

Digitized by the Internet Archive
in 2011 with funding from
Lyrasis Members and Sloan Foundation

<http://www.archive.org/details/carpenter91unit>

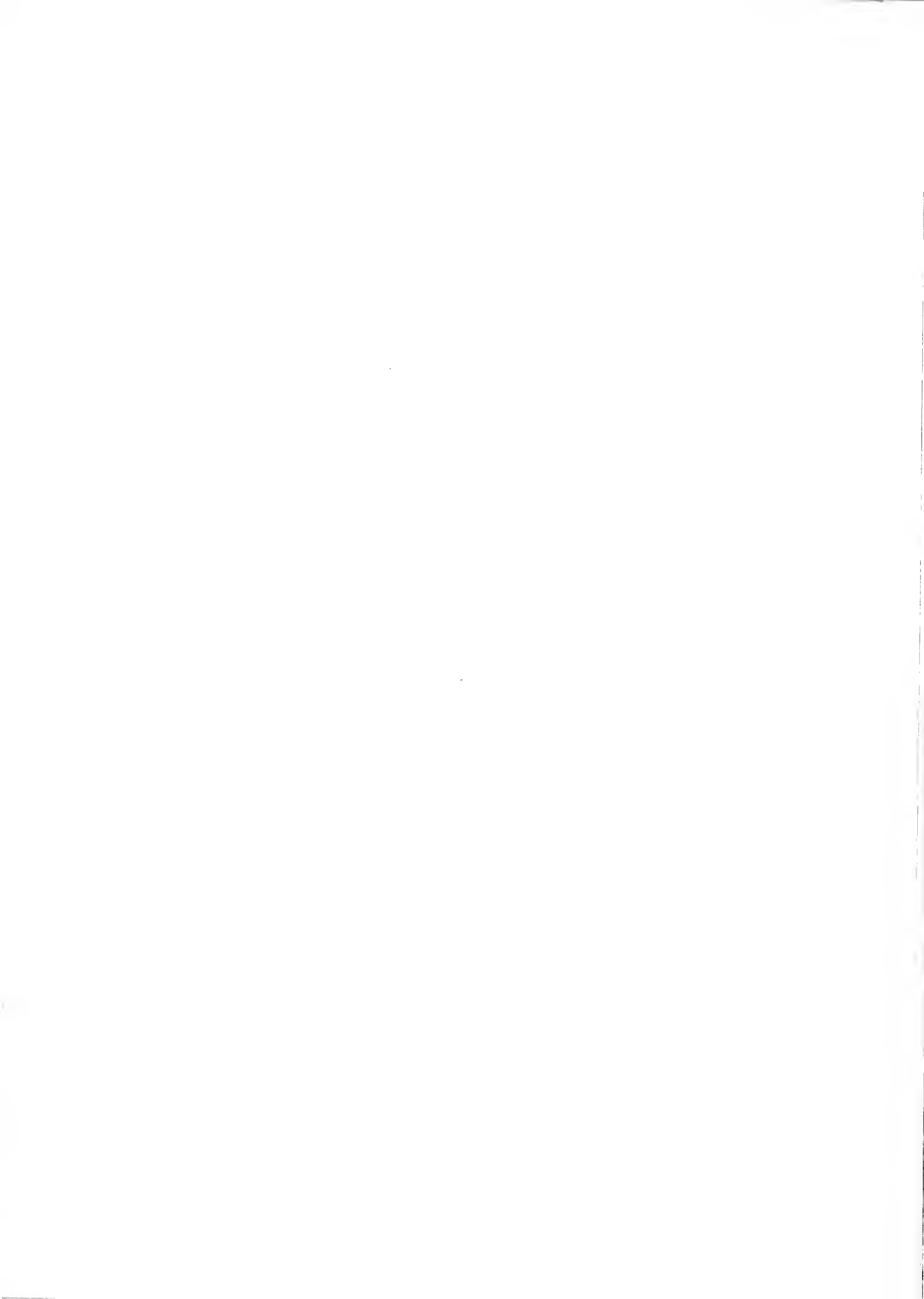

CARPENTER

Official Publication of the UNITED BROTHERHOOD OF CARPENTERS AND JOINERS OF AMERICA • FOUNDED 1858



1971

JANUARY							FEBRUARY							MARCH						
S	M	T	W	T	F	S	S	M	T	W	T	F	S	S	M	T	W	T	F	S
					1	2	1	2	3	4	5	6	1	2	3	4	5	6		
3	4	5	6	7	8	9	7	8	9	10	11	12	13	7	8	9	10	11	12	13
10	11	12	13	14	15	16	14	15	16	17	18	19	20	14	15	16	17	18	19	20
17	18	19	20	21	22	23	21	22	23	24	25	26	27	21	22	23	24	25	26	27
24	25	26	27	28	29	30	28							28	29	30	31			
31																				
APRIL							MAY							JUNE						
S	M	T	W	T	F	S	S	M	T	W	T	F	S	S	M	T	W	T	F	S
				1	2	3	2	3	4	5	6	7	8	1	2	3	4	5		
4	5	6	7	8	9	10	9	10	11	12	13	14	15	6	7	8	9	10	11	12
11	12	13	14	15	16	17	16	17	18	19	20	21	22	13	14	15	16	17	18	19
18	19	20	21	22	23	24	23	24	25	26	27	28	29	20	21	22	23	24	25	26
25	26	27	28	29	30		30	31						27	28	29	30			
JULY							AUGUST							SEPTEMBER						
S	M	T	W	T	F	S	S	M	T	W	T	F	S	S	M	T	W	T	F	S
				1	2	3	1	2	3	4	5	6	7	1	2	3	4			
4	5	6	7	8	9	10	8	9	10	11	12	13	14	5	6	7	8	9	10	11
11	12	13	14	15	16	17	15	16	17	18	19	20	21	12	13	14	15	16	17	18
18	19	20	21	22	23	24	22	23	24	25	26	27	28	19	20	21	22	23	24	25
25	26	27	28	29	30	31	29	30	31					26	27	28	29	30		
OCTOBER							NOVEMBER							DECEMBER						
S	M	T	W	T	F	S	S	M	T	W	T	F	S	S	M	T	W	T	F	S
				1	2	1	2	3	4	5	6	1	2	3	4					
3	4	5	6	7	8	9	7	8	9	10	11	12	13	5	6	7	8	9	10	11
10	11	12	13	14	15	16	14	15	16	17	18	19	20	12	13	14	15	16	17	18
17	18	19	20	21	22	23	21	22	23	24	25	26	27	19	20	21	22	23	24	25
24	25	26	27	28	29	30	28	29	30					26	27	28	29	30	31	
31																				

OFFICIAL INFORMATION

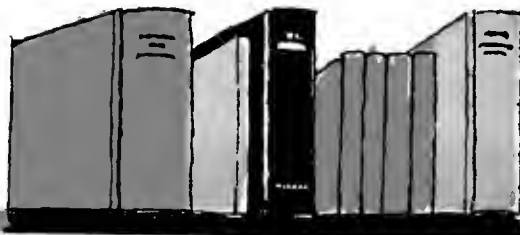

GENERAL OFFICERS OF THE UNITED BROTHERHOOD of CARPENTERS & JOINERS of AMERICA

GENERAL OFFICE:
101 Constitution Ave., N.W.,
Washington, D. C. 20001

GENERAL PRESIDENT

M. A. HUTCHESON
101 Constitution Ave., N.W.,
Washington, D. C. 20001

FIRST GENERAL VICE PRESIDENT

WILLIAM SIDELL
101 Constitution Ave., N.W.,
Washington, D. C. 20001

SECOND GENERAL VICE PRESIDENT

HERBERT C. SKINNER
101 Constitution Ave., N.W.,
Washington, D. C. 20001

GENERAL SECRETARY

R. E. LIVINGSTON
101 Constitution Ave., N.W.,
Washington, D. C. 20001

GENERAL TREASURER

PETER TERZICK
101 Constitution Ave., N.W.,
Washington, D. C. 20001

DISTRICT BOARD MEMBERS

First District, **PATRICK J. CAMPBELL**
130 North Main Street
New City, Rockland Co., New York
10956

Second District, **RALEIGH RAJOPPI**
2 Prospect Place, Springfield, New Jersey
07081

Third District, **CECIL SHUEY**
Route 3, Monticello, Indiana 47960

Fourth District, **HAROLD E. LEWIS**
340 Northwest 148th St.
Miami, Florida 33168

Fifth District, **LEON W. GREENE**
18 Norbert Place, St. Paul, Minn. 55116

Sixth District, **FREDERICK N. BULL**
P.O. Box 14279
Oklahoma City, Okla. 73114

Seventh District, **LYLE J. HILLER**
Room 722, Oregon Nat'l Bldg.
610 S.W. Alder Street
Portland, Oregon 97205

Eighth District, **CHARLES E. NICHOLS**
Forum Building, 9th and K Streets
Sacramento, California 95814

Ninth District, **WILLIAM STEFANOVITCH**
2418 Central Avenue
Windsor, Ontario, Canada

Tenth District, **GEORGE BENGOUGH**
2528 E. 8th Ave., Vancouver 12, B. C.

M. A. HUTCHESON, *Chairman*
R. E. LIVINGSTON, *Secretary*

Correspondence for the General Executive Board
should be sent to the General Secretary.



Secretaries, Please Note

If your local union wishes to list deceased members in the "In Memoriam" page of *The Carpenter*, it is necessary that a specific request be directed to the editor.

In processing complaints, the only names which the financial secretary needs to send in are the names of members who are NOT receiving the magazine.

In sending in the names of members who are not getting the magazine, the new address forms mailed out with each monthly bill should be used. Please see that the Zip Code of the member is included. When a member clears out of one Local Union into another, his name is automatically dropped from the mail list of the Local Union he cleared out of. Therefore, the secretary of the Union into which he cleared should forward his name to the General Secretary for inclusion on the mail list. Do not forget the Zip Code number. Members who die or are suspended are automatically dropped from the mailing list of *The Carpenter*.

PLEASE KEEP *THE CARPENTER* ADVISED OF YOUR CHANGE OF ADDRESS

PLEASE NOTE: Filling out this coupon and mailing it to the *CARPENTER* only corrects your mailing address for the magazine. It does not advise your own local union of your address change. You must notify your local union by some other method.

This coupon should be mailed to *THE CARPENTER*,
101 Constitution Ave., N.W., Washington, D. C. 20001

NAME _____

Local No. _____

Number of your Local Union must be given. Otherwise, no action can be taken on your change of address.

NEW ADDRESS _____

City

State

ZIP Code

The 20th Century Comes To Tigerton

Many "owed their souls to the company store" until the Brotherhood offered assistance.

Karen Gutho and Roger Gill, two Tigerton residents and employees, carried picket signs listing grievances. Mrs. Gutho's sign calls for indoor toilets and a living wage. Employees say they were coerced into buying at the company store.



Photos courtesy of the Capital Times, Madison, Wisconsin

■ Last month the 20th Century came to Tigerton, Wisconsin. It was dragged there by Local Union 2806.

Up to a few months ago, Tigerton was a company town, pure and simple. Its only industry was, and still is, the Tigerton Lumber Company.

In addition to owning the assets of the plant, the Tigerton Lumber Company also pretty much owned the citizens of the community. They worked for the Tigerton Lumber Company, or they didn't work at all.

They bought their groceries and

general merchandise at a store owned by the company or they jeopardized their jobs.

They bought their gas at a gas station owned by the company for the same reason.

Even their electric light bills were deducted by the company, since it also owned the power plant.

Many lived in company houses.

Paycheck stubs of several employees showed that the deductions for food, gas and electricity equaled net pay month after month, leaving the employees zero cash at the end

of the pay period.

The Madison Capital Times did a feature story on the Tigerton situation. When the reporter questioned Lawrence Swanke, the owner of the company, regarding the feudal economy existing in Tigerton, Mr. Swanke is quoted as replying:

"You know as well as I do that a lot of these people would never be able to manage their own affairs, if the company didn't do it for them.

"Everyone's trying to make me look like some kind of bastard, but we are helping our employees. Most



Lawrence Swanke, president of the Tigerton Lumber Company, lives here in the village's nicest house. Swanke not only owns the lumber company, but the local electrical utility, the general store, the bank, and other Tigerton firms.



This is the backyard of one of the homes Swanke rents to his employees and other persons who live in the village. This one has been empty for several months, but the backyard has been left in disrepair.

of them are much better off when they get their paychecks, and their food and light bills are already paid. You should know that. You know how some people are.”

Against this 18th Century kind of economic royalism, Local Union 2806 finally went on strike on September 14th after months of negotiations proved fruitless.

For three months, the workers at the Tigerton Lumber Company hung tough. In the end, the company finally capitulated.

The new agreement includes a

25¢ an hour across-the-board increase and an additional increase of 16¢ later in the year. It provides for seniority on a plant-wide basis; something that was unheard of until recently. It includes a dues check-off and shortens the probationary period from six months to 45 days.

The company also agreed not to harass any employee for not shopping at the company store or service station. The company also agreed not to deduct employees' bills from their paychecks without written authorization approved by the union.

While the wage increase still leaves the Tigerton Lumber Company employees considerably short of a truly American wage rate, the feudal overlordship of the company has been broken, and it should never again return.

So the 20th Century has finally been dragged into Tigerton by the valiant efforts of Local Union 2806, whose members displayed a militancy that earned them a niche in the annals of trade union progress in Wisconsin. ■

WASHINGTON



ROUNDUP

LONG WEEKENDS IN '71—In planning your free time in 1971 don't forget you will have seven long week-ends—four by the Monday holiday law and three natural.

The artificial holidays are Washington's Birthday on February 15, Memorial Day on May 31, Columbus Day on October 11 and Veterans Day on October 25. July 4th falls on Sunday making the following Monday a holiday. Christmas falls on Saturday, making the preceding Friday a legal holiday. Labor Day is, of course, always on a Monday.

CHOICE LOCATION—What city is the waste capital of the U.S.?

The Capitol Reclamation Corp. of Washington, which purchases waste paper and turns it into commercial products, says this city is. The owner of the private firm told stockholders that "your company is located in the city that ranks first in the U.S. as producer of waste paper, placing us strategically close to important sources of supply." Most of the waste paper, of course, is government red tape.

WHITE COLLAR SALARIES UP—Salary increases for the year ending June 1970 averaged 6.2 percent for the white collar occupations including professional, administrative, technical support and clerical categories.

The increase, according to the U.S. Department of Labor, was "the largest recorded in the 10 years that the Bureau of Labor Statistics has surveyed salaries of selected white collar occupations in private industry." Largest gainers were personnel directors whose salaries went up 7.4 percent!

COLLEGE STANDARDS—The National Labor Relations Board has agreed to take jurisdiction over labor relations cases involving any private non-profit college or university which has a gross annual revenue of \$1 million or more for operating expenses. That means nonprofessional employes of such colleges are entitled to the protection of the federal labor law.

The rule, effective immediately, was announced through publication Dec. 3 in the Federal Register. It was the NLRB's second step in asserting its jurisdiction over private non-profit educational institutions. The first step was taken last June 12 when the board, on petition by the AFL-CIO and some of its affiliated unions, acted on a Cornell University election petition and agreed to set money standards for accepting future cases.

TWO-THIRDS OF BONDS—Worker participation accounts for more than two-thirds of the projected \$5 billion in 1970 sales of U.S. Savings Bonds, according to a report of the Savings Bond program.

The report, submitted to AFL-CIO Pres. George Meany by the Treasury Dept., indicated that those on the Payroll Savings Plan—mostly union members—buy 11 million bonds a month. This represents monthly savings of more than \$322 million.

CHILD LABOR VIOLATIONS—Violations of federal child labor laws governing farm and nonfarm work showed a 15 percent increase over the year, the Labor Dept. reported.

The department's Wage-Hour Division found 1,472 children illegally employed on farms and 11,500 in nonagricultural jobs.

The Fair Labor Standards Act forbids the employment of minors under 16 on farms during school hours and at any time in farm operations declared hazardous by the Secretary of Labor.

More than 90 children under 16 were found employed in farm occupations deemed hazardous. Most frequently, these were operating a tractor and handling agricultural chemicals.

More young people were illegally hired to harvest vegetable crops than in any other farm work. Of 1,472 violations, wage-hour officers found 876, or 60 percent, on vegetable farms.



Blue Collars to Reach 32 Million, But New Skills Will Be Necessary

■ Despite the tremendous surge in educational requirements for millions of American jobs, the next ten years will see many millions of job openings for which a high school education—now virtually a “must”—will be sufficient.

However, the increasing complexity of work which in the past has been downgraded and the new skills that are required will necessitate a new and higher level of both general and specialized education.

In a ten-year analysis of what the job picture will look like through the 1970's, the U.S. Department of Labor has laid down a program of educational and job training needs for the 100,000,000 Americans who will form the worker force by 1980.

Called “U.S. Manpower in the 1970's — Opportunity and Challenge,” the Labor Department report is being distributed to 100,000 leaders in business, labor, education and manpower in an effort to alert them to a rapidly changing manpower picture.

Those changes will involve the entry of millions more women into the work force, a crucial need to provide adequate jobs for the Nation's Negro youth and an educational program that will prepare future workers for the kind of economic world into which they will enter.

Although the stress on educational needs remains as it has been in the past, Secretary of Labor J. D. Hodgson indicated clearly that there is still great need for improved vocational education.

“A continuing shift toward white-collar and service occupations and to the more complex skills required for technical and craft occupations

indicates a need for change in both high school and specialized vocational training,” Hodgson told a press conference. “By 1980, for the first time, there will be more professional and technical workers than blue-collar operatives.”

“Yet,” he continued, “there will be many good jobs for which a high school education is sufficient—15,000,000 operative jobs and 17,000,000 in various clerical capacities.”

The Labor Department's analysis of the future is based on a 4.4 percent annual growth rate and a 3.3 percent growth in productivity. On a dollar basis Gross National Product is expected to pass the trillion dollar mark and reach \$1.4 trillion by 1980. (A trillion in the United States is a thousand billion. In Great Britain it's a million billion.)

The labor force is expected to reach more than 100,000,000 workers by 1980, growing by 15,000,000 men and women during the decade of the 1970's. Young adults—those in the 25-34 year range—will account for almost one-half of the growth.

The growth in the teen-age labor force will slow except for “explosive labor force increases among young blacks” due to a great increase in the Negro birth rate over that of whites. Young blacks will grow at a rate nearly five times that of the young white workers, according to the Labor Department projections.

“One of the most pressing tasks of the '70's, therefore,” the report says, “will be to make available job opportunities to young blacks. Growth sectors of the economy will have to employ increasing proportions of young blacks to fill their needs.”

Commenting on this, Secretary Hodgson noted that the educational level of young Negroes is increasing. “They are rapidly catching up with their white counterparts,” he said.

The second important area of work-force growth is that of women, twice as many of whom will be working as in 1950. “This means,” Hodgson said, “that day-care needs will expand. Job training must be available and many employers will have to adjust work schedules to permit the utilization of the skills of those women able to work on a part-time basis.”

While white collar workers will outnumber blue-collar employees by more than 50 percent in 1978, there will still be 32,000,000 workers in blue-collar jobs, an increase of more than 2,000,000 over 1970.

An important aspect of the future will be a tremendous growth in the need for part-time jobs for those who prefer such work. If present trends continue one out of every seven persons will be a part-time worker by 1980.

There is one area in the job market where jobs are expected to be fewer instead of increasing—that is in the teaching profession. As a result of the slackening in the birth-rate the numbers of teachers will decrease. The demand for teachers reached its peak in 1967-68 when there were more than 230,000 job openings. The demand is rapidly slackening and by 1980 is expected to be less than 200,000.

Inasmuch as two out of three college women in the past entered teaching, it is expected that the reduction in teacher openings will prompt many women college graduates to enter other fields. (PAI) ■

FLEETWOOD ENTERPRISES, INC.

TICKER SYMBOL:
FLE

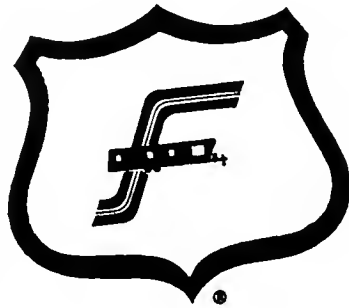

- Begins trading today on the New York Stock Exchange. Continues trading on the Pacific Coast Stock Exchange.

- Is one of the nation's leading manufacturers of mobile homes, recreational vehicles and sectional housing.

- Average annual increase in sales in ten years ended April 26, 1970: 37%. Average annual increase in earnings in ten years ended April 26, 1970: 50%.

- And fresh ideas for the Seventies.

You may already know us. If not, let us send you a get-acquainted information kit.

Fleetwood Enterprises, Inc.
P. O. Box 7638
Riverside, California 92503
Attention: David R. Marriner
Financial Vice President

**BIG
PROMISES
TO
STOCKHOLDERS**

**... for its
own employees:
nothing**

■ The Brotherhood of Carpenters and Joiners of America is preparing to petition the AFL-CIO Executive Council for endorsement of a nationwide boycott of Fleetwood Industries, Inc., makers of mobile homes and trailers.

The Brotherhood's Director of Organization, Anthony Ochocki, stated in a recent press interview that the company is "uncompromisingly anti-labor, using every device in the books to avoid signing meaningful union agreements."

Fleetwood refuses to bargain in good faith, in spite of its record of above-average sales and income.

Evidence of the company's ability to meet union demands for better wages and working conditions came

in a recent company advertisement in *The Wall Street Journal*. The ad (reproduced above) reports that the company's stock is now being traded on the New York Stock Exchange, that it is one of the nation's leading manufacturers of mobile homes, recreational vehicles and sectional housing, and that the company's average annual increase in sales in the 10 years ending last April amounted to 37%! Going even further, the advertisement stated that the company has had an average annual increase in earnings of 50%!

This hardly indicates financial straits for the employer or justification for the anti-union tactics reported in previous issues of *The Carpenter*. A 50% annual increase

in earnings is far above percentage demands of Brotherhood local unions now seeking to negotiate contracts with the company.

The company has 32 plants in all, and the Brotherhood has won representation elections in nine.

Picket Lines

There are informational picket lines at more than 20 plants, advising workers and the public of unfair-labor-practice strikes at seven locations stemming from the company's failure to bargain in good faith.

A strike, begun last August 8 at Westmoreland, Tenn., is still in progress. Eight others are underway.

The Brotherhood of Carpenters and Joiners of America is certified

and in negotiation at nine plants, located in seven states. These include: Broadmore Homes in Waco, Tex., and Woodland, Wash.; Deluxe Homes in Quincy, Mich.; Fleetwood Homes in Riverside, Calif., Macomb, Ill., Westmoreland, Tenn., and Waco, Tex.; and Prowler Industries at Anaheim, Calif., and Hancock, Md. The Brotherhood local union has been bargaining at the Macomb, Ill. plant since September 25, 1969.

'Scatter-gun' Trouble

Union members have had "nothing but trouble" at Westmoreland, Tenn., according to Brotherhood Director of Organization Pete Ochocki. There have been arrests of pickets on "John Doe lists" for such minor offenses as spitting on the sidewalk. So-called "scatter-gun" warrants have also been issued.

Pickets have also been arrested at Macomb, Ill.

"There has been extreme use of coercion and intimidation by the company in an attempt to override the legitimate demands of the organized workers," says Ochocki.

Negotiations have been conducted with a team of roving company negotiators, who ask for meetings

at various plant locations. Recently, Fleetwood has begun to use local attorneys in bargaining sessions as well.

There has been some progress in the talks, but still no agreement on union security, checkoff of dues, wages, and visitation rights of union representatives.

Director of Organization Ochocki, meanwhile, has met with top officials of the AFL-CIO as a prelude to petitioning the AFL-CIO Executive Council for endorsement of a nationwide consumer boycott, on the order of those which have proven so effective against General Electric Company and the California grape growers.

"Today," Ochocki reports, "the company has employed more workers but its production is down 20 to 40 percent from the pre-strike levels."

Mobile Home Dealers

Some 1800 dealers across the country currently are handling the Fleetwood mobile homes and trailers under such names as Fleetwood, Broadmore, Terry Industries of Virginia, Prowler Industries, Inc., Festival Homes, Inc. and Pace-Arrow, Inc.

According to reports filed with the Securities & Exchange Commission the officers of Fleetwood Enterprises are paid relatively low salaries but with ample "incentive compensation."

Executive Salaries

President and Chairman of the Board is John C. Crean. In the fiscal year ending April 26, 1970 he earned a salary of \$31,200 but made \$101,023 in "incentive compensation" and \$19,833 in accrual pension. Executive Vice President Dale T. Skinner earned only \$12,000 in salary but \$148,163 in "incentive compensation" and \$24,024 in accrual pension.

In the SEC report, Fleetwood explained that "incentive compensation" was a form of profit-sharing. Five officers and 13 directors earned over one million dollars last year.

Ochocki points out despite the reported increase in earnings the income of company officials has declined recently.

"This tells me," he said, "that the income of these officers is directly tied up with earnings. Therefore, the less they pay their workers the more they will earn. I think that's why they are fighting us so bitterly." ■



Year of Preparation

1971 TO SET STAGE FOR 1972 PRESIDENTIAL RACE

By **ALEXANDER UHL**
Press Associates, Inc.

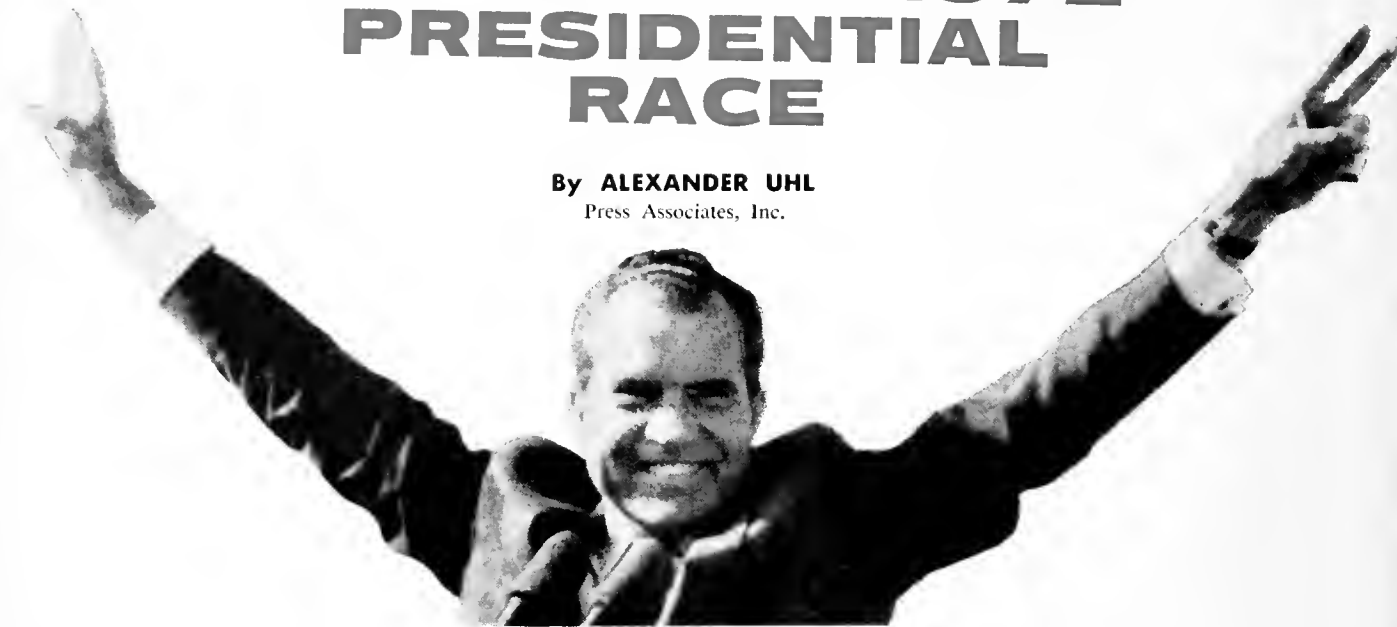

■ Any preview of the year 1971 must really be a preview of 1972

Rarely has a new year been so telescoped into its successor than the new year that is coming up.

Congressmen in the midst of their 1970 campaigns for re-election were worried a good deal of the time about what would happen to them two years from now—worried perhaps more about the 1972 results than the 1970 ones.

President Nixon with his thundering pronouncements on the good guys and the bad guys was clearly lining up what he thought would be the issues in the 1972 Presidential race as much as he was seeking to line up the issues for the coming Congress.

Even the GOP economists are now talking about the "boom" that they expect "by 1972" with inflation licked, unemployment down and Republican euphoria all over.

And yet, when all is said and done, it's going to be difficult to pretend that 1971 is merely a forerunner of 1972 and has no life of its own.

It has.

Simple Promises

Take the economy. It is simple to promise pie in the sky by 1972 in time for the elections. But that isn't much comfort for the unemployed, the elderly on their meager Social Security benefits and even

businessmen themselves, all of whom have to live through the next 365 days much less the year 1972 itself.

What happens, of course, depends largely on the "curious" outcome of the 1970 elections—that is how much the new 92nd Congress will differ—if at all—from the 1970 Congress and how it shows that difference, if any.

COPE, in its analysis of the results, said that the 1970 results, and so the next Congress, had "something in it for everyone" and was not a clear-cut victory for either party. But, it pointed to certain imponderables that may play an important role in the 92nd Congress.

Bitter Campaign

Among these were "an aftertaste of bitterness" among Democrats because of the vicious nature of the GOP's (including the President's himself) campaign—especially during the closing weeks. Add to this the bitterness among liberal and moderate Republicans because of the merciless purge of GOP Senator Charles Goodell in New York.

But, whatever the record to be made over the next two years in Congress, there can be little doubt that the plight of the economy will be the number one issue both this year and in the election of 1972. Most analysts concede that the Vietnam War, as a key issue, played a rela-

tively minor role in 1970 and may well be eliminated during the next two years. "Law and order" also failed the Republicans as an issue for the simple reason—as Senator Edmund Muskie made clear so movingly—the Democrats are as much devoted to law and order as anyone else.

That leaves inflation, interest rates, the housing depression and, above all, jobs as the vital issues ahead.

There can be little doubt that the Nixon Administration was stunned to find that even "law and order" hard hats are concerned with so elemental a matter as getting paid on Friday night in money that answers the needs of themselves and their families.

Only Lip Service

That realization seems to have sunk in with resounding suddenness. Administration economists paid largely lip service to the severity of unemployment before the election, stressing the war on inflation as a "success" and the happy days that lay ahead. But it was after the election that they really put their heart into it.

It didn't take too long after the election for Secretary of the Treasury David M. Kennedy to discover that there are worse things than budgetary deficits. He told the 46th Annual New England Conference on November 12 that "there are times, like

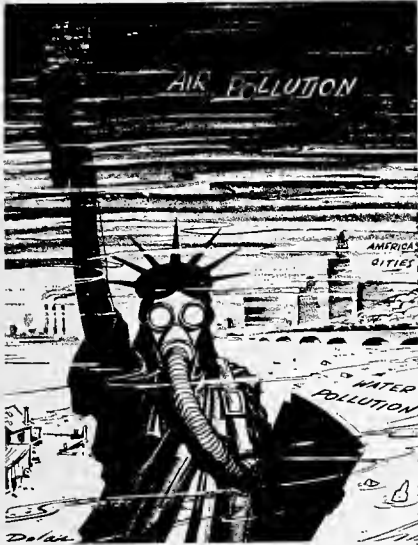

the present, when a reasonable budget deficit is not to be deplored but accepted as a vital element in policies to promote economic stability."

That led *The Washington Daily News*—a redoubtable supporter of balanced budgets—to say in alarm:

"It was only a couple of weeks ago (just before the election) that Treasury Under-Secretary Charles E. Walker was saying that the inflation cycle was the direct result of a Federal 'spending spree' in the Johnson Administration."

And now, the editorial continued with obvious shock, "we hear Treasury Secretary Kennedy saying that a 'reasonable budget deficit is not to be deplored'."

Other economic powers in the Administration also are beginning to talk about how the Nixon Administration is going to restore good times during the next two years, presumably timed to have a major impact on the 1972 Presidential election.

"Prospects and Policies for the U.S. Economy."

"Economic Priorities in the 1970's."



"Next Steps in the American Economy."

"The Management of Expansion."

These are the titles of speeches now being made by members of the President's Council of Economic Advisers.

Opposing Situations

The common strain running through these speeches is the effort to reconcile the "war on inflation" with the obvious necessity to come up with a "full employment" program by 1972.

What is equally clear is that Nixon economists are now shifting their emphasis from the war on inflation—they all but say that the battle has been won — to an expanding economy that will cut back on the 4,800,000 now out of work when the Nation marches to the polls on November 7, 1972.

That the Nixon Administration has failed to solve the problem of licking inflation without throwing people out of jobs through a hard line fiscal policy is obvious. The Kennedy speech and the emphasis on "ex-

URBAN DECAY



pansion" would indicate that it is now seeking new ways to lick the problem.

This groping may hold bad news for organized workers, for there is no guarantee that the Nixon Administration will continue to cling to its opposition to "wage-price guidelines". Herbert Stein, conservative economist and member of the Council of Economic Advisers had some significant comments to make on this question in a recent speech before the California Bankers Association in California.

Stein put much emphasis on wage rates, declaring that "the rate of inflation from this point forward will depend on the rate of wage increases probably more than anything else." He tied wages in with increases in productivity, adding that any significant slowdown in the rise of unit



labor costs will "have to come from slower wage increases."

Stein noted that the Nixon Administration has been opposed to laying down "wage-price guidelines" and showed great reluctance to the imposition of such guidelines, but did not shut the door on them.

Wage 'Jawboning'

From these speeches and other indications it is apparent that the Nixon Administration is accepting the obvious fact that it is going to have an inflationary budget deficit and that a certain amount of "jawboning" on wage increases already has begun.

The Administration, too, is giving strong hints to the Federal Reserve Bank that a cut in interest rates and a more liberal money supply would be welcome. The Federal Reserve did drop its discount rate a modest fourth of a percent from 6 to 5¾ percent shortly after the election leading to an equally slight reduction in prime bank rates. But as yet there has been no substantial drop in general interest rates.

In summary, the Nixon Administration has acknowledged that it can't





balance the budget and that "hard money" is producing too much unemployment—both basic fiscal measures in its "economic game plan" to lick inflation.

That leaves wage and price guidelines as a highly tempting new weapon. Hard-money advocate William McChesney Martin, former chairman of the Federal Reserve Board, is still not talking about lower interest rates, but is advising the Administration to go in for wage and price guidelines.

The AFL-CIO has frequently announced its willingness to sacrifice so long as equal sacrifice is expected from others. But supporters of guidelines talk big about wage guidelines but very small when it comes to profit controls. They use a recent slump in profits as their excuse, but say little about the huge profits of recent years, which are largely responsible for today's inflation.

In other areas, 1971 is being pointed to 1972, also. Administration spokesmen had laid great emphasis on the withdrawal of American forces from Vietnam with all but definite promises that the vast bulk of fighting men will be back home before the 1972 election.

Highly important legislation, much of it with political overtones, will come before Congress next year.

- The Griffiths-Kennedy National Health Bill—a top priority for the AFL-CIO—will be pushed hard by liberals in Congress. This bill would extend health insurance to all Americans, not merely those over 65.

- Improvements in fair labor standards which never seem to catch up with the economy, will be up again. The AFL-CIO is calling for an increase in the minimum wage to at least \$2 from the current \$1.60. The Federation also wants to extend its protection to millions not now covered.

- Housing, education and environmental controls to reduce pollution

urgently need adequate funding as the AFL-CIO has repeatedly pointed out.

- Congress itself will see reform efforts. In the House efforts will be made to break down traditional selection of committee chairmen on the basis of seniority to a selection by ability. In the Senate efforts again will be made to change Rule 22 in order to prevent or, at least, limit filibusters.

But, when all is said and done, the big issue for workers as the new

year comes along is jobs. Unless the Nixon Administration scores a totally unexpected victory over inflation and rebuilds the economy on the basis of its present "game plan", the Republicans will be going into the 1972 campaign politically hamstrung.

Next year, in preparation for 1972, will open the way to new Nixon policies. What they will be remains to be seen, but there are strong indications that organized labor may become the scapegoat in new measures to combat inflation. ■

Half Million Construction Workers Involved in 1971 Contract Changes

- The U.S. Department of Labor reports that 1971 will be another peak year for the negotiation of major labor contracts.

The Department estimates that at least 4,800,000 workers are under major contracts that either expire in 1971 or contain 1971 wage reopening agreements.

In addition, about 5,300,000 workers under major agreements covering 1,000 or more workers, will receive "the highest deferred wage increases on record."

Industries in which contracts will expire and the number of workers involved follow:

Steel	400,000
Aerospace	212,000
Telephone	538,000

Construction	532,000
Mens Clothing	125,000
Soft Coal	80,000
Aluminum	44,500
Cans	38,000
Glass containers	92,000
Gas, Electricity	137,000
Stevedoring	73,000

In addition, close to 400,000 railroad workers will be involved in bargaining under a no-strike law expiring at the end of February.

Unions involved in the bargaining include: Glass Bottle Blowers, Steelworkers, Utility Workers, Communications Workers, Amalgamated Clothing Workers, Aluminum Workers, Telegraph Workers, Longshoremen, Machinists, Mine Workers and the Auto Workers. ■

Congress Adds Pay Step For 600,000 Blue-Collar U.S. Workers

Legislation to provide an extra pay step for 600,000 blue-collar Federal employees and a bill granting early retirement benefits to 11,000 fire fighters at government installations won final Congressional approval before the Christmas recess.

Both bills were strongly supported by labor—and opposed as too costly by the Administration.

The blue-collar pay bill, trimmed down in conference from a House-passed version in an effort to avoid a threatened veto, would give long-service workers a 4 percent pay hike.

Under the wage board system of

prevailing area pay scales, the government's blue-collar workers start at 4 percent below the going rate. After 26 weeks, they move up to the prevailing wage, and 78 weeks later advance to 4 percent above the going scale.

The new legislation would give them an additional 4 percent step two years later, bringing them to 108 percent of the base rate.

The bill also provides for the first time a form of wage board pay-setting for about 140,000 workers employed by military post exchanges and other self-financing activities.

ANOTHER YEAR HAS PASSED . . . WOULD YOU LIKE TO GO FOR 100?

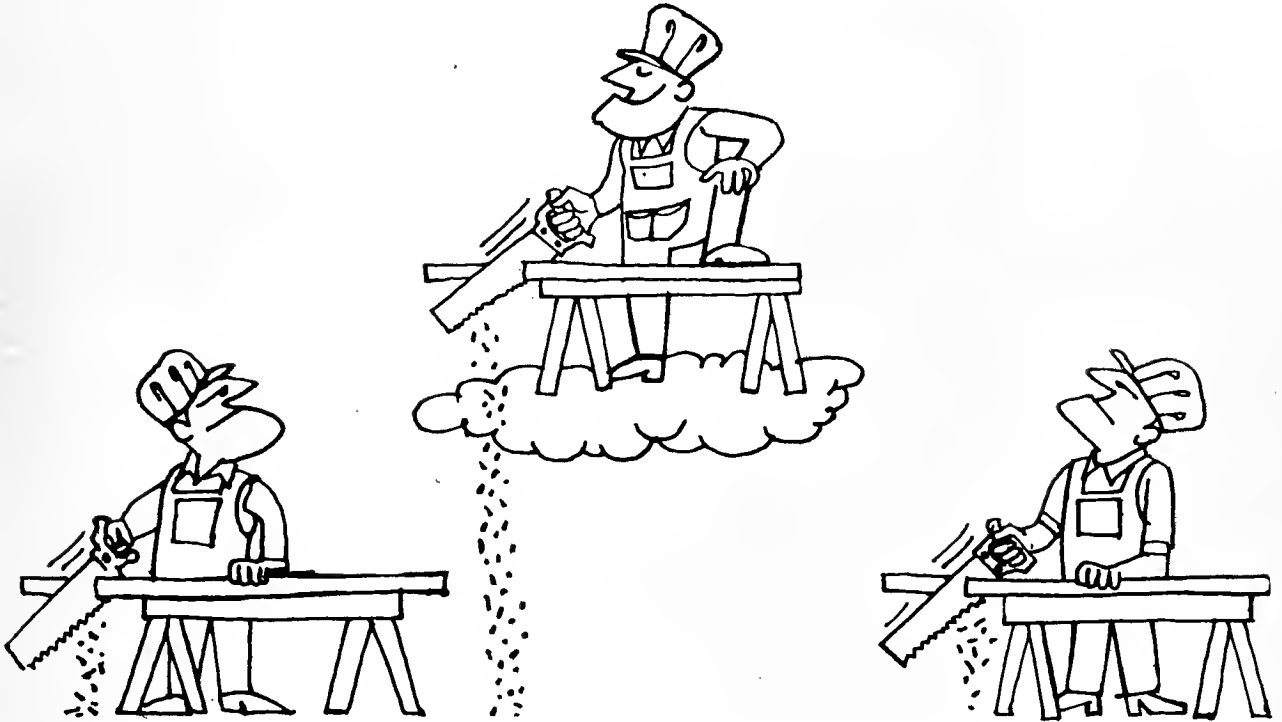

To the list of fatal diseases, add envy.

After a ten-year study of farmers in Azerbaijan, a Caucasus mountain region noted for its centenarians, Soviet gerontologist Shykhur M. Gasanov has concluded they live to be more than 100 years old because, "They are not envious of their neighbors."

Conversely, a study made in 1969 by the Duke University Medical Center indicated that pessimists and persons who dislike their work are not likely to reach the century mark.

"We know the mind affects the body in various ways," says Dr. Erdman B. Palmore, of the Medical Center. "It would seem that the best way to increase longevity is to maintain a useful and satisfying role in society and keep a cheerful disposition."

Centenarians are found in nearly all countries, and there are as many theories of longevity as there are oldsters. But whatever the explanation, man outlives all other warm-

blooded animals and birds, the National Geographic Society says.

Elephants popularly were thought to be the longest lived. The myth was fostered by circus ballyhoo that billed any large specimen as "More Than 100 Years Old." An elephant's average life span is 45 years, though occasionally one may reach 60.

Inadequate data and faulty memories have made it impossible to pinpoint the greatest age reached by a human being. A South African who thought he was 160, for example, turned out to be only 110 when officials unearthed some old birth records.

The United States Social Security Administration sends monthly checks to a man 128. His age was authenticated when he applied for a Social Security card at the age of 106 so he could get a job picking fruit.

Professor Gasanov's conclusion that lack of tensions contributes to long life isn't new. Surveys also have shown that retiring may not be as healthful as continuing to work.

The Soviet Union's oldest citizen, officially 165, was shown in a documentary tending his garden in Azerbaijan, riding his horse, and strolling a mountain path.

The film also featured a 30-member folk song group, all of whom were more than 100 years old. The troupe's only woman, a dancer, was reputed to be 130.

A 103-year-old Briton runs a boarding house by the sea; a woman 109 operates her own dairy; and other centenarians are tax assessors, physicians, newspaper columnists, and farmers.

In San Francisco, a waiter who works up to 13 hours a day celebrated his 103rd birthday recently by jogging more than six miles. The previous year he ran the 100-yard dash in 17.2 seconds.

And a Syrian farmer who claims to be 136 is seeking a bride because he has been married 13 times and considers 13 an unlucky number. A Moslem, he already has two wives.

The Payoff Comes in '71

How far will the housing recovery go under its present momentum ?

When can industrial and commercial building be expected to advance again ?

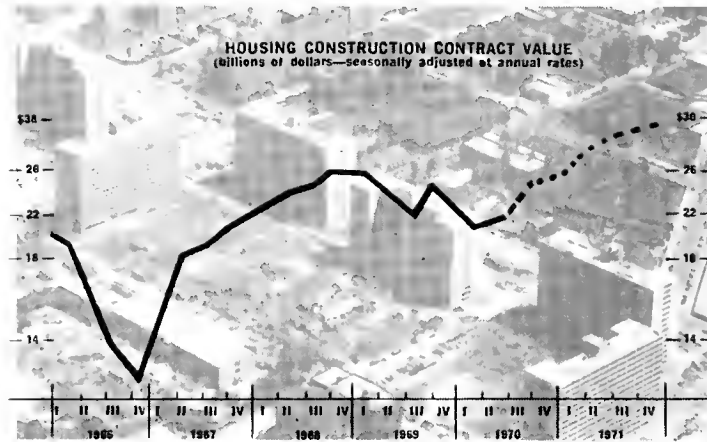
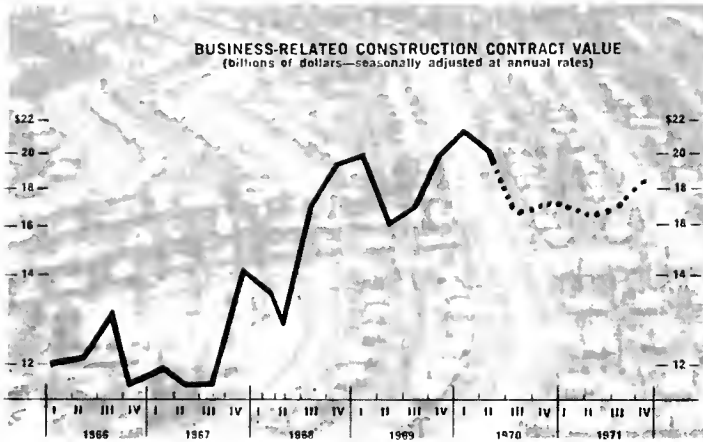

■ Think of 1970 as a year of transition for the construction industry. Economic growth had to be measured with a micrometer.

Then think of 1971 as a year of recovery . . . even though it too, may be only slight.

That's the recommendation of the *F. W. Dodge 1971 Construction Outlook*, recently distributed by McGraw-Hill, Inc.

"Right now we're in the sticky part," the report commends. "Contracts for industrial and commercial building fell sharply, last spring. And housing, which has been depressed for more than a year, is only at the beginning of its recovery. For the time being, that leaves something of a gap in the flow of new construction work."

F. W. Dodge says two things have to happen for 1971 to be a better construction year than 1970: Housing must make not only a strong but a sustained recovery—something that lasts all through 1971, and even beyond. Besides that, business construction must eventually reinforce the new year's housing expansion.

If all goes well, we'll have a strong

advance of nearly 10% in total construction during 1971, the Dodge Outlook states.

Some worthwhile changes have been wrung out of this period of equilibrium. One such improvement in 1970: the nagging inflationary pressures of the past several years finally began to show signs of lessening. Another big plus: a smaller share of our resources is now being used for military purposes, and more emphasis is being given to our many domestic problems. In both areas, we still have a long way to go, but 1970's movement in these directions will yield important long-term benefits, F. W. Dodge states.

As is usually the case, these gains weren't accomplished without a cost. The price that had to be paid in the short-run was that we had to bear many of the symptoms of recession: absence of growth, rising unemployment, reduced profits.

This transition, or "re-ordering of national priorities," has been making itself felt on construction markets all through 1970 in both positive and negative ways. And if the over-all result in 1970 looks like a standoff

(since 1970's total of construction contract value is headed for about the same amount as in 1969), that's only because totals often conceal important changes. What makes the difference is the change in the *composition* of the construction market between the opening and closing quarters of 1970. When the year began, nonresidential building was booming, while housing had sunk to its lowest level since the 1966-67 credit crunch. Yet, by the end of the year those two construction markets had exchanged roles. *That shift was the really important development in construction during 1970.*

The business slowdown was one key to 1970's construction shift; the easing of credit to keep that slowdown from turning into a full-scale recession was another. The first of these put an end to the non-residential building boom while the second took the lid off the housing market.

Will the anti-inflation brakes on the economy since early 1969, it was only a matter of time before the strong and rising rate of industrial and commercial building that made

sense in an expanding economy proved to be excessive under no-growth conditions. That awareness came early in 1970, and contracting for manufacturing plants and office buildings was cut back sharply during the spring quarter.

Relaxation of the Federal Reserve Board's stranglehold of the money supply, coupled with a higher rate of saving by consumers (who were getting increasingly nervous about the way unemployment was rising) resulted in a rush of funds available for mortgages during the spring and summer months. By mid-year the long decline in housing starts had turned around and a vigorous recovery was on the way.

Result: 1970's flow of new construction work was approximately as strong at the end of the year as it was at the start, though the mix was

very different. This trade-off sets up two key questions for the *1971 Construction Outlook*: How far will the housing recovery go under its present momentum? When can industrial and commercial building be expected to advance again?

Part of the answer to these questions lies in the kind of economic environment that will set the boundaries of 1971's construction markets. Uppermost in the analysis of where we are and which way we are going is the fact that the business slowdown of 1969-70 didn't just happen all by itself. It was deliberately engineered with the object of breaking inflation's grip. And the means by which it was created—severely restrictive monetary and fiscal policy—were eased greatly during the first half of 1970.

Government taxing/spending op-

erations are a mixed bag. The current deficit (which helps to stimulate recovery) arises more out of reduced revenue than from higher spending. As recovery accelerates, tax revenue will automatically rise along with corporate and personal incomes, and this will have a dampening effect on the rate of expansion.

Business spending for plant and equipment will be another drag on recovery, because of the long lag that always exists between the decision to invest in productive capital and its eventual delivery. Decisions to cut back on new investments that were made during the first half of 1970 (when excess capacity was piling up) showed up as a leveling-off in spending for plant and equipment late in 1970 and early in 1971.

Continued on page 30

REGIONAL REPORTS ON ANTICIPATED CONSTRUCTION IN 1971



■ The extreme scarcity of office space that has existed in the Northeast's major cities for several years is finally easing. The office building boom it precipitated began to deliver a heavy volume of new office space to the inventory during 1970, at about the same time that the general economic slowdown was lessening the pressures of demand. Vacancy rates will ease still further

through 1971, as more of the massive volume of office space contracted in this region during 1969 and 1970 becomes ready for tenants.

Commercial building will be off in the nation generally during 1971, due primarily to the subsiding office building demand, and the Northeast will share heavily in this decline. Utilities should bolster the Northeast's business-related market share in 1971, though, by responding to the projected long-term shortages of demand in this power-hungry region. Area manufacturing will trend nearly even with 1970 levels next year, following the national pattern.

Residential building has been seriously neglected in the Northeast over the past few years. The combination of tight money and high costs of construction, which had effectively frozen many Northeastern

cities out of Federal-aid housing programs, has sent vacancy rates to critically low levels. This is particularly true of rental housing, as multifamily construction has fallen far behind the rampant progress of urban decay. With easier money in prospect for 1971, the stage is set for a strong gain — perhaps the strongest of any region—in Northeastern housing.

The Northeast has recently been responding better to needs for institutional and public facilities, and 1971 should see further progress in these categories. Contracting for sewer and water facilities, which was especially strong this year, will continue at high levels in 1971. Schools and health facilities construction is also expected to be a positive factor in the Northeastern construction picture next year. ■



■ Manufacturing building, the Midwest's weak spot for most of 1970, is likely to become a source of strength in the year ahead. The typical sensitivity of this region's heavy industry to changes in business conditions led to a severe decline in contracting for manufacturing plants during the slowdown. As the pace of business quickens during 1971, the expected spring pickup in indus-

trial construction contracting should also begin in this region.

Commercial construction in the Midwest will reflect the general trends of expanding store building and lower office construction in 1971. Since this region normally accounts for a larger-than-average share of the national total of store construction, this shift in commercial building ought to give Midwest-

ern building a boost.

Like the rest of the country, the Midwest has had its housing recessions during the periods of money scarcity in the late Sixties. But in-between those credit squeezes, the region managed to get a good quantity of housing built. This fact, combined with a lower rate of popula-

tion growth than the other three areas, leaves the Midwest relatively better off at the start of 1971. With a residential vacancy rate comfortably above the national average, the Midwest's need for housing is not quite so urgent as it is in the Northeast. Housing will be expanding next year in all four regions, but the

gain in the Midwest will be a bit less than the national average.

Institutional building and public facilities construction both have been strong in the Midwest during 1970. But next year should see these building types return to their long-term trend levels. ■

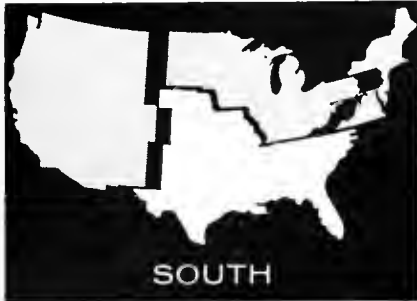

■ Commercial building in the South got a lift during 1970 with the start of several large office buildings. The construction of new office space has been strong there this year, even though the South is probably in the best shape of any region as far as office space needs are concerned. In 1971 the region's office building will mirror the generally weaker performance expected for the nation as a whole next year. Store and ware-

house building should remain strong, though, as the region continues to diversify and expand its retail outlets and distribution facilities.

The petro-chemical and pulp and paper industries, heavily concentrated in the South, are both planning reduced levels of capital expenditures next year. Utilities may take up some of the slack, but the region's total business-related category appears headed for a decline in 1971.

The South has increased its share of new apartment building in every year of the past five, and 1970 will make it six. Rental vacancy rates in the region are now the highest in the country, but there is still a substantial backlog of new units on the drawing boards. This is particularly true of Florida's gold coast, where the lure of a second home in a resort

setting has proven irresistible to many. The current level of rental vacancy rates, though high (near 7 per cent), is not alarming. (The West worked with 10 per cent as a rule of thumb for several years in the early Sixties.) It does suggest that there is a distinct limit to the South's apartment growth, though. In 1971 the South will be building a smaller share of the national total of apartments than it has become accustomed to in recent years. But single-family housing in the region should about match the national rate of growth next year.

Southern institutional and public facilities construction has lagged behind the national pace during 1970. Better-than-average gains can be expected next year, particularly in the areas of health facilities, street and highway, and sewer and water contracting. ■



■ The promises 1970 held out for Western commercial building have gone largely unfulfilled. After a sharp gain during 1969, this area's share of commercial building lost ground relative to the national average this year, as the cutbacks in defense and aerospace industries permeated other sectors of its economy. At last reading, most of the advance indicators of the defense industry were still sagging. Reflecting this,

planned expenditures for construction of additional plant facilities for this major Western industry are way down for 1971. Gains in other industries will help to limit a decline in the region's industrial building next year, though. The experience of the recent past (DOD/NASA work was at its peak in 1967) has shown that, owing to the continuing diversification of Western industry, this area is no longer as dependent on aerospace dollars as it once was.

Even toward the end of 1970 there was no strong indication that the West's defense/aerospace cutback had seriously undermined the demand for housing. In that generally weak housing year the region outdid the national residential building average without giving signs of serious surplus. Indications are that there's room for a good gain in Western housing next year.

Public facilities construction has lagged in the West recently, primarily because cutbacks in direct Federal construction have their greatest impact on this region. With higher levels of Federal construction in the offing next year, Western public facilities contracting should improve.

Institutional building (schools and health treatment facilities) should also do better than the national average next year, as the pressure of tight money is relieved. The area's share of school building has declined steadily over the past five years. But it is now somewhat below the West's proportion of school-age children. This situation isn't likely to prevail for any extended period of time in this area, where dynamic population shifts require a classroom inventory somewhat higher than the national average. ■



Editorials

* **Who Can Tell Why?**

Visions of a "don't-give-a-damn," marijuana-oriented society were conjured up in a two-day international conference on drug research, last month, at Stanford University by Dr. Leo Hollister, clinical associate professor of medicine at Stanford and an investigator at the Palo Alto Veterans Administration Hospital.

"Marijuana," he said during discussion of his research paper which he presented at the conference, "appears to be better than alcohol, because it gives you a 'no cal high.' It doesn't add calories like the commonly used cocktails do."

If the use of marijuana continues to rise, as researchers have predicted, Dr. Hollister said, it may bring with it a drug dependency situation, a sort of "permanent euphoria."

The future effects of more widespread use of marijuana, especially in the 15-to-30 age group, might bring on an "amotivational syndrome"—a permanently dropped-out, don't-give-a-damn society that will cause a brain-drain "among some of our best young people," Dr. Hollister speculated.

In his research paper, he noted that whether marijuana use leads to permanent addiction still appears to be highly controversial, and it may be too early to provide an adequate answer."

"In some parts of the U.S.," he continued, "especially the northern urban center, opiate addiction is clearly related to the prior use of marijuana."

Of particular alarm to all thinking people was Dr. Hollister's admonition that widespread use of marijuana can lead to loss of desire to work, loss of motivation, and loss of sound judgment.

That thousands of young people have opted to follow the drug route rather than come to grips with the world of work responsibility and competition bodes no good for the future of Western civilization.

That many young people cannot adjust to a society which everyone seems to consider affluent certainly is a tribute to the generation which grew up during the depression, when joblessness and callous indifference on the part of government made existence perilous. The depression generation looked reality in the eye.

In such a climate a turn to euphoric drugs could be expected, but no such trend developed. Instead, drug

abuse seems to have come into full flower in an era which supposedly is the most affluent in the history of mankind.

Who can explain why?

* **Protecting the Consumer**

After the issuance of a strongly worded report by the National Commission on Product Safety, we may well ask the question: is consumer protection as provided by Federal law and administered by the U.S. Government breaking down?

The National Commission last month issued a 182-page report in which it criticized Federal agencies for failing to provide the degree of consumer protection called for by law. The failure of enforcement or the inadequate enforcement of the following were blasted by the Commission:

- The National Traffic and Motor Vehicle Safety Act of 1966 being administered by the National Highway Safety Bureau of the Department of Transportation and by the Commerce Department.

- The Flammable Fabrics Act (amended in 1967) being administered by Commerce, Federal Trade Commission and the Department of Health, Education and Welfare.

- The Federal Hazardous Substances Labeling Act of 1960, amended by the Child Protection Act (1966) and the Toy Safety Act (1969) being administered by the Food and Drug Administration, an agency of the Department of Health, Education and Welfare.

The report contains a bill of particulars on each of the three areas indicated above. While space here prevents a detailed discussion, we would recommend that the entire report be consulted by those in local unions and District Councils who have a strong consumer protection interest.

The thrust of much of the criticism is that the law is not being enforced or administered in the spirit in which it was passed. Industrial concerns are handled with the tenderest possible care and the protection the public should be getting simply is not forthcoming.

The National Commission has done a commendable job in striking this lusty blow for consumers. We hope the spotlight of public attention will result in some action by the Federal agencies involved—and we also hope that Congress gives this report its scarching attention.

Carpentry wasn't 'Greek' to the Ancients of Greece

*Builders of the
classic temples used
wood-construction methods
to create their wonders
of the Ancient World*

■ After many centuries, the phrase "Greek architecture" invariably conjures up visions of gleaming marble temples set against a backdrop of blue sky.

This vision is not altogether wrong. But the remarkable thing about these beautiful stone edifices was that their design and craftsmanship was originally provided by wood-working carpenters.

This interesting fact is revealed in a new book entitled *Man The Builder*, recently published by McGraw-Hill Book Company and written by Gösta E. Sandström. The author traces the development of building and architectural techniques from the earliest age to the present, giving insight into the problems and accomplishments of man and the civilization he has produced.

Carpentry is one of the oldest crafts in the world, the author states. This is well known, because man has been working with wood since the dawn of human consciousness. Very little is known about early carpenters, however, because written records were

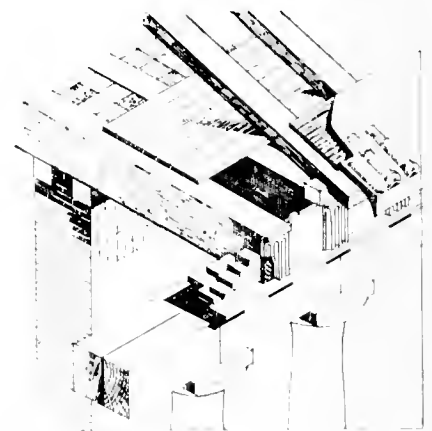

Above is shown a reconstruction of the roof used for the arsenal in Peiraeus. The Greek engineers did not understand or else abstained from trussing. As seen from the section of the arsenal at right, the 22 x 17-inch ridgepole exposes the roof beams to the maximum possible load.

The beautiful columns that typify Greek temples were constructed in sections and joined together with wooden blocks made of cypress wood.

(Illustrations from *Man the Builder*)

not kept, and time has erased most of their work.

The work of ancient Greek carpenters, on the other hand, has been indirectly preserved in the stone temples of Athens and other ancient Greek city-states. These edifices were, in fact, copies of wooden temples already in existence, and the craftsmanship used to work the marble was almost exactly the same as the methods used in wood construction.

Mud Bricks Used

The earliest Greek temples were modest buildings, constructed entirely of mud brick on stone plinths and roofed over with thatch. As their size grew with increasing prosperity, timber began to appear to carry the weight of heavier roofs. Eventually timber posts were inserted in the clay walls, placed in line with ridgepoles, and the whole weight was carried by the posts. The mud bricks took over a subsidiary function of wall filling. This was the way the Artemis temple

in Sparta was built in the ninth century B.C., Sandström says.

As the Greeks became more civilized, they began thinking about using stone for their temples—wood construction continued in housing and public buildings. With the erection of the Parthenon and other buildings on the Acropolis in Athens, the marble of Mount Pentelicus, located a few miles north of the city, was used. The Pentelic marble consisted of pure calcium carbonate which when quarried, produced blocks of close-textured, brilliantly white stone. The character of the marble lent itself to fine joints, smooth finishes, and all the optical refinements found in the Parthenon and other contemporary temples.

Because the Pentelic marble could be quarried in lengths of up to 15 feet, the Greeks continued to work the stone the same way they worked with wood. There was no need to develop arches, vaults, or domes and they were content to apply trabeated architecture, employing a post-and-

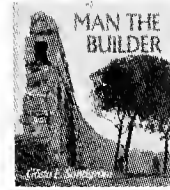

Information in the accompanying article is taken from a new book, *MAN THE BUILDER*, published by McGraw-Hill Book Company. Written by Gosta E. Sandstrom and profusely illustrated, *MAN*

THE BUILDER recounts man's achievements in construction from pre-historic times to the present. A sturdily-bound volume, well-indexed, it is recommended for the layman as well as the construction engineer and architect.

intel system in the manner of their old wooden temples. Because of this reliance on carpentry techniques, Greek temples achieved geometric perfection and many are still standing today, as structurally sound as the day they were built.

30-Degree Pitch

Into their temples the Greeks poured their genius and money. The roofs of these temples, with a pitch of about 30 degrees, were supported by

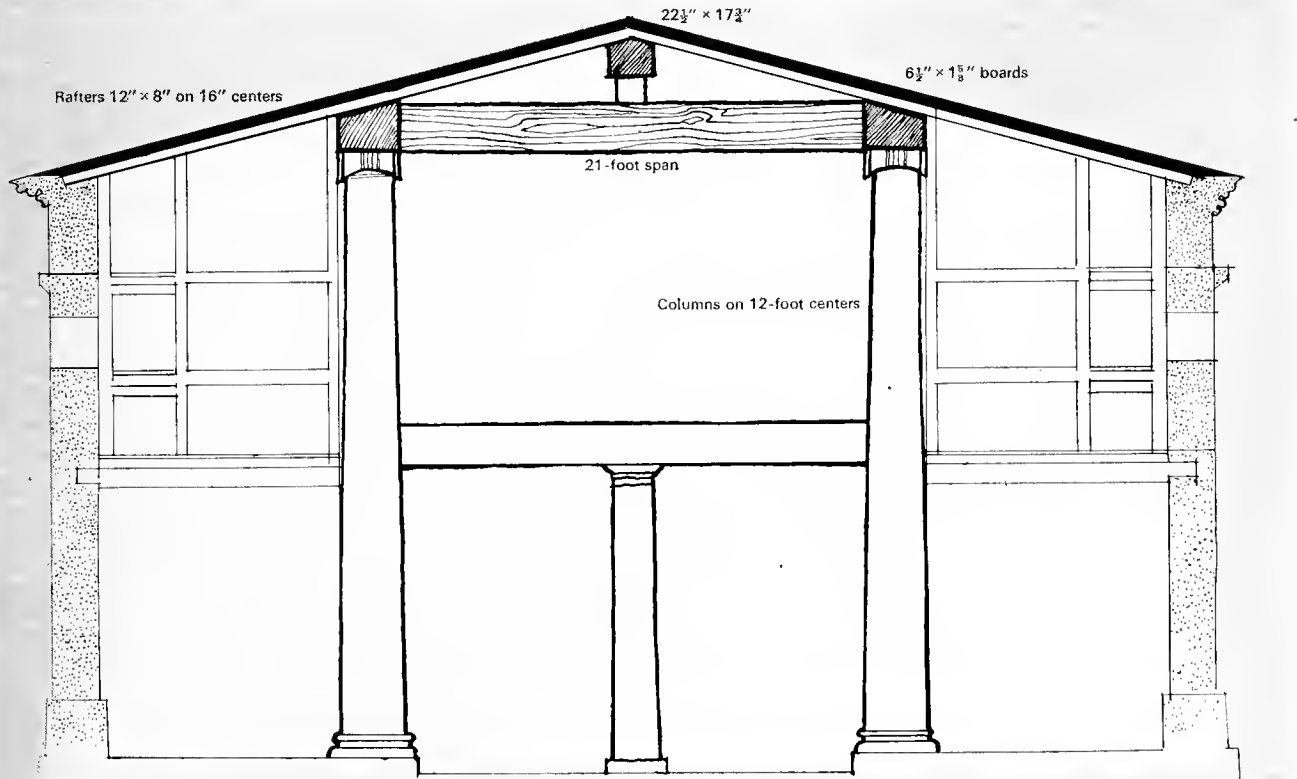

timber construction, judging from the surviving holes in the masonry for the footing of joists and rafters. They were covered with tiles or thin marble slabs.

The fantastic dimensions specified for the roof members, according to the author, suggest that Greek carpenters had no conception of trussing, that is, the stiffening of a beam by braces. Along the top of each row of marble columns—placed on 12-foot centers—were laid heavy longitudinal timbers which were joined with level transverse beams at each column.

Roof Measurements

In order to obtain a low-pitched roof, a timber block was placed at the middle of each transverse beam. On these blocks were laid the ridge beam measuring 22 x 17 inches. The 12 x 8 inch rafters were placed 16 inches apart and rested on the masonry wall and transverse beams. The roof deck carried by the rafters consisted of 6½ x 1½ inch boards spaced ¾ inches apart and crossed by ¾ inch boarding, on which the ceramic tiles or marble slabs were laid. In this roof construction there was no relationship between the structural members and the load carried.

The beautiful columns that typify Greek temples were constructed in sections and joined together with

wooden blocks made of cypress wood. When completed in this way, the joint was hardly visible and each segment was solidly joined together without cement.

Housing in ancient Greece presented a problem the Greeks never entirely solved. The houses were built with wooden frames and completed with mud bricks. These bricks were not baked, however, and keeping the walls in repair was a constant chore. Many families found it was easier to build a new house every few years, rather than repair the weathered mud bricks of the old one.

Designs were simple and efficient. The typical house was oblong with the central axis running east and west and the entrance always at one end. A porch might be added in front and a sanctuary in the rear. Some were two stories high, with the women's quarters upstairs, and usually a sloping hipped roof with wooden rafters, supported by girders, rested on the side walls.

The main feature of the Greek house, of course, was its defense capability. With the men sleeping downstairs, intruders could be intercepted and the house and contents defended fairly easily. This was necessary because ancient Greece was a far cry from the law and order we have to-

day and marauding bands of thieves were quite common.

The interesting thing about Greek houses, Sandström says, was that their master plan provided a basis for later temple designs. In other words, the carpenters who designed and built the early Greek houses were also responsible for the design of the elaborate temples that were to follow. Thus a continuity of theme was maintained by the careful craftsmanship first put into homes. All that was lacking was quality construction material, and that followed with the introduction of marble in the temples.

Not Afraid to Learn

Greek carpenters of antiquity were skilled craftsmen who developed a synthesis of construction techniques from all of the civilizations of the ancient world. They weren't afraid to learn and when they found a better way of doing the job—as when they switched to marble from unbaked brick in their temples—they moved ahead with skill and determination.

These men, of which too little is known, set the stage for Western civilization, and it is to their credit that the Brotherhood has a long and honored tradition of skilled workmanship. In this respect they will not be forgotten. ■

Up Six Percent

New Family Budget: \$6,960 Lower; \$10,644 Medium; \$15,511 Higher

■ Family budgets for four persons on three different levels worked out by the U.S. Labor Department for 1969, which were higher than average wages even then, have gone up still higher due to inflation.

The new budgets are about six percent higher than the 1969 budgets with costs varying widely among cities and regions, with the lowest costs in small cities and in the South.

The average budget costs for an urban family of four in the Spring of 1970—it would be higher now—ranged from \$6,960 a year "at a lower level" to \$10,664 "at an intermediate level" and \$15,511 "at a higher level."

The corresponding figures for the Spring of 1969 were: \$6,544 at the lower level; \$10,064 at the intermediate level and \$14,571 at the higher level.

The hypothetical family used for the study consisted of a 38-year-old husband with a full-time job, his non-working wife and two children, a boy

of 13 and a girl of 8. The couple has been married 15 years and the family is well-established with the husband an experienced worker.

The three budgets cover different levels of living and do not represent the cost of minimum or subsistence level of living. They represent rather differing standards of living covering such items as eating out, more expensive automobiles, higher rents or housing costs, different costs of clothing and personal care.

As could be expected, costs were higher in urban than in non-metropolitan areas, the difference ranging by 13 percent between the lower standard budget and the intermediate and 17 percent between the lower and higher budget.

Anchorage, Alaska had the highest index for comparative living costs while Southern, non-metropolitan areas showed the lowest. Such cities as Honolulu, New York, Boston, San Francisco, Cleveland, Philadelphia,

Chicago and Los Angeles were above the average in costs.

Cedar Rapids, Iowa, marked the dividing line between those above and those below. Those below included: Kansas City, Mo.; Detroit, Baltimore, Denver, Pittsburgh, Cincinnati, Dayton, Dallas, Baton Rouge, Atlanta and Orlando, Florida.

The Labor Department reported that between the Spring of 1967 when the first similar budgets were published, and the Spring of 1970, "consumption costs for each of the three different levels have risen 14 percent." If Social Security payments, and Federal, state and local income taxes are added, the increase was 18 percent.

On all three levels, taxes as a factor in the budgets rose more than consumption costs in relative terms, increasing two percent for the lower budget, three percent for the intermediate budget and four percent for the higher budget. (PAI) ■



CANADIAN REPORT

Social Security Ideas Called 'Patch Up'

Proposals for the overhaul of the federal social security system have been long awaited with great expectations, but the changes advanced last month by the White Paper on Income Security are not so much an overhaul as a patch-up job.

No doubt they are improvements, but they neatly sidestep the key issue of a guaranteed annual income scheme which is now looked upon as an essential basis for a solid social security anti-poverty program for a modern-day technologically-advanced society.

The changes are aimed at helping two groups of people in particular, senior citizens and low income families in the lower income levels.

So far Canada's universal old age pension plan has paid every citizen over 65 a basic \$75 a month plus cost of living allowance bringing the total payment in 1970 to just below \$80.

Canada's mothers' allowance system has paid every mother \$6 a month for each child under the age of 10, and \$8 for children aged 10 to 16—regardless of family income.

Under the new plan the basic universal old age pension is frozen at \$80 a month with no further cost of living increases.

But people over 65 with little or no income will get an increase which will bring the minimum income to \$135 a month for single persons, up from \$111.41; and to \$255 a month for married couples, up from \$222.82.

These senior citizens will of course also get medicare and hospital care free of charge under most if not all provincial health care programs to which the federal government makes a substantial contribution.

The above o.a. pension changes re-introduce a means test into the program. It will be paying more to the

needy and less to those with other income like private pensions, dividends and property.

The same will now hold true for family allowances.

Families with income over \$10,000 a year will no longer get family allowances. Families with earnings around \$4,500 a year will have their payments boosted up to \$16 a child. Families with income around \$8,000 a year will do as well or somewhat better under the plan than they were doing. Families with income between \$8,000 and \$10,000 will be getting less.

The changes will not help those families with breadwinners who are working but earning less than needed for a minimum decent standard of living even including the new family allowances.

The White Paper says, "The needs of people who now live in poverty are clearly those of greatest priority".

The changes do help. It is useless to deny this. But they do not meet the trade union movement's demands for a complete overhaul of social security programs including guaranteed annual income. They do widen the dividing line between rich and poor.

Reuben Baetz, executive director of the Canadian Council on Social Development, put it succinctly: "Under the old system we were all in it, we all contributed and we all got money back. There was no stigma to it.

"But under this plan, when a woman walks into a store to cash a cheque, she can be identified quickly as a low income person."

Job-Creating Loans Under Federal Budget

A few days after the federal government introduced its White Paper on social security, the Minister of Finance Edgar Benson announced a new budget for 1971.

It was at best a cautiously expansionist budget aimed at making jobs

in those areas of the country hardest hit by unemployment. But considering the extent of the jobless problem, particularly in Quebec and the Maritimes, it would be somewhat miraculous if it accomplished its purpose.

One of the main features of the budget is a special \$150 million fund to provide job-creating loans to the provinces in most need. Under this formula Quebec would get about \$68 million at an interest rate of 7.9 percent, British Columbia \$35 million, the Atlantic provinces even less.

No new taxes are being levied and no taxes are being introduced. But a three percent income surtax which was to come off at the end of last year is now to remain—which is not much different from making a new levy of three percent.

A positive note is an increase in unemployment insurance benefits by 10 percent. The new benefits effective January 3rd raise maximum weekly payments for single persons from \$42 to \$46 and for persons with dependents from \$53 to \$58.

The budget increases payments to the federal housing agency, Central Mortgage and Housing, by \$40 million which the building industry has already labelled "a drop in the bucket".

One side comment on the budget is that this is unlikely to be an election year. An indication of an election would be tax cuts.

Union Co-op Housing Opens in Windsor

One of the few cooperative housing projects in Canada sponsored by the trade union movement was officially opened in Windsor, Ontario, toward the end of last year.

The other co-op project was built about a decade ago in Winnipeg.

The Winnipeg project is made up mainly of row housing and single family units.

The Windsor project is a high-rise—300 units in an imposing 26-story structure overlooking Lake St. Clair. The surrounding view from the roof is most impressive, as it looks across the water to Detroit.

While unionists initiated the project, Co-operative Dwellings of Windsor which originally sponsored Solidarity Tower as the apartment block is called, is a community venture.

The building cost a total of \$4,650,000 and of this amount, the federal housing agency, CMHC, put up \$4,100,000 at 8¾ percent. This is no bargain interest rate but at least

CANADIAN REPORT

Continued from Page 19

one percent below the rate available from commercial lenders.

The equity money came from down payments from the owner-residents. Down payment on a one-bedroom apartment is \$1,540 with monthly payments of \$137 including light, heat, water, taxes, maintenance and management; on a two-bedroom apartment, down payment is \$1,915 plus \$157 monthly; on a three-bedroom, down payment is \$2,180 plus monthly payments of \$177.

These costs are well below equivalent accommodation from private developers or landlords.

All the apartments were sold to owner-residents under the co-operative plan which gives each one vote in the decision-making.

The project is quite modern with swimming pool, sauna baths, sundeck, recreation and playground area.

Housing co-ops are not the solution to everybody's housing problem but they can make a definite contribution toward better housing for middle income families at lower cost.

Survey Disclaims Minimum Wage Myth

Those who say that increases in the minimum wage by legislation are likely to destroy jobs and force higher prices got no comfort from a survey made by the Department of Labor in Ontario.

The department studied five needle trade industries just before and after a 30 cents an hour boost in minimum wages came into effect January 1, 1969.

Main result of the finding was that there was very little reduction in employment in the period studied and that was due chiefly to seasonal factors.

Textiles is of course a low wage industry where an increase in the hourly minimum wage from \$1.20 to \$1.50 can be an important factor.

Toronto Plumbers In Poverty Project

Plumbers Local 46, Toronto, did something which it hopes will encourage other building trades unions to do likewise.

They have their offices not far from a rundown area of central Toronto and so are close to the very serious housing problems of people in the

downtown area which is slated for redevelopment.

In response to an appeal from a community group in the area, the local union made a \$3,000 contribution to the rehabilitation of a number of houses so that the tenants could continue to live in them until new development gets going.

The money was spent in paying union wages to the plumbers who worked on the job. The materials for the work were supplied by the building contractors' association.

Provincial Election Appears in Offing

A provincial election in Ontario is very likely in June.

In November 1970 the Ontario New Democrats elected a young and dynamic new leader Stephen Lewis, 32, and started gearing for an election in 1971. Signs were that the fortunes of the party which holds 23 seats in the Ontario Legislature were definitely on the way up.

Apparently Premier Robarts, head of a Conservative government which has been in power non-stop since 1943, thought so too. At this writing, evidence is mounting that the Premier will not lead the Tories into another election. The Conservative Party has leased Toronto's 15,000 seat Maple Leaf Gardens for a February convention.

Trade Unions Increase Pollution Education

More educational work is going to be done in the trade union movement on the subject of pollution.

The Canadian Labor Congress will likely announce pollution and environmental issues as the key subject for Citizenship Month 1971. Every year for the last eight or nine years the CLC has promoted one major issue during Citizenship Month—February. It has keyed on medicare, housing, automobile insurance, old age pensions, guaranteed annual income, in recent years.

The CLC adopted a policy statement on pollution at its 1970 convention and the subject is one which will be advanced by its new social action department.

Various Federations across Canada—including British Columbia and Ontario—have taken up the issue, especially Ontario.

The Ontario Federation of Labor has already published a report of its June 1970 conference on "Solution to Pollution: A matter of life and death"

which will likely serve as a textbook for Citizenship Month. It is available from the OFL at 25 cents a copy . . . but one copy free of charge.

The OFL pulled a ten-strike by inviting and getting the co-operation of the Community Colleges of Ontario in promoting a series of seminars on pollution in October.

The result was 33 seminars on one day—Saturday, October 17th—involving 19 community colleges and 46 labor councils.

This produced some very good publicity for the trade union movement in the local press right across the province.

Wage Guidelines Go By The Board

The federal government has finally given up on its vaunted wage guidelines program.

The program started in March 1969 was ineffective. Unions without exception made it a matter of principle to break the six percent guidelines and few of them failed. The building trades in particular showed them to be nonsense.

The business community too was fed up with the pretense that such guidelines could be of any effect either on wages or prices and John Young, chairman of the Prices and Incomes Commission threw in the towel at the end of the year.

But the Commission will continue to operate. It will study specific price increases and publish reports on them. This is exactly what it was supposed to do in the first place. Labor's objection to the operations of the Commission last year was that it did not do its homework. It tried to enforce a policy without having done the essential research on which it could be rationally based.

New Leader For New Democrats

The New Democrats are seeking a new leader federally too.

The party is holding a leadership convention in April in Ottawa. Veteran leader T. C. "Tommy" Douglas won't run again. Four names at least will be on the ballot—David Lewis, Canada's leading labor lawyer until he got elected to the House of Commons and now deputy leader of the NDP, Ed Broadbent M.P. for Oshawa-Whitby, John Harney, former Ontario NDP secretary, and James Laxer, all three of them university professors.

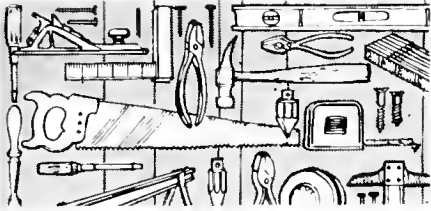

LOCAL UNION NEWS

West Virginia Local Observes Birthday

The twenty-fifth anniversary of Local 2023, St. Marys, West Virginia, was observed recently with a dinner and a meeting at the fire department social rooms.

Earl McDonald of Marietta, president of the Mid-Ohio Valley District Council, was the principal speaker. A history of the organization was given by Myles Worstell, Local 2023 business representative.

Twenty-five year pins were presented to charter members still active with the local union.



Officers of Local 2023 are, left to right, William F. Smith, treasurer; Robert A. Brown, Jr., trustee; Myles Worstell, business representative and financial secretary; Phillip Smith, vice president; Jennings A. Smith, president; and C. A. Nichols, trustee.



Receiving congratulations on 25 years of membership from Business Representative Myles Worstell are Phillip Smith, at left, and C. A. Nichols.

McCulloch is 1970 Bent-Nail Winner



At Bent Nail presentation ceremonies were, left to right: Harry Dawson, Local 1140 business representative and president of the Los Angeles District Council; Dean G. Weddle, Local 1507, business representative and recording secretary; Paul Stevens, Local 1507, warden; William Sidell, Local 721, First General Vice-President of the Brotherhood; Garvan A. McGehee, Local 1507, former business representative; Gordon A. McCulloch, Local 1140, executive secretary of the Los Angeles District Council; William A. Bennett, Local 1507, business representative; C. A. (John) Ward, Local 1507, secretary-treasurer; Stanley A. Kasianovitz, Local 1507, conductor; and Armond L. (Slim) Henderson, Local 1296, executive secretary, San Diego Building Trades.

At the California State Council of Carpenters Convention held in San Diego last year, Gordon A. McCulloch was presented with El Monte Local 1507's annual Bent Nail Award for outstanding contributions and service to the labor movement in general and to California Carpenters in particular.

The Bent Nail Award is presented each

year, and every Carpenters' local union and district council in the State of California is eligible to submit a candidate's name for consideration. The public relations and political education committee of Local 1507 then reviews the biographical sketches of those candidates submitted and decides who the winner will be for that year.

LOCAL UNION NEWS

Pictures and news items for The CARPENTER are to be addressed to: Editor, The Carpenter, United Brotherhood of Carpenters and Joiners of America, 101 Constitution Ave., N.W., Washington, D.C. 20001. Please identify all persons shown in photos from left to right, front row to back row, with names spelled correctly and clearly. Because of the large amount of editorial material sent in, we cannot always use local union news immediately following receipt. We will publish all articles of merit as quickly as space is available.

We urge local correspondents to send in news and pictures as quickly as possible after the news event occurs. Such material must be timely for publication.

J. C. Baker of Local 109, Marks 92nd Birthday



Brother J. C. Baker recently marked his 92nd birthday at home with his wife of 66 years. A member of Local 109 in Sheffield, Alabama, since March 29, 1904, Brother Baker is certainly among the oldest of our Brotherhood. He now wears reading glasses, reports Fourth District General Executive Board Member Harold E. Lewis, who visited the Bakers recently. He reports that Brother Baker says he's going to live to be 100, and after seeing the fine state of health and the general bright and cheerful attitude of Brother and Mrs. Baker, we are reassured that they will go beyond the century mark. The picture shown here was taken on the occasion of Brother Baker's 91st birthday.

Local 1246 Veteran Celebrates 88th Birthday



The only living charter member of Local 1246 in Marinette, Wis., Brother Otto Carlson, celebrated his 88th birthday on November 1. Brother Carlson, who resides in Menominee, Michigan, joined Local 1246 in September 1902, and was an active carpenter for 56 years. He is still in fairly good health and enjoys reading and watching television. His hobbies have been cabinet making and violin making, since retirement in 1955.

SERVICE TO THE BROTHERHOOD



1

(1) WALTHAM, MASS.—Friends of labor from various points across the Eastern Seaboard of Massachusetts gathered recently to salute Brother Joseph Robillard, marking his 30 years of service in Local 540. Among those present were Arthur Clark, mayor of Waltham; General Representatives Richard Griffin and Carl Soderquist, and representatives of many area locals, including Lawrence Local 111, Haverhill Local 82, Woburn Local 885, Arlington Local 831, Boston Locals 51, 40, and 218, Boston Millwrights Local 1121, and other locals of the Newton District Council (Natick Local 847, Concord Local 1593, Needham Local 693, and Newton Locals 275, 680 and 708). Members of the Waltham Laborers Union No. 560, Bricklayers Local Union 15, and the Tri-Painters and Decorators Union No. 1963 were also present. A gift was presented to Brother Robillard, who served 23 of the past 30 years in the local as treasurer, by Chairman and Past President Allan Stirling, and a bouquet was presented to Mrs. Robillard by Co-chairman Allan McNeil, on behalf of the local. Shown at the presentation are (left to right): seated—Mrs. and Brother Robillard, Mrs. and General Representative Carl Soderquist. Standing—Father Gaudett, Co-chairman Allan McNeil, Chairman Allan Stirling and General Representative Richard Griffin.

(2) MANCHESTER, N. H. — Three members of Local 1688 recently were honored by their union, and were presented their 25-year service pins. President Arthur Gimás, left, made the pin presentations to Arthur Hobsch, Maurice Dube, and Jules Degelan (shown in that order).

OAKLAND, CALIF. (No picture was supplied to the editor.)—Millmen's Local 550 presented 25-year pins to the following members at a meeting December 18:

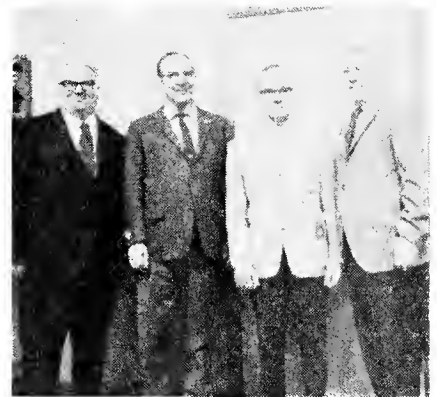

2

Ralph Andres; Fred Bardoli; Raymond Bargagliotti; George L. Barlow; Richard D. Benson; Edward L. Blair; Bathias Boesinger; Joseph A. Brune; Vernon Buesen; Glenn Carson; J. A. Dane; Frank D'Antonio; Manuel DeCosta; Albino Deiro; Joseph DePont; Arpad Doka; Paul Dovell; Paul Durante; W. C. Ellis; Hollis Ewart; Joseph Ferreira; S. A. Frakes; Peter Francisco; George Gable; Lawrence V. Gaiato; Ralph Garcia; Earl F. George; Frank Gonsalves; William F. Garcia; William M. Honlon; John Herrera; Raymond Hilderbrand; John D. Hill; George E. Jensen; Roy H. Jensen; Albert R. Johnson; Fred Kalning; Woodrow L. Kay; Fred Klein; Victor M. Kohl; Guy E. Lackey; Frank P. LeGreve; Frank J. Leonard; A. H. Lind; Manfred Lindahl; Gotthard Lindblom; John J. Mahoney; Frank Matutovich; James W. Maynard; Rau L. McDaniel; Carl W. Miller; Oscar E. Nelson; R. J. Neumann; Hugh O'Connor; True Protzman; Ray Pugsley; Thomas Resch; Frank Roat; Allan A. Samuelsen; John C. Schrammel; Edwin F. Schulze; Ralph Spencer; Jim D. Tullis; Walter Vierra; Antone Vigallon; Arthur Villata; L. R. Young, and Thomas H. Ziegenfuss.



1

SERVICE TO THE BROTHERHOOD

(1) ST. LOUIS, MO.—More than 1,000 Carpenters, family members and guests attended a Local 47 function recently at which some 350 members were recognized for long service in the union and trade. Standing at head table in background, left to right: Retired Carpenters District Council Secretary-Treasurer Erwin Meinert and his wife; Local 47 Vice-President Theodore and Mrs. Roesler; 6th District International Representative Fred Bull; President Joseph and Mrs. Humphrey; CDC Director of Jurisdiction Pleasant Jenkins and his wife; CDC Executive Secretary-Treasurer Ollie Langhorst and Mrs. Langhorst; Financial-Secretary Leroy and Mrs. Lasley, and CDC Assistant Executive Secretary-Treasurer Carl Reiter. The entire St. Louis Carpenters Hall—upstairs and downstairs—was used for the gala celebration.



2

(2) CARPENTERS' LEADERS with two Local 47 members of 60-year standing. From left: Carpenters District Council Director of Jurisdiction Pleasant Jenkins; International Representative Fred Bull; 60-year members Walter Fisher and William Porter; CDC Executive Secretary-Treasurer Ollie Langhorst and Business Representative Larry Daniels. A total of 354 members were honored, including: three 65-year members, eleven 60-year men; five 55-years, nine 50-years; thirty-nine 45 years; sixteen 40-years; twenty-one 35 years; one hundred ninety-two 30-years, and fifty-eight 25-year members.



3

(3) CICERO, ILLINOIS—At a recent meeting of Local 54, service pins were presented to these members (with years of service to the Brotherhood indicated in parentheses): Front row—Paul Kropacek (51); Frank Janeczek, deceased November 2; Frank Sebek (60); Joseph Karlovsky (64); John Baumruk (58); Joseph C. Prochazka (50); and Anton Nuzik. Back row—George Mills (25; Joseph



4

Kralicek (25); James Streje (25); Robert Lid, business agent; John Pernicka, president (29); Fred Will (21), and George Budlovsky (25).

1963, at a recent special meeting honored its 25-year members with Silver pins. They are (from left to right): Antoni Pietrowski, Albert Tokarz, Walter Krula and John Mitchell, President of Local 1963 since 1947.

(4) TORONTO, ONTARIO — Local

APPRENTICESHIP & TRAINING

In-Service Training Program Ends

■ With the November Seminar for Coordinators and Directors of Apprenticeship Programs, the United Brotherhood of Carpenters and Joiners of America concluded the Carpentry Apprenticeship Instructor In-Service Program begun a year and a half ago.

The first of 20 sessions, opened July 7, 1969, with a greeting by General President M. A. Hutcheson, and during the sessions all of the General Officers have met the seminar participants as the officers' time would allow.

The In-Service Training Program was instituted and developed under the direction of Technical Director Leo Gable and the late First General Vice President, Finlay Allan, and

funded jointly by the United Brotherhood of Carpenters and Joiners of America and the Department of Health, Education and Welfare, through the cooperation of Dr. Howard Matthews and William Woodfin of the Department of Health, Education and Welfare.

A total of 869 instructors and 112 coordinators have attended the 20 one-week sessions in groups of approximately 45. Instructors or coordinators have attended from all 50 states, and groups were invited to sessions in an effort to achieve a cross-sectional national representation at each assembly.

The objectives of the program were to provide a national conversation among apprenticeship instruc-

tors and coordinators as to the problems of instructing apprentices, the development of multi-media communication techniques, facilitating the adjustment of disadvantaged young men into apprenticeship, and the problems of administration of apprenticeship programs.

The staff for implementing the In-Service Program was headed by James Tinkcom, project coordinator. Tinkcom, Albert Preheim, William Ludwig, and William Oviedo served as instructors and discussion leaders. The staff was impressed with the dedication, enthusiasm and quality of discussion the coordinators and instructors brought to the seminars throughout the program, and feel that the United Brotherhood is to



The November seminar for coordinators and directors of apprenticeship programs—perhaps the final gathering.

2 MEN CAN LIFT WALLS INTO PLACE IN 5 MINUTES WITH **PROCTOR WALL JACKS**

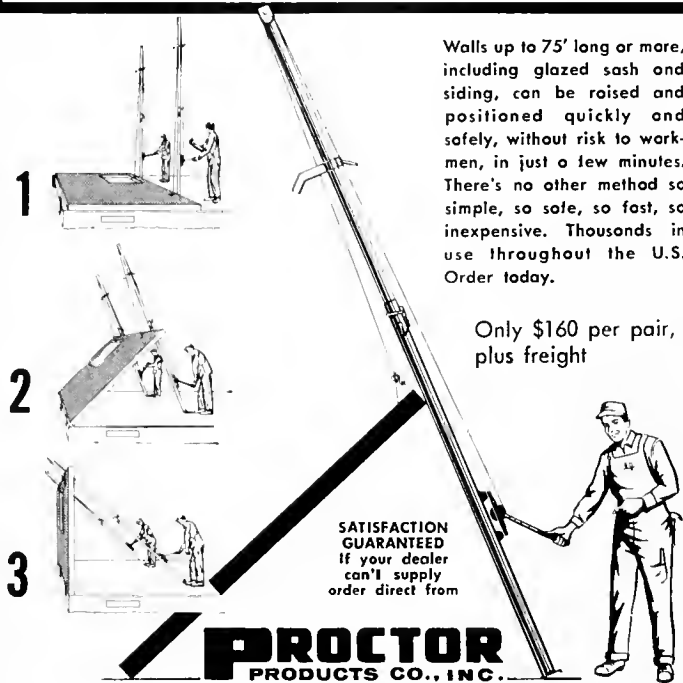

Walls up to 75' long or more, including glazed sash and siding, can be raised and positioned quickly and safely, without risk to workmen, in just a few minutes. There's no other method so simple, so safe, so fast, so inexpensive. Thousands in use throughout the U.S. Order today.

Only \$160 per pair, plus freight

SATISFACTION GUARANTEED
If your dealer can't supply order direct from

PROCTOR PRODUCTS CO., INC.

BOX F • KIRKLAND, WASHINGTON 98033

be complimented upon the stature of its nationwide instructional staff.

A questionnaire has been distributed to all participating instructors and coordinators as to their feelings about the effectiveness of the program, and upon completion, a statistical "feedback" will be distributed to all seminar participants. ■

ARIZONA PLAUDIT



Mel Stewart and the Golden Hammer Award at presentation ceremonies in Arizona. (See story, opposite page.)

BY POPULAR DEMAND



Last month, The CARPENTER published a one-page feature entitled "The Hard Hat's Credo," which we reproduce above in miniature. The popularity of this feature and the demand for copies of the Credo suitable for framing has been so great that The CARPENTER is offering a limited number of copies of this page to its readers at 25¢ each. (The price covers costs of handling and mailing.) Send your order for The Hard Hat's Credo to: Editor, The Carpenter, United Brotherhood of Carpenters and Joiners of America, 101 Constitution Avenue, N.W., Washington, D.C. 20001.

For Nearly 50 Years ESTWING Tools have been First Choice of Expert Craftsmen the World Over!



Of Course—There's A Reason—

Forged One-Piece Solid Steel, Strongest Construction Known, Unsurpassed Estwing Temper Balance and Finish. PLUS Estwing's Exclusive Nylon-Vinyl Cushion Grip—Won't Loosen, Come off, or Wear Out.

Estwing MFG. CO. Dept. C-1
2647-8th St. ROCKFORD, ILLINOIS

Completion Ceremony in Central Arizona

The Central Arizona Carpenters Joint Apprenticeship Committee held its annual completion ceremony October 16 in Phoenix. Nineteen carpenter apprentices and five millwright apprentices satisfactorily completed four years of

training and received their certificates. Mel Stewart, business representative of Local 1216, Mesa, was presented a Golden Hammer Award for his many years of service as a member of the Central Area Committee.

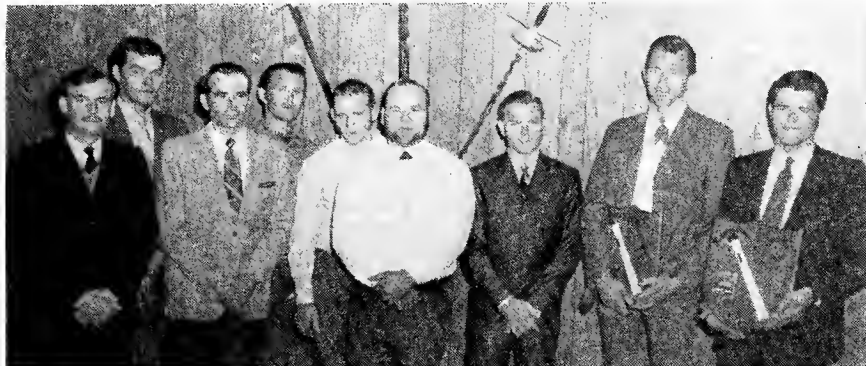

New Arizona journeymen, left to right, John H. Johnson, millwright; Malcolm W. Wilcox, millwright; Robert E. White, millwright; and Carpenters Fred Eggstein, John J. Carlson, Charles A. Denny, Milton J. Kent, Ronald H. McGee, and Philip L. Erickson.



Left to right: E. J. Wasielewski, chairman of the Arizona Carpenters' Apprenticeship Committee; H. Stan Sibert, business representative, Millwright Local 1914 and state committee member; Malcolm Wilcox, outstanding millwright apprentice; R. E. Barrett, secretary of the state committee and secretary of the district council of Carpenters; Ronald McGee, area winner; Philip Erickson, Carpenter outstanding apprentice and "Cliff Maddox Award" winner; and Ben Collins, general representative of the United Brotherhood of Carpenters and Joiners of America.



Wives of the Outstanding Apprentices: left to right, Mrs. Philip L. Erickson, Mrs. Malcolm W. Wilcox, and Mrs. Ronald H. McGee.

You'll Like Being a
**SKILLED
LOCKSMITH**



You'll EARN MORE, LIVE BETTER
than Ever Before in Your Life

You'll enjoy your work as a Locksmith because it is more fascinating than a hobby—and highly paid besides! You'll go on enjoying the fascinating work, year after year, in good times or bad because you'll be the man in demand in an evergrowing field offering big pay jobs, big profits as your own boss. What more could you ask!

Train at Home—Earn Extra \$\$\$\$ Right Away!
All this can be yours FAST regardless of age, education, minor physical handicaps. Job enjoyment and earnings begin AT ONCE as you quickly, easily learn to CASH IN on all kinds of locksmithing jobs. All keys, locks, parts, picks, special tools and equipment come with the course at no extra charge. Licensed experts guide you to success.

Illustrated Book, Sample Lesson Pages FREE
Locksmithing Institute graduates now earning, enjoying life more everywhere. You can, too. Coupon brings exciting facts from only school of its kind Lic. by N. J. State Dept. of Ed., Accredited Member, Natl. Home Study Council, Approved for Veteran Training.

LOCKSMITHING INSTITUTE
Div. of Singer Communications Corp.
Dept. 1118-011 Little Falls, N. J. 07424

Earned \$150 During Training
I realized with LOCKSMITHING I'd be able to double my income. During my training period I made \$150.
Paul Funes
New York, N. Y.



LOCKSMITHING INSTITUTE, Dept. 1118-011
Little Falls, New Jersey 07424 Est. 1948

Please send FREE illustrated Book—"Your Big Opportunities in Locksmithing," complete Equipment folder and sample lesson pages—FREE of all obligation—(no salesman will call).

Name.....
(Please Print)

Address.....

City..... State..... Zip.....

Check here if Eligible for Veteran Training

**MY SPARE TIME HOBBY
MAKES ME
\$500 an hour
CASH PROFIT**

START YOUR OWN SPARE TIME BUSINESS.
You can turn your spare time into Big Cash Profits with your own **COMPLETE SHARPENING SHOP**... Grind saws, knives, scissors, skates, lawn mower blades... all cutting edges. Your Own Cash Business with no inventory... right at home... no experience needed.

FREE BOOK tells how you can start your own spare time business while you are still working at your regular job. Low Cost - time payments. 30-Day Free Trial.

Just Mail Coupon—No Salesman Will Call

BELSAW SHARP-ALL CO., 731J Field Bldg.,
Kansas City, Mo. 64111

Send Free Book, "LIFETIME SECURITY." No obligation.

Name.....

Address.....

City..... State..... Zip.....

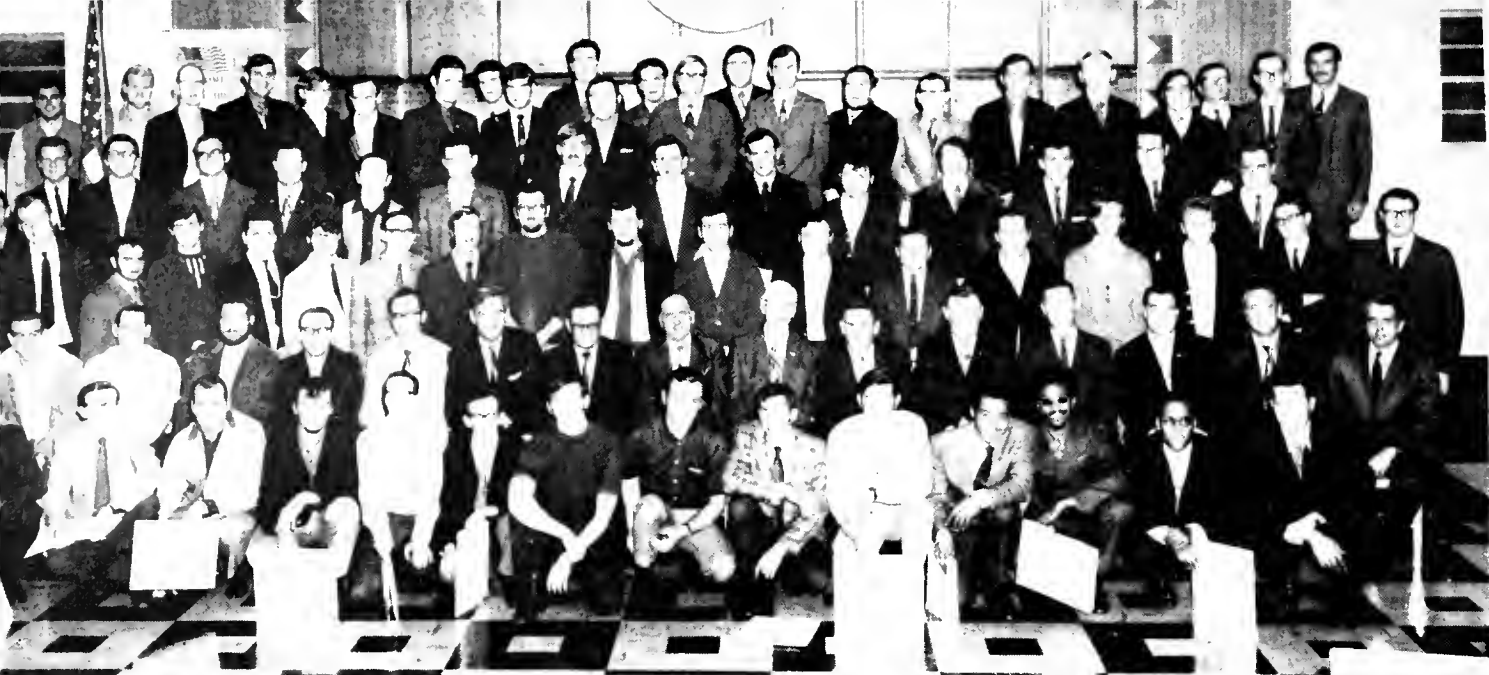

The big graduating class assembles for a picture at district council headquarters in Chicago.

Chicago Graduates 80 Apprentices in November

The Chicago District Council of Carpenters recently graduated into the ranks of journeymen a class of 80 apprentice carpenters.

The affair, held at the Chicago District Council Headquarters on November 5, 1970, was attended to capacity by the graduating apprentices, with officers of their respective local unions represented.

Talks were given by representatives of the Builders Association of Chicago, as well as representatives from the Washburne Trades School, the United States Department of Labor, the Building and Construction Employers Association, the State of Illinois Employment Service, and Father Joseph Donahue.

Highlighting the evening was a talk delivered by First General Vice Presi-

dent William Sidell on behalf of the Council, George Vest, Jr., president of the Chicago District Council, and Charles A. Thompson, secretary-treasurer of the Chicago District Council, presented to First General Vice President Sidell, an inscribed rosewood gavel. Vice President Sidell announced on behalf of General President M. A. Hutcheson, that George Vest, Jr., has been offered a seat on the International Apprenticeship Committee.

All in all, the evening was a most delightful graduation exercise with its surprise events tastefully complemented by a buffet dinner.



District Council President George Vest, Jr., presents an inscribed rosewood gavel to First General Vice President William Sidell in appreciation for his participation in the ceremonies and his leadership of the Brotherhood training program.

Four smiling graduates with Brotherhood leaders, who included District Council Secretary-Treasurer Thompson, First General Vice President Sidell, District Council President Vest, and Richard Pepper, Management Representative on the Joint Apprenticeship Committee.



Meany blasts one-sided CEA attack on wage increases

■ AFL-CIO President George Meany has blasted as utterly unfair and one-sided the report of the Council of Economic Advisers which blames wage increases for continuing inflation and places the major burden of higher prices on workers.

"I don't buy that and American workers won't buy it," he said in a statement refuting the Council's charges against wage increases and reiterating organized labor's warning that workers do not intend to be the victims of restraints that are not applied equally to profits and dividends.

Meany declared that wages have not caused inflation, that workers have not profited by it and, indeed, are its chief victims, "a fact about which they are not happy".

He charged that nothing in the 41 pages of the CEA's report mentions that the buying power of the average worker is two percent less than it was a year ago and is even less than it was in 1965.

"The document," he said, "is heavily weighted against wage increases for workers, but is very solicitous about profits for business."

There is not a word about interest rates as a cause of inflation, Meany continued, nor inflated land prices in the construction industry, nor soaring bank profits. "The attack on the UAW settlement with GM is unwarranted," Meany said, calling the agreement instead "a most responsible agreement."

"Nor is the cause of industrial peace promoted," he continued, "by attempting to undermine the recommendations of the President's Emergency Board in the railroad dispute which were, in themselves, meager and unsatisfactory."

The economy, Meany declared, "must be made to work for all the people. Equity must be restored by eliminating inequity."

He concluded by warning that American workers are determined to have their "fair share" of the American economic pie. (PAI) ■

Always look for the union label and union shop card when you shop. It's your assurance of quality goods produced under fair working conditions.



These FREE BLUE PRINTS have started thousands toward BETTER PAY AND PROMOTION

That's right! In all fifty states, men who sent for these free blue prints are today enjoying big success as foremen, superintendents and building contractors. They've landed these higher-paying jobs because they learned to read blue prints and mastered the practical details of construction. Now CTC home-study training in building offers you the same money-making opportunity,

LEARN IN YOUR SPARE TIME

As you know, the ability to read blue prints completely and accurately determines to a great extent how far you can go in building. What's more, you can learn plan reading simply and easily with the Chicago Tech system of spare-time training in your own home. You also learn all phases of building, prepare yourself to run the job from start to finish.

CASH IN ON YOUR EXPERIENCE

For over 67 years, building tradesmen and beginners alike have won higher pay with the knowledge gained from Chicago Tech's program in blue print reading, estimating, foremanship and contracting. Through step-by-step instruction, using actual blue prints and real specifications of modern, up-to-date buildings, you get a practical working knowledge of every building detail—a thorough understanding of every craft. And as a carpenter or apprentice, you already have valuable experience that may let you move up to foreman even before you complete your training.

Don't waste a single day. Start preparing right now to take over a better job, increase your paycheck and command greater respect as the "boss" on the job. Find out about Chicago Tech's get-ahead training in building. Send for your free blue prints and trial lesson — today! Approved for Veterans.

CHICAGO TECHNICAL COLLEGE

A-143 TECH BLDG., 2000 S. MICHIGAN AVE., CHICAGO, ILL. 60616

Free BLUE PRINTS AND TRIAL LESSON

Send for your free trial lesson now. You'll agree that this training is simple yet practical—your surest way to promotion and increased income in building.

MAIL COUPON TODAY

Chicago Technical College
A-143 Tech Bldg., 2000 S. Michigan
Chicago, Illinois 60616

New G.I. Bill!
Vets check here

Please mail me Free Trial Lesson, Blueprints and Catalog.

Name _____ Age _____

Address _____

City _____ State _____ Zip _____

Occupation _____

Accredited Member National Home Study Council

35 New Journeymen Millwrights Feted in Detroit



Recent graduates of Local 1102's Joint Apprenticeship Training Program assembled for a picture.

Both labor and employer representatives of the Millwright Local 1102 Joint Apprenticeship Committee have been loudly voicing the praises of the Detroit Mich., training program. And rightfully so.

Twice within the past three years have the program's apprentices captured millwright national apprenticeship championships in contests sponsored by the parent United Brotherhood of Carpenters and Joiners of America.

William Stewart, who won the latest apprentice title last year in Denver, Colo., was among 35 millwright graduates of the apprentice classes of 1969 and 1970 honored at a JAC-sponsored testimonial dinner in the Raleigh House, Detroit.

On hand to welcome them to journeyman status within Local 1102 were Carpenter Union officials on the local, state and national levels.

Without exception, each speaker singled out Stewart for individual praise and lauded the JAC collectively for its record of achievement.

Dominick "Lucky" Spano, business manager of Local 1102 and JAC chairman, pointed with pride to Stewart and Daryl Wright, the 1968 national champion, saying that the accomplishments of these two could serve as a challenge to others who follow.

Spano also lavished praise on Ralph Caruso, JAC co-ordinator, for his "outstanding contribution" to the labor-employer sponsored program.

As master of ceremonies, Spano introduced the following speakers:

International Representative Robert Laing; Jack Wood, secretary-manager of the Detroit Building Trades Council; Robert Cox, JAC secretary representing management; Leonard Zimmerman, secretary-treasurer of the Michigan State Carpenters Council; John Harrington, Detroit Carpenters District Council secretary-treasurer, and Macomb County District Court Judge Roy Gruenburg.

Laing extended greetings to the gradu-

ates of the four-year training program from United Brotherhood President Maurice Hutcheson and William Sidell, first general vice president.

Stewart was another brief speaker. A member of the 1970 class, he personally thanked the JAC for the training opportunity presented him and other graduates and asked that each committee member stand and be recognized.

Stewart also praised Caruso's efforts on

his behalf and expressed further thanks to those millwright journeymen who lent a helping hand during the job training phase of the program.

Climaxing the testimonial affair was presentation of apprentice completion certificates to the graduates by Joseph Crawford and George Millsap, union members on the JAC, and Mel Woodbeck and C. D. Connelly, employer committee members.

THE PAYOFF COMES

Continued from page 13

This gap in the spending stream will retard the next expansion in much the opposite way that capital spending helped to cushion the recent slowdown.

One important new source of demand to offset this expected weakness in business investment is the steady recovery of housing. The heavy flow of savings in 1970's first half supplied the only ingredient that has been missing in this depressed sector, and the upturn in housing starts that followed will gather momentum in 1971.

So, in the early stages of recovery, the expansionary forces of *government* (the decision to ease up on anti-inflationary restraint) and *consumers* (whose normal day-to-day spending for goods and services are being reinforced by a big increase in housing investment) are more than balancing off the temporary sag in business capital spending.

Economic conditions that directly

affect construction shape up this way for 1971:

- **Fed. Govt. Spending**—Very tightly budgeted, at least through mid-year, in order to keep deficit at minimum. Could ease a bit once fiscal-72 budget takes over next July 1st.
- **Monetary Policy**—Object is to support 4-4½% growth without rekindling inflation. Once recovery is firmly established, money will be held to slower increase than at present. Long-term interest rates should drift downward through mid-71.
- **State & Local Govt. Spending**—Will expand a bit faster in 1971 as states and municipalities find the bond market more receptive to their need for funds.
- **Consumers**—Mortgage availability capable of supporting 20% more conventional housing starts.
- **Capital Spending**—Gradualness of recovery here means that excess capacity won't be absorbed quickly. Total outlays for next year: about equal to 1970's \$81 billion.



"We Congratulate..."

... those members of our Brotherhood who, in recent weeks, have been named or elected to public offices, have won awards, or who have, in other ways, "stood out from the crowd." This month, our editorial hat is off to the following:



Stadler, Hansen, Jarvis, and Discher.

SCHOLARSHIP — James Discher, Route 6, Menomonie, Wisconsin, a member of Local 252, Oshkosh, and a junior at Stout State University, has received a \$1,500 scholarship from the Wisconsin State Council of Carpenters and its affiliated local unions and district councils. At the presentation were: Ronald Stadler, president of the state council, shown in the picture presenting the check to the scholarship winner; Chester C. Hansen, secretary-treasurer, state council (standing left) and John Jarvis, university vice-president for academic affairs (standing right). Discher's selection for the scholarship was based on his work, his union and school record as an apprentice carpenter, and on an oral and written examination, conducted at the Madison Area Technical College under the supervision of the state council officers and representatives of the Wisconsin State Board of Vocational, Technical and Adult Education.

HEROISM ON THE JOB— A Uniloader operator named Jim Elmes was working on a high-rise building project in Wilkes-Barre, Pa., last November 9, when the Uniloader upset, pinning him under the equipment. Gasoline on the hot motor formed a threatening white-spray cloud and appeared ready to explode.

While other workers fled the scene, expecting an explosion, two Brotherhood members courageously dug under Elmes' pinned leg with their hands and pulled him to safety. The employer, Grosek & Sons Construction, credits their prompt action with saving Elmes' life.

The two Brotherhood members are Primo Calletti, a member of Local 514, Wilkes-Barre, and Jim Maguire, a member of Local 768, Kingston, Pa.

BLOOD DONOR—Carman E. Davis, a member of 639, Akron, O., recently became one of America's youngest five-gallon blood donors. At age 35 he is a member of the Emergency Blood Donor Groups which is on call on a 24-hour basis. He donates blood at various hospitals in the Akron area on several occasions each year.



Davis

PLAQUE RECOGNITION— Louis Tolve, a member of the Brotherhood for 55 years who has served Local 543, Mamaroneck, N.Y., as business agent for 39 years, got recognition outside the union recently.

More than 200 persons paid tribute to Brother Tolve at an annual Republican barbecue in recognition of his "years of service to the Village of Mamaroneck and the Republican Party." Tolve was lavishly praised by such elected officials as Rep. Ogden Reid, State Senator Anthony Gioffre, and Assemblyman Joseph Pisani.

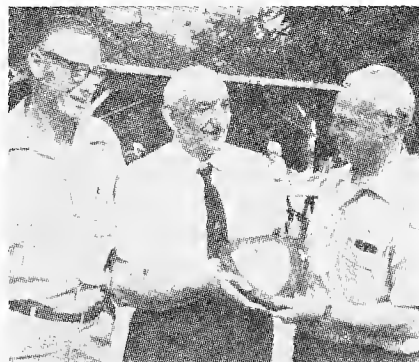

Tolve, right, is presented plaque.

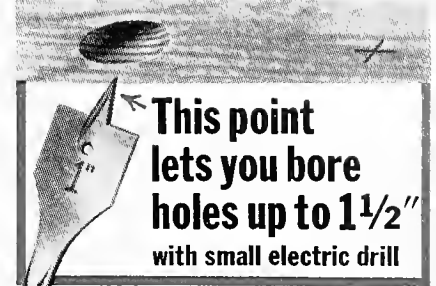

This point lets you bore holes up to 1 1/2" with small electric drill

IT'S HOLLOW GROUND to bore cleaner, faster at any angle

Now step-up the boring range of your small electric drill or drill press to 1 1/2" with Irwin Speedbor "88" wood bits. 1/4" shank chucks perfectly. No wobble. No run-out. Sharp cutting edges on exclusive hollow ground point start holes faster, let spade type cutters bore up to 5 times faster. You get clean, accurate holes in any wood at any cutting angle.

Each Irwin Speedbor "88" forged from single bar of finest tool steel. Each machine-sharpened and heat tempered full length for long life. 17 sizes, 1/4" to 1 1/2" and sets. See you Irwin hardware or building supply dealer soon.



IRWIN SPEEDBOR "88" WOOD BITS
at Wilmington, Ohio, Since 1885

VACATION & SMALL HOMES - \$1

... Income Producing & Duplexes - Multiple Units.

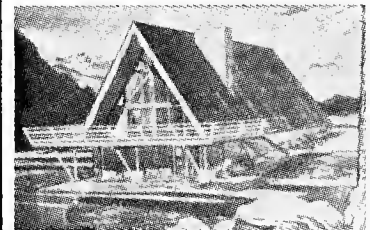

LEISURE - RETIREMENT - AND INCOME. Over 125 plans for duplex, multiple units, residential income property and small retirement - type homes \$1.00
MAIL TODAY

GARLINGHOUSE
OLDEST, MOST RESPECTED
HOME PLANS COMPANY

Dept. CAR 1-1
P.O. Box 299
Topeka, Kansas 66601

() Check here for complete library of 13 books \$10

NAME _____
ADDRESS _____
CITY _____ STATE _____

YOU NEED

The original
"wedge-type" screwdriver

QUICK-WEDGE

SCREW-HOLDING SCREWDRIVER

IT'S YOUR THIRD HAND

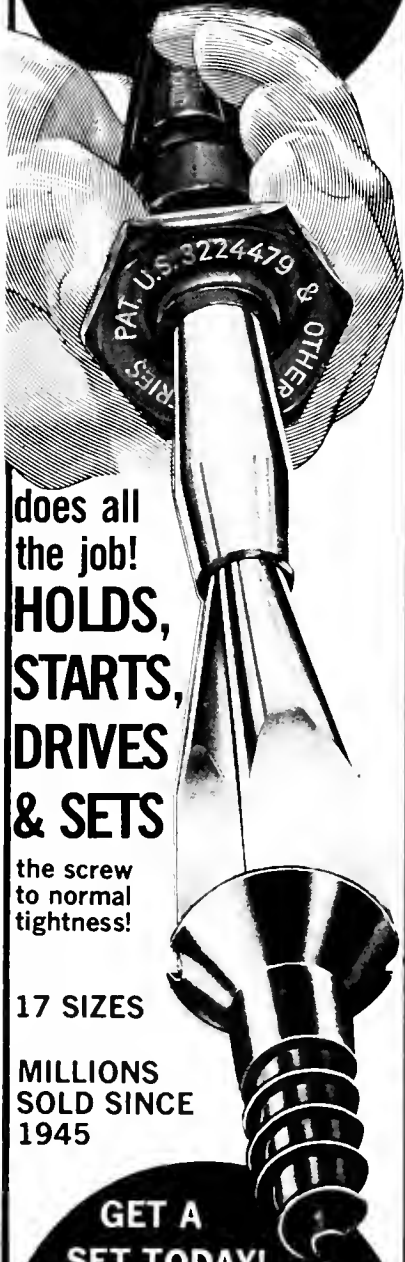

does all
the job!
**HOLDS,
STARTS,
DRIVES
& SETS**

the screw
to normal
tightness!

17 SIZES

**MILLIONS
SOLD SINCE
1945**

**GET A
SET TODAY!**

Unconditionally Guaranteed
Finest Quality
Workmanship & Materials
At Your Dealers or Write

KEDMAN COMPANY

P. O. Box 267

Salt Lake City, Utah 84110

Phone (801) 363-4413

© 1970 by Kedman Company



Employees at the union printing plant in Washington, D.C., where *The CARPENTER* is printed, donate blood to the Red Cross. This is part of an effective and continuing program.

Blood Bank System In U.S. In Urgent Need of Reform

■ There is urgent need for reform in the American blood banking program both to cut costs and reduce the risk of disease from transfused blood in the view of Leo Perlis, Director of the AFL-CIO Department of Community Services.

Perlis, in an interview on "Labor News Conference" over the Mutual Broadcasting System, said that blood banking is now a "number of uncoordinated and in some ways uncooperative" programs. The commercial blood bank is boosting prices and by now has become a lucrative business without adequate controls to prevent disease.

Pointing out that commercial blood banks are often located in "skidrow areas," he said that blood purchased for \$15 a unit is eventually sold for as much as \$50 or \$60—"sometimes far beyond that, in the case of rare types."

Perlis declared that besides being costly, blood from commercial banks carries a high risk of disease, mainly hepatitis. "About 90 percent of all hepatitis cases resulting from transfusions are due to blood obtained from commercial blood banks that

buy their blood from prisoners" and other "down-and-out people." He said that the annual death toll of "blood-transfused hepatitis" ranges between 1500 and 3000.

He urged the American Red Cross to take the lead in a drive for a national "blood assurance program" based on public service voluntary donors. He said that while the Red Cross now has the biggest non-profit blood banking program, it has not had an "aggressive and dynamic" program to recruit voluntary donors since World War II. He said that some two million patients need blood each year and that it takes some seven million units to meet that demand.

He predicted that if the spotlight of public opinion is put on the present state of blood banking in the U.S. and an effective donor recruitment drive is mounted, "120 million (donors) could be encouraged to give blood," and meet the demand on a voluntary non-profit basis. The AFL-CIO would "not only help, but cooperate vigorously" in that kind of effort, Perlis asserted. (PAI) ■

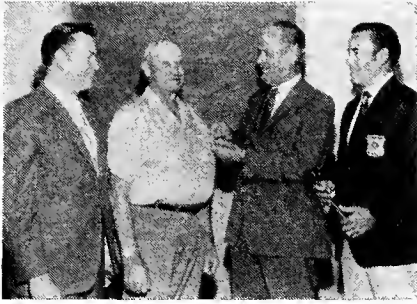

1



Service to the Brotherhood



A gallery of pictures showing some of the senior members of the Brotherhood who recently received 25-year or 50-year service pins.

(1) LOS ANGELES, CALIF.—Cabinet Makers & Millmen Local 721 honored their "Old Timers" September 15 before a record turnout of their membership and honored guests. A total of 60 members were eligible to receive awards —37 for 25-year pins, 22 for 30-year gold cards, and one member, Brother Maynard H. Robinson, was the recipient of the 50-year pin. Making the presentation are, from left, Tony Bogdanowicz, business manager of Local 721; Maynard Robinson, 50-year pin recipient; John F. Henning, secretary-treasurer of the California Federation of Labor, AFL-CIO, who made the presentations, and Local 721 President James Flores.

(2) Thirteen members of Local 721, Los Angeles, recently awarded 30-year pins. There were 22 members eligible for the award. They are (not listed in order shown): Raymond Cannon, William L. Derr, Apolino Espino, Joseph L. Ezell, Charles Garson, Paul A. Herman, John Holuboff, Oscar Izenman, Sam Jackson, John Jacobs, Chris Laursen, Harry McFarland, Rudolf Melendez, Claude Porter, George Reader, Carl Reseck, Paul Robinson, Lawrence Rout, Jack Rouse, Treve Sanders, George D. Self, and Albert Zaitz.

(3) Recipients of 25-year pins at Local 721's recent "Old Timers" night. Eligible for the pins are (although not listed in order shown, and some not present): Carlyle Aaen, Zenon Alderette,



2



3

Ignacio Alvarez, Kirby Bahcock, Kenneth Barnes, Eric Blaufuss, Otto Bojorques, Henry Bulthuis, Ted Caughthran, Steve Cseke, Jr., Giacomina Dragatto, G. R. Gustafson, Howard Hanson, William E. Harper, Melvin F. Hassler, Herman Hempe, Charles J. Hopp, Gustave P. Humber, Jr., James J. Hopp, John E. Jensen, Paul E. Johnsen, Arthur Jordan, Paul Katzenberger, Max Kemble, Joe Kutes, Thomas L. Mongeon, Charles Ochoa, Max Overton, Joe Pena, Jr., Paul E. Rose, Henry Roth, John Rufer, Clint G. Sullivan, Berthald Symank, Alessio Vivona, Alfred Weisshaar, and John S. Welch.

(4) MELBOURNE, FLORIDA — A 50-year pin was recently presented to Local 1685 member Christian Thomassen, at his home in Pineda. Shown at the ceremony, from left, are: Mrs. Thomassen; Brother Thomassen; George T. Wood, recording secretary of Local 1685, and H. W. Hubler, financial secretary.

(5) AMELIA, OHIO—Brother William Dahlman of Local 224, Cincinnati, received his 50-year pin from Recording Secretary Peter N. Claug, in a recent presentation.



4



5



Outdoor Meanderings

Readers may write to
Fred Goetz
 2833 S. E. 33rd Place,
 Portland, Oregon 97202

Those Giant Kamloops

... EVER HEAR OF THEM?

It may be a long way from where you live but you'll have to go there if you want to catch the world's largest rainbow trout. I refer to Lake Pend Oreille, located in the northern panhandle of Idaho near the Montana and Canada border. Here fins a gigantic species of rainbow, the Canadian-bred "Kamloops," transplanted from British Columbia's Kootenay Lake in 1942. A few years after the transfer, rainbow trout the size of truck mufflers were taken and on a historic day in November, 1947, Wes Hamlet startled the angling world by catching a 37-lb. Kamloops from Pend Oreille's seemingly fathomless depths.

Ever since then, trophy-bent trout fans have been trolling the lake's vast acreage, trying to top Hamlet's mark. Awestruck divers have come to surface with tales of 50 pounders cruising the bottom. Even the most conservative of Idaho's fishery biologists hesitate to deny the claim.

This year the Outdoor Writers Associ-

ation held their annual conference at Coeur d'Alene, Idaho, little more than an hour's drive from the resort town of Hope on Pend Oreille's northwest shore. I left Portland a few days before the meet started to have a "try" at the Kamloops. It was just that, a "try." In three days, I logged 24 hours for the lunkers, each day in company with an in-the-know Kamloops fisherman and failed to provoke a strike. "Do not be discouraged," they consoled, "it takes about 60 hours for a beginner to hook one."

First day on the lake was with Fred Page Jr., one of Hope's top guides. Recorded in his boat's log were over 200 Kamloops over 15 pounds, taken in the last 4½ seasons, 20 of which he caught himself.

A four-rod setup on Page's boat featured two rods in holders off the stern and two through outriggers at midships. Gear was as follows:

RODS—Two-piece, 7½-ft. with somewhat flexible tips sections.

REELS—Penn Model 49 M's, the "M" designating metal spools.

LURES—Various sizes and patterns of salmon plugs and wobblers.

LINE—300 yards of 25-lb. test monofilament nylon next to spool; 100 yards of 35-lb. test braided line following and a 12-ft., 20-lb. test monofilament leader at the end.

Page uses this latchup for mid-season trolling—from five to six feet below the lake's surface at around 3½ miles per hour. To avoid line twist, roller bearing swivels are used. (Later in the year, spreaders, weights and planing devices are used to acquire greater depth.)

After a fruitless second-day effort with Fred Burnside, also of Hope, we switched to lighter gear for a two-hour "go" at kokanee and managed to catch a bucketful. Kokanee are landlocked salmon,



Fred Page Jr. and R. K. Dickerson show pair of chunky Kamloops rainbow nailed from Lake Pend Oreille. (World record from this lake weighed twice as much.)



Hope resort owner Fred Burnside shows 11-inch kokanee which serves as prime food source for giant Kamloops rainbow of Lake Pend Oreille. (Goetz photo)

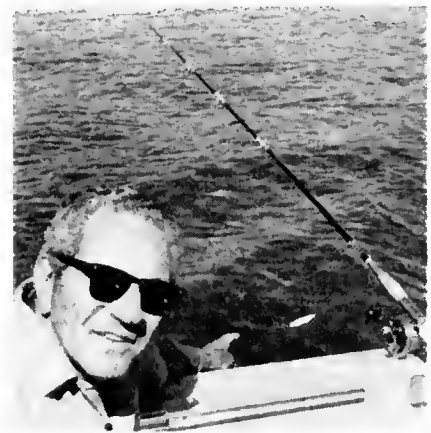

Kirk Kirkpatrick points to "Tiny Lonie" plug which duped several lunker Kamloops from Lake Pend Oreille.



Columnist Goetz obligingly displays Lucky Orm's "teenage Kamloops trout." (Sprungman photo)

which average out from eight to twelve inches. They are the lake's forage fish and provide main fare for the ravenous Kamloops. So abundant are they in Pend Oreille that a 50-per-day sport limit is allowed.

Last eight-hour junket was with Sandpoint resident "Kirk" Kirkpatrick who has the distinction of having caught all his lunker Kamloops on one battle-scarred lure called the "Tiny Louie." Also aboard that day was fellow outdoor scribe Ormal Sprungman of San Diego. Known in the fraternity as "Lucky Orm," he lived up to his name by catching a five pounder in the first hour, a relatively small (for Pend Oreille, that is) but nevertheless genuine Kamloops.

Before I left Hope, I saw Fred Page again. He was just returning from an all-day sortee with R. K. Dickerson. They unceremoniously flopped two beautiful chrome-bright Kamloops on the dock, a 17½ and 19 pounder, both duped near the lake's surface. Unlike native lake and stream rainbow or steelhead, the Kamloops is salmon-like in build, more deep of body than the traditional deep-bodied Chinook salmon.

I have but scratched the surface of Pend Oreille's sprawling 80,000 acres. Having a shoreline of over 110 miles, it's over 43 miles long and six miles wide. In addition to giving up the world's largest rainbow, it has also produced a world-record Dolly Varden, a 32-pounder by N. L. Higgins in 1949, and lake trout (Mackinaw) up to 35 pounds.

I hope to return to Pend Oreille this fall and round out an apprenticeship on the lake. Who knows, maybe I'll be lucky enough to hook one of those 50 pounders the divers talk about.

■ Action in Arkansas

James H. Black of Hope, Arkansas (retired from Local 211, Houston, Texas), says there's two outdoor pastimes that can be indulged in with great success in his neck o' the woods: namely squirrel hunting and bass fishing; and he sent photographs to prove it, which, unfortunately, were too faint to reproduce. But I got the message and am happy to pass it along, Jim.

Brother Black says there's five wonderful bass lakes within a 5-mile radius of Hope, and he's found that he can catch 'em just about anytime in the year. His snapshot depicted a trio of bass taken this past December, the largest being a 4½ pounder.

■ Stripers

We hear that Robert Mason of Livermore, California, a member of Local 2046 in Martinez, and his fishing buddy Clarence Otter have been knocking the striped bass dead this year, and not too far from home base in the fish-lush waters of San Pablo Bay. The big stripers have been pulling the scales down to 29 pounds.

For Spare Time or Full Time
Income, Here's How To Earn

MONEY IN SHARPENING

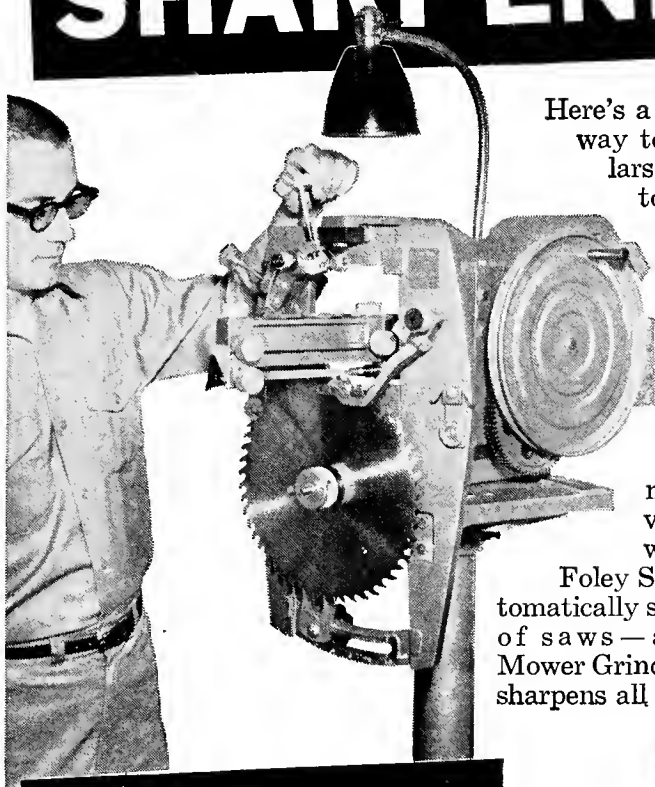

Here's a proven practical way to earn extra dollars in spare time—to develop money-making repair business of your own. Investment is small. There's no overhead, no stock of goods to carry. No experience needed, no canvassing. You do it with the famous

Foley Saw Filer that automatically sharpens all kinds of saws—and the Lawn Mower Grinder that precision sharpens all types of mowers.

EARN UP TO \$6 AN HOUR IN SPARE TIME

Hundreds of people like yourself are making cash like this—\$20 to \$30 a week—right now in spare time. "My spare time saw filing business has made me \$952 these first ten months"—says R. T. Chapman. Many have built a complete sharpening service with such year-around profits. You can too, simply by following the sure, easy Foley Plan.



Get Free Book Now "Money Making Facts"

This valuable book shows you how to start, how to get business from home owners, factories, carpenters, etc., and how to make profits fast. Mail coupon today. No salesman will call.



FOLEY MANUFACTURING COMPANY

118-1 Foley Building, Minneapolis, Minnesota 55418

Saw Filer information.

Lawn Mower Sharpener information.

Money Making Facts booklet.

NAME _____

ADDRESS _____

CITY _____ STATE _____ ZIP _____

BE A PANELING EXPERT

Take all the guesswork out of aligning and marking corner panels with our kit of rugged aluminum off-set jigs and marking gauges.

Increase your speed and accuracy as you scribe perfect panels marked for a "pressed-in" fit. Panel-by-panel instructions included for inside and outside corners and for the location of cut-outs, for plywood panels of 1/4" or less.



NOW... OFFSET JIGS FOR ROUTERS

A Cut-In-Place method of fitting inside corner panels. The router takes the place of the marking gauge or scribe and precisely cuts over 90% of an 8 ft. panel. Complete instructions.

- Offset jigs and marking gauges. \$9.95 Postpaid. (Calif. tax 50c)
- Cut-In-Place jigs for your router. \$6.95 Postpaid. (Calif. tax 35c)

Only Californians add sales tax. C.O.D. orders: you pay postage and charges. Satisfaction guaranteed or money refunded.

A revolutionary new tool dolly!

Heavy duty compact design • turns on a dime • jumps electric cords with ease

Detailed Construction Plans — \$1.95. Check or M.O. Californians add 10c tax.

PANELING SPECIALTIES CO.
Box 11764 • Palo Alto, Calif. 94306

LAYOUT LEVEL



- ACCURATE TO 1/32"
- REACHES 100 FT.
- ONE-MAN OPERATION

Save Time, Money, do a Better Job
With This Modern Water Level

In just a few minutes you accurately set batters for slabs and footings, lay out inside floors, ceilings, forms, fixtures, and check foundations for remodeling.

HYDROLEVEL is the old reliable water level with modern features. Toolbox size. Durable 7" container with exclusive reservoir, keeps level filled and ready. 50 ft. clear tough 3/10" tube gives you 100 ft. of leveling in each set-up, with 1/32" accuracy and fast one-man operation—outside, inside, around corners, over obstructions. Anywhere you can climb or crawl!

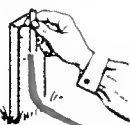

Why waste money on delicate instruments, or lose time and accuracy on makeshift leveling? Since 1950 thousands of carpenters, builders, inside trades, etc. have found that HYDROLEVEL pays for itself quickly.

Clip this ad to your business stationery and mail today. We will rush you a Hydrolevel with complete instructions and bill you for only \$7.95 plus postage. Or send check or money order and we pay the postage. Satisfaction guaranteed or money back.

Ask your tool dealer to order it for you. We allow the usual dealer discount on 1/2 Doz. lots and give return-mail service.

HYDROLEVEL

925 DeSoto, Ocean Springs, Miss. 39564
FIRST IN WATER LEVEL DESIGN SINCE 1950

WHAT'S NEW?



CORRUGATED HOUSE

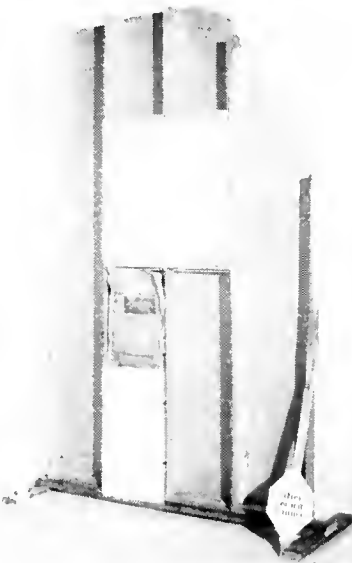

The 1970 Fibre Box Association corrugated design competition has awarded a silver medal to a corrugated house engineered by Connelly Containers, Inc., Bala Cynwyd, Pa.

Designed by Universal Papertech, Inc., Hatfield, Pa. the modular houses come in kit form, and are made of chemically impregnated corrugated.

Because the design is modular, the corrugated houses can be variably constructed from basic building units as one-story houses ranging from 400 to 1400 square feet or as a two-story A-frame. Coated outside with glass fibre or sprayed concrete and inside with a chemical fibre-swelling coating, the fibreboard house will last for 20 years and withstand heat to 1900 degrees Fahrenheit.

The 400 sq. ft. unit weighs 450 pounds, and arrives complete with windows and doors in two boxes that can be hauled in a station wagon. Three men can erect the unit in about ten hours. Step-by-step assembly instructions with variables are included.

The cost of the basic 400 square foot, single story unit is \$800. Interior finishes add \$160 and a factory made center core that provides a room divider, shower toilet, kitchen sink, electric stove, refrigerator, closet and heating unit space adds \$400.

DASHBOARD POWER UNIT

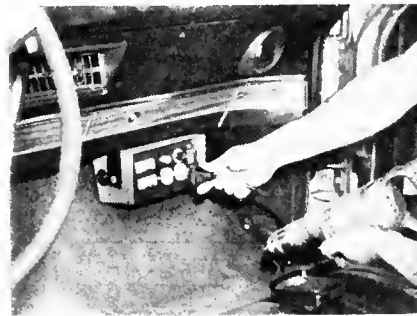

A power unit that fits under your automobile dashboard delivers up to 3600 watts, enough to power skill and table saws, heavy duty drills, and jack hammers, while simultaneously powering lighting appliances. Called the Dynamote GS, the unit features a bypass system which eliminates any drain on the car battery. Larger capacity models are also available. Write Dynamote, P.O. Box 177, Beloit, Wis. 53511.

NEW TRIM SAW

A 4 1/2 inch trim saw designed to cut problem materials quickly and cleanly has been introduced by Rockwell Power Tools. The new Rockwell 314 saw has been designed for a variety of special sawing applications including the cutting of trim, plastic laminates, plywoods, composition boards, thin non-ferrous metals, plexiglass and other problem materials.

Powered by a 4.5 amp motor through a high-torque worm gear drive, the 4 1/2 inch blade turns at 3,800 rpm. The unit cuts stock up to 1 1/16 inch at 90 degrees, and 1/16 inch at 45 degrees.

Additional information on the trim saw can be obtained from the Power Tool Division, Rockwell Manufacturing Company, 400 North Lexington Avenue, Pittsburgh, Pennsylvania 15208.

ALL-STEEL AXE

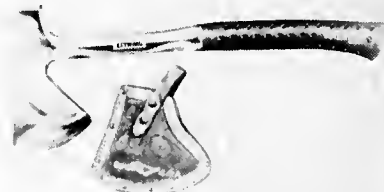

A new all-purpose axe—ideal for general use as well as camping, home or farm—has been introduced by Estwing. The E44A axe is full polished with forged steel head and 4-inch cutting edge. A nylon-vinyl hand grip adds non-slip comfort; it won't loosen, come off or wear out. The cutting head is protected by an attractive embossed leather sheath that comes with the axe. The 16-inch-long axe weighs three pounds; its list price is \$10.50. For information, write Estwing Mfg. Co., 2647 Eighth Street, Rockford, Ill. 61101.



IN MEMORIAM

**L.U. NO. 12
SYRACUSE, N.Y.**

Given, Clifford
Lamphere, Harold

**L.U. NO. 15
HACKENSACK, N.J.**

Airikka, Konstantin
Goetschuis, David
Huismann, Peter
Toniola, Justino

**L.U. NO. 19
DETROIT, MICH.**

Hamilton, Jack

**L.U. NO. 20
NEW YORK, N.Y.**

Eversen, Engvald
Flail, Karl
Franco, Salvatore
Greet, Horace
Hendricksen, Helmer
Holtermann, Charles
Jacobsen, Ingvald
Konczynski, Steve
Savern, Peter
Schreiber, Alex

**L.U. NO. 35
SAN RAFAEL, CAL.**

Elliott, Harry L.

**L.U. NO. 40
BOSTON, MASS.**

Deveau, Leo
Frisone, Matthew S.
Hardy, Ernest
Philpot, Lincoln C.

**L.U. NO. 54
CHICAGO, ILL.**

Janecek, Frank

**L.U. NO. 55
DENVER, COLO.**

Wesman, Ernest

**L.U. NO. 88
ANACONDA, MONT.**

Martheson, Martin

**L.U. NO. 89
MOBILE, ALA.**

Dreading, B. J.
Hand, Tommie

**L.U. NO. 90
EVANSVILLE, IND.**

Magee, Frederick
Schinemann, Albert
Schultze, Fred
Stephan, Adolph

**L.U. NO. 94
PROVIDENCE, R.I.**

Bates, Percy
Caswell, Frank
Charnley, Frank
Denton, Arthur
Eklof, Frank W.
Lessard, Joseph
McAuliffe, Frederick
Nelson, Gustaf
Payette, Francred
Seidel, Raymond

**L.U. NO. 101
BALTIMORE, MD.**

Lowman, Edgar M.
Scott, Paul S., Jr.

**L.U. NO. 104
DAYTON, OHIO**

Bratten, Charles S., Jr.
Brooks, Gerald C.
Dailey, George L.
Elkins, Henry H.
Evans, Louis
Gansley, Robert
Hatfield, William D.
Hendrickson, Lloyd E.
Himes, Allen
Riggs, Charles A.
Roberts, Edmond M.
Vore, Ray C.
Witham, Clifford

**L.U. NO. 106
DES MOINES, IOWA**

Karnes, George
Rydberg, Ernest

**L.U. NO. 129
HAZELTON, PA.**

McGee, Daniel

**L.U. NO. 132
WASHINGTON, D. C.**

Delphay, Ernest
Elmendorf, Roy A.
Jaeger, George R.
Johnson, Gustaf A.

**L.U. NO. 144
MACON, GA.**

Keen, G. F.
Smith, G. E.

**L.U. NO. 174
JOLIET, ILL.**

Jeffrey, Frank
Schmekel, William

**L.U. NO. 181
CHICAGO, ILL.**

Forsell, Louis

**L.U. NO. 195
PERU, ILL.**

Guerrini, William
Noonan, Charles

**L.U. NO. 226
PORTLAND, ORE.**

Dockery, John F.
Nelson, Melvin C.

**L.U. NO. 246
NEW YORK, N.Y.**

Haimowitz, Barney
Henriksen, Charles
Petroff, Paul

**L.U. NO. 257
NEW YORK, N.Y.**

Hanson, Ernest
Mald, Frank J.
Ressa, Peter
Winkelman, George

**L.U. NO. 261
SCRANTON, PA.**

Alsbaugh, William
Atterson, Stanley
Blackledge, John
Bronson, Edward
Gatto, Nick
Grahm, John
Hedig, John
Pettinato, Carl
Piehl, William
Roche, Edward

Roman, Michael
Schirg, Fred
Stender, Otto
Trestic, Al
VanBlarigan, Adam

**L.U. NO. 278
WATERTOWN, N.Y.**

Kast, Herbert

**L.U. NO. 281
BINGHAMTON, N.Y.**

Stout, Alvin E., Sr.

**L.U. NO. 283
AUGUSTA, GA.**

Byrd, Harmon W.

**L.U. NO. 297
KALAMAZOO, MICH.**

Baker, Leslie
Hornaday, Charles
Makay, Michael
Neubauer, Martin

**L.U. NO. 314
MADISON, WIS.**

Babcock, Ray
Baumgartner, M. R.
Bluel, Jerome
Borchardt, Robert
Bradani, Jake
Gilardi, Bert
Matthews, John
Richards, Wilbur
Ryan, Lawrence
Scheib, Joe
Stout, Glen
Swiggum, Victor
Tierney, Tom
Weitzel, Ireneus A.

**L.U. NO. 331
NORFOLK, VA.**

Elliott, Henry R.
Gordon, William V.
Inabinet, J. B.

**L.U. NO. 335
GRAND RAPIDS, MICH.**

Miller, Alvoid
Sherman, Thomas

**L.U. NO. 347
MATTOON, ILL.**

Chapman, Edward
Jones, Homer, Jr.
Phipps, Marion
Stech, Ray

**L.U. NO. 366
NEW YORK, N.Y.**

Lindquist, Carl A.

**L.U. NO. 403
ALEXANDRIA, LA.**

O'Quinn, W. L.

**L.U. NO. 413
SOUTH BEND, IND.**

Breysacher, Clarence
Cressy, Clement
Fink, Nelson
Nelson, Harry

**L.U. NO. 488
NEW YORK, N.Y.**

Anderson, Carl R.
Brody, Jacob
Fleischman, Isadore
Walter, Max

**L.U. NO. 494
WINDSOR, ONT.**

Cote, J.
Hewet, A.
Yauck, H.

**L.U. NO. 531
ST. PETERSBURG, FLA.**

Galt, Robert M.
Joinville, Theodore
Olsen, Ole

**L.U. NO. 562
EVERETT, WASH.**

Bishop, Malcolm
Woods, Thomas G.

**L.U. NO. 586
SACRAMENTO, CAL.**

Caire, John
Docker, Fred
Ferguson, Arthur
Meager, John G.
Rader, John
Sloppy, Carl L.
Whalin, John O.
Wiedman, Henry
Yeakel, Rodney E.

**L.U. NO. 608
NEW YORK, N.Y.**

Huron, Harry
Grassini, Cosmo
Moloney, Michael
Ohman, Henry

**L.U. NO. 621
BANGOR, ME.**

Larson, Dorian T.

**L.U. NO. 665
AMARILLO, TEX.**

Kimbrell, C. L.
Milligan, Harris
Roberts, Doyle
Smith, Ernest

**L.U. NO. 674
MT. CLEMENS, MICH.**

Reynolds, Louis W.

**L.U. NO. 695
STERLING, ILL.**

Drury, William P.

**L.U. NO. 710
LONG BEACH, CAL.**

Braitsch, Charles J.
Burrell, Charles A.
Culler, C. Richard
Frampton, Jack
Jones, Marion E.
King, Edwin C.
Klosterman, George D.

**L.U. NO. 746
NORWALK, CONN.**

Mallett, Wesley

**L.U. NO. 750
JUNCTION CITY,
KANS.**

Bachmann, Adam

**L.U. NO. 753
BEAUMONT, TEX.**

Fogleman, Ernest
Folks, Houston
Hemenway, W. H.
Tippett, Andrew L., Jr.
Winfrey, H. M.

**L.U. NO. 756
BELLINGHAM, WASH.**

Anable, Clarence
Erickson, Fred
Flotree, Antone
Nelson, Carl O.
Nieshe, George

**L.U. NO. 770
YAKIMA, WASH.**

Johnston, Roy L.

**L.U. NO. 787
NEW YORK, N.Y.**

Fast, Sven

**L.U. NO. 875
PANAMA CITY, FLA.**

Bailey, J. T.
Davis, Arthur
Mixon, L. T.
Rycroft, J. E.

**L.U. NO. 882
LOUISVILLE, COLO.**

Mathias, Henry G.

**L.U. NO. 925
SALINAS, CAL.**

Blakeman, Albert
Daggett, Lyman

**L.U. NO. 937
DUBUQUE, IOWA**

Horch, Louis

**L.U. NO. 982
DETROIT, MICH.**

Bledsoe, James

**L.U. NO. 1065
SALEM, OREG.**

Lee, Archie

**L.U. NO. 1098
BATON ROUGE, LA.**

Thompson, O'Quinn

**L.U. NO. 1128
LA GRANGE, ILL.**

Juna, John, Sr.

**L.U. NO. 1209
NEWARK, N.J.**

Allen, Jack
Barclay, Andrew
Brown, John
Church, Louis, Sr.
Does, Jacob
Fairweather, William
Haripoulas, Constanino
Henry, Joseph
Korkuc, Charles
Kovac, John
Lund, John
MacDonald, Hugh
Stopper, John
Sojidak, Peter

**L.U. NO. 1235
MODESTO, CAL.**

Graves, Willard F.

**L.U. NO. 1274
DECATUR, ALA.**

Aday, Willard
Crow, Louie
Haribson, Basil G.

Continued,
next page



IT PAYS TO CHECK YOUR SOCIAL SECURITY EARLY



✓ Check Your Social Security Record

"I've been paying into Social Security ever since it started—my checks should be pretty high, I guess." You've probably heard that remark often, but you don't have to guess about the status of your Social Security account; it's something you can, and should check regularly.

Social Security currently maintains the earnings records of more than 150 million workers in the United States. Many safeguards are used to insure that each worker is given credit for the correct amount of money he has earned, but sometimes mistakes do occur.

The only way to be certain that Social Security has the correct information about year earnings is to check your record at least once every three years. If a mistake is found in your Social Security record, it can be corrected very easily by your local Social Security Office, provided it is found soon after it occurs. Mistakes in reported earnings which are discovered more than three years after they are made are harder to correct because

employers may move, go out of business, or destroy records which are necessary to provide corrected information about your wages. Sometimes, this may result in a lower benefit when your checks are due.

You may check your Social Security record by writing directly to: SOCIAL SECURITY ADMINISTRATION, P. O. Box 57, Baltimore, Maryland 21203.

Be sure to include your Social Security number, your date of birth, and your return address in any letter you write.

A special post card form used to request information about your Social Security records is also available from any Social Security Office. Ask for form OAR-7004, request for statement of earnings. If you are age 60 or older, you may use the same form to request an estimate of the benefit you will receive when you retire. You may also use this form to find out how much work under Social Security you will need in order to get checks, and how much work has already been credited to your account.

✓ Apply for Social Security Early

Do you plan to retire soon? If you are going to apply for social security benefits, you should do so three months before your retirement date.

It may take two to three months to process your application. Even though the Social Security Administration is constantly adopting procedures to speed up service, the workload remains heavy, and you are advised to apply early so your first check will arrive at the earliest possible time. If you wait too long, your payments may be late in getting started.

If you are almost 65, apply for Medicare even though you plan to continue working. It is important that you apply before the month you turn 65; otherwise, your coverage under the Medical Insurance portion will not begin until after your birthday.

You may not have to visit a social security office at all to apply for benefits. Many applications are now being taken by phone. To find out whether yours can be, call your nearest Social Security office, Monday through Friday.

IN MEMORIAM, concluded

L.U. NO. 1292 HUNTINGTON, N.Y.

Anciewicz, Francis
Candros, Louis
Oudalstol, Jonas
Peltola, George

L.U. NO. 1303 PORT ANGELES, WASH.

Greenbrook, Edwin
Housman, Alva R.
Langworthy, Howard H.
Larson, Sig

L.U. NO. 1367 CHICAGO, ILL.

Larsen, Norman E.

L.U. NO. 1397 N. HEMPSTEAD, N.Y.

Kowalski, William
Lirio, Abilio
Tackman, Anton F.

L.U. NO. 1407 SAN PEDRO, CAL.

Andrade, Ernest
Cowing, Charles F.
Duke, Paul G., Jr.
Hopkins, James M.
Gough, Paul G.
Herman, Ben G.
Hernandez, John M.
Lefler, Leonel M.
Morse, Charles W.
Murphey, David S.
Ornelas, Francisco
Pippin, Mack W.
Schaffer, Henry C.
Symons, Harry W.
Toscano, Refugio
Williams, Miles M.

L.U. NO. 1527 WHEATON, ILL.

Creager, Frank
Finnely, Robert

Johnson, Robert
Woody, Danny

L.U. NO. 1599 REDDING, CAL.

Whiting, J. A.

L.U. NO. 1683 EL DORADO, ARK.

Williams, Hoyle

L.U. NO. 1699 PASCO, WASH.

Bailliff, Richard
Bierbaum, Richard
Burlingame, Mark

L.U. NO. 1784 CHICAGO, ILL.

Stromer, Edward
Torma, Vince

L.U. NO. 1849 PASCO, WASH.

Froelich, William
Johannson, Lester

Johnson, George A.
Rogers, M. A.

L.U. NO. 1889 DOWNERS GROVE, ILL.

Brittingham, Thomas
Dodds, Joseph
Peterson, Orvie E.

L.U. NO. 2161 CATSKILL, N.Y.

Weinert, Max W.

L.U. NO. 2274 PITTSBURGH, PA.

Shandorf, Louis F.

L.U. NO. 2376 SANFORD, FLA.

Jacobs, James
Lossing, Max
Thompson, R. V.
Wilborn, Howard

L.U. NO. 2403 RICHLAND, WASH.

Booth, Kenwood A.

Bryson, Ernest C.
Choate, James L.
Ellestad, John O.
Kingsley, James E.
LaBarr, Frank
Palmer, Ralph L.
Rislov, Sigvold
Sonderland, Carl S.
Thompson, Harold S.

L.U. NO. 2435 INGLEWOOD, CAL.

Coenen, S. J.
Dean, Robert A.
Hengst, Edward
James, Robert A.
Kelley, Clarence
Kunz, Robert
Lehmkuhl, M. C.
Long, William
Pettersson, Thomas
Roberson, Raymond
Sligar, George
Towels, Carl
Turner, Frank
Winn, John



Lakeland News

Items of interest from the Brotherhood's retirement home at Lakeland, Florida

Samuel H. Fleming, Local 1665, Alexandria, Va., was readmitted to the Home Nov. 6, 1970.

Alcide Grandmont, Local 32, Springfield, Mass., arrived at the Home Nov. 23, 1970.

Wm. T. Bramel, Local 1108, Cleveland, Ohio, arrived at the Home Nov. 24, 1970.

Matt Moss, Local 1590, Washington, D.C., arrived at the Home Nov. 27, 1970.

Oscar Carlson, Local 488, Bronx, N.Y., arrived at the Home Nov. 30, 1970.

Arthur Nielson, Local 105, Cleveland, Ohio, died Nov. 8, 1970. Burial was in Cleveland.

Wm. P. Friedrich, Local 1947, Hollywood, Florida, died Nov. 21, 1970. He was buried in the Home Cemetery.

Joseph Hada, Local 1209, Spring Lake, N.J., died Nov. 26, 1970. Burial was at Newark, N.J.

Christian Munk, Local 58, Chicago, Ill., left the Home July 24, 1970 and has not returned.

Harold J. Cobb, Local 131, Seattle, Wash., left the Home August 8, 1970, and has not returned.

Joseph Lambert, Local 94, Providence, R.I., withdrew from the Home Nov. 13, 1970.

**Be Better Informed!
Work Better! Earn More!**
**ORDER YOUR COPY
of
SIGMON'S
"A FRAMING GUIDE
and STEEL SQUARE"**



- 312 Pages
- 229 Subjects
- Completely Indexed
- Handy Pocket Size
- Hard Leatherette Cover
- Useful Every Minute

Gold mine of understandable, authentic and practical information for all carpenters and building mechanics, that you can easily put to daily use. Dozens of tables on measures, weights, mortar, brick, concrete, cement, rafters, stairs, nails, steel

beams, tile, many others. Use of steel square, square root tables, solids, windows, frames. Every building component and part.

SATISFACTION GUARANTEED OR MONEY REFUNDED

ORDER TODAY **\$4.00** Postpaid, or COD, you pay charges.

CLINE-SIGMON, Publishers

Department 171

P. O. Box 367 Hickory, N. C. 28601

USO Anniversary

AFL-CIO Pres. George Meany saluted the United Service Organization in a letter to Gen. Emmett O'Donnell, USO president, noting that the organization will reach its 30th anniversary on February 4.

Meany observed that as long as the nation is threatened by totalitarian powers, it will need soldiers, sailors and airmen, and "as long as we have our military we shall need also the USO."

INDEX OF ADVERTISERS

Audel, Theodore	39
Belsaw Power Tools	39
Belsaw Sharp-All Co.	27
Chicago Technical College	29
Cline-Sigmon, Publishers	39
Estwing Manufacturing	26
Foley Manufacturing	35
Garlinghouse	31
Hydrolevel	36
Irwin Auger Bit Co.	31
Kedman Company	32
Locksmithing Institute	27
Paneling Specialties Co.	36
Proctor Products Co.	26
Stanley Works	Back Cover

new AUDEL CARPENTERS & BUILDERS GUIDES

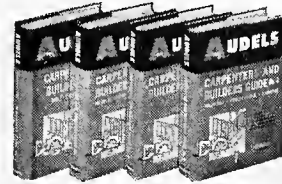

4 VOLS.
1616 Pages
Heavily Illustrated
ONLY \$16.95

INSIDE TRADE INFORMATION—for Carpenters, Builders, Joiners, Building Mechanics and all Woodworkers. Here are the short-cuts you want—new methods, ideas, solutions, plans, systems and money-saving suggestions. A complete course for the apprentice—a practical daily help and Quick Reference for the master worker. Mail COUPON TODAY to get these helpful guides used by thousands of carpenters. Shows you—

HOW TO USE: Mitre Box, Chalk Line, Rules & Scales, Steel Square & Settings 12, 13 & 17. **HOW TO BUILD:** Furniture, Cabinetwork, Houses, Barns, Garages, Skylights, Stairs, Hoists, Scaffolds. **HOW TO:** File & Set Saws, Do Carpenters Arithmetic, Solve Measurement Problems, Estimate Strength of Timbers, Set Girders & Sills, Frame Houses & Roofs, Estimate Costs, Read & Draw Plans, Draw Up Specifications, Excavate, Lath, Lay Floors, Hang Doors, Put On Interior Trim, Insulate, Paint.

MONEY BACK GUARANTEE

You must be COMPLETELY satisfied with the Audel Guides you order, or you may return them within 10 days and get your money back.



ORDER NOW!

MAIL COUPON TODAY

THEO. AUDEL & CO., 4300 W. 62nd St. C-011
Indianapolis, Ind. 46268

Please mail me Carpenters & Builders Guides, 4 Vols. Enclosed is down payment of \$6.00. I agree to pay balance, including shipping costs, within 30 days. If I am not completely satisfied with my Audel Guides I may return them for refund.

Name _____
Address _____
City _____ State _____ Zip _____

SAVE SHIPPING COSTS. Enclose \$16.95 (plus sales tax, if any) and we pay postage.

Planer · Molder · Saw!

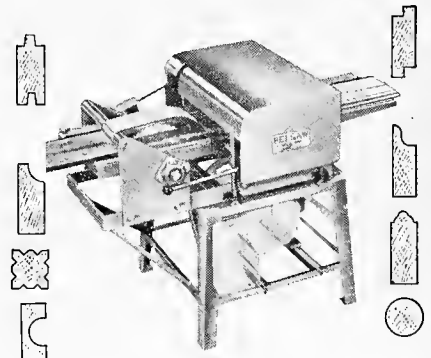

Now you can use this ONE power feed shop to turn rough lumber into high-value moldings, trim, flooring, furniture... ALL popular patterns.

RIP... PLANE... MOLD... separately or all at once by power feed... with a one horsepower motor. Use 3 to 5 HP for high speed commercial output.

LOW COST... You can own this MONEY MAKING POWER TOOL for only... \$30.00 down.

Send coupon today... No salesman will call

BELSAW POWER TOOLS

941J Field Bldg., Kansas City, Mo. 64111

Send me complete facts on the MULTI-DUTY Power Tool. No obligation.

Name _____
Address _____
City _____ State _____ Zip _____



In Conclusion

M. A. Hutcheson, *General President*



Senior Citizens Need 'Political Muscle' Too

■ A new phenomenon of the 1960s was the rapid proliferation of highly organized and very vocal minority groups. The Blacks, the Indians, the Spanish-Americans, all developed vehicles for making their collective voices heard on matters they deemed to be discriminatory. Even the women have gotten into the act through Women's Lib.

The one sizable American group which has so far failed to adequately champion its cause through organization is the older Americans, even though there is scarcely a group which has been more neglected, and, therefore, in greater need of political muscle.

In the past 10 years, the percentage of older people classified as poor grew by nearly a third.

Statistics show that 47 percent of older people living alone or living with non-relatives fall within the poverty classification established by the Bureau of Labor Statistics.

Statistics also reveal that whereas the Social Security benefits for a retired couple in 1950 met one-half the cost of a bare bones budget, today, they meet only one-third of the cost.

Unfortunately, the vast bulk of older citizens are in no position to help themselves. They are too feeble, or crippled, or blind, to hold down a job. Those who are able to work cannot find jobs because employers want younger people. Therefore, their welfare is closely tied to the political winds which prevail in Washington, D. C. and City Hall.

The more inflation is allowed to run rampant, the worse the plight of older citizens trying to exist on fixed incomes becomes.

The more penurious Congress becomes in appropriating funds for bettering Social Security benefits, improving Medicare, etc., the lower the living standards of older citizens sink.

While there has been a vast increase in the number of pension plans negotiated by unions, statistics reveal that large numbers of retirees fail to get a pension because of restrictive vesting rules. It is estimated that somewhere between a third and one-half of those now in private pension programs can wind up without a pension because vesting regulations will deal them out. This is particularly the case in pension plans unilaterally established by employers.

A number of proposals for regulating private pension plans are now before the Congress. At least one would set up mandatory vesting after five years. A second proposal would make vesting automatic whenever a man's age plus his years of service add up to 45. For example, if a 42-year-old worker achieved three years of service in a company, he would automatically be vested after three years. Another version would provide for 50% vesting after five years, with an added 10% for each subsequent year, bringing it up to 100% in 10 years.

Still other proposals would set up an insurance program to guarantee the solvency of all pension plans in the same way bank deposits are guaranteed now.

Far too many unorganized workers have been cheated out of their pensions because the company they worked for played fast and loose with pension funds without violating any law.

The encouraging factor in the whole picture is that older citizens are building up some political clout. They are doing so through organizing clubs in their local unions; by working with organizations such as the National Council of Senior Citizens; and by giving time and effort to help elect candidates who care to Congress and state legislatures.

I am sure this presages the dawn of a better day for our older citizens. ■



Eliminate
the
negative...

give to the
March
of Dimes

What makes the Stanley Workmaster™ your kind of level?

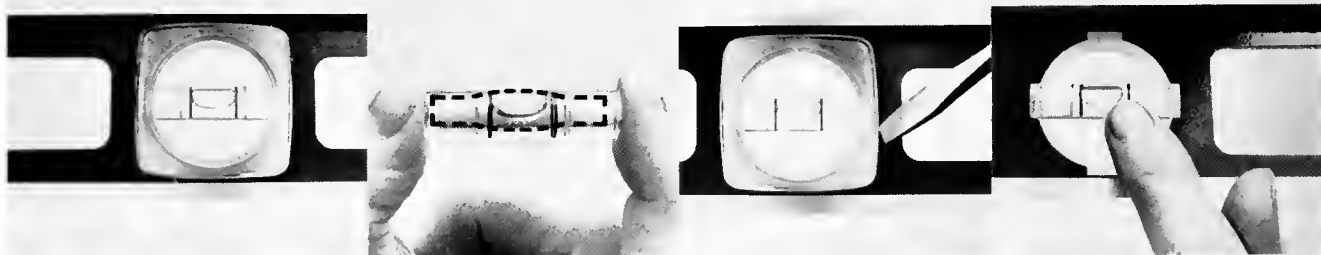

Here's the most advanced level ever developed. A complete concept, with new "360 vials". King size, the tough acrylic vials are 20% larger for maximum visibility and accuracy.

One vial works better than two bent glass vials. Fact: Stanley engineering has put one barrel shaped vial inside another vial, providing 360° surface readings from any angle.

Simply put a screwdriver under cover plate and twist. Cover plate snaps out. Now just take out the broken vial. It's that simple.

Snap the new vial into place, snap on cover plate and you've replaced the vial in seconds.

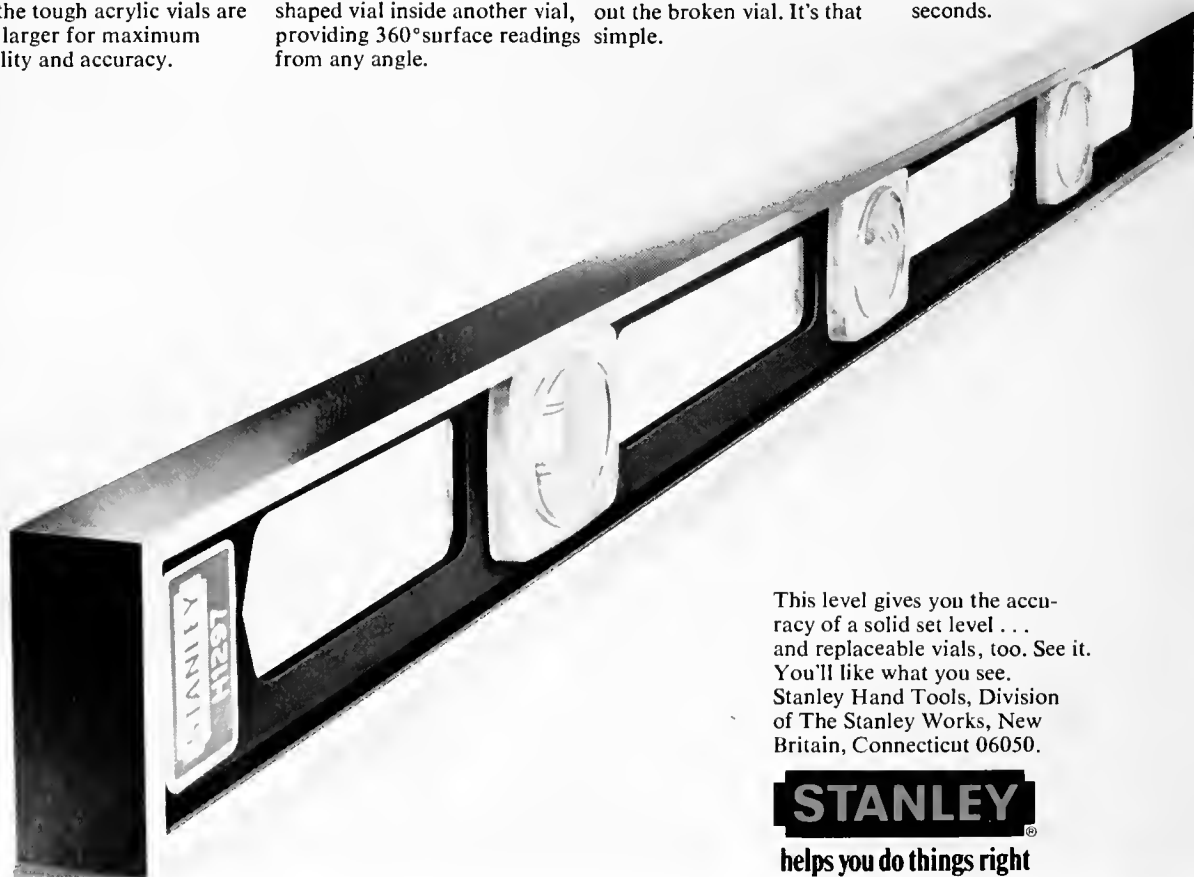

This level gives you the accuracy of a solid set level . . . and replaceable vials, too. See it. You'll like what you see. Stanley Hand Tools, Division of The Stanley Works, New Britain, Connecticut 06050.

STANLEY®

helps you do things right

FEBRUARY 1971

The
CARPENTER

Official Publication of the UNITED BROTHERHOOD OF CARPENTERS AND JOINERS OF AMERICA • FOUNDED 1861

Property is the fruit of labor. Property is desirable, is a positive good in the world. Let not him who is houseless pull down the house of another, but let him work diligently and build one for himself, thus by example assuring that his own shall be safe from violence when built. *Abraham Lincoln*

First Annual Message to Congress, Dec. 3, 1861



OFFICIAL INFORMATION

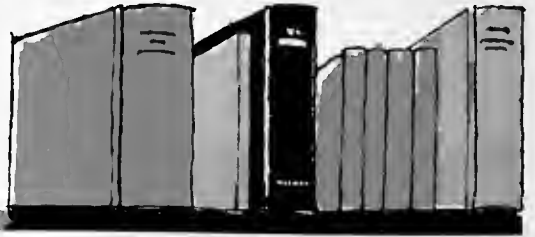

GENERAL OFFICERS OF THE UNITED BROTHERHOOD of CARPENTERS & JOINERS of AMERICA

GENERAL OFFICE:
101 Constitution Ave., N.W.,
Washington, D. C. 20001

GENERAL PRESIDENT

M. A. HUTCHESON
101 Constitution Ave., N.W.,
Washington, D. C. 20001

FIRST GENERAL VICE PRESIDENT

WILLIAM SIDELL
101 Constitution Ave., N.W.,
Washington, D. C. 20001

SECOND GENERAL VICE PRESIDENT

HERBERT C. SKINNER
101 Constitution Ave., N.W.,
Washington, D. C. 20001

GENERAL SECRETARY

R. E. LIVINGSTON
101 Constitution Ave., N.W.,
Washington, D. C. 20001

GENERAL TREASURER

PETER TERZICK
101 Constitution Ave., N.W.,
Washington, D. C. 20001

DISTRICT BOARD MEMBERS

First District, PATRICK J. CAMPBELL
130 North Main Street
New City, Rockland Co., New York
10956

Second District, RALEIGH RAJOPPI
2 Prospect Place, Springfield, New Jersey
07081

Third District, CECIL SHUEY
Route 3, Monticello, Indiana 47960

Fourth District, HAROLD E. LEWIS
340 Northwest 148th St.
Miami, Florida 33168

Fifth District, LEON W. GREENE
18 Norbert Place, St. Paul, Minn. 55116

Sixth District, FREDERICK N. BULL
P.O. Box 14279
Oklahoma City, Okla. 73114

Seventh District, LYLE J. HILLER
Room 722, Oregon Nat'l Bldg.
610 S.W. Alder Street
Portland, Oregon 97205

Eighth District, CHARLES E. NICHOLS
Forum Building, 9th and K Streets
Sacramento, California 95814

Ninth District, WILLIAM STEFANOVITCH
2418 Central Avenue
Windsor, Ontario, Canada

Tenth District, GEORGE BENGOUGH
2528 E. 8th Ave., Vancouver 12, B. C.

M. A. HUTCHESON, *Chairman*

R. E. LIVINGSTON, *Secretary*

Correspondence for the General Executive Board
should be sent to the General Secretary.



Secretaries, Please Note

If your local union wishes to list deceased members in the "In Memoriam" page of *The Carpenter*, it is necessary that a specific request be directed to the editor.

In processing complaints, the only names which the financial secretary needs to send in are the names of members who are NOT receiving the magazine.

In sending in the names of members who are not getting the magazine, the new address forms mailed out with each monthly bill should be used. Please see that the Zip Code of the member is included. When a member clears out of one Local Union into another, his name is automatically dropped from the mail list of the Local Union he cleared out of. Therefore, the secretary of the Union into which he cleared should forward his name to the General Secretary for inclusion on the mail list. Do not forget the Zip Code number. Members who die or are suspended are automatically dropped from the mailing list of *The Carpenter*.

PLEASE KEEP THE CARPENTER ADVISED OF YOUR CHANGE OF ADDRESS

PLEASE NOTE: Filling out this coupon and mailing it to the CARPENTER only corrects your mailing address for the magazine. It does not advise your own local union of your address change. You must notify your local union by some other method.

This coupon should be mailed to **THE CARPENTER**,
101 Constitution Ave., N.W., Washington, D. C. 20001

NAME _____ Local No. _____

Number of your Local Union must be given. Otherwise, no action can be taken on your change of address.

NEW ADDRESS _____

City

State

ZIP Code

THE CARPENTER

VOLUME XCI

No. 2

FEBRUARY, 1971

UNITED BROTHERHOOD OF CARPENTERS AND JOINERS OF AMERICA

Peter Terzick, Editor



IN THIS ISSUE

NEWS AND FEATURES

The Long Road to Adequate Housing	2
The Growing Threat of Pollution	6
Returning Convicts	AFL-CIO 9
Enough Power for the Years Ahead?	Issues of the 70s 12
We've Won Another Fleetwood Election	14
The New Job Safety Bill	16
Canada Faces The Pollution Threat	CLC 20
The Bills for Lincoln's Funeral	29

DEPARTMENTS

Washington Roundup	8
Editorials	11
Canadian Report	Morden Lazarus 18
Local Union News	21
Plane Gossip	25
Service to the Brotherhood	30
Outdoor Meanderings	Fred Goetz 34
In Memoriam	36
What's New?	38
Lakeland News	39
In Conclusion	M. A. Hutcheson 40

POSTMASTERS, ATTENTION: Change of address cards on Form 3579 should be sent to THE CARPENTER, Carpenters' Building, 101 Constitution Ave., N.W., Washington, D. C. 20001

Published monthly at 810 Rhode Island Ave., N.E., Washington, D. C. 20018, by the United Brotherhood of Carpenters and Joiners of America. Second class postage paid at Washington, D. C. Subscription price: United States and Canada \$2 per year, single copies 20¢ in advance.



Printed in U. S. A

THE COVER

Washington, D.C., is a city of many shrines . . . but no shrine has deeper meaning for Americans than the Lincoln Memorial and the massive statue of the 16th President, which it encloses. The great, seated figure of the Emancipator seems to breathe a silent prayer . . . a prayer of unity for a divided people.

The heroic statue, created by Daniel Chester French, looks out across a long reflecting pool, past the Washington Monument, to the dome of the Capitol itself. It is as if the brooding Lincoln is observing the actions of the legislators beneath the Capitol dome and reminding them of their obligation to perpetuate a government of the people, by the people, and for the people.

The quotation which appears on our February cover is pertinent today . . . as are many of the statements of Abraham Lincoln. In this period of dissension and uncertainty, we find solace in the firm and compassionate understanding of this truly great man.

The Lincoln Memorial is built on bedrock of White Colorado-Yule marble. The seated figure at its center is 19 feet from head to feet. The classic armchair is 12½ feet tall. Over the back of the chair a flag is draped in marble. The statue was fashioned out of 28 blocks of Georgia white marble.

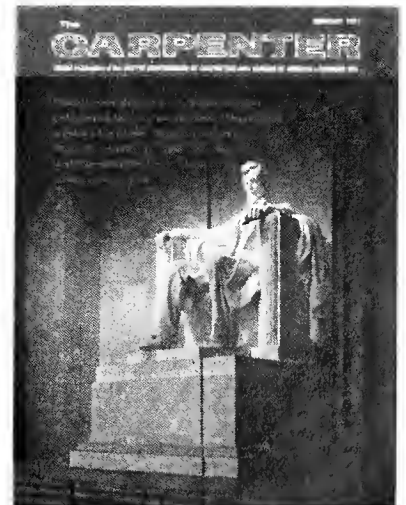



The Long Road To Adequate Housing

- Three years ago the Housing Act of 1968 set a goal of 26 million new homes by the end of the decade. Since that time, man has walked on the moon, science has created simple life forms synthetically, but the program to build 26 million

homes is at least 2 million homes behind schedule.

Nor are there any solid indications that much of the slack will be picked up in the near future. The home building industry is limping along with the throttle at half speed.

What ails the housing industry? The list of answers to this question could fill several pages. Tight money, unrealistic land prices, obsolete building codes, are but a few. However, the most serious roadblock to achieving the goals set up by the Housing Act of 1968 is not a matter over which the construction industry has any real control; rather it is a matter rooted in the economic climate of our day. It is called inflation.

The construction industry has the capacity and the will to meet the 1968 objectives, even though it may be starting from far behind the goal line as of 1971.

Suddenly, Next Summer?

Management has the know-how. Labor has the necessary skills. By next summer, given the green light, the industry could be turning out homes at a rate no one dreamed possible a generation ago.

Why then are not the necessary homes being built? Primarily, the answer is because too many people have been priced out of the housing market, not only by the cost of the house but also by the cost of maintaining it.

The cost of land has doubled in the past decade. Interest rates have nearly tripled in the same period. These two factors alone have driven up the price of housing tremendously. Taxes and utilities have skyrocketed too.

A 1% increase in interest rates increases the cost of the \$20,000 house by nearly \$5,000 on a 30-year mortgage. With lots carrying \$4,000 and \$5,000 price tags, it becomes impossible to place a low-cost house thereon.

Let's translate some of this into a hypothetical case. A worker who buys a house by assuming a \$20,000 mortgage through a conventional loan carrying 8% interest must pay a monthly debt service of approximately \$170 on a 20-year mortgage. This is beyond the reach of most working people.

The rule of thumb followed by practically all housing economists is that 25% of income is about the tops a family can afford to spend for housing. Applying this to the case of a worker earning \$6,000 per year, you come up with a figure of \$1,500 or \$125 per month as the maximum the family can spend on shelter.

The Mortgage Money!

However, this \$125 a month must include the operating expenses; namely, taxes, light, heat and repairs. When these items are deducted from the \$125 per month, it is obvious that considerably less than that amount is available for paying off a mortgage.

Obviously, the higher real estate taxes go, the more difficult it becomes for a worker to finance the purchase of a home. The same thing is true of increased utility costs. Therefore, the persistent rise in taxes and rates for heat and electricity militate against more widespread home ownership.

Mr. William G. Rosenberg, executive director of the Michigan State Housing Development Authority, touched on this phase in a recent speech before the National Symposium on Industrial Approaches to Urban Problems.

In part, he said:

"It is my opinion that under existing federal, state and conventional financing programs, increased operating expenses, primarily real estate taxes and utility charges for heat and electricity, are imposing extreme economic restraints to the ability of this nation to deliver housing that a majority of citizens can afford.

"To demonstrate that proposition, consider the relative impact of changes in development costs and operating expenses on the family housing budget under a federally subsidized program serving the \$5,000 to \$10,000 family. Assume a \$20,000 townhouse unit with development costs of \$1,000 land, \$2,000 land improvements, \$14,000 structures (50% labor and 50% materials), and \$3,000 development fees:

1. A 10% change in labor costs will change monthly debt service \$1.60;
2. A 10% change in materials costs will change monthly debt service \$1.60;
3. A 10% change in raw land costs will change monthly debt service \$.23.

On the other hand:

- (a) A 10% change in real estate taxes will change monthly operating expense \$3.10.
- (b) A 10% change in utility charges for heat and electricity will change monthly operating expense \$2.00.

"Thus, a change in real estate taxes has 2 times more impact than the same percentage change in labor costs. 2 times more impact than the same percentage change in materials costs, and 14 times more impact than the same percentage change in raw land costs.

Impact of Power Bills

"Similarly, a change in utility charges for heat and electricity has $\frac{1}{3}$ more impact than the same percentage change in labor costs, $\frac{1}{3}$ more impact than the same percentage change in material costs, and 2 times more impact than the same percentage change in raw land costs."

From these observations, it is clear that factors outside the control of the construction industry bear heavily on the cost of home ownership.

Still another factor adding to the cost of home acquisition is the sales commission. This generally is set at 6% of the selling price—no small item. There is no competition. All brokers charge the same fee. A more competitive setup might shave a respectable sum from the cost of buying a home.

According to the Nixon Administration, 1971 is supposed to be the turn-around year for housing. Only time will tell whether this forecast is whistling in the dark or based on solid facts.

Eliminate Road Blocks

Whatever housing does in 1971, the goals established by the 1968 Act will not be achieved unless some of the roadblocks spelled out above are eliminated.

As the figures show, rapidly increasing real estate taxes do as much as any other one thing to put housing beyond the reach of lower and middle-income wage earners, the very category in which the housing needs are the greatest.

Unfortunately, local governments depend almost entirely on real estate taxes for their income. This is the source of revenue they use for maintaining schools, police and fire departments, sewage plants, and streets. A growing population is making ever-growing demands upon cities and counties for these services.

The city or county in which the tax bite has not increased every year for the past 10 years is a rarity. If the tax rate is not increased, the assessed valuation is stepped up, so that the home owner faces a bigger burden each year.

Now the breaking point has been reached insofar as real estate taxes on dwellings are concerned. No city or county can dispense with the essential services. The money to provide them must be raised, but some form of taxation other than levies on real estate must be devised if the great demand for decent

housing in the low and middle income brackets is to be met.

As pointed out above, the escalating cost of utilities is also tending to freeze lower paid workers out of the home market. Since most utilities are governed by public or quasi-public agencies, the government must recognize the relationship existing between high utility costs and the ability of people to buy homes.

Interest rates, too, are a major factor in shrinking the home market. Over the past two years interest rates have reached highs unheard of since Civil War days. In recent months there has been some slight downward move in interest rates. However, they have a long way to go before home ownership can become more widespread among ordinary citizens.

Attention Needed

For the extremely poor there have been various programs for subsidizing interest rates, but there has been no real effort made to give preferential treatment to the mortgage market, despite presidential authority to do so. This is an area that must have far greater attention.

Population pressures naturally have caused rapid escalation of the price of land. This trend is likely to continue for a long time to come, unless some remedial measures are taken.

Somewhat or other, the speculative aspects of land ownership must be diminished. Great fortunes are made out of land speculation by people who do nothing other than hold the land for a period of time, often only a year or two. This is made possible by the fact that the real estate tax structure is fixed mainly on the value of the improvements rather than on the value of the land. This makes it possible for speculators to hold on to idle land because the tax burdens are light.

On the other hand, if the major

tax emphasis was on the land rather than the improvements, it would tend to make speculation in land less profitable. In the long run, this could stimulate home ownership by stabilizing land costs.

Reforms Necessary

From all the foregoing, it seems logical to assume that the housing goals of 1968 will not be achieved until there are some dramatic reforms in the various areas outlined above.

The last session of Congress made some hesitant moves in the right direction. The amendments passed by the 91st Congress made it easier for non-profit organizations to underwrite the construction of housing for migratory farm labor and other low-income groups.

New communities are also given assistance, but the main roadblocks to the construction of adequate housing that working people can afford still need to be swept away by a coordinated attack by Federal, state and local governments working together with the advice and guidance of the construction industry. ■

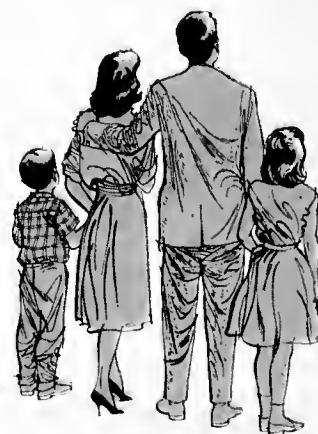

The problem facing America: how to deliver housing that a majority of its citizens can afford.

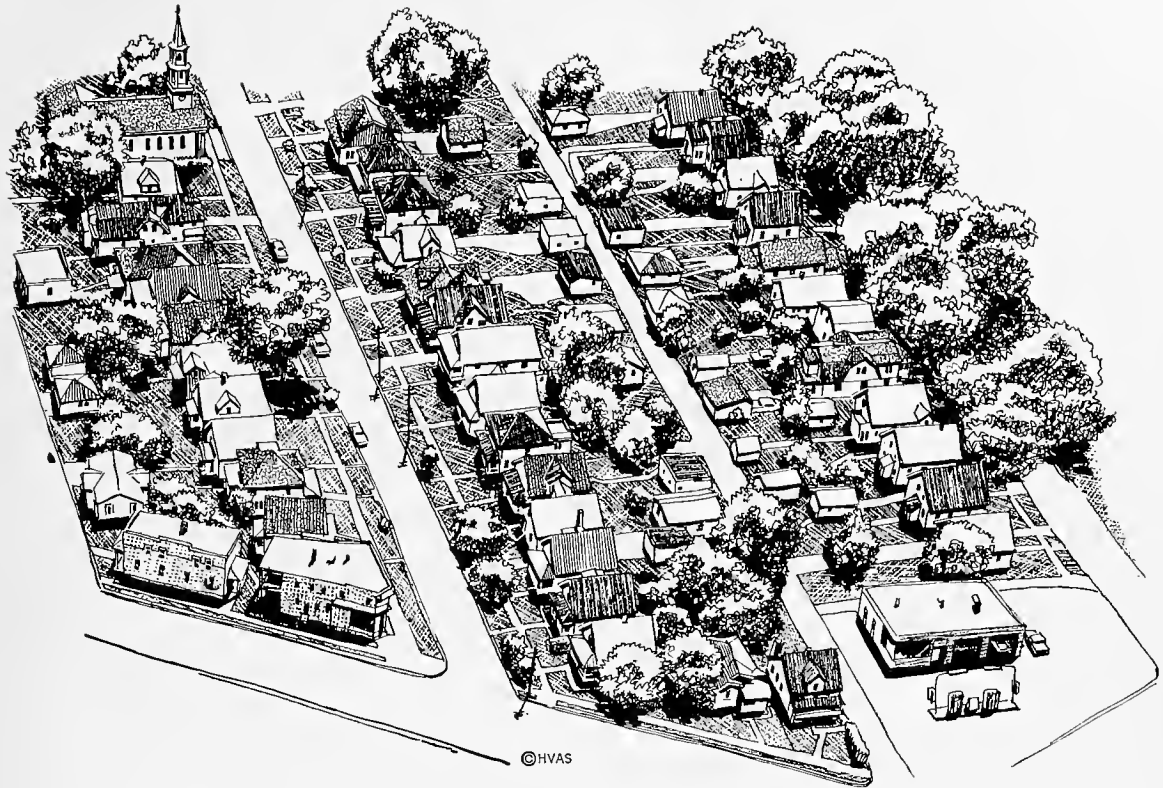

©HVAS

The Question of Housing Subsidies

■ A program of housing subsidies for middle to lower-income families was proposed to the Congress last year by Senator William Proxmire of Wisconsin. Eligible families would have been guaranteed a 7% mortgage as long as they devote 20% of their income to housing costs.

To qualify, a family's income would have had to fall below the median for the locality. Though this figure varies from state to state, officials of the Department of Housing and Urban Development calculated that the eligibility limits would have ranged roughly from \$7,000 to \$12,000.

The government would have subsidized all interest payments exceeding 7%. At the time the proposal was introduced, the rate on government-backed mortgages was 8.5%. As many as 250,000 families could have benefited from \$105 million which would have been authorized for the program.

Congress passed Senator Proxmire's bill, and HUD seemed to go along with it. But the Nixon Administration never asked for appropriations to finance the subsidies. At a press conference, last month, HUD Secretary George Romney indicated that the appropriation request probably would never come.

Romney claimed that the subsidy plan duplicates a program recently inaugurated by the Federal Home Loan Bank Board, under which the Bank Board pays \$20 monthly subsidy for five years to eligible families who fall roughly into the same income brackets.

Aides to Senator Proxmire rejected that argument claiming that the two subsidy plans—drafted nearly simultaneously—were expected to complement each other. In effect, they charged, HUD was backing away from an earlier commitment to their plan.

“When this proposal was con-

sidered by the Senate, I received assurance from (HUD) that funds to implement the program would be requested as soon as possible,” Proxmire wrote President Nixon.

At the press conference, Romney never said flatly that no appropriation would be requested, but later other HUD officials also talked negatively about the program.

In the six months since passage of the legislation, mortgage rates have declined and credit for home construction has increased, one official said. He doubted that more subsidies would result in any additional increase in home building this year—projected at 1.7 million starts against 1.4 million in 1970.

The contract rate on mortgages insured by the Federal Housing Administration (or guaranteed by the Veterans Administration) is now 7½ per cent against 8.5 per cent last summer. ■

THE FORMERLY GOOD EARTH,
copyright 1970
by Herblock
in The Washington Post

THE GROWING THREAT OF POLLUTION



Will we reach the point of no return?

■ "The human race may be in even more trouble than we think," the ecologist said bluntly. "Very possibly, man won't know he has passed the point of no return until it's too late."

Gordon Young agreed. He already had seen some of the menace of that grim warning. As a National Geographic staff writer, he had spent six months traveling the world taking murky measure of how man is befouling his nest.

"Unless we stop abusing our vital life-support systems, they will fail," Mr. Young writes in the December magazine. "We must maintain them, or pay the penalty. The penalty is death."

His story, "Pollution. Threat to Man's Only Home" leads off a three-part look at "Our Ecological Crisis."

"One of our basic errors," said ecologist Lamont Cole, "is that we always equate growth with goodness." Dr. Cole, of Cornell University, was making the same point repeated by almost every ecologist Mr. Young interviewed.

"We have to stop growth some-

where," Dr. Cole added. "And, if we don't stop the population explosion, there's very little chance of solving our other problems. It's the key to the whole thing."

Everywhere Mr. Young found evidence of the discards from the world's ever-growing population.

He writes: "Last year Americans threw away 50 billion empty cans, 30 billion glass containers, 4 million tons of plastics, and more than a million television sets."

Americans, he learned, produce a daily average of six pounds of waste per person, gorging landfill dumps and fueling incinerators that belch more smoke.

Nine million cars are disposed of each year. Many are abandoned—including 150 on the streets of New York City every day.

Man dumps from three to ten

Ounces of Prevention

Some things you can do to fight pollution include . . .

- Support local, state, and Federal legislative action to correct pollution abuses.

- Recognize the need for adequate water, sewage, and waste disposal facilities in your community and support public moves or bond issues to bring them about.

- Practice good anti-pollution habits as an individual. Stop littering. Eliminate smoke hazards. Use returnable and reusable containers when possible. Measure detergents carefully.

- Bug gasoline manufacturers to get the lead out.

- Preach the doctrine of conservation of our resources and our lives.

million tons of oil into the world's oceans every year.

In Tokyo Mr. Young found traffic policemen refreshing themselves from oxygen tanks. In the industrial Ruhr of Germany he saw how the corrosive air from heavy industry etched and turned brown a test square of shiny steel in only two months. In Milan, Washington, and Paris he saw statues eaten away by airborne acid.

Much of the pollution can be outlawed, but not without cost. Mr. Young pointed out the dilemma facing lawmakers across the country:

"If a plant has polluted the air for fifty years, and is operating on a close budget—can we, in good conscience, make demands that will drive it into bankruptcy? On the other hand, can we afford to risk our health by continuing to breathe the smoke?"

Mr. Young's article catalogs some of the changes man brings to his world in the name of improvements, which often backfire into pollution problems.

These double-edged dramas are portrayed on the back of the new 47½-by-29½-inch world map accompanying the December National Geographic.

Down on the farm, cattle have been turned out of fields traditionally revitalized by natural fertilization and have been penned into feeder lots where manure becomes a major disposal and pollution problem. Meanwhile, fields suffer from lack of organic fertilizer.

Some insecticides have prevented epidemics and assured greater health and bigger crop yields. At the same time, they may not only wipe out certain endangered species of animals, but, by invading the food chain, threaten man as well.

Mercury, valuable in saving stored grain from spoiling fungus, menaces man through his food. Lead, a long-used additive in gasoline, is another toxic appearing increasingly in human bones.

Nuclear power plants may be efficient generators on the one hand

and, on the other, produce thermal pollution—making water hotter than marine life can tolerate in rivers needed to cool the reactors.

Strip mining for coal produces needed fuel efficiently, but leaves behind canyons of desolation highly vulnerable to erosion, and where little will grow for many years.

Phosphates, one of the main ingredients that do the job in chemical fertilizers and in laundry and dish-washing detergents, also are major dangers to the life of lakes.

Phosphates, carried to lakes in sewage, overstimulate plant growth, especially algae, which then die, sink to the lake bottom and decompose. The process robs the water of oxygen.

Much of the water in Lake Erie already is without the oxygen needed to sustain fish and other marine life.

The burning of fuel by jet aircraft leaves vast quantities of water vapor in the air, increasing the cloud cover and further cutting the amount of the sun's energy that reaches Earth. Supersonic transports may increase the blanketing effect in the stratosphere where drifting clouds dissipate more slowly.

Pollution fighters have won victories that ecologists say must only be the beginning of what they emphasize is man's fight for survival.

Los Angeles, "Smog City, U.S.A.," is at least holding its own, thanks to the Nation's toughest regulations against air pollution.

A community-wide effort produced a new sewage disposal operation that has saved Seattle's Lake Washington from the kind of death that threatens Lake Erie.

Garbage and rubbish is incinerated without giving off smoke particles while generating light and heat for a community of 40,000 in West Germany.

More factory wastes are being recycled or reused. Old newspapers reprocessed into new front pages sometimes whimsically inform readers of the antipollution effort with the headline: "You've read this paper before." ■

Industry's Smokescreen

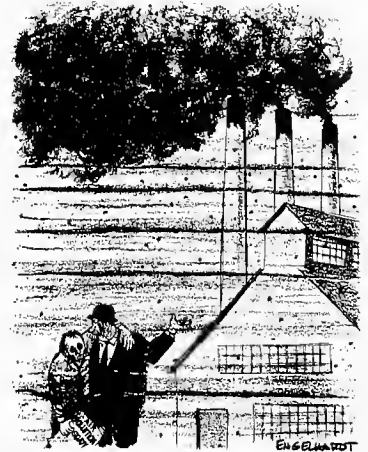

"But the economy might suffer!"

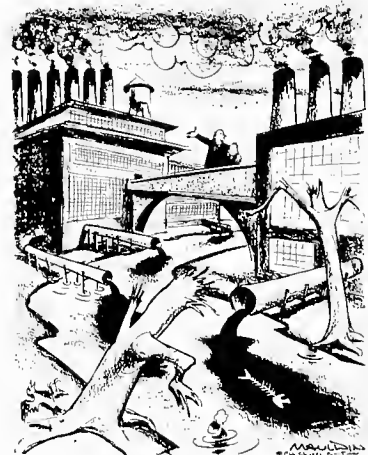

"Some day, my boy, this will be yours!"

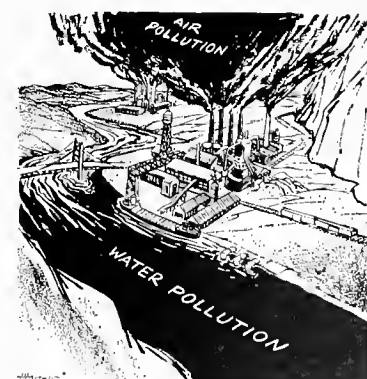

"Man's inhumanity to man."

Cartoons from NO LAUGHING MATTER, published by U.S. Dept. of Health Education and Welfare.

WASHINGTON



ROUNDUP

PUSH MONEY—An organization for consumers, Consumers Union, has petitioned the Federal Trade Commission to ban the practice of "push money," whereby a store sales person promotes a certain brand to a customer without admitting that he has been paid by the manufacturer or wholesaler to push that particular product. FTC banned the practice in 1921 but was overruled by the courts. CU is hoping that by now the courts are more aware of the need for consumer protection.

JET POLLUTION—Airlines have been asked by the national Air Pollution Control Administration to stop dumping into the air after takeoff the jet fuel that seeps from engines into holding tanks during stops. APCA estimates that 110 tons of such fuel are dumped over Washington's National Airport each year, alone. Fuel losses from such dumping are estimated to total over 6,700 tons (2 million gallons) per year, nationwide.

CAPITOL WEST FRONT—The west front of the Capitol in Washington has been the subject of an architectural and engineering controversy. Will it tumble down, or not? The late Architect of the Capitol, George Stewart, insisted it would. However a report to the Congress, still unreleased, says that it won't. The report, prepared by a New York engineering firm, says restoring the damaged front is more feasible economically than Stewart's plan for extending the edifice by 88 feet.

CHILD LABOR—After 30 years of law, there were still 13,000 cases of child labor violations reported by the U.S. Labor Department last year and, so far as the AFL-CIO is concerned, that was only the tip of the iceberg. A figure of 75,000 is more likely and that is probably too low.

Rudolph Oswald of the AFL-CIO Research Department, who has studied the problem for many years, contends that only about three percent of firms covered by the child labor laws are actually investigated and that the only way to enforce the law is to get more wage hours inspectors.

SUPREME COURT STRENGTHENS WOMEN'S RIGHTS—This is a time in which women are making strong efforts for equal rights in our society. The United States Supreme Court gave the movement a boost recently when it declined to intervene in a lower court decision. The lower court had held that equal pay for women may be based on jobs which are "substantially similar" rather than "identical" in nature. The decision broadens the scope of the Equal Pay Act of 1963 which provides that men and women performing work under similar conditions must receive the same pay for jobs requiring equal skill, effort and responsibility.

HOME "IMPROVEMENT" VULTURES FLY AGAIN—Warning flags are flying for the benefit of homeowners who may be needing some improvements. In the spring and summer months many phony home improvement outfits ply their dubious trade with unwary householders, usually the wives, as victims. They come by and tell a story about "just finishing a roof job down the street" and offering to do a roof repair cheaply or to repair a driveway. In too many of the cases the repair work is shoddy whether it's roof or driveway and Better Business Bureaus throughout the country are warning homeowners to beware of itinerants in this game. To make sure, get a union job.

CLEANING UP "SOAP"—Phosphates in laundry detergents cause much pollution, move through sewage treatment plants practically unaffected and contribute to the growth of slimy green algae in lakes and rivers at the end of the line. According to a federal study, "Salvo" has the most phosphates-per-pound of all laundry detergents tested. Also very high were "Biz" and "Axion." Lowest was "Wisk." Another study said "Trend" is lowest. Housewives can personally fight water pollution by selecting a low-phosphate washer detergent and not using excessive amounts (many housewives believe that if one cupful does a good job, two cupful will do a better job, which is not necessarily so, but which compounds water pollution).



RETURNING CONVICTS

■ Every year the barred gates of the grim, gray prisons of the nation swing open and more than 100,000 inmates of Federal and state prisons are returned to the society from which they had been isolated in punishment for the crimes of which they had been judged guilty.

Some way or another . . . legally or illegally . . . these men (and women) must now make a living. They must have roofs over their heads, food to eat, clothes to wear and some diversion. It is predictable that if they cannot live by legal means, they will live by illegal means. If society will not accept them, then their anti-social actions which led them into prison will continue. Live they must.

The U. S. Department of Labor believes that this small army of annual returnees should have more meaningful job training while they are serving their sentences. "Working on the rock pile" to "do time" serves no real social purpose.

About 95 per cent of all those released annually are young males. Almost two-thirds of them are under 35 years of age. Almost all of them are under-educated. They went to prison unskilled and most of them return to society without having acquired a skill which they can offer to the job market in return for an honest income.

Despite the ever-repeated maxim that our prisons seek to rehabilitate criminals, the jobs they do are basically make-work projects. They typically produce license plates, signs, soap, concrete blocks, mattresses and prison garments. These are not skills which would enhance their employment potential after release. This is particularly true of state prisons, from which 86 per cent of the nation's prisoners are released.

A Manpower Research bulletin of the Department of Labor entitled "Training Needs in Correctional Institutions" outlines the problems of

Every Year 100,000 Apply in the Labor Market; What Can We (And They) Do?



the former prison inmate in sharp statistical terms:

- More than half of the adult prisoners never progressed beyond elementary school and more than 80 per cent did not finish high school. Yet psychological studies show the intelligence of prisoners does not differ markedly from that of the general public.

- The majority of prisoners have worked in occupations that require the least skill and have the highest unemployment rates: less than five per cent were in the professional or technical class, while 35 per cent were general laborers and 27 per cent were unskilled workers in other fields.

The future is predictable for the releasee. A Virginia study covering a 12-year period showed a direct relationship between parolee earnings and parole violations. Forty per cent of the releasees who had monthly incomes of less than \$50 violated parole, as compared with 10 per cent of the releasees who earned more than \$275 a month following their release.

As the Manpower Research bulle-

tin points out, "Obviously, a releasee who is unable to support himself is subject to pressures which may lead to crime and a return to prison."

The Labor Department cites other studies which show that during the month following release from prison only about one of every four former prisoners was employed at least 80 per cent of the time; three out of 10 were totally unsuccessful in obtaining employment. After three months, only about four out of 10 had worked at least 80 per cent of the time and nearly two out of 10 had still been unable to find work of any kind.

In addition to the prejudices of employers against former prison inmates, there are other serious blocks to his finding employment.

The releasee may find himself restricted by state and federal government regulations from doing work for which he was formerly trained. These regulations may prevent him from getting a chauffeur's license, a government job or a job in a hotel or bar.

Bonding companies will refuse to provide bonds for ex-prisoners,

making it impossible for them to find jobs in financial institutions or insurance companies—both of which represent rapidly expanding employment areas.

They may have serious psychological or family problems and only a small percentage of the releasees know about or use the social services available to them.

They need special assistance in locating work, but available employment services are limited. In the entire federal prison system there are 12 employment placement offices.

But the major block to fruitful employment is that the ex-prisoner is unskilled or that his skills are outdated.

To solve this problem the Labor Department, through the Manpower Development and Training Act, has been working to develop programs tailored particularly for the prisoner.

Unions, management, city-government and educational leaders are working together on advisory committees in various communities. Two projects, one at Rikers Island in New York and one at Lorton, Virginia, have already trained a number of youths for release.

Special efforts are being made to make sure that any programs will, like all other MDTA projects, train prisoners for jobs that pay adequate wages, that will not subject them to exploitation in employment and that would not depress the wage level of an occupation by contributing to an oversupply of workers in that field.

Such programs offer meaningful vocation training for prisoners and could go a long way to helping solve the root problems of crime.

The long-run solution to crime is jobs, education and hope. ■





Editorials

* **Misguided Guideposts**

In the early 1960s, the government promulgated a so-called wage-price guidepost policy. Average increases in wages and fringe benefits were supposed to be limited, voluntarily, to the trend-figure of rising private output per manhour in the previous five years—a percentage that was soon nailed down to 3.2 percent and, with the passage of time, developed into a rigid 3.2 percent fixation.

On the other hand, the “voluntary guidepost” for prices was a vague theoretical truism, devoid of policy implications. The price level would remain stable if prices of rapidly rising productivity industries would decline, while prices of other industries would remain stable or increase, depending on their productivity increase in relation to the national average.

So the “voluntary guidepost” policy continued a precise percentage guideline for increases in workers’ wages and fringe benefits. But there was no effective guideline for prices. And there was no guideline at all for profits, dividends, executive compensation and other forms of income.

When the textbook theory of a “voluntary guidepost” policy was translated into action in the real world, it was hardly more than a sophisticated, largely one-sided pressure to hold down wage increases.

Wages and salaries are not merely a cost to employers and a factor in the price of goods and services. They are also income to workers and the major source of consumer buying power.

Emphasis on the cost side of this issue to the exclusion of the income side, represents a lack of objectivity, as well as social and political insensitivity. Any objective view must include consideration of both sides of this issue—wages are both income to workers and a cost to employers.

Wage determination is subject to employer resistance and to the time lags and advance notice that are part of the collective bargaining process, as well as to the influence of economic conditions. Price-setting, on the other hand, has no such built-in restraints, except for the influence of changes in economic conditions, and in several key industries, the major corporations so dominate their industries that they set prices with little, if any, effective price competition.

Moreover, the United States is a huge country of continental size, with tens of thousands of different

markets, industries and occupations. Each of them has a large number of specific and different conditions, a multitude of tangible factors and real problems that have to be met.

For these reasons, no one single “magic number” can be imposed as the precise limit for all increases in hourly compensation of all employees throughout the varying and different markets, industries and occupations. Moreover, an attempt to base such a single “magic number” on one economic factor alone—such as productivity—makes the idea even more unworkable.

Therefore, the AFL-CIO determined that the so-called wage and price guidepost policy—with its precise “magic number” for wages—was unworkable as well as largely one-sided and inequitable. And the AFL-CIO has maintained this view to the present time.

—From *A Trade Union View of Inflation* by AFL-CIO Research Director Nat Goldfinger in the Jan. 1970 *Federationist*.

* **Man and the Universe**

The solar system, of which Earth is an integral part, is in the Milky Way galaxy, consisting of about 100 billion suns (of which our sun is but one). The Milky Way galaxy is only one of millions of such galaxies . . . all traveling at high speed through space . . . and the galaxy nearest to ours is speeding along about 2.2 million light years away. A light year is the distance light will travel in one year, traveling at 186,000 miles a second. The next-door neighbors are a fair distance away.

One of the striking facets of the moon explorations was the look back, via television, at our earth. When one puts it up against the billions of other planets . . . virtually all of which are much larger than earth . . . it looks pretty small indeed.

And when one considers that this little clod of dirt is just about in the same position as one grain of sand on a whole seashore, it makes you wonder if we here are truly the only living creatures in the universe. On the law of averages, that would have to be a pretty long bet, indeed!

One good aspect of the whole concept: when you sit back and reflect on it, your personal problems just have to shrink in size when viewed in contrast to such celestial grandeur.



Enough Power For The Years Ahead?

... or is America
'a Samson shorn
of his locks?'

■ "The United States will continue to have power problems over the next four or five years."

Take the word of the chairman of the Federal Power Commission, John N. Nassikas, as quoted in a recent interview.

His statement prompts another question: After that, what?

The energy crisis facing the United States and Canada in the 1970's is shrouded in a polluted cloud of uncertainties.

It is compounded by another crisis: the shortage of fuels, especially fuel oil, coal and natural gas.

Adding an additional element to



the crisis is the current battle to protect the environment. We need energy to light our homes and power our homes and factories, but the creation of energy brings smoke, smog, waste products, and all the pollutants we are belatedly trying to subdue.

Although some progress has been made in dealing with the crisis, the likelihood of more electric power brownouts and even total blackouts in the early '70s is not being ruled out by top energy experts.

We have beefed up our power stations and facilities since the great Northeast blackout of 1965, but much more must be done.

Currently, 57% of all electric power in the United States is generated by coal; 27% by natural gas, 11% by residual fuel oil, and the balance—about 5%—by nuclear power.

Power from atomic energy held great promise a few years ago—

and still does—but efforts to set up nuclear power plants have met opposition from local citizens who fear radioactivity, etc. Compounding this is the fact that atomic energy production requires great quantities of water, which when discharged back into streams, lakes, or bays, increases water temperatures to such an extent that they create serious pollutants. Engineers are now devising methods of cooling water as it leaves a power station and before it is discharged into natural waterways.

COAL IN SHORT SUPPLY

Coal, the biggest source of energy at present, is in short supply because of inadequate rail facilities, continuing exports, restrictive environmental standards, and even lack of adequate safety precautions in many mines.

The Federal Power Commission in Washington has conducted a na-

**ISSUES
OFF
THE 70's**

ONE OF A SERIES

tional inventory of all electrical utilities which use coal, directing them to report when their supplies dip below a 30-day supply. As a result of this check up, suppliers added to their stockpile somewhat, although the FPC reports it would take one million tons of coal to actually wipe out a deficit in minimal 30-day supplies for the nation's coal-using utilities.

The transportation bottleneck, which developed in the fall of 1969, when thousands of railroad cars were unavailable to deliver coal, has also diminished. The gravity of this situation was intensified at the time by export coal which was standing idle in railroad cars at coastal ports, awaiting shipment.

RESIDUAL FUEL, TOO?

The Federal Power Commission chairman has expressed worry about the U.S. supply of residual fuel oil, too. This type of fuel accounts for most electrical power generation in the Northeast.

"Although power requirements will be met," he said, "the situation is by no means under control."

The problems of fuel oil supply is wrapped up in problems of oil import quotas and the acquisition of coal companies by oil companies in apparent violation of anti-trust laws.

NATURAL GAS SUPPLY

At one time natural gas was considered a useless byproduct of oil well drilling. Natural gas was burned off as it left the casing heads. It became a major source of power during the period of World War II and has grown in importance since. Today it fuels 27% of the nation's electrical power, and now government and industry spokesmen tell us it, too, is in short supply!

Reserves continue to decline, according to the FPC, and that agency is encouraging producers to develop new reserves.

The situation has not noticeably improved. This winter, although all residential and contract demands are expected to be met, no new demands for gas from such users as new industries and businesses can be accommodated.

Some critics have charged that the domestic natural gas shortage

Continued on Page 15

National Transmission Grid

AFL-CIO Had Answer to Blackouts, a Decade Ago

■ If the nation's lawmakers and others who set policy had been listening to organized labor since 1959 the power shortages of today might not exist.

Many top power authorities have pointed to the fact a nationwide power transmission system could have instantaneously provided large blocks of reserve power from other regions of the country.

At its 1959 convention, the AFL-CIO called for such a giant power grid, and every Federation convention since has repeated this call.

The 1963 AFL-CIO convention declared:

"America is now moving into the age of giant power technology which must be harnessed to benefit all consumers and the general public.

"The nation's future power supply will require joint ownership of the power supply and transmission facilities by private, cooperative and publicly owned utilities, including the Federal government, with federal leadership in planning the most economic and feasible regional and interregional power connections, and laying down the rules for their operation in the public interest.

"Existing utilities, privately, cooperatively and publicly owned would be allowed to pool their resources into regional power supply agencies and required to meet the requirements of all electric distributing systems without discrimination and at uniform low wholesale rates. Regional systems would be allowed to finance their operations through issuance of revenue bonds under federal legislation.

"A prerequisite for success for a giant power program would be provision in legislation that all major transmission lines be designed as common carriers, just as are railroads, steamship lines, airlines and bus lines."

Private power interests in New England have long resisted moves to establish such a national power grid.

Charles Robinson, power engineer for the National Rural Electric Cooperative Association, said such a system could have delivered surplus power to New York City to prevent initial automatic shutdown of generation stations there and elsewhere in the Northeast.

"Had the 2 million kilowatts of capacity in reserve at the Tennessee Valley Authority system or the 1.7 million kilowatts of reserve in the Bonville Power Administration system in the Pacific Northwest been instantaneously delivered to New York City, automatic shutdown of generation facilities there could have been avoided," Robinson declared.

He contradicted officials who are publicly stating that the Northeast blackout constitutes a blow to advocates of a national transmission system.

Robinson pointed out that, according to a spokesman of the Potomac Electric Power Co., which serves the Washington, D.C. area, that company had sent 300,000 kilowatts northward to help New York, and that more help was available from the Pepco system but could not reach New York because of limited transmission capacity.

In addition to this, Federal Power Commission studies have shown that a nationwide transmission system would be the key to achieve savings of \$11.7 billion for all electric consumers in the nation by the year 1980 alone.

A similar view was expressed by F. H. King, president of the American Public Power Association. He said that the Northeast power failure forcibly points up the need for more comprehensive long range planning and for full development of power resources, in that area by both private and public power systems.

"Up to now," he said, "development of a power grid in this region has been too much on a temporary, short range basis with insufficient

Continued on Page 39

We've won another election at a Fleetwood plant...

Ten Plants Organized But Still No Contract; Furniture Workers, Marine Engineers Join Effort

■ Fleetwood Enterprises "threw everything in the book" at our organizers and general representatives, last month, in Hillsboro, Texas.

But we still won the right to represent workers at the Festival Mobile Homes plant there!

It was a closely-fought contest, and the company used the tactic of implied strike threat to sway the vote in its direction. But the workers at Festival still cast the majority of their votes for the union.

To File Objections

We have been put on notice that the company will file objections to the election (held January 14), but indications are that we are growing in strength at this plant site, and that the Hillsboro plant will join nine other Fleetwood installations won over to the Brotherhood's program of better wages and working conditions.

Although the Hillsboro plant is the 10th Fleetwood facility in which we have been selected as bargaining agent by the employees, a contract has not been signed in a single plant.

This, in itself, indicates Fleetwood's antipathy toward unionism and the reasoning behind the Brotherhood's plan for a nationwide con-

sumer boycott of the company's products.

Boycott Planned

The Brotherhood plans to petition the AFL-CIO Executive Council, meeting this month in Florida, for permission to present the boycott proposal to the entire labor movement at the AFL-CIO Convention later this year. This would gain support of a nationwide consumer boycott by all trade unionists in North America—more than 15 million strong.

We are already advised that we will be supported in the boycott by two other unions which have won elections at Fleetwood plants and do not have contracts. These two unions are the Furniture Workers, who have won a representation election at Woodland, California, and the Marine Engineers, who won an election at the Bowling Green, Ohio, plant. Both unions are heartily in accord with the consumer boycott proposal—which labor has found successful in dealing with the grape growers of California and the General Electric Company.

Fleetwood distributes its products through 1,800 dealers. A complete listing of distributors will be circulated throughout the Brotherhood as

well as the labor movement in general, once a consumer boycott is initiated.

With 28 manufacturing plants in 13 states now in operations, and new facilities about to open, Fleetwood is a major manufacturer of mobile homes. It is listed on the New York Stock Exchange.

Last year it delivered approximately 27,000 mobile homes and recreational vehicles, a 32% increase over 1969.

Modular Housing

The firm contemplates moving into modular housing through the acquisition of Deluxe Homes, Inc.

Though the company reported an average annual increase in sales over the past ten years of 37% and an average annual increase in earnings over the same period of 50%, it continues to hold its workers to low wages and outmoded working conditions.

Meanwhile, contract negotiations continue in a foot-dragging manner with no settlements in sight.

The Brotherhood's Director of Organization Pete Ochocki urges all local unions and district councils to lend their support to the fight for contractual representation for all Fleetwood employees. ■

Enough Power?

Continued from Page 13

was industry-produced to drive up prices. Even the FPC chairman does not rule out that possibility. In any case, there would be more capital investment by the industry if it is to expand to domestic needs.

IN RETROSPECT

Water power, meanwhile, continues to generate electricity at Tennessee Valley Authority sites and at the mammoth dams of the Far West. Though conservationists condemn the building of dams along our major waterways, our power supplies today would be totally inadequate, if these huge dynamos were not turning.

A White House official said, last month, that the nation must rely more on coal and the atom for its energy, because oil is too costly and its supplies too scarce and insecure.

Director George Lincoln of the Office of Emergency Preparedness said 10% of the nation's energy is supplied by imported oil, particularly residual fuel oil used in East Coast power plants. He said these supplies are subject to being cut off by events abroad over which the United States has no control.

In addition, he said, worldwide demand for oil is beginning to out-strip supplies, is causing prices to rise. The White House is now studying recent price hikes made by American firms on crude oil.

Whereas oil and gas reserves are dwindling, he said the potential energy from coal and atomic power is adequate for hundreds of years. But he added that the present ability to substitute these fuels for oil is limited, and the nation will continue to have to rely on oil to a great degree.

Lincoln said disruption of Middle East oil supplies by closure of the Suez Canal and rupture of a pipeline to the Mediterranean "is cause for sobering thought about over-dependence on sources which are questionably secure."

"We are a great country largely because of our supply and use of energy," he said. "Without control of that energy supply, we could become a Samson shorn of his locks."

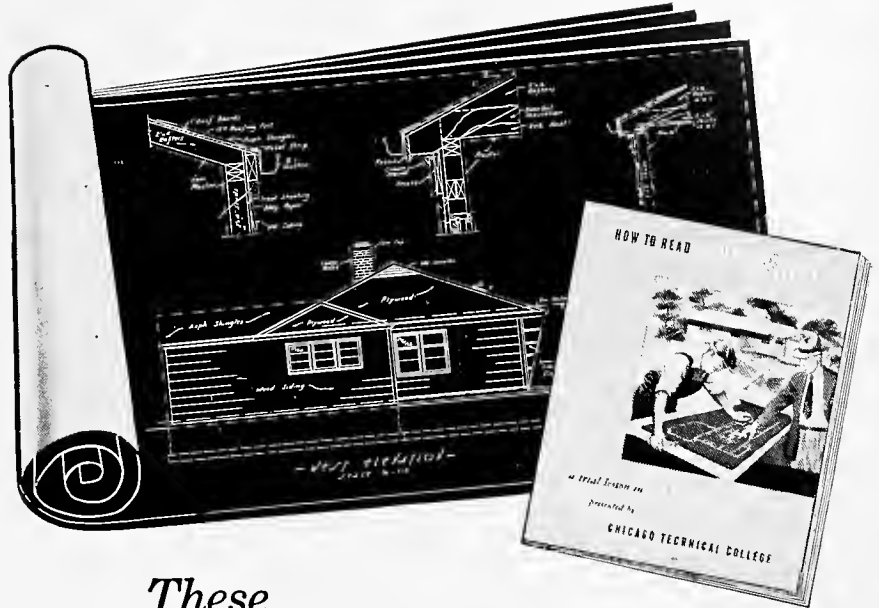

These FREE BLUE PRINTS have started thousands toward BETTER PAY AND PROMOTION

That's right! In all fifty states, men who sent for these free blue prints are today enjoying big success as foremen, superintendents and building contractors. They've landed these higher-paying jobs because they learned to read blue prints and mastered the practical details of construction. Now CTC home-study training in building offers you the same money-making opportunity.

LEARN IN YOUR SPARE TIME

As you know, the ability to read blue prints completely and accurately determines to a great extent how far you can go in building. What's more, you can learn plan reading simply and easily with the Chicago Tech system of spare-time training in your own home. You also learn all phases of building, prepare yourself to run the job from start to finish.

CASH IN ON YOUR EXPERIENCE

For over 67 years, building tradesmen and beginners alike have won higher pay with the knowledge gained from Chicago Tech's program in blue print reading, estimating, foremanship and contracting. Through step-by-step instruction, using actual blue prints and real specifications of modern, up-to-date buildings, you get a practical working knowledge of every building detail—a thorough understanding of every craft. And as a carpenter or apprentice, you already have valuable experience that may let you move up to foreman even before you complete your training.

Don't waste a single day. Start preparing right now to take over a better job, increase your paycheck and command greater respect as the "boss" on the job. Find out about Chicago Tech's get-ahead training in building. Send for your free blue prints and trial lesson—today! Approved for Veterans.

CHICAGO TECHNICAL COLLEGE

B-143 TECH BLDG., 2000 S. MICHIGAN AVE., CHICAGO, ILL. 60616

FREE BLUE PRINTS AND TRIAL LESSON

Send for your free trial lesson now. You'll agree that this training is simple yet practical—your surest way to promotion and increased income in building.

MAIL COUPON TODAY

Chicago Technical College
B-143 Tech Bldg., 2000 S. Michigan
Chicago, Illinois 60616

New G.I. Bill!
Vets check here

Please mail me Free Trial Lesson, Blueprints and Catalog.

Name _____ Age _____

Address _____

City _____ State _____ Zip _____

Occupation _____

Accredited Member National Home Study Council

New Occupational Safety and Health Act Should Lessen Hazards at Your Job Site

■ Look for safer work sites and more safety inspections of construction projects in the years ahead.

The new Occupational Safety and Health Act of 1970 goes into effect April 28. It's a bill long supported by the United Brotherhood of Carpenters and Joiners of America and the building and construction trades generally.

It will enlist approximately 2,000 people to cut the annual death toll due to industrial hazards.

By April 28, President Nixon must appoint an Assistant Secretary of Labor for Occupational Safety and Health and three members of an Occupational Safety and Health Review Commission. The original commission members will serve a two, a four, and a six-year term, and thereafter the members will serve six years, with a new appointment coming up every two years.

There are still a number of uncertainties about the new law, but the building trades generally regard it as a milestone in the fight for safer working conditions.

Big, New Agency

When the new Labor Department bureau created to carry out the provisions of the Occupational Health and Safety Act of 1970 gets rolling, it will be a good-size agency.

Secretary of Labor James D. Hodgson estimates that it will be comparable in size to the Department's Wage and Hour Division which has some 2,000 employees.

"One of our biggest problems," he said, "is to find and train a staff of inspectors. There are not an adequate number of trained people in this field. This is one of the lessons we learned from the Federal Mine Safety Act."

The Labor Department is asking for \$11 million for fiscal 1971 covering the first six months of 1972, but Hodgson said more will be needed for proper enforcement of the law.

Union safety experts said they hope the Department asks for considerably more. They estimated that the \$11 million would only be "a drop in the bucket" for effective enforcement.

The new Assistant Secretary of Labor for Occupational Health and Safety, Hodgson said, could come from either in or out of government.

He would have to be an "accomplished executive," familiar "with the world of work" and be able to get along with such groups as labor and management. Labor Department and Health, Education and Welfare and the states and the Federal government.

More Safety Data

Another by-product of the bill was that it would enable the Labor Department to collect sound statistics on the number of job casualties, Hodgson said. Currently neither the Department nor the National Safety Council has the facilities, he said.

The Act was signed by President Nixon in the Inter-Departmental Auditorium. A special backdrop was set up with a picture of James A. Mitchell, Eisenhower's Labor Secretary, looking down on the proceedings.

Among the union officials present were AFL-CIO President George Meany, and Steelworkers and Industrial Union Department President I. W. Abel.

Nixon acknowledged that the bill was "different in substance" from the bill urged by the Administration but it "attains the same goals." He said he would not have signed it if it did not have the support of both industry and labor.

"All groups cooperated in making this bill possible," he said.

Actually, the final product was largely a victory for organized labor over the Administration-business proposals.

A major battle took place over

who should set the health and safety standards. The business-Administration side wanted to give the power to independent boards. Organized labor said these boards too often have become the pawns of business. Labor was successful in making the Labor Secretary responsible for setting the standards.

Labor won another important battle in giving worker representatives the right to accompany inspectors whether or not employer representatives go along.

Organized labor wanted the Labor Secretary to be the final enforcement authority with employers free to go to the courts. The final bill gave a three-member panel final enforcement power prior to going to the courts.

The final bill also weakened the "imminent danger" section which requires the Secretary to seek a court order to restrain imminent danger practices.

Labor Statement

At the time the bill passed Congress, AFL-CIO President Meany called it "a long step down the road to a safe and healthy workplace" and he stressed that the AFL-CIO would closely monitor the law to see that it is carried out.

Abel, in his statement, declared that Senator Harrison A. Williams (D-N.J.) and Rep. Dominick Daniels (D-N.J.), sponsors of the law, and all their co-sponsors "deserve the gratitude of all trade union members."

"This law is an epochal event in our national effort to improve the quality and safety of life in America," Abel declared.

Williams said the Act "represents a landmark protecting the health and lives of America's working men and women."

Following are major provisions of the Occupational Health and Safety Act of 1970, a top priority in the 91st Congress:

Continued on Page 33

Estwing Tools are First Choice of Those Who Want the Very Best



NAIL HAMMERS
NYLON-VINYL
GRIP



NAIL HAMMERS
LEATHER GRIP



BALL PEEN
HAMMERS



DRILLING
HAMMERS



ROCK PICKS



PLASTIC
MALLET



SHINGLER'S
HAMMER



HANDY
CLAWS

Forged One-Piece-Solid Steel.
Strongest Construction Known.
Unsurpassed Temper, Balance
and Finish.

Plus

Exclusive Nylon-Vinyl Cushion
Grip or Genuine Leather Cushion
Grip.

Available at Leading Hardware
and Building Supply Dealers
Everywhere.

If your Dealer can't supply you
with
ORIGINAL ESTWING TOOLS
write us.



CHIPPING
HAMMERS



LATH
HATCHET



DRY WALL
HAMMER



CARPENTER'S
HATCHETS



SPORTSMAN'S
AXES

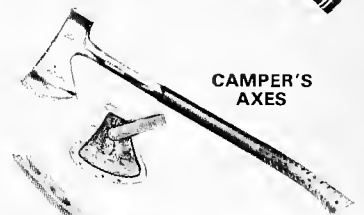

CAMPER'S
AXES



PRY
BAR



HANDY
BAR



MINI-SAW



HACK-SAWS



SPORTSMAN'S KNIFE



TRIM SQUARE



SAFETY GOGGLES

Estwing

MFG. CO.
DEPT. C2

2647 - 8TH STREET
ROCKFORD, ILL. 61101



CANADIAN REPORT

Ontario and Quebec Building Trades Fight Employer-Association Move

Labor act changes in both Ontario and Quebec affect the building industry profoundly.

Organized labor and the building trades unions have reacted strongly in both provinces.

But the changes in Quebec are vastly different from those in Ontario.

In Ontario the main bone of contention is an amendment to the labor act which gives legal sanction to accreditation of organizations of employers with exclusive rights to bargaining for their affiliated unionized employees.

The explanatory section of the act is worked this way:

"To help correct an economic imbalance of power, an employer association accreditation scheme will be established for the construction industry. This scheme will grant exclusive bargaining rights to an employer association able to demonstrate the required degree of support amongst a group of unionized employers. These bargaining rights will entitle an accredited association to negotiate a collective agreement that will be binding on all covered employers and will prevent individual employers from entering into a separate agreement with a union."

The unions dispute the premise on which this change is based. They deny that there is a so-called imbalance of power, and say that the new legislation gives more power to the employer groups than any relevant legislation gives to union councils.

The building trades councils are continuing their protest against the new legislation while preparing for negotiations with Ontario builders in April. These negotiations may prove to be a real test of the legislation.

At first some sections of the building industry were also opposed to the

changes but they have been brought into line. They hope that the accreditation system will effectively prevent maverick employers from signing settlements with unions before the employer association approves a deal.

The building trades are understandably fearful of the new arrangement, but it just could be that the things will work out reasonably well. The unions have pretty solid, sophisticated leadership and in some parts of Ontario, like the Thunder Bay area, have already been involved with an organization of employers on a voluntary basis. The experience has worked to the advantage of both groups.

In Quebec the legislation is even more contentious than in Ontario. There the government is ruling the construction field by decree. Do as we say . . . or else!

Or, just do as we say.

In mid-December the new Quebec Minister of Labor Jean Cournoyer laid down the terms of a construction industry settlement which gave construction workers in Montreal an increase of 75 cents an hour over three years, and workers outside Montreal \$1.25 an hour over three years.

The idea is to help the outside Montreal workers to achieve wage parity with those in the Metropolitan area.

The city workers' settlement is exactly the figure which was already provided under terms of a bill passed last summer to end a six-week construction strike in the province.

That bill known as Bill 38 was adopted by the Quebec National Assembly on August 8, 1970 while Pierre Laporte was still minister of labor. Laporte is now mourned as a victim of terrorism which hit Montreal late last year. His alleged assailants are now being tried.

It was the late minister of labor who ended the strike by declaring that a state of crisis existed through strikes which tied up \$600 million in contracts.

Representatives of the two central labor bodies in Quebec, the Quebec Federation of Labor and the Confederation of National Trades Unions, and five employer organizations were given 30 days to work out a new contract under supervision of two government conciliators.

The strike had been called jointly by the QFL and the CNTU to support demands for provincewide wage rates based on those earned in the Montreal area. The employers resisted this demand.

The two parties failed to reach agreement under the two conciliators. This led to the government decree on the 75 cents-in-\$1.25 out-of-Montreal basis.

The QFL represents the international unions, mostly organized in the Montreal area. The CNTU and its construction affiliate, the National Federation of Building and Wood Workers, has most of its members in the area outside of Montreal.

The QFL and the CNTU do not always see eye to eye by any means.

Last September Louis Laberge, QFL president suggested that a vote be taken among Quebec construction workers to choose a single labor group to represent them, in other words, to make a choice between the QFL affiliates and the CNTU.

The QFL has had the support of the Montreal Council of the CNTU. This created some friction between that Council and the CNTU leadership.

Inflation Down? Unemployment Up?

Pensioners and most workers may have found it hard to believe but the words came from the mouth of the prime minister of Canada, Pierre Elliott Trudeau, that "inflation no longer exists in Canada."

This same prime minister pronounced less than a year ago that inflation was the major threat to the nation's economy, and he set the wheels in motion to try to reduce inflation at the cost of sharply increased unemployment.

Now PM Trudeau says that priority would be given to tackling the jobless problem. Why the sudden turnaround?

Simply because government policy is backfiring. The unemployment rate has become politically unacceptable.

The inflation threat has not been as dangerous in Canada as the authorities

pictured it. Unemployment has been worse than estimated.

In its so-called anti-inflation fight the government keyed its attack on wages with considerable support from a public which looked upon 9 and 10 percent annual wage increases as too high and certainly inflationary. A recent report from the Organization for Economic Co-operation and Development seemed to controvert this belief and threw the braintrusters in Ottawa into a tizzy.

OECD is a voluntary international body made up of 22 countries including Canada, the U.S. and most advanced western nations. Its aim is to foster world economic growth and full employment.

The OECD report said that wage rates in Canada have been lagging behind advances in production and profits by three years, and that the upsurge in pay rates in 1970 was in effect a process of catching up with past increases in Canadian output and corporate profits.

The resumption of economic growth in 1971 would not necessarily be inflationary, said OECD.

This is very much along the line of what the Canadian labor movement had been saying in its opposition to the 1970 guidelines policy of the federal Prices and Incomes Commission. It's nice to have an independent international economic body support your position against the official position of the government and of big business.

Naturally the pundits at Ottawa were considerably embarrassed by the OECD statement and issued a statement saying that the OECD report was misinterpreting the facts.

Statistics can often be subject to more than one interpretation. But one conclusion can be drawn. Wage increases were not to blame in any major way for the economic slowdown which the government is now trying to reverse.

Another conclusion is that heavy unemployment is a much more serious economic threat than mild inflation such as Canada has experienced.

Union Membership Up 4.7% in 1970

The Canada Department of Labor reports that the labor movement in Canada showed considerable growth in 1970.

Union membership went up 4.7 percent over 1969 and comprised 33.6 percent of the non-agricultural working force and 27.2 percent of the total labor force.

Three-quarters of all unionized

workers were in affiliates of the Canadian Labor Congress, and of these, 1,111,000 were in unions affiliated with the AFL-CIO. The total 1970 membership in the CLC was 1,632,000.

Ten percent of all union members were in the Quebec-based CNTU and 15 percent in various unaffiliated and independent national and international organizations.

Due to growth of union members in the public service sector, an increasing share of total union membership was in national and regional unions.

Toronto Fastest Growing Urban Center

The city of Toronto is the fastest growing urban center on the North American continent, based on the per capita value of construction in 1970.

The Toronto building commissioner expects 1971 to be at least as good. A number of huge developments are under way or in the advanced planning stage.

Metro Center located not far from the waterfront will be built in an area which is now a network of railroad tracks. The property is owned by the CNR and CPR and the development is a joint effort of these two giant rail corporations, one publicly, the other privately owned.

The Center is expected to cost a billion dollars. It will take about 15 years to complete.

The first phase which is being proceeded with will cost \$100 million and consist of a 1,575 foot high communications tower, two office towers with a million square feet of floor space and a transportation center. A major sports center is also being considered.

This is just one of the big projects for Toronto. There are a dozen others including a number of big hotels and office-apartment complexes in the \$25 million to \$100 million range.

Gap Between Pocket And Pay Envelope

Building trades wages may seem high to the public, but they are by no means high when they reach the workman's pocket book.

This was brought out in a survey by an enterprising Toronto reporter who discovered that there is a big difference between a wage rate and actual pay over a period of a year.

In Metro Toronto a union carpenter would earn about \$12,500 for a full year's work, but the average carpenter

Continued on Page 37

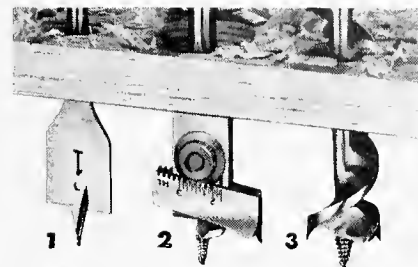

3 easy ways to bore holes faster

1. Irwin Speedbar "88" for all electric drills. Bores faster in any wood at any angle. Sizes 1/4" to 3/8", \$.90 each. 5/8" to 1", \$1.00 each. 1 1/8" to 1 1/2", \$1.50 each.

2. Irwin No. 22 Micro-Dial expansive bit. Fits all hand braces. Bores 35 standard holes, 7/8" to 3". Only \$5.70. No. 21 small size bores 19 standard holes, 5/8" to 1 3/4". Only \$5.00.

3. Irwin 62T Solid Center hand brace type. Gives double-cutter boring action. Only 16 turns to bore 1" holes through 1" wood. Sizes 1/4" to 1 1/2". As low as \$1.60 each.

EVERY IRWIN BIT made of high analysis steel, heat tempered, machine-sharpened and highly polished, too. Buy from your independent hardware, building supply or lumber dealer.

Strait-Line Chalk Line Reel Box only \$1.35 for 50 ft. size

New and improved Irwin self-chalking design. Precision made of aluminum alloy. Practically damage-proof. Fits the pocket, fits the hand, 50 ft. and 100 ft. sizes. Get Strait-Line Micro-Fine chalk refills and Tite-Snap replacement lines, too. Get a perfect chalk line every time.

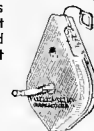

IRWIN Wilmington, Ohio 45177
every bit as good as the name

LAYOUT LEVEL



- ACCURATE TO 1/32"
- REACHES 100 FT.
- ONE-MAN OPERATION

Save Time, Money, do a Better Job With This Modern Water Level

In just a few minutes you accurately set batters for slabs and footings, lay out inside floors, ceilings, forms, fixtures, and check foundations for remodeling.

HYDROLEVEL is the old reliable water level with modern features. Toolbox size. Durable 7" container with exclusive reservoir, keeps level filled and ready. 50 ft. clear tough 3/10" tube gives you 100 ft. of leveling in each set-up, with 1/32" accuracy and fast one-man operation—outside, inside, around corners, over obstructions. Anywhere you can climb or crawl!

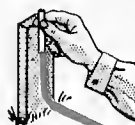

Why waste money on delicate instruments, or lose time and accuracy on makeshift leveling? Since 1950 thousands of carpenters, builders, inside trades, etc. have found that HYDROLEVEL pays for itself quickly.

Clip this ad to your business stationery and mail today. We will rush you a Hydrolevel with complete instructions and bill you for only \$7.95 plus postage. Or send check or money order and we pay the postage. Satisfaction guaranteed or money back.

Ask your tool dealer to order it for you. We allow the usual dealer discount on 1/4 Doz. lots and give return-mail service.

HYDROLEVEL

925 DeSoto, Ocean Springs, Miss. 39564
FIRST IN WATER LEVEL DESIGN SINCE 1950

Canada Faces the Pollution Threat

CANADIANS have never had it so bad. For hundreds of square miles over the great metropolitan regions and in the area surrounding many industrial plants, the famous blue Canadian sky is brown—blotted out by a pall of smog and stinking, sulphurous fumes. Vast acreages of forest have been defoliated by toxic wastes belching daily from industrial stacks. Northern streams, once cold and clear, are warm and turgid with chemical effluent. Great rivers have become open, slimy sewers of human and industrial waste. Entire lakes are dead. Fisheries are poisoned. Quiet suburbs have become a nightmare of screaming jets. The old swimming hole is a garbage dump.

In our race for industrial progress and economic growth we have paid scant attention to the ruthless spoilage of nature. Pollution has reached such proportions that life in its many forms is seriously menaced.

The Canadian Labor Congress, which represents a large proportion of the Canadian public, has a duty—in keeping with its concern for the well-being of its members, their families, and all citizens—to place its influence and resources to the forefront of a national effort mobilized to combat pollution.

The protection of the public good is the responsibility of government and up to the present time our governments in the federal and provincial jurisdictions have been slow to legislate, or where legislation already exists to enforce it, against pollution offenders.

The Canada Water Act, which aims at a comprehensive management program in the area of pollution control and use of water resources, should remedy some of our legislative deficiencies. In co-operation with the provinces, this act provides for the establishment of water quality management agencies to control pollution and stiff penalties for offenders. It could represent the first major step by the federal government towards a comprehensive pollution policy.

Control legislation in varying degrees is present on the provincial statutes. Common law permits some redress against private and public nuisance. Municipalities are empowered to enact by-laws regarding waste disposal. And public health legislation generally purports to prevent pollution in various forms.

These laws, however, appear to have been ineffective in protecting our water, soil and atmosphere from the intrusion of pollutants to such an extent that some scientific experts now suggest that we may be too late in restoring fully the balance of nature.

One eminent ecologist predicts the death of oceans by 1979 if the process of pollution is not stopped. He suggests that the level of contamination in the atmosphere will soon be high enough to reduce normal solar radiation to the detriment of vegetation. Another holds that everyone in America will be deaf by the year 2,000 and that there is more than mere auditory damage caused by noise.

Our approach to the problem of pollution must be global. The time for action is now. Our survival is at stake as never before. But history has taught us that we cannot rely upon profit-oriented private enterprise to institute strong action in social fields. Therefore, we must

look to government for wise, decisive and prompt remedies. For instance, the residue from DDT and other pesticides used in agriculture has been found in meat, vegetables, and drinking water. We must take more stringent measures against the pollution of food and drink by questionable chemical additives. These substances which were never designed specifically for use in foodstuffs are there because of the marriage of convenience between chemical and food interests aimed at boosting the sales of their respective products. The common use of these additives could mean that the consumer is being slowly flavoured and dyed to death for the sake of profit.

Pollution cannot, however, be controlled and prevented by legislation alone. Legislation must be augmented by the twin weapons of research and experimentation. To some extent, these weapons are already being used by government and private agencies. One example is the Canada Centre for Inland Waters at Hamilton, Ontario, a co-operative research project being carried out by several departments of the federal government. And some industries have undertaken research projects.

But pollution control and prevention cannot be left to government alone. It is imperative that we, as the national voice of organized labour, develop a concerted demand for governments to enact without further delay effective and enforceable legislation that will prevent, under severe penalties, the continuance of destructive practices which endanger our environment.

At the same time we must initiate within our own ranks, through our federations and labour councils, a comprehensive education programs on pollution problems. Parallel to this there must be an on-going involvement with other civic-minded organizations in identifying, publicizing, and seeking community support for the swift eradication of environmental hazards at their source.

There is a real danger that fighting pollution could become mere talk, a fad which would lose popular appeal when another one came along. Therefore, the Congress in Convention supports a program of action, including the following steps for involvement of local unions:

- 1. Take the initiative in forming citizen Ban Pollution committees;**
- 2. Seek technical assistance from government, university and sympathetic industry research units;**
- 3. Identify local sources of pollution and make constructive criticism of area pollution problems;**
- 4. Demand comprehensive pollution control and prevention legislation at all levels of government;**
- 5. Demand realistic deadlines for ending local pollution;**
- 6. Make periodic re-assessments of pollution control programs;**
- 7. Publicize good results of anti-pollution efforts as well as bad ones;**
- 8. Take action to counteract jurisdictional buck-passing by federal, provincial and municipal authorities; and**
- 9. Prepare a progress report for the 1972 Canadian Labor Congress Convention. ■**

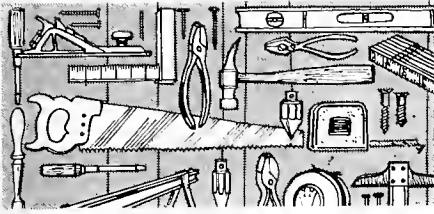

LOCAL UNION NEWS

Alberta Local Union Commemorates 50th Birthday



Pioneers of Local 846, Lethbridge, Alberta, were honored recently, when the local union commemorated its 50th birthday. The old timers included: left to right front row: Don Vath, secretary of 846; Tom Clay, executive; Carlo Chiste, 26 years membership; Roy Berlando, first period with Local 846. All these men were presented with long service pins: Andy Thompson, 30 years a member; Clarence Barby, 30-year Member; and Joe Leroy, long Service pin. Fourth from right, back row, A. Dogterom, 40-year member. The local union charter was issued February 23, 1920; but the first meeting was held February 4, 1920.

39th Annual Party Celebrated at Junction City, Kansas

A charter of the United Brotherhood of Carpenters and Joiners of America was presented to Local 750, Junction City, Kans., on November 15, 1940. Former 6th District Board Member J. O.

Mack was the installing officer.

Each year since, Local 750 has commemorated its birthday with a party—the most recent being held November 13, 1970, at the nearby Rock Springs

4-H Ranch in its big dining room.

The local union still has eight charter members on its active roster. These members were particularly honored at the recent anniversary party.



The officers of Local 750 with a guest of the anniversary party: Standing, from left, Michael Mosher, trustee; Leonard Bremer, trustee; Marshall V. Darling, president; R. P. Ratts, trustee; and Virgil Keller of Local 918, Manhattan, Kans., of the Kansas State Council of Carpenters. Seated, Amos Hooper, treasurer; Bert Spittles, warden; Alvin Schubert, business representative and financial secretary; and Glenn Stockwell, conductor. Absent at the time of the picture: Leodell Spence, vice president, and James Laughlin, recording secretary.

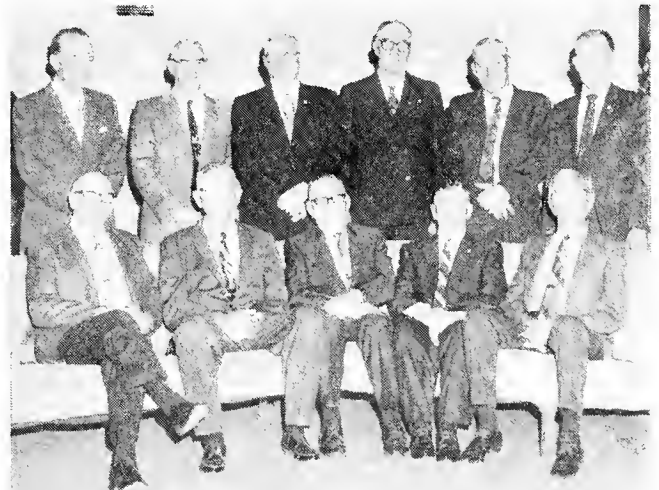

The old timers of Local 750 assembled for a picture. Seated, from left, are the following 30-year members: Fred Pratt, Rolla Allaman, Martin Lueker, Bert Spittles, and Charles Kimbrough. Six of the charter members are standing in the rear: Amos Hooper, Harry Walton, Harry McCluskey, Charles Karmann, Eugene Hindman, and Alvin Schubert. Absent at the time of the picture: J. O. Anderson and J. E. Hosler.

Vacation Fund Charter Members Honored

KENOSHA, WISC.—A dinner was held recently to honor the charter members of the Carpenters Local 161 vacation fund. From left, seated, are: Edward Weston, Percy Jones, and Fred Podella. These three have been members of the committee since its formation in 1956. Glenn Morrith, the other trustee to be honored was absent due to illness. Standing, from left, are: Bernard Evenson, administrator of the fund; Ben Yantorni, Local 161 president; Lew Blaney, financial secretary and the business agent-elect, and George Larsen, a fund trustee.



OVER-TIME PARKING



An over-time parking problem faces the driver of this old log truck (registered in 1921) who straddled a tiny Douglas fir tree seedling when he parked nearly 50 years ago. The tree, obviously handicapped, has grown up through the truck and partially encased the frame on both sides. Dale Houston, a forester for Georgia-Pacific Corp. representing a newer generation of tree farmers, looks in disbelief at the old hardrubber tires and chain drive once common in the woods. The photo was taken near Alder Point, Calif.

Wear Your Lapel Button Proudly



Your Brotherhood lapel button costs little, but its value is high. It signifies membership in an old and respected craft. It tells all who see it that you belong to an organization which stands firmly for good wages, fair working conditions, and a decent standard of living for your family and your fellow man.

Gold Watch Presentation

Henry Carlson of Local 1246 Marinette, Wis., received a gold watch from Local President Ronald Sundquist in recognition of his 50 years of continuous membership. The award was made at the annual Christmas banquet.







NEW

DRYWALLTAPE



NEW WALLBOARD LIFTER
... THE KIKLIFT™ Cast aluminum, heat treated for strength. Correctly balanced with lip always on the floor. Move and position with your foot, kick under wallboard and lift. A non-skid surface gives the foot traction needed.

Send for FREE copy of the new 1971 Goldblatt Catalog, more than 1200 Trowel Trades Tools. Goldblatt Tool Co., 521B Osage, Kansas City, Kansas 66110



Div. of Bliss & Laughlin Industries

FLEX CORNER

WRITE FOR
FREE SAMPLE



"We
Congratulate..."

... those members of our Brotherhood who, in recent weeks, have been named or elected to public offices, have won awards, or who have, in other ways, "stood out from the crowd." This month, our editorial hat is off to the following:



Carpenters' District Council of St. Louis members cited by the St. Louis Chapter of the American Institute of Architects for their outstanding craftsmanship, are, from left, Al Doering, Melvin Lanns and George Grateke. Presenting the award certificates is Leonard Terbrock, Council business representative.

CRAFT AWARDS—Three carpenters, members of the Carpenters' District Council of Greater St. Louis, were among five building tradesmen honored by the St. Louis Chapter of the American Institute of Architects for "superior craftsmanship and very real service to the entire local construction industry."

They are:

Al Doering, Local 73, a Council member for 11 years, was cited for his work in the law offices of Thompson, Walther & Schewmaker in the Laclede Gas Building. He is employed by Albers Construction Co.

Melvin Lanns, Local 1739, a Council member for eight years, was cited for his work in the Trinity Presbyterian Church Sanctuary Renovation. He is also employed by Albers Construction Co.

George Grateke, Local 2119, a Council member for 14 years, was cited for his work in the Ralston Purina Research Center. He is employed by Volk Construction Co.

This is the fourteenth Craftsmanship Awards Program sponsored by the AIA Chapter to "recognize the performance of exceptional craftsmanship and the display of interest and ingenuity by building trade craftsmen in order to encourage

the highest grade of workmanship."

Award nominations are made by the members of the St. Louis Chapter of the AIA. All buildings are visited by the selection committee.

The award winners were selected from a list of over 30 candidates.

STATE SECRETARY—At the annual convention of the Georgia State AFL-CIO, held in Augusta, Georgia, October 21-23, 1970, Herbert H. Mabry, president of Carpenters Local 225, Atlanta, Georgia, was elected state federation secretary. Brother Mabry has served as president of Local 225 for two years, and, prior to that he served as vice president.

J.A.C. WORK—Robert F. Dalton, director of labor relations for the Building Trades Employers' Association of Cleveland, O., has been honored for his work in the national apprenticeship program.



Continued on Page 39

new AUDEL CARPENTERS & BUILDERS GUIDES

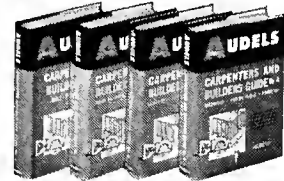

4 VOLS.
1616 Pages
Heavily Illust.
ONLY \$16.95

INSIDE TRADE INFORMATION—for Carpenters, Builders, Joiners, Building Mechanics and all Woodworkers. Here are the short-cuts you want—new methods, ideas, solutions, plans, systems and money-saving suggestions. A complete course for the apprentice—a practical daily help and Quick Reference for the master worker. Mail COUPON TODAY to get these helpful guides used by thousands of carpenters. Shows you—

HOW TO USE: Mitre Box, Chalk Line, Rules & Scales, Steel Square & Settings 12, 13 & 17. **HOW TO BUILD:** Furniture, Cabinetwork, Houses, Barns, Garages, Skylights, Stairs, Hoists, Scaffolds. **HOW TO:** File & Set Saws, Do Carpenters Arithmetic, Solve Mensuration Problems, Estimate Strength of Timbers, Set Girders & Sills, Frame Houses & Roofs, Estimate Costs, Read & Draw Plans, Draw Up Specifications, Excavate, Lath, Lay Floors, Hang Doors, Put On Interior Trim, Insulate, Paint.

MONEY BACK GUARANTEE

You must be COMPLETELY satisfied with the Audel Guides you order, or you may return them within 10 days and get your money back.



ORDER NOW!

MAIL COUPON TODAY

THEO. AUDEL & CO., 4300 W. 62nd St. C-021
Indianapolis, Ind. 46268

Please mail me Carpenters & Builders Guides, 4 Vols. Enclosed is down payment of \$6.00. I agree to pay balance, including shipping costs, within 30 days. If I am not completely satisfied with my Audel Guides I may return them for refund.

Name _____

Address _____

City _____ State _____ Zip _____

SAVE SHIPPING COSTS. Enclose \$16.95 (plus sales tax, if any) and we pay postage.

START A MONEY-MAKING BUSINESS FOR LESS THAN \$50!

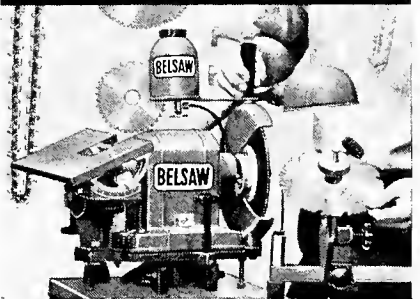

You can have your own lifetime business right at home...work in spare time... and make up to \$200 a month CASH! My FREE PLAN gives you all the facts: How to start, how to grow. You don't need previous experience. You don't have to sell. I'll even finance you. People bring you the work and pay cash. Over 90% of every dollar you collect is clear cash profit. And you work when you want to. Let me prove you can't find a more certain, lower cost, higher paying business of your own.

Just Mail Coupon—No Salesman Will Call

BELSAW SHARP-ALL CO.
Stan Field, President
731F Field Bldg., Kansas City, Mo. 64111



Name _____

Address _____

City _____ State _____ Zip _____

THIS SPACE CONTRIBUTED BY THE PUBLISHER

One cancer you can give yourself.



Horrible isn't it?

AMERICAN CANCER SOCIETY

Las Vegas Enjoys Dinner-Dance



Members of Ladies Auxiliary 597 of Las Vegas, Nev., served as hostesses for a recent awards dinner and dance held by Local 1780 to honor its 25 to 55-year members. Among those serving the refreshments were, from left: Daisy Snook, Nell Camp, Treva Roper, Loretta Benson, Vera Keasey, Rebecca Cox, and Dolly Powers.

Jobless Benefits Due Locked-Out Workers, Says Indiana Court

An Indiana appellate court has ruled that lock-out workers are entitled to unemployment compensation benefits for the duration of the lock-out if they are "unemployed through no fault of their own."

The ruling involves a three-month lock-out in 1968 by the Clip Pattern & Foundry Co. and three other foundries against members of the Pattern Makers Association in South Bend.

The companies closed their doors at the expiration of a contract.

The precedent-setting decision means that nearly 100 members of the union will receive retroactive unemployment benefits amounting to tens of thousands of dollars.

Max Wright, secretary-treasurer of the Indiana AFL-CIO, explained that the locked-out workers has applied for the benefits each week. When they were denied the benefits, they appealed the denial to the review board of the Indiana Employment Security Act.

Both a referee and the review board found that since no impasse had been reached in negotiations before the lock-out, the workers were unemployed through no fault of their own, and, therefore, entitled to the unemployment benefits.

The appellate court found that the evidence supported this finding because the employees had offered through the union to keep on working until a new agreement was reached. The employers, however, responded that the plants would be closed.

The court acknowledged the legal right of an employer to lock out his workers, but said that "he cannot use the Employment Security Act to further his cause."

The review board had found that the companies had given the union a "no contract, no work" ultimatum. The board summary said:

"At the time the employers decided to close their plants, there had been no work stoppage by employees, no overt actions by employees to curtail production by slow-down tactics, and no irregular attendance by employees. . . . The record is conclusive in that the facts show that work was available, the employees had continued working regularly and they were ready and available for work."

The companies contended that there was an impasse in negotiations and that a labor dispute existed. But the appellate court held that the employees still had the right to unemployment compensation during the lockout unless their own intransigence had contributed to it.

Fight Water Pollution



Keep America clean for the next generation.

THE CARPENTER

PLANE GOSSIP

SEND YOUR FAVORITES TO:
PLANE GOSSIP, 101 CONSTITUTION
AVE. NW, WASH., D.C. 20001.
SORRY, BUT NO PAYMENT MADE
AND POETRY NOT ACCEPTED.

A Real Sweet Deal

Didja hear about the woman who got her supply of "the pill" mixed up with her saccharine tablets? They say she has the sweetest children!—John Freeman, L.U. 22, San Francisco.

R U REGISTERED TO VOTE?

Outa-This-World-Talent

A real diplomat is a guy who can tell you to go to hell in such a manner that you really look forward to the trip!

ATTEND YOUR UNION MEETINGS

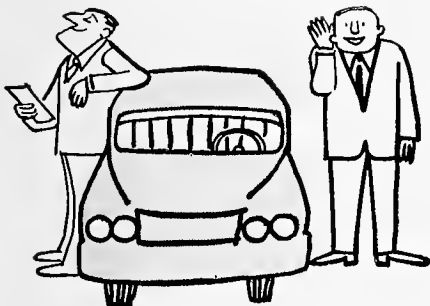

He Auta Be Careful!

The used car dealer was extolling the merits of an aged model to a customer. "You can't go wrong with this one," he boasted. "It's the opportunity of a lifetime!"

"Sure it is," agreed the leery customer. "I can even hear it knocking!"

BUY ONLY UNION-MADE TOOLS

And That's No Bull!

The Latin American was telling a visiting U.S. clubwoman about his country. "Our most popular sport is bullfighting," he said. Upset at the thought of such a bloody spectacle, the dowager said: "But isn't it revolting?" "Oh, no, senora," replied the Latino, "that is our second-most popular national sport!"

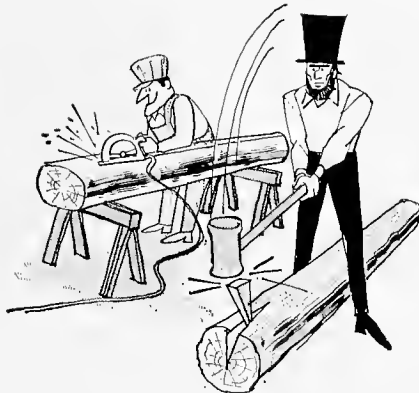

Maids to Order?

Said the cook to the cannibal: "We're having a couple of old maids for lunch, your highness."

"Ugh!" said the king. "We're always having left-overs!"

UNION DUES—TOMORROW'S SECURITY

Right Handy Lad!

The street peddler was selling fruit to the Scottish housewife and, as her young son was standing, looking at the cherries, he invited the boy to help himself. "Take a handful," he invited. When the boy refused, he put a generous handful into the boy's cap. Later his mother said: "Son, 'why did you na take some cherries when the man asked?" "Hoot, mither," replied the tad, "did y' no notice the size of HIS hand?"—H. E. Millham, Fullerton, Pa.

1 4 ALL—ALL 4 1

A Solid Bargain

Realtor: Now here's a house without a flaw!

Southern Belle: Really? Then what do you-all walk on?—Jacob Willis, St. Louis.

GIVE A DOLLAR TO CLIC

Deft Definition

A genius is someone lazy enough to do the job right the first time.



This Month's Limerick

There were two frolicsome girls from Birmingham
And a scandal is current concerning them.

They lifted the bib
And tickled the rib
Of the Bishop as he was confirming them!

All At Sea

Two men met and one said: "Congratulations! I hear you've signed on as skipper of the good ship Matrimony!"

"Not exactly," replied the other. "I married a widow and I suppose that makes me her Second Mate!"

UNION DUES BUY RAISES

Marks Delimit

Student: I don't think I ought to get a zero on this exam!

Teacher: I don't think so either, but that's the lowest mark there is!—Mark Carini, River Drive, Ill.

BUY AT UNION RETAIL STORES

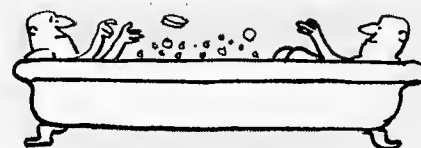

Not A Bath Deal

The hotel clerk explained to the late-arriving guest that the house was full. "We have nothing left but a room with shared bath. Would you object to sharing a bath with another man?"

"Not at all," agreed the traveller, "as long as he stays at his end of the tub!"

R U A UNION BOOSTER?

Just A Matter of Form

This year's income tax form has been revised and simplified. This is it:
(A) How much did you make last year?

(B) How much do you have left?
(C) Forward B.

UNION-MADE IS WELL-MADE

Solid, Man, Solid!

Carved on the tombstone of a cool musician: "Man, this cat is REALLY gone."

R U GOIN 2 D UNION MEETING?

Getting A Real Lift

The little old lady was on her first trip from her farm to the city. "I won't pay good money for a pigsty room like this . . . and so small!" she protested to the bellboy.

"Please, lady!" protested the bellboy, "this isn't your room. This is the elevator!"—Mr. Jerry Olin, Vancouver, Wash.



1



2



3



4

Las Vegas Musters Big Group of Oldtimers

Local 1780 of Las Vegas, Nev., was chartered on April 12, 1929, shortly before the crash of Wall Street and the Great Depression. Its charter members were drawn from workers on Boulder Dam. The carpenters' scale at the time was \$1 an hour, and they were happy to get it.

Members of Local 1780 recently got together to celebrate their local union's 41st birthday with an awards dinner and dance. The occasion was marked by the presentation of many service pins, as the accompanying pictures show:

(1) Twenty-five-year Pins went to these members of Local 1780, from left, front row: Joseph B. Lucero, Isaac Gusdofer, Thoma Trapasso, Tom Pool, Ray Liston, Lee Pounds, George Musser, Charles Camp, Joe Vigil, Ernest Bright, A. D. Foster, Everett Iiams, Glen Stark and Joe M. Cordova. Back row: Joe M. Law, Robert Zinsmeister, Jim Blakeman, Jake Romo, Wm. J. Hutchison, Sr., Orwin Olson, W. R. Hall, Henry Swanson, Russell Angione, Lloyd Drennen, and Clyde Jarman. Twenty-five-year Brothers not present to receive their pins were: Bernard Adams, George P. Adams, Quincy Alvey, C. R. Anderson, Wm. J.

Angvin, Arthur Baker, Jewel P. Bolles, Erving Bortles, Diamond Beetley, Clarence Bourque, James Boyer, Silvester Brane, Fred Broomfield, Hiram Bruce, Wm. Canfield, Charles Connelly, Keith Cornbridge, George Cromer, Lewis Dansby, Wayne Darnell, Wm. F. Ellis, George Englebrecht, Ellsworth Face, Herbert Fassler, Max Ford, Frank Garcia, M. K. Garhardt, Hugh Gilger, Rex Glenn, James Goodman, Duncan Gordon, Alva Haning, Lester Herring, Jack Hinrick, James Holland, J. R. Hood, Eugene Huse, John Jackson, A. T. Jenkins, Henry N. Jones, Charles Jordan, Walter Kajfas, Hyman Klein, Theodore Clock, George Latham, Eugene Littin, Floyd Leavitt, Torges Lee, Clyde Lewis, Lester Lloyd, Robert Lundgren, Loyd McAninch, Clee Mann, Paul Mears, George Michelson, Homer Morgan, Herbert Oliver, Marcelino Ozuna, Earl Parker, Fred Pennington, Harry Perhsall, Walter Pinjuv, C. F. Pinkstaff, Eric Peterson, Harry Pospical, Wm. M. Price, James Rawson, Wm. H. Smith, F. A. Snyder, Vernon Southern, R. W. Spencer, Robert Stannard, Gerald L. Stoddard, Lloyd Swope, Wm. S. Thomas, S. M. Thompson, Wayne Trotter, Vance Vallin, Condola Walton, Burt

SERVICE to the BROTHERHOOD

A gallery of pictures showing some of the senior members of the Brotherhood who recently received 25-year or 50-year service pins.

Ward, Frank Weaver, Angus Wegren, Andrew Yacek and Carl Zimmerman.

(2) Thirty-year carpenters are from left, front row: William R. Williams, Tom B. McCullough, John Kreimeyer, James Banner, George Serletb, Earl Schult, Homer O. Powers, Arthur Kistler, Howard Griswold, J. L. Doss, Roy S. Smith, A. C. Mortensen and William Whidden. Back row: R. D. Medford, Allen Shepherd, Fred N. Terry (25 years—he missed the picture taking for his group), John Power, Bill Marsac, Maurice Gibson, Arthur G. Taylor, Wm. B. Ragland, Harvey Mendenhall, Ernest Aukamp, Charles Franklin and Lawrence Shuman. Those Brothers who were not on hand to receive their awards were: J. D. Adams, Don F. Ahnder, F. E. Boerner, H. B. Bearden, Louis Biel, J. S. Carpenter, Fred Christensen, O. W. Clark, Odes Cremer, Leo Davis, Walter Davison, Merle M. Dunagan, Roscoe English, Clarence Fulton, George Gartin, James Gaskins, Vance Gooble, Harry Gohdy, Robert Grammer, Roy Cribble, Lawrence Hakala, Roscoe Haley, Merle E. Harris, Kale Hatfield, Edward Hanser, Robert Higgins, Thomas Holland, Frank Hutchinson, Bruce Ingram, Carl Kaiser, Gustav Larson, Robert La Rue, Darwin Long, Erwin McCollum, A. D. McKenna, Ned McKenzie, J. H. Mankins, Alex Matriciani, D. S. Miles, Fred Moss, Robert Newman, Gus Olson, Gerard Parent, C. E. Perry, Ralph Phillips, Benjamin Poole, James Fulse, L. E. Ragsdale, Charles Ray, Jewels Richards, Lester Richards, Wayne Roundy, Colin Ryness, Santi Sestini, Robert Shaner, L. C. Shaw, Richard Small, Edgar Smith, Robert Snyder, Lon Stamey, Ollie Stephen, Joe Stewart, Cecil Stubbs, C. B. Tinkler, R. V. Tinkler, Art Trimmer, Lloyd Van Ert, Eugene Wagner, C. S. Walkington, W. L. Weber, Gene Woolery, Erle Zook and Hugh Zug.

(3) Thirty-five-year members are, from left: Gene Owens, Harry Brown, Bill Benner and Herman Wills. Not present for the award ceremonies were the following 35-year brothers: A. F. Baker, Alfred Braccini, A. C. Endlein, C. C. Foster, W. French, E. J. McNatt, L. W. Mallard, Louis Maurer, Archie Mellott, Joseph Penninger, Will Robbins, George Richert, Wm. Robinson, Melvin Souza, Antonio Tesauro and Paul Zug.

(4) Forty to Fifty-five Year Members are congratulated by General Representative J. Wiley Howard, left, who shakes hands with 55-Year Member Daniel Crothers. Next left are Forest Leinenweaver whose pin says "40 Years" and far right is Harry Fisher who had just received his 50-year pin. Each of these three also received a gift in the form of a tool of the trade. In doing some quick paper work, Bro. Howard told the guests that the total years in awards given that night "represented 6445 years which would build a city larger than Las Vegas from the ground up." Not there to claim their 40-year pins were: V. S. Lewellen, Martin Nelson and John Schoepf.

Need More Money? Want to Be Your Own Boss?

Start Saw Sharpening Business Of Your Own IN YOUR SPARETIME

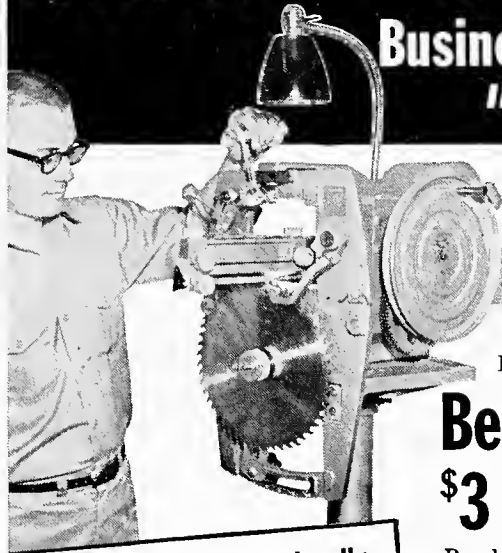

Turn your spare hours in the evening or weekends into extra dollars, this proven practical way—start your own money-making sharpening business—No selling or canvassing—No experience required. You can do it automatically with Foley Saw Filer or Lawn Mower Sharpener.

Beginners EARN \$3 to \$6 an Hour

People, just like yourself, all over the United States are making extra cash—\$20 to \$30 a week—right now in their spare time. "My sparetime saw filing business has made me \$952 these first ten months," says R. T. Chapman. Many start part-time, find it so profitable that they build year-round service business. You can, too, simply by following easy Foley plan.

Town of 150 Supports Profitable Business...

Here's the story from Dick and Jo Ann Koester after being in business less than a year. "We have acquired another Foley Saw Filer and for the past two months we have been in full-time operation. As we live in a small town of 150 population in farm area we use our truck to pick up saws in five nearby towns. With a family to support and plans for building to our house we had to pick up a business fast and already sharpen an average of 15-20 saws a day. Business for the future looks even better as good machine filing is our best advertising."

CASH for Sharpening Mowers

Every neighbor with a lawn needs his lawn mower sharpened at least once a year. No experience is needed to start—anyone can operate and turn out professional jobs. All operations are handled quickly, easily and accurately.

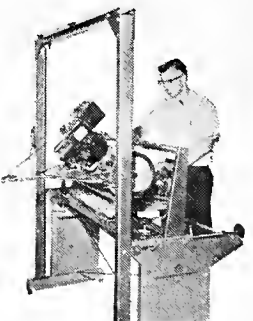

Sharpen These Professionally

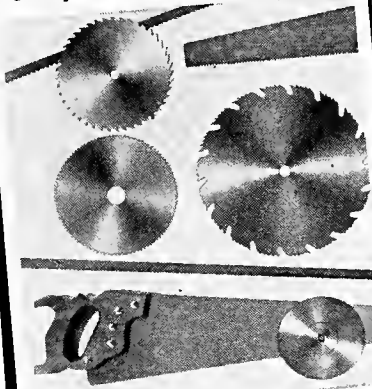

with amazing

Foley Saw Filer

You can sharpen combination (rip and crosscut) circular saws, band saws, hand saws, crosscut circular saws—and do a perfect job every time without experience or special training. The precision Foley Filer does it for you automatically! A complete repair shop in one machine! Set up in basement or garage, work your own hours in your own way and earn big sparetime profits.



MAIL COUPON TODAY!

FREE Booklet Tells How!

Free Book "Money Making Facts" shows just how you can start at home in spare time. Small investment—time payments if desired. Get this booklet—study it! Send coupon today. No salesman will call on you.

Foley Manufacturing Co., 218-1 Foley Bldg.
Minneapolis, Minnesota 55418

Send Free Booklet on Saw Sharpening Business
 Lawn Mower Sharpening

Name _____

Address _____

City _____ State _____ Zipcode _____

APPRENTICESHIP & TRAINING

Outstanding Graduates in Richmond



Only four of the nine Richmond graduates were present for the ceremony. They were, from left: Ronald Whitt, Sam Mitchell, Bobby Boatwright, and Andrew Smith.

An annual completion ceremony and dinner for new journeymen carpenters was held at Longworth's Restaurant, East Gate Mall Shopping Center, Richmond, Virginia, November 13.

The graduates are well above average in their skill and knowledge of the trade, and are a wonderful example of what apprenticeship can be, the local JAC reports.

Whitt is an excellent carpenter and is also talented in layout and instrument work. His employer gave him the opportunity along the way to use and improve his knowledge in this type of work.

Mitchell is an excellent carpenter and welder. His related class work in the welding shop was considered outstanding by his instructor.

Boatwright is an excellent carpenter and has moved up to carpenter foreman now.

Smith is an excellent carpenter, and has the talent for teaching. He teaches blueprint reading and estimating in the related night school classes.

1971 Carpenters International Apprenticeship Contest, August 12, 13, 14, in Detroit, Michigan.

Winner Honored



At a recent meeting of Boston Local 40, Apprentice Russell T. Britt was honored by all the members present for his winning the 1970 Massachusetts State Carpenters Apprenticeship Contest.

One of the many members who spoke highly of Russell was a carpenter foreman who had helped him by passing on some of the knowledge he had learned over many years. He attested to the fact that Britt had a unique ability to grasp and retain any information pertaining to the construction industry. Shown in the picture are: Training Supervisor John Greenland, Apprentice Britt, and Business Representative Robert J. Stevenson.

Careers in Carpentry

A NEW FILM

A new film, "Careers in Carpentry" produced by the United Brotherhood's Apprenticeship and Training Department, and first shown at the 31st General Convention, is now available for distribution to local unions, district, state or provincial councils, and joint apprenticeship training committees.

The film is 16 mm, in color and sound. It runs approximately 26½ minutes. It is geared to acquaint young men with the many employment opportunities existing in the field of carpentry. It covers all branches of our trade—commercial construction, home building, heavy and highway, cabinet making, millwrighting, pile driving, diving, and carpentry work related to the space industry.

The film should be extremely valuable in attracting capable young men to enter our apprenticeship programs. It is suitable for showing to civic and social organizations, as well as for presentation to high school students on career days. Young men viewing the film cannot help but get a graphic picture of what the career of carpentry is all about.

"Careers in Carpentry" sells for \$125.00 per copy. All orders should be directed to R. E. Livingston, General Secretary, 101 Constitution Ave., N.W., Washington, D.C. 20001.

The Bills for Lincoln's Funeral

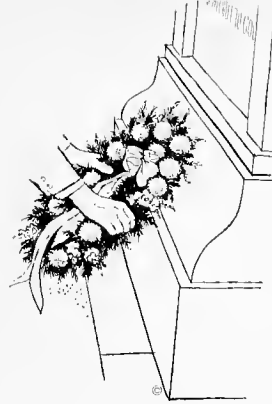

■ The assassination and funeral of Abraham Lincoln has been described in detail in prose and poetry. Stage plays have related the tragic events which followed the shots of a Derringer in Ford's Theater in Washington, D.C., that crucial night in 1865.

And everyone is well aware of the fact that inflation has increased prices substantially over the past 100 years, but nothing can dramatize the fact more than a look at the cost of President Lincoln's funeral.

L. J. Hawley of Santa Monica, California, some time ago, sent us a copy of the bills which the government paid to provide an appropriate funeral for the assassinated President.

At today's prices, \$8,500 buys only a moderate funeral for an ordinary citizen.

Compare the costs of the items below, for example, with those for the state funerals of Presidents Kennedy, Eisenhower, and Roosevelt.

The following bills for the Great Emancipator's funeral were paid by the U.S. Commissioner of Public Buildings (and the spelling and text is just as it was prepared a century ago):

To Drs. Brown and Drs. staff of Dr. Alexander.

To Embalming remains of Abraham Lincoln late President of the United States . . .	\$ 100.00
To 16 Days services for self and assistant at \$10.00 per day	160.00
Total	\$ 260.00

To Sand & Harvey

To coffin cover of fine Broadcloth lined with fine white Satin & silk trimmed with fine mountings heavy Bullion fringe & tassels, Lead inside of coffin lining fine silver plate & Walnut outside, One Box for Abraham Lincoln, late President of the United States	\$1,500.00
700 yds white silk at 3.75 pr. yd	2,625.00
257 yds white & black silk at 3.50 pr yard	899.50
132 yds white cambric at 1.00 pr yard	132.00
90 boxes fine crape at 7.50 per box	675.00
24 yds white swiss at 1.50 pr yard	36.00
158 pair blk kid gloves at 3.00 pair	474.00
126 pair white silk gloves at 1.00 pair	126.00

84 pair black silk gloves at 1.00 pair	84.00
170 boxes white thread at 3.25 per yard	552.50
Removing remains of Willie	10.00
23 days attendance 3 men at 5.00 per day each	345.00
Total	\$7,459.00

To John Alexander, Dr., Penna. Avenue, between 12 & 13th Sts.

Putting front of Presidents (House) in Mourning	\$ 50.00
Putting East Room in Mourning	30.00
Upholstering Catafalque in East Room	75.00
Upholstering funeral Car	50.00
Upholstering Railroad Car	85.00
Total	\$ 290.00

Bought of George R. Hall

To making Hearse body (and) Brunishings	350.00
To A. Jardin	
For flowers for Funeral of Late President April 18, 1865	
Rose Buds	\$ 9.00
Other white flowers	1.00
Total	\$ 10.00

To Phillip Ghegan Dr 1865

April 18th for Flowers for decorations for funeral of the President of the United States	\$ 20.00
--	----------

To James W. Callam 1865 April 14th.

Articles furnished on occasion of the assassination of the late President	
3 Packages Taylors Pat. Limt	\$ 3.00
2 Pounds Ground Mustard . .	2.00
6 Oz. Tinct. Camphor (ad) . .	.90
Total	\$ 5.90

Bought of Harper & Mitchell (Mourning for Mrs. Lincoln)

1 Mourning dress & trimmings	\$ 60.00
1 Mourning Shawl	25.00
1 Crape Veil	10.00
5 yds Blk. Crape 4.00 per yd	20.00
Gloves & Hdkfs	7.50
5 pr Hose	5.00
1 Crape Bonnet	15.00
Total	\$ 142.50

To B. H. Stinemetz

April 18	
2 Silk Hats for Coachmen at \$8.00 each	\$ 16.00

Mourning bands for same . . .	1.00
1 Silk Hat for Captain Robert Lincoln	10.00
Mourning band for same75

April 21

1 Blk felt Hat for Tad Lincoln	4.50
Mourning Band for same50

To Elizabeth Kickey.

To Services of first Class Nurse & Attendant on Mrs. Lincoln from April 14th to May 26th 1865, 6 weeks at \$35.00 per week	\$ 210.00
Traveling & incidental expense in attending Mrs. Lincoln to her home in Chicago, Ill. & return trip to Washington, D.C.	100.00
Amount expended in requisite mourning apparel	50.00
Total	\$ 360.00

All Genereal expense and moneys set forth by the Commissioner of Public Buildings for the Late President of the United States (Abraham Lincoln) **\$8,580.15**

Bill Paid in Full



WITH THIS NEWEST BOOK

In plain language and with over 50 illustrations and photos, you are shown the methods that years of experience have proven the easiest, fastest, most practical and efficient.

Even with no previous experience you will be able to build a good stair the first time. It gives complete, detailed, easy-to-follow instructions on how to lay out, cut and build a more perfect stair. It shows the basic construction methods of all types, including winder and circular stairs.

This is the most complete book on stair construction published in the past 30 years. Increase your skill and self-confidence now. It saves its cost on the first stair built.

Satisfaction Guaranteed

\$3.50 Postpaid. Washington State residents add 18c tax. For air mail shipment add 60c extra.

Send \$3.50 money order or check to:

DOUGLAS FUGITT

11347 N.E. 124th St., Kirkland, Wash. 98033

ORDER TODAY

Name
 Address
 City
 State Zip Code

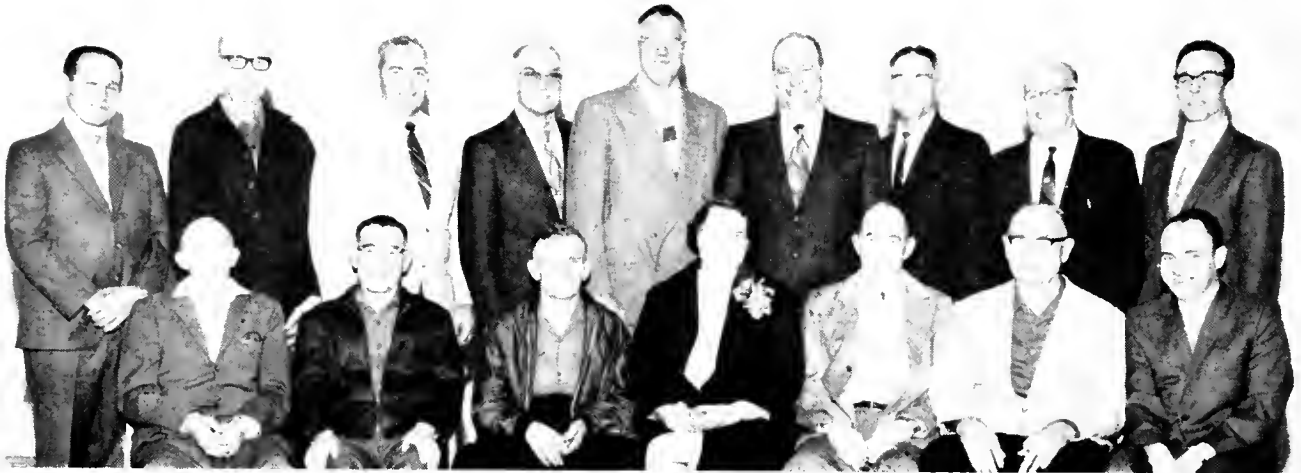

1



Service to the Brotherhood



A gallery of pictures showing some of the senior members of the Brotherhood who recently received 25-year or 50-year service pins.

(1) ROSEBURG, ORE.—A picture was taken Saturday night, December 12, at the "Spouse Night" Party of Local 2949. Members who were given 20 and 25 year pins were photographed. Shown in the picture, back row, left to right: James

Fosback, Albert Fiegun, Stan Cornutt, Charles Smith, Ralph Woods, Charles Bertucci, Alvin Wade, Vernon Welliver and Don Smith; front row: Jim Street, Alex Wolford, Bernard Sjogren, Evelyn Thiele, George Clark, Henry A. Eason and Neal S. Meyer. All of these members won 20-year pins except Bernard Sjogren and Evelyn Thiele who won 25-year pins.

(2) NAPA, CALIF.—At a recent presentation of service awards by Local 2114, Guy Butler, age 88, received the 50-year gold emblem from Clarence Briggs, general officer of the Brotherhood.

Brother Butler is the only living charter member of Local 2114, having joined in 1919 at the age of 37. His wife Bessie was with him when he received his pin. He also was presented with a copy of his original application which listed Bessie as his beneficiary. The couple has been receiving a pension from the United Brotherhood since Guy was 67 years of age, back in 1949.

W. J. Carey, who became a union carpenter for the second time back in 1915, was unable to be present but received a

copy of his original application. Brother Carey, age 82, received his 50-year pin five years ago.

(2A) NAPA, CALIF.—At a recent dinner and awards presentation, more than 100 carpenters and wives turned out to honor

2



2A



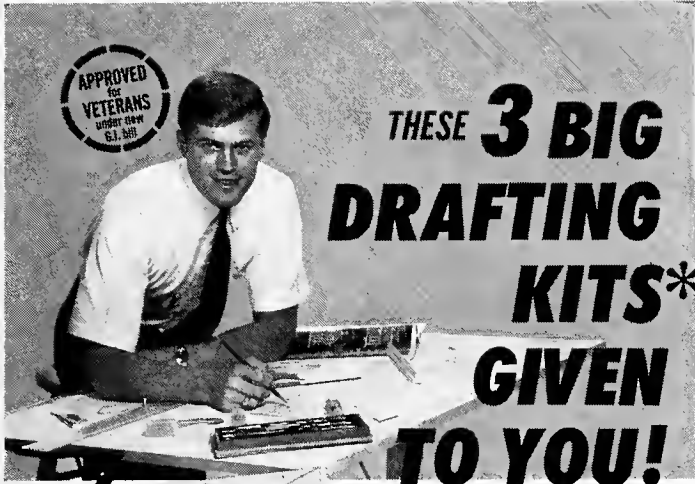

THESE 3 BIG DRAFTING KITS* GIVEN TO YOU!

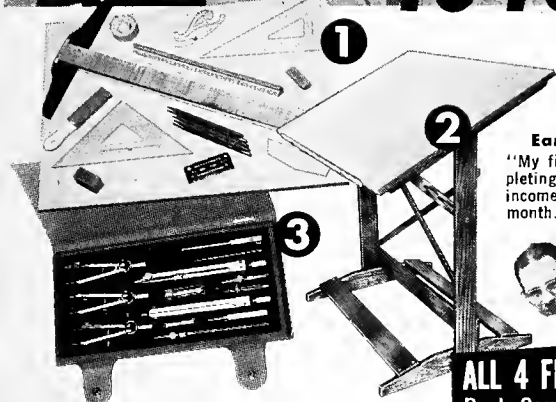

* Precision Drawing Instrument Set, Professional Drafting Board Outfit & Fingertip Tilting Drafting Table are given to you with your complete North American Course in Drafting.

...when you train at home with NASD for a **HIGH PAY JOB IN DRAFTING!**

Earns \$820 Month!
 "My first position after completing your course jumped my income from \$350 to \$820 per month." — G. W., Tenn.



Big Promotion!
 I was promoted from the production line ahead of 4 others and got a good pay raise." — W. A., Wisc.



ALL 4 FREE!
 Rush Coupon today!

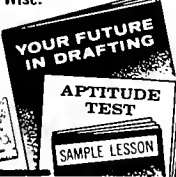

RUSH COUPON FOR FREE KIT...

Mail coupon today for FREE "DRAFTING CAREER KIT," Sample Lesson, Drafting Aptitude Test including intriguing new 5-Way Drafting Instrument & 20-page Book "Your Future in Drafting" — jam-packed with revealing facts on your opportunities to win top pay and job security in Drafting. No salesman will call. Everything sent FREE and WITHOUT OBLIGATION. Write today!

North American School of Drafting, Dept. 11462
 4500 Campus Dr., University Plaza, Newport, Calif. 92660
 Rush "DRAFTING CAREER KIT", including Book, Sample Lesson, Aptitude Test & Drafting Instrument — ALL FREE! No salesman will call. G.I. Approved.

NAME _____ AGE _____
 ADDRESS _____
 CITY _____ STATE _____ ZIP _____

A home study program in association with Cleveland Engineering Inst.

40 recipients of silver or gold emblems in recognition of 25 or more years of service and membership. Clarence Briggs, General Officer of the Brotherhood, presented the awards. Other special guests included Charles Nichols, 9th District Board Member, and Dick Mansfield, legislative advocate, of Sacramento, with their wives; Al Brown, Northern Calif. Apprentice Director; and Buck Cooper, executive officer.

Recipients of the pins were as follows: Left to right, standing: Nello Poli, 30 years; O. L. Carlson, 30 years; Robert Bunjes, 30 years; Albert Kristensen, 30 years; Sherman Perry, 25 years; David Stone, 25 years; John Dyke, 30 years; Ted Jalo, 30 years; C. F. Stark, 25 years; Frank Mayers, 30 years; Ed Momerack, 30 years; James Davis, 25 years; and Joseph Kiefer, 25 years; President L. U. 2114. Seated are: R. C. Sullivan, 25 years; Alden Luntley, 30 years; Joseph Silva, 30 years; Ole Furn, 30 years; Robert Lehman, 40 years; Guy Butler, 50 years; August Fruenhagen, 40 years; Dan Campbell, 25 years; J. G. Jones, 30 years; and N. P. Bartlow, 25 years.

Receiving awards but unable to attend the affair were: James Chadwick, 25 years; Francis DeVita, 25 years; Amos Essary, 25 years; Claymon Kear, 25

years; Leon LaBarge, 25 years; Marvin Ransford, 25 years; David Sasenbery, 25 years; Joseph Ulrich, 25 years; George Gauger, 30 years; E. O. Herrick, 30 years; Lon Jenkins, 30 years; Irwin Krenke, 30 years; Wm. C. McCaimey, 30 years; John Molinari, 30 years; Wilbur Norton, 30 years; and L. Spickelmier, 30 years.

(3) CARMEL and KENT, N.Y.—At a quarterly meeting of Local 1704, last October 14, there was a special presentation of 25 through 50-year pins. Receiving their awards, from left to right, are Eric Peterson 35 years; Charles Bloomer 35 years; Frank Zeller, 45 years; Tony Castellano, 45 years; Frank

Schauffer (president); Clarence Miller, 50 years; Gino Elicati, 30 years. Also honored but not present were Alfred Harpp, 50 years; Harold Greenwood, 25 years; and Carl Linquist, 25 years.

(4) CHICAGO, ILL.—Local 1 held a special meeting, Nov. 11, to honor those members who completed 50 and 25 years of service. The honorees included: First Row, Nick Rausa, 25 years; Peter Skerston, 25 years; Francis Murphy, 25 years; Edward P. Carlson, 50 years; Ralph Nelson, 25 years; Joseph Canibano, 25 years; William Reimann, 25 years; Rudolph Pape, 25 years. Second Row, William J. Sanders, 25 years; M. W.

Continued on Page 32





4

Service to the Brotherhood

Continued from Page 31

Stavrum, 25 years; John Vanderpool, 25 years; Otto Prim, 25 years; Bertil A. Anderson, 25 years; Frank Albert, 25 years; Lambert H. Mueller, 25 years; George Gibson, 25 years; Charles Light, 25 years. Top Row, August Vollmer, vice president; Kenneth J. Kinney, Recording secretary; Earl W. McLennan, president; Richard Garnett, financial secretary-treasurer; John J. Dillon, treasurer; W. S. Jewell; Joseph Kash, 25 years; Robert Borvansky, 25 years; and Rudolph Vanderley, 25 years.

(5) DENVER, COLO.—These were the honorees at a recent dinner of Local 55. Top Row, 25-year pins, Al Dinges, Fred Weber, Oscar Debose, Edward Nelson, Adam Lamb, Arthur Chonry, Benny Jahnke, Chris Romero, Sam Befus, Robert Peterson and Frank Dickerson. Middle Row, All 25-year pins, except George Peterson (60-year pin), Robert England (65-year pin), and Lonnie Nigh (50-year pin). Leon Green, Board Member of the 5th District, R. L. Whittemore, Russell Graham, Charles Elder, George Peterson, Robert England, Lonnie Nigh, Acie Chance, Henry Boschert and Harry Howell. Bottom Row, James A. McFarland, president of Local 55, Wilbur

Waneka, Robert Rieley, Thomas Hammon, Carl Bleifeld, A. J. Kirkgaard, and Raymond Olson, Financial secretary of Local 55.

(5A) DENVER, COLO.—Leon Green, Executive Board Member, 5th District; George Peterson, 60-year member; Robert England, 65-year member; Lonnie Nigh, 50-year member; and James A. McFarland, president of Local 55.

(5B) DENVER, COLO.—Raymond Olson, financial secretary, and Labon Ryan, conductor of Local 55 presented their oldest member of 99 years of age his 65-year pin at his home as he was unable to attend the award dinner.

5



5A

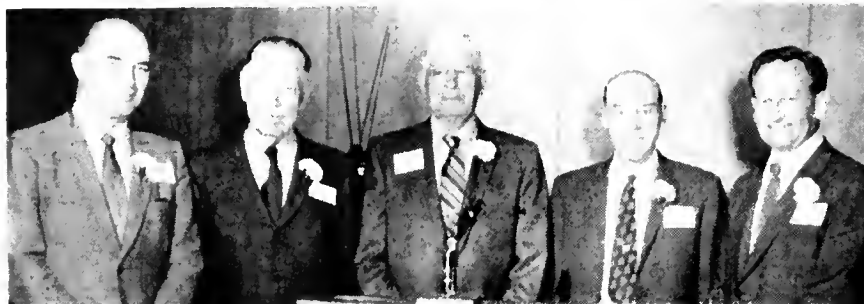

5B



You'll Like Being a SKILLED LOCKSMITH

You'll EARN MORE, LIVE BETTER
than Ever Before in Your Life

You'll enjoy your work as a Locksmith because it is more fascinating than a hobby—and highly paid besides! You'll go on enjoying the fascinating work, year after year, in good times or bad because you'll be the man in demand in an evergrowing field offering big pay jobs, big profits as your own boss. What more could you ask!

Train at Home—Earn Extra \$\$\$\$
Right Away!

All this can be yours FAST regardless of age, education, minor physical handicaps. Job enjoyment and earnings begin AT ONCE as you quickly, easily learn to CASII IN on all kinds of locksmithing jobs. All keys, locks, parts, picks, special tools and equipment come with the course at no extra charge. Licensed experts guide you to success.

Illustrated Book, Sample Lesson
Pages FREE

Locksmithing Institute graduates now earning, enjoying life more everywhere. You can, too. Coupon brings exciting facts from only school of its kind Lic. by N. J. State Dept. of Ed., Accredited Member, Natl. Home Study Council, Approved for Veteran Training.

LOCKSMITHING INSTITUTE

Div. of Singer Communications Corp.
Dept. 1118-021 Little Falls, N. J. 07424



Earned \$150 During Training
I realized with LOCKSMITHING I'd be able to double my income. During my training period I made \$150.
Paul Funes
New York, N.Y.



LOCKSMITHING INSTITUTE, Dept. 1118-021
Little Falls, New Jersey 07424 Est. 1948

Please send FREE illustrated Book—"Your Big Opportunities in Locksmithing," complete Equipment folder and sample lesson pages—FREE of all obligation—(no salesman will call).

Name..... (Please Print)

Address.....

City..... State..... Zip.....

Check here if Eligible for Veteran Training



FOR 25 YEARS
THE WORLD'S
MOST NEEDED GIFT

Give to help people:
CARE-New York, N.Y. 10016
or your nearest office

The year 1971 marks a milestone in CARE service: 25 years ago, the first CARE food packages were delivered in Europe, to help save millions from starvation after World War II. To make CARE possible, 41,250,000 Americans and Canadians have contributed a cumulative total of approximately \$282 million. Their concern has enabled CARE to enlist host government contributions and U.S. donations of farm abundance, for an overall total of more than \$1¼ billion worth of assistance to the needy in 73 countries.

To every donor who is part of this anniversary record, on behalf of those who have been helped, CARE says "thank you."

Job Safety Bill

Continued from Page 16

Purpose—The Act provides for the setting and enforcement of nationwide occupational safety and health standards.

Coverage—The Act applies to any business affecting interstate commerce. It is estimated that the Act will cover approximately 57 million wage earners in 4.1 million establishments.

Effective Date—This Act is effective 120 days after signing by the President.

Standard-setting—The Act establishes a procedure whereby the Secretary of Labor sets safety and health standards with the assistance of advisory committees where appropriate. Any interested person is afforded an opportunity to present his views in this proceeding.

Employer Duty—Employers must comply with specific standards set by the Secretary of Labor. In addition, the Act contains a "general duty" provision requiring employers to furnish a place of employment free from recognized hazards causing or likely to cause death or serious physical harm to employees.

Inspections—A labor or a management representative or both may accompany a Federal official on an inspection of a factory. When an employee representative reports a violation of a standard and the Labor Secretary finds such violation likely a special investigation can be ordered.

Enforcement—The Secretary of Labor will conduct investigations to determine employer compliance with safety and health standards. Where a violation of the standards is found, the Secretary will issue a citation to the employer specifying the violation and giving a reasonable period to correct the violation. If the employer desires to contest the Secretary's findings, he may do so by means of an appeal to the Occupational Safety and Health Review Commission which will cause an administrative proceeding to be held to determine whether the employer has violated the standards; the final judgment of the Commission being appealable to a Federal Court of Appeals.

The Real Pros demand Lee

Designed by Carpenters
Especially for Carpenters

There's plenty of comfort, convenience and work-saving features in these overalls. Made just like you want 'em... because they're designed by workers like yourself. Guaranteed to be the best you've ever worn or we'll take 'em back. No questions asked.

Lee® UNION MADE
M.R. CARPENTERS'
OVERALLS

H. D. LEE COMPANY, INC.
SHAWNEE MISSION, KANSAS 66201
"World's largest manufacturer of
union-made workwear."



Penalties—The bill provides for civil penalties for violation of a standard and a criminal penalty—a fine up to \$10,000 and up to six months imprisonment or both—is provided where there is a willful violation which results in death.

Other Provisions—The Act provides for rapid court procedures to remedy conditions or practices which constitute an imminent danger to the safety and health of employees.

In addition, the bill authorizes the states, after submission and approval of a state plan, to assume responsibility for the development and enforcement of standards. It requires the heads of all Federal agencies to establish and maintain safety and health programs consistent with standards issued under the Act.

It provides for the conduct of research; the establishment of a National Institute on Occupational Safety and Health; the establishment of a National Commission on State Workmen's Compensation Laws; and the provision of economic assistance to small businesses to better enable them to comply with the Act.

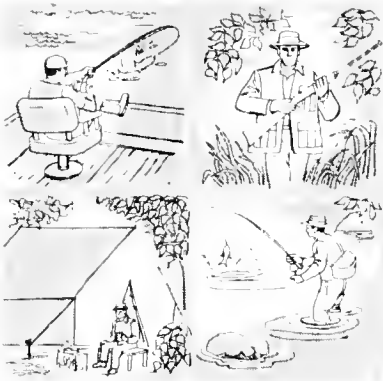

Outdoor Meanderings

Readers may write to
Fred Goetz
 2833 S. E. 33rd Place,
 Portland, Oregon 97202

Fishing Reports, Coast to Coast

■ Vancouver Salmon



Kulovitz and brother.

Some of the best salmon fishing I've ever experienced took place a few years ago in the briny depths off Vancouver Island, B.C. My trip was called to mind by a recent note and snapshot sent in by Bruce Robson, business representative of Local 1541 Floorlayers of the U.B.C.J.A. Here's a snapshot of fellow member Julius Kulovitz of Vancouver, holding a 47-lb. Chinook salmon he caught in Cowichan Bay off Vancouver Island this past September. Looking on in envy is Julius' brother Frank.

■ California Catch

From time to time we've gone on in these columns about the wonderful salmon fishing which prevails in Washington, Oregon, British Columbia, Alaska, and more recently in the Great Lakes and have, perhaps, overlooked the fact that, at certain times of the year, equally good salmon fishing prevails in the waters off the California coast. We therefore call attention to the accompanying photograph sent in by Bill Conkie of San Francisco, longtime member of Local 2164. Brother Conkie is depicted (in dark sweater) with his 33 pound Chinook which won the "pool" on recent charter boat junket to waters off his home town.



Bill Conkie and Group.

■ Largest Bluefish



Joel McRae and Admirers.

Largest bluefish catch ever recorded in these columns can be credited to Joel McRae of Hopewell, Virginia, a member of Millwright Local 1402, Richmond. We're indebted to Thomas R. Smith, financial secretary of that local, for noting that McRae eased a "blue" off the coast of Virginia near Virginia Beach which weighed 16-lbs., 5-ozs. He sent in the accompanying snapshot of McRae, and young admirers, with his catch, which earned a citation when entered in the Virginia Salt Water Fishing Tournament.

■ Spent powder:

... Avid deer-hunting duo is Glenn Solum of Gurnee, Illinois, a member of Local 448, Waukegan, Illinois and his son. Here's a pic of the pair with two sizable bucks they nailed in the wild-woods north of Hayward, Wisconsin. Largest of two deer was a 12-point buck which field dressed close to 200 pounds.



... Recent note from Erich Herrmann of Local 255, Miami Beach, Florida, calls attention to a four-point buck downed by friend Russell Grande in the south Florida Everglades. It was nailed with one shot from .308 Winchester, a running shot at 90 yards.

... According to information from Mrs. H. Miller Sr. of Pleasanton, California, wife of Carpenter Hollis Miller, a member of Local 1622, her husband, friend Bob Adams, also a member of Local 1622 and their hunt partner Tom Brewer, really hit the hunter's jackpot last hunt season near Elk City, Idaho. Brother Miller nailed a bull elk which dressed out at 350 lbs., a whitetail buck at 155 lbs. and a mulie buck at 165 lbs. Adams accounted for an elk which dressed close to 400 lbs., and two chunky mule deer. Brewer downed the heaviest animals on the hunt—a bull elk which tipped the scales at 700 lbs. and a mule deer close to 280 lbs. The big elk rack had 13 points, the mulie 17 points and a 32-inch antler spread. Here's proof of the tale: Hollis and Adams with their bag and Brewer with that rocking-chair elk rack.

... Judging from letter and photograph (too faint to reproduce) the rabbit hunting 40 miles south of Columbus, Ohio, must be out of this world. H. W.



Carpenters Miller and Adams with Idaho take of elk and deer.

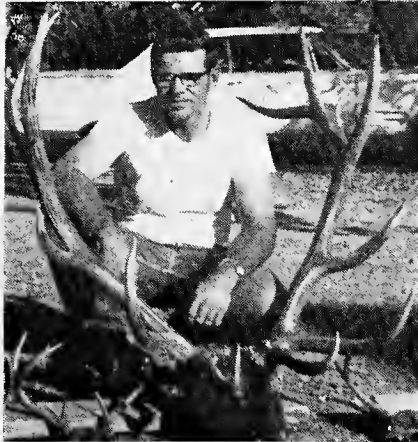

Tom Brewer with his monstrous elk rack.

Kellenbarger, brother (both members of Local 200) and dad (since deceased), and two brothers-in-law bagged 32 of the bunnies on the opening day of the season; 23 the following day and that's a lot of rabbit stew in any man's hunt country.

... "It's called Trout Lake and located in the wonderful fishing country of Ontario, Canada, but there's other big fish in the lake." says Art Leffier of Plymouth, Michigan, a member of Local 982. He sends in the following photo of his buddy who made the trip with him to Trout Lake—Tom Yest, also a member of Local 982, holding a 20-lb. northern from the fish-lush waters. Art was close with a 19-lb. northern.



Tom Yest displays 20-pound Northern.

■ Bear Gets Deer, But . . .

Mrs. B. F. Rowe Jr. of Front Royal, Virginia, passes on an unusual hunt tale involving her husband Ben, a member of Local 1665, Alexandria. Ben was on stand the first morning of the hunt season, high in Virginia's mountain country. His quiet vigilance was rewarded with the sight of a deer, but one being dragged by a black bear. The deer was already a "goner" but not the bear, so Ben brought it down with one well-aimed shot. The story made the sport section of the local newspaper. Bruin tipped the scales at 275 pounds and after being dressed out provided the Rowe family with trophy mount and rug. (Mrs. Rowe comes from a family of Carpenters, her grandfather W. E. Sealock Sr.; father W. E. Sealock Jr., a member of Local 2033 and her uncle Earnest Balderson, a member of Local 1665, Alexandria, Va.)

STEEL PROTECTION FOR TOOLS AND MATERIALS

Protect your investment in tools and materials with KNAACK®, the contractor's complete source for quality chests

and benches. On-the-job or in the shop, KNAACK® steel chests keep out weather—and pilferers.



KNAACK® STORAGEMASTER®

America's most popular chest is now completely redesigned and available in a brand new 49 cu. ft. model that's 60" wide. Specify Model 89. **\$16900**

- Special hinged cover eliminates weather leaks
- New bar handles for comfortable grip, maximum leverage
- Rain gutter eliminates leakage, provides safety stop for cover
- Steel skids protect chest — permit easy lift truck movement
- Exclusive KNAACK® WATCHMAN® lock system makes it virtually impossible to force or cut open padlock

KNAACK® JOBMASTER®

King of the contractor's box type chests, Jobmaster 60 features 20 cu. ft. of steel protection for tools and material. KNAACK'S full line of Jobmaster chests offers six separate models.

- Exclusive KNAACK® WATCHMAN® lock system makes it virtually impossible to force or cut open padlock
- New bar handles for comfortable grip, maximum leverage
- Supports that lock cover open
- Full length piano hinge
- Rugged steel skids protect chest — permit easy lift truck movement
- Carton packaging to prevent in-shipment damage



ASK FOR



KNAACK MANUFACTURING COMPANY
420 East Terra Cotta Avenue, Crystal Lake, Illinois 60014
815/459-6020

Write for free 1970 catalog. Wholesale inquiries invited. (Prices shown are F.O.B.)





IN MEMORIAM

L.U. NO. 1 CHICAGO, ILL.

Aneste Angelo S.
Cramer, Harry W.
Feuerstein, Joseph M.
Foelsch, Arthur
Hegstrom, Ferdinand
Kuhnle, Johannes
Lessner, Earl
Peterman, William
Pligge, Manfred
Schwandt, Grover W.
Wiborg, Fred

L.U. NO. 12 SYRACUSE, N. Y. Buettgens, Fred Switts, Roy Tucci, Donato

L.U. NO. 14 SAN ANTONIO, TEX.

Aguilar, E. J.
Bargsley, R. E.
Brown, William M.
Connelly, J. W.
Cresswell, W. W.
Digges, Edward C.
Gooden, Hugh A.
Isam, Roy E.
Johnson, Bert
Kelley, George R., Jr.
Kelly, John H.
Leasman, A. A.
Lock, William G.
Luddeke, Freddie E.
McEnery, Bill G. J.
McKinnon, W. B.
Mackey, John H.
Meginnis, D. K.
Mosely, W. H.
Murrey, J. F.
Otto, Alfred

L.U. NO. 15 HACKENSACK, N. J.

Erichsen, Henry
Spinosa, Charles

L.U. NO. 21 CHICAGO, ILL. Marchand, Wilbert E.

L.U. NO. 35 SAN RAFAEL, CALIF.

Addenin, A.
Licatovich, Alex S.
Lowry, Roy
Hasbrouck, George

L.U. NO. 36 OAKLAND, CALIF.

Campbell, P. D.
Holladay, Dewell
Johnson, Melvin W.

L.U. NO. 40 BOSTON, MASS.

Daneault, Ronald
Gagnon, Pierre
Spencer, William
Touchette, Aime

L.U. NO. 51 BOSTON, MASS.

Bossi, Charles
Hardy, John M.

L.U. NO. 55 DENVER, COLO. Buller, Frank

Harwardt, Jacob
Wulff, James

L.U. NO. 89 MOBILE, ALA. Howell, L. O.

L.U. NO. 93 OTTAWA, ONT.

Beaudry, Arthur
Boileau, Leo
Farmer, Fred

L.U. NO. 101 BALTIMORE, MD.

Kuliek, Frederick
Rainier, William B.
Thorp, Reidar S.

L.U. NO. 103 BIRMINGHAM, ALA.

Fine, W. A.
Lanier, Sam B.
Lofton, Pat
Martin, Jim D.
Simpson, A. D.
Thompson, George Lee

L.U. NO. 109 SHEFFIELD, ALA.

Holden, Will
Woodruff, Joe T.
Yarbrough, J. F.

L.U. NO. 131 SEATTLE, WASH.

Bergstrom, Carl
Boyle, Ernest E.
Carlson, John A.
Carson, Louis, S.
Combs, Delbert V.
Dillehay, Lyle S.
Eblers, Charles R.
Eschbach, Franklin J.
Firby, Robert J.
Granberg, August
Hohn, Erick
Homer, J. C.
Kompas, Anton
Kukkonen, Emil
Lagerquist, J. Clarence
Leonard, Charles H.
Lirhus, Knute
Lundstrom, Axel
McCarthy, Joseph L.
McConbe, L. F.
McKee, Thomas C.
Marchant, Charles
Naes, Arvid
Nelson, Gustav
Nokleberg, Jacob
Ohlson, John A.
Owen, Fred J.
Pearson, Arvid
Peterson, E. A.
Peterson, Martin
Porter, William J.
Rasmusson, John C.
Sagdabl, John M.
Schroder, William L.
Selin, John
Shell, David T.
Soderquist, Ole A.
Verland, Martin
Widell, Thor F.

L.U. NO. 132 WASHINGTON, D.C.

Disney, Roland
Metz, Powell M.

Meyerhoffer, J. E.
Myers, Charles E., Sr.
Napier, Leslie

L.U. NO. 133 TERRE HAUTE, IND.

Dillingham, Virgil
Miller, Clarence
Volker, Stewart W.

L.U. NO. 135 NEW YORK, N. Y.

Block, Harry
Chmarzewski, Stanley
Chytilo, Joseph
DeAngelis, James
Ewansky, William
Goldman, Hyman
Greer, John N.
Gross, Mayer
Mallin, Walter
Runsten, Arthur
Rizzo, Matteo
Schorr, Leon
Siporin, Sam
Suska, Sigmund I.
Weil, Theodore
Wolf, David

L.U. NO. 176 NEWPORT, R. I. Denicourt, Charles B.

L.U. NO. 181 CHICAGO, ILL.

Jacobsen, John S.
Johnson, Axel

L.U. NO. 188 YONKERS, N. Y. Tacket, Gordon W.

L.U. NO. 200 COLUMBUS, OHIO

Archer, Terry
Bush, Herbert
Crane, Nathan
McCalla, Glenn
Moore, E. H.

L.U. NO. 225 ATLANTA, GA.

Anderson, Joseph E.
Bonner, Floyd Ray
Bray, H. O.
Brown, Henry R.
Bryan, John T.
Cater, John D.
Chapman, J. W.
Cole, Ralph T.
Conner, Lynwood R.
Darby, J. Don
Findley, Willie L.
Gosnell, Ralph L.
Grooms, Donald
Hendrix, James W.
Henson, Harvey
Hippensteal, A. C.
Johnson, G. F.
Kellogg, W. W.
Kobbervig, D. K.
Lancaster, H. A.
Leming, Frank C.
Lisle, Hubert W.
Mathis, L. L.
Ramsey, R. J.
Rawlins, Carter T.
Scoggins, Hoyle
Skinner, Charlie

Smith, Melvin M.
Starnes, Thomas C.
Thomas, Marion H.
Treadwell, Elmer L.
Vining, J. Oliver, Sr.
Waldrop, F. W.
Whitfield, Dorris E.
Wolfe, W. F.

L.U. NO. 230 PITTSBURGH, PA.

Vickless, Martin

L.U. NO. 232 FORT WAYNE, IND.

Bailer, Walt
Burford, W. E.
DeLong, Wayne, Sr.
Dirr, Roy
Dyer, Robert, Jr.
Edgar, Roy
Elliott, James B.
Greenler, William
Hines, John W.
Hostettler, Ivan
Johnston, William
Languell, Ray, Sr.
Lantz, Abner
McGuire, James T.
Meyer, Raymond E.
Miles, Levi
Mitzner, Jack
Morningstar, Wayne
Murphy, Robert
Nyberg, Robert
Pyle, Robert
Shannon, Charles
Sims, James O.
Stout, Bob

L.U. NO. 246 NEW YORK, N. Y.

Barbieri, Salvatore
Bergna, Henry
Ederer, Martin
Lange, Henry

L.U. NO. 257 NEW YORK, N. Y.

Beck, Linnart
Parssinen, Antti
Swanson, Leif

L.U. NO. 264 MILWAUKEE, WISC.

Bohlmann, Arthur F.
Eggebrecht, Herman H.
Frasheski, Stephen S.
Guth, Raymond
Kegler, John E.
Neuzerling, Theodore
Winkle, Joseph

L.U. NO. 266 STOCKTON, CALIF.

Huffman, Hilton
Santana, Joseph

L.U. NO. 281 BINGHAMTON, N. Y.

Houseknecht, Howard

L.U. NO. 301 NEWBURGH, N. Y.

Todd, William J.

L.U. NO. 355 BUFFALO, N. Y.

Feiner, Andrew
Lippke, Walter
Winkelman, August

L.U. NO. 359 PHILADELPHIA, PA.

Marks, A. Edward
Miller, Edward W.
Ott, Fred E., Jr.
Strobel, Ludwig
Thompson, Frederick

L.U. NO. 362 PUEBLO, COLO.

Shaull, G. N. (Bruce)

L.U. NO. 366 NEW YORK, N. Y.

Marx, Meyer
DeSantis, Donato

L.U. NO. 422 NEW BRIGHTON, PA.

Gibson, Earl
Sinclair, Stewart
Staub, Charles

L.U. NO. 434 CHICAGO, ILL.

Antonnucci, Peter
Bagdanas, William
Biewenga, Harry
Bochmann, Harry O.
Burmaster, John
Chesier, Charles
Cimaroli, Vincent J.
Deganhart, Donald
DeRuiter, Harry
DeVries, Jacob
Ellement, Peter
Fraecaro, Victor
Geerling, Philip
Greer, Elder
Grotto, Marcello
Hirtz, John
Jackman, Robert
Kott, Henry
Lundin, Fred
McCasland, Lawrence
Mazanik, Gust
Peterson, Fred
Peterson, Oscar
Schroeder, Martin
Slebos, Fred
Taylor, Robert
Tegalaar, Fred
Torgenson, Thomas
Vellenga, Harry, Jr.
Wilcox, Robert
Zelinski, Charles

L.U. NO. 436 NEW ALBANY, IND.

Dunn, Charles

L.U. NO. 438 MOBILE, ALA.

Bobinger, Samuel C.

L.U. NO. 488 NEW YORK, N. Y.

Kingston, Adolph
Novack, Joseph

L.U. NO. 543 MAMARONECK, N. Y.

Castiglia, Fred
DeLalla, Nicholas
Johnson, Emil
Landry, Patrick
Nesci, Peter
Roberto, Ralph
Trama, James
Turso, Leonard

**L.U. NO. 562
EVERETT, WASH.**
Harvey, Clarence Fay
Martineau, Louis A.

**L.U. NO. 674
MT. CLEMENTS, MICH.**
Rugamer, Philip

**L.U. NO. 678
DUBUQUE, IOWA**

Akins, Clifford
Hamblin, Leo W.
Hammerand, Martin
Latenser, Walter
Lundin, Roger
Nelson, Joseph
Rubner, Henry
Then, Francis

**L.U. NO. 688
PALO ALTO, CALIF.**

Davidson, Jack D.
East, Merlyn E.
Light, Edwin E.
Wagner, Merle L.

**L.U. NO. 750
UNCTION CITY, KANS.**

Bachmann, Adam

**L.U. NO. 787
NEW YORK, N. Y.**

Solaas, Stanley O.

**L.U. NO. 791
NEW YORK, N. Y.**

Egenes, Joseph
Gordh, Fred
Hornes, Lars
Veneche, Stanley
Zagrodnik, William

**L.U. NO. 849
MANITOWOC, WISC.**

Jacobsen, Herman
Pieschel, George

**L.U. NO. 916
AURORA, ILL.**

Kennedy, Edmund

**L.U. NO. 937
DUBUQUE, IOWA**

Courtade, John
Sweeney, Louis

**L.U. NO. 944
SAN BERNARDINO,
CALIF.**

Brooks, Barnett J.
Carlisle, Thomas R.
Douglas, George S.
Elledge, J. D.
Hunter, Floyd
Langley, Ike
Langley, Kenneth
Mattingly, Vincent
Monninger, John
Nicola, J. S., Jr.
Smith, Floyd
Smith, William H.
Turnbow, Jack
Vastine, Harry
Wilbur, Wayne L.
Wyman, Frank E., Jr.
Young, Robert H.

**L.U. NO. 982
DETROIT, MICH.**

Fuller, Lloyd
Hancy, Elliott
Kellogg, John

**L.U. NO. 1035
TAUNTON, MASS.**

Brouillette, Gilbert R.
Machado, Wayne C.

**L.U. NO. 1042
PLATTSBURGH, N.Y.**

Brewster, Floyd
Jackson, Philip
Mitchell, Harold
Rabideau, Harry

**L.U. NO. 1143
LA CROSSE, WISC.**

Capzlewski, Al
Dahl, Palmer
Nelson, Hillman F.
Sevc, Wencel
Veum, T. C.

**L.U. NO. 1172
BILLINGS, MONT.**

Ball, A. J.
Herranen, Otto

**L.U. NO. 1185
CHICAGO, ILL.**

Kaminski, Chester E.
Pauls, William C.

Wilks, Harry H.

**L.U. NO. 1195
SEATTLE, WASH.**

Miller, Leonard C.
Moore, J. C.
Prather, Harvey L.
Rasmussen, Walter P.

**L.U. NO. 1235
MODESTO, CALIF.**

Marsh, Carl H.

**L.U. NO. 1243
FAIRBANKS, ALASKA**

Harmon, Sam
Hurselman, Bernard
Lear, Paul
Tillberg, Olov
Wittleton, Norman

**L.U. NO. 1277
BEND, ORE.**

Clark, Robert J.
Davis, Harold K.
Glenz, Dan L.
Lantzer, William H.
Nelson, Henry C.
Rutledge, Paul E.

**L.U. NO. 1332
GRAND COULEE,
WASH.**

Ashcroft, A. O.

**L.U. NO. 1335
WILMINGTON, CALIF.**

Mosby, Eisha E.
Zaninovich, George

**L.U. NO. 1367
CHICAGO, ILL.**

Emanuelson, Fred
Lubkin, Carl
Swensen, Martin

**L.U. NO. 1397
NORTH HEMPSTEAD,
N. Y.**

Krizek, Edwin J.
Masone, Damiano

**L.U. NO. 1423
CORPUS CHRISTI, TEX.**

Beard, Johnny
Case, Jack
Rosas, Mannel

**L.U. NO. 1426
ELYRIA, OHIO**
Nicol, Dave

**L.U. NO. 1433
DETROIT, MICH.**

Allen, Gerald L.
Biagini, Evio
Giles, Fred
Proctor, Stuart
Zemetis, William

**L.U. NO. 1456
NEW YORK, N. Y.**

Barmen, Karl
Brady, John
Dalane, Syvert
Frain, Thomas
Groll, Camillo
Hendrickson, Frank
Johnson, Charles
Johnson, Frank
Knipfelberg, Harold
Larsen, Lars Martin
Lindberg, Arthur
Malandro, Rocco
Pedersen, Robert
Thorsen, Chris
Torbjornsen, Johannes
Underland, Ingolv

**L.U. NO. 1541
VANCOUVER, B. C.**

Miller, Robert

**L.U. NO. 1598
VICTORIA, B. C.**

Chornoby, Roy

**L.U. NO. 1667
BILOXI, MISS.**

Johanson, Eric

**L.U. NO. 1822
FORT WORTH, TEX.**

Cartwright, James A.
Collins, Charles E.

**L.U. NO. 1846
NEW ORLEANS, LA.**

Ahlers, Clarence
Cousins, Neville
Crochet, Leslie
Goutierrez, Norman
Hebert, Placide
Junius, John

Koehl, Charles
McCullogh, William
Miller, Charles C.
Oberling, Herbert
Reeves, Woodrow W.
Stein, Joseph

**L.U. NO. 1849
PASCO, WASH.**

Strege, Roy

**L.U. NO. 1922
CHICAGO, ILL.**

Bader, Arthur
Jeske, Henry
Kosary, Louis
Zwart, Arthur

**L.U. NO. 2018
LAKEWOOD, N. J.**

Clayton, Clifton
Jennings, Kenneth
Layton, William
O'Conne, Anthony
Smerecky, Nicholas

**L.U. NO. 2130
HILLSBORO, ORE.**

Hansen, Harold

**L.U. NO. 2203
ANAHEIM, CALIF.**

Adling, Walter
Hernandez, Joseph
Kingerly, Odell

**L.U. NO. 2436
NEW ORLEANS, LA.**

Tripkovitch, George

**L.U. NO. 2582
MUSKEGON, MICH.**

Schoenmaker, George

**L.U. NO. 2621
COOS BAY, ORE.**

Needham, Robert
Tyberg, Myrtle

**L.U. NO. 2818
MONTICELLO, IND.**

Hardesty, Robert
Lenick, Natalie

**L.U. NO. 3127
NEW YORK, N. Y.**

Kmetz, Andrew, Jr.

Officers of St. Louis District Council



Officers and business representatives of the Carpenters District Council of greater St. Louis are shown following their election and installation at the Council's regular meeting. From left, seated, are Norman Barth, president; Ollie W. Langhorst, executive secretary-treasurer; Carl Reiter, assistant secretary-treasurer; Pleasant Jenkins, coordinator of jurisdiction and research; business representatives Hermann C. Hanke, Ed Thien, Michael J. Heilich and Leonard TerBrock, and Perry Joseph, business manager of the CDC affiliated Carpet, Linoleum, Hardwood and Tile Layers Local 1310. Standing, from left, are George Thornton, CDC vice president; Don Brussel warden; trustees Walter Webb, Harold Hof, and John Morarin Jr.; business representatives Dean Sooter, Bill Field, Leerie Schaper, Larry Daniels and James Watson; Gilbert Clark, president of Local 1310, and Joseph L. Pijnt business representative of Local 1310.

Canadian Report

Continued from Page 19

worked for just 10 months and earned a gross of \$9,360.

Even so, he was better off than the average bricklayer who could earn \$11,100 for a full year but actually worked seven months for a gross yearly income of \$6,541. The plumber who would earn \$11,990 for a full year but worked just 10 months was slightly better off with an actual income of \$9,900, but ornamental iron workers, lathers, painters and sheet metal workers earned somewhat less.

The point of the exercise was made in the headline of the story, "Building wages high—but the layoff's long." One union business agent estimated that only 10 percent of building tradesmen work the year round, and this is in boomtown Toronto.

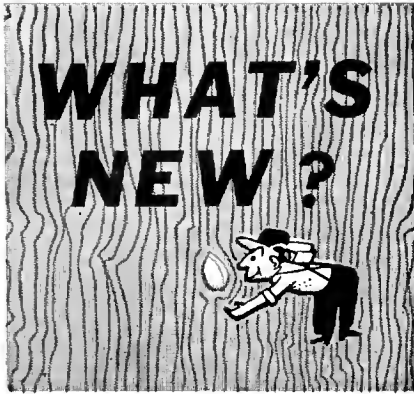

TRUCK MOUNTED LIFT

A hydraulically operated scissors lift mounted to a flat bed truck, shown to be a great time saver in the erection of metal and combination metal and wood buildings, was recently demonstrated in Brookfield, Illinois, by Smith Tool Company, manufacturer of the Mite-E-Lift.

First step in the erection of a building is bolting the stanchions into position. Then a pair of joists are bolted to opposing stanchions, using a single bolt in each. These bolts act as hinges. Next, the truck-mounted lift is used to elevate the joists at the point where they come together to form the arch, accurate within a fraction of an inch. After the joists are raised to the proper elevation, they are bolted together and the opposite ends bolted securely to the stanchions. The Mite-E-Lift is then used to position the stringers which stabilize the skeleton until the final assembly is completed.

The lift is also used to stitch the vertical sides of the building. It has sufficient



load capacity and work area to accommodate two men who control lift operations from the working platform. The lift may be furnished for truck mounting or as a self contained, caster equipped portable unit.

For more information contact Smith Tool Company, 1122 Elizabeth Street, Waukegan, Illinois, 60085.

ONE-MAN LADDER LIFT



A new device that makes loading and unloading long, heavy ladders an easy, time-saving operation that can be done by one man, has been announced by a New York manufacturer.

Made of durable, fabricated steel, Laderak installs on a car or truck top in only 30 minutes. Many superior features include horizontal and vertical rubber rollers, both curb and rear loading, locks easily to prevent theft, fits any truck, can be transferred quickly to other vehicles. For details, call Joseph Kern Jr., at (516) 888-1441 or write: Aines Sales Corp., 1019 North Wellwood Avenue, Lindenhurst, N.Y. 11757.

CIRCULAR SLIDE RULE



A new circular slide rule is comparable in quality to straight slide rules of two or three times the price. Extremely clear, fully-engraved, scales and made from non-warping, non-aging, acrylic materials, it has a cadmium-plated centre screw, removable for easy cleaning, and cursor guide on outside diameter to prevent undesired movement of cursor.

Basically similar in principle to the straight slide rule, it has these advantages:

- The basic scales (C. & D.) are over 30% longer than on a 10" straight slide rule, with consequent widerspacing, increased accuracy, and ease of operation.

- The continuous circular scales eliminate the need for re-setting due to the calculation running off at one end of the scales or the other. The resulting simplification of operation saves time and is also a great help to beginners.

- The continuous log-log scale ranges from 1.010 to 10" and is over 25 inches long. It has a wider range than a straight

slide rule and is particularly easy to operate.

- Also included are square scales (A. & B.), cube scales and scales for sines, cosines, and tangents of angles.

The circular slide rule, 5" in diameter and $\frac{3}{16}$ " thick, comes in a plastic snap-fastener case, with full instructions. Price: \$8.95. Write: Industrial Scientific Instruments, Ltd., P. O. Box 33, Rouses Point, N.Y. 12979.

IDENTIFIED LUMBER

In an effort to help customers avoid potential inventory problems resulting from the changeover to new lumber sizes, Weyerhaeuser Company is making a number of changes in product identification.

"We recognize that the conversion to standards established by PS 20-70 can cause our customers some inventory trouble because many of the old and new sizes are not interchangeable," a company spokesman states.

"The first thing we're going to do is clearly identify the new sizes in red on all grade stamping, edge marking and end branding. Yardmen will be able to spot this new lumber from the old, which is identified in black."

"Also, we'll be re-emphasizing our famous lumber trade mark, 4-Square. This will be printed in red on the edge branding of all Kiln-dry framing."

Weyerhaeuser also indicated that all green dimension lumber shipped in units will carry a vertical red stripe on each unit.

The company's West Coast mills began production of the new grades and sizes in early December.

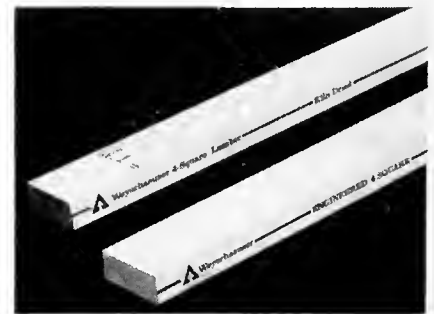

Special identification is being given to all the new size lumber by Weyerhaeuser Company to help customers separate inventories of old and new lumber. The firm is re-emphasizing its 4-Square lumber trademark (shown at top) and will identify all new sizes in red on grade stamping, edge marking and end branding. The old-size lumber (pictured at bottom) was identified with black markings.



The Brotherhood's union label. Look for it when you shop.



Lakeland News

Items of interest from the Brotherhood's retirement home at Lakeland, Florida

Ray Gay of Local 531, St. Petersburg, Fla., arrived at the Home Dec. 10, 1970.

Dominick Mangaglio, Sr. of Local 385, New York, N.Y., arrived at the Home Dec. 11, 1970.

Dixie O'Connor of Local 978, Springfield, Mo., arrived at the Home Dec. 18, 1970.

Charles Calman Homa, of Local 359, Frankford, Pa., arrived at the Home Dec. 21, 1970.

Ralph Wicklund, of Local 2236, Bronx, N.Y. arrived at the Home Dec. 30, 1970.

Oskar Eriksson, of Local 331, Norfolk, Va., died Dec. 3, 1970. Burial was at Virginia Beach, Va.

Patrick Garrity, of Local 1, Chicago, Ill., died Dec. 4, 1970. He was buried in the Home Cemetery.

Otto Busch, of Local 105, Cleveland, Ohio, died Dec. 6, 1970. He was buried in the Home Cemetery.

Arvid Johnson, of Local 58, Chicago, Ill., died Dec. 13, 1970. Burial was in Chicago.

Alcide Grandmont, of Local 32, Springfield, Mass., died Dec. 19, 1970. Burial was in Chicopee, Mass.

Joseph S. Egenes, of Local 791, Brooklyn, N.Y., died Dec. 23, 1970. He was buried in the Home Cemetery.

We Congratulate

Continued from Page 23

Dalton received a Certificate of Meritorious Service, "in recognition of outstanding service to the national apprenticeship program in the interest of the highest standards of craftsmanship." Several top-ranking U.S. government officials signed the award.

Currently, Dalton serves on both local

and state Carpenter Joint Apprenticeship Committees.

In 1965, the Mayor of Cleveland appointed Dalton to the Cleveland Apprenticeship Information Center Advisory Committee. Dalton was responsible for beginning a construction orientation course in the Cleveland public schools. He created a recruiting booklet for construction apprenticeship, and requests for it continue to come from every state. Promoting apprenticeship at the annual home and flower show is also part of his contribution.

This is the third award Dalton has received for his work in the apprenticeship program.

AFL-CIO Had Answer

Continued from Page 13

coordinated long-range planning."

King, who is manager of the Holyoke, Mass. Gas and Electric Department, a municipally-owned utility, suggested that the Northeast should at least follow the pattern of the West Coast with extra high voltage interconnections and full development of power resources in the area. (PAI) ■

INDEX OF ADVERTISERS

Audel, Theodore	23
Belsaw Power Tools	39
Belsaw Sharp-All Co.	23
Chicago Technical College	15
Estwing Manufacturing	17
Foley Manufacturing	27
Goldblatt	22
Hydrolevel	19
Irwin Auger Bit Co.	19
Kant-Slam Door Check Co.	39
Knaack Manufacturing Co.	35
Lee, H. D.	33
Locksmithing Institute	33
North American School of Drafting	31
Stanley Power Tools	Back Cover

\$ 306⁰⁰ PROFIT...FAST!
I Sold 44 KANT-SLAM DOOR CHECKS to Just 4 Customers! Says Segrest of Texas

Join our exceptional men who make big money every day... spare time or full time... with amazing invention

KANT-SLAM 
World's Lowest Priced

HYDRAULIC DOOR CHECK

Here's a year-round lifetime money-making opportunity for you! Thousands of doors in your territory need sensational KANT-SLAM low-priced HYDRAULIC DOOR CHECK that closes large or small doors quickly, smoothly, quietly—prevents heat loss in winter, keeps bugs out and cool conditioned air in during summer. Hundreds of prospects—factories, stores, public buildings, warehouses, institutions, homes, etc. KANT-SLAM operates on controlled hydraulic principle—not an air check—yet costs many dollars less than any other hydraulic door check. **GUARANTEE:** Repair or replacement guaranteed FREE for 3 years (except for shipping charges) by Kant-Slam Door Check Co.

UP TO \$6.50 PROFIT ON EACH UNIT!
Demonstrator Door Supplied at No Cost to Producers

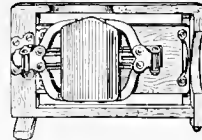

As producer, you get actual KANT-SLAM mounted on easy-to-carry miniature door. Closes sales for you. **FREE!** Mail coupon TODAY for complete money-making details and Demonstrator Offer—free, no obligation.

KANT-SLAM Door Check Co., Dept. B-13
Bloomfield, Indiana 47424
Rush FREE money-making details of Kant-Slam Door Check and no-cost Demonstrator offer.

Name

Address

City..... State..... Zip.....

Agencies in Canada Now Available.

Planer · Molder · Saw!

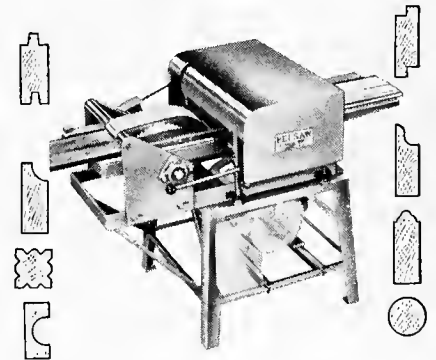

Now you can use this ONE power feed shop to turn rough lumber into high-value moldings, trim, flooring, furniture... ALL popular patterns.

RIP... PLANE... MOLD... separately or all at once by power feed... with a one horsepower motor. Use 3 to 5 HP for high speed commercial output.

LOW COST... You can own this MONEY MAKING POWER TOOL for only... **\$30.00** down.

Send coupon today... No salesman will call

BELSAW POWER TOOLS
941F Field Bldg., Kansas City, Mo. 64111
Send me complete facts on the MULTI-DUTY Power Tool. No obligation.

Name

Address

City..... State..... Zip.....



In Conclusion

M. A. Hutcheson, General President



The Construction Worker Is Still 'Low Man'

■ Late last month, President Nixon subtly served notice on the construction industry that wage increases are going to be much harder to come by henceforth.

At a White House meeting of representatives of the contractors and the building trades unions, he emphasized the point that he was getting pressure from various sources to clamp down on free collective bargaining in the construction industry.

Some of the proposals which he said were recommended to him included: suspension of the Davis-Bacon Act; imposition of wage and price controls; White House monitoring of wage negotiations.

As a participant in the White House meeting, I got the distinct feeling that political considerations outweigh economic ones in the Administration's thinking.

While no one can deny that wage increases in the construction industry have been rather substantial in recent years, the truth of the matter remains that the annual earnings of construction workers still lag considerably behind the earnings of many other groups.

For all the progress that has been made, auto workers, chemical workers, and oil workers, take home larger annual paychecks than the average construction worker. The difference, of course, is represented largely by the lost time which construction workers constantly suffer.

According to Department of Labor figures, the average construction worker puts in only 1200 hours per year. Any advantage in hourly wage rates is more than offset by fewer hours of work per year.

President Nixon placed heavy emphasis on the idea that wage increases in the construction industry are adding considerable fuel to inflation. Yet, as the following table shows, construction workers are actually lagging in take-home pay compared to auto, oil, and chemical workers.

Industry	1964 Annual Earnings	% Increase Hourly Earnings	1970 Annual Earnings
Construction Workers	\$6,579	49.3%	\$ 9,822
Motor Vehicles	7,814	33.0	10,393
Petroleum Refining	8,447	32.3	11,175
Chemical	7,717	33.2	10,279

Obviously, a 10% increase for a construction worker will not pump as much money into the economy as a 10% increase for an auto worker.

Comparing construction wages with another group closely associated with the Presidency—namely, government workers—Department of Labor figures show that Federal workers have fared better than construction workers in the years between 1964 and 1970.

In 1964, a construction worker employed on general building construction earned \$6,579 on the average. A government worker with comparable earnings was a grade 8, who earned \$6,390. By 1970, the average construction worker was making \$9,822, while the grade 8 government worker had jumped to \$10,152.

Stated another way, the construction worker in 1964 earned \$189 more than the grade 8 government worker. In 1970, the construction worker's annual earnings were \$330 less than the government worker's. . . .

All of the figures quoted herein are from Department of Labor publications. In looking at them none of them give any indication that construction wages are a major inflation threat. Furthermore, they show that the wage increases negotiated in our industry did little more than pick up the slack which existed since 1964.

A recent issue of *The Wall Street Journal* reiterated what the Building and Construction Trades have stated repeatedly in recent years: namely, that wages are not the primary cause of higher construction costs.

Unfortunately, the construction industry may once more become a convenient whipping boy, unless we get the true story across to the general public. ■

Working Partners



One out of every four scoutmasters of Boy Scout troops in North America is a union member.

Organized labor has a deep and lasting commitment to Scouting. The spirit of cooperation between trade unions and the Scouting movement spans six decades.

Soon after the youth organization was founded in 1910, the American Federation of Labor made a thorough and far-reaching investigation of its activities and objectives. In November, 1912, the AFL gave the BSA a cordial and encouraging endorsement.

Three former Boy Scouts are members of the AFL-CIO Executive Council. Fourteen became presidents of international unions, and 27 were elected secretary-treasurers of their international unions.

Boys Scouts conduct their annual sustaining membership drives in February. Support their cause. Give financial support and leadership . . . for a better tomorrow.

Scouting can make the difference between a social misfit and a good citizen. Build boypower, and you build manpower!

**SUPER SWITCH
SPEED CONTROL AND
REVERSIBLE**

Stanley now has longer trigger stroke

(over 30% longer for better control of speeds)

Our new "Super-Switch" puts precise control right at your fingertip. Gives you over 30% longer trigger stroke for more control over your speed range (0-1000 RPM) than with conventional speed control drills. And it will outlast the others because it's a switch designed for use in heavy duty applications.

But that's only the beginning. This 3/8" pistol grip reversible speed control workhorse has an oversized fan and cooling system. And a 4 amp rating (none higher in the industry). Four ball bearings deliver the power to the working end of the tool. 3 stages of heat treated precision gearing (most others have two), provide all the torque you need when the drilling gets rough.

Price? \$69.00 – lower than most others charge for single speed heavy duty drills without reverse.

Still looking for reasons to buy our drill? Consider the welded (not soldered) leads to protect against burnout. The removable 3-position auxiliary handle for complete torque control. And new strain relief collar for maximum protection against cord pullout. See your distributor today

or write: Stanley Power Tools,
Division of The Stanley Works,
New Bern, North Carolina 28560.

STANLEY[®]

helps you do things right

P.S. Made by the same Stanley that makes the finest hand tools

**Model 91061
\$69.00**

The

CARPENTER

Official Publication of the UNITED BROTHERHOOD OF CARPENTERS AND JOINERS OF AMERICA • FOUNDED 1881



"The stream is still quiet, and we glide along through a strange, weird, grand region. The landscape everywhere, away from the river, is of rock—cliffs of rock; tables of rock; plateaus of rock; terraces of rock; crags of rock—ten thousand strangely carved forms. . . . In long, gentle curves, the river winds about the rocks.

"When speaking of these rocks, we must not conceive of piles of boulders, or heaps of fragments, but a whole land of naked rock, with giant forms carved on it: cathedral-shaped buttes, towering hundreds or thousands of feet; cliffs that cannot be scaled, and canyon walls that shrink the river into insignificance, with vast, hollow domes, and tall pinnacles, and shafts set on the verge overhead, and all highly colored—buff, gray, red, brown, and chocolate; never lichened; never moss-covered; but bare, and often polished. . . .

"These streams unite in solemn depths, more than one thousand two hundred feet below the general surface of the country. The walls of the lower end of Stillwater Canyon are very beautifully curved, as the river sweeps in its meandering course. The lower end of the canyon through which the Grand comes down is also regular, but much more direct, and we look up this stream, and out into the country beyond, and obtain glimpses of snow-clad peaks, the summits of a group of mountains known as the Sierra La Sal."

—From *The Diary of the First Trip Through the Grand Canyon* by John Wesley Powell, 1869

OFFICIAL INFORMATION



GENERAL OFFICERS OF THE UNITED BROTHERHOOD of CARPENTERS & JOINERS of AMERICA

GENERAL OFFICE:
101 Constitution Ave., N.W.,
Washington, D. C. 20001

GENERAL PRESIDENT

M. A. HUTCHESON
101 Constitution Ave., N.W.,
Washington, D. C. 20001

FIRST GENERAL VICE PRESIDENT

WILLIAM SIDELL
101 Constitution Ave., N.W.,
Washington, D. C. 20001

SECOND GENERAL VICE PRESIDENT

HERBERT C. SKINNER
101 Constitution Ave., N.W.,
Washington, D. C. 20001

GENERAL SECRETARY

R. E. LIVINGSTON
101 Constitution Ave., N.W.,
Washington, D. C. 20001

GENERAL TREASURER

PETER TERZICK
101 Constitution Ave., N.W.,
Washington, D. C. 20001

DISTRICT BOARD MEMBERS

First District, **PATRICK J. CAMPBELL**
130 North Main Street
New City, Rockland Co., New York
10956

Second District, **RALEIGH RAJOPPI**
2 Prospect Place, Springfield, New Jersey
07081

Third District, **CECIL SHUEY**
Route 3, Monticello, Indiana 47960

Fourth District, **HAROLD E. LEWIS**
340 Northwest 148th St.
Miami, Florida 33168

Fifth District, **LEON W. GREENE**
2800 Selkirk Drive
Burnsville, Minn. 55378

Sixth District, **FREDERICK N. BULL**
P.O. Box 14279
Oklahoma City, Okla. 73114

Seventh District, **LYLE J. HILLER**
Room 722, Oregon Nat'l Bldg.
610 S.W. Alder Street
Portland, Oregon 97205

Eighth District, **CHARLES E. NICHOLS**
Forum Building, 9th and K Streets
Sacramento, California 95814

Ninth District, **WILLIAM STEFANOVITCH**
2418 Central Avenue
Windsor, Ontario, Canada

Tenth District, **GEORGE BENGOUGH**
2528 E. 8th Ave., Vancouver 12, B. C.

M. A. HUTCHESON, Chairman
R. E. LIVINGSTON, Secretary

Correspondence for the General Executive Board
should be sent to the General Secretary.



Secretaries, Please Note

If your local union wishes to list deceased members in the "In Memoriam" page of *The Carpenter*, it is necessary that a specific request be directed to the editor.

In processing complaints, the only names which the financial secretary needs to send in are the names of members who are NOT receiving the magazine. In sending in the names of members who are not getting the magazine, the new address forms mailed out with each monthly bill should be used. Please see that the Zip Code of the member is included. When a member clears out of one Local Union into another, his name is automatically dropped from the mail list of the Local Union he cleared out of. Therefore, the secretary of the Union into which he cleared should forward his name to the General Secretary for inclusion on the mail list. Do not forget the Zip Code number. Members who die or are suspended are automatically dropped from the mailing list of *The Carpenter*.

PLEASE KEEP *THE CARPENTER* ADVISED OF YOUR CHANGE OF ADDRESS

PLEASE NOTE: Filling out this coupon and mailing it to the **CARPENTER** only corrects your mailing address for the magazine. It does not advise your own local union of your address change. You must notify your local union by some other method.

This coupon should be mailed to ***THE CARPENTER***,
101 Constitution Ave., N.W., Washington, D. C. 20001

NAME _____ Local No. _____

Number of your Local Union must be given. Otherwise, no action can be taken on your change of address.

NEW ADDRESS _____

City

State

ZIP Code

THE CARPENTER

VOLUME XCI

No. 3

MARCH, 1971

UNITED BROTHERHOOD OF CARPENTERS AND JOINERS OF AMERICA

Peter Terzick, Editor



IN THIS ISSUE

NEWS AND FEATURES

President Nixon Suspends Davis-Bacon Law	2
The Work Goes on at 35 Degrees Below	6
New Tax Rules a Help If You Know Them	9
Constructors, Unions Set Up Uniform Work Rules	12
Plans for Fleetwood Boycott Studied	13
USS Sam Gompers, Navy's Mr. Fixit	14
India's Princes Form Union to Save Purses	17
Do These Members Attend Your Union Meetings?	23
WPA, PWA Put Men Back to Work, Mr. Nixon ... Press Associates	26
1971 CLIC Drive Is Launched	28

DEPARTMENTS

Washington Roundup	5
Canadian Report	Morden Lazarus 18
Service to the Brotherhood	20, 34
Local Union News	22
Plane Gossip	24
Apprenticeship and Training	30
Your Union Dictionary	31
In Memoriam	36
What's New?	38
Lakeland News	39
In Conclusion	M. A. Hutcheson 40

POSTMASTERS, ATTENTION: Change of address cards on Form 3579 should be sent to THE CARPENTER, Carpenters' Building, 101 Constitution Ave., N.W., Washington, D. C. 20001

Published monthly at 810 Rhode Island Ave., N.E., Washington, D. C. 20018, by the United Brotherhood of Carpenters and Joiners of America. Second class postage paid at Washington, D. C. Subscription price: United States and Canada \$2 per year, single copies 20¢ in advance.



Printed in U. S. A.

THE COVER

The Colorado River twists through Stillwater Canyon just above its junction with the Green River and rapidly picks up speed as it moves through eastern Utah into northern Arizona. The canyon walls are steep and the scenery exotic.

In the distance the snowcapped Lasal Mountains remind us that the windy and cold month of March is still with us but that spring is not far behind.

The picture is by the well-known color photographer David Muench and is from H. Armstrong Roberts.

One hundred years ago, ten men in four boats swept down the raging Colorado River on the first trip through the Grand Canyon and the Canyon Country to the north. The expedition was led by Major John Wesley Powell.

On August 30, 1869, 13 weeks after the expedition left Green River Station in Wyoming Territory, the one-armed major, with only two boats and six survivors, emerged from the canyon to find men fishing with nets for their remains.

Powell and his men mapped the Canyon Country and studied its geology and its Indian inhabitants throughout the 1870's. He later helped to establish the U.S. Geological Survey.

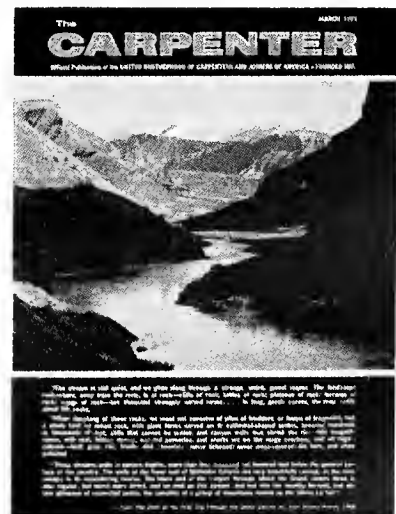

President Nixon Suspends Davis-Bacon Law, Claims 'Emergency Conditions' in Industry

See General President Hutcheson's Response on Page 40

■ President Nixon has suspended the provisions of the Davis-Bacon Act which require that contractors working on Federal construction projects pay the prevailing area wage rates.

His action was taken, the President declared, "on the principle that Government programs which contribute to excessive wage and price increases must be modified or rescinded in periods of inflation."

The suspension of Davis-Bacon means that in all new contracts—about \$25 billion annually—workers will not have the wage protections which they have had since the Act was first passed in 1931.

Called 'Lesser Move'

Secretary of Labor James D. Hodgson said that efforts to get leaders of construction unions to agree to voluntary wage freezes had been unsuccessful and that the President was resorting to this "lesser" move.

Just three days before the President acted, the AFL-CIO Executive Council meeting in Bal Harbour, Florida issued a statement saying that Davis-Bacon "is as important today as it was 40 years ago. Its basic principle, as its effective enforcement, must be maintained. The AFL-CIO will not settle for less."

After the President suspended Davis-Bacon, a spokesman for the AFL-CIO said that the statement still stands. The complete statement follows:

"This year is the 40th anniversary of the Davis-Bacon Act which established the principle that workers employed on Federal Government construction projects should be paid prevailing wages.

"This concept, first written into law in 1931, was extended five years later, in the Walsh-Healey Act, to employees engaged in the production of manufactured goods for the

Government. In 1962, it was established as the basis for setting salaries paid to Federal employees. More recently, the McNamara-O'Hara Service Contract Act further extended this principle to service employees of private contractors engaged in work for the Federal Government.

"This principle of prevailing wages is essential—to assure that work for the Federal Government is not based upon exploitation of workers. Without such requirements, bidding on Federal contracts by unscrupulous employers could result in a competitive undermining of fair wages and labor standards.

"The Davis-Bacon Act is as important today as it was 40 years ago. Its basic principle, as its effective enforcement, must be maintained. The AFL-CIO will not settle for less."

The general presidents of the various craft unions issued a joint statement prior to President Nixon's action which indicates general feeling in the trades regarding wages and collective bargaining. The statement said in part:

Building Trades Comment

"The Executive Council of the Building and Construction Trades Department, AFL-CIO, is heartened by the interest in stabilizing construction bargaining indicated by President Nixon.

"There is no group of individuals in the United States with a greater desire to make collective bargaining work than the officers and the 3.5 million members of the 17 national and international unions affiliated with the Department.

"The free enterprise system is the foundation of their security, their welfare, their very existence as working craftsmen.

"It should be obvious, therefore,

that the Department would enthusiastically support any improvement and strengthening of collective bargaining.

"It also should be obvious that we would vigorously oppose any proposal or procedure that would erode, restrict or endanger collective bargaining.

"There is no question that a wide range of problems confront the construction industry, probably to an extent even greater than the difficulties which face almost all segments of our society in these troublesome but challenging times. They are problems that need solutions structured for long-term benefit, not stop-gap schemes.

Picture Out of Focus

"To achieve meaningful solutions, also requires an examination of the whole picture. For example, wage rates negotiated by Building and construction tradesmen in recent years frequently—perhaps even unintentionally on occasion — have been portrayed out-of-focus.

"Little if any attention has been paid to the fact that a building and construction tradesman averages only 1,200 to 1,400 hours of work a year. At the average \$6.39 an hour paid union building trades workers—as reported by the Bureau of Labor Statistics on Feb. 2, 1971—this does not represent much of a chance for the worker to combat the very inflation some accuse him of being largely responsible for.

"Nor is consideration given to the accelerating cost of a building tradesman in earning a dollar. His work radius often includes hundreds of miles and he must be daily available for work at the site, even on those days or during those periods that his job is down. Moreover, wage rates, in comparison to land cost,

Continued on page 4

'It Is An Open Invitation to Unscrupulous Employers to Exploit Workers ...'

■ AFL-CIO President George Meany, on February 23, issued the following comment following the President's action suspending the Davis-Bacon Law:

The action taken by the President is wrong in principle. It attempts to correct the national economic problem—mass unemployment in a period of inflation—brought about by the unwise monetary and fiscal policies of the President and his economic advisors, by penalizing a single segment of the working population.

It is an open invitation to unscrupulous employers to exploit workers by competitive undermining of fair wages and labor standards. That is an action unworthy of the federal government.

There are five elements in the cost of any building—labor, materials, land, financing and profit.

The President has moved against only one element—the cost of labor. This is decidedly one-sided for the President has done exactly nothing about the fastest rising cost element in construction—the cost of land.

He has not acted against the costs of building materials nor the profits of the employers. Moreover, he has imposed no ceiling on interest rates, thus leaving the important cost of financing in the hands of the money lenders whose profits have been soaring in the past several years.

A whole body of federal and state law—based on the simple and sound proposition that the taxpay-



Meany

ers' money should not be used to exploit workers—is endangered by the President's action. We consider it unfair. We resent it. We think construction workers do not deserve to be treated in an arbitrary, one-sided fashion.

What America needs is full employment at fair wages and decent conditions, not punitive action against workers. The action taken by the President today will have no real effect on halting inflation. ■

TEXT OF PRESIDENT NIXON'S STATEMENT

■ I am today suspending the provisions of the Davis-Bacon Act which require contractors working on Federal construction projects to pay certain prescribed wage rates to their workers. In my judgment, the operation of this law at a time when construction wages and prices are skyrocketing only gives Federal endorsement and encouragement to severe inflationary pressures.

The action I have taken today is based on the principle that government programs which contribute to excessive wage and price increases must be modified or rescinded in periods of inflation. This was the principle I applied to industry in the case of recent excessive increases in steel and oil prices. This is the principle I am applying to organized labor in the construction emergency.

This decision suspends a special provision of law which has applied uniquely to the construction industry since 1931. It puts the construction industry on the same footing with other industries that now sell products to the Government. For under the Davis-Bacon Act, wage rates on Federal projects have been artificially set by this law rather than by customary market forces. Frequently, they have been set to match the highest wages paid on private projects. This means that many of the most inflationary local

wage settlements in the construction industry have automatically been sanctioned and spread through Government contracts.

The Davis-Bacon Act was originally passed in 1931 to ease extremely severe downward pressures on wages in the construction industry. I believe, however, that this preferential arrangement does not serve the best interests



Pres. Nixon

of either the construction industry or the American public at a time when wages are under severe upward pressures. I am therefore using the authority which the law gives to the President to suspend this provision. The proclamation I am issuing today also suspends the wage determination provision of more than 50 other Federal laws relating to Federally-involved construction which incorporate the Davis-Bacon Act. I am calling upon States and other governmental bodies with similar statutes to take similar action.

This action is the most appropriate of the actions which are available to me at this time. Nevertheless, I make

this decision most reluctantly. It has been my hope that the problem of excessive and inflationary wage settlements in the construction industry could be met without such measures. Yet on several occasions over the past two years I have also made it clear that I would take whatever further steps were necessary if the inflationary pattern did not end.

That pattern has not ended. In fact, inflation in the construction industry has grown worse. In 1970, the average contract settlement in the building trades called for a first year wage increase of 18.3 percent.

On the other hand, the average increase for the first year of new contracts in manufacturing industries was 8.1 percent—a striking contrast. And in the last two quarters of 1970, wage settlements in the construction industry went even further out of control; new contract settlements in the last six months of the year called for nearly a 22 percent average first year increase.

While some might wish to blame management or labor unions for this inflationary syndrome, we must recognize that, in fact, they are its victims. I have met with construction contractors and labor leaders on a number of occasions—including a meeting last month. I know that many of them have

been doing their best to find an answer to this situation. It is evident now, however, that decisive government action is needed to protect the public interest while labor and management continue their efforts to attack the causes of this problem.

Those causes are deep and complex. They are rooted in the way the construction industry is organized—and particularly in the highly fragmented nature of its collective bargaining process. A craft-by-craft, city-by-city negotiating pattern makes competition between local unions for higher wages particularly intense. It makes strikes on particular projects more likely since alternative work is often available nearby. One out of every three wage negotiations in the building trades now produces a work stoppage. When these and other structural factors are combined with a law like the Davis-Bacon Act which, in effect, requires employers to pass on to the Government the cost of high local settlements, then the inflationary problem becomes even more acute.

The results of this inflationary situation are felt in every part of our society. As construction costs go up, so does the price for buying or renting new homes and apartments. Because the entire economy is affected by rising construction costs, other prices are driven up also. The taxpayer bears a particularly heavy burden since the Government spends so much for construction. The Federal Government alone plans to spend some \$13 billion for construction in Fiscal Year 1972. A good part of this spending will come from the defense budget — which means that inflation in the construction industry can make it harder adequately to fund programs which are vital to our national security.

All levels of government together account for almost one-third of total construction expenditures. It is crucial, I believe, that taxpayers get their money's worth for all this spending and that it not be used to accommodate — and further accelerate — inflationary pressures.

But the person who is hurt most by this pattern of inflation is the construction worker himself. For as the cost of building increases, the rate of building is slowed—and the result is fewer jobs for the workingman. The rate of unemployment in the construction trades last year was substantially higher than any in other major industry and double the national average. It stood at 11.2 percent this past January. Moreover, those workers who do find jobs also find that as costs rise

and the number of projects declines, they are working fewer hours.

The average worker in the building trades is therefore caught in a vicious cycle. His rate of pay goes up but often his overall income does not, since his opportunities to work have gone down. As a result, he is inclined to demand an ever higher hourly wage which can have the effect, in turn, of further reducing available employment. By curbing inflation in the construction industry, we hope to break this cycle, expand employment and improve the overall position of the construction worker.

During the past two years, this administration has taken a number of steps to help the construction industry. We have made considerable progress in bringing down the cost of money. We have worked to stabilize the cost of materials and to increase productivity. We are planning to expand Federal construction programs—especially in housing—and we are making additional efforts to assist private construction.

We are now on the threshold of a new economic expansion. That expansion must be a genuine expansion, one that is measured by rising purchasing power and not by an accelerating cost of living: by more new homes and apartments, and not by ever-accelerating rents and housing prices; by more new public facilities urgently needed to combat pollution and meet other pressing social needs. We are counting on the construction industry to make a significant contribution to our expanding economy. We have great confidence in the potential of the construction industry and we want this potential to be fully realized.

But the construction industry cannot realize its potential—and it cannot make its full contribution to the stable growth of our entire economy—unless it can overcome its present handicaps of chronic instability, frequent strikes and excessive wage increases. Insofar as the government is a party to these conditions—as it is under the Davis-Bacon Act—it can serve both the public and the industry best by correcting that situation.

I have suspended the Davis-Bacon Act because of emergency conditions in the construction industry. The purpose of the Davis-Bacon Act can once again be realized when construction contractors and labor unions work out solutions to the problems which have created the emergency.

In the final analysis, those who are directly involved in the construction

industry must assume the leadership in finding answers to these complex problems. Construction contractors and labor leaders will have the full cooperation of this administration as they strive to carry out this crucial responsibility. ■

President Suspends

Continued from Page 2

interest charges and the price of materials, have a minimum relationship to the cost of construction. Wages are less than 20 percent in home building and less than one-third in many multi-million dollar projects.

“In the continuing series of consultations initiated by President Nixon being conducted among unions, contractors and the federal government, the General Presidents of the affiliates of the Building and Construction Trades Department have not been asked to give specific answers to specific questions. They have not been advised that any specific plan for stabilizing construction bargaining is in the making or any executive action by President Nixon will be taken.

Union Concern

“But being responsible and responsive Americans, the General Presidents and the individuals they represent do have concern for any national problem, especially a problem in the construction industry, which is so fundamental to their economical and social life and that of their countrymen.

“They also have hopes and beliefs.

“They hope that the total picture, not mere fragments, will be carefully examined before any solutions are attempted.

Unemployment Noted

“They hope that something will be done about joblessness, which almost always is twice as high in the construction industry as in the national average, and at the present time even exceeds that figure.

“They pledge their support of a program or a procedure which is equally fair for all—not restrictive to one group and advantageous to another, not punitive for one and permissive for another, not representative of one and oblivious of another.” ■

WASHINGTON



ROUNDUP

ECONOMY STARTS AT HOME?—Columnist Les Finnegan reminds us that it's almost a year now since Secretary of Housing and Urban Development George Romney announced that he would return 25% of his \$60,000 salary to the government and, in effect, challenged other members of President Nixon's cabinet to follow suit. Since then not a single cabinet member has reduced his own salary by as much as a buck, not even the several millionaires. Romney's original announcement came in a speech on collective bargaining but the other cabinet members decided the question was "non-negotiable."

NUCLEAR PLANT SHUTDOWN SCORED—The AFL-CIO has urged Pres. Nixon to cancel an order that would shut down plutonium production at the Atomic Energy Commission's Hanford, Wash., plant, throw thousands of persons out of work, and threaten the Far West with a power shortage.

The Brotherhood wired President Nixon that it is deeply concerned about the decision to close down Hanford at a time when a power shortage seems imminent in the Northwest, even as the unemployment rate in the area is double the national average.

POVERTY LEVELS INCREASED—A non-farm family of four persons in the continental United States is considered living in poverty if it has an annual income of \$3,800 or less, the Labor Dept. said in announcing it has raised the poverty dividing line about \$200 over last year.

The poverty levels were adjusted in line with increased living costs as a guide in determining eligibility for manpower programs aimed at improving the employability of the poor.

Other new poverty levels by income for various non-farm family sizes are: Seven-person family, \$5,600; six-person family, \$5,000; five-person family, \$4,400; three-person family, \$3,100; two-person family, \$2,500 and single persons, \$1900.

For farm families, poverty-level incomes are \$300 to \$900 less than for non-farm families, depending on family-size.

SOCIAL SECURITY BOOST ASKED—The nation's largest organization of older Americans, the National Council of Senior Citizens, recently urged Congress to raise Social Security 15 per cent immediately and an additional 20 per cent next year.

The group also urged Congress to immediately double the minimum Social Security benefit—now \$64 a month.

NIXON CHARGED ON ELDERLY—President Nixon's recommendations to the current Congress clearly show that "he has turned his back on the Nation's elderly," President Nelson H. Cruickshank of the National Council of Senior Citizens charges.

1970 UNEMPLOYMENT—Man-days lost by unemployment in 1970 were 17 times greater than the loss from strikes, an analysis of Labor Dept. figures shows.

With joblessness averaging over 4 million for the year, the lost man-days of work exceeded a billion. This compared with an estimated 62 million man-days lost due to strikes during 1970.

CONSUMER BILLS—A package of 23 consumer-protection bills has been introduced in the House by 133 Democratic congressmen.

It includes legislation establishing an independent consumer agency and a bill allowing consumers to band together in "class action" suits in federal courts against manufacturers.

THE WORK GOES ON...

AT 35 DEGREES BELOW

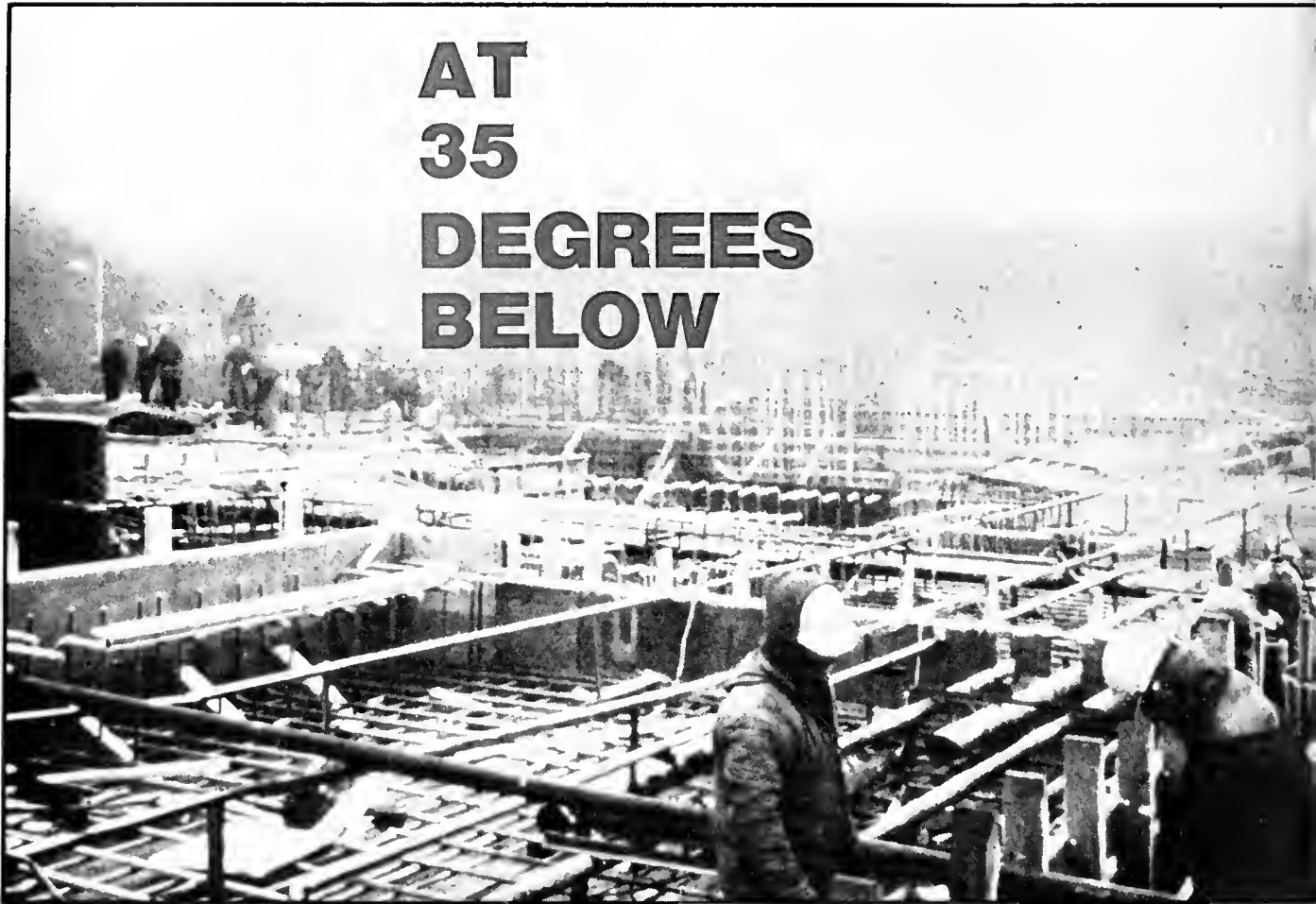

■ The winter winds blow hard and cold across the Northern Great Plains, and, until the winter of 1970, all outside construction work usually stopped.

You couldn't excavate in deep snow; you couldn't pour concrete at low temperatures; you couldn't work when your nose was turning blue.

Now, however, construction workers, have beat Old Man Winter at his severity game at two job sites.

Work continued all winter at Safeguard Missile Defense System sites near Great Falls, Mont., and Grand Forks, N.D., despite the fact that temperatures on occasion dipped to 35 degrees below zero.

The winterization program at these two job sites was aimed at being able to accomplish the con-

crete pours and protecting the concrete.

The first item in the winterization plan was protection of the concrete batch plants. This was accomplished with polyethylene (Styrofoam) and plywood covers. The water and aggregates also received protection and were heated. The trucks transporting the mixed concrete to the pumping and conveyor areas were equipped with insulated drums, and the conveyor and pumping areas were protected.

Winterization for the concrete placements was in increments. For example, when the forms were ready for a placement, the area was inclosed in polyethylene and plywood. During the pour and fresh curing

period, propane space heaters with electric blowers were used to force warm air into the area. Blankets, tarps and hay were used to protect the concrete in the later curing stages.

When the weather became too severe, the concrete operations ceased, then the only thing to do was wait for a warming chinook wind out of the west to raise the temperatures to a workable condition.

Barney Trawicky, Construction Division Chief, reports that the major step taken to allow winter work at the Grand Forks site was closure of the first floors of the four major buildings. The last of these structural concrete placements was made on the second floor slab of the Perim-

Construction workers beat the rap of winter construction with hay bales, plastic canopies, polyethylene, plywood, space heaters, and many other items



2



3

1. Members of the Brotherhood at work on concrete forms at a missile site. Hard hats, ear muffs, and scarfs help to protect them against winter blasts.

2. The sloping walls of a perimeter acquisition radar building take shape under huge concrete forms studded with rods and planking. Concrete sets at 50 degrees beneath this blanket, as the temperature outside goes below zero.

3. A worker strides past snow-covered forms and walkways, as construction continues relentlessly on.

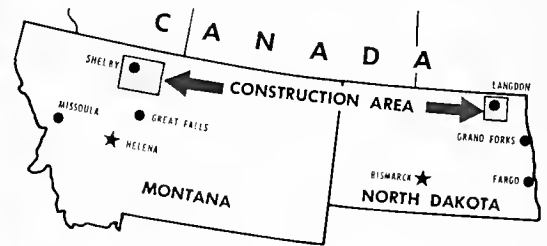

eter Acquisition Radar (PAR) Building on December 23, 1970. Closure of the first floors of the other three buildings had been reached previously.

With the first floors inclosed in concrete, a protected base was established to allow inside work. But concrete alone provides little comfort from the hostile temperatures produced by a North Dakota winter. There were still many openings left in the lower levels of the building shells, and the concrete itself had to be protected during the curing period.

Next to be tackled were the interiors of the buildings. If any effective inside work was to be accomplished, the workers had to be provided some semblance of comfort and the mate-

rials had to be protected. Implementing another phase of their well conceived plan, the construction men installed huge 2,000,000 BTU gas-fired furnaces in each structure. The furnaces are equipped with electric blowers and yards of ducts which force warm air into most of the nooks and crannies of the maze-like interiors. If any hidden corners in the labyrinth of rooms are missed, plenty of portable LPG space heaters are on hand.

The workers were rewarded for their efforts with a tolerable 55 degree temperature, sufficient to allow inside work to progress in comfort without the necessity for bulky clothing. Evidently, efficiency of the workers remained adequate also. At last report progress on all the elec-

trical, mechanical, painting, and other inside features was on schedule. Even the miscellaneous concrete required can be placed in warmth from one of the portable mixers inside the buildings.

At the Malmstrom site, the primary effort was on concrete and embeds, with little electrical and mechanical work involved. Consequently, the winterization effort was aimed at protecting the concrete.

As at Grand Forks, a winterization plan was approved and implemented.

The primary work so far has been at Grand Forks, N.D., where more than 600 members of the United Brotherhood of Carpenters and Joiners of America—members of Local 2028—have been employed. Actual-



1. An aerial view of the building site for the Malmstrom Missile Site radar building . . . deep in snow. Canopies cover the work areas as reinforcing rods are tied and concrete forms are made ready for concrete pouring when the temperature rises.



2. A view of the same site, last November, when a huge pile of straw bales (light colored, in the foreground) was assembled for barrier walls against winter winds and snow.

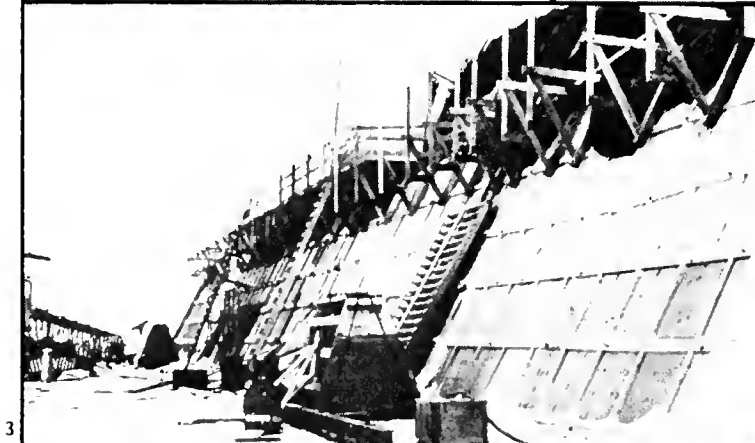

3. The "blanket-covered" northwest corner of the Perimeter Acquisition Radar Building. Sheets of plywood and Styrofoam cover concrete curing at 50-degrees F temperature, despite below-zero outside temperatures.



4. A heavily-insulated concrete truck (left, foreground) delivers temperature-maintained concrete to the job site, while the work goes on beneath plastic canopies.



5. An artists cutaway conception of a finished "perimeter acquisition radar power plant" now being built in winter weather. Almost the entire plant will eventually be underground.

ly, the job site is near Langdon in Cavalier County, North Dakota.

Bids are being opened this month at Great Falls, Mont., as work begins in earnest there. Less than 100 Brotherhood members have been employed so far at this site, and winter work has not been as intense as it has been at Grand Forks. The Montana units are near Conrad in Pondera County.

Safeguard in North Dakota began with the letting of the contract March 31, 1970, in St. Paul, Minn., when a submittal of Morrison-Knudsen and Associates was selected as the low bid. The bid totaled \$137,-858,850 and was the largest single contract ever awarded by the U.S. Corps of Engineers in its 195-year history.

Basically, Safeguard is composed of five major subsystems—missile site radar (MSR), perimeter acquisition radar (PAR), Spartan missile installations, Sprint missile installations, and data processing.

Overall, the winterization effort has prevented much waiting for warm temperatures, allowed construction to progress under what would otherwise have been impossible conditions and allowed an effective work force to be kept assembled and gainfully employed. ■



New Tax Rules

A HELP IF YOU KNOW THEM

By **Sidney Margolius**

■ There are important changes in the tax rules this year which you ought to know about before you send in your return on 1970 income due April 15. These changes especially affect low-income and part-time workers, including any of your children who may have worked part time. They can have up to \$1,725 in income without owing any taxes.

You should see that your child files a tax return if he worked part-time, in order to recover federal income taxes if they were deducted from his pay.

But in addition to part-time workers, many low and moderate-income families with several children will not owe any federal income tax this year, and may be eligible for refunds, because of a special "low-income allowance."

On your return for 1970 income, you have a choice of three ways to take deductions:

—You can itemize deductions.

—Or you can take a blanket deduction of 10 per cent of your adjusted gross income up to \$1,000 (\$500 on the separate return of a married person).

—Or you can use the optional tax tables to take a minimum standard

deduction which now includes an additional allowance for low-income taxpayers.

The new minimum standard deduction is the total of two amounts: a "basic allowance" and an "additional allowance." The **basic** allowance consists of \$200 for each taxpayer plus \$100 for each exemption on his return. The **additional** allowance, designed to help low-income taxpayers, is \$900 minus \$100 multiplied by the number of exemptions.

Note that these two allowances always add up to \$1,100. For a single person who has only himself as an exemption, the basic allowance is \$300 and the additional allowance, \$800. For a couple the basic allowance is \$400 and the additional allowance \$700, and so on.

Now if you add to these allowances the 1970 exemption of \$625 per person (increased from the century-old \$600), you see that a single person can have nontaxable income for 1970 of as much as \$1,725 (\$1,100 plus \$625). A couple can have \$2,350 of nontaxable income (\$1,100 plus \$1,250). Similarly, a taxpayer with three exemptions can have \$2,975 of non-taxable income; one with four exemptions, \$3,600; five, \$4,225; six,

\$4,850; seven, \$5,475; eight, \$6,100.

But: if your income is over these amounts, the "additional allowance" is reduced on 1970 returns by \$1 for each \$2 of excess income until it melts away completely.

If you are a moderate-income taxpayer who might benefit from the new allowance you don't need to figure it out yourself, although it helps to understand it. The optional tax tables that come with your tax forms have the minimum standard deduction, including the low-income allowance, already built-in for families of various sizes.

But what the average family with income under \$10,000 does need to decide is whether itemizing deductions would save taxes compared to using the optional tax tables with their built-in standard allowance. (Families with incomes of \$10,000 or over, or who have more than \$100 of dividends or interest, can't use the optional tax tables in any case. They must either itemize or take the 10 per cent standard allowance.)

Let's see how a typical family would decide which of the alternative deduction methods would be best. Mr. and Mrs. Smith have two children and adjusted gross income of \$8,000. First they estimate that their potential deductions would total \$900 if itemized. This obviously would be better than the \$800 the 10 per cent blanket deduction would give them.

But would the new additional allowance help them? First the Smiths estimate what their tax would be on their \$8,000 income if they itemized. With their itemized deductions of \$900 and their four exemptions of \$625 each, they can subtract a total of \$3,400 from their gross adjusted income. This leaves \$4,600 of taxable income. The normal tax on this is \$734. Then they look at the optional tax table for returns claiming four exemptions and find that the tax shown there for an adjusted gross income of \$8,000 would be \$757. (Neither figure includes the surtax.)

Thus, they would get no help from the minimum standard allowance. So the Smiths itemize deductions.

But take a family with less income and more exemptions. Joe Jones, with a wife and four children, suffered a work cutback in 1970. His gross adjusted income was \$5,000. The Joneses add up their potential deductions and find they come to \$800 if itemized; obviously preferable to a 10 percent standard deduction of only \$500.

But as they see by checking the

optional tax tables for six dependents, they would get some help from the minimum standard allowance. The tax shown on the tables is only \$37 instead of the \$63 they would pay if they itemized deductions and calculated their tax the normal way.

The Internal Revenue Service has made a partial concession on our plea to correct one of its unfair rules—the limitations on the amount you can deduct for interest on installment purchases. Last year in this column and in letters and discussions with IRS, this writer pointed out that the Truth in Lending law now requires that all credit charges must be shown as an annual percentage rate. Therefore it is only fair that consumers be allowed to deduct finance charges in full as “interest.” Otherwise, on revolving charge accounts and installment purchases you are supposed to deduct only an amount equal to 6 per cent of the average unpaid balances.

Deductible Interest

In contrast, you *can* deduct the full interest on cash loans. One contradiction which we tried to get IRS spokesmen to clarify is whether the credit fee on a bank charge card such as Master Charge or BankAmericard is “interest” and fully deductible, or a “finance charge” and only partly deductible. We reported that the New York IRS office said that bank-card credit fees are fully deductible but the Washington office said they would not be (a typical IRS contradiction).

Finally after almost a year the IRS has ruled that the credit fees on a bank charge card would be fully deductible if the bank treats them as interest. But if the bank or retailer does not show the “interest” separately from carrying charges” or it cannot be ascertained, then they are subject to the 6 per cent limit (a typically vague IRS ruling).

If you paid credit fees on a store revolving credit plan, our best advice is to contact the store and ask what part is “interest.” We have also warned a number of department-store executives, some of whom are as tied up in red tape as government officials, that they should call their so-called carrying charges “interest.” Otherwise consumers have a double reason for using credit-union or bank loans to finance purchases. The credit charges are both lower and fully deductible.

‘Adjustments’ and ‘Deductions’

Sometimes taxpayers are confused by the differences between “adjust-

ments” and “deductions” and subtract “adjustments” in the wrong place. It’s important to understand the difference.

For one reason, failing to list the “adjustments” in the proper place (on page 2 of the tax return) can delay a refund. But even more important, you can subtract your total adjustments from gross income on page 1 whether or not you itemize deductions or take a standard deduction.

Too, subtracting the adjustments from gross income results in a lower “adjusted gross income.” Thus you may be able to deduct more of your medical expenses, since you can deduct only that part over 3 per cent of adjusted gross income.

The most common adjustment is for sick pay. You can subtract the pay you received while sick or injured, within specified limits.

Another frequent adjustment these days is moving expenses if you go to a new job. The rules have been liberalized so you can take off additional costs, such as expenses for house-hunting at the new location.

Employees who must sometimes be away from home overnight on jobs or who work away from home temporarily can take an adjustment for non-reimbursed travel, meals and lodging.

Or if you work at two places in one day you may take off costs of getting to the second.

Now for deductions:

We cannot list here all the potential deductions you may be able to itemize (the better tax guides have comprehensive lists) but want to point out some often overlooked.

MEDICAL: You can deduct one-half of amounts paid for health insurance up to \$150, whether or not you have enough other medical expenses to itemize. The balance can be included in your medical deduction if you have enough to deduct. In health-insurance expenses, include your share of the cost of employer health insurance, and the medical-payments portion of your auto insurance.

Other deductible medical expenses, as well as the usual doctor, and hospital bills, include eyeglasses; prosthetic aids; household medicines like aspirin; transportation costs to get care; special foods, vitamins and equipment, even an air conditioner for an ill person, support hose, etc., if advised by a doctor.

If you support a relative who would qualify as your dependent except that he has taxable income of \$625 or more, you can include in your medical

deduction any medical and health-insurance bills you pay for him, including for Medicare Part B. In fact, it may be preferable to pay medical bills for such a dependent than give him the cash.

CASUALTY LOSSES: You can deduct for sudden damage of over \$100 to property, boat and car or other possessions from fire, storm, accident (even if your own fault) and also theft. The loss is the difference in fair market value of the property before and after the damage. It helps to have documents such as appraisals and repair bills.

INTEREST: Mortgage interest is wholly deductible. So are prepayment penalties, and “points” paid to get a mortgage if the buyer pays. Interest on cash loans also is fully deductible. But, as noted, you have the problem of whether finance charges are “interest.”

CONTRIBUTIONS: As well as cash donations, you can deduct fair market value of donated goods and out-of-pocket car and other expenses (or 5 cents a mile), and costs of uniforms for serving qualified nonprofit organizations such as Scouts, hospitals, schools, etc.

WORK EXPENSES: You can deduct union and professional-association dues; employment agency fees; costs of distinctive work uniforms; safety clothing and shoes; tools and technical books; training or vocational courses required for your present job (but not to learn a new trade); car expenses if you must bring heavy tools to your job.

OTHER POTENTIAL DEDUCTIONS: Other income and sales taxes; child and disabled-dependent care (under specified conditions); bad debts; alimony; investment expenses, including a safe-deposit box, in which you keep E bonds or other securities.

Exemptions Bigger Now

Exemptions are big tax savers since this year they reduce your 1970 taxable income by \$625 for each one (\$650 in 1971).

The IRS does examine dependency claims closely, *especially if the dependent does not live in your home.* You must be able to show that you do provide over half the support, and he does not have \$625 or more of taxable income of his own (except for children under 19 or full-time students). (Social Security and similar benefits are not taxable income, and are not counted in the \$625.) ■

Copyright 1971 by Sidney Margolius

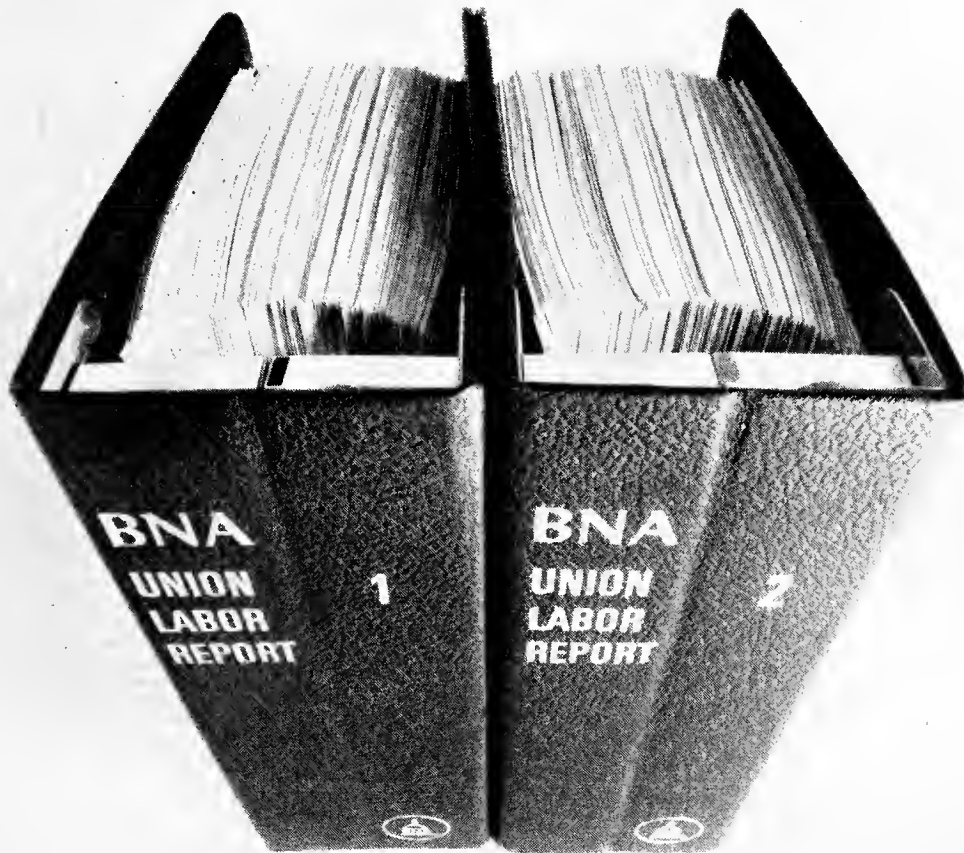

...to form a more perfect union.

BNA's *Union Labor Report* is a unique weekly information service tailor-made for local union officers, officials of trade councils, executives of state and national labor organizations, even members of grievance committees, organizers, and negotiators . . . in short, every union leader involved in day-in, day-out conduct of labor relations.

ULR has been around since 1947, keeping union leaders

up to date on the latest developments with an 8-page weekly Newsletter written in an informal, easy-to-read manner. *Union Labor Report* consists of looseleaf binders filled with practical guidance on the day-to-day operation of your union. It is kept up to date every other week. You know it all, because you have it all . . . right there at your elbow whenever a gripe, squawk, or problem arises.

Is ULR for you? Here's a no-obligation way to find out for yourself. Simply fill in and mail the coupon and we'll send you the complete service on a 45-day approval basis. And we'll show our appreciation for your interest by including a *free copy* of "Organizing and the Law" by Stephen I. Schlossberg, general counsel of the UAW. It's a valuable "how-to" book on labor organizing. Mail the coupon today.



THE BUREAU OF NATIONAL AFFAIRS, INC.

Dept. ULR-501, 1231 25th Street, N.W.
Washington, D.C. 20037

Please send me ULR on a 45-day approval basis. Also include my FREE copy of "Organizing and the Law." At the end of 45 days, I will either accept your billing (\$158 annually) or return all materials at BNA's expense (except the free book, which is mine to keep).

Signed _____

NAME _____ TITLE _____

ORGANIZATION _____

ADDRESS _____

CITY _____ STATE _____ ZIP _____



FREE

with your 45 Day
Approval Order

Hard cover edition
Retail value \$8.50

**MAIL THE COUPON
TODAY**

CONSTRUCTORS, UNIONS SET UP UNIFORM WORK RULES, ESTABLISH JURISDICTIONAL PENALTIES



C. J. Haggerty, president of the AFL-CIO Building and Construction Trades Department signs the historic agreement. Standing, from left, are Benjamin B. Frost, president of the National Constructors Assn. and head of Arthur McKee and Co. of Cleveland, O.; John O'Connell, executive vice president of the Bechtel Co.; and Charles Pillard, president of the International Brotherhood of Electrical Workers and chairman of the unions' "summit" negotiating committee.

■ The National Constructors Association and the Building and Construction Trades Department, AFL-CIO, signed agreements, late last month, that for the first time set up uniform national work rules and a system of financial penalties in the area of jurisdictional disputes.

The precedent-setting "productivity compacts," executed after a year of intensive high-level negotiations, are aimed at boosting field labor productivity and eliminating costly and disruptive strikes and picketing over arguments between rival unions as to which craft performs various kinds of work.

Jurisdictional disputes, long the bane of the construction industry, are the subject of a separate and unique contract. It requires adherence to procedures of the National Joint Board for the Settlement of Jurisdictional Disputes and creates, for the first time, a set of financial penalties to be levied on transgressing contractors or unions. A contractor who makes an unreasonable misassignment can be assessed up to \$10,000 for the first such act and higher penalties for subsequent unreasonable assignments.

Similar fines can be levied against an international union that fails to take "prompt and appropriate" action against a local that strikes or pickets a job "in furtherance of a jurisdictional dispute." These penalties range from \$2,500 for a small international that permits a jurisdictional strike to \$10,000 for a large union that fails in halting a jurisdictional picket line. The jurisdictional penalty system is spelled out in detail in the second of the two productivity compacts.

It provides for an impartial umpire with power to decide if the rules are violated, to fix the amount of the penalty, and to take action against the offender.

Separate trusts are to be set up by labor and management to receive money paid by their respective sides. The Employer Trust will be used for research and study in the area of manpower use and recruitment in the industry. Moneys deposited in the Building Trades trust will be spent in research and study concerning the origin and prevention of labor disputes. None of these funds can revert to the penalized unions or employers.

Although signed on behalf of the National Constructors Association, these agreements and proceedings are available to other contractors in the industry who sign letters of assent upon agreement with the Building and Construction Trades Department. ■

Editor's Note: In a subsequent issue, the full text of the agreements will be published for the benefit of local unions and district councils.

Fleetwood Boycott Plans Progressing

■ As this issue of *The Carpenter* goes to press, representatives of the Brotherhood are discussing with leaders of the AFL-CIO a possible nationwide boycott of Fleetwood Enterprises—an employer of Brotherhood members which has been “dragging its feet” in contract negotiations for more than a year.

They are also conferring with officials of the AFL-CIO Union Label and Service Trades Department, which directs much of the consumer boycott activities of the American labor movement.

Purpose of the boycott will be to bring consumer pressure to bear on negotiations which have been marked by little progress since the first Fleetwood plant was organized in 1969.

Fleetwood Enterprises has 28 mobile and modular home manufacturing plants in 13 states, plus other facilities due to open in 1971. It is a major manufacturer of mobile homes and is listed on the New York Stock Exchange. Last year it delivered 27,000 mobile homes and recreational vehicles. Its sales, according to a recent advertisement in *The Wall Street Journal*, have shown an average annual increase over the past decade of 37% per year. It also reports to stockholders an average annual increase in earnings of 50% during the same period.

Fleetwood distributes its products through 1,800 dealers and it is upon these dealers that a boycott would fall hardest.

The maps of the United States, shown below, indicate where mobile home dealers are concentrated. From 1960-1969, the Northern states more than tripled shipments, rising from 46,000 mobile homes to 150,000. The South had more than a six-fold increase, from 31,000 to 203,000. The West slightly more than doubled its acquisitions, from 26,000 to 59,000.

A boycott of Fleetwood would be supported by every local union and district council of the United Brotherhood of Carpenters and Joiners of America. It would also have the support of the more than 100 affiliated unions of the AFL-CIO—over 15 million union members—when the AFL-CIO lends its support, as Brotherhood leaders anticipate.

It is significant to note that most mobile home buyers are in the so-called “working class” of the nation—those blue collar workers who have difficulty in obtaining high-cost housing or who find mobile homes useful in changing job locations or retirements.

Owens-Corning Fiberglas Corp. recently conducted a study, which was supported by the Mobile Home Manufacturers Assn., and which revealed who mobile home buyers are, what they like, what they don't like, etc.

The survey asked hundreds of mobile home buyers this question: “Into which of these groups did your total family income fall last year?” and it listed various salary levels. These were the findings:

Income	North	South	Total
Under \$3,000	.. 8%	8%	8%
\$3,000-\$4,999	..13%	12%	13%
\$5,000-\$7,499	..25%	31%	28%
\$7,500-\$9,999	..22%	20%	21%
\$10,000-\$14,999	14%	13%	14%
\$15,000-\$19,999	1%	2%	1%
\$20,000 and over	—	1%	1%

Mobile home buyers, for the most part, are wage earners, and many of them are union members. Also, many owners of mobile homes are persons who have retired on union-won pensions, senior citizens loyal to union label trades and services. Such persons will be alerted to the non-union practices of Fleetwood Enterprises and will be called upon to back the boycott. ■

CORRECTION

In its February issue, *The Carpenter* reported that the National Marine Engineers' Beneficial Association, an AFL-CIO affiliate, has organized an Ohio plant of Fleetwood Enterprises. Actually, it is the Mechanics Educational Society of America, another AFL-CIO affiliate, which was voted official union representatives of the workers in this plant.

MOBILE HOME SHIPMENTS TO DEALERS -- % OF U.S. TOTAL
1960 and 1969

Percent	No. States		Percent	No. States	
	1969	1960		1969	1960
0.00-0.49	9	2	2.50-2.99	4	1
0.50-0.99	12	11	3.00-3.99	4	4
1.00-1.49	3	10	4.00-4.99	2	3
1.50-1.99	8	12	5.00-7.49	3	2
2.00-2.49	3	3	7.50 and over	2	1

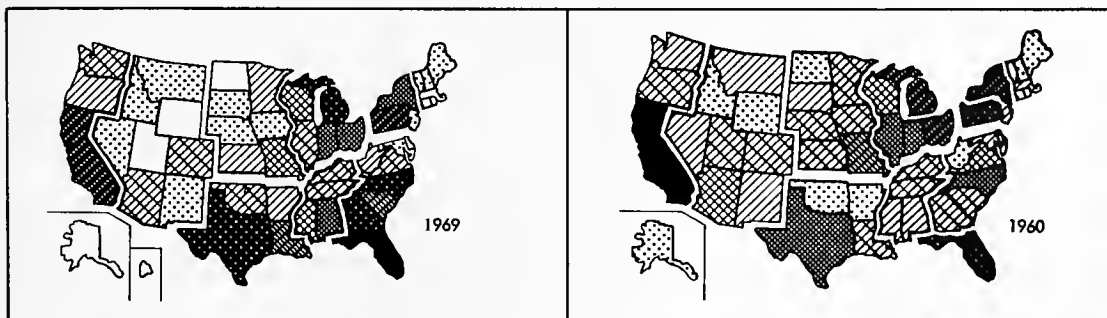

—From a report for the Mobile Home Manufacturers Assn. prepared by the American Society of Planning Officials.

USS Sam Gompers

NAVY'S MR. FIXIT

■ A U.S. Navy destroyer tender named for U.S. labor pioneer Samuel Gompers is making a name for itself in service to the fleet. Significantly, the *USS Sam Gompers* employs many on-board skills of various craftsmen that would make any labor leader proud.

Tenders play a key role in keeping the Navy seaworthy, performing normal supply and repair jobs to other ships wherever they are needed. Like its namesake, however, the *Gompers* is something special.

The ship was commissioned three years ago upon completion at Bremerton, Washington, Naval Shipyards.

It is the first of its type built since World War II.

A destroyer tender like *Sam Gompers* is almost twice as long and six to eight times as heavy as the individual destroyers that look to her for aid. In addition to the regular jobs, the *Gompers* acts as a repair center for missile systems, antisubmarine weaponry, advanced communication and electronic systems and nuclear propulsion plants.

Atop the tender's hull lies a vast deck area dotted with multipurpose cranes. Below deck is a maze of workshops where Navymen repair equipment ranging from drone helicopters to chronometers.

One of the key facilities is the car-

pentry-patternmaking shop, which has assigned to it 28 damage controlmen and patternmakers.

The shop completes an average of 100 to 120 jobs per month. It does cabinet work, patternmaking for the ship's foundry, and the repair of boats.

Boat repair is not limited to simple woodwork, but includes fiberglass work, hull repair, replacing beading and decks, and modernization of interiors.

The cabinet work consists of the creation and installation of cabinets, partitions, picture frames, wooden deck grating, cruise boxes, and decorative fancywork for cabins and

The Navy's "labor leader," the USS Samuel Gompers, dwarfs the destroyers McKean, Higbee and L. F. Mason at her side as she provides a multitude of maintenance facilities for them in Subic Bay, Philippines.—U.S. Navy Photo



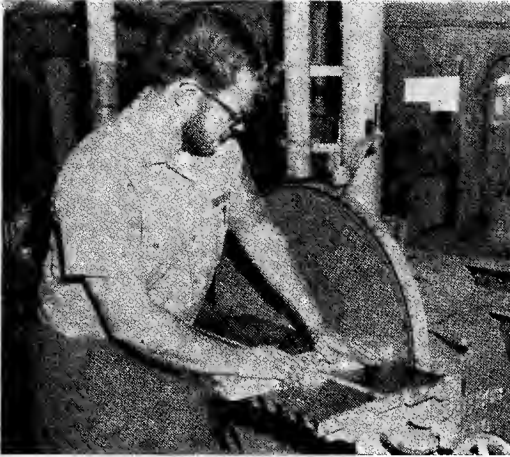

FAR LEFT:
Pattern Maker
Second Class
T. L. Clark of
Tucson, Ariz.,
on a sander.

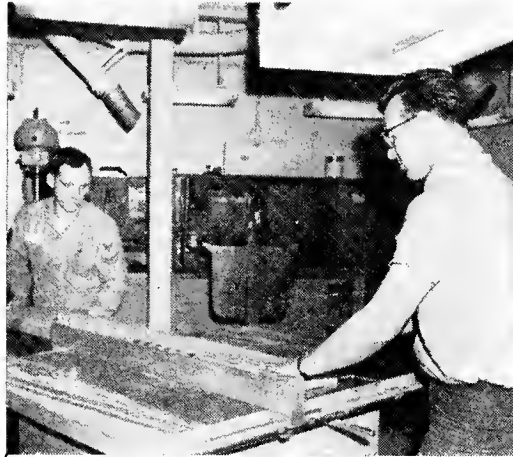

LEFT:
Damage
Controlmen
S. J. Mace of
Vashon Island,
Wash., and D. L.
Baird of Carey,
Ida., at work.

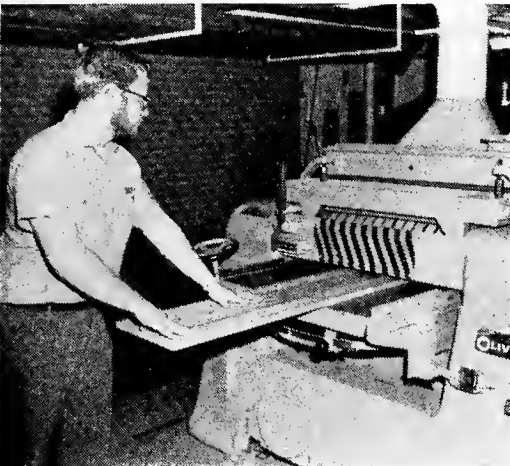

FAR LEFT:
PM2 Clark
operates a
planing machine
in the carpentry
shop.

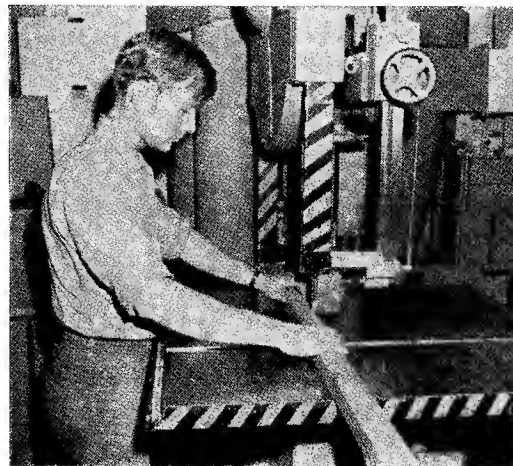

LEFT:
Pattern Maker
Third Class L.
P. Oltman of
Seattle, Wash.,
at work.

ceremonial areas such as quarter-decks.

These are a few of the shops now in operation:

- A shipboard computer installation that sorts, scrambles and selects data on almost 70,000 different repair parts and materials, and provides updated information on the status of the ship's work.

- A sound analysis shop where Navy personnel survey shipboard noise and remedy sound conditions

that might be harmful to their shipmates' hearing and safety.

- In the optical shop thousands of binoculars, magnetic compasses and similar optical equipment are overhauled, adjusted and calibrated. In addition, lenses are polished and coated, and a silvering laboratory is being added to give its shop flexibility unequalled in the fleet.

- The engine shop is equipped to test small marine engines and associated equipment. Enginemen

working here also provide technical advice and assistance in the maintenance of larger engines that cannot be brought into the *Gomper's* hold for overhaul. It is also equipped to repair nuclear-powered warships, coordinating this work with the tender's radio chemistry lab and electronics repair shop.

- To complement these and other shops—including a pattern shop and foundry—there are huge storerooms for spare parts, vertical conveyors

If You're A Man Who Likes To Work With His Hands...You Can START A BUSINESS OF YOUR OWN



Get ready now for a happier, more secure future—start a business of your own. Discover success with the *automatic* Foley Saw Sharpener. It's the machine that has enabled thousands of men to have a stable, profitable full time or spare time business that grows and grows and brings in cash every day!

90¢ Profit on each \$1⁰⁰

You'll make big profits on every sharpening job—and, there's no selling, no canvassing and no experience necessary!

Earn \$6 an Hour with FOLEY Saw Sharpener

A precision machine . . . a time-tested, use-proven sharpener that turns out a perfect job every time, yet so easy to use, you need no experience! Set it up in your basement or garage and earn cash doing high-profit sharpening in your spare hours. And, best of all, the repeat business builds every day!

RETDOTHER—Cuts a full set of new teeth, either rip or crosscut, in less than a minute. Can be operated by either motor or by hand crank.



GRINDER —Sharpens all types of circular saw blades—will handle any size from 5" to 44" in diameter. Attachments available for a variety of other sharpening jobs.



CARBIDE SAW GRINDER —New precision machine grinds face, top, sides of carbide blades. Sharpens old teeth and replacement tips.



LAWN MOWER GRINDER —No need to remove reel with this money-making Foley Grinder. Gives all year cash profits.



FREE Booklets Tell You How...

Write for free booklet "MONEY MAKING FACTS"—get details about how you can get into the profitable "sharpening business, and our time payment credit plan. Send the coupon today. No obligation—no salesman will call.



Foley

MANUFACTURING COMPANY
318-1 Foley Bldg., Minneapolis, Minnesota 55418

- "Money Making Facts"
 Automatic Saw Filer
 Automatic Retodother
 Automatic Power Setter
 Automatic Grinder
 Lawn Mower Grinder
 Foley Carbide Saw Grinder

Please send me FREE booklets checked at left:

Name _____

Address _____

City _____ State _____ Zip _____



A submersible pump is repaired in a shop aboard the USS Gompers.

and freight elevators by the dozens, and a fleet of forklift trucks.

• An altogether different facet of the *Sam Gompers'* aid to its destroyers is in the area of personal health and dental care. Its 43-bed hospital, complete X-ray and lab facilities, operating room and six-chair dental clinic provide the services of specialists not feasible, due to space and manpower limitations, on smaller vessels.

Because of its unique capabilities, the *Gompers* crews "sec the world" in the best of Navy tradition, cruising—though not at the speed of its destroyer charges—wherever the need arises.

Because of her wide variety of shops and highly-trained Navymen, *Sam Gompers* was recently selected as a training center for the Vietnamese Navy. There U.S. Navy personnel teach their Vietnamese counterparts electrical repair, motor rewinding, welding, pipefitting and lathe operations.

Named for an extraordinary American, the extraordinary destroyer tender *Samuel Gompers* has lived up to its name. ■

Information and pictures for the accompanying article were supplied by the staff of *ALL HANDS*, official Navy publication, and by the Office of the Public Affairs Officer, Commander Cruiser-Destroyer Force, U.S. Pacific Fleet, San Diego, California. Our special thanks to John Foland, Media Relations, All photographs are official U.S. Navy photos.

India's Princes Form Union To Save Their Privy Purses

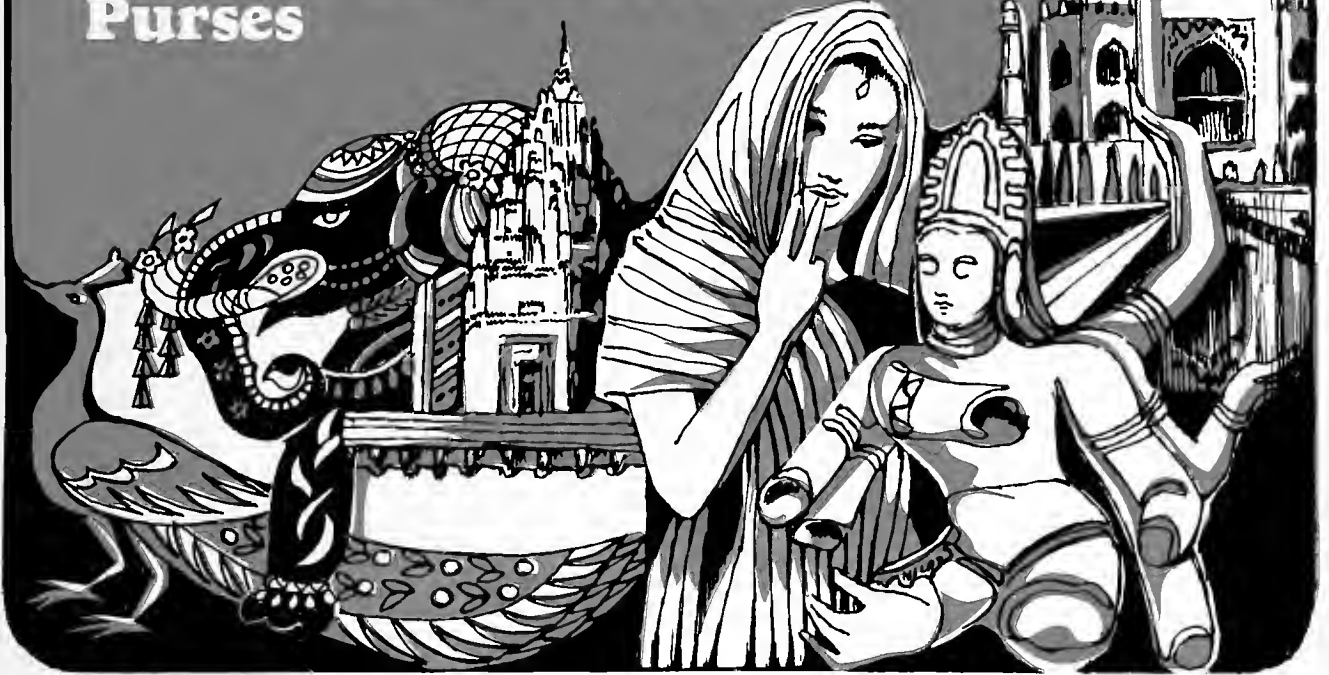

■ These are the times that try the souls of poor maharajas trying to face life in modern India.

Things have come to such a pass that the maharajas, rajas, nawabs, and other princes have formed their own trade union, the Concord of India.

The princes recently met to reaffirm opposition to a government proposal to eliminate their privileges and privy purses, or annual tax-free payments.

They plan to fight their case all the way up to India's Supreme Court, the National Geographic Society says.

The potentates lost their power soon after India gained independence in 1947. Nearly 600 princes were granted either cash settlements or privy purses in return for integrating their states into India.

The payments currently are made to some 280 princes. The annual sums range from \$267,000 for the Nizam of Hyderabad to \$25.60 for the Talukdar of Katodia.

Princely privilege is another mat-

ter. The full list of 23 privileges is accorded only to the exalted few who were entitled to 21-gun salutes in the days of the British Raj.

The perquisites include free medical care, special red auto license plates, duty-free imports, the right to fly personal flags on vehicles and residences, and priority on telephone calls.

Many princes fear that abolition of their privy purses will mean almost instant penury. After generations of living like kings, the rajas find it difficult to adjust. One princely person in Mysore tried hard to economize. He took to wearing homespun suits—with diamond buttons.

The grandfather of the present Nizam of Hyderabad had no trouble pinching rupees, though he was believed to be the richest man in the world. The old Nizam dressed in shabby clothes, slept on a pallet, and planned the palace menus to forestall extravagance. His favorite pastimes were writing poetry and watching surgical operations.

The Maharaja of Jaipur once col-

lected taxes from a domain roughly the size of Vermont and New Hampshire, but with three times the population. The maharaja's personal elephants now transport howdah-loads of tourists to his 17th-century palace. The female elephants are fitted with impressive false wooden tusks to make a better show.

In the mid-19th century, the Maharaja of Gwalior built a palace with a solid-gold roof, tested for strength by elephants. Within were the largest red chandelier and the most elaborate model train setup in the world. The palace now is a public museum.

Many of the princes, whose word was once law to 91 million Indians, have gone into government, diplomacy, business, and the professions. The Maharaja of Patiala manufactures soda pop.

Gone are the days when an Indian prince reportedly took along 200 concubines on a one-night visit to a neighboring prince, explaining, "The ladies don't get out much. I thought this might be a nice outing for them." ■



CANADIAN REPORT

Banks will loan for \$25,000 house, But how can \$9,000 worker afford it?

Canada has 10 national banks ranging from big to huge. The biggest of them all is Royal Bank of Canada, which probably ranks among the top 10 or 20 in the world.

None of Canada's banks have lent much money for housing. They have been lending more in recent years due to quiet government pressure. In addition, mortgage rates are at an all time high and probably not unattractive even to big banks.

The man who runs the mortgage department at the Royal Bank had some advice to residential builders recently. Build homes to suit people earning between \$5,000 and \$9,000 a year.

Some smart builder is going to ask him how. Few homes in Canada are built to sell under \$20,000, and in major industrial centres, they sell for \$20,000 to \$30,000; in Metro Toronto, for \$30,000 to \$40,000.

The carrying charges on these homes would range from \$200 to \$400

monthly . . . at current interest rates, maybe more.

A man earning only \$5,000 a year can't afford to pay more than \$100 a month for his home. If his family is large, say three children or more, he shouldn't pay even that much.

A man earning around \$9,000 should pay no more than about \$180 a month unless he has fewer than three children.

These estimates of monthly payments or rent are based on the old rule of a week's pay for a month's rent for an average family.

But the Royal Bank proposes to provide builders' mortgages for homes selling between \$25,000 and \$30,000. The minimum average monthly cost of carrying these homes would be about \$250 to \$300.

Workingmen earning between five and nine thousand a year just can't afford these costs.

The mortgage manager of the bank hasn't done his homework.

Industrial unions accept wage freezes In some provinces of Canada

The trade union movement has shifted its concern from changes in labor legislation which could hamper organization to worry about heavy unemployment, layoffs, shutdowns and pollution.

These issues are all tied together.

The dire prediction which trade union headquarters, from the Canadian Labor Congress down, made last year have unfortunately come true. Now the debate is not whether or not we're going to have serious unemployment, but about how high it really is and what to do about it.

The number of unemployed, accord-

ing to Bureau of Statistics figures, at the beginning of the year was well over the half million mark.

This was bad enough. But when the question was asked in the House of Commons as to how many are drawing unemployment insurance, the figure given was three quarters of a million—which is considerably worse.

Some estimates say that unemployment may reach close to the million mark before the winter is over. But the government contends that the worst is over, that the trend of joblessness is downward.

But there is not too much support

for this optimistic view.

Arthur J. R. Smith, chairman, Economic Council of Canada, believes that economic recovery will be slow, that high unemployment will be with us throughout the year.

Canada has checked threatened inflation in much better fashion than the United States. It is really in a good position to develop aggressive policies for full employment. But, if Prime Minister Trudeau is to be taken at his word, nothing extraordinary is going to be done that has not already been done.

But the United States which has had double the inflation that Canada has had in the last year or so is supposed to be going ahead with an aggressive economic program to provide enough jobs to cut unemployment from the six percent figure last year to under five percent this year.

There is often a big difference between what a government says it will do and what it actually does.

Canadians have been looking to Ottawa for a ray of hope that the job-making problem will be tackled with the seriousness it deserves. They have not been encouraged.

Conservative Leader Robert Stanfield made a publicity trip across Canada to meet with the unemployed, but it is hard to say that his ideas about what should be done differ substantially from that of the government. He has advocated tax cuts and elimination of the tax on building materials. The first would be effective if the biggest cuts were allowed to the lower income groups. But usually tax cuts benefit the high incomes, and Stanfield has not said how he would avoid that.

The New Democratic Party, through retiring leader T. C. Tommy Douglas and through deputy leader David Lewis, Canada's leading labor lawyer who may succeed Douglas, urged the government to take a number of steps immediately which would help the unemployed.

They advocated a big increase in unemployment insurance benefits, instead of the small increase the government has allowed; more aid to provincial and municipal governments to meet soaring welfare costs; increased old age pensions which would help the elderly and stimulate the economy by increasing consumer spending; and elimination of the three percent income tax surcharge.

These would be of immediate help. What would help over a longer term would be a more consistent policy toward homebuilding. The government

has turned the money tap for housing on and off in response to its fiscal and monetary policies. Last year it tightened its money lending so much that the homebuilding market almost collapsed, then toward the end of the year, it saw its mistake and poured two hundred million dollars into housing to get construction moving again.

But the construction started late last year will be coming on the market this year. This year started out with a great deal of uncertainty.

But the uncertainty is not limited to construction.

Business is so bad in some industries that companies have threatened unions with wage reductions.

Acme Screw and Gear, producing chiefly for the auto industry, told the union they would have to take a wage cut or a wage freeze. They did the unusual by opening the books to the union, which finally and reluctantly agreed to an 18-month freeze on wages.

About 600 production and office workers at Dunlop Canada Ltd. in Whitby, about 25 miles east of Toronto, accepted a one-year wage freeze after the company proposed a 10 percent cut as the alternative to a shutdown.

Layoffs and shutdowns have been taking place right across the country. In British Columbia there have been heavy cuts in the forest and construction industries. B.C. has the highest wage rates in Canada, and today some of the heaviest unemployment. And B.C. is a rich province.

In Quebec, the electrical, aerospace and pulp and paper industries are having a rough time.

In Ontario, unemployment is not as bad as elsewhere, but still over five percent of the work force is out of work.

Young people are getting hard hit. It is estimated that two out of five without work are below the age of 25.

Pollution, Jobs Tied Together

If the pollution problem were tackled as it should be, the unemployment situation could be made worse, unless longterm, intelligent planning were undertaken to make sure that the "pollution and jobs" problems were tackled simultaneously.

This was one of the conclusions drawn from a conference on the subject of pollution and jobs sponsored by the Ontario Federation of Labour.

It was probably the first conference of its kind held in Canada.



A longboat moves down the Welland Canal. Pollution may become a problem along this vital waterway.

As the work force of the country grows, and Canada's is growing at a rapid rate, more economic growth is needed to provide jobs. More jobs mean more pollution.

The problem is complicated by the fact that economic growth today does not provide as many jobs as yesterday. Automation and other technological changes mean a heavy investment in computers and machinery which reduce the number of jobs required for any particular task.

But with the heavy unemployment we already have, economic growth is essential. Russell Bell, Research Director, Canadian Labor Congress, said that, in his opinion, growth need not be sacrificed to anti-pollution measures. But legislation will have to be adopted to get much tougher with polluters, e.g. much heavier fines and jail terms.

A spokesman for the paper unions said that companies will have to turn back more of their earnings into pollution control. Unions will have to introduce the pollution issue into collective bargaining.

The OFL has produced a substantial quantity of educational material dealing with conservation, pollution and environmental issues. The material is available to any union on request and at cost.

Mortgage Rates Higher Than in United States

Sidney Margolius, trade union consumer expert, wrote recently regarding mortgage rates: "A mortgage will cost you just a little less than last year's impossible 8½ percent and more . . ." in the United States.

In Canada, 8½ percent is not im-

possible. Rates last year ranged from 9½ to 10½ percent on first class mortgages.

The recent decline in mortgage rates brought the rate down to 9¼ percent . . . on prime first mortgages.

Margolius also says that 8 percent is "still not low enough to enable many working families to buy a house."

In Canada the big majority of working families have been priced right out of the conventional housing market.

Price Index For New Housing Up in Nine Years

The residential construction industry held a convention in Edmonton, last month, from which came all kinds of pertinent information.

One builder pointed out that the price index of new housing has gone up 63 percent during the last nine years, much more than most other components of the index.

He said that in the same period of time, TV sets have gone down nine percent in price. This provides the builder with a lot of competition for the consumer's dollar.

The same builder said that in the 1970s, the 30- to 39-year age group will be the best customers for housing. They are young, better educated and cost-conscious.

The concensus was that more mortgage money would be available this year at lower rates, and that the big market will be low-cost housing.

Many builders were anything but optimistic. Even the lower interest rates will still be too high. The rate should be pegged at seven percent, they thought.

One builder pointed out that few people can qualify for the required mortgage to carry a three-bedroom house of 1,100 square feet, selling for \$22,000 with \$2,500 down.

Another builder said that a \$20,000 home with a \$1,500 down payment was what is needed. But he agreed that this meant a lower profit for builders.

A big Ontario contractor who has been building apartments since 1964 said he was going back into building the single family home. But another builder from Toronto said that the answer to current problems is the condominium unit. Only the wealthy can really afford the single family home today.

But the condominium will be different in the future. It will be built in "total environment" communities and include corporate, commercial, social and educational facilities.



1



Service to the Brotherhood



A gallery of pictures showing some of the senior members of the Brotherhood who recently received 25-year or 50-year service pins.

(1) ST. LOUIS, MO.—Veteran members of Carpenters Local 73 were honored for 25 to 50 years of membership in the union. Seated, from left: John C. Vohs, the senior member with 53 years; James Brady, 51 years; George Vollmer, 51 years; Orville Johnson, 30 years; John Seydick, 29 years and Local 73 President Joe Feast, Arthur Smith, M. R. Brockmeier, Leo Brown, and Recording Secretary Edward Abmeyer, all 25 years. Standing, left to right: Carl Reiter, assistant executive secretary-treasurer of Carpenters District Council; Local 73 Vice-President Pat Sweeney, Financial Secretary-Treasurer Jack Melchior, Warden Charles Duncan, Conductor Sal Tedesco, Trustees William Ulmer, Ben Holthaus and Hurley Rector, and CDC Business Representatives Bill Field, Leonard Terbrock, Larry Daniels and Ed Thien. Old-timers not present when photo was taken are Ervin Bauer, Elmer Baught, Bernard Baumeyer, Floyd Busen, G. J. Maas, Joseph Maus, Albert Meyer,

Leo Sander, Clarence Spencer, George Spreitzer, Robert Young, Edward Aubertin, Roy Bohnenkamp, Raymond Phillips and Paul Whealen.

(2) GRAND RAPIDS, MICH.—Twenty-five-year service pins were presented to members of Local 1615 at a recent awards banquet. Standing, left to right, Corliss VerDuin, trustee; Ralph Meggitt, president; Chas. Gersch; Ernest Gates; Henry Bas; Stanley Karas; J. J. Pruin, trustee; Leonard J. Storm, financial secretary; Alfred Mickna; Floyd Wilson; Bert Wright; Louis Batstra; Robert Smith; Walter Peterson; Anthony Temaitis; Alby J. Conklin, recording secretary. Seated from left, Clemence Miller; Clyde Eldred; Ted Dlugolemski; Peter White, trustee; Chris Windt, vice president; Tony Kozal; Peter Schaaphok; and Ed Siemion. Others awarded 25-year pins were: Orville Ash, Jack Coleman, Warren Culp, Chas. Dirkse, John Dykhouse, Maurice Eman, Edmund Funk, John Funk, Dan

2





3

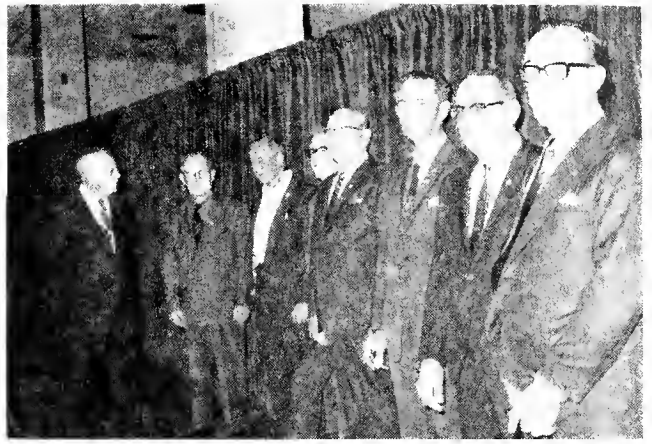

4



5



6

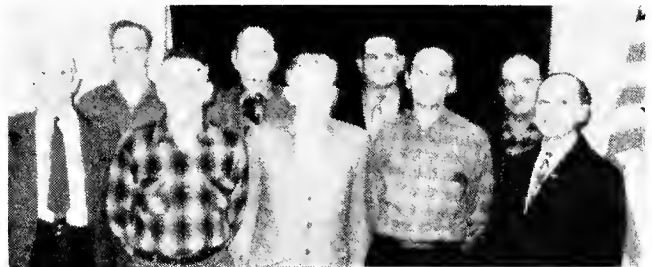

7

Grecaitis, Ebe Hansen, Dick Hesselink, Anthony Japlawy, Bror Johnson, Wm. Jones, Karl Kipp, Wm. Klepser, Louis Koperski, Chas. Kowiejsza, John Krolewski, Joe Levans, Herman Lindley, Kay Lukson, Jacob Manni, Bernard Mikulenas, Henry Nauta, Gust Johnson, Jay Naylor, Geo. Northedge, Orland Palmer, Arthur Peterson, Melvin Pearson, John Permoda, August Pitchelli, Lawrence Portko, Segmant Razgunnas, Irving Rood, Gerhart Reuschel, A. B. Shotkus, Adolph Siemion, Frank Siemion, Gerald Smith, Kenneth Snyder, Wm. Staskevicz, Frank Sterzik, Walter Tomazenski, Sam Vander Molen, Louis Van Liere, Herbert Van Velsen, Albert Watermulder, Frank Strayer and Geo. Swiers.

(3) WOODLAND, CALIF.—Six members of Local 1381 were recently recognized for more than 25 years of service. In the picture, E. J. Klinkhammer, right, presents pins to Burt Stratton, Marvin A. Crutcher, and Alfred Franks. Not present for the picture but also receiving pins were Lonnie Berry, Leslie L. Phipps, and John Colombara.

(4) TOPEKA, KANS.—Local 1445 honored one 50-year member and five 25-year members at its annual Christmas party, last December 19. Congratulating the old-timers in the picture are Retired State Representative Charles Miller, left,

and State Representative Morris Eastland, right. They flank, from left: Julius Martell, 50-year member; and Byron Lynn, Leo Hudgens, William Hanna, William Lignitz, and Marvin Gay, all 25-year veterans.

(5) BUFFALO, N.Y.—On November 5, 1970, Local 1345 presented service pins to 76 of its eligible members for 25 years or more of membership. Before a record turnout of members and guests, the President of the Buffalo District Council, H. Buddy Bodewes, made the presentations. Shown in the accompanying picture are the recipients of 50-year pins. (Only three of the four honored are shown).

From left to right in the front row are Dominic Coppola, Rudy Mascellino, and Julius Mariani. Not shown is George F. Dieter. In the back row, from the left, are Joseph O'Neil, President of Local

1345, and H. Buddy Bodewes, President of the Buffalo District Council.

(6) POMPTON LAKES, N.J.—A veteran member of Local 1493 was guest of honor at the local's Christmas party, last December. He is John Anderson, 50-year veteran, and he is shown here surrounded by the local's officers. Seated are Vice President Glenn DePetris, Anderson, and Recording Secretary Joe Weaver. Standing, from left, are Trustee Larry Hudgen, Treasurer Ross Muse, Financial Secretary Ken Larkin, and President Giles Ackerman.

(7) BOISE, IDA.—Carpenters with over 25 years membership receiving 25-year pins at a meeting of Local 635, January 25. Pictured from left to right: J. E. McBride, Earl Smart, R. L. Sawyer, C. E. Gunnerson, Roy Watson, Earl Yardley, Richard Johnson, George Ferguson, and Elwood Rarick.

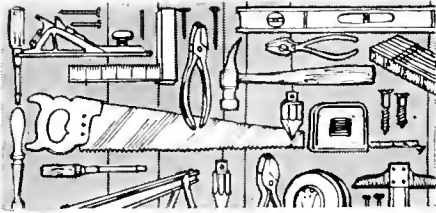

LOCAL UNION NEWS

Scranton Local Union, Builders Establish College Scholarship Fund

Carpenters' Local 261 of Scranton, Pa., and the Scranton Builders' Exchange have announced the formation of a "Scholarship Educational Fund." Purpose of the fund is to provide a \$1,000 per year scholarship to a son or daughter of a member of the Scranton local. It will guarantee a \$4,000 total scholarship to the most qualified student, as long as he or she maintains the academic standards of the college or university in which the student enrolls.

The student will have a choice of four institutions: the University of Scranton, Marywood College, the Dunmore Branch of Pennsylvania State University, and Keystone Junior College.

The executive committee to administer the fund includes: Joseph Bartell and Charles Pumilla of Local 261; Michael J. Cestone and Nicholas Scandale of the Scranton Builders' Exchange; Robert E. Dawson, Pennsylvania State University; Jean M. Lynott, Marywood College; John A. Fidel, Keystone Junior College; and Joseph M. Tierney, the University of Scranton.

Parkersburg Hails Long-Time Member

Local 899 of Parkersburg, W. Va., recently noted its obligations to a veteran member. On September 24, 1919, Chester



Gates

E. Gates, was initiated into Local 899, and in his 52 years as a member has not missed more than two or three union meetings.

During this lifetime membership, Mr. Gates has held almost all of the offices and at present is serving as treasurer of the local union, which office he has filled for the past 25 years.

Carpenter Artist



John W. Kyes of Local 2581, Libby, Mont., is an avid and accomplished painter of Western scenes, particularly those showing wildlife. We published reproductions of three of his paintings on our September, 1970, cover. Here is another, showing deer on the Western plains.

Auxiliaries, Please Note

The AFL-CIO's Committee on Political Education, otherwise known as COPE, is holding a series of women's activities conferences in five major cities this spring. Auxiliaries of the Brotherhood are urged to send delegates.

"The national COPE office has long recognized the important role women have played in politics," states COPE's National Director Al Barkan, in announcing the meetings. "We will soon be facing the 1972 Presidential election, as well as important Congressional and state elections. Because of the importance we attach to the activities of our women in all elections, we are calling this series of WAD conferences."

The conferences will be devoted to practical ideas for getting voters registered and candidates elected. There is no registration expense, we are told. Your delegate, or delegates, will be guests of COPE at the luncheon. Any hotel expenses must be borne by the sponsoring organization, however, and delegates make their own hotel reservations.

Meeting times and places are as follows: Chicago—Ambassador Hotel, Wednesday, March 31; Atlanta—Sheraton Biltmore, Thursday, May 20; Philadelphia—Sheraton Philadelphia, Monday, June 14; Phoenix—Ramada Inn, Wednesday, June 23; Seattle—Hyatt House, Sunday, June 27. Further information may be obtained from: Committee on Political Education, AFL-CIO; 815 - 16th Street N.W., Washington, D.C. 20006.

Indiana Industrial Local Honors Retirees



Several members of Local 2818, Monticello, Ind., have retired, in recent months, from work at the local Bryan Manufacturing Company. The local union felt that the old-time employees were not getting sufficient recognition from the employer upon their retirement. It appointed a committee to plan a get-together to honor them. Last November 28, the retirees were honored at a special dinner, and the local plans to make the dinner an annual affair. Each lady was presented a Brotherhood pin and each male retiree an official tie-tac.

Retirees honored included, left to right, front row, above: Lorraine Alpha, Opal Keebly, Edythe Maple, Lavina Mull, Beulah Copas, Maybell Baer, Freida Quade, and Viola Hacker. Back row: Elsie Anwiler, Leora Harmon, Sylvia Malchow, Katherine Ross, Edna Farley, Nellie McFadden, Hazel Overton, Esther Ellis, Louis Quade, and Vernon Weltzin.



Do These Members Attend Your Union Meetings?

■ Some wiseacre, a few years ago, drew up a list of 11 types of members who attend union meetings . . . other than a stable and intelligent soul like yourself.

His list has been published in some state and local journals. It bears repeating. See if you recognize any of the types in your local union:

1. The Confused Listener

He tries to be helpful but can't follow the proceedings. He rises to say there's a motion before the house; and has to be told it was rejected half an hour ago. He has a habit of sitting in the last row and of complaining he can't hear. Throughout he carries an outraged attitude of "why don't people tell me these things."

2. The Professional Seconder

He never thinks up an idea, and is so overwhelmed when someone else does, that he comes in with a loud "second the motion." Any non-sensical scheme any one can think up gets his nod. He then settles back to enjoy the confusion, or does until time for him to chime in with another second.

3. The Willing Voter

He takes little part in business but votes in a loud voice. He is always eager to swell the vote of the prevailing side. A dangerous yes man.

4. The Behind-the-Hand Mutterer

He fumes, fidgets, mutters to his neighbor, but seldom takes the floor to speak. If you sit beside him you will miss hearing the most important points of the meeting. He votes no consistently, and mutters, "What can you do in a mess like this—it's a gang of dopes."

5. The Explode-at-the-Door Man

He sits quietly through the meeting as if everything were to his liking, but at

the door he boils over. You hear him say, as he rounds up a few discontented members, "And another thing I didn't like. . . ."

6. The Next-Day Complainer

After thinking it over he decides the meeting had better be run over. As he corners you he says, "Are you going to stand for that?"

7. The "We-Always-Do-It-This-Way" Member

He is a traditional, forever looking over his shoulder. The old way is the only way. If a change of any kind is suggested, or a new idea brought forth, he fears the new officers are leading up to ruin.

8. The Super-Parliamentarian

He knows all the rules when they are not needed. But when you run into difficulty, and call upon him for advice, he has forgotten his rule book.

9. The Stay-at-Home Member

Meetings bore him. He has his own way of wasting time. Besides he doesn't want to feel responsible for anything that happens. The blood is not on his hands if he didn't go to the meeting.

10. The Obstructionist

He delights in tying the meeting into knots. Anything that he can do to make the meeting so long or unpleasant that members will stay away next time, he will gladly do. He may work with henchmen to wear down the membership so that his gang can take over.

11. The Pre-Meeting Specialist

Before the meeting is held, he explains just what should be done. He is still going strong at 1:30, but by meeting time he is exhausted and has to be guided home. ■

YOU GET MORE
OUT OF THEM
'CAUSE
VAUGHAN
PUTS MORE
INTO THEM!

... AND HAS FOR
MORE THAN
100 YEARS

999
A 20 oz.
heavy duty
beauty Larry
striking face.
14" or 16"
top grade
hickory
handles.
Plain or
milled face.

FIBERGLASS

Exclusive hollow core
design adds greatest
strength, better
balance, absorbs
more shock.
13 to 20 oz.
sizes, nail
and rip.

RIG BUILDER'S HATCHET

Polished 22 oz.
striking head with
flat milled face.
Special 17"
hand
comfort
handle.

SUPER BAR

15" all
purpose pry bar.
A must for every
tool box.

Request catalog illustrating
complete line of striking
tools and pry bars.



**VAUGHAN & BUSHNELL
MFG. CO.**

11414 MAPLE AVE., HEBRON, ILL. 60034

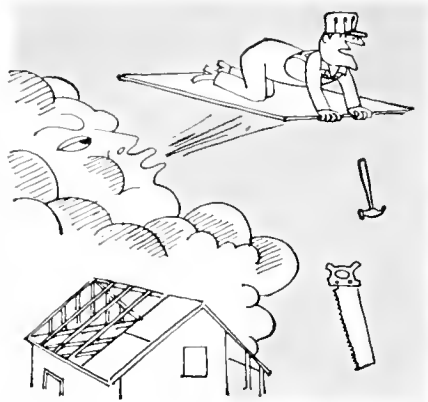

Slight Misunderstanding

The carpenter had lost an eye in an accident and, rather than pay for a glass eye, he made one of wood and painted it as best he could. At a union dance, he was too timid to ask the good-lookers to dance, but he spotted a plain girl with big ears sitting by herself. "I'll ask her!" he decided. Going up to her he said: "Would you like to dance?" Since she hadn't had an offer all evening, she gratefully gushed:

"Would I? Would I!"

To which the carpenter indignantly replied "Big ears! Big ears!"—Phyllis Muro, Los Angeles, Calif.

R U REGISTERED 2 VOTE?



Check and Double-Check!

The doctor called his patient and protested angrily: "That check you gave me has come back!"

"So what?" replied the patient. "So has my arthritis!"—O. G. Zimmerman, Chicago, Illinois.

GIVE A DOLLAR TO CLIC

PLANE GOSSIP

SEND YOUR FAVORITES TO:
PLANE GOSSIP, 101 CONSTITUTION
AVE. NW, WASH., D.C. 20001.
SORRY, BUT NO PAYMENT MADE
AND POETRY NOT ACCEPTED.

Signs of The Times

On a bankrupt amusement park: "Insufficients funs."

In a travel agency window: "Let Yourself Go."

On a perfume counter: "Don't use this if you're bluffing!"

On a laundry truck: "Don't kill your wife; let us do your dirty work!"

On a cleaner's truck: "Come clean with us and we will dye for you."

On an orchard fence: "God help those who help themselves!"

In a recruiting station: "We honor all draft cards."

In a finance company window: "For the man who has everything . . . but hasn't paid for it."—R. F. Fritz, Turners Falls, Mass.

ATTEND YOUR UNION MEETINGS

She Was A Real Sinker!

Our business agent complained to the marriage counsellor that the reason his marriage was going on the rocks was because his wife was so immature. "Would you believe it . . . every time I take a bath she comes in and sinks all my boats!"—Hans Hasse, L.U. 2155, N.Y.C.

GIVE A DOLLAR TO CLIC

Sorry, No Dice!

The taxpayer wrote the Internal Revenue Service: "I invested several thousand dollars in a young lady, try-



This Month's Limerick

I once took the Vicar to tea;
It was just as I thought it would be.
His rumblings abdominal
Were simply abominable
And everyone thought it was me!

ing to negotiate a marriage. But at the last moment she ran out on me. Now, since my tax position is worsened (I can't file a joint return) can I deduct those expenses as a business loss or maybe as a bad debt?"

UNION DUES BUY RAISES

Feels Doggoned Good!

The sawmill operator was happy. "For four months I was convinced I was a fox terrier. But I went to a psychiatrist and he cured me!"

"How are you now?" asked his friend.

"Wonderful!" he exclaimed. "Just feel my nose!"

R U GOIN 2 D UNION MEETING?



Blow Hot, Blow Cold

It'll soon be spring; that time of year when a young man's fancy turns to thoughts of what his girl-friend has been thinking about all winter!

BUY ONLY UNION-MADE TOOLS

Sick Transit Glorio Bumbi

The boomer carpenter was being interviewed for another job. "It says here you left your last spot because of illness," said the personnel man. "What was the nature of the illness?"

"I dunno," replied the boomer. "They just said they were sick of me!"

TAKE PART IN UNION AFFAIRS

His Love's Story?

It was late and the first carpenter said: "I can't stay for a drink . . . I gotta go home and explain to the wife."

"Explain what?" asked his companion.

"How do I know?" asked the first. "I ain't home yet!"

THE CARPENTER

Young Workers Discuss Experiences



Two young St. Louis, Mo. area union members recently went before television cameras for a panel discussion entitled "New Members Look at Their Unions." They were Kenneth Becker, left, above, a Sheet Metal Worker apprentice; and Kenneth Parkin, a Carpenter apprentice. Their interviewer was Newspaper Guild Chairman James B. Woods, right. The discussion was video-taped for an AFL-CIO Conference on "Reaching the Union Member," held in St. Louis in January.

Wyoming Project Superintendent Praises Wealth of Skilled Labor

Casper and surrounding towns in Wyoming are "remarkable for the quality and number of skilled workers in the building trades," the project superintendent for Pacific Power and Light Company's Unit No. 4 recently told *The Casper Star-Tribune*.

Rondo Curtis, project superintendent for Ebasco Services Inc., designer and construction management agent for PP & L's Dave Johnson plant addition, said "There is an exceptional amount of skilled labor available in this area, considering the small population."

Members of Carpenters Local 1564 and other locals have been employed in

the 300-man work crew at Unit No. 4, with a construction payroll approaching \$400,000 a month.

Curtis said he presumed that the reason for the exceptional amount of skilled labor was because of the industry located nearby—oil refineries, oil service industries, and mines.

"There has been a considerable amount of wind and cold this year," Curtis told *The Star-Tribune*, "and this is hard on efficiency. But I have nothing but respect for the spirit and the quality of craftsmen in this Central Wyoming area, as well as the various contractors associated with this project."

Two Governorships at Stake in 1971

This year, 1971, may be an off-year politically but almost every election that does take place will be politically charged for 1972.

Two governorships are at stake this year—Kentucky and Mississippi—only in the Bluegrass State will we get a feel of the political wins. Republican Governor Louie Nunn cannot succeed himself and two moderate Democrats have their eye on the Frankfort post.

In addition to Kentucky and Mississippi, New Jersey and Virginia will elect their state legislatures.

Republicans control the New Jersey legislature and the outcome there could be politically sensitive.

Important races for mayor will take place in Baltimore, Boston, Chicago, Cleveland, Dallas, Denver, Gary, Philadelphia and San Francisco as well as other major cities. Altogether, about 750 cities with more than 150,000 population will be holding municipal elections in 1971.

Special election will be held for House seats in the 1st District of Maryland and in the 1st District of South Carolina.

START A MONEY-MAKING BUSINESS FOR LESS THAN \$50!

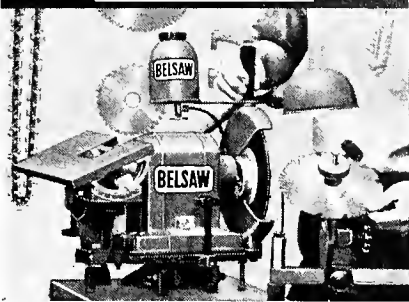

You can have your own lifetime business right at home...work in spare time... and make up to \$200 a month CASH! My FREE PLAN gives you all the facts: How to start, how to grow. You don't need previous experience. You don't have to sell. I'll even finance you. People bring you the work and pay cash. Over 90% of every dollar you collect is clear cash profit. And you work when you want to. Let me prove you can't find a more certain, lower cost, higher paying business of your own.

Just Mail Coupon—No Salesman Will Call

BELSAW SHARP-ALL CO.
Stan Field, President
731M Field Bldg., Kansas City, Mo. 64111

FREE BOOK

Name _____

Address _____

City _____ State _____ Zip _____

The Real Pros demand Lee

Designed by Carpenters Especially for Carpenters

There's plenty of comfort, convenience and work-saving features in these overalls. Made just like you want 'em... because they're designed by workers like yourself. Guaranteed to be the best you've ever worn or we'll take 'em back. No questions asked.

Lee® UNION MADE
M.R. CARPENTERS' OVERALLS

H. O. LEE COMPANY, INC.
SHAWNEE MISSION, KANSAS 66201
"World's largest manufacturer of union-made workwear."

VF



Outdoor soup kitchens such as this one in New York City in 1932 kept workers from starving. Unemployment compensation checks and food stamps are only limited substitutes for jobs today.



The WPA and PWA Put Men Back to Work, Mr. Nixon *...and took them off welfare*

By Press Associates, Inc.

A public works project in Charleston, S.C., during the Depression of the Thirties. Such projects kept men working and improved their communities as well.



■ When President Nixon vetoed the Manpower Bill that would have created public service jobs, he sneered at the work programs of New Deal days as leading to dead-end jobs that did nobody any good. His words were his own, but the voice was that of Herbert Hoover.

“WPA-type jobs” Nixon said, “are not the answer for the men and women who have them, for government which is less efficient as a result, or for the taxpayers who must foot the bill.”

In his veto message, the President echoed with startling similarity the Hoover-Republican outcries of 35 years ago when the Roosevelt Administration came to the conclusion that the private economy could not provide desperately needed jobs and that only a combination of public and private job-producing measures could help save the 16 million unemployed.

Was the Nixon jibe at the Works Progress Administration, the Public Works Administration, the Civilian Conservation Corps and similar programs of the New Deal days really justified?

The record is to the contrary.

The record of the WPA as laid down in its final report showed that at its peak 3.5 million men and women on relief had been given gainful employment; that 18 billion hours of work had been performed; that at one time or another 8.5 million persons with 30 million dependents had worked for the WPA.

The Tally Sheet

These men and women had constructed or repaired 650,000 miles of highways, roads and streets; had built nearly 40,000 new public buildings across the face of the country and had helped improve 85,000 existing buildings; had built or improved thousands of parks, playgrounds and recreational centers; had helped improve sanitation services and had worked on thousands of airports and airway facilities.

Today—thanks to WPA workers—Americans can enjoy facilities of New York’s Central Park Zoo; the San Francisco Aquatic Park, Chicago’s water-front, the Philadelphia Art Museum as well as thousands of

libraries, hospitals, municipal buildings, swimming pools—the list is endless.

Perhaps even greater results were achieved by the Public Works Administration which built structures as the Grand Coulee Dam, and the Civilian Conservation Corps which took thousands of unemployed boys off the streets and put them to useful work in conservation and reforestation.

What 'Dead-End' Jobs?

The Nixon veto-message jibes at "dead-end" jobs was strongly resented by liberal members of Congress who pointed out the unfairness of the criticism of the WPA program and the even more unjust criticism of the Manpower Bill which went out of its way to assure that the measure would provide for useful work.

They could point to the insistence of much-maligned Harry Hopkins, WPA head who repeatedly pointed out the advantages of work to "relief."

"Work for the unemployed is something we have fought for since the beginning of this Administration and we shall continue to insist upon it," Hopkins said in a 1934 radio address. "Work preserves a man's morale. It saves his skills. It gives him a chance to do something socially useful."

The vetoed Manpower Bill—so strongly supported by organized labor—sought to do the same.

The program is to have a new chance in the current 92nd Congress. A similar bill will be introduced by Rep. James G. O'Hara, (D-Mich.), who led the fight for the vetoed measure.

It was with some bitterness that O'Hara commented on the Nixon sneer at WPA-type jobs in the veto message.

"Well," he told Congress, "there was much wrong with the WPA, but I am just barely old enough to remember that it did give people jobs. I am just old enough, Mr. Speaker, to remember that a WPA-type job was a whale of a lot better for the spirit and for the stomach than a Hoover-type breadline. The President apparently feels just the opposite." ■

DO "101" MEASURING JOBS

with Berger Transits and Levels

- Establish foundation heights. ■ Level floors ■ Set lintels ■ Mark batter boards ■ Plumb columns and walls ■ Set first course of siding ■ Determine differences in elevation ■ Measure angles ■ Set nails for concrete lines
- Align retaining walls ■ Pick up elevations for finished floors ■ Measure hung ceiling heights ■ Set door bucks

You move in on a job faster—move out faster, too—and always know you're on the button with a Berger level or transit. Eliminate costly "do-overs," too. That's why you see so many carpenters measuring with a Berger. And so many carpenter union training programs working with it.

FREE 24-pg. BOOKLET "How to Use Transits and Levels." Gives helpful field hints... illustrates scores of uses you may not have thought of.

BERGER

37C Williams Street, Boston, Mass. 02119
Engineering and Surveying Instruments... since 1871

Berger Convertible Transit-Level (Model 320) \$245. Other models from \$80. to \$340. Prices FOB Boston. Tripod extra.

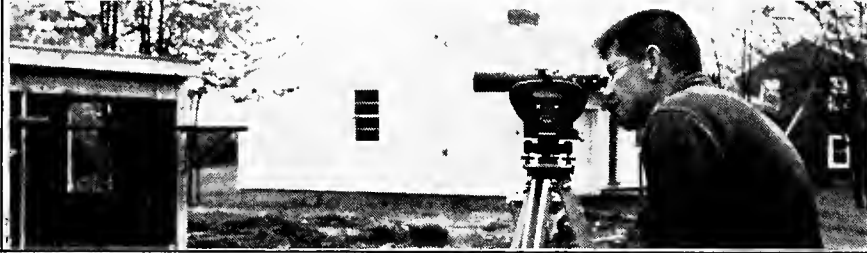



CORNER

NEW

Flex Corner® is made for all corners, arches, bay windows and angles impractical for ordinary beads. Flex Corner® insures perfect corners or any angles—adds strength to joints and corners. Just cut the length you need, fold at center margin and apply with metal facing the wall. Feathered edges blend perfectly into the surface, removing all traces of irregularities. Apply with joint cement as with paper tape.

DRYWALLTAPE



NEW WALLBOARD LIFTER
... THE KIKLIFT™ Cast aluminum, heat treated for strength. Correctly balanced with lip always on the floor. Move and position with your foot, kick under wallboard and lift. A non-skid surface gives the foot traction needed.

Send for FREE copy of the new 1971 Goldblatt Catalog, more than 1200 Trowel Trades Tools. Goldblatt Tool Co., 521C Osage, Kansas City, Kansas 66110



Div. of Bliss & Laughlin Industries



CLIC's '71 Drive Gets Underway

■ The 1971 fund-raising campaign of the Carpenters Legislative Improvement Committee is being launched this month, and the financial secretaries of local unions all over the United States will soon be receiving receipt books, buttons, and all the other material necessary for making this year's drive a success.

Peter E. Terzick, director of CLIC, has sent letters to CLIC representatives in every local union, similar to the one reproduced at right, addressed to Financial Secretary Richard Garnett of Local 1, Chicago.

The First Session of the 92nd Congress is well underway, and

CLIC representatives are now at work on Capitol Hill on behalf of legislation which will help carpenters, mill-cabinet makers, millwrights, and all other trade unionists.

Plans are being formulated for an active year of voter registration in preparation for the 1972 political campaigns. There are still thousands of members, their wives, and adult members of their families who have not registered to cast ballots in the fall elections.

Members are urged to form active local units of CLIC to solicit voluntary donations and help in voter registration drives and "get out the vote" campaigns.

The Carpenters Legislative Improvement Committee is now in its seventh year of activity. It grew out of personal and volunteer work by the Brotherhood's General Officers in 1964, who recognized the growing importance of legislation and governmental action on union members' jobs. The Brotherhood's General Officers, Board Members, and Representatives began voluntarily contributing 2% of their own earnings to start a special fund for political action and legislative work in Washington. They did so because they recognized the great need for a strong voice to protect labor's interests. Out of this work CLIC was established.

With the funds collected, CLIC has been able to give Brotherhood members good representation in legislative and executive halls. Members have reaped substantial dividends from the results achieved. ■

Help CLIC Turn The Trick

... to build a better nation through better legislation

It is extremely important that the Brotherhood be represented on a day-to-day basis in Washington.

As Samuel Gompers has stated, labor must support its friends and defeat its enemies. Supporting its friends continues after they are in office.

As everyone knows, Federal law prevents the use of union funds for political purposes. Every cent of money used by organized labor for political purposes must come from individual members on a voluntary basis.

Receipt books are being forwarded to all financial secretaries in the United States shortly. In turn, the secretaries will solicit members for a contribution of at least \$1 to further the work of CLIC. You can become a charter member of CLIC by making a contribution when your financial secretary asks you to do so.

While it is true that hardly a day goes by that does not see someone asking a contribution for a worthy cause, the work of CLIC is a bread and butter matter. The work that CLIC can do with adequate funds can return dividends a hundredfold into the pockets of our members.

When your financial secretary asks you to make a contribution to CLIC, you will be protecting your own interests when you respond.

SUPPORT CARPENTERS LEGISLATIVE IMPROVEMENT COMMITTEE



Peter Terzick
DIRECTOR

James Bailey
LEGISLATIVE REPRESENTATIVE

101 CONSTITUTION AVE., N.W., WASHINGTON, D. C. 20001

Carpenters' Legislative Improvement Committee

February 22, 1971

Mr. Richard Garnett, F. S.
Local Union No. 1
176 W. Adams Street
Chicago, Illinois 60603

Dear Sir and Brother:

The 1971 Campaign of the Carpenters Legislative Improvement Committee, "CLIC", will get underway as of early March. Under separate cover, you will receive "CLIC" receipt books and buttons; the number of books and their serial numbers are noted below.

Your members are well aware that lean times have prevailed in the construction industry in many parts of the nation. The tight money policies of the administration and the holdback of housing funds have led to high unemployment in construction.

Through "CLIC", our Brotherhood, in cooperation with other Building Trades Unions, is pushing hard for a reversal of the policies which have held back construction. Our effectiveness will be directly tied to the help we have been able to give Congressmen and Senators through "CLIC".

"CLIC" is our first line of defense against more unemployment, more inflation, and more anti-labor legislation.

As in previous years, a special lapel button will be provided for each member contributing \$10.00 or more to the political drive. When making your returns, we request that you list separately the names of such contributors so that we can forward a lapel pin to them as quickly as possible.

We sincerely hope your local union will make a real effort to secure voluntary contributions of at least \$1.00 per member this year.

With warmest regards, I remain

BKS. SER. NOS.

Fraternally yours,
Peter E. Terzick

Peter E. Terzick, Director
Carpenters Legislative
Improvement Committee

PET/JFB/slk



APPRENTICESHIP & TRAINING

More Apprentices Among Minority Groups

■ A steady and pronounced increase in the number of carpenter apprentices from minority groups is reported by First General Vice President William Sidell.

Updating of Carpenter records shows that, since the approval of the original Manpower Development and Training Act contract on November 17, 1966, a total of 4,898 individuals has entered various Carpenter pre-apprenticeship classes. Of these, 1,431 (29 percent) were from minority groups.

Not all those who entered the classes finished the courses. A total of 3,306 completed the work. And of this number, 642 (19 percent) were from minority groups.

Sidell, in his report to General President M. A. Hutcheson, disclosed that 2,483 individuals entered the so-called Type II Apprentice Entry Programs. Of these, 461 (18 percent) were from minority groups. Of the 1,609 who completed this work, 190 (11 percent) were from minority groups.

A compilation of both programs shows that 7,381 entered and 4,915 completed. Entrants from minority groups totaled 25.7 percent and completions 16.9 percent.

Sidell said that of the 4,915 individuals who completed the work, 80 percent still were in the trade. And 732 of them (18 percent) are from minority groups.

Sidell also announced that the two experimental Operation Transition Centers which opened in 1970 have

been so successful that eight additional centers will be operative by March 1. Operation Transition Centers are for servicemen about to be separated from the armed services. They receive a six-week training period in what is necessary to become a skilled craftsman via the apprenticeship route.

Already, 121 individuals have been referred from Operation Transition Centers to Joint Apprenticeship Committees and Local Unions for placement in their apprenticeship programs. Approximately 20 percent are from minority groups.

The first two centers are Fort Lewis, Wash. and Camp Pendleton, Calif. Between now and March 1, centers will be opened and training commenced at Fort Bragg, N.C., Fort Riley, Kan., Fort Carson, Colo., Fort Gordon, Ga., Fort Hood, Tex., Fort Benning, Ga., Fort Campbell, Ky. and Fort Sill, Okla.

Concerning the Carpenters' Job Corps Program, which was approved May 20, 1968, Sidell said that, despite closings throughout the country by executive order, programs are now being conducted in 26 centers.

If the enrollment is up to capacity, there are 885 training slots in the Job Corps program. Composite of the groups is about 65 percent black and 15 percent from other minority groups. As of January 1, 1971, the Carpenters placed 525 of these young men in apprenticeship programs, 341 of them black and 80 from other minority groups. ■

APPRENTICESHIP CONTESTS CALENDAR FOR 1971

State	Carpenter	Mill	
		Cabinet	Millwright
Alabama	X		
Alaska	X		
Arizona	X		X
California	X	X	X
(June 17, 18 & 19)			
Colorado	X	X	X
Connecticut	X		
Delaware	X		
District of Columbia	X	X	X
Florida	X		
(May 13)			
Hawaii	X		
Illinois	X	X	X
Indiana	X	X	X
Iowa	X		
Kentucky	X		X
Louisiana	X		X
Maryland	X	X	X
Massachusetts	X	X	
Michigan	X		X
Nebraska	X		
New Mexico	X		
New York	X	X	X
(May 6, 7 & 8)			
Ohio	X		
Oklahoma	X	X	
Oregon	X	X	X
Pennsylvania	X	X	X
Tennessee	X		X
Texas	X		X
Utah	X		
Virginia	X		
Wisconsin	X		
Wyoming	X		
Alberta	X		
(May 16 & 17)			
British Columbia	X	X	
Ontario	X		X
(April 22 & 23)			
Saskatchewan	X		
Totals	35	12	16

1971 Carpenters International Apprenticeship Contest, August 12, 13, 14, in Detroit, Michigan.

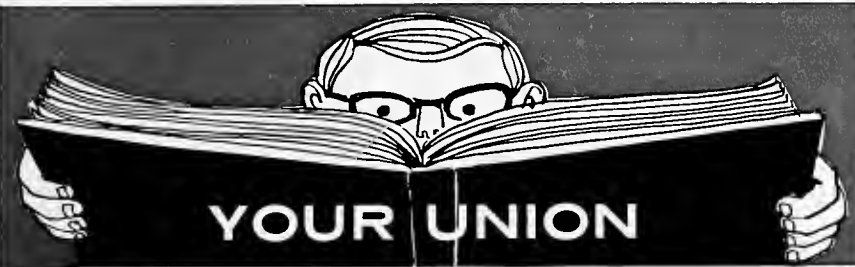

YOUR UNION DICTIONARY

This is the first of a new feature series planned to keep you better informed on the meanings of terms related to collective bargaining, union contracts, and union business. Follow it closely, and your union membership will become more meaningful, and your ability to participate in decisions which affect your future and security will be strengthened. It was compiled by the International Labor Press Assn. and is used with permission.

A

ability to pay: In collective bargaining, the ability of management to meet the financial demands of a union. (This depends on the financial condition of the company and is often hotly disputed.)

across-the-board increase: A general pay increase affecting equally all or most of the employees covered by a contract. May be in percentage or cents-per-hour.

administrative officer: Title, in certain unions, of business agent.

affecting interstate commerce: The point that determines whether an enterprise is subject to federal regulation. The NLRB has ruled that manufacturers who buy or sell \$50,000 worth of goods a year across state lines, and retailers with a gross volume of \$500,000 or more, fall under its jurisdiction; the courts have agreed.

affiliation: The association of a local or international union with a larger group, e.g., of a state, national or international labor union federation.

agency shop: A collective bargaining agreement providing that employees covered by the contract who refuse to join the union must pay a service fee to the union equal to union dues. This is predicated on the fact that by law, a union must give full and equal protection to all members of the bargaining unit it represents.

agreement, collective: A contract (agreement and contract are used interchangeably) between a union, acting as bargaining agent, and an employer, covering wages, hours, working conditions and fringe benefits.

allowed time: For incentive workers, time allowed for tool care, fatigue and personal needs.

American Arbitration Association: Private group offering expert arbitration services in labor and other disputes. Non-partisan and non-profit.

annual improvement factor: Contract clause providing for annual wage increase of stated amount as a share in increased productivity.

annual wage: Guarantee of a minimum income and/or hours total, during a year.

antitrust laws: Designed to bar unlawful restraints and activities affecting trade and commerce, these federal and state statutes were once used as anti-union weapons.

apprentice: In the skilled trades, a learner who is under supervision as to his work experience, often with related classroom studies. Completion of 4-5 years of apprenticeship leads to journeyman status.

Planer · Molder · Saw!

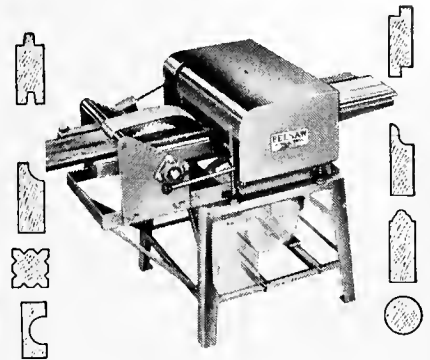

Now you can use this ONE power feed shop to turn rough lumber into high-value moldings, trim, flooring, furniture... ALL popular patterns.

RIP... PLANE... MOLD... separately or all at once by power feed... with a one horse-power motor. Use 3 to 5 HP for high speed commercial output.

LOW COST... You can own this MONEY MAKING POWER TOOL for only... **\$30.00** down. Send coupon today... No salesman will call

BELSAW POWER TOOLS

941M Field Bldg., Kansas City, Mo. 64111

Send me complete facts on the MULTI-DUTY Power Tool. No obligation.

Name _____

Address _____

City _____ State _____ Zip _____

BE A PANELING EXPERT

Take all the guesswork out of aligning and marking corner panels with our kit of rugged aluminum off-set jigs and marking gauges.

Increase your speed and accuracy as you scribe perfect panels marked for a "pressed-in" fit. Panel-by-panel instructions included for inside and outside corners and for the location of cut-outs, for plywood panels of 1/4" or less.



NOW .. OFFSET JIGS FOR ROUTERS

A Cut-In-Place method of fitting inside corner panels. The router takes the place of the marking gauge or scriber and precisely cuts over 90% of an 8 ft. panel. Complete instruct.

Offset jigs and marking gauges. \$9.95 Postpaid. (Calif. tax 50¢)

Cut-In-Place jigs for your router. \$6.95 Postpaid. (Calif. tax 35¢)

Only Californians add sales tax.

C.O.D. orders: you pay postage and charges. Satisfaction guaranteed or money refunded.

A revolutionary new tool dolly!

Heavy duty compact design • turns on a dime • jumps electric cords with ease

Detailed Construction Plans — \$1.95. Check or M.O. Californians add 10¢ tax.

PANELING SPECIALTIES CO.
Box 11764 • Palo Alto, Calif. 94306

Estwing

FIRST CHOICE of Skilled Craftsmen for Nearly 50 Years

Make Your Next Hammer An Estwing!

Forged One-Piece Solia Steel—

Supreme Nail Hammer



Strongest Construction Known

Unsurpassed Estwing Temper Balance & Finish

22 oz. Rafter & Framing Hammer

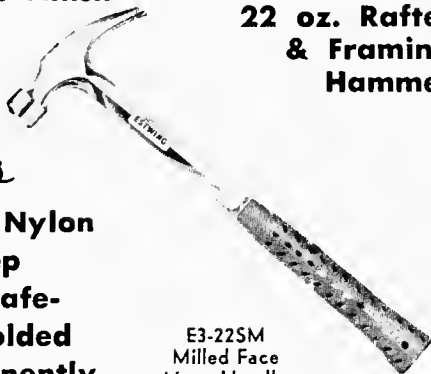

Plus

Exclusive Nylon Vinyl Deep Cushion Safe-T-Grip Molded on Permanently

These and Other Quality Estwing Tools Are Available At Leading Hardware, Lumber And Building Supply Dealers.

IN SUPPORT OF THE GOVERNMENT CONSUMER PROTECTION PROGRAM

Estwing Tools Carry the Following Advance Warning

"Nail and Ripping Hammers Are Made To Drive Or Withdraw Common Nails— Any Other Use May Be Hazardous"

Always Wear Estwing Safety Goggles

Estwing 

Mfg. Co. 2647—8th Dept. C-3 Rockford, Ill. 61101

Detroit Graduates 143 At Annual Banquet



Among those at the head table for Detroit's 25th Annual Carpenters Apprentice Banquet were, from left: John Harrington, secretary-treasurer of the Detroit District Council; Jerome Rospierski of East Detroit Carpenters Local 26, who represented Michigan in last year's International Apprenticeship Contest; Anthony "Pete" Oehocki, the Brotherhood's director of organization; Raymond Fair, chairman of the joint apprenticeship committee; Leo Gable, technical director of the Brotherhood; and Jack Wood, secretary-manager of the Detroit Building Trades Council.

A total of 143 carpentry apprentices—all members of eight local unions of the Detroit, Mich., District Council—graduated in impressive ceremonies recently.

They were presented certificates at the council's 25th Annual Apprentice Graduation Banquet held at the Raleigh House.

The program was dedicated to the late Stuart Proctor, head carpentry instructor from 1941 to 1963 and a member of the international union's Apprenticeship Committee until his death last year.

Leo Gable, technical director of the United Brotherhood of Carpenters and Joiners of America, was the principal speaker. He received able help from three others on the speaking agenda, John R. Harrington, CDC secretary-treasurer; Irvin H. Yackness, of the Builders Association of Metropolitan Detroit, and Raymond Fair, chairman of the sponsoring Detroit Carpentry Joint Apprenticeship Committee and CDC president.

In addition, Joseph Rospierski, a graduate apprentice and member of East Detroit Carpenters Local 26 who represented Michigan in the union's national contest last year, presented his views.

Chris Magnusson, executive-secretary of the Michigan Carpentry Contractors Association, served as toastmaster. Doing the honors as chairman was Clay Langston, of the Associated General Contractors who also is secretary of the JAC.

Gable first paid tribute "to my old friend Stuart Proctor" with whom he said he had worked at both local and national levels.

He explained that "the apprentice program has only started" and that "if you want improvements made you will have to help."

"This help can be provided by being constructive workers and active in your local unions and your affairs involving management. The biggest contribution would be by taking pride in your work," Gable added.

Joel Bergman, Kenneth Rosemeck and Dennis Campbell were presented with awards for finishing one, two, three in last year's local contest.

Among the honored guests were Jack Wood, secretary-manager of the Detroit Building Trades Council, and Stan Arnold, secretary-treasurer of the Michigan Building and Construction Trades Council.



FOREMAN



SUPERINTENDENT



ESTIMATOR



CONTRACTOR

These well-paid positions need you now!

The best-paying jobs in building are being filled by former carpenters and apprentices.

The "population explosion" is in full bloom. Men like yourself are being counted on to supervise the construction work on millions of new houses, apartments, factories, office buildings and institutions. The question is: Do you have the all-around construction know-how needed to step up to these better paying positions? . . . If not, Chicago Tech can show you how to prepare to take advantage of these job opportunities.

All facts sent FREE . . .

it won't cost you a penny

With your permission, Chicago Tech will send you the latest book on Builder's Training and

CHICAGO TECHNICAL COLLEGE

ESTABLISHED 1904 TECH BLDG., 2000 SOUTH MICHIGAN AVE., CHICAGO, ILL. 60616

Trial lesson in blueprint reading • Builder's training manual • Set of actual blueprints

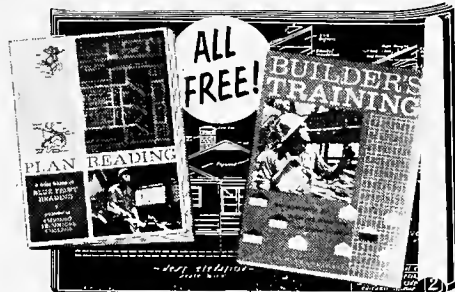

Opportunities—Plus a Free Trial Lesson with complete set of Blueprints.

Chicago Tech Builder's Training is practical, down-to-earth and is specially prepared for study at home in your spare time. The Free Trial Lesson will show you how easy it is to learn the Chicago Tech way. No special schooling is required and it will not interfere with your present work. You learn while you earn merely by devoting a few hours each week to study.

As a building tradesman you are in a choice spot to cash in on this tremendous growth of the building industry. Your reward can be higher pay, more secure employment, plus the added prestige of a top job in building. So act now—get the facts—mail the coupon today!

Builder's Training—by builders for builders

Chicago Technical College New G.I. Bill!
C-143 Tech Bldg., Vets check here
2000 S. Michigan Ave.
Chicago, Illinois 60616

Please mail me Free Trial Lesson, Blueprints and Catalog.

Name _____ Age _____

Address _____

City _____ State _____ Zip _____

Occupation _____

Accredited Member National Home Study Council

IN CONCLUSION

Continued from Page 40

of the economic structure is allowed to do business as usual.

In the past decade medical costs have increased by 165 percent. The rate of increase for the medical profession has been double that of other goods and services. Since nothing is more important to the American people than maintaining health, it seems to me that the whole medical complex could get a little attention from the President, if he is as interested in curbing inflation as he tries to convince the building trades that he is.

The profits of the defense industries are another place where some serious inflationary pressures could be uncovered. A recent newspaper column claimed that the General Accounting Office recently uncovered instances of defense contractors making as much as 56 percent profit. So far the President has ignored this part of our economy.

On the other hand, he has been constantly harping on the wages of building tradesmen. He has repeatedly quoted 18 percent as the figure by which building trades wages increased in the past year. His own Department of Labor sets the figure at 11.9 percent increase for the year ending January 4, 1971.

The President somehow or other seems to be ob-

sessed with the wages of blue-collar workers. One of his first actions this year was to veto a bill providing for a wage increase for blue-collar government workers.

The wage rates of craftsmen employed by Uncle Sam have lagged sadly behind the wages of comparable categories of white-collar government employees as well as the wages paid by private contractors for similar work. The bill he vetoed was designed to do nothing more than to equalize the earnings of blue-collar and white-collar employees. For reasons known only to himself, the President found this unacceptable.

Apparently those workers who wear a blue collar rate very low on his totem pole. First he vetoed a long-overdue increase for craftsmen on the government payroll. Next he wiped out Davis-Bacon protection for mechanics working in the private sector.

Certainly, cracking down on building tradesmen, whose annual earnings do not lead the parade, is not likely to have much impact on the problem of inflation. By the same token, it can hardly be construed as a measure of genuine statesmanship.

The time for grandstanding and political opportunism has long since passed. I am afraid that Mr. Nixon's action is motivated by both of these considerations. I do not think those who earn their livelihood in the construction trades are very likely to forget or to forgive. ■



1

SERVICE to the BROTHERHOOD

A gallery of pictures showing some of the senior members of the Brotherhood who recently received 25-year or 50-year service pins.

(1) SACRAMENTO, CALIF. — Photographs were taken at Local 2170's recent dinner honoring 25- and 50-year members, on November 14, 1970.

The photo shows three members being presented their 50-year pins by President Jenevah Dingman. Reading left to right, are: M. C. Davis, R. I. Corum and John Speck.

(1A) The group photo taken by Local 2170 reading left to right: H. J. Nielson, executive secretary of the district council (seated), President Jenevah Dingman presenting pins to members with 25-years or more: W. E. Pfeiffer (financial secretary), F. M. Amundsen, L. D. Bartholmew, Merle Curtice, Ray Evans, Dino Franceschini, Roy Hughes, George Katelan, Paul Weindel and Paul Mannen.



1-A

(2) HALEAH, FLA.—At its anniversary party held recently, Local 727 presented 25-year pins to the following: Front row,



2



3

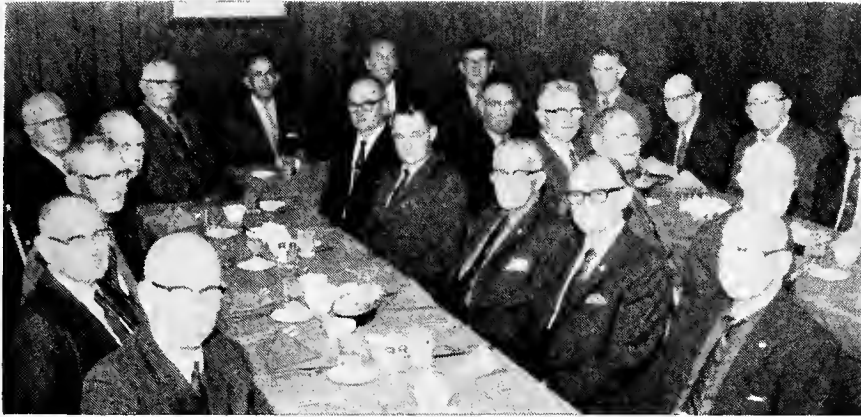

4

left to right, William L. Elmore, Earl E. Garrow, Austin Douberley, Emil Kubler, Thomas A. Jones, La Verne Decker, Lee Dalton, and William Boling. Back row, left to right, Bryce Vieten, Sr., Arthur N. Simon, John Pearson, Jr., Robert McKenna, Lynn McGowan, Henry McDonald, Rene La Bonte, and Jacob H. Sell.

(3) APPLETON, WISC.—Local No. 955 of the Fox River Valley presented 25 and 50-year pins at its Christmas party.

A dinner, with 100 door prizes, a dance with refreshments, were offered with the compliments of Local 955.

In the picture, left to right, front row, are: John Palmbach (34 years), Ed Abel (50 years), Walter Kruger (40 years), Norm Winkler (38 years), Leo Steffens (26 years), and Financial Secretary L. W. Hein (35 years). Back row, left to right, are: John Kolbs (27 years), Lawrence Kohl (26 years), Ed Ginnow (28 years), Carlton Cook (25 years), President Arnie Seyfert (27 years), Frank Kieffer (26 years), Paul VandenBoogard (26 years), Harry Gebheim (37 years), John Van Handle (25 years), Bob Steinberg (26 years), Earl Hegner (34 years), Harold Hoier (25 years), Oscar Van Rizin (25 year), and Francis Weiland (33 years). Not present were: John Mielke (54 years), Paul Schubert (54 years), and Herman Stueck (54 years).

(4) SHEFFIELD, ALA. — Harold E. Lewis, 4th District recently presented 25-

and 50-year pins to members of Local Board Number, 109, Sheffield, at a banquet held at the Holiday Inn.

Those receiving 25-year pins were: O. E. Grainger, C. H. Bunt, Carl Moyers, J. G. Clark, W. T. Curtis, Ralph Newbern, R. A. Murphy and J. T. Rhodes.

Those receiving 50-year pins were: A. J. Peeden, Sam Bounds, and J. A. Hakola.

Pictured, left to right are: O. E. Grainger; C. H. Bunt; L. E. Butler, treasurer; A. L. Parker, trustee; C. M. Strickland, trustee; J. M. Thornton, fin. sec.; I. Q. Thompson, vice-pres.; J. H. Whitfield, warden; B. L. Watkins, conductor; Carl Moyers; George Hennegar, special representative; A. J. Peeden. On the right side, table: Sam Bounds; J. G. Clark; W. T. Curtis; Ralph Newbern; H. E. Lewis, 4th District Board Member; H. Troy Miles, bus. rep.; R. L. Moore, rec. sec.; B. T. Durham, special representative; R. A. Murphy; and J. T. Rhodes.

(5) NASHUA, N.H.—Local 1616 recognized 150 years of total service to the Brotherhood, January 6, by awarding 30-year service pins to five members. Four of the members, shown in the picture, include, from left, Roscoe Goodale, Nelson Parkhurst, Pascal Gallant, and Henry Gilchrist. Not present for the picture but also honored was Aurele Pontbriand. Pins were presented by Local 1616 President Edward Stepanian. The local's charter was issued on July 8, 1914, more than 56 years ago.



5

new AUDEL CARPENTERS & BUILDERS GUIDES

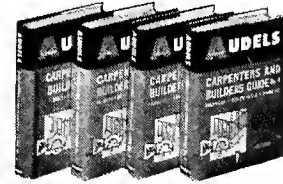

4 VOLS.
1616 Pages
Heavily Illustr.
ONLY \$18.50

INSIDE TRADE INFORMATION—for Carpenters, Builders, Joiners, Building Mechanics and all Woodworkers. Here are the short-cuts you want—new methods, ideas, solutions, plans, systems and money-saving suggestions. A complete course for the apprentice—a practical daily help and Quick Reference for the master worker. Mail COUPON TODAY to get these helpful guides used by thousands of carpenters. Shows you—

HOW TO USE: Mitre Box, Chalk Line, Rules & Scales, Steel Square & Settings 12, 13 & 17. **HOW TO BUILD:** Furniture, Cabinetwork, Houses, Barns, Garages, Skylights, Stairs, Hoists, Scaffolds. **HOW TO:** File & Set Saws, Do Carpenters' Arithmetic, Solve Mensuration Problems, Estimate Strength of Timbers, Set Girders & Sills, Frame Houses & Roofs, Estimate Costs, Read & Draw Plans, Draw Up Specifications, Excavate, Lath, Lay Floors, Hang Doors, Put On Interior Trim, Insulate, Paint.

MONEY BACK GUARANTEE

You must be COMPLETELY satisfied with the Audel Guides you order, or you may return them within 10 days and get your money back.



ORDER NOW!

MAIL COUPON TODAY

THEO. AUDEL & CO., 4300 W. 62nd St. C-031
Indianapolis, Ind. 46268

Please mail me Carpenters & Builders Guides, 4 Vols. Enclosed is down payment of \$6.00. I agree to pay balance, including shipping costs, within 30 days. If I am not completely satisfied with my Audel Guides I may return them for refund.

Name _____

Address _____

City _____ State _____ Zip _____

SAVE SHIPPING COSTS. Enclose \$18.50 (plus sales tax, if any) and we pay postage.

LAYOUT LEVEL



- ACCURATE TO 1/32"
- REACHES 100 FT.
- ONE-MAN OPERATION

Save Time, Money, do a Better Job
With This Modern Water Level

In just a few minutes you accurately set battens for slabs and footings, lay out inside floors, ceilings, forms, fixtures, and check foundations for remodeling.

HYDROLEVEL is the old reliable water level with modern features. Toolbox size. Durable 7" container with exclusive reservoir, keeps level filled and ready. 50 ft. clear tough 3/10" tube gives you 100 ft. of leveling in each set-up, with 1/32" accuracy and fast one-man operation—outside, inside, around corners, over obstructions. Anywhere you can climb or crawl!

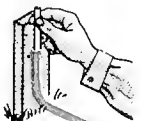

Why waste money on delicate instruments, or lose time and accuracy on makeshift leveling? Since 1950 thousands of carpenters, builders, inside trades, etc. have found that HYDROLEVEL pays for itself quickly.

Clip this ad to your business stationery and mail today. We will push you a Hydro-level with complete instructions and bill you for only \$7.95 plus postage. Or send check or money order and we pay the postage. Satisfaction guaranteed or money back.

Ask your tool dealer to order it for you. We allow the usual dealer discount on 1/4 Doz. lots and give return-mail service.

HYDROLEVEL

925 DeSoto, Ocean Springs, Miss. 39564
FIRST IN WATER LEVEL DESIGN SINCE 1950



IN MEMORIAM

L.U. NO. 8 PHILADELPHIA, PA.

Bachman, Edgar H.
Larson, Carl S.
Miller, LeRoy
Sandstrom, Arthur
Weiss, Henry C.

L.U. NO. 12 SYRACUSE, N.Y.

Gottstein, William

L.U. NO. 13 CHICAGO, ILL.

Anderson, S. E.
Gaddis, Homer
Janson, Michael
Kalis, Edward E.
Kubat, Jerome A.
Miller, Royden T.
Sharpe, Daniel
Shoberg, H.
Smith, Anthony
Winter, William

L.U. NO. 19 DETROIT, MICH.

Ammons, Archie L.
Andrews, Alvin
Assalley, William
Ball, Clyde
Buxton, Ted
Cathey, William G.
DeCare, Fred
Derbin, Edward
Elliott, Edward C.
Hamilton, Jack
Hopwood, James W.
Intsons, Willy
Kogelschatz, Glen A.
Latka, Anthony
Leipus, Anthony
Lofgren, Matts
MacDonald, Robert
Marty, Camille J.
Millar, Robert
Motson, Leslie
Mullins, Ralph
Schramm, Harry
Schweitzer, Antol
Sine, Frank
Stewart, William C.
Thompson, Henry
Welsh, Jack
Wightman, John C.

L.U. NO. 23 DOVER, N.J.

Eklund, Kust
Hennessey, Thomas
Johnston, George
Knothe, Edward
Komula, Edward
Shaw, Norman

L.U. NO. 30 NEW LONDON, CONN.

Chagnon, Paul
Couture, Louis R.
Hilton, Henry
Kloptowski, Mychajlo
Ortman, William
Phillips, Francis H.
Spencer, Fred
Veroneau, Roland
Wiitanen, Ansel
Zigarro, Rosario

L.U. NO. 34 SAN FRANCISCO, CALIF.

Manbeck, William N.
Paul, Albert L.
Wilson, Warren

L.U. NO. 35 SAN RAFAEL, CALIF.

Fraser, R. E.
Hockerson, George

L.U. NO. 50 KNOXVILLE, TENN.

Stanley, H. D.
Tillett, J. M.

L.U. NO. 62 CHICAGO, ILL.

Anderson, Louis
Danielson, John
Erlandson, George
Hansmann, William F.
Johnson, Eric
Landow, William E.
Nelson, Martin H.
Sage, Paul

L.U. NO. 65 PERTH AMBOY, N.J.

Fitzsimmonds, Edward
Gerzoff, Max
Nelson, Fritz
Rinko, George

L.U. NO. 69 CANTON, OHIO

Green, Charles E.
Hykes, Paul A.
Jury, Donald R.
Keck, James R.
Kiko, Russell E.
Oneacre, Julius
Sweany, A. P.
Unger, Andrew
Young, Charles S.

L.U. NO. 71 FT. SMITH, ARK.

Agee, John F.
Brodie, William B.
Cook, Russell L.
Jackson, R. L.
Johnson, Mose
Leiter, K. E.
Minard, Charles F.
Rotkahr, Lawrence

L.U. NO. 74 CHATTANOOGA, TENN.

Bender, Z. B.
Morton, A. R.
Myers, James C.
Nicholas, Joe J.
Slaten, George
Thomason, Jack W.

L.U. NO. 121 VINELAND, N.J.

Bracalillo, John
Kissell, Mike
Seeds, Harry

L.U. NO. 132 WASHINGTON, D.C.

Arner, Walter B.
Coyne, Stephen
Davis, Thomas H.
Richardson, Beverly C.

L.U. NO. 144 MACON, GA.

Thomas, Carson C.

L.U. NO. 155 PLAINFIELD, N. J.

Averill, Lyle
Derlinger, Harry
Miller, Cornelius
Thomas, Walter J.
Yoerg, Lawrence

L.U. NO. 181 CHICAGO, ILL.

Holmquist, Titus
Pedersen, Harold

L.U. NO. 188 YONKERS, N.Y.

Williams, John R.

L.U. NO. 226 PORTLAND, ORE.

Desinger, Carl
Schneider, Fritz W.
Wells, John

L.U. NO. 241 MOLINE, ILL.

Hostens, Arthur L.
Johnson, Clair V.
Karlson, Karl F.
Knudsen, Elmer F.
Prior, Raymond L.
Schultz, William J.

L.U. NO. 242 CHICAGO, ILL.

Bernston, Carl
Braun, Paul
Dowling, Vernon A.
Lattimer, Leslie
Rehling, Charles Jr.
Sarsfield, Arthur
Spakowski, Alex

L.U. NO. 246 NEW YORK, N.Y.

Muscarella, Nicholas
Renna, Albert
Szeg, Anton
Vobornik, John

L.U. NO. 257 NEW YORK, N.Y.

Carozzo, Rocco
Carrington, Richard
Grahn, Harry
Ruppe, Alois

L.U. NO. 278 WATERTOWN, N.Y.

Pielow, William

L.U. NO. 331 NORFOLK, VA.

Hudkins, Wilbert L.
Riddick, Harry L.

L.U. NO. 335 GRAND RAPIDS, MICH.

Rhoades, James Sr.
Saganski, Clarence
Trumbull, George

L.U. NO. 337 DETROIT, MICH.

Dierkes, Walter
Gilbertson, Gunwald
Ray, H. B.
Wilcox, Leo

L.U. NO. 340 HAGERSTOWN, MD.

Baughman, Harry E., Jr.
Yunker, Donald W.

L.U. NO. 366 NEW YORK, N.Y.

Foth, Fred

L.U. NO. 383 BAYONNE, N.J.

Livin, Israel
Sugerman, Jacob
Thompson, Louis

L.U. NO. 470 TACOMA, WASH.

Aikins, William
Berquist, R. C.
Biggs, W. D.
Norton, Joseph J.
Oren, Chester
Warter, Louis

L.U. NO. 494 WINDSOR, ONT.

Hewet, Alex

L.U. NO. 501 STROUDSBURG, PA.

Learn, Harold
Reisenwitz, Paul
Shook, Deward R.

L.U. NO. 543 MAMARONECK, N.Y.

Tolve, Louis

L.U. NO. 585 CODY, WYO.

Todd, Loren L.

L.U. NO. 620 MADISON, N. J.

Bopp, Philip
Daley, Michael A.
Smith, Alfred

L.U. NO. 627 JACKSONVILLE, FLA.

Birchall, Arthur J., III
Crews, Lewis C.
Gaddis, R. R.
Martin, Frank
Norton, T. H.

L.U. NO. 630 NEENAH, WISC.

Schultz, Erven

L.U. NO. 633 MADISON, ILL.

Sims, Louis

L.U. NO. 642 RICHMOND, CAL.

Baker, Fred H.
Bergo, Ole
Cecil, Harry E.
Crews, Mike R.
Gallacher, L. Ross
Gengler, Peter
Hadnott, Robert
Heath, Floyd L.
Hopkins, Efnor
Johnsen, Ernest C.
LeBlanc, Philip E.
Underwood, Guy
Vittitow, W. O.

L.U. NO. 651 JACKSON, MICH.

Church, Robert P.
Decker, William L.
Hazelwood, Sidney E.
Heminover, George
Pezon, John
Rich, Arthur
Storm, Frank R.
Vandenburg, John E.

L.U. NO. 674 MT. CLEMENS, MICH.

Kowalski, Leo G.

L.U. NO. 690 LITTLE ROCK, ARK.

Alletag, Frank M.
Devore, L. A.
King, Hubert U.
Lindsay, Frank R.
Matthews, E. A.
McArthur, James A.
Moore, Jesse S.
Pruitt, A. R.
Reeves, John E.
Thomas, Fay

L.U. NO. 710 LONG BEACH, CAL.

Erkes, Henry
Lindstadt, Clarence
Mohler, Frank W.
Nelson, Paul L.
Piggee, Larry
Starich, John
Stine, Jack

L.U. NO. 715 ELIZABETH, N.J.

Blusevicz, Mathew
Deubert, Harold
Ericksen, Martin
Knudsen, Martin
Lewis, Joseph
Morgan, William
Resnick, Paul
Sloan, Harry

L.U. NO. 751 SANTA ROSA, CAL.

Cleveland, Charles
Sikes, Sam

L.U. NO. 769 PASADENA, CAL.

Mitchell, Harold G.

L.U. NO. 819 W. PALM BEACH, FLA.

Arnold, Harry B.
Baker, Roland A.
Carrin, Vernal B.
Cook, Oren F.
Harvey, Charles R.
Hillyer, Lyle K.
Hunt, Joseph A.
Johns, Paul J.
Krough, Marius
Lehto, Richard
Smith, Sylvanus
Swanson, Henning
Walker, Elmer L.
Weysman, Richard

L.U. NO. 848 SAN BRUNO, CAL.

Luporini, Aladino
Wilcox, Robert

**L.U. NO. 885
WOBBURN, MASS.**

Cooper, Cyril
Walters, George

**L.U. NO. 930
ST. CLOUD, MINN.**

Johnson, Elmer D.
Jost, Peter
Lawrence, Scott W.
Lorentz, Walter F.
Maciej, Joseph L.
Schwindel, Albert
Wallek, Joseph

**L.U. NO. 964
ROCKLAND CO., N.Y.**

Backus, Sydney
Barrera, Francis
Cornelius, George
McNeice, William

**L.U. NO. 977
WICHITA FALLS, TEX.**

Hull, Walter H.
Taylor, Guy

**L.U. NO. 981
PETALUMA, CAL.**

Cooper, Riley L.

**L.U. NO. 982
DETROIT, MICH.**

Diehl, Bernard O.

**L.U. NO. 1006
NEW BRUNSWICK**

Belfi, Peter
Matusz, Alexander
O'Neill, John

**L.U. NO. 1035
TAUNTON, MASS.**

Paull, Stuart N.

**L.U. NO. 1040
EUREKA, CALIF.**

Atwell, John

**L.U. NO. 1098
BATON ROUGE, LA.**

Adams, Earl R., Sr.

**L.U. NO. 1138
TOLEDO, OHIO**

Bates, Ralph
Lambert, Paul
Selent, Gottfried
Sheppard, Clyde

**L.U. NO. 1164
NEW YORK, N.Y.**

Argiro, Dominick
Bensen, Jack
Biasetti, Leonida
Hirschfeld, Albert
Kirnbauer, John
Kolakowski, Joseph
Krisch, Albert
Kurfner, Edward
Pick, Alfred
Ruegg, John
Slamavitz, Morris
Tricarico, Isidore
Vetter, Philip
Wirzberger, Lawrence
Zelin, Jacob

**L.U. NO. 1172
BILLINGS, MONT.**

Burnett, W. A.
Merrill, L. C.

**L.U. NO. 1321
BALLSTON-SPA., N.Y.**

Nagy, Joseph

**L.U. NO. 1323
MONTEREY, CAL.**

McLean, William
Quarles, Mortie
Russo, Michael R.
Sutton, Ray S.

**L.U. NO. 1367
CHICAGO, ILL.**

Swanson, Emil

**L.U. NO. 1397
N. HEMPSTEAD, N.Y.**

Wiencko, Alexander C.

**L.U. NO. 1408
REDWOOD CITY, CAL.**

Allen, Edward
Knudsen, Knud
Lawson, William
Lien, Alfred
Oppen, Arthur
Skinner, H. M.
Tunnell, Norman
Whited, Harvey

**L.U. NO. 1609
HIBBING, MINN.**

Carlson, Axel
Edwardson, Jacob
Rantala, Anton

**L.U. NO. 1688
MANCHESTER, N.H.**

Rancourt, Albert

**L.U. NO. 1708
WHITE RIVER VALLEY,
WASH.**

Emerson, George
Kanzig, William
Pahl, Edgar
Whetstone, Arthur

**L.U. NO. 1752
POMONA, CAL.**

Brand, Merle
Byse, Walter
Dusserre, Joe
Edwards, Clifford J.
Gendron, Henry
Hefty, Robert E.
Hughes, Paul J.
King, Shafter A.
LeClaire, William
Manqueros, Damacio
Masker, Duane
Mhoon, Jerry A.
Reed, Frank
Rodriucz, Mike
Schweer, E. C.
Smith, Eldoras
Tedford, Ervin A.
Thomas, H. O.
VanLeeuwen, Christian
Young, Ralph

**L.U. NO. 1797
RENTON, WASH.**

Allen, Lester
Costner, C. M.
Croston, James
Hren, Frank
Isackson, Walter E.
Matta, Wayne J.
Melville, Wesley A.
Potter, George
Root, Albert W.
Rose, Otto E.
Ryan, Fred E.
Sieber, Leo H.
Stewart, Donald J.

**L.U. NO. 1822
FORT WORTH, TEX.**

Long, John P., Sr.

**L.U. NO. 1846
NEW ORLEANS, LA.**

Lavie, Oscar
Lombardo, Sam
Pittman, Cecil
Smith, Oscar G.

**L.U. NO. 1849
PASCO, WASH.**

Paulsen, Peter

**L.U. NO. 1934
BEMIDJI, MINN.**

Anderson, Walter A.
Woodward, John R.

**L.U. NO. 2006
LOS GATOS, CAL.**

Adams, Roy R.
Baungartner, Edward K.
Diard, Robert L.
Forrest, Bedford
Foster, Raymond P.
Gilpatrick, Ray S.
Stradley, Lloyd E.

**L.U. NO. 2143
UKIAH, CALIF.**

Hine, Bill

**L.U. NO. 2375
LOS ANGELES, CALIF.**

Ardaiz, Frank
Bruce, J. W.
Kramer, Walter P.
Long, Cleo R.
Murphy, J. B.
Swart, W. H.

**L.U. NO. 2422
SONOMA, CALIF.**

Pfalzgraf, Henry

**L.U. NO. 2898
GLIDDEN, WISC.**

Kobin, O. W.

**L.U. NO. 3208
LOVELAND, COLO.**

Longwill, Merl

Vietnam Casualty

Wade Rollins, 24, of Local 1831, millwright contestant in the 1968 International Apprenticeship Contest at Kansas City, was killed Feb. 19 while serving with a reconnaissance observer team of the 101 Airborne Division near Laos. He represented the District of Columbia in the 1968 contest.



This point lets you bore holes up to 1 1/2" with small electric drill

IT'S HOLLOW GROUND to bore cleaner, faster at any angle

Now step-up the boring range of your small electric drill or drill press to 1 1/2" with Irwin Speedbor "88" wood bits. 1/4" shank chucks perfectly. No wobble. No run-out. Sharp cutting edges on exclusive hollow ground point start holes faster, let spade type cutters bore up to 5 times faster. You get clean, accurate holes in any wood at any cutting angle.

Each Irwin Speedbor "88" forged from single bar of finest tool steel. Each machine-sharpened and heat tempered full length for long life. 17 sizes, 1/4" to 1 1/2" and sets. See you Irwin hardware or building supply dealer soon.



IRWIN SPEEDBOR "88" WOOD BITS
at Wilmington, Ohio, Since 1885

You'll Like Being a SKILLED LOCKSMITH

You'll EARN MORE, LIVE BETTER than Ever Before in Your Life

You'll enjoy your work as a Locksmith because it is more fascinating than a hobby—and highly paid besides! You'll go on enjoying the fascinating work, year after year, in good times or bad because you'll be the man in demand in an evergrowing field offering big pay jobs, big profits as your own boss. What more could you ask!

Train at Home—Earn Extra \$\$\$\$ Right Away!

All this can be yours FAST regardless of age, education, minor physical handicaps. Job enjoyment and earnings begin AT ONCE as you quickly, easily learn to CASI EX on all kinds of locksmithing jobs. All keys, locks, parts, picks, special tools and equipment come with the course at no extra charge. Licensed experts guide you to success.

Illustrated Book, Sample Lesson Pages FREE

Locksmithing Institute graduates now earning, enjoying life more everywhere. You can, too. Coupon brings exciting facts from our school of its kind. Lic. by N. J. State Dept. of Ed., Accredited Member, Natl. Home Study Council. Approved for Veteran Training.

LOCKSMITHING INSTITUTE
Div. of Singer Communications Corp.
Dept. 1118-031 Little Falls, N. J. 07424

Earn \$150 During Training

I realized with LOCKSMITHING I'd be able to double my income. During my training period I made \$150.
Paul Funes
New York, N.Y.



LOCKSMITHING INSTITUTE, Dept. 1118-031
Little Falls, New Jersey 07424 Est. 1948

Please send FREE illustrated Book—"Your Big Opportunities in Locksmithing," complete Equipment folder and sample lesson pages—FREE of all obligation—(no salesman will call).

Name.....
(Please Print)

Address.....

City..... State..... Zip.....

Check here if Eligible for Veteran Training

LABOR and MATERIAL COSTS

NATIONAL CONSTRUCTION ESTIMATOR
1971 UNIT COSTS
COMPILED FROM THE RECORDS OF HUNDREDS OF CONTRACTORS AND MATERIAL SUPPLIERS

1971 UNIT COSTS
COMPILED FROM THE RECORDS OF HUNDREDS OF CONTRACTORS AND MATERIAL SUPPLIERS

— 208 Pages **ONLY \$4.75**
8 1/2" x 11" NO ADVERTISING In California add 24c tax

- ACCURATE BUILDING COSTS IN DOLLARS AND CENTS
- AVERAGE LABOR COSTS FOR THOUSANDS OF ITEMS
- TYPICAL SUB CONTRACT PRICES INCLUDED
- NEW ESTIMATING RULES OF THUMB

Send for FREE Building Books Catalog

CRAFTSMAN BOOK COMPANY OF AMERICA Dept. C
124 SO. LA BREA AVE., LOS ANGELES, CALIF. 90036

Please send me the *Nineteenth Edition* of the NATIONAL CONSTRUCTION ESTIMATOR. \$4.75
In California add .24c Sales Tax

Please send me FREE Building Books Catalog.

Firm Name _____
Your Name _____
Address _____
City _____ State _____
Zip _____

10 DAY FULL MONEY BACK GUARANTEE

MAKE \$20 to \$30 EXTRA
on each
STAIRCASE



Saves its cost in ONE day—does a better job in half time. Each end of Eliason Stair Gauge slides, pivots and locks at exact length and angle for perfect fit on stair treads, risers, closet shelves, etc. Lasts a lifetime.

Postpaid if payment sent with order, or C.O.D. plus postage Only **\$19.95**



ELIASON STAIR GAUGE CO.
6005 Arbour Lane
Minneapolis, Minn. 55436

WHAT'S NEW?

CONVERTIBLE HOME BAR

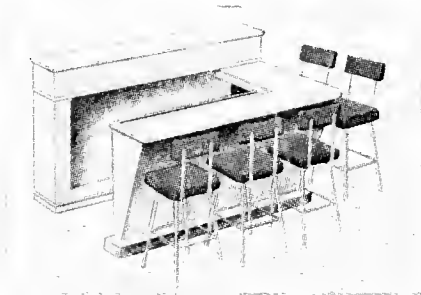

John Zufa of Lockport, Ill., has designed a convertible home bar which he calls a "Zufari" and which he describes as an innovation for home luxury, adaptable to many uses. Price for the plans is \$4. (The stools are not included.) Address your order to: Zufari Crafts Co., 135 North Hamilton, St., Lockport, Ill. 60441

GRINDING TEMPLATES



W/W Engineering Company has introduced a set of 3 Universal grinding templates for reconditioning struck or striking surfaces on impact hand tools. Sledges, chisels, punches, ball peen hammers and similar tools are damaged in normal use due to the constant blows on the struck surfaces. As the surface mushrooms or develops spalls, it is recommended that the surfaces be reconditioned by grinding. The W/W templates are designed to provide an accurate guide in restoring the proper radius to the crown of the tool. These simple low-cost devices can greatly prolong tool life. Literature and prices are available by writing to W/W Engineering Company, 525 South Dearborn Street, Chicago, Illinois 60605.

WALLBOARD LIFTER

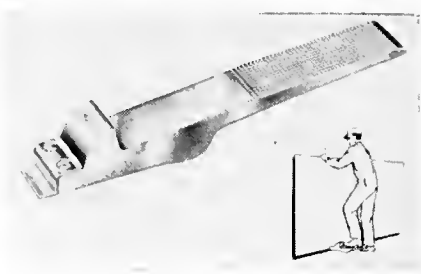

Goldblatt, producer of trowel trades tools, has developed and designed a new, more durable wallboard lifter. Made of cast aluminum, the Kiklift® is heat treated for added strength, with a 1/2" die-formed steel replacable lifting lip for years of service. You replace only the lip.

The new Goldblatt Kiklift® is correctly balanced, with the lip always on the floor. All you do is move and position with your foot, kick under the wallboard and lift. The extended heel rest has a raised, non-skid, checkered surface that gives the right feel and needed foot traction.

Weighing only 24 ounces, the new Goldblatt Kiklift® is 15" long, 2" wide and has a 1/2" lifting lip with a 1" high toe kick.

Replaceable lifting lips are available through Goldblatt Dealers or for further information on the new Goldblatt Wallboard Kiklift® write: Mr. Si Kraft, Sales Manager, Goldblatt Tool Co., 511 Osage, Kansas City, Kansas 66110.

PANELING CATALOG

A 20-page, color-illustrated catalog, "Interiors—Decorative Paneling Systems," is available from Masonite Corporation as a guide to the company's prefinished hardboard panels. The products are shown in room settings and closeup vignettes. In addition, sketches show a selection of commercial and office installations. Specifications and installation directions are included, along with a reproduction of the lifetime Masonite Brand paneling guarantee. For a free copy of "Interiors," write on your letterhead to Masonite Corporation, Box B, Chicago, Illinois, 60690, requesting Form 7103.

WEATHERED WOOD

Imitation weathered wood has been available for some time. Now Tradition Materials, St. Cloud, Minn. 56301, offers real weathered wood from old barns and shelters for decorating purposes. The wood is from six to 12 inches wide, "aged to a soft silver-gray, sometimes touched with the tones of moss, marked here and there with the holes of wrought nails or the softened scars of use."

PLEASE NOTE

A report on new products and processes on this page in no way constitutes an endorsement or recommendation. All performance claims are based on statements by the manufacturer.



Lakeland News

Items of interest from the Brotherhood's retirement home at Lakeland, Florida

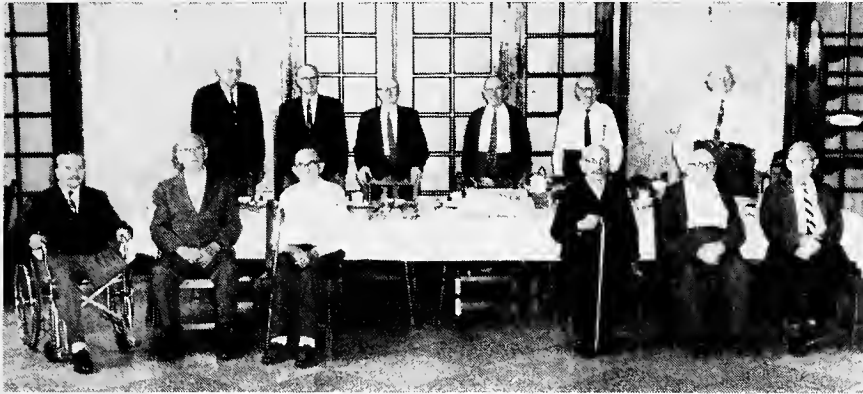

Brother Sitkey, seated in the wheelchair at left, enjoys his recent birthday with other members living at the Carpenters Home.

Lakeland Resident's Letter to Home Local Prompts Local's Letter to General President

Local 1784 of Chicago recently received a letter from one of its long-time members, Louis Sitkey, 90 years old, and a resident of the Carpenters Home at Lakeland, Fla.

A reading of Brother Sitkey's letter to a recent local union meeting prompted the local to write General President M. A. Hutcheson, through its recording secretary, Robert Sabo, and call attention to the Home's value to members of the Brotherhood. The local union stated: "Mr. President, it's letters like this that make our efforts worth while in the preservation of our Home."

Retiree Sitkey learned the cabinet-

maker's trade in Budapest, Hungary. He immigrated to the United States in the early 1900s. The loss of a leg in 1963 made entry into the Carpenters Home at Lakeland a necessity. Sitkey attended union meetings regularly while living in Chicago and served the labor movement for more than half a century.

In his letter to his home local, Brother Sitkey described the recent celebration of Christmas at the Lakeland Home. Every door and window was decorated with wreaths, he reported. There were three Christmas trees and many turning and blinking lights. All members of the Brotherhood would be proud of "the old Carpenters Home," he wrote.

Herbert Bates, of Local No. 1590, Washington, D.C., arrived at the Home January 6, 1971.

Joseph O. Supper, of Local No. 122, Philadelphia, Pa., arrived at the Home Jan. 6, 1971.

Karl S. Westerholm, of Local No. 2531, Portland, Ore., arrived at the Home Jan. 6, 1971.

Albert F. Jett, of Local No. 2217, Lakeland, Fla., arrived at the Home Jan. 8, 1971.

Andrew Daugherty, of Local No. 73, St. Louis, Mo., arrived at the Home Jan. 8, 1971.

Herbert L. Nelson, of Local No. 36, Oakland, Calif., arrived at the Home Jan. 11, 1971.

Gunnar Frostad, of Local No. 7, Minneapolis, Minn., arrived at the Home Jan. 11, 1971.

Frank Selzo, of Local No. 107, Worcester, Mass., arrived at the Home Jan. 12, 1971.

Phil Berard, of Local No. 36, Oakland, Calif., arrived at the Home Jan. 13, 1971.

John Lindstrom, of Local No. 58, Chicago, Ill., arrived at the Home Jan. 15, 1971.

Karil Plasil, of Local No. 1786, Chicago, Ill., arrived at the Home Jan. 25, 1971.

Robert J. Dvorak, of Local No. 2159, Cleveland, Ohio, arrived at the Home Jan. 29, 1971.

Thos. McCann, of Local No. 132, Washington, D.C., died Jan. 2, 1971. Burial was in Washington, D.C.

Chas. Homa, Local No. 59, Philadelphia, Pa., died Jan. 2, 1971. After cremation, his ashes will be buried in the Home Cemetery.

Terrence J. Cunningham, of Local No. 81, Erie, Pa., died Jan. 6, 1971. Burial was in Erie.

Hugh Urquhart, of Local No. 1125, Los Angeles, Calif., died Jan. 27, 1971. He was buried in the Home Cemetery.

William Hunting, of Local No. 1739, St. Louis, Mo., died Jan. 29, 1971. He was buried in the Home Cemetery.

Frank Lloyd, of Local No. 142, Pittsburgh, Pa., died Jan. 31, 1971. He was buried in the Home Cemetery.

Walter Januzik, of Local No. 181, Chicago, Ill., withdrew from the Home to be married. We removed him from the rolls as of Jan. 4, 1971.

George Vasilon, of Local No. 721, Los Angeles, Calif., withdrew from the Home Jan. 13, 1971, to return to Greece.

INDEX OF ADVERTISERS

Audel, Theodore	35
Belsaw Power Tools	31
Belsaw Sharp-All Co.	25
Berger Instruments	27
Bureau of National Affairs, Inc.	11
Chicago Technical College ..	33
Craftsman Book Co. of America	38
Eliason Stair Gauge Co.	38
Estwing Manufacturing	32
Foley Manufacturing	16
Goldblatt Tool Co.	27
Hydrolevel	35
Irwin Auger Bit Co.	37
Lee, H. D.	25
Locksmithing Institute	37
Paneling Specialties Co.	31
Stanley Works Back Cover	
Vaughan & Bushnell Mfg. Co.	23



In Conclusion

M. A. Hutcheson, *General President*



Is It Business As Usual For Everybody Else, Mr. President?

■ After many weeks of threats, some implied and some overt, the Nixon Administration finally cracked down on building trades unions in the name of halting inflation in construction costs.

On February 23, President Nixon announced the suspension of the Davis-Bacon Act, the act which for 40 years insured that the Federal government would not undercut existing wage rates in any area.

By the stroke of a pen, Mr. Nixon changed all this.

The press agents for the Administration had a field day trying to picture the move as a great feat of statesmanship for Mr. Nixon and a vital move toward curbing inflation.

A little bit of study of the President's action cannot help but convince any thinking man that the real motive for the move is to crack down on building tradesmen.

In the first place, on-site labor costs constitute only a small fraction of the total cost of erecting any structure. Other costs are materials, equipment rental, profits, finance charges and, of course, land. No restrictions of any kind were placed on these cost items.

Trying to halt the escalation of construction costs by concentrating exclusively on labor is like trying to hold back a river by building a dam one-fifth of the way across its width.

That construction wages have climbed substantially is a proposition no one can dispute; but the increases in on-site wages have been no more drastic than the escalation in the cost of materials, finance charges, profits, etc. Weighed against the climb in living costs they look a lot less ominous, too.

Nor is the construction industry unique in regard to wage inflation. Last month I quoted some figures indicating that construction earnings have not outrun industrial or government white-collar earnings by any substantial percentage over the past decade. Yet, construction workers have been singled out for special punitive attention by the Administration.

This in itself seems to indicate that the Nixon Administration is bowing to the big money interests which put him in office through vast campaign contri-

butions. These interests long have advocated repeal of Davis-Bacon provisions. The tycoons in the conglomerates, banks, oil and manufacturing empires who hate unions with a passion got what they wanted.

Not too many years ago these same interests pushed hard for the Landrum-Griffin Act. They theorized that rank and file members hated strikes and participated in them only because their officers compelled them to. In their opinion, if you undercut the authority of the officials to call and maintain strikes, you immediately created a climate where rank and file members would accept "reasonable" settlements. To their sorrow, they found that this kind of thinking was a gross miscalculation. Time and again in recent years rank and file members have voted down propositions accepted by negotiating committees. The rank and file turned out to be the real militants.

In the long run, the self-serving anti-labor groups may find that they have miscalculated once more. By the nature of things, the non-union contractors now will be free to pay whatever wages they can cram down the throats of their employees. Eventually this may inspire, if not force, such non-union employees to seek the protection of collective-bargaining in legitimate labor organizations as their wages and working conditions deteriorate.

In none of this do I mean to imply that inflation is not a serious threat. It is a clear and present danger, and I believe that all working people should realize that inflation hits hardest at those who work for a living. The rich are smart enough to transfer their diminishing dollars into goods which appreciate in value. The poor have to be taken care of anyway, so inflation touches them very little. It is those who are in the blue-collar and lower white-collar categories who suffer most.

Therefore, the labor movement has a real concern for holding back the growing threat of inflation; but it cannot be held back or even diminished by cracking down on one segment of one industry while the rest

Continued on Page 33

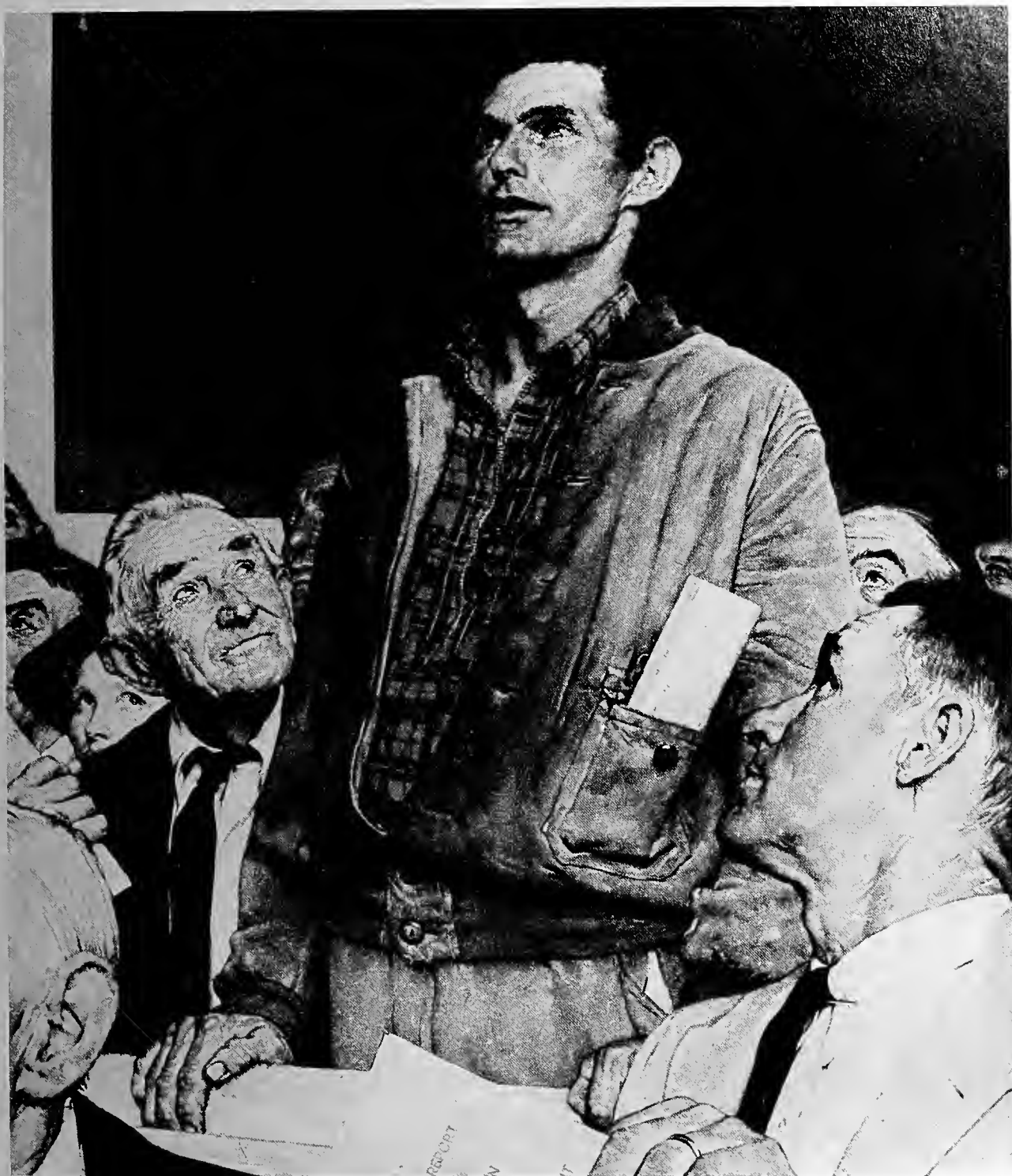

Speak Up, Brother! You Have the Floor

The right of a man to stand up and speak his piece without fear of police action is one of the sacred freedoms of the Bill of Rights. It is a right which will preserve democracy in America when other freedoms are denied.

It is a right, too, which gives every member of the United Brotherhood of Carpenters and Joiners of America the freedom to take the floor in a union meeting and have his thoughts, his wishes, and his aspirations heard. . . . And, of course, he has to be at the meeting in order to speak.

The painting entitled "Freedom of Speech" by Norman Rockwell, reproduced above, is a reminder to each member of the Brotherhood of his responsibility—and freedom—to speak up.

What makes the Stanley Steelmaster your kind of hammer?



The face is rim-tempered, for a safer hammer. Rim-tempering minimizes chipping in case of a foul blow. That's on-the-job safety.

Handle is hydraulically driven into the handle hole under 10,000 lbs. force. Permanently locked head and handle can't twist or loosen.

Notice the clean, sharp edges on the claw. This makes it easier to grip the shank of any nail and pull it, without effort, from the toughest wood.

Finally, it's a perfectly balanced hammer. Set it on its claws and notice the exact 45° angle. Perfect.



Don't settle for anything less than the best, time-tested tools. Stanley has been known for excellence in hand tools for over a century. Buy the tool that makes a difference. Stanley Hand Tools, Division of The Stanley Works, New Britain, Connecticut 06050.

STANLEY
helps you do things right

APRIL 1971

The CARPENTER

Official Publication of the UNITED BROTHERHOOD OF CARPENTERS AND JOINERS OF AMERICA • FOUNDED 1881



OFFICIAL INFORMATION

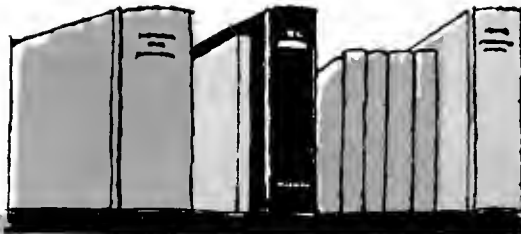

GENERAL OFFICERS OF THE UNITED BROTHERHOOD of CARPENTERS & JOINERS of AMERICA

GENERAL OFFICE:
101 Constitution Ave., N.W.,
Washington, D. C. 20001

GENERAL PRESIDENT

M. A. HUTCHESON
101 Constitution Ave., N.W.,
Washington, D. C. 20001

FIRST GENERAL VICE PRESIDENT

WILLIAM SIDELL
101 Constitution Ave., N.W.,
Washington, D. C. 20001

SECOND GENERAL VICE PRESIDENT

HERBERT C. SKINNER
101 Constitution Ave., N.W.,
Washington, D. C. 20001

GENERAL SECRETARY

R. E. LIVINGSTON
101 Constitution Ave., N.W.,
Washington, D. C. 20001

GENERAL TREASURER

PETER TERZICK
101 Constitution Ave., N.W.,
Washington, D. C. 20001

DISTRICT BOARD MEMBERS

First District, PATRICK J. CAMPBELL
130 North Main Street
New City, Rockland Co., New York
10956

Second District, RALEIGH RAJOPPI
2 Prospect Place, Springfield, New Jersey
07081

Third District, WILLIAM KONYHA
1830 Ledge Rd., R.D. No. 4
Medina, Ohio 44256

Fourth District, HAROLD E. LEWIS
340 Northwest 148th St.
Miami, Florida 33168

Fifth District, LEON W. GREENE
2800 Selkirk Drive
Burnsville, Minn. 55378

Sixth District, FREDERICK N. BULL
P.O. Box 14279
Oklahoma City, Okla. 73114

Seventh District, LYLE J. HILLER
Room 722, Oregon Nat'l Bldg.
610 S.W. Alder Street
Portland, Oregon 97205

Eighth District, CHARLES E. NICHOLS
Forum Building, 9th and K Streets
Sacramento, California 95814

Ninth District, WILLIAM STEFANOVITCH
2418 Central Avenue
Windsor, Ontario, Canada

Tenth District, GEORGE BENGOUGH
2528 E. 8th Ave., Vancouver 12, B. C.

M. A. HUTCHESON, *Chairman*
R. E. LIVINGSTON, *Secretary*

Correspondence for the General Executive Board
should be sent to the General Secretary.



Secretaries, Please Note

If your local union wishes to list deceased members in the "In Memoriam" page of *The Carpenter*, it is necessary that a specific request be directed to the editor.

In processing complaints, the only names which the financial secretary needs to send in are the names of members who are NOT receiving the magazine.

In sending in the names of members who are not getting the magazine, the new address forms mailed out with each monthly bill should be used. Please see that the Zip Code of the member is included. When a member clears out of one Local Union into another, his name is automatically dropped from the mail list of the Local Union he cleared out of. Therefore, the secretary of the Union into which he cleared should forward his name to the General Secretary for inclusion on the mail list. Do not forget the Zip Code number. Members who die or are suspended are automatically dropped from the mailing list of *The Carpenter*.

PLEASE KEEP *THE CARPENTER* ADVISED OF YOUR CHANGE OF ADDRESS

PLEASE NOTE: Filling out this coupon and mailing it to the *CARPENTER* only corrects your mailing address for the magazine. It does not advise your own local union of your address change. You must notify your local union by some other method.

This coupon should be mailed to *THE CARPENTER*,
101 Constitution Ave., N.W., Washington, D. C. 20001

NAME _____ Local No. _____

Number of your Local Union must be given. Otherwise, no action can be taken on your change of address.

NEW ADDRESS _____

City

State

ZIP Code

THE
CARPENTER



VOLUME XCI

No. 4

APRIL, 1971

UNITED BROTHERHOOD OF CARPENTERS AND JOINERS OF AMERICA

Peter Terzick, Editor

IN THIS ISSUE

NEWS AND FEATURES

THE BUILDING TRADES UNDER ATTACK

Nixon's Davis-Bacon Line Plunge	2
How the Executive Order Operates	5
The Second Bacon Rebellion	6
The Blue-Collar Worker, Uncle Sam's Forgotten Man	9
Any Way You Look At It, It's a Quota	11
Not All Young People Knock Hard Hats	Hope Smith 12
Nixon Aide Says "Arrogance" to End	26
TRANSITION, Brotherhood Trains Vietnam Veterans	14
Murphy Plans to Make Union Label Sharper	Harry Conn 21
General Executive Board Installed	27

DEPARTMENTS

Washington Roundup	10
Service to the Brotherhood	18, 35
Canadian Report	Morden Lazarus 19
Plane Gossip	22
We Congratulate	23
Your Union Dictionary	24
Local Union News	28
Outdoor Meanderings	Fred Goetz 32
Apprenticeship and Training	36
In Memoriam	37
Lakeland News	39
In Conclusion	M. A. Hutcheson 40

THE COVER

The full bloom of spring comes with the bright-colored tulips and the blossoms on the trees and shrubs. It comes with song and excitement, as migratory birds return from the south and begin building nests and occupying bird houses, such as the one which decorates the garden on our April cover.

Many of our more familiar birds returned last month. Robins began staking out their courting and nesting domains in March in some parts of the East.

About March 19 the first swallows returned to California's San Juan Capistrano, "The Jewel of the Missions." Their arrival attracted a clamorous throng of onlookers. Sometimes thousands of automobiles grope amid dawn's faint light for a place near the mission walls. Photographers adjust their lenses, and microphones listen for the first flutter of wings.

And do you know about the turkey buzzards that fly back each March 15 to Hinckley, Ohio? The town welcomed them with an annual festival March 21, and the townspeople hope they return each year. They're not such handsome creatures—these red-neck, gaunt birds—but they bring the first signs of spring to their part of the world . . . Just as a pair of blue-birds or wrens will add joy to the garden on our April cover.



POSTMASTERS, ATTENTION: Change of address cards on Form 3579 should be sent to THE CARPENTER, Carpenters' Building, 101 Constitution Ave., N.W., Washington, D. C. 20001

Published monthly at 810 Rhode Island Ave., N.E., Washington, D. C. 20018, by the United Brotherhood of Carpenters and Joiners of America. Second class postage paid at Washington, D. C. Subscription price: United States and Canada \$2 per year, single copies 20¢ in advance.



Printed in U. S. A.



Nixon's Davis-Bacon White House

Doctors' fees skyrocket, profits spiral upward, food and clothing prices defy the law of gravity, but only the wages of Building Trades workers are put under controls

■ Late last month the Nixon Administration crammed down the throats of the building trades unions a new executive order placing the wages of construction workers under ill-conceived controls.

This latest vendetta against construction workers was substituted for the suspension of Davis-Bacon provisions, which the President put into effect on February 23.

The excuse given by the President for both of these actions was that construction costs were running wild and, thereby, triggering inflation.

As we have pointed out so many times in the past, construction wages are only a small part of the total construction costs. Trying to control construction costs by clamping controls on wages is as futile as trying to hold back a stream by building a

dam one-fifth of the way across its width.

The only way that construction costs can be controlled effectively is by controlling the cost of materials, the cost of financing, the cost of equipment rental, and the cost of profits and the cost of land. In these categories, the President's newest proclamation talks in the vaguest terms or remains silent altogether.

All of this makes the President's proclamation appear to be nothing more or less than a deliberate kick in the teeth for the building trades unions.

However, the building trades unions, being dedicated to law and order, accepted the President's latest proclamation while reserving the right to attack it in the courts, in the legislative halls, or in any other legal manner.

At a meeting held in Washington on March 30, the General Presidents of the Building and Construction Trades Department issued the following statement:

"The General Presidents of the Building and Construction Trades Department, AFL-CIO, have studied President Nixon's Proclamation revoking his suspension of the Davis-Bacon Act and his Executive Order providing for the stabilization of wages and prices in the construction industry.

"In respect to the Davis-Bacon Act, as the Department and its affiliates repeatedly stated from the time of the suspension, President Nixon's action did not address itself to the inflationary problem at hand and served no purpose other than to completely confuse the bid and award procedure in almost every locality of the nation.

Thousands of protestors gathered outside the Iowa State Capitol, March 1, to protest the suspension of the Davis-Bacon Law, as President Nixon delivered a speech to legislators inside. (UPI Photo)



Bacon Line Plunge Falter; Calls For Wage Controls



Though they were cold and formal in their relations with each other, Presidents Hoover and Roosevelt agreed on the value of the Davis-Bacon Act as a method of stimulating the economy and protecting economically-depressed communities from sub-standard, slave-wage contractors.

We are glad that the suspension has been revoked. We suspect that most contractors are glad. And we are sure that many governors, attorneys general, mayors and legislators who declined to follow the invitation to knock out their state and local prevailing wage laws, insofar as federally assisted construction was concerned, are glad.

"In respect to the Executive Order, the General Presidents, after a brief review of its provisions, are of the opinion that it is fundamentally unfair in applying strict controls to wages and a vague procedure with respect to

prices and profits. It will be noted that the Executive Order apparently provides that wage or salary increases negotiated after the effective date of the Order shall not go into effect until processed through the procedures of the Order but that, 'until criteria have been developed and applied and prices and compensation are deemed to be unacceptable, prices and compensation shall not be deemed in violation of this order.' The General Presidents also wish to emphasize that they rejected a proposal of the Labor Department for a voluntary wage stabilization arrange-

ment, and any implication to the contrary is not consistent with the facts.

"The General Presidents have also noted with interest the release today of a Report by the Joint Economic Committee of the United States Congress which places in perspective the relationship of the building and construction industry to the problem of inflation in the United States. The pertinent statement on page 32 of the Report reads as follows:

'... it should also be emphasized that these large wage increases have been awarded to only a fraction of all construction workers. The Committee was surprised and dismayed to learn how little factual data is available regarding construction wages.

'The Labor Department should quickly enlarge its data on construction wages. In particular, more information should be developed on the number of workers who are unionized, the spread between union and non-union wages, geographical wage differentials, the average number of hours worked annually and average annual earnings.

'It should also be noted that wages are only one small part of total construction costs and represent less than 15 percent of the on-site cost of building an average house. An effective cost control policy is required for materials, for land, for mortgage credit and for contractor profits, as well as for wages.'

"The uncertainties and ambiguities in the language of the Executive Order have made it necessary for the officers of the Department to direct that a meeting of General Counsels of all International Unions be held for the purpose of analyzing the Executive Order in detail so that an appropriate basis

can be secured for making future policy determinations."

"As good Americans, we will abide by the Executive Order," Haggerty told reporters, but, he added, "only time will tell if the various unions will voluntarily take seats on wage review boards."

It has become apparent to building trades unions that once again they are under attack. A series of actions by the Nixon Administration and by management groups warns the trades to be on their guard.

Not only are hard-won wage levels and fair working conditions under attack, but there are continuing attempts to establish arbitrary racial and ethnic quotas in Federal construction projects and in apprenticeship training programs, regardless of circumstances which often make such quotas inoperable.

The curious, ill-conceived attempt to curb inflation by unilaterally holding down construction wages got underway soon after the new year began. Accepting hourly wage scales won by some crafts as evidence of high income for any and all construction workers—without taking into consideration the number of hours and days worked by the average construction worker each year, or the hardships and hazards of construction work or the lack of many fringes, or many other factors—the Administration mouthed the false and misleading statements of labor baiters and called for voluntary cutbacks in union wage proposals.

In response, the Building trades tried to point out to the President and to Secretary of Labor James D. Hodgson that labor costs are only a minor part of the total cost of construction, and that in order to curb inflation, costs of land, materials, and mortgages, would have to be held in check, as well. Ignoring these considerations, the President, late in February, suspended the Davis-Bacon Law, which requires that contractors working on Federal construction projects pay the prevailing area wage rates. The rising costs of land, materials and mortgage money continued unchecked.

Then followed a month of confusion for all parties—labor, management, and government. Inflation continued, undeterred by the suspension, and anti-union forces studied their next move.

Curiously, Davis-Bacon was signed into law 40 years ago by another Republican president, Herbert Hoover, and was actually created by two other Republicans, Senator James J. Davis



Gib Crockett in The Washington Star

and Congressman Robert L. Bacon, as a means of bringing the nation out of a heart-rending depression. It was considered then, as it is considered today, a stabilizing influence in the construction industry and not a creator of "emergency conditions," as charged by the White House.

AFL-CIO President George Meany called suspension of Davis-Bacon "an open invitation to unscrupulous employers to exploit workers by competitive undermining of fair wages and labor standards."

M. A. Hutcheson, General President of the United Brotherhood of Carpenters and Joiners of America, charged that the Nixon Administration was "bowing to the big money interests" which "long have advocated repeal of Davis-Bacon provisions."

"The President, somehow or other, seems to be obsessed with the wages of blue-collar workers," the General President said. "One of his first actions this year was to veto a bill providing

for a wage increase for blue-collar government workers."

This month the Building Trades confront Congress with legislative proposals endorsed by their annual legislative conference in Washington, D.C., the whole picture of collective bargaining and wage stabilization is clouded and uncertain.

The action to suspend Davis-Bacon was hardly taken before the Administration began destroying the Federal office which was established to make it workable. Fifty employees of the Davis-Bacon branch of the Department of Labor's Wage and Hour and Public Contracts Division were assigned to other jobs. At the time, the job shifts were called permanent.

The Nixon Administration now must say, "Come back. We've changed our minds."

The tactics, it is plain to see, are confused and changing, but the attack on the Building Trades goes on.

HOW THE EXECUTIVE ORDER ON BUILDING WAGE CURBS OPERATES

Following are excerpts from the Presidential Executive Order "Providing for Stabilization of Wages and Prices in the Construction Industry" setting forth the structure and functions:

Section 1 (a) A construction Industry Stabilization Committee (hereinafter referred to as "Committee") is hereby established to assure generally conformance of any increase in any wage or salary in the construction industry to the provisions of this order.

(b) The Committee shall be composed of twelve members appointed by the Secretary of Labor and selected as follows: four of the members shall be representative of labor organizations in the construction industry; four of the members shall be representative of employers in the construction industry; and four of the members shall be representative of the public. The Secretary of Labor shall appoint one of the public members as chairman of the committee.

Section 2. Associations of contractors and national and international unions shall jointly establish craft dispute boards (hereinafter referred to as "boards") to determine whether wages and salaries are acceptable in accordance with the criteria established in section 6. Each board shall be composed of appropriate labor and management representatives.

Section 3 (a) It shall be the responsibility of each board, in relation to the craft or branch over which it has jurisdiction, to provide advice and assistance in an effort to resolve any unresolved collective bargaining disputes involving wages and salaries and to promptly examine every collective bargaining agreement negotiated on or after the date of this order and to determine, in accordance with the criteria established in section 6, whether wage and salary increases in the agreement are acceptable and may thus be approved. The board shall make determinations within a reasonable time and shall notify the parties and the Committee of action taken. When it is determined by the board that a wage or salary increase is not acceptable, the board shall also notify the Secretary of Labor.

(b) Each board shall also have the authority to examine collective bargaining agreements negotiated prior to the date of this order which contain wage or salary increases scheduled to take effect on or after such date to determine whether any increase is unreasonably inconsistent with the criteria established in section 6.

Section 4 (a) Upon receipt of a notification by a board that it has found a

wage or salary increase acceptable, the Committee shall have fifteen days in which to determine whether it will assume jurisdiction over the matter. If the Committee does not determine within that time, and so notify the parties and the board, that it will assume jurisdiction, the board's determination will be deemed final and the increase may take effect. If the Committee determines that it will assume jurisdiction it shall be a violation of this order to implement the increase unless and until the Committee affirms the board's initial determination. The Committee shall notify the parties, the board and the Secretary of Labor of its final action.

(b) The Committee is also authorized, upon its own motion, if a board has not yet reported or an appropriate board has not been established, to review any proposed wage or salary increase to determine its acceptability.

(c) Unless and until an increase in wage or salary has been approved in accordance with the provisions of sections 1(a) and 4 of this order, it shall be a violation of this order to put such a wage or salary increase into effect.

Section 5. Upon a determination by a board or the Committee that a proposed wage or salary increase is not acceptable and certification of that determination by the Secretary of Labor, the following actions shall be taken:

(a) In implementing the provisions of the Davis-Bacon Act of March 3, 1931 (46 Stat. 1494, as amended) and related statutes the provisions of which are dependent upon determinations by the Secretary of Labor under the Davis-Bacon Act, and including state statutes or laws requiring similar wage standards, the Secretary of Labor and all states shall not take into consideration any wage or salary increase in excess of that found to be acceptable in making determination under that Act and related statutes.

(b) In order to assure that unacceptable wage rates shall not be utilized in Federal or federally-related construction, the heads of all Federal departments and agencies, subject to the direction and coordination of the Secretary of Labor:

(1) shall review all plans for construction and financial assistance for construction in localities in which wage or salary increases have been certified by the Secretary of Labor to be unacceptable and shall, on the basis of that review, determine whether such plans can be approved or continued; and

(2) shall review current and prospective construction contracts for Federal construction and for construction on projects receiving Federal financial assistance

in the area affected by a certification by the Secretary of Labor and shall, on the basis of such review, determine whether such contracts can be awarded or continue.

(c) The Committee and the boards shall make public their determinations, specifying the craft and area affected and the wages or salaries deemed unacceptable.

(d) Any other action authorized by law to carry out the purposes and policy of this order shall be available to the Secretary of Labor to assure the stabilization of wages and prices in the construction industry.

Section 6. The following criteria shall be applied in determining whether any wage or salary increase is acceptable:

(a) Acceptable economic adjustments in labor contracts negotiated on or after the date of this order will be those normally considered supportable by productivity improvement and cost of living trends, but not in excess of the average of the median increases in wages and benefits over the life of the contract negotiated in major construction settlements in the period 1961 to 1968.

(b) Equity adjustments in labor contracts negotiated on or after the date of this order may, where carefully identified, be considered over the life of the contract to restore traditional relationships among crafts in a single locality and within the same craft in surrounding localities.

Section 7. The parties to a labor contract negotiated in the construction industry shall promptly submit that contract to the appropriate board or boards. Where there is no appropriate board to consider the acceptability of a proposed wage or salary increase, the affected national or international union, and the affected association of contractors shall promptly submit that contract to the Committee.

Section 8. The Interagency Committee on construction (hereinafter referred to as "Interagency Committee"), is hereby established to develop criteria for the determination of acceptable prices in construction contracts as well as criteria for acceptable compensation, including bonuses, stock options and the like. Officers and employees of Federal departments and agencies shall be designated to serve as members of the Interagency Committee by the Secretary of Housing and Urban Development who shall also designate its chairman. The Interagency Committee shall consult with the Secretary of Labor, with major Government procurement agencies and with the Committee in developing such criteria and concerning the application of such criteria. Until criteria have been developed and applied, and prices and compensation are determined to be unacceptable, prices, and compensation shall not be deemed in violation of this order.



LEFT: Cong. Richard J. Welch of California, chairman of the House Committee on Labor.

RIGHT: Secretary of Labor William N. Doak, 1930-1933, supporter of the legislation.

THE SECOND BACON



■ Robert Low Bacon was slow to anger. A Boston aristocrat by birth, a graduate of Harvard and a Republican, he chose his words carefully when he delivered a speech on the floor of the House or Representatives in Washington.

But he had served with honor in World War I, and his orderly, disciplined mind was outraged by what he saw one day in his home district on Long Island.

The Veterans Bureau in Washington had let a bid to an Alabama contractor, for the construction of Northport Hospital. It was a low bid, and government agencies were practically required in those days to accept the lowest bid, without too much concern for its merit.

Now, ringed about the construction site in Northport was a collection of shanties housing low-paid



JAMES J. DAVIS, a Republican Senator from Pennsylvania, was a native of Wales who immigrated to the United States with his parents in 1881, settled in Pittsburgh and later moved to Sharon, Pa. He apprenticed as a puddler in the steel industry at the age of 11 and later served as a leader of the Amalgamated Association of Iron, Steel and Tin Workers of America. He was at one time city clerk of Elwood, Indiana, and recorder of Madison County, Indiana. Appointed Secretary of Labor by President Warren Harding, he was reappointed by Presidents Coolidge and Hoover, serving from March, 1921, till December, 1930. He was elected to the U.S. Senate to fill a vacancy caused by the refusal of the Senate to seat William S. Vare and served in the Congress until January, 1945. He died in 1947 and is buried in Uniondale cemetery, Pittsburgh, Pa.



ROBERT L. BACON, a Republican Representative from New York, was born in Jamaica Plains, Boston, Mass., in 1884, graduated from Harvard Law School in 1910, was an employee of the U.S. Treasury in 1910 and 1911. He moved to Old Westbury, N.Y., in 1911 and was a New York City banker for the following decade of his busy life. He had a distinguished military career, which began with attendance at a "businessmen's training camp" at Plattsburg, N.Y., in 1915, and which included service on the Texas border with the N.Y. National Guard, service as a major in World War I, and later promotion to colonel in the Officers' Reserve Corps. Elected to the 68th Congress in 1923 he served until his death in 1938 in a hospital in Takoma Park, Maryland. He is buried in Arlington National Cemetery.

THE FIRST BACON REBELLION—One hundred years before the Declaration of Independence at Philadelphia, a Virginia planter named Nathaniel Bacon led an uprising of colonists against the administration of Governor William Berkeley. On September 19, 1676, the colonial capital of Jamestown was almost completely destroyed by Bacon's rebels in protest against the governor's reactionary policies regarding the Indians and territorial expansion.

REBELLION



workers from the South. Low bid meant low wages, and the evidence of "slave labor" was easy to see.

"Unfortunate men were huddled in shacks, living under the most wretched conditions and being paid wages far below the standard," the Congressman told his colleagues on Capitol Hill. "These unfortunate men were being exploited by the contractor. Local skilled and unskilled labor were not employed. The workmanship of the cheap imported labor was, of course, very inferior.

"Local workmen are merely envious onlookers, off the reservation, simply because the Federal contractor concerned has been able to bring into the community a cheap, bootleg labor supply with profit to himself and, perhaps also, I am ashamed to say, with profit to the Federal government."

Bacon's temper mounted as he checked construction work in other parts of his district. The nation at the time was enduring prosperity. This was in 1926, and Wall Street was riding high. Bacon could not understand why a wealthy nation such as ours could permit its skilled citizens to be exploited in this way.

He introduced a bill into the House of Representatives, and the House Labor Committee took it under consideration. But in that session of Congress, the House failed to act. Bacon didn't give up, how-

ever. His bill faced three separate Congresses, and each time it was reported out unanimously only to fail in the Senate. Each time, however, he gained support from other Congressmen, and the record began to build up. The nation, meanwhile, had taken a nosedive into a tragic economic depression. Herbert Hoover succeeded Calvin Coolidge at the White House, and men were idle all over America. In the first months following the Wall Street Crash, when Bacon's bill was up for reconsideration, there were almost 5 million persons unemployed. In 1931, when the Act finally passed, there were 8 million unemployed—a relatively small number by today's totals, but almost a fifth (or 20%!) of the total work force in 1931.

By now it was evident to many that the only way the nation could come out of its catastrophe was to spread its limited wealth to local communities and increase the purchasing power of the citizenry. If no one had money to buy goods and services, no one would be employed to produce those goods and services.

The Federal government entered upon an extensive public construction program throughout the 48 states and the District of Columbia. The program was scheduled to continue for eight to ten years and would expend almost half a billion dollars for the construction, altera-

tion, and repair of Federal buildings. Though the money would enhance Federal facilities, its major benefit would be that it would distribute funds through legitimate public works to every area of the country. It was "make work," but, like the New Deal projects which came later, it put people into jobs and money into circulation.

Such a purpose would not be served by the contractor who hoarded construction funds for himself, paying slave wages to imported workers. President Hoover and his cabinet soon realized this, and the full support of his administration was thrown behind Bacon's proposed legislation to establish the prevailing wage principle. Senator James J. Davis, another Republican, introduced S. 5904, a counterpart to Bacon's HR 16619, and Congressional hearings began.

The question of having contractors who were awarded Government contracts pay fair wage scales was passed on by the Senate in the form of an amendment introduced by Senator Couzens of Michigan and attached to an appropriation bill. The Executive Branch of the government, meanwhile, had tried to correct general conditions without the aid of legislation, but was unable to do so.

The Senate Committee on Manufacturers held extensive hearings. Secretary of Labor William N. Doak

WILLIAM GREEN, president of the American Federation of Labor during the 1930's told the Committee on Manufactures of the U.S. Senate that the Davis-Bacon Bill was "a decent American wage standard bill." The AFL gave the bill its "full and hearty" support. Green warned senators that some Federal agencies were letting bids to low-wage contractors who were unable to secure business in private industry because they were regarded as irresponsible, in spite of the fact that they could file performance bonds. He cited cases from throughout the nation in which wages on government jobs were far below either union scale or average local wages.



SENATOR ROBERT LA FOLLETTE, JR., of Wisconsin, chairman of the Committee on Manufactures, called Davis-Bacon wage standards "practical and workable." He reported that it was the opinion of all Federal departments concerned with public building projects that existing machinery in the Department of Labor would be able to make "speedy determinations" of any controversies which might arise under Davis-Bacon. He warned that "government construction contracts are being let every day and . . . unless some legislation is passed . . . the government will have no right to put into the specifications or the contracts any provision for the maintenance of wage standards."



JOHN P. FREY, Secretary-Treasurer of the Metal Trades Department, American Federation of Labor, told the Committee on Manufactures that reputable contractors joined organized labor in supporting prevailing-wage-standards legislation. He told the Senate committee: "These contractors find it impossible to get contracts when other contractors are able to import labor and pay sometimes as low as 50% below the local scale." He added his department's endorsement to that of the Building and Construction Trades Department of the AFL. Frey commented that the Davis-Bacon Bill did not "go as far as it might."



CONGRESSMAN FRED HARTLEY, JR., Republican of New Jersey, who later became co-author of the infamous Taft-Hartley law, was serving his first term in Congress when Davis-Bacon was proposed. He was assigned to the House Committee on Labor, and this committee had before it HR 16619, which would "regulate wages paid to employees by contractors awarded government building contracts." This bill, however, was rejected in favor of the Senate's Davis-Bacon Bill. Any anti-labor position taken by Congressman Hartley on the House committee during this period was offset by that of another New Jersey Rep., Mary T. Norton of Jersey City, a Democrat.



CONGRESSMAN FIORELLO LA GUARDIA of New York, later to become the celebrated mayor of New York City, told his fellow legislators in House floor debate that the Davis-Bacon Bill was for the protection of the government as well as the workers "in carrying out a policy of paying decent American wages to workers on government contracts." He deplored the "wretched conditions" and poor wages paid to workers under government contract in the home district of fellow Congressman Robert Bacon. "The workmanship of the cheap, imported labor was, of course, very inferior," he told fellow Congressmen in his familiar, vigorous manner.

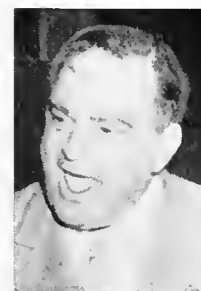

told the Congress that his department was fully equipped to determine prevailing area wages through its regional offices, and he strongly supported the joint Davis-Bacon Bill.

"We do not say it is a bullet-proof bill," he said, "or that it is the very best bill that can be written . . . but we believe it will answer the purpose fully and completely."

Favorable testimony was also heard from Assistant Secretary of War Frederick H. Payne, the Supervising Architect of the Treasury James A. Wetmore, Assistant Secretary of the Treasury Ferry K. Heath. Though labor leaders spoke in favor of the legislation, too, it was clearly evident that the Republican Administration was in strong support as well.

Finally, five years after he first introduced such legislation, Bacon saw his bill passed—altered somewhat and shortened to cover all situations in general language, but still a major step forward in the upward climb of American workers for a better standard of living.

It went before the Senate on February 4, 1931, and was passed without dissent after a third reading. Twelve days later the House acted favorably, too. Only a short time after that, President Hoover signed it into law.

Except for a brief suspension in 1935 during the Roosevelt Administration because of technicalities in the National Recovery Act, Davis-Bacon has stood the test of four decades. Even President Nixon's suspension, this year, was shortlived.

As a writer for Press Associates in Washington recently stated, Davis-Bacon has had more than just an economic meaning to American union workers. It also has a symbolic meaning. Developed at a time when millions of Americans were out of work, when American standards of living were on the downgrade and when labor unions were all but helpless to alleviate economic conditions, it still stands today as a bulwark against unscrupulous, low-wage contractors. It is not a demon to spread inflation, as the Nixon Administration suggests, but a method of keeping the nation's purchasing power where it belongs—in the hands of the working people of America. ■



The Blue-Collar Worker Is Uncle Sam's Forgotten Man

A recent Presidential veto put him further behind in wages

■ The forgotten man in the vast bureaucracy which makes up the Federal Government is the blue-collar worker who draws his pay-check from Uncle Sam.

While white-collar workers employed by the Federal Government have improved their relative position compared to their counterparts in private industry, the blue-collar people on the Federal payroll have fallen further behind both the white-collar government employees and their counterparts in private industry.

In addition to the low pay which blue-collar workers have to contend with, they are further hampered by a lack of sufficient pay steps to enable them to advance as rapidly or as far as fair play would dictate.

From Presidential actions emanating from the White House, it is very obvious that Mr. Nixon has a very low regard for people who work with their hands—the so-called blue-collar workers.

First, he vetoed a bill early this year which would have granted a long-overdue wage increase to the nation's blue-collar work force. He claimed that the measure would feed the fires of inflation.

However, he did not see the same inflationary dangers in a bill which raised the wages of white-collar

workers, nor did he see anything inflationary in taking a 100 percent increase in his own pay at the start of his term.

Next, he revoked Davis-Bacon provisions in the construction industry for the avowed purpose of fighting inflation in the industry. Since labor costs make up only a very small fraction of total construction costs, it is very logical for one to suspect that motives other than the desire to curb inflation in construction motivated his actions.

When it became apparent that the suspension of Davis-Bacon provisions would create utter chaos in the industry, he revoked his order. However, in its place he issued a proclamation which places severe restraints on wage increases in the construction industry. Again, his avowed reason for taking such action is to control construction costs.

However, the same proclamation that places restrictions on construction industry wages is very vague or even silent on the matter of controlling profits, materials, finance charges, etc.

The Nixon Administration further revealed its disregard of the welfare of blue-collar workers by allowing the Public Service Contract Act to wither on the vine. This is an Act whose purpose is to protect wages

and working conditions affecting over one million employees of private contractors furnishing the government with laundry, janitorial service, guard service and other such items.

The Act was passed some six or seven years ago to insure that the government did not beat down prevailing wages in any localities for this kind of work.

Since President Nixon has been in the White House, the law has not been enforced in any meaningful manner. As a result, over a million service workers are making as much as a dollar an hour less than their counterparts in private industry.

This is a long recital of the Nixon Administration's disregard for the plight of those who are on the lower rungs of the economic ladder.

The entire labor movement is becoming increasingly aware of this sorry record being compiled by the Nixon Administration. As far as the United Brotherhood is concerned, it is going to muster all the political muscle at its command to see that justice is done not only for construction workers in private industry and in government service, but also for those people who are being victimized by the Administration's failure to enforce the Public Service Contract Act. ■

WASHINGTON



ROUNDUP

SENIOR CITIZENS—The National Council of Senior Citizens has sounded its official call for the Council's tenth anniversary convention to be held in Washington June 10-12. At least 2,000 delegates are expected to make the convention the largest and most dramatic of the Council's history.

MEDICAL MANPOWER—Although health manpower needs may slacken somewhat during the next few years, the U.S. Department of Labor predicts that they "will skyrocket" during the rest of the decade.

"Health Manpower in 1980" published in the Department's "Occupational Outlook Quarterly" says that employment of health workers is expected to jump from 3,900,000 in 1968 to 6,350,000 by 1980. Demand will be spurred by increasing coverage under health insurance plans, by the rising scope of medical services, and by population increases, particularly among elderly persons and other groups requiring the most medical care.

WAGE-PRICE CONTROLS—AFL-CIO President George Meany has renewed labor's long-standing pledge to cooperate with wage-price controls, if the President judges them necessary, provided they are applied fairly and even-handedly throughout the economy. But he made it clear that labor will not accept one-sided curbs on workers' wages while corporate profits and other earnings go unrestrained.

TRADE DEFENSE—A tremendous hardening of the demands of organized labor for defense against unfair trade competition from overseas is evident in the nation's capital.

The AFL-CIO Executive Council has taken an unequivocal position in demanding that the United States face up to the realities of "the export of American jobs", to stop subsidizing the flight of American industry abroad and to press "for the establishment of international fair labor standards in world trade".

JOBS CONFERENCE—The AFL-CIO Conference on Jobs, which will explore all aspects of the job-loss problem in the United States—from foreign trade to reconversion—has been scheduled for July 12-13 at the Statler-Hilton Hotel in Washington.

"We consider it one of the most important conferences ever held by the AFL-CIO," said Federation Pres. George Meany in a letter to union presidents asking that they reserve these dates.

Meany said a limitation on the number of delegates would be necessary to insure fair, across-the-board representation from all affiliates.

The Conference on Jobs was authorized by the AFL-CIO Executive Council during its last session.

FEDERAL WAGE STUDY—The five-member Federal Employees Pay Council has held the first of a series of meetings with Administration officials to discuss the ground rules for a survey of private industry salaries by the Bureau of Labor Statistics.

Under the Pay Comparability Act that took effect this year, salaries of federal white-collar employes are adjusted annually by the President to achieve pay comparability with private industry.

Three of the five members of the employes council—the maximum permitted from a single union or labor federation—represent the AFL-CIO. They are John F. Griner and Clyde Webber, president and executive vice president of the American Federation of Government Employes, and Rudolph Oswald, economist in the AFL-CIO Dept. of Research. Two other spots are assigned to unaffiliated unions.

REVOLUTIONARY PLAN—What its supporters describe as a "revolutionary" program of improvements in Social Security and welfare benefits for the aged is now being developed by Chairman Wilbur Mills of the House Ways and Means Committee.



Any Way You Look At It, It's A Quota System, And It Won't Work!

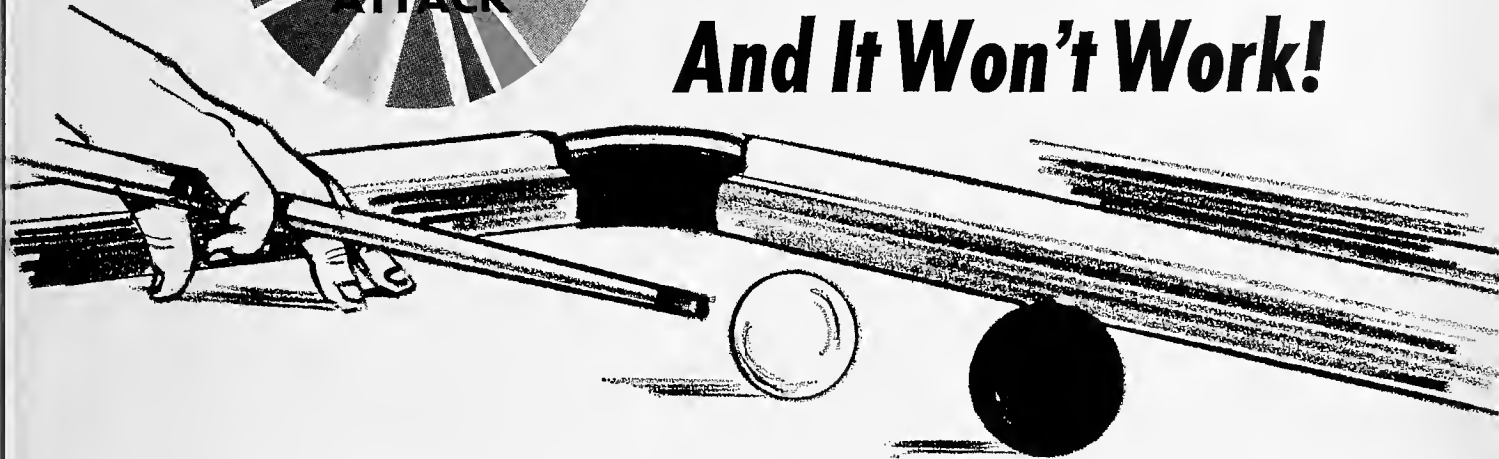

■ Spokesmen of the Nixon Administration at the Labor Department in Washington, D.C., began, one year ago, to call for new "goals" in construction crafts, apprenticeship training programs. They called for the establishment of new "timetables."

On April 1, 1970, the Labor Department introduced a proposal for revision of Title 29 of the Code of Federal Regulations covering apprenticeship and training programs, and for 12 months representatives of Building Trades unions, including our own Brotherhood, have met with Department representatives to determine the value of the new "goals" and "timetables."

It quickly became apparent that the "goals" were actually racial quotas and that the "timetables" are time demands for reaching these quotas. The Building Trades are being told, in effect, to train and place so many black apprentices for so many white apprentices . . . they are being told to have so many in the first-year training programs regardless of job conditions.

As the Executive Council of the AFL-CIO Building and Construction Trades Department stated in February, "racial quotas, under any guise, are repugnant to all Americans."

"When a proposal is made to establish racial quotas as public policy, honest men must protest," stated union leaders in our industry. "The Building and Construction Trades Department rejects the quotas to be established by the proposed revisions of

Title 29, Part 30 . . . The proposed revision directs that future apprentices be selected not on merit, but on a racial quota determined by the minority population, the minority work force, existing minority apprentices, incumbent minority journeymen, and the availability of minorities with potential capacity to become craftsmen."

Each attempt by Building Trades leaders to establish a more realistic policy regarding minority trainees has met with a cold reception in the Nixon Administration. The Labor Department went ahead and published its proposed Revisions to Title 29, last December, in spite of indications from the Building Trades that such revisions are not needed.

Statistics, available at the Labor Department itself, bear out the union position. Statistics indicate that non-whites are being enrolled in construction industry apprenticeships programs in a ratio exceeding the non-white enrollment in the adult male work force.

Last year, participation of non-white apprentices in the construction industry equalled non-white participation in the adult male work force. Approximately 10% of the adult male work force was non-white, and 10% of the construction apprentices were non-white. More significantly, the past five years have seen non-white apprentices grow from 4.4% of all apprentices in 1966 to better than 11% of all apprentices entering in the first half of 1970.

While the total of all apprentices increased 38.6% from 1950 through

1969, the number of minority apprentices jumped 364.7%! At the current rate of increase in minority apprentices, the ratio of minorities in the Building Trades apprentice programs will exceed the ratio of minorities in the United States within the year.

So why all the who-struck-John? Building Tradesmen suspect that, once again, the Nixon Administration is playing politics with the livelihood of blue collar workers. In a period of high unemployment, an attempt is being made to force Building Tradesmen to create jobs and opportunities that often aren't even there.

The Brotherhood's First General Vice President William Sidell indicated the fallacies of another aspect of this oppressive Administration effort. In a letter to Secretary of Labor James D. Hodgson, last December 29, he warned that a proposed revision in the regulations which would require that 25% of apprentices be in the first year of training is unrealistic.

As he pointed out: "In times of full employment there are always a greater number of men in the first year of training than there are in the later years of training due to attrition rates and other factors.

"In times of limited employment the men in training most severely displaced are those in the first years of training, inasmuch as these men are not in demand by employers, nor do these men feel that their loss of time and effort already given in training is

Continued on Page 29

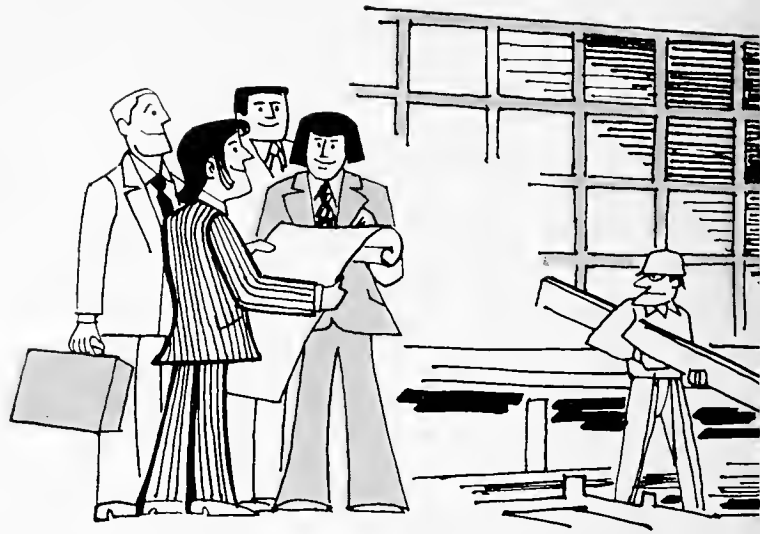

Not All Young People Are

EDITOR'S NOTE—In recent years, we have more frequently heard that “The labor movement is out of touch with the young people of today.” But could it just be that the reverse is true? Do young people understand unions, our objectives and our backgrounds? Do they make an honest attempt to try and look into our unions to see us as we really are? Building and construction trades unions are favorite targets of our accusers. Here is what one student found when she took a close look.

■ On a recent Rowan and Martin “Laugh-In” show, one of the skits involved Dan Rowan’s efforts to get help for a friend who was stuck to a live wire lying on the floor outside his office. First, Rowan asked the electrician to move the wire, but he refused because the carpenter’s hammer was lying on top of it, and he couldn’t move it because it was another union man’s job.

So Rowan asked the carpenter to move the hammer, but he said he couldn’t until the plumber moved a piece of pipe lying on the hammer. The plumber couldn’t move the pipe until the painter moved his ladder. Meanwhile, the poor fellow holding the wire was getting warm, to say the least.

This case of ribbing building tradesmen was unusual because it was gentle and humorous. Most criticism isn’t. But it wasn’t rare. As a group, building tradesmen

probably have been criticized more, and more often, than any other sector of the labor movement. Most important, the criticism often has been one-sided, derogatory rather than objective evaluation. Statistics are taken at face value without valid interpretation.

Nationally, the criticism involves three main areas. The first of these is that wage settlements in the construction industry are inflationary. It is true that skilled tradesmen make high hourly wages. According to a 1969 survey of 33 building trades by the Bureau of Labor Statistics (BLS), the average journeyman made \$5.87 per hour, the average apprentice or helper, \$4.33.

Before concluding, however, that construction workers are selfishly and greedily harming our economy, other factors must be considered.

First, the typical industrial employee works 2,000 hours each year. **But construction workers average less than 1,300 hours—700 hours less per year, according to a two-year BLS study of 13 occupational groups in four areas published in 1969. (In other words, four months out of the year without work.)** The areas studied were Omaha, Milwaukee, Detroit and Southern California.

Also, consider the problem of unemployment. **The unemployment**

rate in construction nearly doubles the rate for nonagricultural workers in industry as a whole.

Seasonal variation in construction is a main problem. **Each summer, contractors complain of a labor shortage and yet, as the unemployment and total-hours figures show, the work force is not being utilized fully.** The economist-authors of a 1970 BLS study, cited previously, say that “industry’s expectation of bad weather has more direct influence on construction activity and employment than actual weather conditions . . .”

As early as 1924, Secretary of Commerce Herbert Hoover, head of the President’s Conference on Unemployment, wrote “Bad weather is not the principal cause of seasonal idleness. Customs which became fixed when builders had not yet learned how to cope with weather conditions have not yet been changed to meet improvements in building materials, the development of new equipment and innovations in management methods.”

Forty-six years later, seasonality still is a major problem. Because of it, construction workers feel they must have higher wages in order to compensate. Staff writer Tom Walton of the Toledo (Ohio) Blade has written “When general contractors get together over martinis, the tradesmen are the bad guys, the



By **MISS HOPE SMITH**

Recent graduate student at the University of Missouri School of Journalism, now writing and editing publications in Chicago, Ill.

Opposed To Hard Hats

money grabbing, overtime-conscious, jurisdiction-jumpy bad guys." Some might conclude that were these contractors to devote their martini-drinking time to finding out what Mr. Hoover was talking about back in 1924, the unemployment rate for construction might drop and the total hours worked might rise. Then, perhaps, construction workers would not feel the need to compensate for layoffs.

The blame should not be placed entirely on management. But, neither should workers be the only whipping boys, as often has been the case in the past.

The geographic mobility often required of construction workers is an additional hardship. A surplus of construction manpower often exists in one locality, while a shortage is apparent in another. The number of jobs available in a location is fluctuating constantly.

As a result, building tradesmen often must either leave their families behind while they move from job to job, location to location, or commute great distances each day. Harold Tompkins, business manager of Sheet Metal Workers Local 474, Columbia, Mo., says, "Of our men working in Columbia, 30 are from out of town. Two men drive 200 miles a day, another makes a 152-mile round trip daily to work in Jefferson City."

Another fact of life for construction people has been the necessity to fight at the negotiating table for fringe benefits. In the past few years, most of the trades finally have won pension, death and hospitalization, vacation and apprenticeship-education fund benefits. Contractors pay X cents per hour, per employee into these funds. **It is difficult to set up broader fringe benefits in the trades because workers move from one construction job and one employer to the next.**

Still, like other union members outside the buildings trades, they must take on a "demanding-employee" stance when contracts expire. Compare this position, along with the total number of fringe benefits, with that of State Farm Insurance Co. employees. Joe Bonato, personnel director at State Farm, says the company's employees get automatic pay increases (or decreases, should the cost of living drop) which reflect the cost of living. As prices change, a comparable bonus is added to an employee's base pay. Among 58 other fringe benefits are a visiting nurse for sick employees, credit union, relocation expenses, time off with pay for voting, jury duty and doctor appointments. A National Guardsman receives the difference between his company pay and Guard pay during summer camp.

Another consideration when deciding just how greedy construction workers are is the danger inherent in their jobs. The injury rate in construction is four times the average for all industries combined. A 1967 report from the Washington bureau of Associated Press read "The four million men who make their living building the nation's projects earn the highest workmen's wages. Their jobs are also the deadliest." In the year preceding the report 2,800 tradesmen died and another 240,000 were severely injured.

The Columbia, Missouri area is no exception. Two workers fell at the Veterans Administration Hospital project, both died a few days later. At another site, a worker happened to be touching a crane, when its boom hit a live wire. He was electrocuted. Another died while working on the Senior Citizens Highrise apartment building. Asphalt, heated to about 400° F., blew on a man's arm. Some of those fortunate enough to survive are unable to return to their jobs.

Finally, building tradesmen should be given a little more credit because, as consulting engineer Carl Niewohner puts it: "I want to tell you something, they work." ■

TRANSITION...

**BROTHERHOOD
TRAINS
VIETNAM
VETERANS**

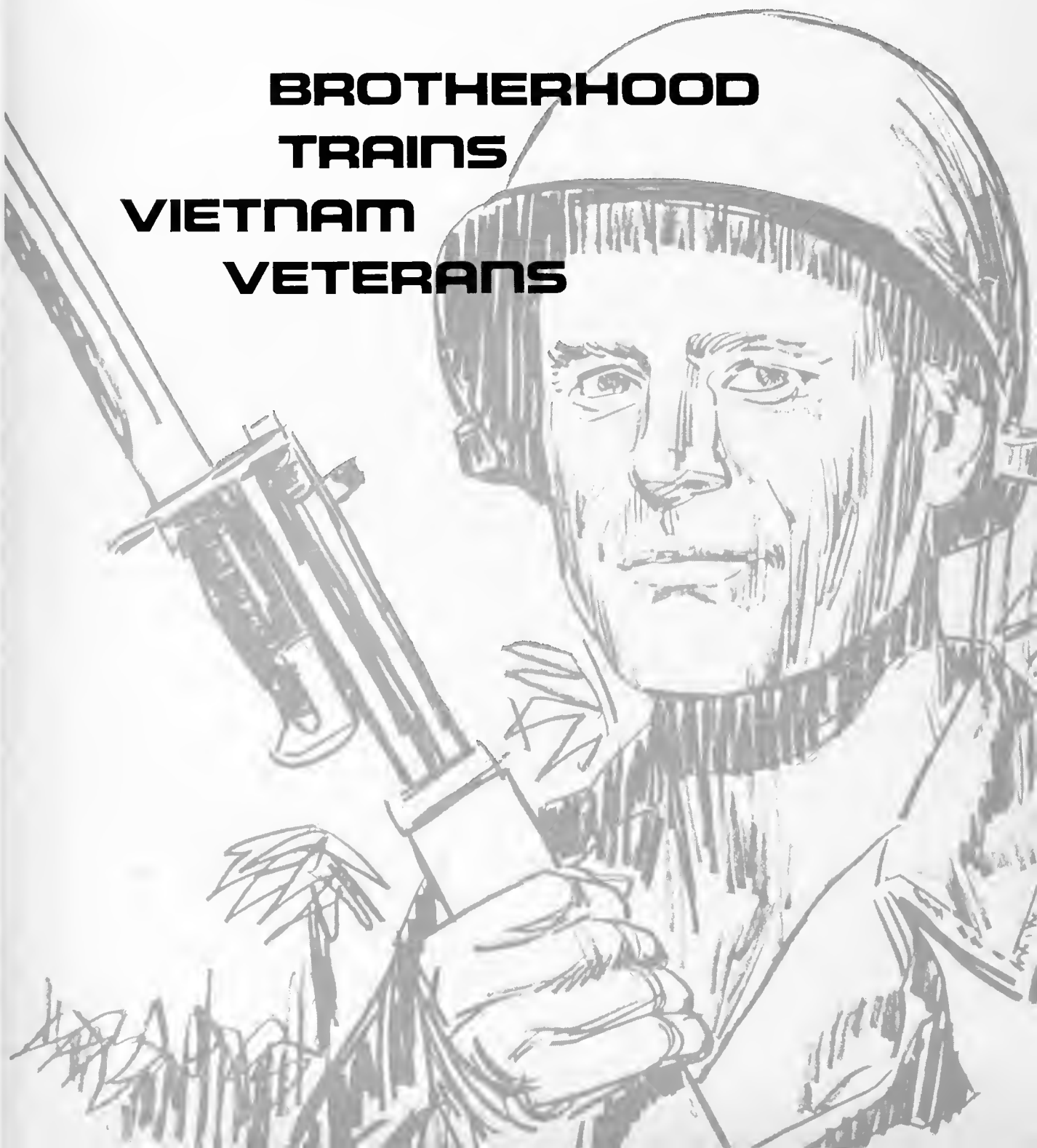

*America's unpraised servicemen,
fighting a miserable, thankless war,
deserve a break when it's over.
Our union and others are
offering it to them.*

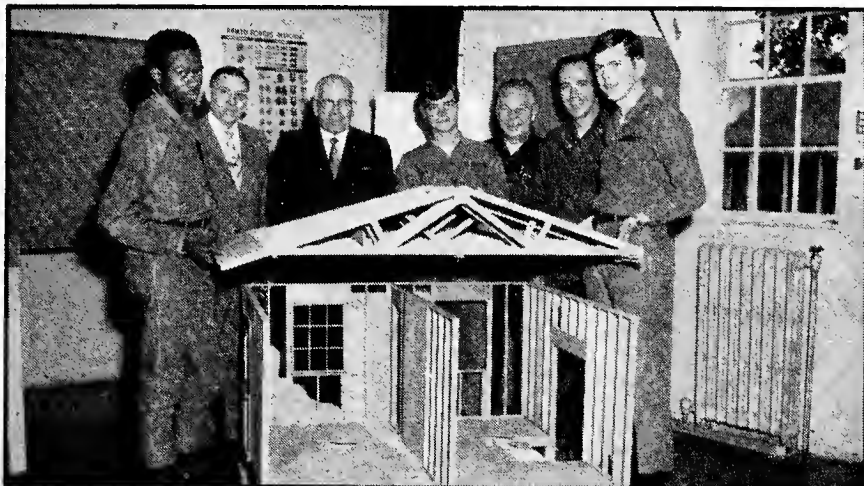

Elmer Morris, project coordinator, second from left, visits Fort Lewis. General Rep. Paul Rudd, and Instructors Gonyeau and Morostica with three trainees.

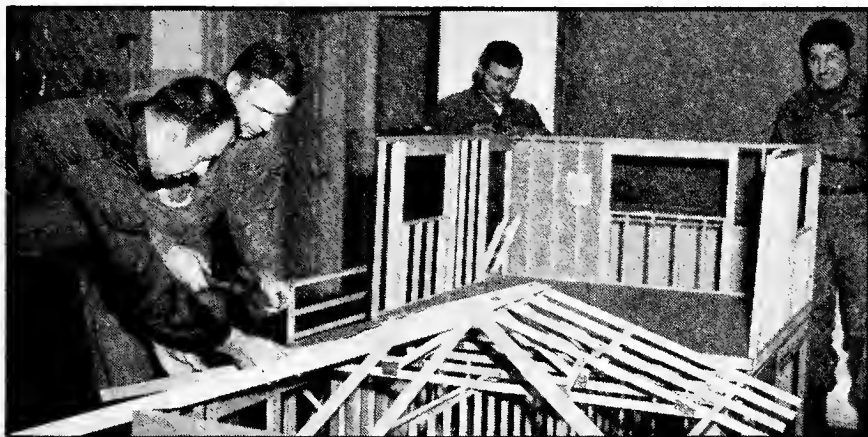

Instructor Ray Morostica describes construction methods for three veterans in Transition studies at Fort Lewis, Washington.



Instructor Gonyeau cuts a graduation cake for the first Transition class at Fort Lewis, Wash. Post officers and Brotherhood leaders join the celebration.

■ Veterans of the Vietnam War are finding it difficult to locate jobs when they get out of the service . . . particularly those under 30 and without skills.

The situation will probably get worse before it gets better, according to the U.S. Department of Labor's *Monthly Labor Review*. More and more GIs are returning from Southeast Asia at a time when there is already high unemployment at home.

The government study shows that the number of Vietnam War era veterans under 30 grew from 2.3 million in early 1969 to 3 million by last June. There were 105,000 of them without jobs early last year, but this had grown to 198,000 last June. 1971 figures will be even higher.

The report points out that while the veterans were serving with the military forces, non-veterans of the same age were joining the civilian work force and actually got a two-year jump on their GI brethren.

To help veterans overcome this handicap, the Defense Department, in cooperation with other Federal agencies, labor unions, and private industry, launched, many months ago, its Transitional Manpower Programs.

The United Brotherhood of Carpenters and Joiners of America has been an active participant in this program since March, a year ago, when it began training returning Marines at Camp Pendleton, California, and returning Army men at Fort Lewis, Washington.

With funds supplied by the U.S. Government's Manpower Development and Training Program, under a national contract, the Brotherhood also began offering in February pre-apprenticeship training and apprenticeship placement assistance to veterans at such scattered locations as Camp Lejeune, N.C.; Fort Bragg, N.C.; Fort Knox, Ky.; and Fort Sill, Okla. Last month, the program was

extended to Fort Campbell, Ky.; Fort Gordon, Ga.; Fort Carson, Colo.; and Fort Hood, Tex.

Each military installation is responsible for providing training facilities and for recruitment of carpentry trainees (all on a voluntary basis). The Brotherhood, meanwhile, furnishes instructors, training material, and calls upon the assistance of local unions, districts, and state councils for placement of graduates.

There are two instructors and approximately 30 trainees at work under the program in each of the military installations. The Transition course runs 240 hours (8 hours a day, 5 days a week, 6 weeks).

The program is primarily designed for those individuals in most need of vocational skill training or education in order to make a proper readjustment to civilian life. Priority is given to the combat disabled, those ineligible to re-enlist, and those with no civilian job experience.

Veterans are encouraged to join Transition training classes at least six months before they are discharged. In addition to carpentry instruction, there is craft instruction in bricklaying, cement masonry, painting, and other skills, conducted at several locations by other trade unions. In addition, such firms as General Motors, International Business Machines, and Sears are grooming veterans for jobs in their own firms and other firms under Transition contracts.

Transition offers special courses in law enforcement for future police officers, courses in water pollution control for workers in an area of growing need, and many other

Al Preheim, Job Development Coordinator for the Brotherhood, discusses the elements of job placement at a briefing of Transition instructors at General Headquarters.



Lt. Col. Robert C. Barnum of the Office of the Assistant Secretary of Defense for Manpower and Reserve Affairs speaks to Brotherhood Transition instructors at a briefing in Washington.

courses which help servicemen adjust to the uncertainties of a post-war world.

Transition Training under MDTA was given to nearly 12,000 returning servicemen last year. This year, more than 17,000 servicemen will be in MDTA Transition classes.

More than 100,000 more have been trained in programs other than MDTA. The Defense Department estimates that it has actually given individual guidance and counseling to more than 700,000 veterans, certainly a commendable start for a vital, ongoing program. ■



Major James R. Joy, U.S. Marine Corps, and a representative of the Office of the Secretary of Defense, explains some of the problems to be encountered by Brotherhood instructors and coordinators as they begin work at various military bases.



totally

**Most V8 power.
Biggest standard 6.**

No other pickup can top Chevy's V8 power availability. Up to 400 cubic inches. And on ½-ton models they don't come any bigger than Chevy's standard 250 Six, either. Three other engines to choose from. They all get along just great on regular, or new no-lead or low-lead gasolines.

Durable double wall cab and box.

We double-wall our Fleetside cargo box side panels top to bottom, not halfway like some pickups. So dings inside don't show outside. (Note our sledgehammer test below.) Our cab roof, cowl, body sills and upper rear wall panels are two walls of steel, too.

New Cheyenne. Other pickups just went out of style.

CHEYENNE

It's our new top-of-the-line pickup. Cheyenne offers a deep foam-cushioned bench seat in deluxe vinyl. Carpeting. Other niceties inside. Special touches outside. Bucket seats and console available, too. Cheyenne has comforts that cars thought belonged to them, and other trucks never even thought of.

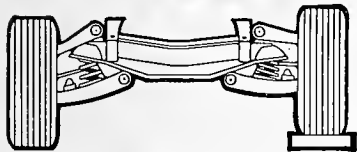

Super Suspension rides smoother.

It's fully independent up front with big coil springs to keep road shock from passing back and forth between the wheels. Or up to the cab and box. In the rear, coil or leaf springs are available—tailored to the loads you carry. So you ride smooth, even when the road isn't. Super Suspension: better because it's proved on more jobs than any other kind.



New fade-resistant disc brakes standard.

You won't find disc brakes standard on most other pickups. You get better fade-resistance, longer brake life. Power assist is standard, too, on ¾- and 1-ton models. And new finned rear brakes on ½-ton models complete Chevy's advanced brake system.

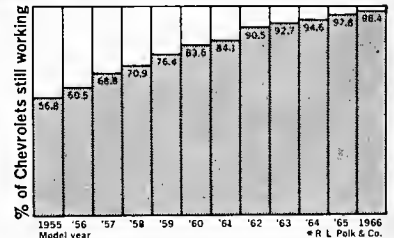

Chevy trucks work longer. Here's proof.

The latest official figures* show how Chevrolets outlast other trucks. Going back as far as 1955, for example, over 56% of the Chevrolets of that model year are still on the job. No competitive make has as many as half of its '55 models still working.



tougher.

71 Chevy trucks are here.



Service to the Brotherhood



A gallery of pictures showing some of the senior members of the Brotherhood who recently received 25-year or 50-year service pins.

(1) HALIFAX, N.S.—Harvy Horne has been a member of Local 83 since 1907. He is 95 years old. Local 83 recognized his long service to the Brotherhood recently with the presentation of a 60-year pin. Shown at the presentation, from left, are: John C. Beattie, 40-year member; Brother Horne; James Fife, president of the local union; Arthur Coleman, representative; and George Smith, 40-year member.



1

(2) CLEVELAND, O.—Local 1365 recently presented 25- and 50-year pins to its veteran members. Pins were presented by Local President John Munlbach, who is shown standing at right in the accompanying picture. Particularly honored was William Marshall, 50-year member, seated in the picture. Also shown, from left, are 25-year members Frank Masula, Vito Navar, Mike Floorchak, Ted Johnson, Andrew Frullo, and James Vild.



2

(3) OGDEN, UTAH—Members of Local 450 recently received 25-year pins. Pins were awarded to eight members, five of whom are shown in the picture. Pictured are, left to right, front row, James K. Owens, president of the local, Cecil Satterthwaite, W. W. McNeeley; (back row) Walter Nelson, Jim Stotts, and J. W. Chamberlain. The three members who were unable to attend and who received their pins at a later date were Reverend Forsberg, Walter Otis, and P. M. Beeson.



3

(4) DOWNER'S GROVE, ILL.—On the occasion of their Christmas party, December 5, and in the presence of the members, their wives, and guests, seven members of Local 1889 received 25-year pins. Pictured from left to right are: Frank Dean, trustee; Herbert Flemm; John Malich, trustee; Travis E. Mahan; Laurence Wheeler; Vincent Pokorny; Harold B. Noffsinger; Arthur Prokaski, President, who assisted in the presentation, and W. E. Corbin, president of the Illinois State Council of Carpenters, who made the presentation.



4



CANADIAN REPORT

Landlord-tenant regulations of growing concern to Canadian trade unionists

Canadian tenants have a long way to go to match the position of landlords before the law.

This is one conclusion of a study of landlord-tenant legislation prepared for the Canadian Council on Social Development.

The idea that tenants should have something close to equality with landlords is relatively new.

Ontario was the first province to make major changes in landlord-tenant legislation, which has its origins hundreds of years ago.

The Ontario legislation came into effect September, 1970, and provides protection for tenants in a number of areas, particularly security deposits. It also provides for local municipalities to set up landlord-tenant advisory bureaus.

But while Ontario was first to make changes, it now ranks fourth in terms of effectiveness of its legislation. Manitoba is top-ranked followed by Nova Scotia, British Columbia, Ontario and Quebec.

The most serious gaps in legislation, according to the CCSD study, are in rent regulation, privacy from landlords, obligation to repair, restrictions on children, discrimination, standardized leases and legal aid.

The Manitoba legislation ranks first because it is easy to read and provides for a rentalsman, both in the provincial government and in areas. The rentalsman acts like an ombudsman between landlord and tenant, and has power to make decisions.

This is the main weakness in the Ontario legislation. The advisory bureaus can do no more than act as mediators between landlord and tenant. They cannot enforce decisions. Cases that don't respond to mediation have to be settled in court.

The regular courts are poor places to decide the rights and wrongs in landlord-tenant disputes, the study agrees. Then it suggests special courts modeled after family courts which could act speedily, try to seek solutions rather than determine guilt.

Even Manitoba's legislation is imperfect, as it does not have a fair rent provision. But the cabinet is empowered to institute a form of rent review.

Nova Scotia's legislation rates high marks as it does provide for rent regulation. British Columbia's legislation makes rent increases illegal during the first year of tenancy.

Quebec is not ranked high even though it does have rent regulation. The other provinces are hardly worth ranking.

Ontario's legislation abolishes rent deposits after current leases expire. The study questions the value of abolition, saying it could lead to discrimination against young tenants and families.

This position is not likely to get much support from tenants' rights organizations springing up across Canada. Rent deposits give the landlord a whiphand over tenants. Manitoba, though, has not abolished rent deposits, but the deposit is paid to the rentalsman, not to the landlord. This is a possible solution.

The trade union movement is becoming increasingly interested in landlord-tenant legislation as more and more of their members have to rent accommodation rather than buy.

The Ontario Federation of Labour has advised its 50 labor councils to encourage the establishment of advisory bureaus in their areas and to press for further amendments in the legislation to give these bureaus more power to act.

CLC takes Trudeau to task on economy

If words could win battles, the Canadian Labor Congress won a big battle on the unemployment issue when it recently lambasted the Trudeau government because of its incredibly poor economic policies, which have resulted in the current heavy unemployment situation.

CLC President Donald MacDonald was in rare form when he teed off on the government for its "brutality, callousness, studied indifference to human consequences" in deliberately planning to increase unemployment to cure inflation.

Inflation proved to be a scarecrow used by the government to whip labor into line.

This is what the CLC presentation to the government March 1st drove home in no uncertain terms.

Canada may have been threatened with inflation due to pressures from the United States, but, in fact, this country's record is one of the world's best.

Certainly the threat of inflation did not warrant the government's all-out battle to deflate.

Hundreds of thousands of unemployed are paying the price of the government's misdirected policies.

Prime Minister Trudeau took the attack with his customary studied indifference, countering the CCF case by arguing that the strength of the Canadian economy was due to government policies.

The economy is strong statistically, in terms of exports, in terms of balance of payments. But not in human terms.

Ottawa professor joins CLC position

A prominent economist who used to be a Liberal government adviser recently bolstered the CLC position by an analysis of his own.

Professor O. J. Firestone, University of Ottawa, said that Canada has paid a high price for its anti-inflationary measures.

Sure, we have had modest price increases—3.3% from mid-1969 to mid-1970 compared with 5.8% in the United States and an average of 5% in 22 other industrialized countries.

But we have achieved this apparently desirable goal at the expense of a very high level of unemployment while

production fell far below our potential.

As a result, real output increased by only three percent when it could have increased by 5.5% if the federal government hadn't put on the brakes.

"This means that Canada could have produced an additional gross national product of \$2 billion and provided jobs for up to 200,000 Canadians had she pursued policies that would have made full and effective use of men, capital equipment, and natural resources available."

Trudeau marriage detracts from issues

Does anyone think that depressed economic conditions have depressed the prime minister?

Three days after he met the CLC delegation, the 52-year-old P.M. married a 22-year-old daughter of a prominent Liberal in British Columbia.

A Liberal wag in Ottawa is reported to have said, "Just wait until the Trudeaus have a baby in time for the next election!"

The wedding took place quietly one day after the prime minister addressed a \$50-a-plate party and fundraising banquet in Toronto and spoke for one hour on women's rights.

More urban growth is reports concern

The reports and studies, most of them paid for with government funds, come out of Ottawa at a fast pace.

The latest report dealt with urban policies.

It was an exceedingly useful report, if it did nothing more than state for everyone to hear that the problems of urban development are manifold, that there are no co-ordinated government policies to deal with them, and they are serious enough to be undermining urban life.

There are no rational policies at the federal, provincial or municipal levels.

Instead policies are spurred by "a basic belief in the righteousness of economic expansion and it is expressed in a willingness to accept growth as inevitable and indeed desirable."

Economic growth is the "conventional wisdom" which won't easily be recognized as a danger just as likely as a benefit.

In short, more growth for what?

The report by N. H. Lithwick, a Carleton University economist, lays the blame on the doorstep of the fed-

eral government, which "has a massive influence on the location, growth and structure of individual urban areas and ultimately on the urban system."

The federal doorstep is getting pretty crowded by the criticism of those who lay the blame.

West Coast labor protests supertankers

There is a growing swell for action on pollution in the trade union movement.

In British Columbia important unions are protesting the shipment of oil by supertanker from Alaska to a Washington State refinery. A spill in Juan de Fuca Strait would be an ecological disaster, according to the B.C. Government Employees' Union.

Five candidates for New Democrats

Five candidates are running for the leadership of the New Democratic Party, which is holding a leadership convention in Ottawa's Civic Centre, April 21st to 24th.

Front-runner is veteran labor lawyer David Lewis, an experienced parlia-

mentarian and one of the best debaters in the House of Commons.

Others are members of parliament Ed Broadbent and Frank Howard, plus John Harney and James Laxer, both of whom are, like Broadbent, university professors.

A big debate will take place at the convention between the leftwing nationalists and the moderates. The trade union delegation, expected to be substantial, will line up with the moderate majority on issues of foreign ownership, public ownership and Quebec. But on unemployment and economic issues, the trade union position will be pushing for far more effective action all along the line.

The total number of work stoppages throughout Canada in 1970 was 425, resulting in a loss of 7,804,480 man-days. These figures compare with 496 work stoppages and 7,732,040 man-days lost in 1969. Most work stoppages were in manufacturing; construction stoppages were low.

Ninety percent of Canada's 20 million people live within a 200-mile-wide strip threaded by the Trans-Canada Highway, the National Geographic Society says.

First millwright pension check presented in Ontario



Sam Oldfield, 72, a member of Millwrights Local 2309, affiliated with the Carpenters, was the first recipient of a pension under the local's health and pension plan first negotiated in 1965. He retired recently after active membership since 1954.

Oldfield is shown here, second from right, with, left to right, Derrick Manson, secretary, Ontario Provincial Council of Carpenters, Ted Ryan, financial secretary and business agent, and at right, Paul Smith, company representative from Matthew Conveyor Company of Toronto.

There are three company and three unions representatives on the plan's board of trustees.

The Local 2309 plan was the first for millwrights in Ontario and in the 9th District (Ontario, Quebec, Nova Scotia, New Brunswick and P.E.I.) represented by Intl. Board member William Stepanovitch. The plan covers 1,500 members of whom about 600 are in the Toronto area. There are 37 companies involved through the Association of Millwright Contractors.



'Bud' Murphy Plans to Make Union Label Sharper Weapon

By HARRY CONN

Edward Patrick (Bud) Murphy has inherited a man-sized job: making the union label the powerful weapon that most people in the trade union movement believe it can be.

Murphy, who was recently named secretary-treasurer of the AFL-CIO Union Label and Service Trades Department to fill the unexpired term of the late Joseph Lewis, discussed his new responsibilities with a PAI reporter. "We face a tremendous job in just educating our membership," he said, "but beyond that we can accomplish a few



MURPHY

miracles with the general public. People, generally, want to see justice done, so our job is getting our story across to them."

The success of the grape boycott and the boycott against General Electric products two years ago has had considerable impact on Murphy's thinking.

"In both of these cases," he continued, "we did get our story across and the public responded. We were effective because the labor movement was unified in support of both boycotts and the public could see the justice of our fight."

Murphy wants the Label Trades Department to play an even stronger role in future boycotts which have been endorsed by the AFL-CIO Executive Council. But he also warns against indiscriminate calling of boycotts which do not have solid trade union backing and which too often lead to confusing "unfair" lists.

Another "new approach" area for the Department, Murphy believes, is in consumer protection.

"To me," he said, "a union label product means a good consumer product and we want to get this idea across." He is considering union label-consumer luncheons and the AFL-CIO Maritime Trades Department, which has been holding successful weekly luncheons on maritime issues, plans to cooperate with him.

The third area of concentration is intensified "be union" and "buy union" campaigns, tying them in with an education effort against low-wage imports which are "snuffing out American jobs."

Top priority on Murphy's list, right now, is the AFL-CIO Union Industries Show set for May 14 through 19 at the Atlanta Civic Center, Atlanta, Ga. Run-

ning the show will not be anything new for him—he's been doing it since 1954.

"There's no reason why this can't be our most outstanding show," he said. "We may be in the midst of a recession—we obviously are—but we've sold out every bit of exhibit space in Atlanta. It seems that more and more unionized firms, hit by the recession, are hoping to sell their product and services on the basis of the union label."

Atlanta, itself, offers real challenges to Murphy.

"It's a major metropolis," he said, "one of the fastest-growing cities in the country. Union organizing efforts in the area have meant that Atlanta is more and more a union town. We hope our show will make it even more so."

Murphy is well equipped for his new job. At 54, he is vigorous and he radiates warm, Irish charm. His grey hair and his tendency to edge on a little weight could be misleading—he keeps pace with men half his age.

"My training as a trade unionist started early," he recalls. "My father was a vice president of the Teamsters in Cleveland and we knew what unions were all about right from the beginning."

Murphy was graduated from West Technical High School in Cleveland and attended Colorado State Teachers College, Greeley, Colorado.

At 21, he was selected as business agent for Local 880, Retail Clerks in Cleveland, and played a key role in a mass membership upswing of the local, making it one of the largest in the International.

In 1941 he served as labor consultant for the War Production Board under the direction of Joseph Keenan, now secretary of the IBEW. He was also named to the executive board of the Label Trades Department. The next three years were spent in the South Pacific Theatre as a member of the Army Air Corps.

In 1952 he joined the staff of the Department. Two years later he was named assistant to the secretary-treasurer and manager of the U-I Show.

The one thing that worries Bud Murphy about his new job is speech-making. He's making one promise, though: he's not going to bore his audiences.

"In all my years in the labor movement," he says, "I've heard enough speeches to either make me sleep or scream. Most of the people I'll be talking to feel the same way. I'm going to give them my message, stir up their interest and support and then I'm going to shut up." (PAI)

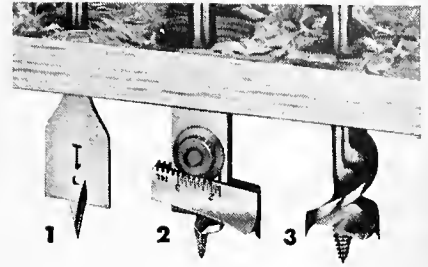

3 easy ways to bore holes faster

1. Irwin Speedbor "88" for all electric drills. Bores faster in any wood at any angle. Sizes 1/4" to 3/8", \$.90 each. 5/8" to 1", \$1.00 each. 1 1/2" to 1 3/4", \$1.50 each.

2. Irwin No. 22 Micro-Dial expansive bit. Fits all hand braces. Bores 35 standard holes, 7/8" to 3". Only \$5.70. No. 21 small size bores 19 standard holes, 5/8" to 1 1/4". Only \$5.00.

3. Irwin 62T Solid Center hand brace type. Gives double-cutter boring action. Only 16 turns to bore 1" holes through 1" wood. Sizes 1/4" to 1 1/2". As low as \$1.60 each.

EVERY IRWIN BIT made of high analysis steel, heat tempered, machine-sharpened and highly polished, too. Buy from your independent hardware, building supply or lumber dealer.

Strait-Line Chalk Line Reel Box

only \$1.35 for 50 ft. size

New and improved Irwin self-chalking design. Precision made of aluminum alloy. Practically damage-proof. Fits the pocket, fits the hand. 50 ft. and 100 ft. sizes. Get Strait-Line Micro-Fine chalk refills and Tite-Snap replacement lines, too. Get a perfect chalk line every time.



IRWIN Wilmington, Ohio 45177

every bit as good as the name

LAYOUT LEVEL



- ACCURATE TO 1/32"
- REACHES 100 FT.
- ONE-MAN OPERATION

Save Time, Money, do a Better Job With This Modern Water Level

In just a few minutes you accurately set batters for slabs and footings, lay out inside floors, ceilings, forms, fixtures, and check foundations for remodeling.

HYDROLEVEL is the old reliable water level with modern features. Toolbox size. Durable 7" container with exclusive reservoir, keeps level filled and ready. 50 ft. clear tough 3/10" tube gives you 100 ft. of leveling in each set-up, with 1/32" accuracy and fast one-man operation—outside, inside, around corners, over obstructions. Anywhere you can climb or crawl!

Why waste money on delicate instruments, or lose time and accuracy on makeshift leveling? Since 1950 thousands of carpenters, builders, inside trades, etc. have found that HYDROLEVEL pays for itself quickly.

Clip this ad to your business stationery and mail today. We will rush you a Hydrolevel with complete instructions and bill you for only \$7.95 plus postage. Or send check or money order and we pay the postage. Satisfaction guaranteed or money back.

Ask your tool dealer to order it for you. We allow the usual dealer discount on 1/4 Doz. lots and give return-mail service.

HYDROLEVEL

925 DeSoto, Ocean Springs, Miss. 39564

FIRST IN WATER LEVEL DESIGN SINCE 1950

PLANE GOSSIP

SEND YOUR FAVORITES TO:
PLANE GOSSIP, 101 CONSTITUTION
AVE. NW, WASH., D.C. 20001.
SORRY, BUT NO PAYMENT MADE
AND POETRY NOT ACCEPTED.

A Superior Swimmer

The customer found a fly in his soup. He called the waiter over, pointed to it, and said: "What is that fly doing in my soup?"

The waiter looked at it for a long moment, then said: "I'd say he's doing a backstroke, sir!"—Maurice Howes, L.U. 370, Pittsfield, Mass.

R U REGISTERED 2 VOTE?

And A Little Paunchy?

After age 45 or so, much of a man's get-up-and-go quite likely has got-up-and-went.

UNION-MADE IS WELL-MADE

The Bliss of Ignorance

A man is happily married when his wife is the boss and he doesn't know it.

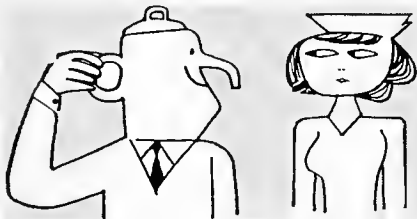

Really Percolating!

This guy is being discharged from a mental hospital and tells his nurse: "You see, with my M.D., I can always be a doctor. I also have a Ph.D., so I can be a professor instead if I want to."

"Wonderful," gushed the nurse. "You certainly have nothing to fear from the outside world!"

"That's right," agreed the departing patient. "And if neither of those work out, I can always be a teakettle!"

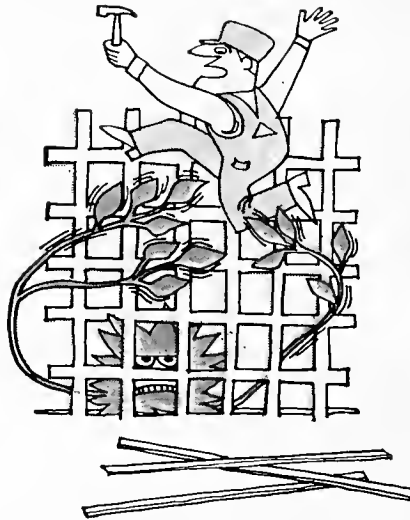

Justice Bus-ted

The bus driver was charged with allowing 150 people on his bus, far above the legal limit. The judge, to decide the case, agreed to a test. Sure enough, only 76 people could get aboard and the bus driver was cleared. Later he admitted he had been guilty.

"But you couldn't have," said the bailiff who arranged the test. "I couldn't get a single person on after 76 got aboard!"

"Yes," replied the driver, "but your passengers were not trying to get home . . . mine were!"—F. S. Millham, Fullerton, Pa.

WORK SAFELY—ACCIDENTS HURT

A Biting Remark

And then there was the eager termite who walked into the saloon and asked: "Is the bar tender here?"

UNION DUES BUY RAISES

Some View, Too!

The Mama's Boy finally got married and when the couple had settled down for the night he stood looking out the hotel window. After a long and undecided wait, his bride finally said: "Dear, don't you think it's time for you to come to bed?"

"No," he replied. "Mother told me this was going to be the most beautiful night of my life and I don't want to miss any of it!"

This Month's Limerick

A careless young boatman named Ray
On his cruiser sailed out on the bay.

He had a leaking gas tank
That he now has to thank
For making possible his Heavenly Day.

Relieving the Boardam

The carpenter on the train stopped the conductor and asked: "What kind of lumber do you want?"

The puzzled conductor replied: "I don't want any lumber!"

"Then why," asked the carpenter, are you always yelling: "Get aboard!?"—Michael Cestone, L.U. 350, New Rochelle, N.Y.

I → ALL—ALL 4 I

Rely on The Old Bag!

Our business agent says the proposed bag-of-wind safety device for automobiles is nothing new; he's had one in his car for years; his mother-in-law.

BE AN ACTIVE UNIONIST

Or A Rat?

Consider the modern girl; she screams at the sight of a mouse, but readily climbs into a car with a wolf. —Mrs. Willard Trnka, Silver Lake, Minn.

UNIONISM STARTS WITH "U"



"According to this chart, I'm nine inches too short!"

R U COIN 2 D UNION MEETING?

Wanted to Go Study With Him

The curvey little co-ed was desperate to pass a course she was obviously failing. After class one day she followed the young professor to his office. "Oh, professor," she cooed, "I'd do anything . . . just ANYthing . . . to get a passing grade in your course!"

"Let me understand," he leered, "you mean you'd do ANYthing?"

"Just anything at all," she replied in a honeyed voice.

"Then STUDY!" he thundered.



"We Congratulate..."

... those members of our Brotherhood who, in recent weeks, have been named or elected to public offices, have won awards, or who have, in other ways, "stood out from the crowd." This month, our editorial hat is off to the following:



From left: Auxiliary Secretary Wilma Brownier, Patti Brownier, Auxiliary President Hope Cain, Pamela Herdel, and Ona Herdel.

SCHOLARSHIPS—Ladies Auxiliary 170, East San Diego, Calif., presented its first scholarship award to a deserving local student in the 1950's and has presented an award every year since.

In 1970 two \$75 awards went to students attending a local junior college. One of the students, Pamela Herdel, was honored for a second time. She is the daughter of Mr. and Mrs. Fred Herdel of LaMesa and granddaughter of a long-time active member and past president,

Ona Herdel. Pamela attends Grossmont College in El Cajon.

Patti Brownier, a graduate of Crawford High School, is the other recipient. She is the daughter of Mr. and Mrs. R. Brownier. Her father is a member of Local 1571 and her mother is secretary of the auxiliary. Patti plans to attend Mesa College.

The auxiliary also contributes to the state scholarship fund and active in other programs for young people.

SERVICE CLUB LEADER—Louis-Israel Martel, of Manchester, N.H., Secretary-Treasurer of the New Hampshire State Council of Carpenters and an officer of Local 625, has been elected general president of the Richelieu International at the annual congress of the organization in Ottawa, Ont. He is the second United States citizen to be elected to the top post in the organization's 25-year



MARTEL

history. Martel was previously secretary-general and vice president of the organization. He won the post in a contest with a Montreal contender. Martel was a founder of a Richelieu Club in Manchester and he helped to found seven of the 15 such clubs in New England.



HANDSHAKE—Stephen Lewis, new leader of the New Democratic Party in Ontario, is congratulates Rene Brixhe, representative of the Lumber and Sawmill Workers in Northern Ontario, on his election as NDP candidate in the riding of Cochrane North. Brixhe is a vice-president of the Ontario Federation of Labor.

new AUDEL CARPENTERS & BUILDERS GUIDES

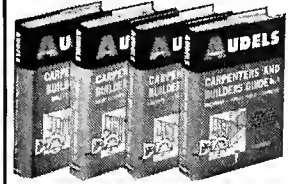

4 VOLS.
1616 Pages
Heavily Illustrated
ONLY \$18.50

INSIDE TRADE INFORMATION—for Carpenters, Builders, Joiners, Building Mechanics and all Woodworkers. Here are the short-cuts you want—new methods, ideas, solutions, plans, systems and money-saving suggestions. A complete course for the apprentice—a practical daily help and Quick Reference for the master worker. Mail COUPON TODAY to get these helpful guides used by thousands of carpenters. Shows you—

HOW TO USE: Mitre Box, Chalk Line, Rules & Scales, Steel Square & Settings 12, 13 & 17. **HOW TO BUILD:** Furniture, Cabinetwork, Houses, Barns, Garages, Skylights, Stairs, Hoists, Scaffolds. **HOW TO:** File & Set Saws, Do Carpenters Arithmetic, Solve Mensuration Problems, Estimate Strength of Timbers, Set Girders & Sills, Frame Houses & Roofs, Estimate Costs, Read & Draw Plans, Draw Up Specifications, Excavate, Lath, Lay Floors, Hang Doors, Put On Interior Trim, Insulate, Paint.

MONEY BACK GUARANTEE

You must be COMPLETELY satisfied with the Audel Guides you order, or you may return them within 10 days and get your money back.



ORDER NOW!

MAIL COUPON TODAY

THEO. AUDEL & CO., 4300 W. 62nd St. C-041
Indianapolis, Ind. 46268

Please mail me Carpenters & Builders Guides, 4 Vols. Enclosed is down payment of \$6.00. I agree to pay balance, including shipping costs, within 30 days. If I am not completely satisfied with my Audel Guides I may return them for refund.

Name _____

Address _____

City _____

State _____

Zip _____

SAVE SHIPPING COSTS. Enclose \$18.50 (plus sales tax, if any) and we pay postage.

The Real Pros demand Lee

*Designed by Carpenters
Especially for Carpenters*

There's plenty of comfort, convenience and work-saving features in these overalls. Made just like you want 'em... because they're designed by workers like yourself. Guaranteed to be the best you've ever worn or we'll take 'em back. No questions asked.

Lee® UNION MADE
M.R. CARPENTERS' OVERALLS

H. D. LEE COMPANY, INC.
SHAWNEE MISSION, KANSAS 66201
"World's largest manufacturer of union-made workwear."



YOU GET **MORE**
OUT OF THEM
'CAUSE
VAUGHAN
PUTS MORE
INTO THEM!

... AND HAS FOR
MORE THAN
100 YEARS



999

A 20 oz.
heavy duty
heavy. Large
striking face.
11" or 15"

top grade
hickory
handles.
Plain or
milled face.



FIBERGLASS

Exclusive hollow core
design adds greatest
strength, better
balance, absorbs
more shock.
13 to 20 oz.
sizes, nail
and rip.

**RIG
BUILDER'S
HATCHET**

Polished 22 oz.
striking head with
flat milled face.
Special 17"
hand
comfort
handle.

SUPER BAR

15" all
purpose pry bar.
A must for every
tool box.

Request catalog illustrating
complete line of striking
tools and pry bars.



**VAUGHAN & BUSHNELL
MFG. CO.**

11414 MAPLE AVE., HEBRON, ILL. 60034

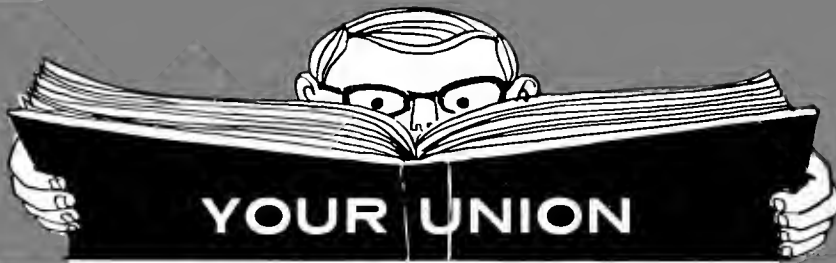

YOUR UNION DICTIONARY

This is the second of a new feature series planned to keep you better informed on the meanings of terms related to collective bargaining, union contracts, and union business. Follow it closely, and your union membership will become more meaningful, and your ability to participate in decisions which affect your future and security will be strengthened. It was compiled by the International Labor Press Assn. and is used with permission.

A

appropriate unit: Decision, by an NLRB examiner, after hearing, of what constitutes (who is to be included in) an appropriate unit for purposes of an NLRB representation election and subsequently collective bargaining.

approved pension plan: A retirement plan meeting regulations of the Treasury Department and enjoying tax advantages therefrom.

arbitration: Submission of a labor dispute to a third party for judicial settlement. Most frequently applied when labor and management disagree on interpreting contract language applicable to a grievance. Procedures are customarily specified in the collective bargaining agreement; decisions are customarily final and binding.

area differential: See geographic differential, regional differential.

area-wide bargaining: See multi-employer bargaining.

arm's length bargaining: Genuine, across-the-table negotiations between an employer and the union of his employees.

assessment: A levy by a union upon its membership other than for regular dues purposes, e.g., to meet heavy strike expenses or to replenish a depleted defense fund.

attrition: Shrinking of employee rolls through death, resignation or retirement.

authorization card: A card signed by a worker in a plant being organized, authorizing the union to be his collective bargaining agent. To get the NLRB to order a representation election the union must prove, through presenting such cards, that it has signed up at least 30 per cent of the workers

automation: In manufacturing or processing, the substitution of machines for men, including the use of computers, feed-back controls and other automatic or semi-automatic devices.

automatic progression: Automatic pay increases at set time intervals until maximum rate for job is reached.

average straight-time hourly earnings: The actual earnings per straight-time hour. This excludes shift differentials and overtime pay, but includes incentive and merit payments.

B

back pay: Wages owed to an employee or group of employees retroactively. Most often accrues when negotiations are continued after expiration of a contract. Other causes are arbitration awards, settlement of wage rate grievances, reinstatement of workers unfairly discharged, bookkeeping errors, underpayment under federal wage-hour law.

back-to-work movement: A rump movement among strikers, usually instigated by management, to return to their jobs without achieving a union contract.

NO MORE PLUMB BOB PROBLEMS!

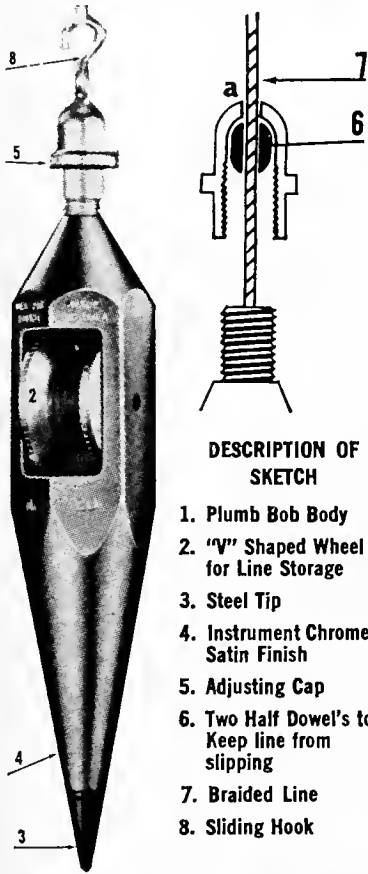

DESCRIPTION OF SKETCH

1. Plumb Bob Body
2. "V" Shaped Wheel for Line Storage
3. Steel Tip
4. Instrument Chrome Satin Finish
5. Adjusting Cap
6. Two Half Dowel's to Keep line from slipping
7. Braided Line
8. Sliding Hook

- Requires one man to operate the Bob;
- Has an adjusting cap that allows the tradesman to drop the Bob at any length on the line, eliminating slipping and knot tying.
- Complete with braided line.
- Case hardened tip, Machine made.
- This is a precision tool and accurate.
- Can be used on all surveyor's instruments.
- No more old fashioned knots to tie.
- Instrument chrome satin finish.
- Can be rewound in seconds.
- Can operate Bob with gloves on, No more cold hands and fingers.
- Will not whirl or turn when handling.

FOR ONLY \$12.50—IN CANADA \$14.50 (IN CALIF. add 5% sales tax). We pay postage, Check or Money Order.

Big Profit for dealers. Write for price list, no obligation.

GUARANTEED OR YOUR MONEY BACK.

**SENSATIONAL 'PLUMB BOB' CO.
317 W. Sepulveda Street
San Pedro, Calif. 90731**

Name
PLEASE PRINT
Address
City State Zip

Nixon Aide Tells Non-Union Contractors: "Arrogance" of Building Trades to End

BY HARRY CONN
Press Associates, Inc.

■ One of the highest officials in the Department of Labor, in a speech to a group of "open shop" contractors, outlined what adds up to a blueprint for union-busting.

Assistant Secretary of Labor Arthur A. Fletcher, in charge of wage and labor standards, spoke to the annual meeting of the Associated Builders and Contractors, Inc. (ABC), using such unbridled charges as "the era of arrogance and discrimination by some trade unions has ended. Corrupted by their sense of power, they have overreached."

He asserted that through a number of Administration moves the "era of union domination of the employment pattern in the construction industry is over."

Fletcher described the function of hiring halls in the construction industry as providing "that no man works without union approval" and declared that "the old order is not only under pressure to change: the old order is collapsing."

Among the steps taken by the Administration to undermine the effectiveness of the building trades, he said, were suspension of Davis-Bacon, new regulations in the Bureau of Apprenticeship and Training restricting union activity and denying the union role in on-the-job training.

"When I came into office," he said, "unions were relying on the Davis-Bacon Act to eliminate non-union competition. They are not doing that today."

The Labor Department official downgraded so-called hometown solutions for bringing minority workers into craft ranks and praised the Administration's Philadelphia Plan which has been denounced by organized labor.

He claimed that the building trades "have lost public support be-



cause of the outrageous abuse of their power, both in terms of demands for wage increases and in the effort which they have made to preserve the segregated character of some of the unions."

While he did warn the open shop group not to "exploit the civil rights movement as a source of cheap labor," Fletcher dwelled at length on moves to weaken the effectiveness of the unions at the bargaining table.

Donald Slaiman, director of the AFL-CIO Civil Rights Department, told Press Associates that he was "shocked that a high official of the Federal government should even imply that opportunity for minority groups come from weakening the labor movement."

He noted that tens of thousands of minority workers are among those receiving what both Fletcher and President Nixon have called "outrageous" wage hikes recently.

To counter Fletcher, Slaiman quoted from a Department of Commerce release of March 9 which declared: "Among Negro men working year-round time in blue collar occupations, union members earned about 50 percent more than their non-union counterparts."

Slaiman said that while the labor movement has a long way to go, "we recognize that Negroes are not in all jobs in the construction industry and like other industries are concentrated in the lower brackets. But in construction these lower brackets are well-paying jobs by any standards."

Slaiman charged that "fancy gimmicks like the Philadelphia Plan have, to date, produced practically nothing in increases in minority job opportunities." ■



Former GEB Member Johnson, at center, swears in the General Officers, from left: Board Members Patrick J. Campbell, Harold E. Lewis, Leon W. Greene, Raleigh Rajoppi, William Konyha; Second Gen'l. VP Herbert C. Skinner; First Gen'l. VP William Sidell; General President Maurice Hutcheson; Gen'l. Sec. R. E. Livingston; Gen'l. Treas. Peter Terzick; and Board Members George Bengough, William Stefanovitch, Charles E. Nichols, Frederick N. Bull, and Lyle J. Hiller.

General Executive Board Installed in Headquarters Ceremonies

■ In a traditional and solemn ceremony, Saturday, March 27, in the auditorium of the General Headquarters Building in Washington, D.C., the General Executive Board Members of the Brotherhood were sworn in for ensuing four-year term.

A quiet gathering of families and friends watched with members of the official staff as Former General Executive Board Member Charles Johnson, Jr., installed the new slate of Brotherhood leaders.

At the close of the ceremonies, each General Officer spoke briefly, thanking those in attendance and expressing the hope that the Brotherhood will continue to maintain the fine spirit and progressive actions of the 31st General Convention, which elected him.

The installation ceremonies came at the conclusion of a week of work by the Brotherhood's General Executive Board. ■

Introducing The Newest Member of The General Executive Board

William Konyha, an active leader in Brotherhood affairs in the Middle West for more than three decades, was installed March 27 as the newest member of the General Executive Board.

Elected to the new position by the 31st General Convention at San Francisco, last August, Konyha brings to his new post wide experience in job safety, pension planning, and contract negotiations.

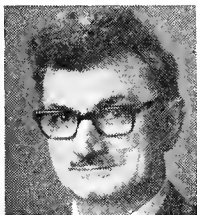

Konyha

He joined the craft at an early age, working on home construction jobs beside his father, a home builder, at the age of 14. In 1932 he became an apprentice in Local 1180, Cleveland, Ohio.

In 1938 he became a union organizer and assisted the late Harry Schwarzer in organizing the lumberyards and shops in the Cleveland area. He volunteered for service with the Seabees in World War II and served as a first class carpenter in the South Pacific until October, 1945, when he received an honorable discharge.

He then returned to Local 1180 and to the trade. In 1947 he became a safety representative of the Cleveland District Council and president of Local 1180. At that time he initiated new safety laws in construction which have become part of the safety standards of the State of Ohio. His work in this field has brought him citations from the City of Cleveland, from Cuyahoga County, the Ohio Senate and House of Representatives, and

from other official groups.

In 1952 he was appointed a general representative of the Brotherhood, and his work at that time was directed primarily to representations at the atomic energy plant in Waverly, Ohio. There were 2,600 Brotherhood members employed on this project at the height of its construction, and the sound labor record achieved there prompted the U.S. Secretary of Labor, James Mitchell, to cite Brother Konyha for his work.

GEB member Konyha has been president of the Ohio State Council since 1962. He helped to launch a state pension program, and a health and welfare program covering most of the State of Ohio. A vice president of the state AFL-CIO, he is now president emeritus of Local 1180.

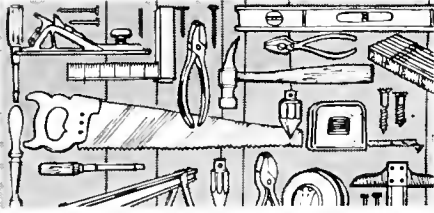

LOCAL UNION NEWS

First Pension Checks For Outside Carpenters in St. Louis

Nineteen members of the Carpenters' District Council of Greater St. Louis, and 25 wives of deceased members received over \$56,000, March 1, as the council made the first payments from their new pension plan for outside carpenters. Ollie W. Langhorst, executive secretary-treasurer made the check presentations in ceremonies at the Carpenters' Hall.

Covers 9,000 Members

The new pension plan, covering approximately 9,000 outside carpenters, was negotiated in contract talks with area contractors in 1969. The plan became effective May 1, 1969, with first payments authorized after May 1, 1970. Because of the need to have the Internal Revenue Service clear the plan, first payments were delayed until March 1. Another segment of the Carpenters' District Council members—cabinet makers, mill-

men and industrial workers—are already enjoying a pension plan.

The plan provides four types of benefits: normal pensions, early retirement, disability payments and a death benefit for survivors of participating members. The amount of the benefit varies in each category depending on the length of service.

First payments included:

\$20,189 to 15 carpenters who will now begin receiving monthly retirement checks ranging from \$42 to \$56 depending on length of service;

\$423.92 to four carpenters for monthly disability payments;

\$34,500 to the wives of 25 deceased carpenters with payments ranging from \$600 to \$1500 each. The pension plan has an insurance policy for survivors included in its benefits.

"There is a good surplus in the fund now," says Art Elsperman, president of

G. L. Tarlton Contractors and management trustee and president of the fund. He added: "Our aim is to keep enough in the fund to pay all eligibles, even if it's a bad year and income into the fund is down. If there were to be any surplus over this reserve in the fund, of course the trustees would certainly consider increasing the benefits."

Also Helps Industry

Elsperman concluded, "The fund also helps industry, because it helps the older man retire at an early age, if he so chooses, thus allowing younger men to move up more quickly."

One pensioner receiving his check commented, "You know, you get a comfortable feeling when you know that there are people who care—who are aware of the needs of older persons and are doing something about it. You just don't know how much this means to me."



Receiving first payments under the Carpenters' District Council's new pension plan for outside carpenters were: 1st row from left, receiving death benefit payments—Mrs. Albert Banze; Mrs. Thomas Cody; Mrs. Clive Dotson; Mrs. Russell Blanner; Mrs. Frederick Struebing; Mrs. James Martin; Mrs. William Spellbrink; Mrs. Richard Pinnell and Mrs. Joe Clubb (guest). Receiving normal pension benefits were: Arthur E. Jones; Arnold Baker and Victor Gaehele. 2nd row from left, receiving disability payments are Charles J. Carnoske; Earl Hodge; Joseph. A. Clubb and Robert W. Cawthorn. Receiving normal pension benefits were John M. Mason; James L. Allen; Russell Walker; Matthew Burkart; Hobert H. Bowen; Virgil M. Wilcox; Clarence Matthews; Rollin Pierce and William L. Waters. Back row: Carpenters' District Council Business Representatives Leonard Terbrock; Dean Sooter; James Watson; Lawrence Daniels; Michael Heilich; William Fields and Edward Thien; Management Trustee and Fund President Art Elsperman, president G. L. Tarlton Contractors; Executive Secretary-Treasurer Ollie W. Langhorst; Assistant Executive Secretary-Treasurer Carl Reiter; Director of Jurisdictional Research Pleasant Jenkins; Business Representative Herman Henke; Management Trustee Max Barken, president Max Barken Realty Co.; Business Representative Leerie Schaper; Fund Advisor Bill Hall, Powers Carpenter & Hall; and Management Trustee Herb Jones, Jones Kissner Construction Co.

Georgia Inaugural Stands 'Union Made'

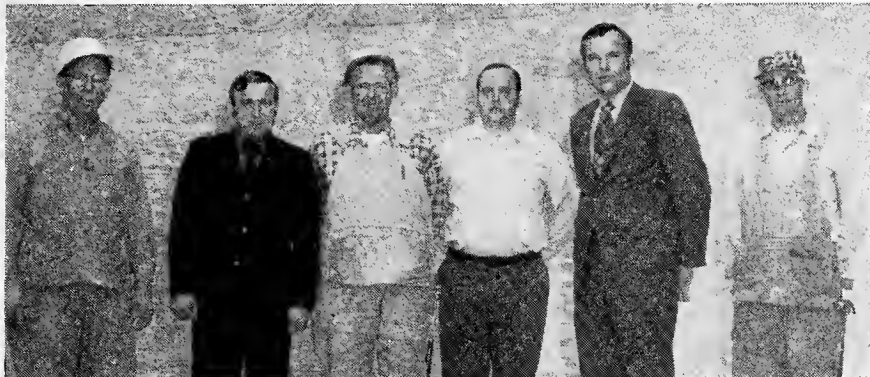

Standing on the steps of the Georgia State Capitol in front of the platform used for the inauguration of Governor Jimmy Carter, January 11, are members of Local 225, who constructed the platform for the occasion. From left to right: W. T. Allen; J. F. (Bud) Cross, assistant business agent; Walt Denning; Melvin McWilliams, superintendent, McDevitt Street Company; Herbert H. Mabry, president, Local 225, and secretary, Georgia State AFL-CIO; and A. J. Lawson.

Further Activity at Safeguard Project

In early 1970 the nation's first Safeguard Ballistic Missile Defense Complex moved into the State of North Dakota and progress on the project is going well, reports Isador Wetzel, business representative for Local 2028, Grand Forks, N.D. Two separate sites are located in the northeastern part of the state, near Langdon, and consist essentially of enormous radar installations, already well on their way to completion. (See last month's issue of *The Carpenter*, pages 6, 7, and 8, for a story on winter construction.)

Scheduled for over-all completion in early 1973, the highly sophisticated complex, along with others to follow in various sectors of the U.S., will form a defense system that will detect and, by means of the Spartan and Sprint missiles, intercept and destroy any approaching enemy missiles hundreds of miles before they reach their targets.

Construction of this initial Safeguard Complex is being performed by Morrison-Knudsen Company and Associates under a \$137,858,850 contract awarded on April 1, 1970.

The contracting team began site excavation only four days after contract award, despite deep drifts of snow that lingered late into Spring. In mid-June, structural operations were started on four principal "buildings" involved in the project—superstrong buildings, with walls as thick as eight feet, that will require a total 176,000 cubic yards of concrete laced with an incredible 50 million pounds of reinforcing steel and more than 10,000 tons of structural steel.

By early October, some 2,200 men were on the job, 620 of them being journeyman Carpenters. They had completed more than a million yards of excavation and had placed approximately 61,000 yards of concrete along with 17.5 million pounds of reinforcing steel. All four of

the fortress-like buildings were growing rapidly toward a point where various areas could be enclosed before sub-zero cold precludes most outside activities. During the winter, electrical and mechanical work was started within the enclosed areas.

The enormous construction effort, also includes scores of appurtenances—among reservoirs, roads, substations, cooling towers, heat sinks and utility tunnels. In all, it is a job quite unlike the many missile projects which have preceded it.

Quota System

Continued from Page 11
of enough significance to resist seeking other employment.

"The construction industry is presently experiencing a traumatic shortage of employment opportunities for the already-trained men in the industry."

He called projections of anticipated industry needs by experts in the industry the "most sound basis" for the declaration of apprenticeship openings... and not quotas.

Administration proposals are uneconomic, because they would inundate apprentice programs with unqualified, short-term dropouts at the expense of dedicated, future craftsmen.

The future of our skilled trades rests on a sound apprenticeship program. The proposed revisions in regulations would be another unjustified attack on the Building Trades. We will oppose them at the Department of Labor, in the Halls of Congress, and, if necessary, in the public press and at the ballot box. ■

START A MONEY-MAKING BUSINESS FOR LESS THAN \$50!

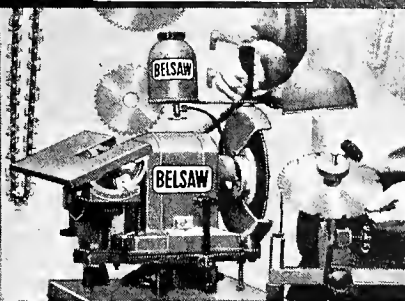

You can have your own lifetime business right at home...work in spare time... and make up to \$200 a month CASH! My FREE PLAN gives you all the facts: How to start, how to grow. You don't need previous experience. You don't have to sell. I'll even finance you. People bring you the work and pay cash. Over 90¢ of every dollar you collect is clear cash profit. And you work when you want to. Let me prove you can't find a more certain, lower cost, higher paying business of your own.

Just Mail Coupon—No Salesman Will Call

BELSAW SHARP-ALL CO.
Stan Field, President
732A Field Bldg., Kansas City, Mo. 64111

FREE BOOK

Name _____
Address _____
City _____ State _____ Zip _____

**Be Better Informed!
Work Better! Earn More!
ORDER YOUR COPY
of
SIGMON'S
"A FRAMING GUIDE
and STEEL SQUARE"**



- 312 Pages
- 229 Subjects
- Completely Indexed
- Handy Pocket Size
- Hard Leatherette Cover
- Useful Every Minute

Gold mine of understandable, authentic and practical information for all carpenters and building mechanics, that you can easily put to daily use. Dozens of tables on measures, weights, mortar, brick, concrete, cement, rafters, stairs, nails, steel beams, tile, many others. Use of steel square, square root tables, solids, windows, frames. Every building component and part.

SATISFACTION GUARANTEED OR MONEY REFUNDED

ORDER TODAY **\$4.00** Pastpaid, or COD, you pay charges.

CLINE-SIGMON, Publishers

Department 4-71

P. O. Box 367 Hickory, N. C. 28601



Buffalo Local Honors Large Group of Veteran Members

A large group of veteran members of the Brotherhood assembled in the hall of Local 9, Buffalo, N.Y., recently to receive service pins. Honored were:

William Adams, John Addie, Richard Anger, Leonard Baumgart, Julius Becker, Wilbert Bernsdorf, Eugene Bilger, Roy Carroll, John Cheslow, James Defibaugh, Henry Donner, Patsy Dorazio, George Eggleston, John Freda, David Fulton, Robert Gassman, Joseph Gauthier, S. A. Giardina, Michael Granziano, Charles Hine, Joseph Kaufman, John La Vigne, Al Langfelder, Ernest Lederhouse, Albert Leising, Daniel Luraschi, Ross McCoy, George Meyer, Joseph Meyer, Calvin Miller, Pascal Minotti, Mauno Nicander,

Anthony Notara, Holger Olsen, Joseph Pulverenti, Gerald Rice, Lynn Rice, Homer Rubeck, John Rubeck, Howard Schutt, Nelson Schutt, William Sinclair,

Nicholas Strascina, John Stronecki, Raymond Swannie, Cirino Torrisi, Gordon Waldhauser, Robert Wessner, and Earl Willison.



ABOVE: Buffalo Council President Herman Bodewes presents pins to Wilson Kilvington (30 years), Emmet Lynch (50 years), John E. Simoneit (50 years), and Stewart Gardner (50 years). Not present but also honored as 50-year members were Sam Carson and Chester Widenor. A 65-year member, John Millors, was not able to attend because of illness.

STAIRWAY CONSTRUCTION MADE EASY



WITH THIS NEWEST BOOK

In plain language and with over 50 illustrations and photos, you are shown the methods that years of experience have proven the easiest, fastest, most practical and efficient.

Even with no previous experience you will be able to build a good stair the first time. It gives complete, detailed, easy-to-follow instructions on how to lay out, cut and build a more perfect stair. It shows the basic construction methods of all types, including winder and circular stairs.

This is the most complete book on stair construction published in the past 30 years. Increase your skill and self-confidence now. It saves its cost on the first stair built.

Satisfaction Guaranteed

\$3.50 Postpaid. Washington State residents add 18c tax. For air mail shipment add 60c extra.

Send \$3.50 money order or check to:

DOUGLAS FUGITT

11347 N.E. 124th St., Kirkland, Wash. 98033

ORDER TODAY

Name
 Address
 City
 State Zip Code



ABOVE: Alfred J. Langfelder, president of Local 9, right, was presented a 25-year service pin by Buffalo District Council President Herman Bodewes.

LABOR and MATERIAL COSTS

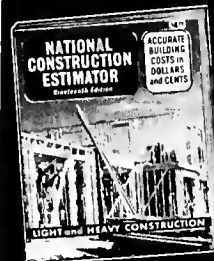

1971 UNIT COSTS
 COMPILED FROM
 THE RECORDS OF
 HUNDREDS OF
 CONTRACTORS
 AND MATERIAL
 SUPPLIERS

- 208 Pages ONLY \$ 4.75
 8 1/2 x 11
 NO ADVERTISING In California add 24c tax.

- ACCURATE BUILDING COSTS IN DOLLARS AND CENTS
- AVERAGE LABOR COSTS FOR THOUSANDS OF ITEMS
- TYPICAL SUB CONTRACT PRICES INCLUDED
- NEW ESTIMATING RULES OF THUMB

Send for FREE Building Books Catalog

CRAFTSMAN BOOK COMPANY OF AMERICA Dept. C1

124 SO. LA BREA AVE., LOS ANGELES, CALIF. 90036

- Please send me the *Nineteenth Edition of the NATIONAL CONSTRUCTION ESTIMATOR*, \$4.75
 In California add .24c Sales Tax
- Please send me *FREE Building Books Catalog*.

Firm Name _____

Your Name _____

Address _____

City _____ State _____

AMOUNT ENCLOSED \$ _____

Zip _____

10 DAY FULL MONEY BACK GUARANTEE

Job Safety Experts Needed; Apply Now

A force of almost 2,000 safety engineers, safety officers, industrial hygienists, and clerical workers will be created in the next few months to carry out the intent of the Federal Occupational Safety and Health Act.

The U.S. Civil Service Commission, working in conjunction with the Department of Labor, is now receiving applications for the positions. Members of the Brotherhood experienced in job safety programs may apply.

Most of the jobs will be GS 11 through GS 13, with starting salaries ranging from \$12,615 to \$17,761 per year.

Basic Civil Service application forms must be submitted and applicants must have civil service status or current eligibility on an appropriate U.S. Civil Service Register in the region where he wishes to be employed. Officials at the offices listed below can explain procedures for fulfilling these requirements.

To apply for a position at the national office of Occupational Safety and Health Review Commission write: Workplace Standards Administration, Office of Personnel Management, Department of Labor, Room 5337, 14th and Constitution Avenue, N.W., Washington, D.C. 20210.

For field positions, write or visit one of the following offices:

PHILADELPHIA—Regional Administrative Office, U.S. Department of Labor, 1015 Chestnut Street, Philadelphia, Pennsylvania 19107.

ATLANTA—Regional Administrative Office, U.S. Department of Labor, 1371 Peachtree Street, Rm. 122, N.E. Atlanta, Georgia 30309.

CHICAGO—Regional Administrative Office, U.S. Department of Labor, U.S. Courthouse & Federal Office Bldg., 219 South Dearborn Street, Rm. 725, Chicago, Illinois 60604.

DALLAS—Regional Administrative Office, U.S. Department of Labor, 308 Mayflower Building, 411 North Akard Street, Dallas, Texas 75201.

KANSAS CITY/DENVER—Regional Administrative Office, U.S. Department of Labor, 911 Walnut Street, Kansas City, Missouri 64106.

SAN FRANCISCO/SEATTLE—Regional Administrative Office, U.S. Department of Labor, Room 10436, Federal Office Bldg., 450 Golden Gate Avenue, Box 36017, San Francisco, California 94102.

BOSTON—Regional Administrative Office, U.S. Department of Labor, John F. Kennedy Federal Bldg., Room 1097-B, Government Center, Boston, Massachusetts 02203.

NEW YORK—Regional Administrative Office, U.S. Department of Labor, 341 Ninth Avenue, Room 831, New York, New York 10001.



These FREE BLUE PRINTS have started thousands toward BETTER PAY AND PROMOTION

That's right! In all fifty states, men who sent for these free blue prints are today enjoying big success as foremen, superintendents and building contractors. They've landed these higher-paying jobs because they learned to read blue prints and mastered the practical details of construction. Now CTC home-study training in building offers you the same money-making opportunity.

LEARN IN YOUR SPARE TIME

As you know, the ability to read blue prints completely and accurately determines to a great extent how far you can go in building. What's more, you can learn plan reading simply and easily with the Chicago Tech system of spare-time training in your own home. You also learn all phases of building, prepare yourself to run the job from start to finish.

CASH IN ON YOUR EXPERIENCE

For over 67 years, building tradesmen and beginners alike have won higher pay with the knowledge gained from Chicago Tech's program in blue print reading, estimating, foremanship and contracting. Through step-by-step instruction, using actual blue prints and real specifications of modern, up-to-date buildings, you get a practical working knowledge of every building detail—a thorough understanding of every craft. And as a carpenter or apprentice, you already have valuable experience that may let you move up to foreman even before you complete your training.

Don't waste a single day. Start preparing right now to take over a better job, increase your paycheck and command greater respect as the "boss" on the job. Find out about Chicago Tech's get-ahead training in building. Send for your free blue prints and trial lesson—today! Approved for Veterans.

CHICAGO TECHNICAL COLLEGE

D-143 TECH BLDG., 2000 S. MICHIGAN AVE., CHICAGO, ILL. 60616

FREE BLUE PRINTS AND TRIAL LESSON

Send for your free trial lesson now. You'll agree that this training is simple yet practical—your surest way to promotion and increased income in building.

MAIL COUPON TODAY

Chicago Technical College
D-143 Tech Bldg., 2000 S. Michigan
Chicago, Illinois 60616

New G.I. Bill!
Vets check here

Please mail me Free Trial Lesson, Blueprints and Catalog.

Name _____ Age _____

Address _____

City _____ State _____ Zip _____

Occupation _____

Accredited Member National Home Study Council



Outdoor Meanderings

Readers may write to
Fred Goetz
 2833 S. E. 33rd Place,
 Portland, Oregon 97202

■ Measurable Muskie



One of the chunkiest muskie-catches we've heard about in quite a spell can be chalked up for Ray Avanthey of Wabigoon, Ontario, a member of Lumber and Sawmill Workers Local 2693. The accompanying picture is graphic proof of his catch and he writes:

"Thought your readers might like to see how big the muskie grow in my neck of the woods.

This one, which was caught in Wabigoon Lake near my home, weighed 42½ pounds; so if any of you fishermen in the U.S.A. want to catch one of the really big ones, come on up and visit us."

■ Daughter's Display



William C. Byers of Rogue River, Oregon, a member of the Lumber and Sawmill Workers Local at Grants Pass, Oregon, dearly loves and appreciates the angling pastime and has passed this on to his daughter Karen. Here's photographic proof that the fair "anglerette"

has proved an apt and successful student: Karen displays a 38-lb. Chinook salmon she eased from the Smith River of northern California—on 12-lb. test line!

Karen was fishing from a boat; used egg clusters for bait and it took her 1 hour and 10 minutes to land this lunger.

■ Contentious Catfish



Getting back to the subject of big fish, we're reminded of a recent note and snapshot from Don I. Williams, financial secretary of Local 1089, Phoenix, Arizona. He writes about a member of that local, Jeff Nard, and sends in the accompanying photograph of Jeff with a whopper of a catfish he nailed, a 22½ pound specimen from Lake Mohave. So be advised that there is a lot of lake water in Arizona and big fish swimming therein. Oh yes, sometime after this was caught, Jeff pulled in a larger one, a 30 pounder!

■ Pennsylvania Penman

In a recent column we mentioned a successful elk hunting foray by Carpenter Charles Knox. It prompts a letter from York Pennsylvania's Local 181 member Ray L. Reichard of Route 1, Dallastown, Pa. (17313) who wants to get in touch with him. Will Brother Knox please note.

■ Fine Fishing Fan

The following photograph from Edward T. Gromatski, a member of Local

444, Pittsfield, Massachusetts, calls to mind that the warm weather fishing season is just around the corner. It depicts his son fishing off of grandfather Gromatski's dock at Eagleville Pond in Athol, Massachusetts—three generations of avid anglers.

Why not take a youngster fishing this year? If you don't have one of your own, see about the possibility of getting permission to take someone else's youngster.



■ Monstrous Moose

In a recent column we called attention to an undaunted moose hunter from the northwest who tripped three times to the Grande Prairie country in north Alberta and, to date, has failed to score. We hasten to improve the overall moose-hunter's average by noting that Michael McIlquham of Chippewa Falls, Wisconsin, a member of Local 1074 at Eau Claire, nailed a big bull the first time out for moose. He is pictured below, kneeling behind the monstrous rack of a bull he downed which tipped the scales at over 1,300 pounds. The moose was nailed near Lake Nippigan, Canada, at 400 yards with a 30/06 rifle.



■ Accurate Arrows

Carl J. Suesens of Burlington, Iowa, a member of Local 534, reports that a friend of his, Lyal Colton, hits big-game targets the hard way—via the bow and arrow route. Hunting in the Iowa Ordinance Area, he made two arrows pay off: a deer and a coyote.

■ **Kona Coast Marlin**



Veteran deep sea angler Attilio Bitondo, business representative of Local 257, New York City, would be the last to say that some of the largest tuna haven't been taken in Atlantic waters north of his home state, but when it comes to those Pacific monsters, he tips his topper to the briny off the coast of Hawaii. Here's a look-see at Brother Bitondo (with cap) with his arm over the shoulder of his fishing partner, Baltimore, Maryland, Ironworker C. L. Greely. With an assist from Bitondo, Greely eased the pictured Pacific Blue Marlin to boat, a monster which tipped the scales at 551 pounds and measured 13-ft., 2-in. from bill to tail. It took 55 minutes for Greely to bring the fish boatside with Bitondo's help. He used a "Kona Head" lure to dupe the Marlin off the Kona coast.

■ **West Coast Halibut**

The following photo and letter from Los Angeles Carpenter Richard Stabile, a member of Local 1506.

"You might say this snapshot is 'off the top of my head,' Fred, but it does depict a junior-size halibut I took from deep water off the coast strip between Malibu and Oxnard. This one only weighed 20 pounds but 50 pounders aren't too unusual from these waters—even bigger ones on occasions. Try these waters if you're ever in the area."

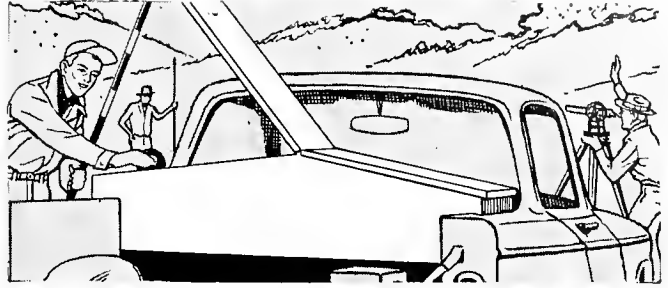

PUT YOUR TOOLS AND EQUIPMENT IN

weather guard

KEEP OUT WEATHER, PILFERERS
THREE BASIC DESIGNS, NINE MODELS...



MODEL 1
\$125.00

← STANDARD

HEAVY EQUIPMENT →

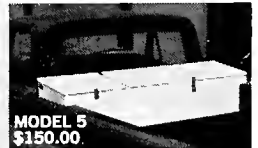

MODEL 5
\$150.00

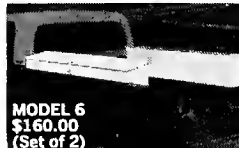

MODEL 6
\$160.00
(Set of 2)

← DOUBLE SIDE BINS

LADDER RACKS →

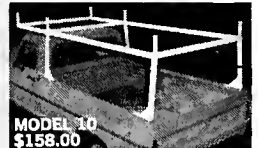

MODEL 10
\$158.00

Prices above are F.O.B.

ASK FOR WEATHERGUARD®



SEND FOR FREE CATALOG . . . Write for free 1970 Weatherguard catalog. Also available on request is Knaack 1970 catalog for general-use steel chests, work benches, accessories. **KNAACK® MANUFACTURING COMPANY**
420 E. Terra Cotta Ave., Crystal Lake, Ill. 60014
815/459-6020

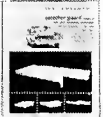

DO "101" MEASURING JOBS

with Berger Transits and Levels

- Establish foundation heights
- Level floors
- Set lintels
- Mark batter boards
- Plumb columns and walls
- Set first course of siding
- Determine differences in elevation
- Measure angles
- Set nails for concrete lines
- Align retaining walls
- Pick up elevations for finished floors
- Measure hung ceiling heights
- Set door bucks

You move in on a job faster—move out faster, too—and always know you're on the button with a Berger level or transit. Eliminate costly "do-overs," too. That's why you see so many carpenters measuring with a Berger. And so many carpenter union training programs working with it.

FREE 24-pg. BOOKLET "How to Use Transits and Levels." Gives helpful field hints . . . illustrates scores of uses you may not have thought of.

BERGER

37C Williams Street, Boston, Mass. 02119
Engineering and Surveying Instruments...since 1871

Berger Convertible Transit-Level (Model 320) \$245. Other models from \$80. to \$340. Prices FOB Boston. Tripod extra

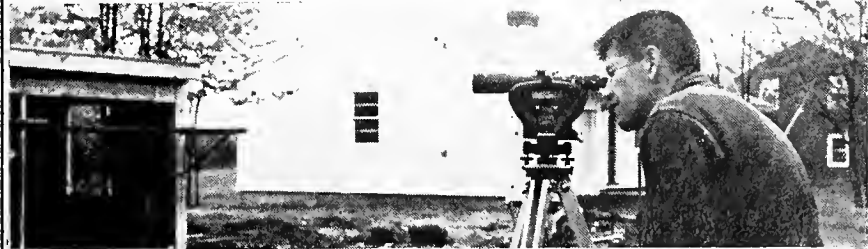

Steel or fiberglass, they pack their own punch.

With True Temper engineering, the hammers do the work. Our fiberglass-handled model gives more flex action to your swing. More drive to each stroke.

 **Fiberglass-Handled Hammer.**
16 ounces (#FG16)

Our tubular steel-handled model is strong. Yet lightweight. It puts the power at impact.

To help you team the right hammer with the right job, both models come in a variety of weight, shape and claw designs. With a cushioned grip so your hand won't slip—even with a glove on.

Either way you get the point home easier.

 **Steel-Handled Rocket Hammer.**
16 ounces (#A16R)

"You'll be glad you bought the best!"

 **TRUE TEMPER**
A MEMBER COMPANY OF ALLEGHENY LUDLUM INDUSTRIES

RETIRED CARPENTERS!

Are you looking for part-time work? The only machine that files hand, band, combination and crosscut circular saws is the

FOLEY **AUTOMATIC** SAW FILER

When you are no longer on a full-time regular job, perhaps you would like something to do for a few hours a day and pick up a little extra money, too. Your carpenter friends would be glad to have you sharpen their saws for them, especially with the precision work done by the Foley Saw Filer. F. M. Davis wrote us: "After filing saws by hand for 12 years, the Foley Saw Filer betters my best in half the time." Exclusive jointing action keeps teeth uniform in size, height, spacing—and new model Foley Saw Filer is the only machine that sharpens hand, band, both combination and crosscut circular saws.

WRITE FOR INFORMATION

You can set up a Foley Saw Filer in your garage or basement. A small cash payment will put a Foley in your hands, and you can handle monthly payments with the cash you take in. Operating expense is low—only 7¢ for files and electricity to turn out a \$1.00 or \$1.50 saw filing job. Send us your name and address on coupon for complete information on the Foley Saw Filer.

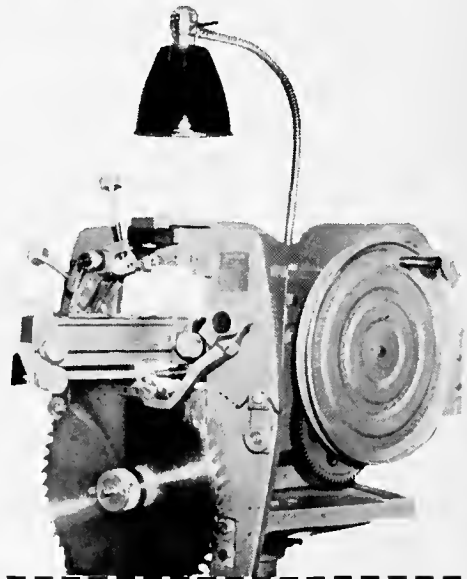

**SEND
FOR FREE
BOOKLET**

FOLEY MFG. CO. 418-1 Foley Bldg., Minneapolis, Minn. 55418

Please send literature on Foley Saw Filer and Time Payment Plan.

NAME _____

ADDRESS _____

SERVICE to the BROTHERHOOD

A gallery of pictures showing some of the senior members of the Brotherhood who recently received 25-year or 50-year service pins.



1



2

(1) LAKEWOOD, N.J.—Frederick Bowe, 76, now retired and in good health at Palmetto, Fla., recently received a 50-year membership pin from Local 2018 of Lakewood which he "cleared into" in 1949. Bowe joined the Brotherhood through Local 155, Plainfield, N.J., in 1920.

(2) LANCASTER, N.Y.—Buffalo District Council President Herman F. Bodewes, right, presents a 40-year membership pin to Stanley Derejko, member of Local 503, who was initiated September 13, 1927.

(3) LANCASTER, N.Y.—Local 503 recently presented 25-year pins to qualified members. They included: First row, Joe Tabone, Emmett Drilling (40 years), Lewis White, Stanley Kocalski (30 years), Stanley Derejko (40 years), Stanley Zynda (30 years), Grant Lavigne (30 years), Ed Jackubzak, Americo Giorgini, Sigmond Miles, Second row, Willard Willison (30 years), Joe Taburzi, George Zamerski, Anthony Suchyna, Jerome Na-

wocki, Emil Zynda, Len Putzback, Len Kissel, William Mumgall, and Ted Kuhn. Third row, Ed Wild, Connie Staszkiwicz, Gene Ruben, Elmer Pass, Ed Dombrowski, Charles Davis, Howard Hanel, Frank Slimko, and Sam Stewart.

(4) CHERRY HILL, N.J.—Local 1050 recently celebrated its 60th anniversary, and in conjunction with the commemorative banquet it presented 50-year pins to its senior members. Seven members received pins from General Representative Raymond Ginnetti. Shown from left are: Donnino Spaletta, Pietro Di Ginseppi, Gaetano Cichetti, Michael Laginestra, Ray Ginnetti, Domenico Viola, Silvino Donatucci, and Domenico DiMarino.

3



4



You'll Like Being a SKILLED LOCKSMITH



You'll EARN MORE, LIVE BETTER
than Ever Before in Your Life

You'll enjoy your work as a Locksmith because it is more fascinating than a hobby—and highly paid besides! You'll go on enjoying the fascinating work, year after year, in good times or bad because you'll be the man in demand in an evergrowing field offering big pay jobs, big profits as your own boss. What more could you ask!

Train at Home—Earn Extra \$\$\$\$
Right Away!

All this can be yours PAST regardless of age, education, minor physical handicaps. Job enjoyment and earnings begin AT ONCE as you quickly, easily learn to CASH IN on all kinds of locksmithing jobs. All keys, locks, parts, picks, special tools and equipment come with the course at no extra charge. Licensed experts guide you to success.

Illustrated Book, Sample Lesson
Pages FREE

Locksmithing Institute graduates now earning, enjoying life more everywhere. You can, too. Coupon brings exciting facts from only school of its kind Lie by N. J. State Dept. of Ed., Accredited Member, Natl. Home Study Council. Approved for Veteran Training.

LOCKSMITHING INSTITUTE
Div. of Technical Home Study Schools
Dept. 1118-041 Little Falls, N. J. 07424

Earned \$150 During Training
I realized with LOCKSMITHING I'd be able to double my income. During my training period I made \$150.
Paul Funes, New York, N.Y.



LOCKSMITHING INSTITUTE, Dept. 1118-041
Little Falls, New Jersey 07424 Est. 1948

Please send FREE illustrated Book—"Your Big Opportunities in Locksmithing," complete Equipment folder and sample lesson pages—FREE of all obligation—(no salesman will call).

Name..... (Please Print)

Address.....

City..... State..... Zip.....

Check here if Eligible for Veteran Training

Lil' Doll

MOST ECONOMICAL WAY
TO MOVE MATERIAL AT
THE JOB-SITE

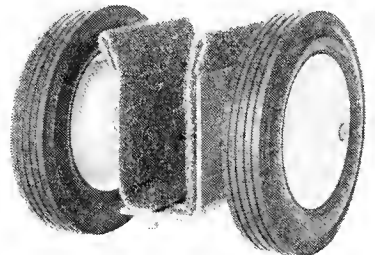

No more back-aches or sore muscles! Our Lil' Doll does all the work—a new idea for on the job transportation of materials. Doors, plywood sheets, counter tops and similar material up to 2-1/4" thick are easily rolled to the point of installation. A padded 3/16" steel carriage and 8" heavy duty ball bearing wheels give Lil' Doll the durability to carry 250 lbs. Lil' Doll easily maneuvers over electrical cords, scrapwood and other debris found at job sites.



Stable enough to work on material without removal from carriage.



One man can do the work of two without tiring, wheeling material not lifting it.

SCHAEFER

MANUFACTURING
COMPANY

3022 West Scott Avenue McHenry, Illinois 60050

New **Estwing**

TRIM SQUARE

New

Estwing Trim Square
Replaces Mitre Box

CUT TRIM & MOLDING FAST - EASY
Handy Pocket-Fit, Lightweight
with MAGIC EDGE!



See Reverse Side
For More
Easy-Cut
Details

ESTWING TRIM SQUARE

The
Ideal
Square
for Craftsmen
School Shop Use
Do-It-Yourselfers

**Tough
Aluminum
Alloy**

*Easy to
Use*

No. ETS

Only
\$2.98

**Cut Trim and
Molding
Fast — Easy**

**Replaces Mitre Box
Lightweight
Tough Aluminum
Alloy**

**Easy-Cut Instructions
with Each Square**

**Handy Pocket Size
4½" x 8¾"**

Only \$2.98—Postpaid
Send Check or Money Order

Estwing MFG. CO.

ROCKFORD, ILLINOIS 61101

2647 8th St.

Dept. C-4

South Florida Apprentice Contestants



Apprentice contestants in South Florida included, left to right, Vincent Schnetzer (tied for third), Richard Cook, Harry Harmon, James Bouchard (first place winner), Roy Lathan, William Dotson, Rinaldo Ciuffetelli (second place winner), and Roger Claxton (tied for third).

Recently the South Florida Carpenters' Joint Apprenticeship Program, sponsored by both labor and management, held its annual contest to select "The Apprentice of the Year."

There were eight fourth-year apprentices competing in the contest. These young men were selected by the joint apprenticeship committee on the basis of their overall school and work records during their entire apprenticeship term. To be selected to compete is an honor obtained only through hard work and study.

The apprentices were competing for the coveted Arthur E. Stewart Memorial

Trophy, which was initiated by the Miami Carpenters' District Council in memory of the late business representative. In addition to the trophy there are prizes of government bonds.

The contest was won by James D. Bouchard, second place Rinaldo Ciuffetelli, and a tie for third place between Roger Claxton and Vincent Schnetzer.

James will compete in a Statewide Contest to be held in Daytona Beach, May 13-14, 1971. The winner of the State Contest will compete in the International Contest to be held in Detroit, Michigan.

Pre-Apprenticeship Grads at Timber Lake



Recent graduates from the Brotherhood's pre-apprenticeship program at Timber Lake Job Corps Center, Estacada, Ore., look over their newly-purchased tools in anticipation of joining a local union in their home area. These young men worked hard to get the education and carpentry skills needed in their chosen trade, reports Center Coordinator Carl W. Hendren. Shown are, front row: Thomas Brown; Richard Booker; Roosevelt Richardson; Selwyn Belfon; Rudolph Wright; and Benson Wan; and in the rear: Coordinator Hendren and Instructor Elmore Reese. (Photo by Instructor Earl Mooney.)



IN MEMORIAM

SYRACUSE, N.Y.

Horning, Don
Paetow, Louis

L.U. NO. 15 HACKENSACK, N.J.

Hillenius, Harry, Sr.
Imperiale, Jack N.
Siegers, Henry

L.U. NO. 18 HAMILTON, ONT.

Nadolychny, Marwell
Richardson, Charles

L.U. NO. 27 TORONTO, ONT.

Doutre, Felix
Geary, Ed
Hodd, Ole
Landry, Raymond
Leadbeater, Arthur
Maki, Albert
Ritchie, Samuel H.
Woolfrey, Hubert
Yalonetsky, Joe

L.U. NO. 31 TRENTON, N.J.

Dailey, John
Gebhardt, William
O'Brien, Lawrence

L.U. NO. 35 SAN RAFAEL, CAL.

Hamman, Edward H.
Nunez, Joseph
Talbot, Ernest J.

L.U. NO. 40 BOSTON, MASS.

Aiken, Joseph, Jr.
Allen, George
McFarlane, George
Wilson, Thomas

L.U. NO. 50 KNOXVILLE, TENN.

Greenlee, E. C.

L.U. NO. 51 BOSTON, MASS.

Huber, William
Jones, William
McCarthy, John R.

L.U. NO. 53 WHITE PLAINS, N.Y.

Janecek, Edwin
Striaini, Biaggio

L.U. NO. 54 CHICAGO, ILL.

Bilek, Lorenz
Fojtik, Rudolph
Gregerson, Paul

L.U. NO. 60 INDIANAPOLIS, IND.

Adams, Howard F.
Bailey, A. J., Jr.
Barker, Harold N.
Battenfell, John
Benge, Merle K.
Bennett, Ernest
Blackford, V. D.
Bland, Hallie
Bornhorst, Carl
Bottsford, Charles
Brunnemer, Walter

Bundy, M. F.
Cauble, Raymond
Clark, Fred T.
Clouse, John
Cramer, Wayne
Dorsett, Floyd
Dougherty, Robert
Fischer, Austin
Ford, Dempsey
Gardner, Henry W.
Gray, John W.
Grove, Orville
Hammond, Richard E.
Harris, John P.
Hayes, C. L.
Helton, R. R.
Hiatt, William E.
Hoene, Charles A., Sr.
Huber, Clem
Huffman, Charles
Hunter, John
Jean, Howard F.
Jones, Perry
Kendall, Norman T.
Kimberlin, Henry A.
Kincaid, William
King, Willis L.
Lambert, Hystel
Leck, Cornelius A.
Lowe, Charles
Lutes, Rufo
Malicoat, Earl
McCord, Leroy
Miller, A. W.
Miller, Oscar
Park, Fred S.
Patterson, Chester
Phillips, Eddie L.
Piatt, Virgil
Reger, Grover
Richardson, Milo H.
Sargent, C. H.
Shafer, Robert H.
Sheets, Allen
Smith, William E.
Springer, Fred
Stambaugh, Preston
Stevens, Earl
Stewart, William
Taylor, Harry A.
Thurston, Leland D.
Tiemeir, Edward A.
Trowbridge, William
Wells, James

L.U. NO. 64 LOUISVILLE, KY.

Alexander, G. E.
Borgel, William
Browning, J.
Butcher, Roy
Duvall, Raymond
Mullins, J. K.
Nugent, W.
Rust, H. L.
Seaman, J. H.

L.U. NO. 64 LOUISVILLE, KY.

Alexander, G. E.
Borgel, William
Browning, J.
Butcher, Roy
Duvall, Raymond
Mullins, J. K.
Nugent, W.
Rust, H. L.
Seaman, J. H.

L.U. NO. 73 ST. LOUIS, MO.

Akers, Walter A.
Doyle, James J.
Christensen, Carl
Clifton, W. A.
Haake, Carl
Maus, Joseph
Meyer, Albert
Miller, James J.
Pratt, Edward
Reindl, H. L.
Schwab, Andy

Walsh, Michael J.
Young, Gary T.

L.U. NO. 80 CHICAGO, ILL.

Dahlstrom, Carl L.
Johnson, Jacob
Larson, Ernest
McCormick, Thomas M.
McPherson, Arly Ray
Nielsen, Gardon A.
Pearson, Carl G.
Steinberger, Joseph
Thompson, Tom

L.U. NO. 87 ST. PAUL, MINN.

Alver, Anton
Borgeson, Norman
Carlson, John
Hallingsworth, Melvin
Heinricks, Herman
Jones, Hubert
Kittelson, John
Luedtke, Paul
Miller, Frank
Morseth, Edwin
Severin, Lester
Slavik, Lorimer

L.U. NO. 88 ANACONDA, MONT.

Forsman, Einar

L.U. NO. 89 MOBILE, ALABAMA

Franks, Milton W.

L.U. NO. 101 BALTIMORE, MD.

Bjorson, Ben
Davis, Charles H.

L.U. NO. 109 SHEFFIELD, ALA.

Adkisson, L. H.

L.U. NO. 115 BRIDGEPORT, CONN.

Knecht, Walter
Monteiro, John
Sparano, Charles J.

L.U. NO. 127 DERBY, CONN.

Kruege, Anthony
Savoyski, John
Sylvester, Frank

L.U. NO. 132 WASHINGTON, D.C.

Chaisson, Gerald
Den-Outer, L. F.
Harper, Elmer R.
Lacek, Ed
Thomson, James

L.U. NO. 141 CHICAGO, ILL.

Anderson, Axel
Bloomquist, Erick
Erickson, Erik
Hawkinson, Sam
Hjalmarson, Axel
Kommenich, Milton
Micheluzzi, Gino
Stocklose, Frank

L.U. NO. 142 PITTSBURGH, PA.

Betler, Harry

Casale, Joseph
English, Edward
Gonzales, Candido
Wentzel, Walter

L.U. NO. 180 VALLEJO, CAL.

Daley, Wayne
Morrow, A. T.
Williams, Roger, Sr.

L.U. NO. 181 CHICAGO, ILL.

Birns, Louis C.
Johnson, Fred
Lee, Christ

L.U. NO. 199 CHICAGO, ILL.

Chapple, Frank B.
Dziagwa, Walter V.
Johnson, Frank A.
Oman, Leroy
Peterson, Carl G.
Skibbe, John C.
Soderlund, Gust
Thunstrom, Verner
Yergovich, Steve

L.U. NO. 200 COLUMBUS, OHIO

Basil, Sterlie
Russell, Darrell

L.U. NO. 201 WICHITA, KANS.

Evans, Frank
Macchden, Lloyd E.

L.U. NO. 218 BOSTON, MASS.

Bursey, Frank
Carlson, Carl
Downey, Bertram
O'Brien, Blair
Smith, John
Xavier, William

L.U. NO. 226 PORTLAND, ORE.

Bernard, Harry
Hartman, Jack
Linn, R. E.
Maruhn, Harold A.

L.U. NO. 230 PITTSBURGH, PA.

Weber, Eugene

L.U. NO. 241 MOLINE, ILL.

Finrock, Horace
Hostens, Arthur
Johnson, Clair
Karlsn, Karl
Knudsen, Elmer
Prior, Raymond
Schultz, William

L.U. NO. 246 NEW YORK, N.Y.

Frankel, Louis
Wdowiak, John

L.U. NO. 257 NEW YORK, N.Y.

Bouchard, Ernest J.
Mackey, William L.
Tarpey, James Denis

L.U. NO. 264 MILWAUKEE, WIS.

Bassi, Andrew
Giese, Raymond
Meyer, Stephen A.
Renner, Ernst
Ross, Richard

L.U. NO. 272 CHICAGO HGTS., ILL.

Hafele, Walter J.

L.U. NO. 314 MADISON, WIS.

Erickson, George
Gallagher, Tom
Johnson, Raymond
Neumeister, Maurice
Reuter, Russell
Statz, Adam

L.U. NO. 325 PATERSON, N.J.

Fusco, Samuel
Lydon, George
Moglia, Frank
Roberson, Matthew
Scarvone, Phillip
Shaw, Robert
Spinosa, Joseph

L.U. NO. 362 PUEBLO, COLO.

Bassett, Elsworth L.

L.U. NO. 366 NEW YORK, N.Y.

Benzenberg, Charles
Klebanoff, Sam

L.U. NO. 372 LIMA, OHIO

Poland, Wilbur

L.U. NO. 494 WINDSOR, ONT.

Philpott, Danny

L.U. NO. 562 EVERETT, WASH.

Amundsen, R. O.
Baudry, William
Christensen, Erling
Kjosens, Ingar

L.U. NO. 579 ST. JOHN'S, NFLD.

Wiseman, George

L.U. NO. 599 HAMMOND, IND.

Bellamy, Hazel
Dudzick, John
Heller, Jack
Nickell, Luther
Sako, John

L.U. NO. 657 SHEBOYGAN, WIS.

Ellinger, Curtiss
Gabert, Charles
Langraf, John
Methfessel, Arno
Meyer, August
Schenk, Kurt

L.U. NO. 678 DUBUQUE, IOWA

Glick, Alex

L.U. NO. 690
LITTLE ROCK, ARK.
Guffy, Delmar
Langford, Barry F.
Tanneberger, Frank
Weber, Joe

L.U. NO. 766
ALBERT LEA, MINN.
Metcalfe, Thomas D.

L.U. NO. 770
YAKIMA, WASH.
Martin, Frank

L.U. NO. 783
SIoux FALLS, S. DAK.
Hanson, Adolph
O'Hara John
Hovedstad, Holger
Klosterman, Andrew
Schroder, Paul
Traves, William

L.U. NO. 787
NEW YORK, N.Y.
Thompson, Emil

L.U. NO. 792
ROCKFORD, ILL.
Emerson, Herbert
Marten, Arnold
Mix, Albert

L.U. NO. 820
WISCONSIN RAPIDS,
WIS.
Henry, George P.
Plawman, Edward W.

L.U. NO. 916
AURORA, ILL.
Wade, Robert

L.U. NO. 964
NEW CITY, N.Y.
Barrere, Francis
Beckman, Dietrick
Brown, Egbert D.
Conklin, Armory
Cornelius, George
Koch, Theodore
Tveit, Arthur
Van Ostrand, James

L.U. NO. 972
PHILADELPHIA, PA.
Goldman, Jack
McLaughlin, LeRoy

L.U. NO. 977
WICHITA FALLS, TEX.
Greeling, James L.

L.U. NO. 982
DETROIT, MICH.
Masters, Donald
Arquette, Louis T.
Betcher, Leon I.
Kniffel, William
Masters, Donald
Nightengale, Edward S.
Pagan, Michael
Robertson, Jack

L.U. NO. 1035
TAUNTON, MASS.
Bisio, Leo J.

L.U. NO. 1098
BATON ROUGE, LA.
Babin, Clarence
Barbay, August
Coleman, J. W.
Gary, Woodrow
Hancock, Claude

L.U. NO. 1128
LA GRANGE, ILL.
Gregory, Andrew
Iacopelli, Carl

L.U. NO. 1165
WILMINGTON, N.C.
Lee, Jathen G.

L.U. NO. 1175
KINGSTON, N.Y.
Simpson, Peter F.

L.U. NO. 1185
CHICAGO, ILL.
Hofmann, Joseph O.

L.U. NO. 1204
NEW YORK, N.Y.
Kaminsky, Max
Neguth, Otto

L.U. NO. 1236
MICHIGAN CITY, IND.
Jordan, Clarence

L.U. NO. 1243
FAIRBANKS, ALASKA
Harmon, Sam
Lear, Paul
Hurstman, Bernard
Tillberg, Olov
Wittleton, Norman

L.U. NO. 1266
AUSTIN, TEX.
Back, Alfred
Bruce, A. G.
Carroll, Roy
Lerche, Alvin
Milam, R. S.
Pace, H. E.

L.U. NO. 1289
SEATTLE, WASH.
Baxter, Ralph M.
Davis, Lydell E.
Edwards, John B.
Giese, Henry A.
Isaksen, Ingvald E.
Lee, Anton
Parish, John B., Sr.
Savage, Harry E.
Way, Gerald F.
Wetterauer, Andrew

L.U. NO. 1323
MONTEREY, CAL.
McLean, William M.
Russo, Michael R.
Sutton, Ray S.
Quarles, Mortie

L.U. NO. 1332
GRAND COULEE,
WASH.
Wagner, Matt

L.U. NO. 1397
NORTH HEMPSTEAD,
N.Y.
Petersen, Walter H.
Rotondo, Guido

L.U. NO. 1400
SANTA MONICA, CAL.
Allenby, James
Armstrong, T. R.
Foster, Glen E.
Frerichs, Fritz
LaMar, Bob F.
Maxson, Dwight B.
Myers, Wilbur L.

Patton, Herbert G.
Reed, Reuben
Thiel, Clarence
Waldrip, Asa
Watson, Geordon B.

L.U. NO. 1426
ELYRIA, OHIO
Giar, George

L.U. NO. 1469
CHARLOTTE, N.C.
Measimer, Ernest E.

L.U. NO. 1478
REDONDO BEACH,
CAL.
Burnham, Albert Lee
McCrum, Robert T.
Leer, Walter J.
Robinson, Edgar A.

L.U. NO. 1505
SALISBURY, N.C.
Earnhardt, L. H.

L.U. NO. 1513
DETROIT, MICH.
Friedman, Hyman
Rochlin, Isidor

L.U. NO. 1518
GULFPORT, MISS.
Gordon, David S.

L.U. NO. 1571
SAN DIEGO, CAL.
Anderson, Louis H.
Boswell, J. T.
Cochran, Harry
Dodrv, George
Dodson, Fines
Jain, Cecil D.
Mercer, Malcolm
Parmer, George E.
Prohaska, R. D.
Sale, Arthur W.
Thornton, Roy C.

L.U. NO. 1580
MILFORD, CONN.
Wynus, George

L.U. NO. 1598
VICTORIA, B.C.
Ormiston, Douglas C.

L.U. NO. 1822
FORT WORTH, TEX.
O'Connor, Thomas P.

L.U. NO. 1846
NEW ORLEANS, LA.
Kemp, Milton
Lado, Felix
Pierce, William A.

L.U. NO. 1889
DOWNER'S GROVE,
ILL.

Meeks, Edward
Schwartz, Albert

L.U. NO. 1922
CHICAGO, ILL.
Batchelor, Leonard P.
Hammer, Peter
Leeden, Albin
Mueller, Christ
Waxberg, Sam

L.U. NO. 2203
ANAHEIM, CAL.
Balmer, James
Fordyce, Bert M.
Hoover, John B.

L.U. NO. 2235
PITTSBURGH, PA.
Bolsinger, Jack

L.U. NO. 2274
FRANKLIN, PA.
Ramsey, Charles R.

L.U. NO. 2311
WASHINGTON, D.C.
Flanagan, John S.

L.U. NO. 2527
VICTORIA, B.C.
Davidson, James

L.U. NO. 2582
MUSKEGON, MICH.
Jensen, Ahlmann

L.U. NO. 2639
DUMAS, TEX.
Bernard, C. G.

L.U. NO. 3127
NEW YORK, N.Y.
Spallino, Camillo

Some Tips on Fighting Disciplinary Discharges

Employees whose work records are generally satisfactory are most likely to win reinstatement through arbitration if and when they are discharged or suspended.

That is the finding of a 10-year study by the American Arbitration Association. The study covered discharges and disciplinary suspensions in which management's decision was reversed or softened by an arbitrator. The report appears in the U.S. Labor Department's *Monthly Labor Review*.

The AAA studied 391 arbitration decisions. In 107 cases—27 per cent of the total—punishment was reversed or softened because the employee was able to show a satisfactory work record prior to the incident.

Typical was the case of an employee fired for using offensive language toward

a supervisor and walking away from his job in the course of an argument over whether an employee who was not in the bargaining unit could do certain work.

Reducing the discharge to a 10-week suspension, the arbitrator held that the grievant has been a "fairly competent" worker for eight years and had committed no previous offenses that called for punishment.

The arbitrator said the incident was "one isolated, emotional outburst" that lasted only five minutes, and that the discharged worker was in a department where "improper language" was not only common, but commonly employed by the supervisor.

Inconsistent or random enforcement of rules is the next most frequent reason for arbitrators overruling a disciplinary discharge.

In fact, arbitrators criticized personnel practices that are lax over long periods until one hapless individual is discharged as an "example."

In 77 cases (about 19 per cent of the

cases studied) management had frequently overlooked similar violations, encouraging the belief among employees that they could disobey the rules without risking penalty.

Punishment too severe to fit the "crime" was cited as the reason for reversing company disciplinary action in 56 cases, or 14 per cent of the total. Among other reasons cited by arbitrators for reversing or softening company disciplinary action:

- The rule itself was reasonable, but its application in some cases was not.

- The grievant did not know he was risking a penalty by his action.

- Management was partly at fault.

- The grievant was punished under the wrong rule or schedule or penalties.

- Management committed procedural errors which prejudiced the grievant's rights.

- Punishment was for a reason beyond management's authority to discipline.



Lakeland News

Items of interest from the Brotherhood's retirement home at Lakeland, Florida

Phillip J. Labbe, of Local 94, Providence, R.I., arrived at the Home Feb. 2, 1971.

Robert Arnau, Sr., of Local 1725, Daytona Beach, Fla., arrived at the Home Feb. 3, 1971.

James W. Copithorne, of Local 860, Framingham, Mass., arrived at the Home Feb. 4, 1971.

Dale "Patty" Dolan, of Local 132, Washington, D.C., died Feb. 6, 1971. He was buried in the Home Cemetery.

Samuel Proctor, of Local 1846, New Orleans, La., died Feb. 7, 1971. He was buried in the Home Cemetery.

Robert J. Dvorak, of Local 2159, Cleveland, Ohio, died Feb. 13, 1971. Burial was in Cleveland.

Oscar W. Larson, of Local 257, New York, N.Y., died Feb. 19, 1971. Burial was in New York City.

Pete Fauret, of Local 993, Miami, Florida, died Feb. 23, 1971. He was buried in the Home Cemetery.

Tips on the Care and Use of Your Hack Saw

Most people are inclined to take hacksaws more or less "for granted." But hacksaws, like other tools, can be used a right way or a wrong way, and the right way is the easier.

Blades come in teeth from 14 to 32 per inch. Coarser teeth are raker-set; finer teeth are wavy-set. Use fine teeth for fine work, coarser teeth for

other work. A good "compromise" tooth for general-purpose work is the 18-tooth sawblade.

Hacksaw blades are designed to cut on the "push" stroke. Sometimes soft non-ferrous metals call for a "pull" cutting stroke. Exert little or no downward pressure in such instances.

Make certain blades are tightly tensioned; a loose blade will whip, will not cut straight and increases the possibility of breaking the blade.

The initial strokes of a blade greatly affect its cutting life. If it doesn't start cutting at once, the rubbing action quickly dulls the teeth. Sometimes, on very hard materials, it is desirable to start the cut with a few strokes of a triangular file.

At the end of the cutting stroke, relieve pressure on the work completely to avoid dragging the teeth over the work on the reverse stroke, thus dulling the blade. A steady 40- to 60- strokes per minute should be maintained. Higher speeds will heat up and dull teeth, especially on very hard materials.

Don't attempt to re-sharpen hacksaw blades. To do so effectively would require heating and de-hardening the steel, sharpening, then re-annealing.

Don't try to complete, with a new blade, a cut which was begun with an old one. The narrowed old-saw cut will damage the wider-set teeth of the new blade. It is better to start a fresh cut with a new blade if at all possible.

Check blade-holding pins of the saw frame frequently to be sure they haven't lost their grip through looseness, strained angle or wear.

—From "Sawology," Nicholson File Co.

INDEX OF ADVERTISERS

Audel, Theodore	23
Belsaw Sharp-All Co.	29
Berger Instruments	33
Bureau of National Affairs	25
Chevrolet	17
Chicago Technical College	31
Cline-Sigmon, Publishers	29
Craftsman Book Co.	30
Estwing Manufacturing	36
Foley Manufacturing	34
Fugitt, Douglas	30
Hydrolevel	21
Irwin Auger Bit Co.	21
Kedman Co.	39
Knaack Manufacturing	33
Lee, H. D.	23
Locksmithing Institute	35
Schaefer Manufacturing	35
Sensational "Plumb Bob" Co.	26
Stanley Power Tools	Back Cover
True Temper Corp.	34
Vaughan & Bushnell	24

YOU NEED
The original
"wedge-type" screwdriver

QUICK-WEDGE
SCREW-HOLDING SCREWDRIVER
IT'S YOUR THIRD HAND

does all the job!
HOLDS, STARTS, DRIVES & SETS
the screw to normal tightness!

17 SIZES
MILLIONS SOLD SINCE 1945

GET A SET TODAY!
Unconditionally Guaranteed
Finest Quality
Workmanship & Materials
At Your Dealers or Write

KEDMAN COMPANY
P. O. Box 267
Salt Lake City, Utah 84110
Phone (801) 363-4413
© 1970 by Kedman Company



In Conclusion

M. A. Hutcheson, *General President*



The Whipping Boy of the 70's

■ Much of this issue is devoted to summarizing some of the attacks which are being made on the building trades unions.

Under the guise of fighting inflation, President Nixon has clamped tight controls on the wages of craftsmen who give the industry its vitality and know-how.

Under the guise of promoting greater hiring of minority groups, the Administration has advanced measures whose ultimate effect can only be to decimate the whole apprenticeship concept, which has served the industry so well for so long.

Added to this, the Associated General Contractors are pushing for legislation which would reduce labor unions in the construction industry to glorified debating societies. Among the items advocated by the AGC for what it calls the "Construction Labor Relations Act," are the following:

1. Repeal of Davis-Bacon
2. Outlaw exclusive hiring halls and all referral systems.
3. Require multi-trade—multi-employer bargaining.
4. Make labor contracts binding when negotiated without referral back to members.
5. Provide for direct injunctive relief in jurisdictional disputes.

From all of this, it is very obvious that building trades workers have become the favorite whipping boy of the 1970's.

The claim that building trades wages are an important factor in causing inflation is as phony as a \$7 bill. At least half of all building trades workers make less than \$9,000 per year—even at today's wage rates. How these workers, who make up only a small portion of the total labor force, can cause continued inflation is difficult to understand.

Since building trades unions, in all except a very few isolated instances, are devoting increasing amounts of time, energy and money to developing programs to recruit and qualify minority youngsters for apprenticeship training, it is difficult to understand why the time-honored and effective apprenticeship system has to be attacked.

Over the years, despite any discrimination which may have existed in the past, the building trades unions have provided more decent job careers to more minority groups than any other segment of our society.

It is my personal feeling that every young man, regardless of race, creed or color, should have an equal shot at

entering apprenticeship training. I further believe that all those who want to detour or shortcut traditional apprenticeship training to "help" minority groups do a great disservice to the very people they are trying to help.

I believe all young men want to stand on their own two feet, meeting all competition on equal terms. To the extent that special favors are granted or difficult assignments by-passed for anyone under the guise of smoothing the pathway, to that extent are the recipients relegated to second-class status. First-class status comes from achievement and from application.

If someone had insisted that Willie Mays ought to have four strikes and three balls because he grew up in disadvantaged circumstances, neither he nor baseball would have benefited. I believe the same holds true in the construction industry. Neither the industry nor the youngsters involved gain very much through any schemes for achieving "instant journeymanhood."

Dr. Conant, in his study of high schools a few years ago, made a sage observation when he said: "Ten second-class men cannot replace one first-class man." Ten carpenters, none of whom can lay out a stairwell, do not equal one man who can.

In the light of their past record, it is hard to comprehend why the building trades unions should be branded the major culprit for most of the nation's ills. In all the nation's wars, the industry has fulfilled responsibilities that seemed impossible in the beginning.

Impossible rivers have been dammed; impossible bridges have been built; impossible skyscrapers have been erected.

Now, the one or two percent of the work force which makes up the construction trades unions is singled out as a major cause of inflation.

Now, the building trades, which do not have even 200,000 apprenticeship slots altogether, are pictured as the major cure for unemployment among three or four million minority youngsters.

Now, the contractors, most of whom made it big for 20 years from the efforts of their craftsmen, want to forge new legislative shackles for those craftsmen.

There are things wrong with the building trades unions. Some wage increases have been out of line. A few unions still use subterfuge to discriminate against minority hiring. Too many jurisdictional disputes still cause problems. But, the building trades are not the villain everybody tries to make them, and it is high time we told the world so in no uncertain terms. ■

THIS SPACE CONTRIBUTED BY THE TELEVISION AUTHORITY

One cancer you can give yourself.



**Horrible
isn't it?**

 AMERICAN CANCER SOCIETY

Stanley gives today's best routers even more power

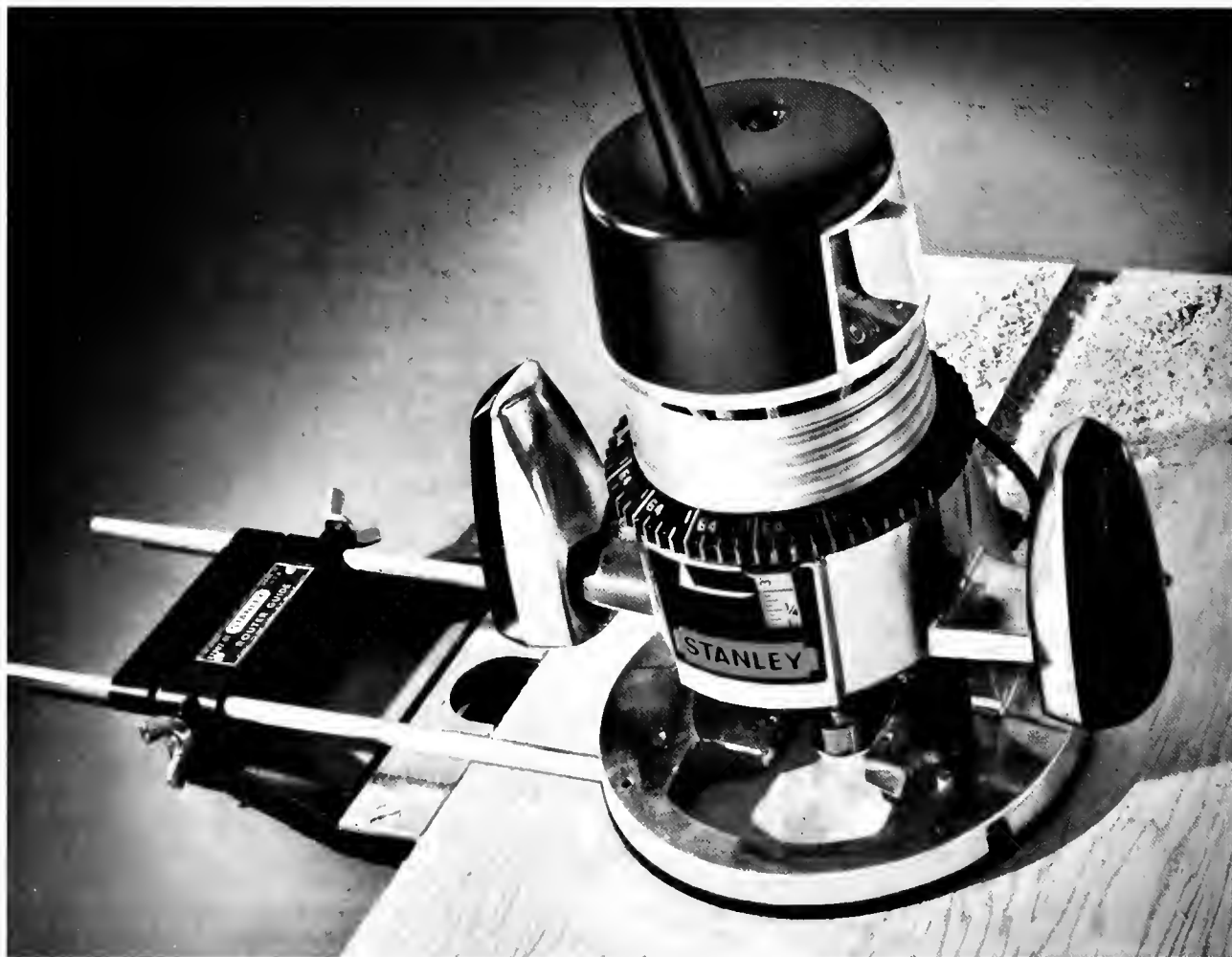

Two of today's most popular ball bearing routers have been given even greater power and capacity.

Model 91264 at \$77.00 now produces a full 1 h.p.; Model 91267 at \$87.00 has a full 1½ h.p. Each router will now accept ⅜" shank diameter bits, as well as ¼", using either of two collets furnished. Use of heavier ⅜" shank bits, however, assures less breakage under heavier torques and feeds.

Motors have welded (not soldered) leads. Micrometer depth settings are in .004" increments. Three position handles provide fatigue-free operation, bet-

ter control, with convenient thumb switching without removing either hand. A switch-operated shaft lock permits one-wrench bit changes. And *only* Stanley routers have a built-in light for better visibility for the operator.

Stanley's complete line of routers range from ¼ h.p. to 8 h.p. in electric, air and high-frequency power sources. See them at your distributor. Stanley Power Tools, Division of The Stanley Works, New Bern, No. Carolina 28560.

STANLEY

The

MAY 1971

CARPENTER

Official Publication of the UNITED BROTHERHOOD OF CARPENTERS AND JOINERS OF AMERICA • FOUNDED 1881

THE CONSTRUCTION WORKER
...more sinned against than sinner

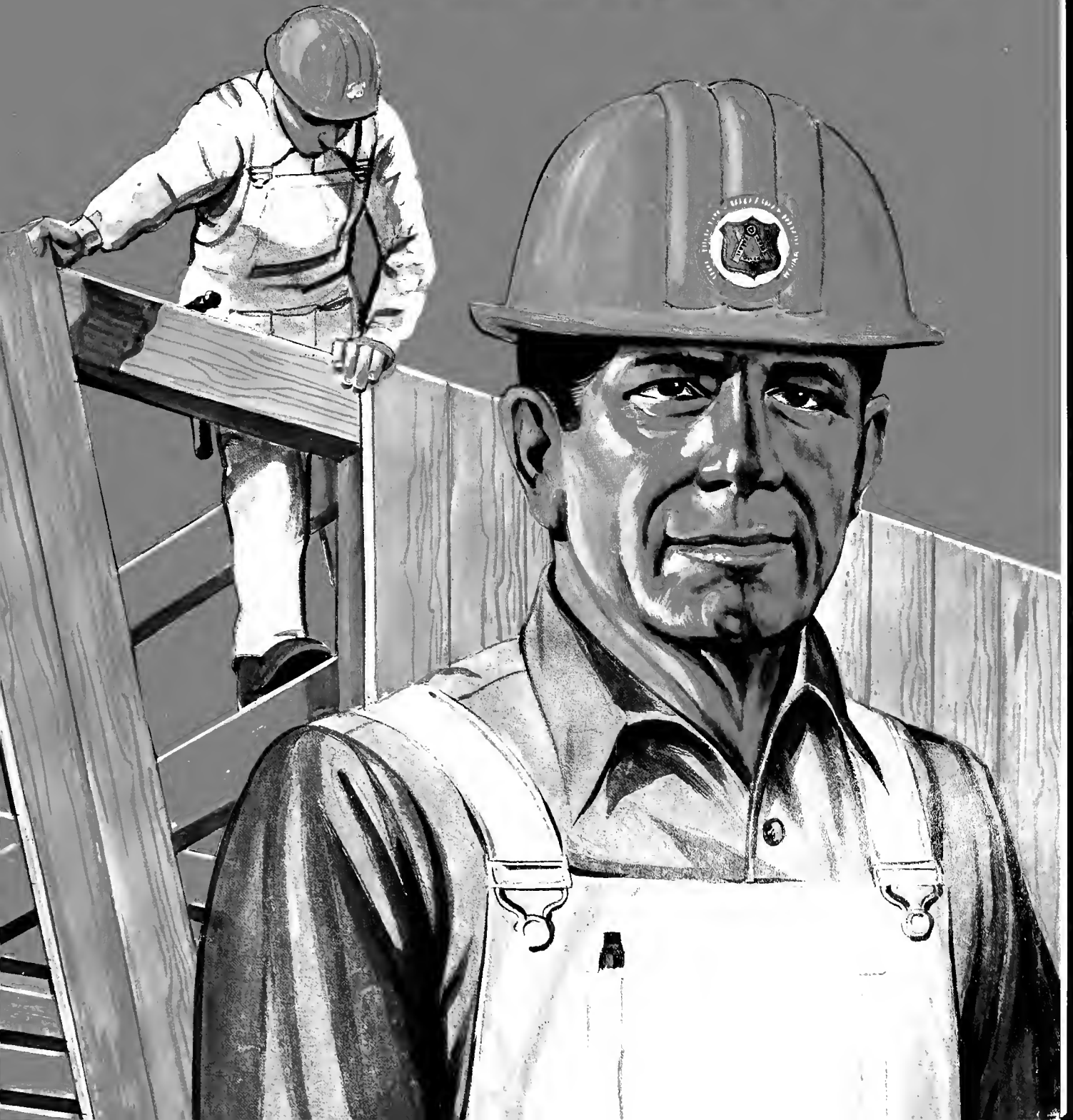

OFFICIAL INFORMATION

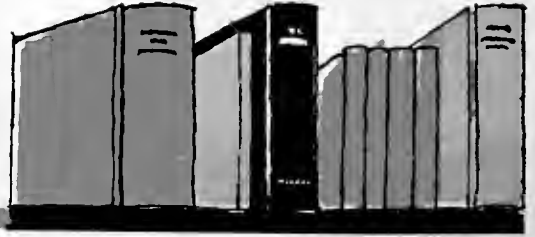

GENERAL OFFICERS OF THE UNITED BROTHERHOOD of CARPENTERS & JOINERS of AMERICA

GENERAL OFFICE:
101 Constitution Ave., N.W.,
Washington, D. C. 20001

GENERAL PRESIDENT

M. A. HUTCHESON
101 Constitution Ave., N.W.,
Washington, D. C. 20001

FIRST GENERAL VICE PRESIDENT

WILLIAM SIDELL
101 Constitution Ave., N.W.,
Washington, D. C. 20001

SECOND GENERAL VICE PRESIDENT

HERBERT C. SKINNER
101 Constitution Ave., N.W.,
Washington, D. C. 20001

GENERAL SECRETARY

R. E. LIVINGSTON
101 Constitution Ave., N.W.,
Washington, D. C. 20001

GENERAL TREASURER

PETER TERZICK
101 Constitution Ave., N.W.,
Washington, D. C. 20001

DISTRICT BOARD MEMBERS

First District, **PATRICK J. CAMPBELL**
130 North Main Street
New City, Rockland Co., New York
10956

Second District, **RALEIGH RAJOPPI**
2 Prospect Place, Springfield, New Jersey
07081

Third District, **WILLIAM KONYHA**
1830 Ledge Rd., R.D. No. 4
Medina, Ohio 44256

Fourth District, **HAROLD E. LEWIS**
340 Northwest 148th St.
Miami, Florida 33168

Fifth District, **LEON W. GREENE**
2800 Selkirk Drive
Burnsville, Minn. 55378

Sixth District, **FREDERICK N. BULL**
P.O. Box 14279
Oklahoma City, Okla. 73114

Seventh District, **LYLE J. HILLER**
Room 722, Oregon Nat'l Bldg.
610 S.W. Alder Street
Portland, Oregon 97205

Eighth District, **CHARLES E. NICHOLS**
Forum Building, 9th and K Streets
Sacramento, California 95814

Ninth District, **WILLIAM STEFANOVITCH**
2418 Central Avenue
Windsor, Ontario, Canada

Tenth District, **GEORGE BENGOUGH**
2528 E. 8th Ave., Vancouver 12, B. C.

M. A. HUTCHESON, *Chairman*

R. E. LIVINGSTON, *Secretary*

Correspondence for the General Executive Board
should be sent to the General Secretary.



Secretaries, Please Note

If your local union wishes to list deceased members in the "In Memoriam" page of *The Carpenter*, it is necessary that a specific request be directed to the editor.

In processing complaints, the only names which the financial secretary needs to send in are the names of members who are NOT receiving the magazine.

In sending in the names of members who are not getting the magazine, the new address forms mailed out with each monthly bill should be used. Please see that the Zip Code of the member is included. When a member clears out of one Local Union into another, his name is automatically dropped from the mail list of the Local Union he cleared out of. Therefore, the secretary of the Union into which he cleared should forward his name to the General Secretary for inclusion on the mail list. Do not forget the Zip Code number. Members who die or are suspended are automatically dropped from the mailing list of *The Carpenter*.

PLEASE KEEP *THE CARPENTER* ADVISED OF YOUR CHANGE OF ADDRESS

PLEASE NOTE: Filling out this coupon and mailing it to the *CARPENTER* only corrects your mailing address for the magazine. It does not advise your own local union of your address change. You must notify your local union by some other method.

This coupon should be mailed to *THE CARPENTER*,
101 Constitution Ave., N.W., Washington, D. C. 20001

NAME _____ Local No. _____

Number of your Local Union must be given. Otherwise, no action can be taken on your change of address.

NEW ADDRESS _____

City

State

ZIP Code

THE
CARPENTER

VOLUME XCI

No. 5

MAY, 1971

UNITED BROTHERHOOD OF CARPENTERS AND JOINERS OF AMERICA

Peter Terzick, Editor



I N T H I S I S S U E

NEWS AND FEATURES

Building Trades Legislative Conference	2
Millwrights-Ironworkers Rigging Agreement	6
Construction Industry Stabilization Committee Meets	8
Pressure-Treated Wood Foundations for Lower Cost Housing	10
Power From Nature's Boiler Room	14
Your Job Safety Law 'Rights'	16
Work in the Craft Shops of 1840	21
Economist Revises Earlier 1971 Construction Forecast	23

DEPARTMENTS

Washington Roundup	5
Canadian Report	Morden Lazarus 18
Service to the Brotherhood	24
Apprenticeship and Training	26
Your Union Dictionary	28
Editorials	29
Local Union News	30
Plane Gossip	33
Outdoor Meanderings	Fred Goetz 34
CLIC Report	36
In Memoriam	37
Lakeland News	39
In Conclusion	M. A. Hutcheson 40

THE COVER

We were thumbing through *The Carpenter* for May, 1931, recently, looking for information about the conditions which prompted passage of the Davis-Bacon Act, 40 years ago, and we were struck by the similarity between the problems of workers then and now.

Construction workers of 1931 were threatened with wage cuts in many parts of the country. Employer representatives in Washington, D.C., were trying to convince the Congress that they could continue to erect public buildings, only if labor costs were kept down.

In this situation, American Federation of Labor President William Green hit back at such statements with strong statements of his own. Said he: "Reduction in wages, forced by some employers, are delaying a return to prosperity. These reductions in wages have been favored and encouraged by a few bankers and some employers whose desire for standard profits has overcome their better judgment. If they are persisted in, a return to normal conditions will be delayed for two years or more."

In 1971 the construction worker is again under attack. Construction wage "stabilization" through government edict has become the policy of the Nixon Administration.

As we intend to show in the months ahead, the construction worker is more sinned against than sinner.



POSTMASTERS, ATTENTION: Change of address cards on Form 3579 should be sent to THE CARPENTER, Carpenters' Building, 101 Constitution Ave., N.W., Washington, D. C. 20001

Published monthly at 810 Rhode Island Ave., N.E., Washington, D. C. 20018, by the United Brotherhood of Carpenters and Joiners of America. Second class postage paid at Washington, D. C. Subscription price: United States and Canada \$2 per year, single copies 20¢ in advance.

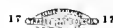

Printed in U. S. A.



AT LEFT: Newsreel cameramen cover the activities of the AFL-CIO Building and Construction Trades Legislative Conference. BELOW: General President M. A. Hutcheson, right, chats with Tom Murphy, president of the Bricklayers.



LEGISLATIVE CONFERENCE HITS WHITE HOUSE LABOR POLICY



■ Five thousand building trades leaders from all sections of the country looked to Congress for programs to pull the nation out of recession—and looked to the 1972 elections for an Administration that will place less emphasis on profits and stock prices and more on purchasing power for workers.

Delegates to the annual legislative conference of the AFL-CIO Building & Construction Trades Dept. gave warm applause, last month, to senators, congressmen and governors—Democrats and Republicans alike—who pledged support for labor's programs.

And they gave prolonged ovations to AFL-CIO Pres. George Meany and other speakers who denounced the White House for attempts to make "scapegoats" and "patsies" of organized labor, and served notice that Election Day of 1972 will be the time of reckoning.

The three-day legislative conference was followed by a day-long session on job safety and occupational health—focusing on the union role in implementing the new

laws passed by Congress.

It found delegates, nearly all of them local leaders of their unions, sharply resentful at the singling out of union building craftsmen for wage controls, while the prices of goods and services they must buy continue to rise.

In a keynote speech to the conference, Meany served notice that America's workers are "fed up" with the Administration's efforts to paper over its economic failures with "rosy rhetoric and Madison Avenue gimmickry."

To loud applause, he declared that labor "will not accept the role of scapegoat for the failures of this Administration. We will not be the patsies for these people."

He stressed the importance of the 1972 elections and emphasized that labor's political effectiveness depends on work at the local union level.

At the opening of the legislative conference, Frank Bonadio, secretary-treasurer of the Building & Construction Trades Dept., said the Administration's initial suspension of the Davis-Bacon Act and subsequent wage curbs had united the construction trades as never before.

"In hard times, we come together and work together for a common goal," he declared.

A key element of the conference was the lobbying on Capitol Hill as the thousands of delegates called on the congressmen and senators from their home states. They were armed with detailed explanations of major labor-supported bills and report forms to pass on the results of their interviews to the full-time trade union legislative representatives.

A number of congressional leaders made the trip the other way, coming from Capitol Hill to the vast ballroom of the Washington-Hilton Hotel, which turned out to be too small to accommodate the record attendance. ■

SPEAKERS AT THE BUILDING TRADES LEGISLATIVE CONFERENCE



GEORGE MEANY
President, AFL-CIO

The president of the AFL-CIO told the conference: "We get a lot of rhetoric these days, and a lot of gimmickry about what is going on. But we are very practical people. We deal with facts, not with fiction or fantasy.

"It is not a fantasy to say that in January of 1969, when a new Administration came here to Washington, that we were in the 95th month of economic progress, measured by every indicator used by government and private economists. We had a period of national economic expansion starting in March of 1961, and still continuing in January of 1969 when President Nixon came to office.

"At that time, there were 2.7 million people unemployed, 3.4 percent of the labor force. Not a perfect record, but the best record that we had for the previous 16 years.

"This record of economic advance very quickly turned around—and this is a fact, not fantasy—when the Nixon Administration set up its game—what they call its game plan—to combat inflation.

"What happened to the game plan?

"Today, 27 months after the Nixon Administration took office, we have continuing high unemployment and continuing rising prices."



CARL D. PERKINS
Chairman, House Labor Committee

Congressman Perkins criticized the Administration's lack of a "sense of urgency" in seeking funds to administer and enforce the Occupational Safety & Health Act.

He told delegates: "The Occupational Health and Safety Act was enacted last year, it remains to be seen whether the Administration will administer that Act with the zeal and dedication which the Congress, at the time of the enactment, hoped for. I wish I could say that I was optimistic on that point, but I must confess that at this time I have not detected a sense of urgency on the part of the Administration, which I would have hoped would characterize their actions under the Health and Safety legislation.

"I make that statement because there were no funds in the supplemental appropriation that recently went through the House to put this great program into operation."

He told delegates also: "It remains apparent that the Administration is inclined to try to hold down wages as a means of fighting inflation, while displaying considerably less interest in profits and incomes of those other than America's working men and women."

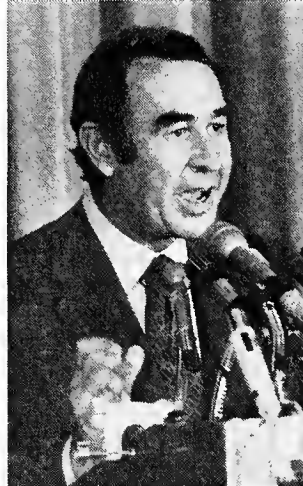

H. WILLIAMS, JR.
Chairman, Senate Labor Committee

Senator Williams promised to move key union-supported bills quickly through his committee but stressed the need for union members to press their senators and congressmen to vote for them, and the President to sign them into law.

"We have much legislation that is necessary for individual Americans and to all of you and all the people you represent as workers," he said.

"Much of it is before the committee I have the honor to be chairman of, Labor and Public Welfare.

"We have narcotics legislation. We have a great deal of labor legislation, including a pension bill to protect the workers pension benefits.

"We have more than enough votes on that committee to pass legislation to deal with the problem, but the legislation has to pass the whole Senate, has to go through the House and it must be signed by the President.

"That is where we need your help. You must see to it that all of this legislation is approved by each of your two Senators of whatever state you are from, by your Congressmen, and most importantly that the President knows where you stand, too."



HENRY M. JACKSON
Washington Senator

Senator Jackson lashed out at the Nixon Administration's domestic record. No previous Republican administration has "made such a mess of economic planning," he charged. Jackson called on the Administration to unfreeze the \$12 billion in appropriated government funds as a first step to getting the economy moving and providing jobs.

He told delegates: "For over two years now, I have been warning of the economic policies of this Administration. I pointed out two years ago that it was one thing to turn the spigot off—that is, by jacking up interest rates and shutting off credit—and another thing to turn the spigot on again and expecting something to come out.

"And we have witnessed exactly that. The Administration knew full well how to turn the spigot off, and they turned it off.

"They have turned the spigot open, but nothing is happening. Do you know why?

"The reason is that there is a crisis of confidence in this country over the policies, the economic policies of the present Administration. And I don't say that in any partisan sense," the Washington State legislator told the conference delegates.



JOHN V. TUNNEY
California Senator

Senator Tunney charged the President and his aides with playing politics with unemployment. "They have tried to blame the sad state of the American economy on everyone but themselves, where the blame belongs.

"President Nixon is going to find that the economic difficulties in this country weren't created by the working men and women who just want a job, want some take home pay, want some bread and butter on the table, but by the economic royalists surrounding this White House, who have programmed a recession."

Later, he said, "I am referring specifically, when I talk about leadership, to those economists who are surrounding the White House, who have such insensitivity that they are perfectly willing, on a hit and go basis, to tighten up the money supply first, create a recession, create massive unemployment and then loosen up spending and say, look how good we are.

"In 1969, when President Nixon took office, the unemployment rate was less than four percent. Today, it stands at six percent, a total of more than five million Americans out of jobs . . . Apparently there isn't anyone in a position of power in this Administration who had any concept of the human suffering within these figures."



HALE BOGGS
House Majority Leader

Congressman Boggs said Congress will not stand still for the continued refusal of the President to spend funds. Congress has appropriated for urgently needed programs including public works and housing.

He predicted that Congress will pass key bills on labor's priority list "and send them to the President. We would hope that he would sign them, but if he doesn't we will try in every case to override those vetoes."

"As Majority Leader of the House of Representatives, with the responsibility for the legislative program, let me spell out what we propose to do.

"Number one, we propose to increase the minimum wage from \$1.60 to \$2.00 an hour immediately.

"No. 2, we propose to tie a cost of living formula to social security payments.

"No. 3, we hope to put into effect as soon as possible the tax reduction schedule to go into effect in 1972 and 1973 by way of increased deductions for dependents and increasing the standard deduction.

"We propose—and this is very vital to you people in the construction industry dependent upon construction for your jobs—to pass an act of Congress if necessary to require the President of the United States to spend the money that we have already appropriated."



R. S. SCHWEIKER
Pennsylvania Senator

Senator Schweiker, a Pennsylvania Republican, said the public service jobs will be enacted, even if it is necessary to override a presidential veto. He has broken with the Administration before, he reminded the delegates, to support labor's position on "the big votes that counted," including the rejection of the Haynsworth and Carswell nominations to the Supreme Court.

He discussed the need for pension legislation: "We need to overhaul the private pension programs. It is high time that we in Congress did something about private pensions. The way things are now, only a handful of working men and women ever get a penny out of their pensions. Even though there are \$130 billion set aside in the private pensions nationwide.

"Actually about 20 percent, and only 20 percent, collect the money that they have paid in on their pension plan. Now that is pretty sad commentary on our situation. And a pretty poor setup for even a capitalistic society to point to about taking care of the people who invest as workers and who invest their savings and then get no reward at the end of their useful careers.

"That is something that this Congress is going to change, too."



N. ROCKEFELLER
Governor, New York

Governor Rockefeller received a warm reception despite his endorsement of general revenue-sharing without federal earmarking. But the governor made clear that he just as strongly supports direct federal grant programs, including "massive federal aid to education" and federal payment of all welfare costs.

"We have supported revenue sharing. I know your position on revenue sharing. But all I say is you men are interested in the cities. That is your base. I am interested in the cities because that is the strength of our states. We have run to the end of our capacity to help those cities meet their needs.

"Washington has got to assume a larger share of responsibility for the meeting of local needs, The fundamental services. Police, fire, sanitation, and the educational costs. These are the basics. These are not recognized by the Federal Government as being their responsibility.

"But if you do what we did as a progressive state, we raised our income tax. We are now up to 14 percent progressive income tax. Our neighbors? They have no tax at all. So why not move across the border? Save the money. This is the problem.

"We are vulcanizing America by the tax structures of our states."

WASHINGTON ROUNDUP

JOBLESS RATE—The jobless rate in poverty neighborhoods of the 100 largest metropolitan areas has been unchanged for the past six months, indicating that it is leveling out but still at the high rate of nine percent.

First quarter figures of the U.S. Department of Labor show the first time since January-March 1970 that unemployment in the poverty areas has not risen. A factor in the picture was the drop in population and labor force in these areas. Over the past year some 200,000 persons have moved out of poverty neighborhoods.

FUNDS TO THE STATES—State employment agencies have been given \$10,000,000 by the Federal Government to improve their services, including doing some employing of their own. The money will be spent to upgrade 2,000 present employees and to hire and train 1,000 unemployed workers.

QUOTABLE QUOTE—"President Nixon apparently has decided to single out the construction industry as his pressure point to try to curb inflationary trends in the national economy.

"This decision is discriminatory on its face, as would be any attempt to blame an inflated economy on one particular industry and its workers. The economy is too large and too complex for such simple scapegoating."—Senator Lee Metcalf (D-Mont.)

'MISERABLE FAILURE' President Nixon's economic plan since he took office has been "a complete, absolute, miserable failure--there's no other judgment you can put on it," AFL-CIO President George Meany charged in addressing the Utility Workers' convention.

Meany took the delegates back through two years of history—to the period when the Nixon Administration took office and the President wrote the AFL-CIO Executive Council, in February 1969, that he was going to bring down prices "without making the worker pay for it" by increased unemployment.

So what happened? Meany asked. "They cooled off the economy all right. They restricted credit and, within two years, we had 2,200,000 more people unemployed than we had in January 1969."

MARITIME COOPERATION—Maritime management and labor have been urged to join forces in an effort to maintain the stability and maximum operating capacity of the existing American Merchant Marine until the benefits of the Merchant Marine Act of 1970 are realized.

Rep. Edward A. Garmatz (D.-Md.), Chairman of the House Merchant Marine and Fisheries Committee warned at a luncheon sponsored by the AFL-CIO Maritime Trades Department that "it will be a long time—perhaps as much as three years" before the first new ships contemplated by the Act are ready for service.

'INFLATION ALERTS'—President Nixon's "inflation alerts," which more and more are being used to hit at unions rather than profits, are drawing bitter resentment and defiance from organized labor.

Top officials, including AFL-CIO President George Meany, have made it clear that the labor movement does not intend to be intimidated and it will continue its fight for wage contracts that answer the needs of workers, themselves the victims of inflation rather than the beneficiaries.



General President M. A. Hutcheson speaks to the joint meeting of representatives assembled in Washington, April 17, with regard to Millwright participation in the agreement.



Ironworkers' General President John H. Lyons addresses the April 17 gathering, discussing understandings reached by the historic pact.

Master Agreement Defines Millwright, Ironworker Rigging Jurisdictions

Leaders of both unions meet at General Headquarters; historic pact goes into effect this month.

■ Millwrights and Ironworkers employed in the rigging of machinery and equipment on building and construction projects have struggled with problems of work jurisdiction for years.

The nature of their respective skills has made it difficult, up until now, to define the work boundaries involved.

A new and historic agreement just signed between the Brotherhood and the International Assn. of Bridge, Structural, and Ornamental Iron Workers, which went into effect May 1, 1971, is expected to change all that.

"It is the purpose of the agreement to improve relations between our two international unions, to settle jurisdictional disputes directly between the two trades, and mutually to assist each union in securing work coming within the recognized jurisdiction," states General President M. A. Hutcheson in a special letter to all construction locals and

districts, state and provincial councils.

Henceforth, all contractors will be required to make assignments between millwrights and ironworkers on rigging in accordance with the terms of the new agreement.

Many of the work procedures covered by the agreement were previously covered by drafts of understandings and job decisions of the National Joint Board for the Settlement of Jurisdictional Disputes and the Appeals Board. The new agreement will supersede any local or area understandings.

The pact was developed through a series of meetings between committees of the respective unions. It was approved and signed at sessions in Bal Harbour, Fla., in February. A meeting of representatives concerned with Millwright and Ironworker assignments met April 17 at General Headquarters to prepare for application of the agreement, beginning this month. ■

Agreement

This Agreement shall become effective May 1, 1971, and is in accord with the action of the National Joint Board for the Settlement of Jurisdictional Disputes at its meeting of July 8-9, 1970, in having invoked Article 3, Section 5 of the Plan for the Settling of Jurisdictional Disputes Nationally and Locally.

Pursuant to these procedures, designated committees of the respective General Presidents met in committee and developed the following Agreement, thereby eliminating the necessity of the matter being referred to the Impartial Umpire and a National Hearings Panel.

Contractors, in accordance with the procedural rules of the National Joint Board for the Settlement of Jurisdictional Disputes, shall make all assignments between Millwrights and Iron Workers over rigging in connection with the installation of machinery and/or equipment on building and construction projects in accordance with the provisions as set forth in this Agreement.

Further, on all work currently in progress on the effective date of this Agreement, application of its provisions shall be extended to enable an orderly implementation by responsible contractors to conform to its provisions, not exceeding thirty (30) days or June 1, 1971.

The purpose and intent of this Agree-

ment is to improve relations between the two crafts, eliminate jurisdictional disputes which may arise and to mutually assist each other in the securing of work coming within their recognized jurisdiction, which shall contribute to the development of procedures in the best interest of the Industry.

ARTICLE 1

Package Machinery and/or Package Equipment

(a) The unloading of package machinery and/or package equipment and the transporting of same by any means from the point of unloading or from a storage area to the point of final installation, or to a temporary holding point in the area of final installation, as designated by the responsible contractor, shall be the work of the Iron Workers. The temporary holding point, as distinguished from a storage area, shall be as near to the foundation as job conditions or required work-

ing space will permit, with the responsible contractor to be the final judge.

(b) After the package machinery or package equipment has been brought from the point of unloading or from the storage area to the point of final installation or to a temporary holding point as outlined in Paragraph (a) above, all further moving and handling by any means required to complete the installation shall be the work of the Millwrights.

ARTICLE 2

Knock Down or Dismantled Machinery and/or Equipment Found in Light Industrial Plants

(a) The unloading of components of knocked down or dismantled machinery and/or equipment and the transporting of same by any means from the point of unloading or from storage areas to an assembly area designated by the responsible contractor, or if direct installation can be made, to the point of final instal-

lation, shall be the work of the Iron Workers.

No arbitrary limitation shall be placed on the assembly area, but it shall be as reasonably close to the foundation on which the installation is being made as job conditions or required working space will, in the judgment of the responsible contractor permit.

(b) After the components have been brought to the designated assembly area, or to the point of installation as outlined in Paragraph (a) of this section, all further rigging by any means required during the cleaning, turning, fitting and assembling of the components, and to make the final installation, shall be the work of the Millwrights.

ARTICLE 3

Machinery and/or Equipment Found in Heavy Industrial Plants

(a) The unloading and transporting of machinery and/or equipment to a tempo-

Continued on Page 22



Participants in the signing of the Brotherhood-Ironworkers agreement at Bal Harbour, Fla., in February were, from left around the table: Ironworkers' 6th Gen'l VP John F. Walsh, Brotherhood GEB Member Charles Nichols, Brotherhood Gen'l Rep. Robert Laing, Ironworkers' Gen'l Org. Wayne Mahurin, Ironworkers' 3rd Gen'l VP Robert V. Poole, Ironworkers' Gen'l Sec. Juel D. Drake, Ironworkers' 1st Gen'l VP John L. McCarthy, Ironworkers' Gen'l Pres. John H. Lyons, Brotherhood Gen'l Pres. M. A. Hutcheson, Brotherhood's 1st Gen'l VP William Sidell, Assistant to the Brotherhood's Gen'l Pres. Jimmy Jones, Brotherhood GEB Member Raleigh Rajoppi, Ironworkers' 9th Gen'l VP Dale Ray, Brotherhood GEB Member Patrick Campbell, and Ironworkers' Exec. Ass't to the Pres. Bob McVay.

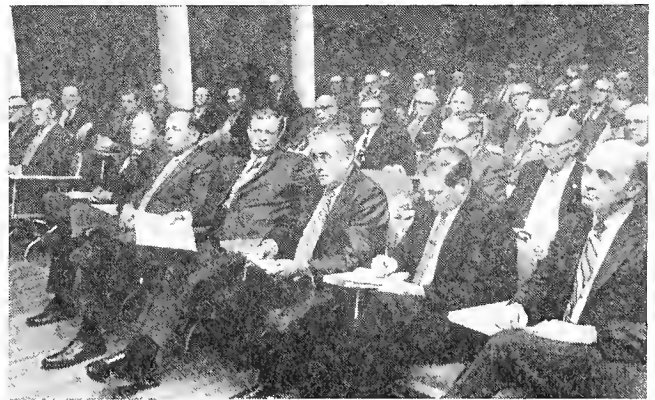

Two views of participants in the April 17 discussions between Millwrights, Ironworkers, and their international officers.



The first gathering of the Construction Wage Survey and Stabilization Committee, held at the Labor Department in Washington, D.C. First General Vice President Sidell is seated sixth from left at the far side of the table.

Wage Stabilization Group Begins Work in Washington

First General Vice President Sidell Participates in Deliberations

■ Late last month, the craft board which will have responsibility for scrutinizing wage increases in the craft of carpentry was set up. The board will be made up of representatives of the Associated General Contractors, the Ceiling and Interior Systems Contractors Association, the Gypsum Drywall Contractors International, International Association of Wall and Ceiling Contractors, National Association of Home Builders, National Constructors Association, and National Council of Erectors and Riggers, together with representatives of the United Brotherhood of Carpenters and Joiners of America.

The board will probably begin functioning even before this issue of the magazine goes to press.

Under the plan devised by President Nixon's Executive Order, each craft in the building trades is required to have a board of its own to examine contracts negotiated after March 29, 1970, to see whether or not the wage increases contained therein meet the formula established by the President's Executive Order.

Roughly, the formula is that the wage patterns established in the years 1961-69 should not be exceeded in current negotiations.

Final authority for determining the appropriateness of any negotiated wage increases will rest with the Wage Sta-

bilization Commission, which is composed of representatives from labor, management, and the general public.

Named to represent the labor side of the tripartite committee were President Charles H. Pillard, IBEW; President Hunter P. Wharton, Operating Engineers; President S. Frank Raftery, Painters; and John H. Lyons, Iron Workers. Named as alternates for labor were First Vice President William Sidell, Carpenters; and Acting President Martin J. Ward, Plumbers and Pipefitters.

Officially named the Construction Industry Stabilization Committee, it has held several meetings. It has already issued its first wage increase approval: a contract between the North Texas Contractors Assn. and the Ironworkers of the Dallas-Fort Worth area.



John T. Dunlop, chairman of the committee and liaison man between the White House and the Building Trades. (PAI)

The committee approved a first 30¢ an hour installment but deferred approval on the rest of the agreement, subject to future review by an appropriate craft board.

In addition to the carpentry board, four other craft boards have been named to date. They are as follows:

- *Council on Industrial Relations for the Electrical Contracting Industry:* The International Brotherhood of Electrical Workers and the National Electrical Contractors Association.

- *Labor Relations Adjustment Board:* The Sheet Metal and Air Conditioning Contractors' National Association and the Sheet Metal Workers' International Association.

- *Piping Industry Wage Stabilization Board:* The National Association of Plumbing, Heating and Cooling Contractors, the Mechanical Contractors Association of America and the National Constructors Association and the United Association of Journeymen and Apprentices of the Plumbing and Pipe Fitting Industry.

- *Masonry Industry Crafts Disputes Board:* Bricklayers, Masons and Plasterers International Union of America; International Association of Tile, Marble and Terrazzo Helpers; the Associated General Contractors of America; Mason Contractors Association of America, Inc.; Tile Contractors Association of America, Inc., and with affiliated representation from the National Association of Home Builders.

Whatever you saw, see Rockwell.

Aluminum.
Oak.
Masonite.
Pine.

A pro runs into a lot of different things on the job. Rockwell can handle them all. We have more ways to saw than anyone else.

Portable Saws

Rockwell's 14 portable circular saws give you a choice in the size, speed, power, special features and price you want: 8" to 12" extra heavy-duty saws, 4½" trim to 10¼" heavy-duty models, 6¾" and 7½" high-torque worm drive saws.

They have parts that are easy to replace at high wear points, ball bearing construction and failure-protected motors. Some have unique features like Rockwell's exclusive external gear lubricator. All have the feel and balance a pro can really appreciate.

Table Saws

Rockwell Delta has many table saws to choose from, for in shop or on site use. For example: Rockwell tilting arbor bench saws have big capacity, extra large table surface, adjustable positive stops. All controls are grouped right up front.

The Rockwell radial saws have famous double overarm action for greater left hand miter capacity. And up-front controls.

Whatever you saw, see the tool for the job at your Rockwell distributor. He's listed under "Tools Electric" in the Yellow Pages.

Free Catalogs

Or write for our catalog: Rockwell Manufacturing Company, 654 N.

Lexington Avenue, Pittsburgh, Pennsylvania 15208.



Rockwell Power Tools

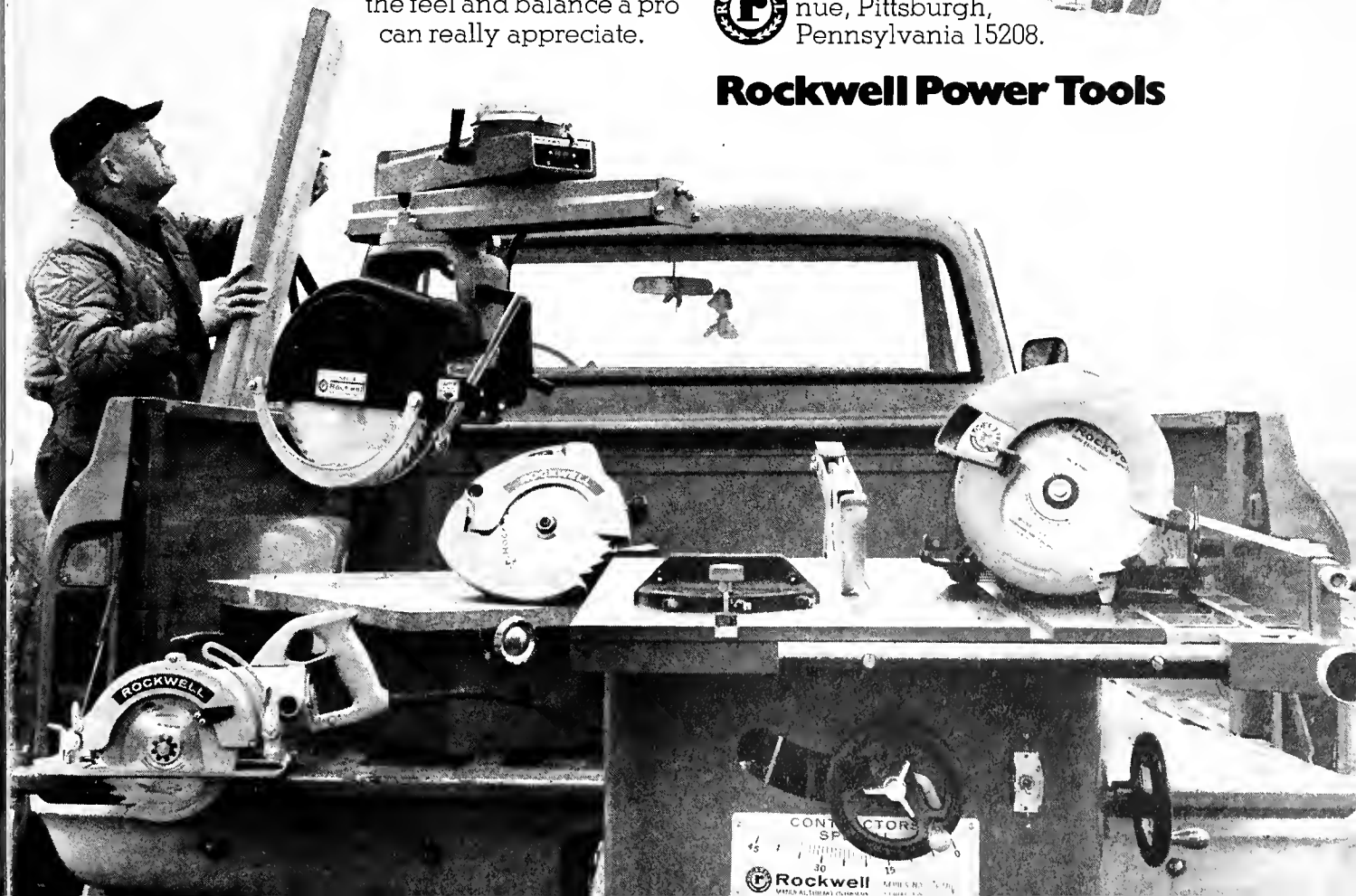

PRESSURE-TREATED WOOD FOUNDATIONS FOR LOWER COST HOUSING

■ The advantages of pressure-treated wood for house foundations, instead of conventional concrete or mortar masonry, are getting close scrutiny from builders and from modular housing firms.

Wood foundation units can be placed in almost any weather, it is pointed out, eliminating shipping and scheduling delays associated with masonry foundations.

Wood foundations offer a warmer, more comfortable basement space, say their advocates. Basements are



ABOVE: Workmen place a modular housing unit on a pressure-treated wood foundation. Such foundations can be site erected in about two hours, while a masonry block foundation wall takes 7 to 8 times as long.



ABOVE: The mark of the American Wood Preservers Institute can be seen in the foundation wood.



BELOW: The excavation is trenched for piping prior to placing gravel fill.

easier and less costly to finish, because paneling or drywall can be nailed directly to stud walls without adding furring.

Studies by the National Association of Home Builders Research Foundation show that treated wood foundations cost less, too.

The whole scope of wood foundation usage is discussed in the March, 1971, issue of *Wood Preserving*, official publication of the American Wood Preservers Institute. AWPI has taken a strong interest in the

subject and supplied the accompanying pictures of a construction project in Arlington, Virginia.

Design criteria and specifications have been published by the National Forest Products Assn., and design departments using these can prepare detailed drawings and specifications for a given project. Federal Housing Administration Notice 70-45, sent to regional field offices in April, 1970, allows builders to use the system under any of their regular home mortgage insurance programs.

Plywood sheathed walls act like large structural diaphragms, and field installations studied indicate that foundation walls do not crack or become damaged by setting modules on them during back-filling, as sometimes occur with masonry block walls.

AWPI indicates that there is no problem in obtaining properly treated materials for such construction from local lumber yards.

Stud walls are easily framed and erected. Plastic 4-mil-thick poly-

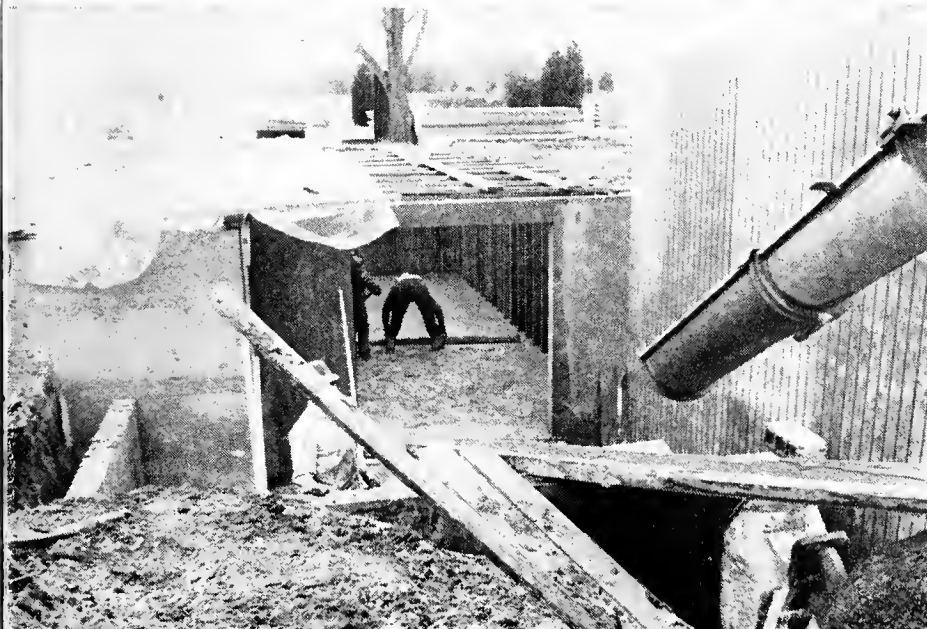

UPPER LEFT: Excavation for a pressure-treated wood foundation system uses the same methods and equipment as for conventional systems.

UPPER RIGHT: Pressure-treated wood footing plates are placed directly on a fill of finely crushed stone, pea gravel, and coarse sand. Concrete footings are not used with this system.

LEFT: A concrete basement floor goes in, abutting the pressure-treated wood foundation.

PRESSURE-TREATED WOOD

ethylene film is adhered with "Flint-kote" 746 adhesive to the outside surface or the basement foundation walls below grade for water proofing. Above grade, the foundation outside surface can be stained or

left to weather unfinished. It can be painted or battens can be added for decorative appearance. Even a stucco or cement plaster finish can be used. For a stucco finish, the treated plywood is first covered with building paper, then 3.40 lbs. per square yard of galvanized self-furring metal lath and edge casing beads are nailed over the building paper. Then cement plaster is troweled onto the lath. This method of exterior surface treatment provides fire protection economically between adjacent

townhouse living units.

Anchoring building modules to treated wood foundations appears to be faster and more effective with treated wood foundations than with conventional foundations because of readily-available galvanized steel framing anchors and nails. Placing the concrete basement floor prior to setting above-ground modules on the treated wood walls prevents moisture leaving the curing concrete from moving into the finished modular units above. ■

RIGHT: A view of the wood foundation system, showing the sump, sanitary waste and water supply lines extending above the fill.



BELOW: Workers move a pressure-treated foundation wall into position atop footing plates, which are aligned on crushed-stone footings.



PUBLICATIONS AVAILABLE

Those interested in further information on this subject can write:

WOOD PRESERVING
2600 Virginia Avenue, N.W.
Washington, D. C. 20037

for the following publications:

All-Weather
Pressure-Treated
Wood Foundation

NEPA Technical Report No. 7

The latter report discusses design and construction requirements for all All-Weather Wood Foundation System.



The totally tougher truck.

(built to lead a hard life so yours can be easier.)

We've got more power.

Nobody can top Chevy's available V8 power. Up to 400 cu. in. strong. They don't come any bigger than Chevy's standard 250 Six, on half-ton models, either. Three other available engines, besides, for you to choose among. They all get along just great on regular, or new no-lead or low-lead gasolines.

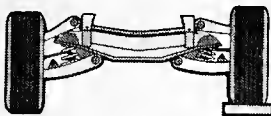
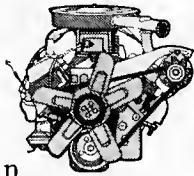

Super Suspension, for the smoothest ride in trucks.

It's fully independent up front with big coil springs to keep road shock from passing back and forth between the wheels. Or up to the cab and box. In the rear, coil or leaf springs are available—tailored to the loads you carry. So you ride smooth, even when the road isn't. Super Suspension: better because Chevy's built more of its kind. Over a million and a half more than anybody else!

Cheyenne. Your car should look so good.

It's our new top-of-the-line pickup. Cheyenne offers a deep foam-cushioned bench seat in deluxe vinyl. Carpeting. Other niceties inside. Special touches outside. Bucket seats and console available, too.

Cheyenne has comforts that cars thought belonged to them, and other trucks never even thought of.

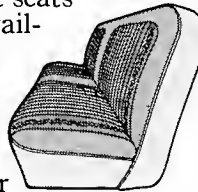

Durable front disc brakes.

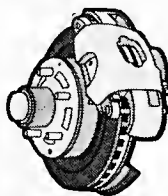

They're standard on Chevrolets. But not on most other pickups. You get resistance to fade, improved brake life. Even with big loads. In heavy use. Despite rain, snow, dust. Power assist is standard, too, on ¾- and 1-ton models. And new finned rear brakes on ½-ton models complete Chevy's advanced brake system.

When we say double-wall, we mean it.

We double-wall our wide Fleetside cargo box sides top to bottom, not halfway like some pickups. So dings inside don't show outside. Our cab roof, cowl, body sills and rear wall panels are two walls of steel, too, with insulation wherever it's needed in between.

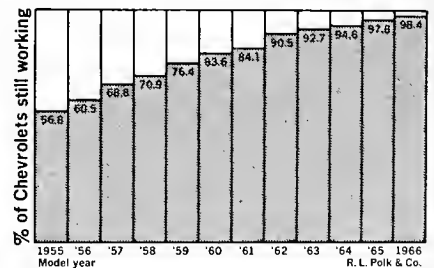
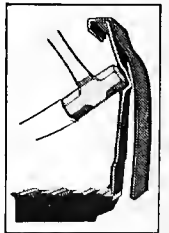

Chevy trucks work longer.

Official figures, based on latest R. L. Polk & Co. statistics, show how Chevrolets outlast other trucks. Going back as far as 1955, for example, over 56% of the Chevrolets of that model year are still on the job. No competitive make has as many as half of its '55 models still working.



Power from Nature's Boiler Room

Pollution Prods Efforts to Harness Earth's Heat

Engineers study the pressure and temperature of this geothermal steam well at The Geysers Power Plant in Sonoma County, California. Wells to produce steam for the plant have been drilled to a depth of more than a mile and a half.

■ More homes and factories in the future will draw pollution-free electric power from the heat of the Earth.

In Italy, Iceland, Japan, New Zealand, the Soviet Union, and the United States wells down to 8,000 feet already tap superheated water that bursts free as steam to spin turbines in generator plants.

The Geothermal Steam Act signed by President Nixon early this year opened 1,350,000 acres of government land in the American West to exploration and leasing for new government power projects.

As utility companies seek to boost output while reducing pollution from conventional power stations, new ways of extracting the underground energy are being sought.

One plan calls for detonating nu-



clear bombs more than two miles below the surface to create "chimneys" through hot, dry rock, the National Geographic Society says.

Water would be piped down to this natural boiler, recovered as steam to drive electric generators, then returned to be reheated in a recycling process. The plan is being studied by the Atomic Energy Commission.

Present geothermal power plants—and one being built in Mexico—use natural steam from water trapped in porous sand above subterranean rock heated by molten magma at the Earth's core.

Scientists estimate some 168,000,000 cubic miles of heated water lie beneath the Earth's surface. But the water can be reached only where thin spots and other anomalies in the crust allow it to rise relatively

close to the surface, sometimes spouting as geysers.

At The Geysers, an area 90 miles north of San Francisco, wells daily produce enough electricity for a city of 90,000.

Near the Mexican border, geologists believe the Imperial Valley may be a 2,000-square-mile geothermal field where wells could provide electricity and drinking water for all of southern California.

But drilling a well can cost \$250,000—and prove fruitless. If the water is too salty, the high mineral content means its steam can damage turbines even though corrosion-resistant materials are used and the brine and steam are separated.

A successful well must deliver steam at a constant pressure and temperature for decades. Some geothermal wells have shown slowly

dropping pressures and cooler temperatures within eight years.

The proposed recycling method would not depend on underground water supplies for steam. And hot, dry rock is accessible in more locations than natural steam.

Italy pioneered geothermal power in 1904, and generators at Larderello are still in operation. The Geysers plant has been furnishing electricity since 1960; Japan and the Soviet Union started operating geothermal plants in 1965.

Geothermal heat does more than drive generators. Homes in Iceland have been warmed by natural steam for more than 40 years.

Thermal wells in New Zealand provide steam to make pulp at a paper mill, heat greenhouses on farms, kiln-dry lumber, mold plastics, and steam-clean cars. ■

Hot magma, molten rock, heats layer of solid rock above it. Water trapped in next layer, porous rock, boils into steam. Steam escapes through a fumarole (a natural vent) or through man-made drill hole. A wellhead caps the drill hole and leads steam to generating plant.

These are Units 1 and 2 of The Geysers Power Plant. The plant is located about 90 miles north of San Francisco. These two units went into commercial operation in 1960 and 1963 respectively. On the knoll, upper left center, are Units 3 and 4. These latter two units went into operation in 1967 and 1968. Total capacity of the four units is 82,000 kilowatts. The plant is operated by the Pacific Gas and Electric Company.

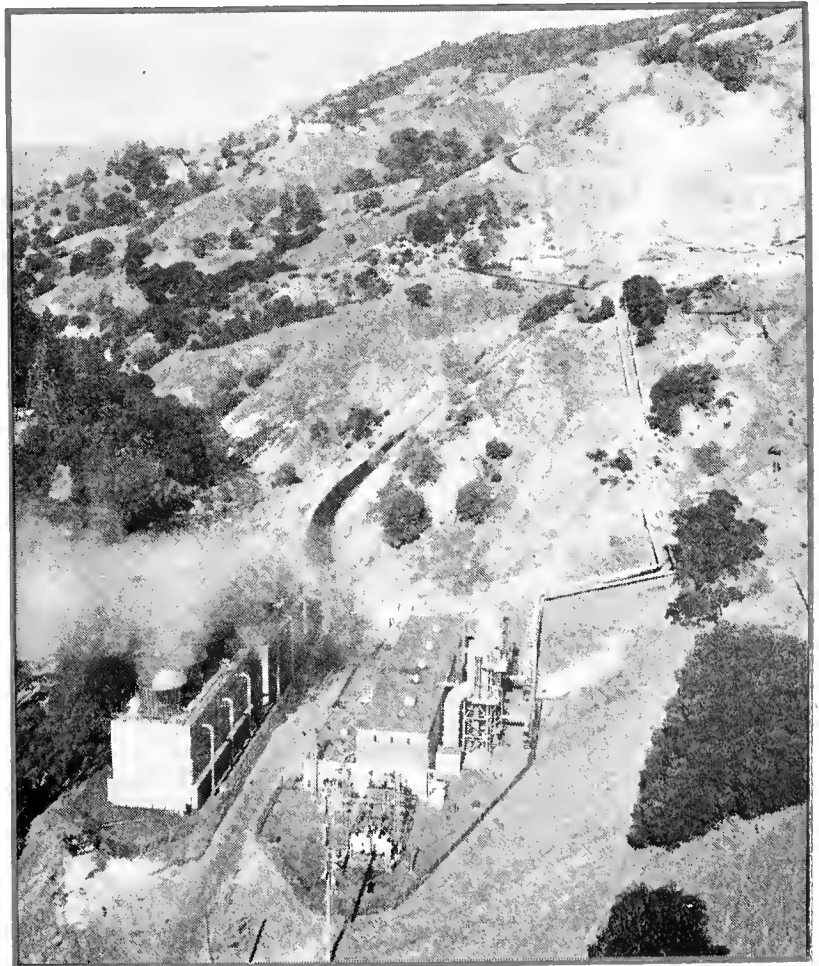
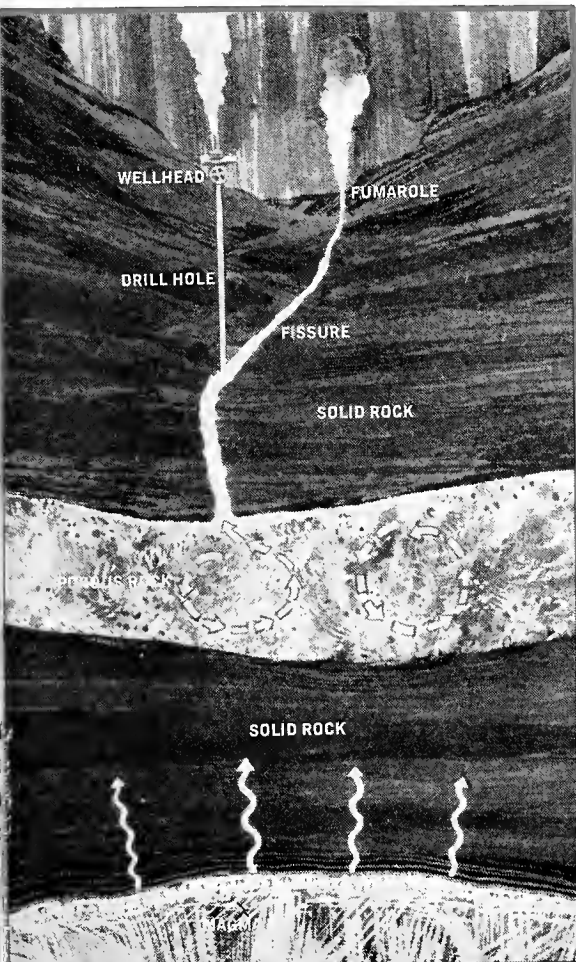

**YOU GET MORE
OUT OF THEM
'CAUSE
VAUGHAN
PUTS MORE
INTO THEM!**

...AND HAS FOR
MORE THAN
100 YEARS



999

A 25 oz.
heavy duty
beauty. Large
striking face,
11" or 12"
top grade
hickory
handles.
Plain or
milled face.



FIBERGLASS

Exclusive hollow core
design adds greatest
strength, better
balance, absorbs
more shock.
13 to 20 oz.
sizes, nail
and rip.



**RIG
BUILDER'S
HATCHET**

Polished 22 oz.
striking head with
flat milled face.
Special 17"
hand
comfort
handle.



SUPER BAR

15" all
purpose pry bar.
A must for every
tool box.

Request catalog illustrating
complete line of striking
tools and pry bars.



**VAUGHAN & BUSHNELL
MFG. CO.**

11414 MAPLE AVE., HEBRON, ILL. 60034



Your Job Safety Law 'Rights'

The new Occupational Health and Safety law, which goes into effect April 28, has at least 16 "rights" for American workers covered by the legislation. They include:

1. The right to have dangerous substances identified by labelling or posting in the workplace (sec. 6b (7)), sec. 8c (1)).
2. The right to have health and safety inspections made on the job (sec. 8f (1)).
3. The right to accompany inspectors when they inspect your job (sec. 8e).
4. The right to have copies of inspection reports and complaints (sec. 8c (3)).
5. The right to have records made and kept of your exposure to dangerous substances (sec. 8c (3)).
6. The right of access to records of your exposure to dangerous substances (sec. 8c (3)).
7. The right to have HEW monitor dangerous substances on your job (sec. 20a (5)).
8. The right to have violations found by HEW inspectors posted in the plant (sec. 9b).
9. The right to have public transcripts made of advisory committee meetings (sec. 7a (2)).
10. The right to have extremely accurate records made of injuries and job-related diseases (sec. 8c (2)).
11. The right to have the HEW secretary set exposure levels for dangerous substances so that no worker suffers impaired health or diminished life expectancy (sec. 20a (3)).
12. The right to see published an annual list of toxic substances with safe exposure criteria (sec. 20a (6)).
13. The right to see published annually studies of the long-term effect of low-level exposures to industrial materials (sec. 20a (7)).
14. The right to be protected in all rights under this law (sec. 11c (1)).
15. The right to sue the Federal Government for an imminent danger cause (sec. 13d).
16. The right to know the health and safety gap each year (sec. 26).

Many union officials are suggesting that these "rights" be posted on bulletin boards so that union members can become acquainted with them.

ATLANTA



UNION ATLANTA CIVIC CENTER, Atlanta, Georgia
INDUSTRIES MAY 14 thru 19 • 1 p.m. to 10:30 p.m. daily





CANADIAN REPORT

No-Fault Auto Insurance Gains Support; Saskatchewan, Manitoba in Early Lead

The trade union movement has a pretty good record for standing up for progressive legislative measures, and as time goes by more and more of these measures are being enacted.

One of these is compulsory car insurance under government sponsorship.

In 1966 the trade unions across Canada through the Canadian Labor Congress and the Federation campaigned for an automobile compensation plan which would provide no-fault insurance for every motorist.

One province in Canada has had such a plan in operation for over 20 years. Saskatchewan's plan introduced by the old CCF government under Tommy Douglas provided the average motorist with better coverage at lower cost than any other plan in Canada.

As a matter of fact the foremost consumers' publication, *Consumers Reports*, rated it the best on the continent.

Now another labor-backed government has announced the details of an auto insurance plan which puts it steps ahead of even the Saskatchewan plan.

Manitoba's Premier Ed Schreyer has unveiled a comprehensive scheme which must surely be the most advanced of any so far available.

It will also save motorists 15 percent on premium payments in the first year of operation. The saving may go as high as 20 to 30 percent after that.

The plan to come into effect November 1st will provide \$50,000 third party liability, \$200 deductible all peril, death benefits up to \$10,000, benefits up to \$6,000 for dismemberment or impairment, medical benefits up to \$2,000—all regardless of fault in an accident.

The medical benefits are on top of the provincial hospital and medicare programs already in effect.

In addition the plan will provide lifetime disability payments up to \$50 a week.

The government plan will also provide additional coverage as an option \$50 or \$100 deductible all peril, and third party liability up to \$100,000 or \$200,000.

The Manitoba Federation of Labor has been urging such a plan for some time and is backing the government to the full.

Naturally the insurance companies have opposed it vigorously, claiming that the government is destroying an important industry and the jobs that go with it.

The government has countered by showing that few if any jobs will be lost. Many people now in private insurance will be employed by the government insurance agency if they want to be. Moreover the government will have new source of funds to create new job opportunities.

And the private companies may still sell supplementary auto insurance policies in competition with the government plan.

The auto owner will buy his insurance when he buys his license plates, and the older the car, the lower the cost.

Premier Schreyer heads a New Democratic government.

Community Health centers make sense

Another progressive union-supported policy which is making headway is the community health center.

With soaring health care costs even under government-sponsored plans,

the public would look favorably on any constructive measure which could cut costs without cutting services.

The logical way is by the establishment of community health centers.

The labor movement in Ontario has set up two union-backed community health centers, one in Sault Ste. Marie and the other in St. Catharines.

A reporter in Toronto's *Globe and Mail* did a series of articles on health services recently. One of them pointed out that even in Ontario, health care methods are old-fashioned.

As one doctor admitted, "Each doctor sits alone in his office and tries to do it all with his own hands. It won't work, it doesn't work. . . . We have to develop more community health centers like those in Sault Ste. Marie and St. Catharines. This isn't socialist medicine as some charge: it's the only kind of medicine that can do the whole job today."

The G and M writer, Jean Howarth, concluded that three main areas of health care have to be enlarged, group medicine, paramedical workers such as nurses, and homecare programs.

These areas are, of course, minimum essentials.

Others are getting adequate health care into rural areas and the north, improved mental health care and paying doctors by salary rather than by fee for service.

Steel executive attacks unions

Prominent business leaders have been touring Canada for the last year or so attacking organized labor in speeches to all kinds of organizations and service clubs.

These speeches have been finding their way into the daily and weekly press, into church publications, radio broadcasts and through other media which reach the public.

The intent of these speeches seems to be to undermine the collective bargaining process and trade union organization.

An example of one of these speeches is one by Mr. D. A. Machum who is a vice-president of Algoma Steel, the third largest steel producer in Canada, situated at Sault Ste. Marie.

Mr. Machum says that unions are getting too powerful, that they are winning too much at the bargaining table, that they strike too much, that strikes in the public sector are unthinkable and so on.

None of these attacks is new, but put together in one package and spouted in speech after speech and appearing in paper after paper month after month, they are bound to have effect in misleading the public.

Anyone out of the steel industry is not in a very good position to cry havoc. The industry as a whole is one of the most flourishing in Canada. It is efficient, productive and profitable.

It is true that the workers have won good wages and benefits over the last two or three decades. But does Mr. Machum want to turn the clock back?

Algoma Steel was non-union until 1940. Before that it had a company union. The labor rate was 27 cents an hour. Men worked two shifts a day, one of 11 hours, the other of 13 hours—seven days a week at straight time.

When shifts changed, men worked 24 hour nonstop.

The union has changed all that. Has the company suffered?

Let's look at the financial record.

In 1940, Algoma showed a net profit of \$780,000.

In 1950, it showed a net profit of \$3,557,000.

In 1970, the net profit was over \$23,000,000!

The Algoma executive is also telling the public that there are too many disruptive strikes in Canada.

What he doesn't say is that the strike record of Canadian workers over a period of 20 years is a very favorable one.

When strikes were few, wage gains were low.

In fact Canadian wages lagged about three years behind productivity gains.

In the last two or three years more strikes have taken place and Canadian wages have been catching up with productivity and profits.

But the strike record is still relatively good, and over 90 percent of industrial disputes are settled peacefully.

The big problem today is not in disputes and strikes, but in heavy unemployment and layoffs.

Mr. Machum claims that in 1969, there were 7.3 million man days lost through strikes.

But in that same year there were 8 million man days lost through industrial accidents, 40 million man days lost through sickness, and over 100 million man days lost through joblessness.

Continued on page 20

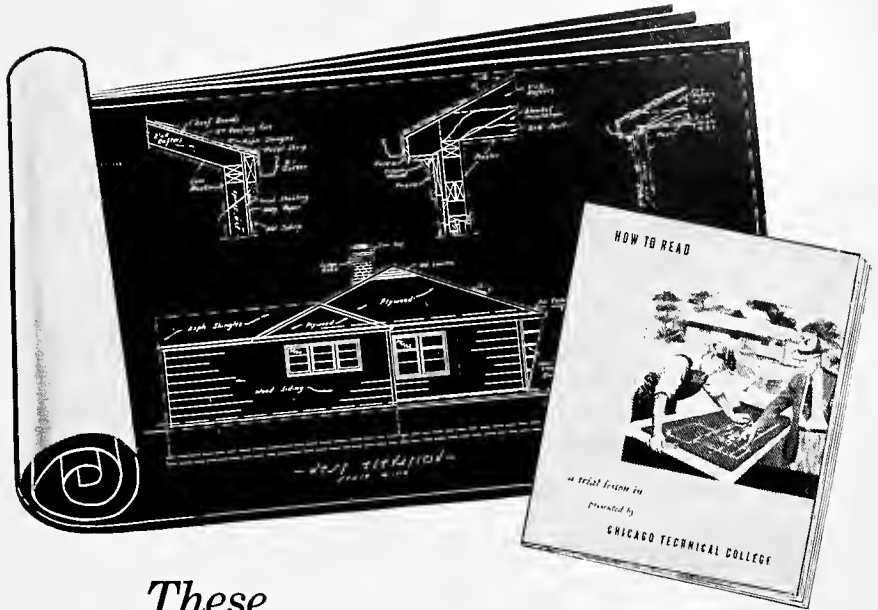

These
FREE BLUE PRINTS
have started thousands toward
BETTER PAY AND PROMOTION

That's right! In all fifty states, men who sent for these free blue prints are today enjoying big success as foremen, superintendents and building contractors. They've landed these higher-paying jobs because they learned to read blue prints and mastered the practical details of construction. Now CTC home-study training in building offers you the same money-making opportunity.

LEARN IN YOUR SPARE TIME

As you know, the ability to read blue prints completely and accurately determines to a great extent how far you can go in building. What's more, you can learn plan reading simply and easily with the Chicago Tech system of spare-time training in your own home. You also learn all phases of building, prepare yourself to run the job from start to finish.

CASH IN ON YOUR EXPERIENCE

For over 67 years, building tradesmen and beginners alike have won higher pay with the knowledge gained from Chicago Tech's program in blue print reading, estimating, foremanship and contracting. Through step-by-step instruction, using actual blue prints and real specifications of modern, up-to-date buildings, you get a practical working knowledge of every building detail—a thorough understanding of every craft. And as a carpenter or apprentice, you already have valuable experience that may let you move up to foreman even before you complete your training.

Don't waste a single day. Start preparing right now to take over a better job, increase your paycheck and command greater respect as the "boss" on the job. Find out about Chicago Tech's get-ahead training in building. Send for your free blue prints and trial lesson — today! Approved for Veterans.

CHICAGO TECHNICAL COLLEGE

E-143 TECH BLDG., 2000 S. MICHIGAN AVE., CHICAGO, ILL. 60616

**FREE
 BLUE PRINTS
 AND
 TRIAL LESSON**

Send for your free trial lesson now. You'll agree that this training is simple yet practical—your surest way to promotion and increased income in building.

MAIL COUPON TODAY

Chicago Technical College New G.I. Bill!
 E-143 Tech Bldg., 2000 S. Michigan Vets check here
 Chicago, Illinois 60616

Please mail me Free Trial Lesson, Blueprints and Catalog.

Name _____ Age _____

Address _____

City _____ State _____ Zip _____

Occupation _____

Accredited Member National Home Study Council



Illustration from STOKES' WONDER-BOOK OF MOTHER GOOSE
by permission of J. B. Lippincott Company



When Jack and Jill fell down the hill,

it was just a clumsy tumble. But when a child with muscular dystrophy falls, it means his diseased muscles are becoming so wasted that his legs can no longer hold up his body. A young dystrophy victim progresses with tragic swiftness from supportive braces to wheelchair to complete helplessness in bed . . . and early death. Until scientific research finds a cure for MD and related neuromuscular disorders, many thousands of children will continue to suffer this grim fate. Please help them by contributing to

THE MARCH AGAINST MUSCULAR DYSTROPHY

Muscular Dystrophy Associations of America, Inc.
1790 Broadway, New York, N.Y. 10019

*Support the work
of Muscular
Dystrophy Volunteers
in the Provinces
of Canada, too!*

Continued from Page 19

And the jobless situation is much worse today.

Mr. Machum also attacks the construction unions for making exorbitant demands—40, 50 and 100 percent—but in this area, he answers himself when he says that negotiated wage gains taken as a whole in Canada averaged 9.1 percent in the first quarter of 1970 when they were at the highest point.

But still he doesn't hesitate to say that many building trades workers are in the \$18,000 a year class.

This generalization is of course nonsense. The average unionized building trades worker may be making about \$8,000 to \$9,000 a year. His rate may seem high compared with other workers, but he gets only eight to nine months of regular work a year.

As for government employees who are now becoming unionized and more active, they have been underpaid for years. Why should they continue to subsidize the rest of the population?

Mr. Machum and other company propagandists have every right to say what they please. Much of what they are saying is based on half-truths and falsehoods, but the press is carrying it and it has to be answered.

As for their attack on collective bargaining, the process has been thoroughly probed year after year and the probers always come up with the same answer.

The process is not perfect, but until some genius comes up with a better way for a democratic society, it must continue to function.

Improvements—yes. Destruction—no.

Nova Scotia aids low-income homes

The Nova Scotia government has come up with a plan to help low income families own their own homes.

Families with incomes as low as \$4,000 a year may be able to buy a home with an interest rate of 3½ percent on the mortgage.

The subsidized interest rate will be made possible with federal and provincial help to reduce the rate to 5½ percent, and with municipal help to get it down to 3½ percent.

The question is should families with such low incomes be encouraged to buy, or should they be provided with rental homes at rents geared to income?

A low income family should be free to move into an area where conditions and wages are higher. Sometimes home ownership decreases mobility.

Nevertheless subsidized interest rates provide a way to help poorer families and is better than a do-nothing policy.

The federal minimum wage is being lifted to \$1.75 an hour effective July 1st.

The minimum is now \$1.65, applying to 530,000 workers in transportation, communications, broadcasting and banking industries.

All other industries with a few exceptions are covered by provincial minimums which now range from 95 cents in Prince Edward Island to \$1.55 in Alberta.

The minimum in Ontario goes up from \$1.50 to \$1.65 April 1st.

The unemployment insurance legislation is also being changed with higher benefits going into effect over a period from June 27th to January 2nd, 1972.

Maximum benefits go up from \$57 a week to \$100.

Over a million Canadian employees now excluded will come under the act, those earning over \$7,800 a year. The new legislation applies to all employees including teachers who were formerly excluded.

Sickness and pregnancy benefits are also added in the new legislation.

Employers will also have to give notice of layoffs and severance pay for discharged workers but the extent of the benefits will depend on the regulations after the legislation becomes law.

Freedman named Manitoba judge

The legal light who brought in the Freedman Report, Justice Samuel Freedman, has been named Chief Justice of Manitoba.

The new Chief Justice headed a royal commission almost five years ago on the subject of railway run-throughs.

He brought in a report including recommendations which were highly acclaimed by the trade union movement. In the main they urged protection for workers against the hazards of technological changes.

His recommendations have been slow in being put into effect, but Labor Minister Mackasey has promised action this year.

OUR CRAFT PAST

WORK IN THE CRAFT SHOPS OF 1840

■ Carpentry, joinery, and cabinet making—three skilled trades of our Brotherhood—are described in a 128-year-old book turned up recently by our editorial staff.

The work in these crafts, as practiced more than a century ago, are still familiar to us, though the tools and materials have undergone change.

The little book is called, "Popular Technology, or Professions and Trades," and it was actually published in 1843 by Harper and Brothers, New York City.

The shops of the period were much like the accompanying illustrations, taken from the book.

"It is the business of the carpenter," says the old volume, "to cut out and frame large pieces of timber and then to join them together, or fit them to brick or stone walls, to constitute them the outlines or skeleton of buildings or parts of buildings.

Continued on page 27

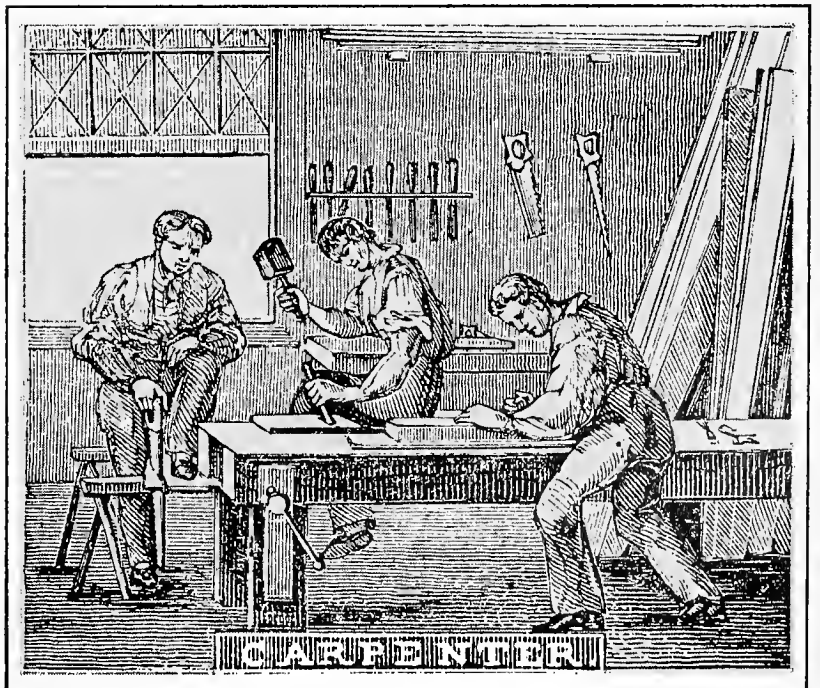
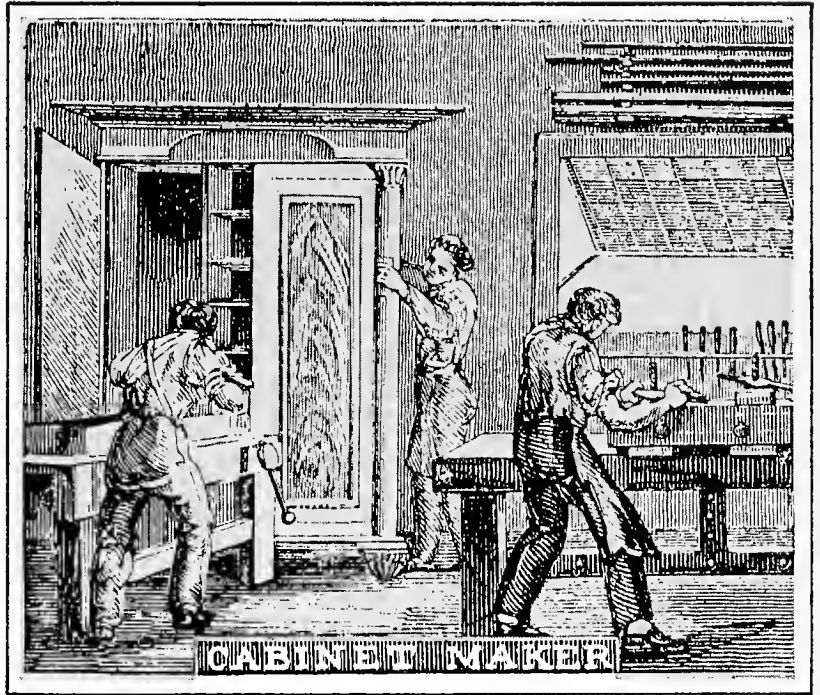

Ironworker Agreement

(Continued from page 7)

rary holding point in the area of installation or any cleaning and sub-assembly area as designated by the responsible contractor shall be the work of the Iron Workers.

(b) The rigging work required in the cleaning and sub-assembly area shall be performed by the Millwrights.

(c) The handling of machinery and/or equipment from the temporary holding point in the area of installation or the cleaning and sub-assembly area to the final point of installation will be performed by an equal numbered composite crew of Iron Workers and Millwrights.

(d) After composite rigging crew has safely placed machinery and/or equipment, Millwrights will complete installation, i. e., final alignment.

(e) Rigging of dismantled or knocked down machinery and/or equipment found in heavy industrial plants from one sub-assembly area to another sub-assembly area, prior to final installation, shall be the work of the Iron Workers.

ARTICLE 4

Removal of Machinery and/or Equipment

(a) Removing and loading out of ma-

chinery and/or equipment which does not require any disassembly shall be the work of the Iron Workers.

(b) The disassembly of machinery and/or equipment shall be performed in inverse order as outlined in section 2 and 3 above.

ARTICLE 5

Foremen

The responsible contractor shall have the prerogative of selecting the first foreman from either craft.

The second foreman selected shall be a member of the alternate craft.

All foremen shall be "working foremen" and shall be counted as members of the composite rigging crew.

ARTICLE 6

Local Union and Contractor Responsibilities

There shall be no work stoppage, slow down, sit down or picket lines established by members of either craft.

Should a dispute arise over interpretation of any part of this agreement, work shall continue as assigned by the responsible contractor.

Local representatives of each craft shall then meet on the job site and attempt to settle the dispute. If agreement cannot be arrived at by the Local representatives, they shall then submit prints, pictures and all other pertinent information to the two

administrators of this agreement for their consideration.

ARTICLE 7

Interpretation of Light and Heavy Industrial Plants

The various types of plants listed below are to be used as a guide in distinguishing between light and heavy industrial plants:

Light Industrial Plants:

Chemical, sewage, furniture, clothing, shoe, appliance, radio, television, soft drink and candy manufacturing plants as well as flour mills, textile mills, bakeries, breweries, canneries, laundries and dairies.

Heavy Industrial Plants:

Power plants, steel and/or basic metal producing facilities, paper mills, foundries, ore reduction, pelletizing, automotive, farm implement, news print and stamping plants.

ARTICLE 8

Scope of Agreement

(a) This agreement does not affect or supersede the Conveyor Agreement of June 22, 1953 and June 5, 1957, or the General Agreement of October 1, 1968, nor shall it supersede any agreements now existing which the United Brotherhood of Carpenters and Joiners of America or the International Association of Bridge, Structural and Ornamental Iron Workers may have with other International Unions.

(b) This agreement shall apply to all subordinate bodies of the United Brotherhood of Carpenters and Joiners of America and the International Association of Bridge, Structural and Ornamental Iron Workers.

S/JOHN H. LYONS

General President,

International Association of Bridge,

Structural and Ornamental Iron Workers

S/M. A. HUTCHESON

General President,

United Brotherhood of Carpenters

and Joiners of America

February 11, 1971 (execution date).

Safety Rules for Two Laws are Published

The Labor Department has issued 70 pages of regulations for the Construction Safety Act of 1969. They also will serve as preliminary regulations for the Occupational Safety and Health Act of 1970.

The entire document may be purchased for 20 cents. Order from Superintendent of Documents, Washington, D.C. 20402. Specify Volume 36, No. 75, Part 2 of the Federal Register (PAI)

TIME SAVER TOOLS' Patented, Carbide-Faced "BIG BORE" WOOD BITS

TWICE THE CUTTING LIFE!

Razor sharp edges are carbide-faced for longer life. All made in U.S.A.

Sizes: 3/8" - 1 1/4" diameters.

SPECIAL INTRODUCTORY OFFER

(Good to July 15, 1971)

4 DRILLS FOR ONLY \$3.00 postpaid

(A \$4.30 value)

This 4-drill set, W10C, contains 3/8", 3/4", 7/8" and 1", carbide-faced wood drill bits, plus shanks. For wood, plaster, composition board, plastics, and laminates.

Replaceable blades. "Resharpen" on the job with screwdriver.

Satisfaction
Guaranteed.



Send check or money order to arrive before July 15, to:

TIME SAVER TOOLS

1245 Glen Rock Avenue, Waukegan, Illinois 60085. Telephone: (312) 662-5303



Economist Revises Earlier 1971 Construction Forecast...Upward

■ The value of construction contracting in 1971 is now expected to total slightly over \$75 billion, 10 percent higher than last year's \$67.9 billion. The revised 1971 outlook confirms the much-improved prospect for construction in the year ahead that first became apparent last fall, according to a leading analyst of construction markets.

Reporting the first of a series of scheduled updates of the F. W. Dodge Construction Outlook prepared last October, George A. Christie, vice president and chief economist of McGraw-Hill Information Systems Company, has taken into consideration recent changes in economic conditions and their probable impact on construction demand.

Weighing the implications of the Administration's recent annual economic and budget messages, he said "the economic report, brimming with optimism about renewed growth and reduced unemployment and prices is the President's 'impossible dream'—an admirable target, but it shouldn't be taken seriously as a forecast of the near-term economic environment."

Commenting on the new Federal budget, Christie believes the current strategy of a large and deliberate deficit (though not greatly different from last year's large but unplanned deficit) "is aimed in the right direction, but it is relatively weak stuff, falling short of the kind of fiscal thrust needed to take up the slack in the economic system.

"The Administration's plan to lean on the Federal Reserve System to get it to provide a big expansion in the money supply, thereby helping to stimulate demand in the private sector, has pitfalls," according to the McGraw-Hill economist. "Inflation,

already a chronic problem even in recession, would almost certainly be aggravated by this degree of monetary expansion."

In Christie's view, "the greatest likelihood for the near future is closer to the soggy kind of economy expected by the majority of private forecasters than it is to the wishful thinking of government economists—A GNP of about \$1,050 billion implying a slow but steady recovery, continuing high unemployment, and persistent inflation unless some form of wage and price restraint is brought to bear."

Christie reported 1971 "still shapes up as a very big year for housing," and that the nonresidential building markets, which continue to show some of last year's sluggishness, "will see quarter-by-quarter improvement this year." Most of the year's gain will take place in the Northeast and South.

In specific construction markets he foresaw:

- Diminishing prospects for early recovery in industrial construction. In the commercial building sector, good gains in stores offsetting further declines in office buildings. Institutional building maintaining its current level throughout 1971.

- Housing contract value up 25 per cent to \$29 billion, reflecting two adjustments of the earlier forecast: 100,000 increase in dwelling units, to 1.8 million; slightly smaller unit size and value, as a result of sharp gain in proportion of low-income subsidized housing.

- Mixed pattern in nonbuilding construction, with highways showing only moderate growth, and utilities, one of 1970's big gainers, easing back a bit. Sewer and water facilities, however, heading for another gain. ■

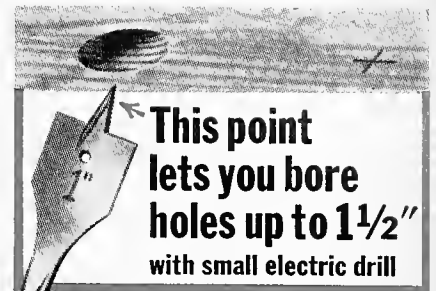

IT'S HOLLOW GROUND to bore cleaner, faster at any angle

Now step-up the boring range of your small electric drill or drill press to 1 1/2" with Irwin Speedbor "88" wood bits. 1/4" shank chucks perfectly. No wobble. No run-out. Sharp cutting edges on exclusive hollow ground point start holes faster, let spade type cutters bore up to 5 times faster. You get clean, accurate holes in any wood at any cutting angle.

Each Irwin Speedbor "88" forged from single bar of finest tool steel. Each machine-sharpened and heat tempered full length for long life. 17 sizes, 1/4" to 1 1/2", and sets. See your Irwin hardware or building supply dealer soon.



IRWIN SPEEDBOR "88" WOOD BITS
at Wilmington, Ohio, Since 1885

The Real Pros demand Lee

*Designed by Carpenters
Especially for Carpenters*

There's plenty of comfort, convenience and work-saving features in these overalls. Made just like you want 'em... because they're designed by workers like yourself. Guaranteed to be the best you've ever worn or we'll take 'em back. No questions asked.

Lee® UNION MADE
M.R. CARPENTERS' OVERALLS

H. O. LEE COMPANY, INC.
SHAWNEE MISSION, KANSAS 66201
"World's largest manufacturer of union-made workwear."





Service to the Brotherhood



A gallery of pictures showing some of the senior members of the Brotherhood who recently received 25-year or 50-year service pins.



1

(1) ROCK ISLAND, ILL.—On February 5th Carpenter's Local 166, honored eight of its members for 25 years of membership. They were each presented a 25-year pin at a membership smoker held in their honor. The members in the picture are from, left to right: President Eugene Rebello, making the presentations to William H. Pahl, Robert L. Nelson, Henry Kaselau, Richard Wagle and Virgil Frese

Those unable to be present were Willard Heisley, John Matthews and John McEvoy.



2

(2) MAYWOOD, CALIF.—Members of Furniture Workers Local 3161 recently received their 25-year membership pins and were congratulated by Harry Thomas, financial secretary, left. Honorees included Don Mortorano, Manuel Amado, James Davis, Curtis Perdue and Cita Rodriquez. Also eligible but not present to receive their pins were, Sam Arrisi, Hardin DeVold, Catarino Dominquez, Andy Galt, Charles Luckey, Martin Mortheim, Charles Rottino, Albert Rubalcava, and Arthur Stein.

(3) VANCOUVER, B.C. — Shown are members who received 25-year pins at the Dec. 13th meeting of Local 452. 1st row (left to right): Martin Jensen, Nick Sebal, Wallace Donovan, Floyd Downs, W. Peltola.

2nd row: Pete Kirkhus, Jack Wiens, Art Kelso, Len VanLaare, Riemans, 3rd row: W. Hnatyszen, Oliver Brock, Cliff Harris, George W. Sharp. 4th row: Ed. Francis, A. Nordin, G. Plosila. 5th row: R. Dodson, R. Brownlee. 6th row: Paul J. Urchenko, Bob Shellborn, Jack Dietz, Emil Hildebrandt.

Members also completing 25-year membership and being sent 25-year pins are: John Johnson, G. F. Sanders, Paul Ursulescu, Wm. Christensen, R. T. McCann, Harry Caldwell, R. J. Peace, S. MacLeod, A. Peltola, H. David, K. Otterstein, B. R. Gorsline, N. Belanski, E. Johanson, A. Stewart (sent), A. Russell, A. Edstrom, Peter West.



3



4



5

(4) VANCOUVER, B.C.—Former Vancouver, B.C., School Board employees got together at a party for retired members of Local 452. They included, from left: Harry Ostman, Frank Platt and Wally Donovan. Brother Platt is 93 years old and has a continuous union membership of 71 years.



(5) MENA, ARK. — Paul Halbig of Local 1627 receives a pension check from Financial Secretary Henry W. Berry, as Vice President Joseph G. Hoag pins on a 50-year membership pin. Brothers Hoag and Berry are 30-year members.

6

(6) PITTSBURGH, PA.—The 25-year members of Millwrights Local 2235 recently honored included:

Standing, left to right: M. Shaw, C. Shaw, J. Rudy, J. McLaughlin, W. Todd, J. Lowery, J. Klotzbaugh, R. Hanable, R. D. Singleton, G. Lyon, Sr., R. Clark, R. Colbert, H. Smith, D. Koseff, M. Banko, Sr. Kneeling, left to right: R. Cobb, M. Hazlett, H. Kanoza, A. DiPietro, L. E. Berkstresser, J. Senge (Secretary-Treasurer, C.D.C. of W. Pa.), J. McIntosh, E. King, S. Simco, J. Booher, and R. Booher.



7

(7) VICKSBURG, MISS. — Local 1964 at a recent award ceremony presented pins to some of its oldest members. They were: left to right, Walter Kelly, 30 years; George R. Wilcox, 30 years; J. O. Campbell, 30 years, and M. J. Chandler, 30 years. Back row, left to right: L. M. Jones, 30 years; E. W. Chandler, 30 years, and S. T. Barnes, 30 years. Also receiving his pin for 35 years service was Bro. A. D. Barfield, who was unable to attend.

sented him with a 30-year membership pin (as shown in picture No. 8). Accompanying Brother Wallace were Patrick McDonald, business representative of the Los Angeles District Council, and Fred V. Vogler, chief engineer of the hospital.

The second surprise was Brother Reardon's quick acquaintance with a 30-year Navy veteran from Indianapolis, Chief Boatswains Mate Frank E. Hyatt, shown in the hospital bed in Picture No. 9.

Wilbert Bernsdorf, Eugene Bilger, Roy Carroll, John Cheslow, James Defibaugh, Henry Donner, Patsy Dorazio, George Eggleston, John Freda, David Fulton, Robert Gassman, Joseph Gauthier, S. A. Giardina, Michael Graziano, Charles Hino, Joseph Kaufman, John La Vigne, Al Langfelder, Ernest Lederhouse, Albert Leising, Daniel Luraschi, Ross McCoy, George Meyer, Joseph Meyer, Calvin Miller, Pascal Minotti, Mauno Nicander, Anthony Notara, Holger Olsen, Joseph Pulverenti, Gerald Rice, Lynn Rice, Homer Rubeck, John Rubeck, Howard Schutt, Nelson Schutt, William Sinclair, Nicholas Strascina, John Stronecki, Raymond Swannie, Cirino Torrisi, Gordon Waldhauser, Robert Wessner, and Earl Willison.

(8) LOS ANGELES, CALIF. — Lawrence L. Reardon of Local 60, Indianapolis, Ind., was visiting his niece in Northridge, Calif., near Los Angeles, when he became ill and was admitted to the Sepulveda Veterans Hospital. Two pleasant surprises awaited him there:

On behalf of the Brotherhood and his home local, Business Representative Ralph W. Wallace of Local 2144 pre-

(10) BUFFALO, N.Y. (No picture)—A large group of veteran members of the Brotherhood assembled in the hall of Local 9 recently to receive pins. Honored were:

William Adams, John Addie, Richard Anger, Leonard Baumgart, Julius Becker,

8



9



APPRENTICESHIP & TRAINING

Kansas City Millwrights Study Optical Tooling In Deep Cave

■ The United Brotherhood of Carpenters with the cooperation of the Brunson Instrument Company recently conducted a training program in optical tooling for the journeymen millwrights in Kansas City. Twenty-two local journeymen took the 80-hours, 14-week course to upgrade their skills toward top jobs and full employment.

The program was organized by the Brotherhood's MDTA Coordinator, Edward Thele and Floyd Price, Kansas City Carpenters Apprenticeship Coordinator. Marion Douglas served as Instructor.

The training facility of the Brunson Instrument Company—under 77-foot-deep layers of solid rock—were made available by M. C. Anderson, vice-president of the Brunson Company.

Coordinator Price said: "The opportunity offered to Millwrights was unique in the isolated depths of a cave in a controlled temperature and humidity atmosphere."

The journeymen were instructed in the setting up and handling of the complex optical instruments. They found that the new techniques employed in modern optical tooling would greatly expedite their work. The new techniques employed on special-purpose optical tooling instruments will also benefit the millwright trade. ■

Reminder

The 1971 Carpenters International Apprenticeship Contest will be held August 12, 13, 14, in Detroit, Michigan. Every state and province should be represented by carpenter mill-cabinet, and millwright contestants.

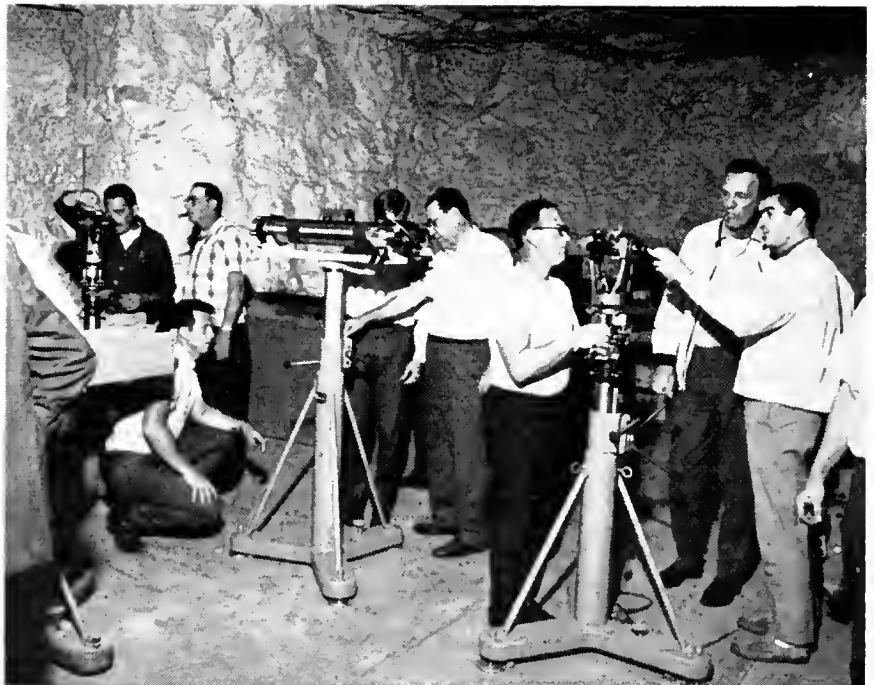

A busy class in a cave. Left to right: Jim Bradley, John Mark, Byron Kelly (kneeling), Tom Estes (behind instrument), M. C. Anderson (Brunson Co. vice president), Don Dettleson, Gordon Burnett and Bill Ruby.

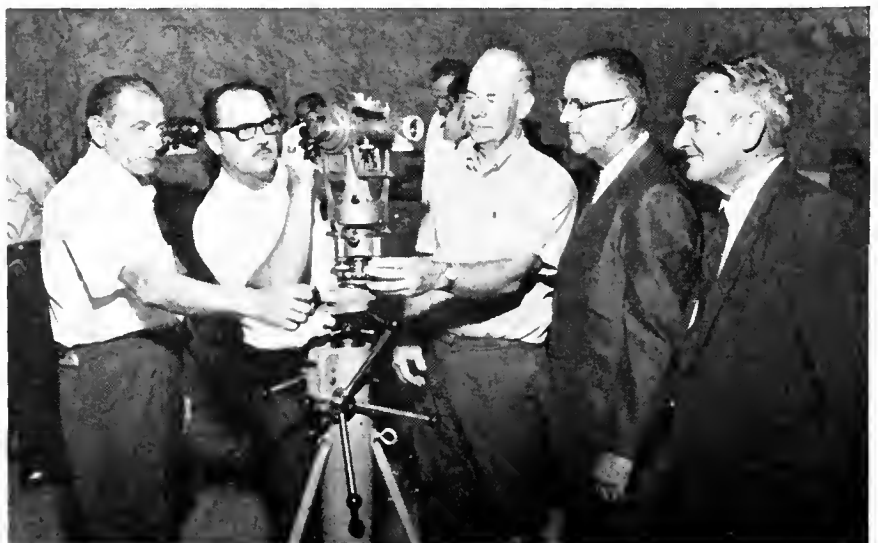

Millwrights studying optics, left to right: John Campbell; Paul Davis; Marion Douglas, Instructor; Ed Thele, MDTA Coordinator; and Floyd Price, Apprenticeship Coordinator.

1971 International Carpenters Contest Calendar

State	Date	Carpenter	M-C	MW
Alabama	May 27 & 28	X		
Alaska		X		
Arizona	April 5 & May 22	X	X	
California	June 17, 18 & 19	X	X	X
Colorado		X	X	
Delaware	May 26	X		
District of Columbia	June 5 & 12	X	X	
Florida	May 13	X		
Hawaii	June 18 & 19	X		
Illinois	June 9 & 10	X	X	X
Indiana		X	X	
Iowa	June 11 & 12	X		
Kansas		X		
Kentucky		X	X	
Louisiana	June 25 & 26	X	X	
Maryland	April 1	X	X	
Massachusetts	May 16 & 17	X	X	
Michigan	May 24 & 25	X	X	
Minnesota	June 12	X		
Nebraska	May 8	X		
Nevada	April 30 & May 1	X	X	
New Jersey	June 5 & 12	X	X	
New Mexico	May 1	X		
New York	May 5, 6, & 7	X	X	X
Ohio	May 26 & 27	X	X	
Oklahoma		X	X	
Oregon		X	X	
Pennsylvania	April 23 & 24	X	X	
Tennessee	April 16 & 17	X	X	
Texas	April 29 & 30	X	X	
Utah	May 22	X		
Washington	June 18 & 19	X	X	
Wisconsin	June 18 & 19	X		
Wyoming	June 12 & 13	X		
Alberta	April 16 & 17	X		
British Columbia		X	X	
Ontario	April 22 & 23	X	X	
Manitoba	June 18 & 19	X		
Connecticut		X		
Totals		39	15	19

Work in the Craft Shops of 1840

Continued from page 21

"The joiner executes the more minute parts of the wood-work of edifices, comprehending, among other things, the floors, window frames, sashes, doors, mantels, etc. Carpentry and joinery, however, are so nearly allied to each other that they are commonly practiced by the same individuals . . .

"Carpentry and joinery, as well as other trades connected with building, are subservient to the architect, when an individual of this particular profession has been employed, but it most commonly happens that the master carpenter acts in this capacity."

The principal tools of the carpenter of the 1840's were listed as follows: the axe, the adze, the saw, the auger, the gauge, the square, the compasses, the hammer, the mallet, the crow, the rule, the level, the maul, and the plane.

The timbers most employed in building were pine, oak, beech, black walnut, cypress, larch, white cedar, and hemlock. Oak and beech were much used in constructing heavy frames. Wood shingles, logs, and scantling were all part of the list of 1840 materials.

The cabinet maker of the period was the furniture maker of his day. He built tables, bureaus, sideboards, desks, bookcases, sofas, bedsteads, and much more. Says the little book: The cabinetmaker "requires not only a correct taste, but also a knowledge of drawing, architecture, and mechanics, besides the abilities of a good, practical workman." ■

Announcing a major breakthrough in a precision instrument! The only level that gives you plumb in four directions from one sighting

■ Unique patented channel construction permits use in close quarters where other levels cannot be used

■ Designed for use on round or flat surfaces

■ Improved accuracy—saves time

■ Achieves plumb 75% faster—saves work

■ Precision engineered heavy-gauge anodized aluminum for maximum strength, minimum weight

■ Plastic parts constructed of practically indestructible G.E. Lexan™ for clarity and durability

■ Precision machined for maximum accuracy

■ Fourteen quality control inspections insure guaranteed accuracy

■ All levels contain 6 vials

■ Obsoletes all existing levels

NEW MIRACLE MULTI-VUE LEVEL

Please send me more information

Name _____

Address _____

City _____

State _____

Zip _____

MIRACLE INSTRUMENT COMPANY
1569 Third Avenue, New York, N.Y. 10028
Patents #2, 727, 314. Other Patents Pending



New Improved
Estwing
HAMMERS

Last Longer
Than All Others!



"Mark of
the
Skilled"

New Safe-T-Shape Grip

- Unsurpassed, Estwing Temper, Balance and Finish
- Forged One-Piece Solid Steel
- Strongest Construction Known

plus

- Exclusive Nylon-Vinyl Deep Cushion Grip (not rubber)
- Molded Permanently to Steel Shank
- Won't Loosen, Come Off or Wear Out
- Easiest on the Hands

Estwing MFG. CO.
Dept. C-10 Rockford, Ill.



DICTIONARY

This is the third of a new feature series planned to keep you better informed on the meanings of terms related to collective bargaining, union contracts, and union business. Follow it closely, and your union membership will become more meaningful, and your ability to participate in decisions which affect your future and security will be strengthened. It was compiled by the International Labor Press Assn, and is used with permission.

B

bargaining agent: The formally designed agency, usually a labor union, which represents employees seeking or having a collective bargaining agreement (contract). Its rights and obligations are defined by federal law.

bargaining unit: The group of employees, usually defined by the National Labor Relations Board after a hearing, which a union may seek to represent as bargaining agent on wages, hours and working conditions.

base rate: Under incentive system, amount guaranteed per hour or other time period. (See guaranteed rate).

beef: See grievance.

black list: A management roster of those deemed "undesirable" as employees—illegal when used for anti-union purposes.

BLS: See Bureau of Labor Statistics.

blue-collar workers: Production and maintenance workers as contrasted to office and professional personnel.

boycott: Collective pressure against an employer to discourage public acceptance of his products or services. A primary boycott involves one employer and his employees only; a secondary boycott involves a third party, and in many cases is forbidden by law.

broken time: Split shift.

brotherhood: A labor union, federation, guild or association. The term derives from the strong fraternal nature of early trade unions, and their primary concept of the brotherhood of man.

bug: A union emblem or symbol, specifically in the printing trades.

bulletin board: A contractually-provided wall space available for the display of union messages or information.

bumping: Application of seniority in the layoff of employees, ordinarily set forth in detail in the collective bargaining agreement. A senior employee laid off from his own job may displace—i.e., "bump"—a junior employee from a lesser post.

Bureau of Labor Standards: An agency of the U.S. Department of Labor, which seeks to improve working conditions. Special areas of interest are safety standards, improvement of migratory labor conditions, enforcement of child labor laws and improvement of opportunities for the physically handicapped.

Bureau of Labor Statistics: A research agency of the U.S. Department of Labor Statistics are compiled on hours of work, average hourly earnings, employment and unemployment, consumer prices and many other areas.



Editorials

The Low-Wage, Foreign-Trade Shoe Is Beginning to Pinch

■ Before the present session of Congress adjourns, a showdown on American foreign trade policy seems inevitable. Pressures are mounting from many sources for some sort of limitation on imports of low-wage foreign goods affecting a number of industries which are suffering badly from such unfair competition.

Foreign trade policy always has been a political football in both the United States and Canada. Until after the war, employers and workers usually were lined up side-by-side in the battle to keep low-wage imports from undercutting domestic industry.

This is no longer the case. American corporations have moved into many countries. They either build their own foreign factories or enter into arrangements for selling products of foreign manufacturers. This greatly diminishes their interest in protecting their American plants. They make a profit whether the products they sell are made in North America or Asia. Maybe they make more on their foreign operations because the wages are far, far lower.

So, today, it is the working people who bear the brunt of the hardship created by foreign imports. Under the circumstances, it is understandable that many American labor unions are becoming increasingly insistent on a re-assessment of the existing trade policies.

Such items as sewing machines and printing equipment have virtually become monopolies of foreign factories. Pottery, shoes, textiles and steel, are all suffering from increasing low-wage foreign competition.

Steel is a good case in point. In the past two years some 30 major construction projects on the Pacific Coast utilized foreign-made steel. Better than 160,000 tons of fabricated steel items were involved. The bulk of the imported steel came from Japan. However, Korea, England, Italy, and even India, all supplied some.

Under the circumstances, it is understandable that organized labor should show genuine concern.

Bad as the import situation has been, it threatens to deteriorate still more under the Nixon Administration. The Administration seems insistent on freeing all foreign aid restrictions.

Heretofore, the countries to which we provided foreign aid have been required to spend some 80 or 90 percent of that aid for goods made in the United States. Once this requirement is lifted, the recipients of our aid become free to buy whatever material they want from whatever source they feel to be most advantageous to them.

It scarcely needs to be pointed out that such a move will create even greater problems for many American industries. African nations will be able to buy more cheaply in Europe, and South American countries will certainly shop the entire world for the cheapest prices available on the commodities they buy with the aid dollars we provide. In the long run, a serious impact must result for American industry in general.

In the years since the close of World War II more and more we have tended to become an exporter of raw materials and an importer of finished goods which involve considerable labor.

Our trade with Japan illustrates this point. We ship vast quantities of cotton, coal, tobacco, hides and logs to the Japanese. None of these items involve much labor. On the other hand, we import from Japan cameras, tape recorders, automobiles, motorcycles, television sets and component parts of all these items.

Up to now we have managed to maintain a dynamic economy under such conditions. But the shoe is really beginning to pinch, and a re-evaluation of the whole foreign trade posture needs to be made, with the emphasis on the welfare of American workers rather than on the profits of conglomerate corporations and foreign producers. ■

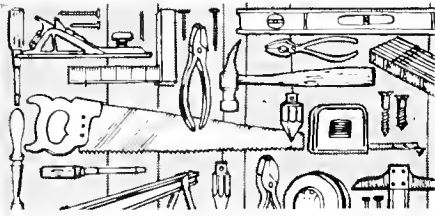

LOCAL UNION NEWS

Crestline Plant Expansion in Wausau, Wisconsin



Crestline Corporation, manufacturer of wood windows, recently broke ground for a new addition to its plant in Wausau, Wis. The new building will be utilized for new products and warehousing and is expected to be completed by May, 1971. Shown breaking ground is Lawrence Riordan, President of Crestline. Also present at the event were Robert Worash, Business Representative, Midwest Millmen's District Council; Ray



Zimick, General Representative, and Wayne Soukup, President, Local 1594.

President Soukup expressed delight that the company chose Wausau to make this expansion. Crestline has a national sales outlet for its manufactured products. Presently 225 workers are employed in the operation. An additional 70 to 75 more workers will be hired.

Tunney Welcomed



U.S. Senator John Tunney, California Democrat, right, above, was principal speaker at the recent 22nd Annual Banquet and Victory Celebration of the Philadelphia, Pa., Committee on Political Education. Among those welcoming him was Robert H. Gray, Metropolitan District Council secretary-treasurer.

Officers and Guests at Local 503 Meeting



Officers of Local 503, Lancaster, N.Y., recently assembled for pin-presentation ceremonies in their local union. They are shown here with guests from the district council. In the front row, from left, are Robert Kennedy, trustee; Allyn Seibert, vice president; Herman F. Bodewes, president of the Buffalo District Council; Herman J. Bodewes and William Miller, business agents. Second row, Sylvester Philips, trustee; Howard Hanel, recording secretary; Anthony Suchyna, treasurer; Jerome Nawrocki, financial secretary; Henry Niedjlak, trustee; and Paul Walters, secretary-treasurer of the Buffalo District Council.

Chicago Local Marks 75 Years

Carpenters Local 58, Chicago, recently celebrated its 75th birthday with a sumptuous dinner attended by 1,650 members and guests at the Conrad Hilton Hotel. Mayor Richard Daley and General Treasurer Peter Terzick headed the list of honored guests and speakers.

The local union was granted a charter on February 21, 1896, with 220 members. It was formed through the consolidation of Locals 269 and 730. Locals 1286 and 980 were later merged into the new local union too. The membership today is 1,917.

Among the guests were William A. Lee, president of the Chicago Federation of Labor and Industrial Union Council; Stanley Johnson, president of the Illinois State Federation of Labor; William Konyha, new GEB member; and many other state and local leaders.



Charles A. Thompson, veteran leader of the Brotherhood in Chicago, confers with the city's newly-re-elected Mayor Richard J. Daley at the commemorative dinner.



Charles Thompson, president of Local 58, second from left, welcomes General Treasurer Peter Terzick to the festivities in the Windy City. With the two men are Wesley Isaacson, vice president and business representative, and George Vest, Jr., president of the Chicago District Council of Carpenters.



During the dinner, the officers of Local 58 gathered for an official photograph.

LABOR and MATERIAL COSTS

NATIONAL CONSTRUCTION ESTIMATOR
Nineteenth Edition

ACCURATE BUILDING COSTS IN DOLLARS AND CENTS

LIGHT and HEAVY CONSTRUCTION

1971 UNIT COSTS
COMPILED FROM
THE RECORDS OF
HUNDREDS OF
CONTRACTORS
AND MATERIAL
SUPPLIERS

ONLY \$4.75

3 1/2 x 11
NO ADVERTISING In California add .24c tax

- ACCURATE BUILDING COSTS IN DOLLARS AND CENTS
- AVERAGE LABOR COSTS FOR THOUSANDS OF ITEMS
- TYPICAL SUB CONTRACT PRICES INCLUDED
- NEW ESTIMATING RULES OF THUMB

Send for FREE Building Books Catalog

CRAFTSMAN BOOK COMPANY OF AMERICA Dept. C2
124 SO. LA BREA AVE., LOS ANGELES, CALIF. 90036

Please send me the *Nineteenth Edition* of the NATIONAL CONSTRUCTION ESTIMATOR. . \$4.75
In California add .24c Sales Tax

Please send me FREE Building Books Catalog.

Firm Name _____

Your Name _____

Address _____

City _____ State _____

AMOUNT ENCLOSED _____ Zip _____

10 DAY FULL MONEY BACK GUARANTEE

LAYOUT LEVEL

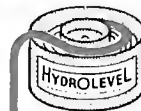

- ACCURATE TO 1/32"
- REACHES 100 FT.
- ONE-MAN OPERATION

Save Time, Money, do a Better Job
With This Modern Water Level

In just a few minutes you accurately set batters for slabs and footings, lay out inside floors, ceilings, forms, fixtures, and check foundations for remodeling.

HYDROLEVEL is the old reliable water level with modern features. Toolbox size. Durable 7" container with exclusive reservoir, keeps level filled and ready. 50 ft. clear tough 3/10" tube gives you 100 ft. of leveling in each set-up, with 1/32" accuracy and fast one-man operation—outside, inside, around corners, over obstructions. Anywhere you can climb or crawl!

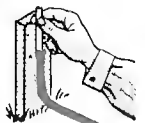

Why waste money on delicate instruments, or lose time and accuracy on makeshift leveling? Since 1950 thousands of carpenters, builders, inside trades, etc. have found that HYDROLEVEL pays for itself quickly.

Clip this ad to your business stationery and mail today. We will rush you a Hydro-level with complete instructions and bill you for only \$7.95 plus postage. Or send check or money order and we pay the postage. Satisfaction guaranteed or money back.

Ask your tool dealer to order it for you. We allow the usual dealer discount on 1/1 Doz. lots and give return-mail service.

HYDROLEVEL

925 DeSoto, Ocean Springs, Miss. 39564
FIRST IN WATER LEVEL DESIGN SINCE 1950



Annual Old Timers' Reunion for Local 34, San Francisco

Pile Drivers, Divers, Carpenters, Bridge, Wharf & Dock Builders Local 34 San Francisco, Calif., recently held its annual 'Old Timers' Luncheon, at the union hall. Presentation of 25-year pins and a past-president pin were made. Guests in attendance were: Clarence Briggs, International Representative, 8th District; Al Figone, secretary, Bay Counties District Council; Anthony Ramos, secretary, California State Council; John Watts, assistant business agent of District Council; Joe O'Sullivan, president, Bay Counties District Council; Dave Williams, trustee, Carpenters Trust Fund; Jack Wagner, retired business agent of Local 34, who originally instituted the annual 'Old Timers' Luncheon.

Marchers in Delaware Told Governor to Veto Wage Bill

Construction workers of Delaware, 1,200 in all and led by placard-carrying members of Carpenters Local 626 of Wilmington, recently marched on the state capitol at Dover to protest Senate Bill 96, which would have repealed the state's prevailing wage law.

Though they arrived too late to stop senate passage, they were ready to urge Republican Gov. Russell Peterson to veto the legislation—which he pledged to do.

The governor's sentiments were conveyed to the marchers by Secretary of Finance Joseph Cashman, Peterson's principal political advisor.

The message to the marchers headed off what might have been an angry confrontation. As it was, the day off for

marching cost the workers an estimated \$50,000 in lost wages.

James Dorman of Local 626 told *The Delaware State News*, "We are very tired of picking up the paper and finding that this Republican administration has appointed somebody to a \$25,000-a-year job. We want some of that action. We want to live well. We work hard, and the weather kills us. We pay taxes, too. We pay our own health and welfare costs."

Asked if any of the hard hats were being paid for a day's work to come to Dover, Dorman said, "Absolutely not."

The marchers linked Gov. Peterson frequently with President Nixon, who had suspended a similar Federal law—the Davis-Bacon Act—two weeks before.

Busy Retirement



Frank Cicansky, 71 years old and a retired member of Local 1867, Regina, Saskatchewan, finds continued pleasure in his carpentry work. Among the items he has produced since his retirement are those shown here—small replicas of windmills, houses, and what appears to be Noah's Ark.



Construction workers of Delaware, wearing their hard hats, hastened to the state capitol at Dover to urge the state senate to bury Senate Bill 96, which would have repealed the state's prevailing wage law. They were successful. Members of Local 626, Wilmington, can be seen in the pictures.



PLANE GOSSIP

SEND YOUR FAVORITES TO:
PLANE GOSSIP, 101 CONSTITUTION
AVE. NW, WASH., D.C. 20001.
SORRY, BUT NO PAYMENT MADE
AND POETRY NOT ACCEPTED.

All Berry True!

Said one strawberry to the other:
"If you hadn't gotten fresh, we
wouldn't be in this jam!"—Mary An-
derson, Sanford, Fla.

R U REGISTERED 2 VOTE?



Something In Reserve

The good-looker's car broke down
and she was trying to thumb down
passing cars for help. A patrolman
pulled up and said: "Lady, you should
tie a white handkerchief to your radio
antenna."

"Look" she replied, "I just want
help . . . I don't want to surrender!"

BUY ONLY UNION-MADE TOOLS And Waxing Rich?

There's a carpenter in our local who
moonlights at a candle factory. But
he only works on wick ends.

UNIONISM STARTS WITH "U"

Full of Ambition

The hippy showed up for a job in-
terview wearing filthy, ragged clothes,
a smell like a middle-aged moose and
six months of hair on his face and
head. "How old are you?" asked the
personnel director.

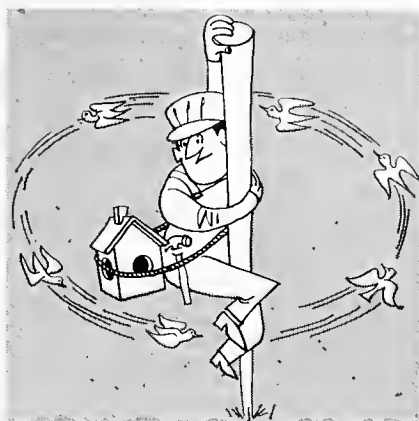

"Twenty-four" said the bum.
"And if you come with us what do
you expect to be in five years?"
asked the interviewer.

"Twenty-nine" replied the tramp.

UNION MEN WORK SAFELY

Passing Troubles Along

Show me a man who can smile in
the face of all his troubles and I'll
show you a man who has figured out
how to blame them on somebody else!
—Ernest Plunket, B.A., L.U. 200, Co-
lumbus, Ohio.

BE AN ACTIVE UNIONIST

Music . . . And the Mind

A true music lover is a man who
will put his ear to the keyhole when
he hears a girl singing in the shower.

A psychiatrist is a guy who, when
a knockout of a girl walks into a room
and everybody looks at her . . . he
looks at THEM.

I 4 ALL—ALL 4 1

Small Wonder!

Looking at the crop of 1971 cars,
our B.A. expressed surprise that the
small cars cost almost as much as the
larger models. "Well," remarked the
salesman, "if you want economy, you
gotta expect to pay for it!"



This Month's Limerick

There was a young lady named Banker
Who fell asleep while the ship was at
anchor.

She awoke in dismay
When she heard the mate say:
"Pull in on the topsheet and spanker!"
—F. H. Warde, L.U. 1062

Left Here Breathless

John Freeman of Local 22, San
Francisco, says an artist on North
Beach died recently. He couldn't draw
his breath.

ALWAYS C D UNION LABEL

A Non-Corny Joke

Sometimes wild oats that were
sowed have to be thrashed out in
court.

UNION DUES BUY RAISES

Something Fishy Here!

Two sardines were swimming along
when a submarine went by. "What's
that?" asked one.

"Oh, that's a can of people," re-
plied the second.

BE UNION—BUY LABEL



Feline Sorry for Him?

You can always overdo an act.
Consider the poor slob who spent five
years pretending to love his rich
aunt's pet cats. So when the loaded
old lady died, all she left him were
all five cats!—Maurice Howes, L.U.
444, Pittsfield, Mass.

UNION-MADE IS WELL-MADE

Heavenly Flit!

While visiting some friends in a
summer cottage near a swamp, the
little girl was afraid of the dark.
"Don't worry, dear," soothed her
mother, "remember that God's angels
are all around you." She closed the
door but shortly, the little girl called
out:

"Mama, the angels are buzzing all
around me . . . and biting!"



Outdoor Meanderings

Readers may write to
Fred Goetz
 2833 S. E. 33rd Place,
 Portland, Oregon 97202

"Dump the Muck, Who Cares?" Is Attitude of Too Many Firms

■ The mounting toll of fish killed by pollution each year is an awesome and frightening thing. Each year the toll mounts and it's bound to continue unless recent corrective and preventive measures are rigidly enforced. It appears there are still too many individuals, industries (including agricultural pursuits) and government agencies, at various levels, willing to bear the "fines" and the "shame of it" as operational overhead; or, "in the name of progress."

Current "Yearly Fish Kill" figures from the "Environmental Protection Agency" reveal 40.6 million killed in the U.S. Added to this is an alarming toll in traditionally pristine Canada. That's progress?

The recap of the state-by-state survey uncovered many careless acts, but the thing which infuriates the citizenry is the complete lack of concern by a percentage of stream, lake and estuary polluters who seem to say by their act: "Aw, the heck with it; dump the muck; who cares?" That's progress?

For instance: "Sawdust and coal slag were bulldozed into river; 9,400 fish died as a result."

"Diesel oil from a derailed tank car, left for three days, leaked into stream; 29,000 fish died."

"Excessive nutrients from septic tank were washed into lake killing 158,000 fish."

"Deicer from manufacturing plant entered stream through sewage system; 600,000 fish died as a result."

That's progress?

Some say: "Do not push the panic button." If it was simply a matter of replacing dead fish, there would be

few problems. Fortunately for mankind, fish are very prolific creatures.

What troubles us are the "hot fish," which for some reason manage to escape death. Perhaps because they are on the fringe of the pollution area or happen to be especially hardy. But what happens when these fish absorb "toxic pollutants" and the unsuspecting angler brings them home in his creel? And what happens when the consumer unknowingly buys them from an equally unknowing fish seller's stalls. That's progress?

Fortunately—at present—the waters which hold "hot fish" are relatively

few in numbers when compared to the countless, clean and safe fishing waters over the land. But there are—today—some questionable waters which hold fish not recommended for table fare. For a list of these waters, write to Richard J. Ronk, U.S. Food and Drug Administration, 200 "C" St., S.W., Washington, D.C. 20204. At a recent meeting, Mr. Ronk assured this writer they were hastening to "update" their November '70 bulletin which listed waters that were—from a standpoint of quality—unsafe or questionable, and that his Department was working feverishly with the aid of recently-developed and highly sophisticated analytical tools to identify and classify the type and degree of various metallic contaminants in fish.

This writer was recently assured in an interview with William D. Ruckelshaus, Administrator of the Environmental Protection Agency, that rigid "water quality standards" have been set and that they will be rigidly enforced and that those who fail to meet them will face heavy fines and possible imprisonment. He said he had no objection to court action brought about by an "informed citizenry" against violators of these standards. "I may live to regret it," he added, "but that includes my own agency if they be at fault."

What should you do if you suspect environmental pollution of your favorite fishing waters? Each state has its own "Water Pollution Control Agen-



What's wrong with this photograph? The fish are "on" the surface, rather than "under" the surface, victims of water pollution.



This could be your favorite fishing hole if water pollution isn't curbed.

cy." Inform them of your findings. If you feel they do not act to your satisfaction, you have recourse through the courts. Interest your local sportsmen-conservationist organizations in your findings. If you do not belong to one; join one. There are 7,000 local clubs, in 50 states, within the framework of the National Wildlife Federation; a sizable number in the Izaak Walton

League of America, and other equally-effective citizen groups that are "on the move against water pollution." You may even want to form your own group; many have; it's your world.

Perhaps increased action by an enraged citizenry will persuade "the polluters" that "an ounce of prevention is worth a pound of cure." If they do, that will really be progress. ■

■ Trot-line Catfish

We're bound to chalk up a column record on "trot-line caught catfish" for Woodrow Brickey of Monticello, Indiana, a member of Local 3154. Brother Brickey, fishing the deep waters of Freeman Lake, he eased a 75½ pounder to boat with an assist from Floyd Bernhardt of Indianapolis who was fishing nearby. The chunky "cat" measured 54 inches from its whiskers to its tail and 34 inches around the belly. Actually, it was a good day for the Brickey boys for Woodrow's brother Harold, fishing the nearby Tippecanoe River, eased a 4-lb., 5-ounce smallmouth bass to bank, one of the largest smallmouth to come out of Tippecanoe for quite a spell.

■ Fishing Lure

Can your tackle box hold another fishing lure? we'd be happy to trade one of the BOLO fishing lures for a clear snapshot of a fishing or hunting (we're low on hunting pics) scene and a few words as to what the snapshot is about. Either black-and-white or color is acceptable but it must be reasonably defined and in focus in order to be reproduced in this column.

Only requirement is that you be a member of the Brotherhood of Carpenters and Joiners of America—in good standing—a member of the family or, of course, a retired member. Send it to:

Fred Goetz, Dept. OM
2833 S.E. 33rd Place
Portland, Oregon 97202

Planer·Molder·Saw!

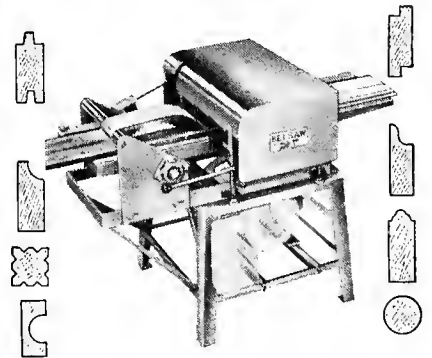

Now you can use this ONE power feed shop to turn rough lumber into high-value moldings, trim, flooring, furniture... ALL popular patterns.

RIP... PLANE... MOLO... separately or all at once by power feed... with a one horsepower motor. Use 3 to 5 HP for high speed commercial output.

LOW COST... You can own this MONEY MAKING POWER TOOL for only... \$30.00 down.

Send coupon today... No salesman will call

BELSAW POWER TOOLS
942B Field Bldg., Kansas City, Mo. 64111
Send me complete facts on the MULTI-DUTY Power Tool. No obligation.

Name _____
Address _____
City _____ State _____ Zip _____

MAKE \$20 to \$30 EXTRA on each STAIRCASE



Saves its cost in ONE day—does a better job in half time. Each end of Eliason Stair Gauge slides, pivots and locks at exact length and angle for perfect fit on stair treads, risers, closet shelves, etc. Lasts a lifetime.

Postpaid if payment sent with order, or C.O.D. plus postage Only \$19.95

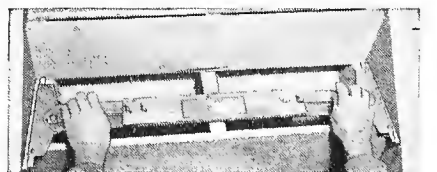

ELIASON STAIR GAUGE CO.

6005 Arbour Lane
Minneapolis, Minn. 55436



REPORT

Monthly Membership Contributions To The Carpenters Legislative Improvement Committee

The 1971 CLIC fund-raising drive got off to a good start March 22 when Gen'l. Treas. Peter Terzick spoke to the annual meeting of the Western Council of Sawmill Workers at Spokane, Wash. Delegates collected \$1,250 for the new campaign, as 1971 buttons sold like hot cakes.

A few days later, the Brotherhood's Legislative Director Jim Bailey attended the meeting of the Massachusetts State Council, and the 184 delegates there contributed \$2,045!

Funds are beginning to come in from local unions across the nation, and we expect to publish the first report of such contributions in the June issue of *The Carpenter*.

Meanwhile, CLIC urges all Brotherhood members to get the eligible young members of their families registered now. Many states now allow 18-year-olds to vote. They should be prepared to vote **RIGHT!** The best way for young people to express their political feelings is by exercising their right to vote as responsible citizens. Remind them of this today.

All members are urged to join CLIC in 1971.

We urge all Brotherhood members to write to their congressmen and senators, regardless of party affiliation, urging that the President be required to release immediately the \$12.5 billion in construction money, which he has frozen.

This money has already been appropriated for highway construction, airport construction and modernization, and construction of public housing, but the President apparently wants to make our members suffer unemployment until next year.

While the President is calling for revenue sharing with the states, he is sitting on this \$12.5 billion already voted by the Congress to help the states and cities. Then when he does release the funds in the spring, he will look like the savior of the Building Trades!

June 5 is SOAR Day; Join Clean-up Effort



A Boy Scout dumps collected and flattened aluminum cans into a truck in a trash recycling project.

On June 5, Keep America Beautiful, Inc., and the Boy Scouts of America are sponsoring a massive nationwide clean-up drive. It is part of the year-long, national SOAR campaign (SOAR stands for "Save Our American Resources").

Everyone, young and old, is being asked to join the Scouts and other organizations on that particular Saturday in ridding our streets, highways, parks, playgrounds, and beaches of the litter that pollutes the land.

Litter is a health and safety hazard an aesthetic and social blight. It attracts rats, feeds fires, spoils natural beauty and costs taxpayers an estimated half billion dollars a year. An attempt to clean-up the blanket of trash that threatens to smother us all is a tremendous undertaking, but a beginning must be made.

Each year, motorists drop 16,000 pieces of trash on each mile of primary highways in America! Let's put a stop to this now.

new AUDEL CARPENTERS & BUILDERS GUIDES



4 VOLS.
1616 Pages
Heavily Illust.
ONLY \$18.50

INSIDE TRADE INFORMATION— for Carpenters, Builders, Joiners, Building Mechanics and all Woodworkers. Here are the short-cuts you want—new methods, ideas, solutions, plans, systems and money-saving suggestions. A complete course for the apprentice—a practical daily help and Quick Reference for the master worker. Mail COUPON TODAY to get these helpful guides used by thousands of carpenters. Shows you—

HOW TO USE: Mitre Box, Chalk Line, Rules & Scales, Steel Square & Settings 12, 13 & 17. **HOW TO BUILD:** Furniture, Cabinetwork, Houses, Barns, Garages, Skylights, Stairs, Hoists, Scaffolds. **HOW TO:** File & Set Saws, Do Carpenters Arithmetic, Solve Measurement Problems, Estimate Strength of Timbers, Set Girders & Sills, Frame Houses & Roofs, Estimate Costs, Read & Draw Plans, Draw Up Specifications, Excavate, Lath, Lay Floors, Hang Doors, Put On Interior Trim, Insulate, Paint.

MONEY BACK GUARANTEE

You must be COMPLETELY satisfied with the Audel Guides you order, or you may return them within 10 days and get your money back.



ORDER NOW!

MAIL COUPON TODAY

THEO. AUDEL & CO., 4300 W. 62nd St. C-051
Indianapolis, Ind. 46268

Please mail me Carpenters & Builders Guides, 4 Vols. Enclosed is down payment of \$6.00. I agree to pay balance, including shipping costs, within 30 days. If I am not completely satisfied with my Audel Guides I may return them for refund.

Name _____

Address _____

City _____ State _____ Zip _____

SAVE SHIPPING COSTS. Enclose \$18.50 (plus sales tax, if any) and we pay postage.

BE A PANELING EXPERT

Take all the guesswork out of aligning and marking corner panels with our kit of rugged aluminum off-set jigs and marking gauges.

Increase your speed and accuracy as you scribe perfect panels marked for a "pressed-in" fit. Panel-by-panel instructions included for inside and outside corners and for the location of cut-outs, for plywood panels of 1/4" or less.

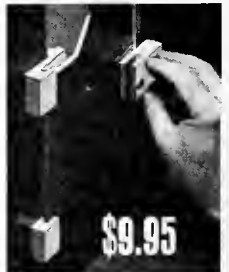

NOW... OFFSET JIGS FOR ROUTERS

A Cut-In-Place method of fitting inside corner panels. The router takes the place of the marking gauge or scriber and precisely cuts over 90% of an 8 ft. panel. Complete instruct.

Offset jigs and marking gauges. \$9.95 Postpaid. (Calif. tax 50¢)

Cut-In-Place jigs for your router. \$6.95 Postpaid. (Calif. tax 35¢)

Only Californians add sales tax. C.O.D. orders: you pay postage and charges. Satisfaction guaranteed or money refunded.

A revolutionary new tool dolly!

Heavy duty compact design • turns on a dime • jumps electric cords with ease

Detailed Construction Plans — \$1.95. Check or M.O. Californians add 10¢ tax.

PANELING SPECIALTIES CO.

Box 11764 • Palo Alto, Calif. 94306



IN MEMORIAM

**L.U. NO. 8
PHILADELPHIA, PA.**

Chouinard, Sylvio
Martin, Thomas A.

**L.U. NO. 12
SYRACUSE, N.Y.**

Watkins, Fred, Sr.
Thomas, George E.

**L.U. NO. 15
HACKENSACK, N.J.**
DeRuiter, Peter

**L.U. NO. 36
OAKLAND, CALIF.**

Bereczkey, Boldizar
Biondo, Peter
Cunningham, W.
Hansen, Thorheld
Kleven, H. M.
Lund, R. O.
Nelson, Nels A.
Walker, Theo

**L.U. NO. 50
KNOXVILLE, TENN.**

Branum, Fred

**L.U. NO. 88
ANACONDA, MONT.**

Davis, Otto

**L.U. NO. 90
EVANSVILLE, IND.**

Mechler, William
Rowley, Bert
Schultz, Fred F., Sr.
Ulsas, Arthur

**L.U. NO. 93
OTTAWA, ONT.**

Darvill, Joseph
DuPuis, William
Hills, Horace
Saumure, Raymond
Stephens, Walter
Vardon, Joseph R.

**L.U. NO. 101
BALTIMORE, MD.**

Geipe, George R.
Hendrikse, John H.
Roosiorg, Hendrick
Windle, Brenty L.

**L.U. NO. 103
BIRMINGHAM, ALA.**

Hodge, B. R.
McGlothlan, Eugene

**L.U. NO. 128
ST. ALBANS, W. VA.**

Caldwell, Albert H., Sr.
Cobb, Charles A.
Hatfield, Erwin
McKee, James D.
Magaw, Cecil E.
Newcomer, Otis
Pullen, William Howard
Stevens, Louis E.

**L.U. NO. 129
HAZLETON, PA.**

Miller, Howard
Pfromm, John

**L.U. NO. 132
WASHINGTON, D.C.**

Feller, Glenn W.

McAnish, William
McDonald, Richard L.

**L.U. NO. 144
MACON, GA.**

Chambless, A. C.

**L.U. NO. 166
ROCK ISLAND, ILL.**

Petit, Harold

**L.U. NO. 181
CHICAGO, ILL.**

Bradley, Lars
Erickson, Fred

**L.U. NO. 183
PEORIA, ILL.**

Aupperle, Samuel
Bienemann, Herman
Bruington, Locke
Carlson, Eric
Dillon, Harry W.
Ford, Barton
Goldhammer, Wallace
Gualdoni, James R.
Helferrich, Homer
Hettler, Albert
Hill, James E.
Horn, John
Hoskinson, Richard
Hutson, Faros
Kneer, William
Krause, Albert
Logan, Raymond
Middleton, Charles
Molek, Frank
Olson, Olaf B.
Peppard, Howard
Shacklett, James
Schneider, William
Yerby, Frank

**L.U. NO. 188
YONKERS, N.Y.**

Connelly, James

**L.U. NO. 200
COLUMBUS, OHIO**

Roush, Harold

**L.U. NO. 201
WICHITA, KANS.**

Erway, H. O.
Sullivan, Flynn D.

**L.U. NO. 226
PORTLAND, ORE.**

King, Ralph L.
Walls, James G.

**L.U. NO. 242
CHICAGO, ILL.**

Fox, Michael
Kowalski, Joseph
Zuchowicz, Leonard

**L.U. NO. 246
NEW YORK, N.Y.**

Anderson, Alfred
Olson, Albin

**L.U. NO. 257
NEW YORK, N.Y.**

Bouchard, Ernest J.
Mackey, William L.
Tarpey, James Denis

**L.U. NO. 266
STOCKTON, CALIF.**

Hiner, George
Krieger, Elmer
Mullins, Albert
Odle, W. B.

**L.U. NO. 272
CHICAGO HEIGHTS,
ILL.**

Pavlik, John F.

**L.U. NO. 301
NEWBURGH, N.Y.**

Karamallis, George
Prange, Fred G.

**L.U. NO. 302
HUNTINGTON, W. VA.**

Klesky, Walter

**L.U. NO. 308
CEDAR RAPIDS, IOWA**

Kohl, Karl W.
Payn, Walter
Schellsmidt, C. E.
Schlesselman, Henry
Starns, Earl

**L.U. NO. 337
DETROIT, MICH.**

Asam, Edward
Garden, W. C.
Grant, Ellis H.
Jarrett, Ernest
McCormick, Leonard
Marshall, Herbert H.
Sexton, John S.
Swan, Thomas

**L.U. NO. 366
NEW YORK, N.Y.**

Marricco, Crescenzo

**L.U. NO. 416
CHICAGO, ILL.**

Barendt, William A.
Dawson, Philip
Dornbos, Peter
Dryden, Michael
Grabowski, Thomas
Gralak, Martin
Jeffries, William
Komen, Harry
Makush, Paul
O'Connor, Patrick
Voss, Fred
Wittol, John

**L.U. NO. 488
NEW YORK, N.Y.**

Anderson, Harold
Carlson, John A.

**L.U. NO. 492
READING, PA.**

Rettew, Paul

**L.U. NO. 562
EVERETT, WASH.**

Koukal, Thomas F.

**L.U. NO. 586
SACRAMENTO, CALIF.**

Beatie, John
Nelson, Carl A.
Parise, Joseph R.
Price, Paul G.
Santillano, C. C.
Trumbull, Rollin P.

Williams, Edwin J.
Younger, George A.

**L.U. NO. 608
NEW YORK, N.Y.**

Fitzpatrick, Joseph
Lepski, John
Mallardi, Peter
Sandalon, Richard
Sapienza, Chris
Serra, Frank
Shmagoris, Albin
Yellowley, Philip

**L.U. NO. 630
NEENAH & MENASHA,
WIS.**

Christian, Gareth

**L.U. NO. 688
PALO ALTO, CALIF.**

Titus, W. C.

**L.U. NO. 710
LONG BEACH, CALIF.**

Edwards, Carl D.
Erkkila, Emil E.
Purcell, Chester L.
Spencer, Stephen A.
Wise, Leonard M.

**L.U. NO. 721
LOS ANGELES, CALIF.**

Charles, Morris
DeBiasio, Fred
Dorward, W. G.
Grunwald, Joseph
Hayes, Thomas
Meyer, Frank
Herman, Paul
Morrison, David
Newman, Julius
Sausser, Carl
Turner, James L.
Wilcox, Marvin
Witkovic, William

**L.U. NO. 787
NEW YORK, N.Y.**

Andersen, Axel
Andersen, Einor
Christiansen, Andrew

**L.U. NO. 808
NEW YORK, N.Y.**

Antonelli, Angelo
Boyle, Hugh
Davey, Thomas
Falletta, Louis
Lynch, Philip
Milani, Zelindo P.
Torjesen, William
Zimmerman, Joseph

**L.U. NO. 845
CLIFTON HEIGHTS,
PA.**

Connolly, Alex
Evans, Daniel
Killen, George
Kisiel, Joseph

**L.U. NO. 848
SAN BRUNO, CALIF.**

Traeger, Louis
Wedell, Edward

**L.U. NO. 929
SOUTH GATE, CALIF.**

Allen, Earl

Akridge, Chris
Bunning, Joe C.
Jeffs, T. Irvine
Jones, James L.
Kennedy, Floyd R.
Simeon, Albert B.
Upright, E. S.

**L.U. NO. 937
DUBUQUE, IOWA**

Specht, Gerald

**L.U. NO. 971
RENO, NEV.**

Turner, Carl

**L.U. NO. 972
PHILADELPHIA, PA.**

Feltzer, David

**L.U. NO. 977
WICHITA FALLS, TEX**

Copelin, George H.

**L.U. NO. 982
DETROIT, MICH.**

Briggs, Arthur

**L.U. NO. 1048
McKEESPORT, PA.**

Brewer, William A.

**L.U. NO. 1065
SALEM, ORE.**

Braden, Hillis R. (Jack)

**L.U. NO. 1098
BATON ROUGE, LA.**

Ducote, James
Ferguson, C. E.
Hauptmann, W. A.
Lego, Eddie
McKinney, Paul J.

**L.U. NO. 1175
KINGSTON, N.Y.**

Ehrbar, George J.
Peyer, John D.

**L.U. NO. 1204
NEW YORK, N.Y.**

Forde, Darnell

**L.U. NO. 1265
MONMOUTH, ILL.**

James, Edward

**L.U. NO. 1332
GRAND COULEE,
WASH.**

Hanford, John
Wagner, Matt

**L.U. NO. 1367
CHICAGO, ILL.**

Andersen, Harold
Tomsheck, Clarence W.

**L.U. NO. 1394
FT. LAUDERDALE,
FLA.**

Greenwood, Kenneth R.
Lundberg, Niels

**L.U. NO. 1508
LYONS, N.Y.**

Sinkeldam, Cornelius

**L.U. NO. 1511
SOUTHAMPTON, N.Y.**

Berglin, Einar

IN CONCLUSION

Continued from Page 37

L.U. NO. 1599
REDDING, CALIF.
Donnelly, David W.

L.U. NO. 1644
MINNEAPOLIS, MINN.
Bittner, Edward C.
Elliott, Alva
Marjama, Emil
Quick, Alden
Sipe, Sylvester
Skowronek, John

L.U. NO. 1723
COLUMBUS, GA.
Bennett, Ralph T.
Carroll, A. F.
DuPriest, H. L.
Harrell, J. B.
Harris, L. L.
Head, H. E.
Hood, G. L.
Hood, Robert

L.U. NO. 1772
HICKSVILLE, N.Y.
Aase, Bjarne
Rapp, Steve

L.U. NO. 1846
NEW ORLEANS, LA.
Colombel, Stephen
Coulter, W. R.
Haley, Louis J.
Lucy, John
Mason, William T.
Yates, Carlton

L.U. NO. 1888
NEW YORK, N.Y.

Campbell, Stanley
Cray, Sidney
Lyons, Nehemiah
Mayers, James
Somme, Ferdinand
Waldron, Mortimer

L.U. NO. 1921
HEMPSTEAD, N.Y.

Carlson, Leonard
DeMarco, Philip
Ford, John
Hingul, Sam
Jorgensen, Olav
Kern, George
Kibitel, Mateius
Kjono, Emil
Larsen, Eric
McGowan, Robert J.
Marjanen, Knut
Palk, William
Schneck, Albert
Sheriff, Irving
Smith, James
Terho, Kusti
Tomins, Janis
Zalenski, Ben

L.U. NO. 2114
NAPA, CALIF.
Butler, Guy

L.U. NO. 2155
NEW YORK, N.Y.
Aliprantis, Antonios

Bocabella, Giuseppe
Carandanis, Constantin
Ceyka, Rudolph
DeCicco, Gustave
Dolgas, Charles
Epstein, Joseph
Grnese, Vincent
Hershkowitz, Harry
Interligi, Giuseppe
Jessen, Alex
Kaminsky, Abraham
Kassler, Joseph
Kucera, Anton
Lapof, Benjamin
Lustigman, Hersh
Modrovsky, Florian

Parrella, Anthony, Jr
Schneider, George
Simon, Deszo
Valenti, Salvatore
Weasen, Max
Zepel, Isidor

L.U. NO. 2224
RIDGECREST, CALIF.
Christiansen, Gordon A.
Hart, Clarence, Sr.
Hill, George W.
Williams, John C.

L.U. NO. 2391
HOLLAND, MICH.
Batjes, Maynard

Brink, Marinus

L.U. NO. 2536
PORT GAMBLE, WASH.

Hickey, Louis
Steenbock, Hans

L.U. NO. 3004
McCONNELLSVILLE,
OHIO

Jenkins, Thomas R.

L.U. NO. 3127
NEW YORK, N.Y.
Bauchens, Kenneth

Legacies of Long Service

The United Brotherhood joins with members of Local 633, Granite City, Ill., in calling attention to the legacy of more than six decades of service given our craft by Brother Ralph Greider, who died recently. He was 86 years of age.

We also pay tribute to the memory of Joseph Wallek, who joined Local 930, St. Cloud, Minn., on April 12, 1902, at the age of 21 and was a continuous member until his death at 89. He was not a charter member, but he joined the local union less than six months after the charter was issued on October 28, 1901.

Gottfried Burri, a member of Local 1703, Pann Yan, N.Y., passed away February 18, 1971. He would have celebrated his 53rd year as a member of the Brotherhood on March 7.

We Regret an Error

We recently listed the name of Edward Komula as a deceased member of Local 23, Dover, N.J. The name should have been William Komula. We extend regrets to family and friends.

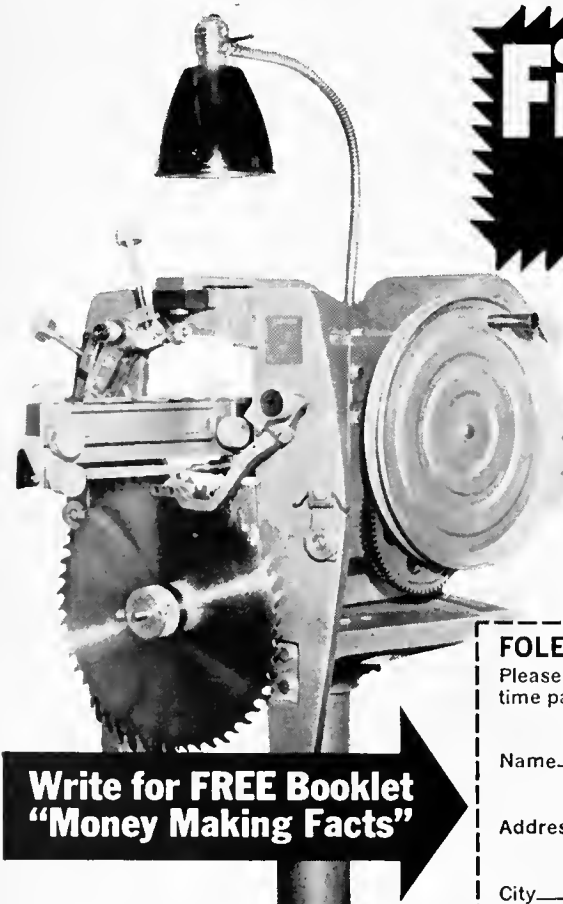

File Saws Easily AUTOMATICALLY

You don't need special training or previous experience to get perfect, sharp blades with the Foley Automatic Saw Filer. Operation is simple—you just follow easy step by step instructions. "The first saw I sharpened with my Foley Filer came out 100%," writes Clarence E. Parsons. This model is the first and only machine that precision files hand, hand and both "combination" and cross-cut circular saws. It's so mechanically accurate it's used by saw manufacturers! Takes minimum space in corner of shop.

Set up in Basement or Garage

Foley can show you how to establish your own saw filing service in your basement or garage. A small cash payment puts a new Foley Saw Filer in your hands. The profits you make easily handle the low monthly payments. Operating expense is low—only 7¢ for files and electricity to turn out a complete saw filing job. Mail coupon now for money-making facts and business-building ideas. No salesman will call.

FOLEY MFG. CO., 518-1 Foley Bldg. • Minneapolis, Minnesota 55418

Please rush free book, "Money Making Facts" and details on easy time payment plan.

Name _____

Address _____

City _____ State _____ Zip _____

**Write for FREE Booklet
"Money Making Facts"**



Lakeland News

Items of interest from the Brotherhood's retirement home at Lakeland, Florida

First from Baton Rouge



E. J. Ardoin, financial secretary of Local 1098, Baton Rouge, La., presents an expense check to Dewitt Simmons, 83 years old, before he leaves to enter the Carpenters Home in Lakeland, Florida. Brother Simmons, the first member from Local 1098 to enter the Home, arrived in Lakeland the first week in April, 1971.

INDEX OF ADVERTISERS

Audel, Theodore	36
Belsaw Power Tools	35
Chevrolet	13
Chicago Technical College	19
Craftsman Book Co.	31
Eliason Stair Gauge Co.	35
Estwing Manufacturing	28
Foley Manufacturing	38
Hydrolevel	31
Irwin Auger Bit Co.	23
Lee, H. D.	23
Locksmithing Institute	39
Miracle Instrument Co.	27
No. Amer. School of Drafting	39
Paneling Specialties	36
Rockwell Manufacturing	9
Stanley Works	Back Cover
Time Saver Tools, Inc.	22
Union Industries Show	17
Vaughan & Bushnell Mfg. Co.	16

Four Arrivals in March

John Fitze of Local 1596, St. Louis, Mo., arrived at the Home March 1, 1971.

Vaino Lahde of Local 1308, Lake Worth, Fla., arrived at the Home March 8, 1971.

Victor Warnquist of Local 135, New York, N. Y., arrived at the Home March 9, 1971.

Wm. R. Bennett of Local 211, Pittsburgh, Pa., arrived at the Home March 16, 1971.

Frank Beck of Local 133, Terre Haute, Ind., died March 2, 1971. Burial was at Terre Haute.

Herman Phillip of Local 12, Syracuse, N. Y., died March 2, 1971. He was buried in the Home Cemetery.

Ernest Laycock of Local 107, Worcester, Mass., died March 12, 1971. He was buried in the Home Cemetery.

Carl Borkgrevink of Local 971, Reno, Nev., died March 13, 1971. He was buried in the Home Cemetery.

Willard C. Garden of Local 337, Detroit, Mich., died March 13, 1971. Burial was at New Boston, Ohio.

William T. Bramel of Local 1108, Cleveland, Ohio died March 23, 1971. Burial was at Cleveland.

Jorn Cabiness of Local 211, Pittsburgh, Pa., died March 23, 1971. Burial was at Roanoke, Va.

Stanley Slawick of Local 1367, Chicago, Ill., died March 24, 1971. He was buried in the Home Cemetery.

Ray P. Newton of Local 1438, Warren, Ohio, died March 28, 1971. Burial was at Warren.

The remains of Oscar Ware, a non-resident, of Local 2396 Seattle, Washington, who died Feb. 7, 1971, in New Port Richey, Florida, were buried in the Home Cemetery.

You'll Like Being a SKILLED LOCKSMITH

You'll EARN MORE, LIVE BETTER than Ever Before in Your Life

You'll enjoy your work as a Locksmith because it is more fascinating than a hobby—and highly paid besides! You'll go on enjoying the fascinating work, year after year, in good times or bad because you'll be the man in demand in an evergrowing field offering big pay jobs, big profits as your own boss. What more could you ask!

Train at Home—Earn Extra \$\$\$\$ Right Away!

All this can be yours FAST regardless of age, education, minor physical handicaps. Job enjoyment and earnings begin AT ONCE as you quickly, easily learn to CASII IN on all kinds of locksmithing jobs. All keys, locks, parts, picks, special tools and equipment come with the course at no extra charge. Licensed experts guide you to success.

Illustrated Book, Sample Lesson Pages FREE

Locksmithing Institute graduates now earning, enjoying life more everywhere. You can, too. Coupon brings exciting facts from only school of its kind Lic. by N. J. State Dept. of Ed., Accredited Member, Natl. Home Study Council, Approved for Veteran Training.

LOCKSMITHING INSTITUTE
Div. of Technical Home Study Schools
Dept. 1118-051 Little Falls, N. J. 07424



Earned \$150 During Training
I realized with LOCKSMITHING I'd be able to double my income. During my training period I made \$150.
Paul Funes
New York, N.Y.



LOCKSMITHING INSTITUTE, Dept. 1118-051
Little Falls, New Jersey 07424 Est. 1948

Please send FREE illustrated Book—"Your Big Opportunities in Locksmithing," complete Equipment folder and sample lesson pages—FREE of all obligation—(no salesman will call).

Name.....
(Please Print)

Address.....

City.....State.....Zip.....

Check here if Eligible for Veteran Training

APPROVED VETERANS

These 3 BIG DRAFTING KITS GIVEN TO YOU!

when you train at home with NASD for a **HIGH PAY JOB IN DRAFTING!**

Take your pick of 1000s big salary jobs open to Draftsmen, U.S. Labor Dept. reports "42% more Draftsmen needed in next 10 years—not enough applicants to fill jobs available now." Easy home-study plan has helped 100s beginners toward \$\$\$\$\$. security, prestige as Draftsmen—many with only grade school training. Others report good earnings drafting part time while still learning. Why not you?

RUSH COUPON FOR FREE KIT!

Mail coupon for FREE "DRAFTING CAREER KIT," Sample Lesson, Drafting Aptitude Test including new 5-Way Drafting Instrument & 20-Page Book, "Your Future in Drafting" — ALL FREE. No salesman will call. G.I. Bill approved. Write today.

NORTH AMERICAN SCHOOL OF DRAFTING, Dept. 11465
4500 Campus Drive, Newport, California 92660

Rush "DRAFTING CAREER KIT," including Book, Sample Lesson, Aptitude Test & Drafting Instrument—**ALL FREE!**

NAME.....AGE.....

ADDRESS.....

CITY.....STATE.....ZIP.....



In Conclusion

M. A. Hutcheson, *General President*



If Hard Hats Stand For Hard-Working Old-Fashioned Patriotism, So Be It

■ The 1971 Legislative Conference of the Building and Construction Trades Department was the biggest and probably the most enthusiastic in history.

Certainly, this was a natural outgrowth of events of the past few years. Over the past decade, no segment of our society has been treated to more criticism, condemnation, and belittlement than the building trades.

Within the last few years, the term "hard hat" has been applied to construction workers. For my part, I believe it is a very appropriate name, and I think we should all answer to it proudly.

However, the press and television have, by innuendo, attached something demeaning and brutal to the name. Why? Because a few construction workers in New York, goaded beyond endurance by the sight of unwashed, uncombed, unkempt young rebels desecrating a flag so many fought to protect in World War II, reacted in a very human way. They used their fists, fists calloused by honest work, fists used to paying taxes and saluting the flag.

The instances of rebels burning college campuses, taking over administrative offices, and bombing public buildings, run into the thousands. But the news media mostly picture these acts of violence as the work of sensitive, concerned (although probably misguided) young men and women.

On the other hand, the construction workers who on one or two occasions got carried away by old-fashioned patriotism are characterized as brutal,

insensitive, and stupid. It is the same all the way down the line. If there is something wrong, the hard hats are culprits.

Somehow or other, the building trades, which actually have done more to place minority youngsters in decent paying jobs than any other group, are pictured as being responsible for most of the unemployment among ghetto youths.

Mister Nixon branded construction workers as being the major cause of inflation in construction costs, although total labor costs make up only a small percentage of the cost of any structure.

So it goes.

At the opening of the 1971 Legislative Conference, Frank Bonadio, Secretary-Treasurer of the Department, said that the Building Trades Unions come together most effectively when they are threatened by outside forces. I sincerely hope this is true, because the crafts are being attacked as never before.

Between a President who seemingly has little respect for blue-collar workers, minority groups which are determined to break down the whole concept of apprenticeship training, and a press that pictures construction workers as feather-bedding millionaires, the need for solidarity is unprecedented.

To me, it all adds up to one thing. We in the building trades need to mobilize our political strength more effectively than we ever have before. It is in the political arena that most of our future battles lie. ■

Here Are Ideal Father's Day Gifts



OFFICIAL LABEL EMBLEM

Clutch back. Attractive small size. Rolled gold.

\$2.00 each

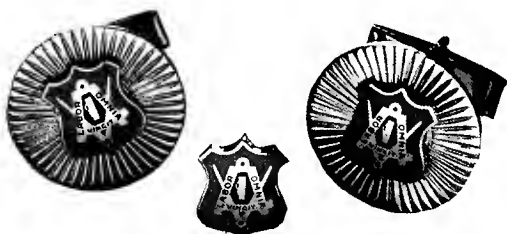

CUFF LINKS AND TIE TACK

Beautiful set with emblem. Excellent materials and workmanship.

Set, **\$3.50**



EMBLEM RING

This handsome ring has been added to the line of the Brotherhood's official emblem jewelry. It may be purchased by individuals or by local unions for presentation to long-time members or for conspicuous service. Gift boxed. Specify exact size or enclose strip of paper long enough to go around finger.

Available in 10k gold, **\$30** each.

Sterling silver, **\$21** each.



He'll Wear Them with Pride

The official emblem of the United Brotherhood of Carpenters and Joiners of America is displayed in full color on the jewelry shown at left. Such bright and attractive articles are a good way for Dad to show membership in our Brotherhood. He'll wear them with pride on special occasions. . . .

And he can be doing that on Father's Day, 1971, if you place your order right away.

The materials used in the official jewelry and their workmanship are strictly first-class. There is a continuous demand for these items—especially as birthday gifts, as Christmas gifts, and as gifts for Father's day.

You'll please the father in your life next June 20 (That's Father's Day, 1971), if you mail in your order now.

Please print or type orders plainly. Be sure names and addresses are correct, and that your instructions are complete.

Send order and remittance to:

R. E. LIVINGSTON, General Secretary
 United Brotherhood of Carpenters and Joiners of America
 101 Constitution Avenue, N.W., Washington, D. C. 20001

What makes the Stanley PL320 your kind of rule?

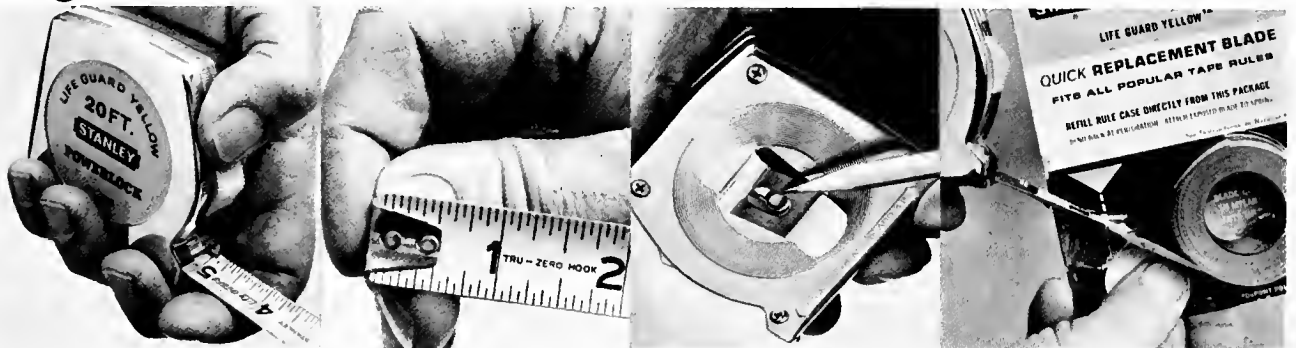

The exclusive Stanley POWERLOCK® locks on the blade, not the drum. This eliminates slip in either direction – positively prevents creep.

“True zero” hook adjusts automatically to precisely measure outside areas or harder-to-get-at interiors. Underside of hook is serrated to grip work, keep blade from slipping.

Back of your PL320 features a clip that snaps tightly over belt or apron pocket. It helps make sure you always have your rule handy – lessens chance of loss or theft.

Lifeguard® Yellow blade takes tough use. But if you ever have to replace one, get a refill – do it on the job, in seconds! No need to send the whole rule back to the factory.



Don't settle for anything less than the best, time-tested tools. Stanley has been known for excellence in hand tools for over a century. Buy the tool that makes a difference. Stanley. Stanley Hand Tools, Division of The Stanley Works, New Britain, Connecticut 06050.

STANLEY
helps you do things right

P.S. Made by the same Stanley that makes the finest power tools.

The

JUNE 1971

CARPENTER

Official Publication of the UNITED BROTHERHOOD OF CARPENTERS AND JOINERS OF AMERICA • FOUNDED 1881



OFFICIAL INFORMATION

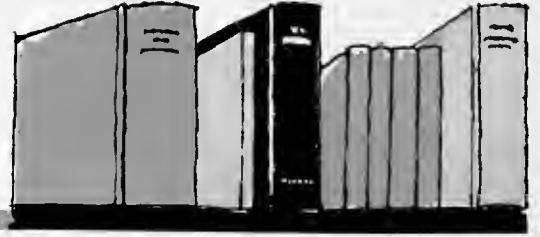

GENERAL OFFICERS OF THE UNITED BROTHERHOOD of CARPENTERS & JOINERS of AMERICA

GENERAL OFFICE:
101 Constitution Ave., N.W.,
Washington, D. C. 20001

GENERAL PRESIDENT

M. A. HUTCHESON
101 Constitution Ave., N.W.,
Washington, D. C. 20001

FIRST GENERAL VICE PRESIDENT

WILLIAM SIDELL
101 Constitution Ave., N.W.,
Washington, D. C. 20001

SECOND GENERAL VICE PRESIDENT

HERBERT C. SKINNER
101 Constitution Ave., N.W.,
Washington, D. C. 20001

GENERAL SECRETARY

R. E. LIVINGSTON
101 Constitution Ave., N.W.,
Washington, D. C. 20001

GENERAL TREASURER

PETER TERZICK
101 Constitution Ave., N.W.,
Washington, D. C. 20001

DISTRICT BOARD MEMBERS

First District, **PATRICK J. CAMPBELL**
130 North Main Street
New City, Rockland Co., New York
10956

Second District, **RALEIGH RAJOPPI**
2 Prospect Place, Springfield, New Jersey
07081

Third District, **WILLIAM KONYHA**
1830 Ledge Rd., R.D. No. 4
Medina, Ohio 44256

Fourth District, **HAROLD E. LEWIS**
340 Northwest 148th St.
Miami, Florida 33168

Fifth District, **LEON W. GREENE**
2800 Selkirk Drive
Burnsville, Minn. 55378

Sixth District, **FREDERICK N. BULL**
P.O. Box 14279
Oklahoma City, Okla. 73114

Seventh District, **LYLE J. HILLER**
Room 722, Oregon Nat'l Bldg.
610 S.W. Alder Street
Portland, Oregon 97205

Eighth District, **CHARLES E. NICHOLS**
Forum Building, 9th and K Streets
Sacramento, California 95814

Ninth District, **WILLIAM STEFANOVITCH**
2418 Central Avenue
Windsor, Ontario, Canada

Tenth District, **GEORGE BENGOUGH**
2528 E. 8th Ave., Vancouver 12, B. C.

M. A. HUTCHESON, *Chairman*
R. E. LIVINGSTON, *Secretary*

Correspondence for the General Executive Board
should be sent to the General Secretary.



Secretaries, Please Note

If your local union wishes to list deceased members in the "In Memoriam" page of *The Carpenter*, it is necessary that a specific request be directed to the editor.

In processing complaints, the only names which the financial secretary needs to send in are the names of members who are NOT receiving the magazine. In sending in the names of members who are not getting the magazine, the new address forms mailed out with each monthly bill should be used. Please see that the Zip Code of the member is included. When a member clears out of one Local Union into another, his name is automatically dropped from the mail list of the Local Union he cleared out of. Therefore, the secretary of the Union into which he cleared should forward his name to the General Secretary for inclusion on the mail list. Do not forget the Zip Code number. Members who die or are suspended are automatically dropped from the mailing list of *The Carpenter*.

PLEASE KEEP *THE CARPENTER* ADVISED OF YOUR CHANGE OF ADDRESS

PLEASE NOTE: Filling out this coupon and mailing it to the **CARPENTER** only corrects your mailing address for the magazine. It does not advise your own local union of your address change. You must notify your local union by some other method.

This coupon should be mailed to ***THE CARPENTER***,
101 Constitution Ave., N.W., Washington, D. C. 20001

NAME _____ Local No. _____

Number of your Local Union must be given. Otherwise, no action can be taken on your change of address.

NEW ADDRESS _____

City

State

ZIP Code

THE
CARPENTER

VOLUME XCI

No. 6

JUNE, 1971

UNITED BROTHERHOOD OF CARPENTERS AND JOINERS OF AMERICA

Peter Terzick, Editor



I N T H I S I S S U E

NEWS AND FEATURES

The Export of American Jobs Must be Curbed 2
 An Old-Fashioned Barn Raising 4
 Union Industries Show is Stellar Attraction in Atlanta, Georgia ... 6
 Guideline Settlement with Fleetwood Enterprises 9
 Labor Secretary Denies Ceiling on Craft Pay Increases 10
 Bonadio Succeeds Haggerty at BCTD 10
 Georgine Named BCTD Secretary 10

DEPARTMENTS

Washington Roundup 11
 Local Union News 12
 Service to the Brotherhood 15, 16, 27, 31
 Canadian Report Morden Lazarus 18
 Apprenticeship and Training 22
 Your Union Dictionary 24
 Plane Gossip 26
 We Congratulate 28
 CLIC Report 32
 Outdoor Meanderings Fred Goetz 34
 In Memoriam 36
 What's New? 37
 Lakeland News 38
 In Conclusion M. A. Hutcheson 40

THE COVER

The experienced carpenter, cabinet-maker, and millman can almost smell the rich scent of the log on our June cover. It's the exposed crosscut of a Western Cedar, felled near Aloha, a small community in the vicinity of Aberdeen, Washington.

In the background of our cover picture the tree-covered slopes of the Coastal Range loom blue-green in late afternoon sunlight. It's a simple picture . . . one which warms the hearts of those who work with wood, who like to feel the grain and hear the rasping cut of a saw or the slivering sound of a plane at work.

Here the work of the Brotherhood member begins—in the picturesque, vibrant and living forest, where lumbermen move the raw building material to the mills. Logs are cut to boards and kiln dried, graded, and moved to wholesalers and retailers.

Finally, it reaches the skilled craftsman, who turns it into a house, a cabinet, a bridge, or any number of amazing creations.

Almost half of the lumber production in the United States is centered in the Pacific Northwest. Approximately 18 billion board feet of lumber come out of the area each year. The cutting of cedar has more than doubled since 1950, and its use continues to increase at a steady pace.

The cover picture is supplied by the Evans Products Co. of Portland, Oregon, and is used with permission.

THE
CARPENTER

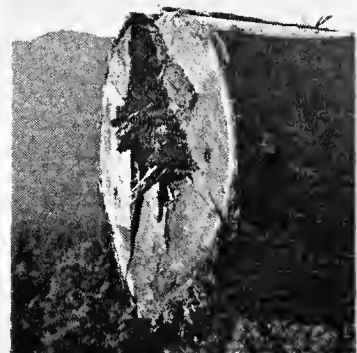

POSTMASTERS, ATTENTION: Change of address cards on Form 3579 should be sent to THE CARPENTER, Carpenters' Building, 101 Constitution Ave., N.W., Washington, D. C. 20001

Published monthly at 810 Rhode Island Ave., N.E., Washington, D. C. 20018, by the United Brotherhood of Carpenters and Joiners of America. Second class postage paid at Washington, D. C. Subscription price: United States and Canada \$2 per year, single copies 20¢ in advance.



Printed in U. S. A.

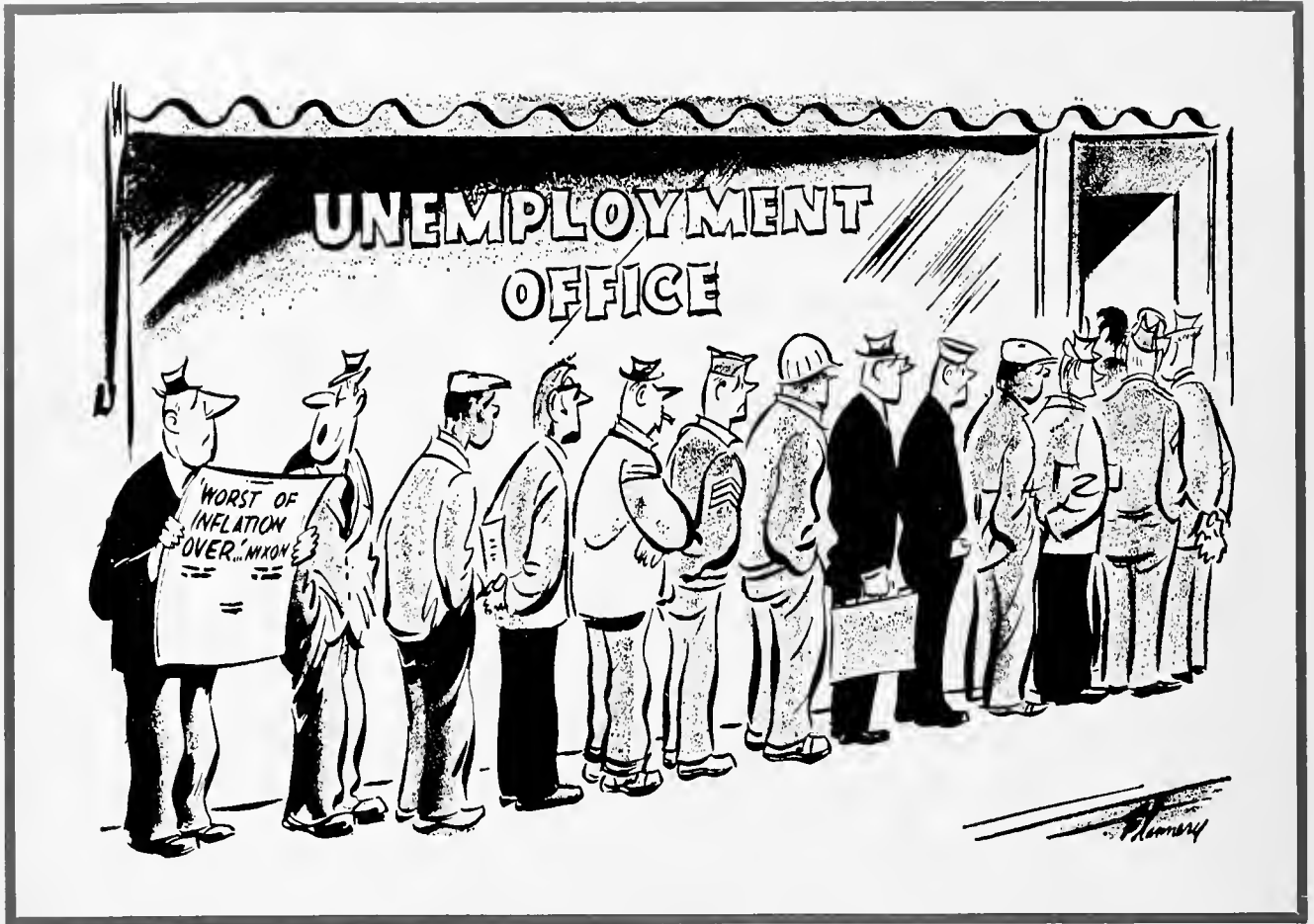

The Export of American Jobs Must Be Curbed

■ This month millions of high school and college graduates are out "pounding the sidewalks" in a quest for jobs.

They join the 6.1% of the employable population already scanning the classified ads and haunting the union halls for work.

In a critical time like this, the heads of many U.S. corporations are ignoring the needs of their fellow citizens and taking their company's jobs overseas, often, to areas like Hong Kong and Taiwan, where people work for a pittance of what the average American needs for his livelihood.

The situation has become so critical that organized labor, last month,

called for a Congressional investigation of low-wage imports, foreign investments, and runaway plants.

In a series of statements, the AFL-CIO Executive Council called for new international trade and investment legislation and U.S. Government action to "curb the mounting displacement of U.S. production and export of American jobs."

Investigation Asked

The Council also urged "an early and thorough Congressional investigation of the recent international speculation against the American dollar, including the activities of American-owned international companies and banks, and the profits

they made from undercutting their nation's currency."

Almost immediately Rep. Wright Patman (D-Tex.) informed Meany that he was putting the entire statement in the Congressional Record and that he was opening hearings on May 24th beginning the recommended investigation.

In calling for new international trade and investment legislation, the Council proposed nine areas for Congressional action:

1. New tax measures to halt the export of U.S. jobs, removal of the incentive to establish production and assembly facilities abroad, and creation of tax "disincentives" to curb expanded production abroad.

Hearings scheduled in Washington, as labor protests runaway investments abroad and growing power of multi-national corporations

"Profits earned by the foreign operations of U.S. corporations should be taxed at the time they are earned," the Council said. Under present law, the statement said, corporations are permitted to defer U.S. taxes which ultimately are never paid.

2. Legislative action to "give the President authority to regulate, supervise and curb the outflow of U.S. capital"

3. A reversal of U.S. policy which "has encouraged the export of technology in recent years"

4. Adoption of international labor standards.

5. Machinery to avoid the continued displacement of U.S. production, tax-base erosion, market disruption and export of American jobs by "quantitative restraints"

6. Truth-in-Labeling on world products.

7. Strict conformity to all laws designed to protect the health and safety of the American consumer on all imports.

8. Establish and enforce federal standards for international accounting by U.S. firms with foreign operations.

9. More effective anti-dumping legislation.

In another resolution blasting the export of production and jobs, the Council said that "such programs are a mockery of international development and goodwill," noting that "policies to subsidize profit greed at public expense destroy labor's goals of better living standards and working conditions in the U.S. and every other nation."

20 Cents An Hour

The statement dealt in-depth with the movement to "lure U.S. firms to use low-wages paid to these workers, the Council said, which often range as low as 20 cents an hour to 46 cents an hour.

In 1967 there were 30 U.S. com-

panies operating plants on the Mexican border. The number reached 219 last year and 250 at the present.

"U.S. owned plants on the Mexican side of the border receive special tax and tariff breaks from the Mexican Government, including exemption for its tight controls on foreign trade," the Council said.

Not only do these firms pay substandard wages to assemble components from the U.S. into final products for export to U.S. markets, the Council said, but these goods usually come into the United States under the special tariff duties and are sold at American prices.

The Council declared that the Mexican Government is now stepping up its campaign to lure U.S. firms to the interior of the country. In addition to those firms on the

border, there are now at least 500 manufacturing subsidiaries of U.S. companies in the interior of Mexico.

"The extension of the Mexican Government's program of tax and other incentives for the production of goods for export presents American workers and trade unions with the immediate threat of a rising flood of imported goods, produced at substandard wages and with various Mexican Government benefits," the statement added.

Noting that the "export of American jobs and displacement of U.S. production is escalating at a tremendous pace," the Council urged a number of U.S. Government actions. In addition to the nine-point program listed above, it included revision of the tariff laws to eliminate the loopholes. ■

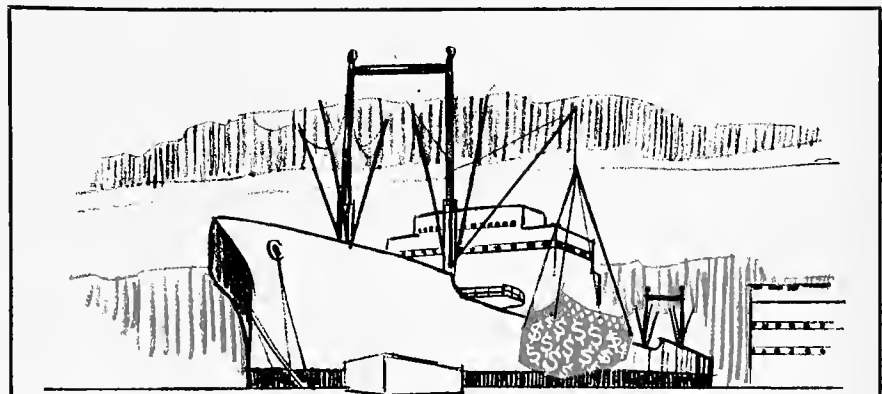

How U.S. Dollars Abroad Cost U.S. Jobs At Home

The so-called dollar "crisis" has served to dramatize how mounting American investment abroad creates thousands of jobs in other countries but does little to put Americans on payrolls.

President Harold S. Geneen of the huge International Telephone and Telegraph Corporation, which has millions of investments abroad, perhaps unconsciously revealed the story at a stockholders meeting. Geneen, who wants foreign capital to invest in the United States as U.S. capital invests in other countries, said proudly that of its total of 210,000 jobs overseas, only 264 are filled by Americans.

That is .00125 percent for the American payroll and .99875 percent for the foreign one. (PAI)

AN OLD FASHIONED BARN RAISING

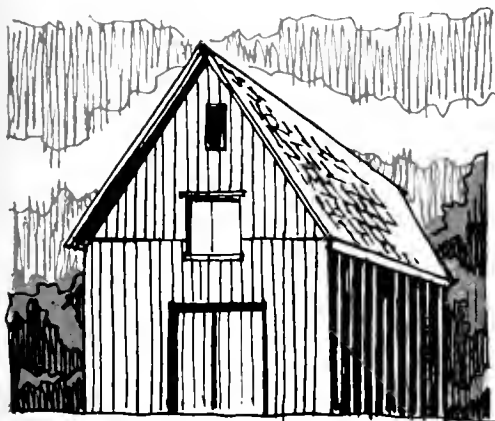

■ Old Bethpage Village is located just off Round Swamp Road on the border between Nassau and Suffolk counties, Long Island, N.Y. In the early 1800s it was a busy community. But time took its toll, until local citizens began raising funds to restore it . . . building by building and landmark by landmark.

Last month, with the help of skilled Brotherhood craftsmen from Locals 1772 and 357, a barn was raised in Old Bethpage Historical Park. It had been taken numbered piece by numbered piece from a farm at Carlisle, N.Y., and was now reassembled with blocks and tackle, mortise and tendon on a site in the park. Not a nail was used. Only one small strip of the hand-hewn, century-old timbers had to be replaced. The E. W. Howell Company of Babylon, N.Y., was general contractor. Business Representative Glenn Kerbs of Local 1772 arranged the work team. ■



The first section (called a bent) weighed 2½ tons and required sturdy backs to pull into place. Note pre-stacking of bents.

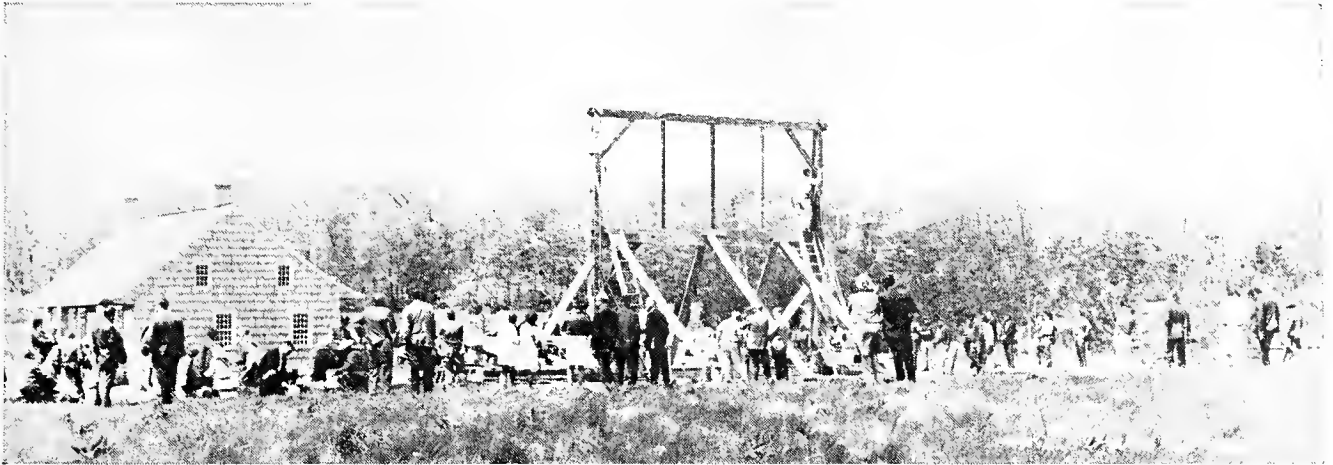

A long view of the erection site, showing workers, advisors and spectators. The first upright unit is in position.

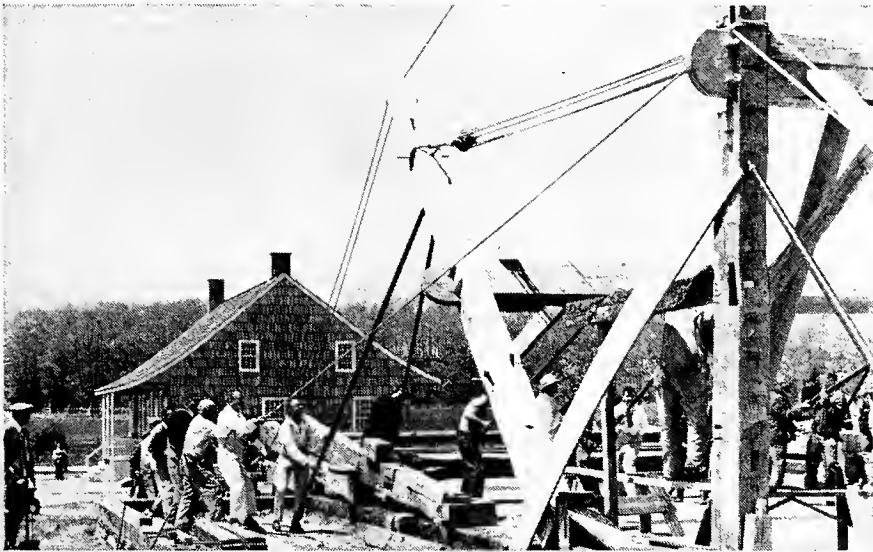

More progress. The barn was raised on a 38-by-40-foot base. Height: 25 feet.

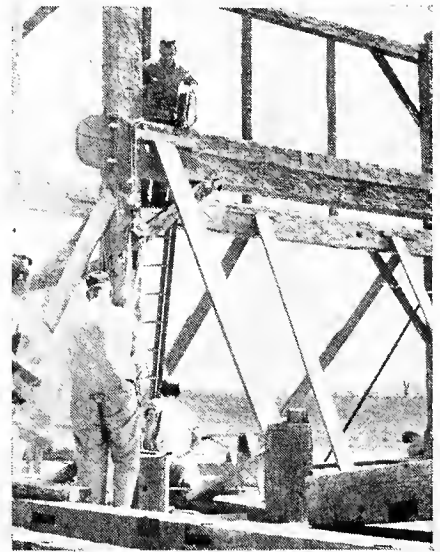

Brotherhood members loosen lashings.

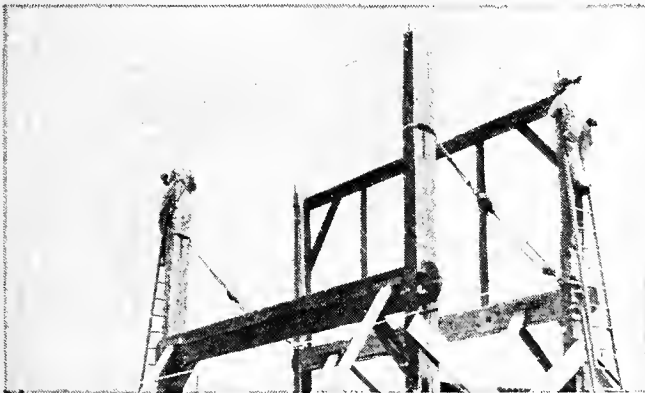

Another upright section is up. Chocks and lashings kept footings of the bents in place as ropes pulled them into position.

Right: The long framework nears completion. Siding followed.

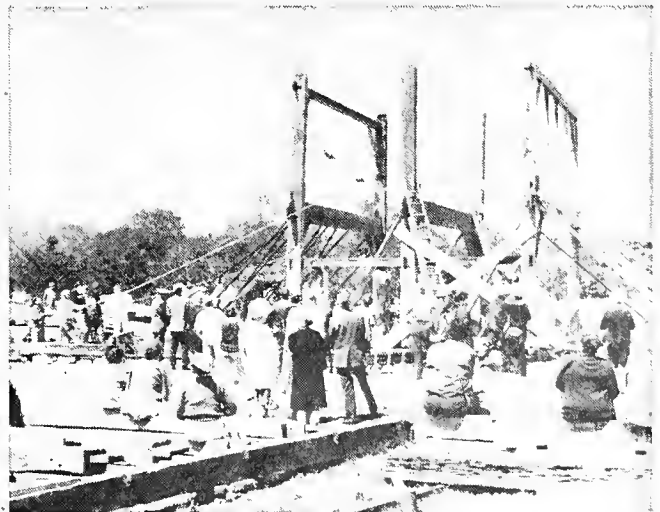

Left: Some of the men who raised the barn: E. W. Howell, general contractor, E. W. Howell Co.; Babylon, N.Y.; John Kurka, Local 357, Islip, N.Y., foreman; Alfred Brand, Local 1772; Frank Rossetti, Local 1772; Donald Collins, Local 1772; Charles Kurka, Local 357; Vincent Franco, Local 1772; Walter Godeski, Local 1772; and Edwin Fungeld, Local 1772, job steward. Back row, from left: James Fairchild, project manager, Old Bethpage Village Restoration; John Rosenstrom, business agent, Nassau District Council; Eugene Hartigan, president, Nassau District Council; and Glenn Kerbs, business representative, Local 1772.





UNION INDUSTRIES SHOW IS STELLAR ATTRACTION IN ATLANTA, GEORGIA

■ As you may remember, Scarlett O'Hara went into the lumber business on the outskirts of Atlanta, Georgia, about a hundred years ago.

According to her fellow Georgian, Margaret Mitchell, she made a big success of her second husband's business, selling building materials and hardware to the Carpetbaggers and the Scallywags who followed on the heels of General Sherman.

There's no Scarlett O'Hara in Atlanta today . . . except for a night spot by that name in a tourist center called Atlanta Underground.

But Atlanta is rising again . . . like the rest of the South . . . and the building materials and building trades are rising with it.

Six Brotherhood locals in the Georgia capital joined with the International Union last month to tell all about it at the 1971 AFL-CIO Union Industries Show in Atlanta

Civic Center. They presented a big display of union label goods and services in a string of show booths extending 90 feet down two wide aisles.

And almost a quarter million show visitors took it all in . . . reminded once again that organized labor is the best hope of the nation's working population.

The Brotherhood exhibit was truly a labor-management arrangement, in the best traditions of the show. In addition to displays of apprentice work, journeymen benefits, and the like, there were cooperative displays by union label manufacturers and contractors. The Concrete Pile Division of Raymond International displayed pictures of projects and miniature piles of many types. Micarta products by Westinghouse and GAF floor products got attention. Custom Creations, Inc. of Atlanta, a union

shop which installed exhibits throughout the show, exhibited its own skills in a Brotherhood booth. Other exhibitors included: Remington Industrial Equipment and Construction Tools, Troy E. Hardin and Associates (health and welfare plan administrators and consultants), Southern Machinery Erectors, Inc., and the Georgia Acoustical Contractors Assn., with a display of Muro II partitions designed by McElroy and Hardy, Inc.

A display which interested many visitors was an educational model of building construction created by students of the Atlanta Joint Apprenticeship and Training Committee and their leaders. The unit was prepared by John Miles, director of education, Wayne Mackie, George Simpkins, Michael Vitro, and Instructor Jack Garrett.

Continued on page 8

Four General Officers of the Brotherhood were on hand as the 1971 AFL-CIO Union Industries Show opened in Atlanta May 14. They are shown at right in the central booth of the Brotherhood exhibit. From left: General President M. A. Hutcheson, General Secretary R. E. Livingston, General Treasurer Peter Terzick, and General Executive Board Member Harold Lewis. Atlanta is in Lewis's home district.



Dressed in light blue jackets with the Brotherhood emblem over each left pocket were four Atlanta leaders who joined General President Hutcheson at the opening of the show. They included, from left: Sam Weldon and J. F. Cross of Carpenters Local 225; and, to the right of the General President, J. L. Cooper, business representative of Millwrights Local 1263; and International Representative Robert J. Ellis.



Prepared to meet early show visitors were: From left, H. D. Cross, ass't. BR. Local 225; J. W. Prewitt, Jr.; General President Hutcheson; and Raymond Pressley, BR, Local 225.



Assembled with the General President as the Union Industries Show opened were, from left: Int'l Rep. Robert J. Ellis; Sam Weldon, coordinator of fringe benefits, Local 225; J. F. Cross assistant BR, Local 225; Bob Mabry, secretary, Ga. State Federation; Gen'l Rep. James Brown; Gen'l Pres. Hutcheson; W. L. Worley, Fin. Sec. and BR, Local 225; Gen'l Sec. R. E. Livingston; Luke S. Pinyan, BR, Local 225; Peter Terzick, General Treas.; Int'l Rep. Strickland; and GEB Member Harold Lewis.





Show visitors were intrigued by the silhouette cutouts produced by representatives of the Atlanta Carpenter Joint Apprenticeship and Training Committee. Spectators were invited to sit in front of

¼-inch plywood boards, as booth attendants outlined their silhouettes, as projected by a bright light. John Miles, educational director, checks a sketch at upper left. Another member cuts a sil-

houette by sabre saw at center. At upper right, Mrs. Wanda Dukes, secretary to the JAC director, and Miles study a finished silhouette before presenting it to a lucky Brotherhood-booth visitor.



Two Atlanta members turn decorative pieces on a wood lathe, demonstrating their skill in one booth at the Union Industries Show.

A general view of the crowd down one aisle of the busy, six-day show. This year's show was the biggest in its 33-year history, according to unofficial early reports.



Continued from page 6

Models of columnar construction which were created by Michael Weldon, Howard Stanley, and David Kendrick were displayed.

Thousands of pencils, rulers, and pocket calendars, bearing Brotherhood messages were given away to show visitors. Savings bonds were won in periodic drawings during each day of the six-day exposition.

Unionization of the South was convincingly dramatized by this show.

John E. Wright, president of the Atlanta Labor Council, expressed this at a pre-show luncheon when he declared:

"Last year the show was in New Orleans. This year we are proud to have it in Atlanta. It demonstrates for the nation and those in the South that the labor movement is now solidly in the southern states.

"Despite the hopes of our opponents, the labor movement is not going to go away from the South and leave the fate of southern workers to those who would exploit them."

AFL-CIO President George Meany called the 1971 show "an outstanding example of labor—management cooperation." He cut the ribbon which opened the big show on May 14.

The 1971 show was the biggest in its 33-year history with a record 300 exhibitors. ■

Guideline Settlement Opens Way to Working Agreements at Nine Fleetwood Enterprises Plants

*Members return to work, as production and sales
of mobile and modular homes move into high gear*

■ After many months of seemingly fruitless negotiations with Fleetwood Enterprises—one of the nation's largest mobile home manufacturers—the United Brotherhood's hardworking bargaining team, last month, arranged a guideline settlement, and local contracts have been drawn up and approved at most of the plants certified.

The settlement offered a breakthrough in negotiations which threatened to evolve into a nationwide boycott of Fleetwood products.

Participants in the negotiations decided last winter to hold a top level meeting before proceeding further with either strike or boycott plans. The concept of such a meeting had the full endorsement of the Brotherhood's national negotiating team appointed by General President M. A. Hutcheson. That team consisted of Southern States Director of Organizing James A. Parker and West Coast Director of Organizing Kenneth M. Davis.

The first top level meeting was held on March 22, 1971, at Los Angeles, Calif. Brotherhood participants included First General Vice President William Sidell, National Director of Organizing Anthony Ochocki, and James Parker. The company was represented by Executive Vice President Jack E. Dahl, Secretary and General Counsel Hugh Scallon, and Director of Industrial Labor Relations Ken Palmer.

The following plants were under certification at that time: two plants at Waco, Tex.; and plants at Hagerstown, Md.; Westmoreland, Tenn.; Macomb, Ill.; Woodland, Wash.; Riverside, Calif.; Anaheim, Calif.; and a plant of the Deluxe Homes Division at Quincy, Mich. Unfair-labor-practice strikes were in effect at all of these plants except the ones at Quincy, Mich., and Hagerstown, Md.

Sufficient progress was made at the Los Angeles meeting to warrant further talks, and another meeting was held March 29 at Brotherhood Headquarters in Washington, D.C. This meeting resulted in consummation of a Memorandum of Agreement which established a framework

under which all outstanding issues between the parties could be resolved by local negotiations.

Some meetings are still being held to resolve minor differences, but, generally speaking, all is settled.

Members are returning to work as quickly as possible, and production and sales are beginning to mount.

With all local agreements signed and ratified, all unfair labor charges pending will be dropped.

"We are looking forward to the establishment and continuance of an amicable collective bargaining relationship with this company in the future," commented Director of Organizing Ochocki, in reporting the settlement. ■





Frank Bonadio speaking to the recent BCTD Legislative Conference held in Washington, D.C., last April.

Bonadio Succeeds Haggerty at BCTD

C. J. Haggerty has retired as president of the AFL-CIO Building & Construction Trades Dept. and will be succeeded by Frank Bonadio, the department's veteran secretary-treasurer.

Haggerty served as president since 1960—"with excellence and distinction," the department's executive council said in accepting with "reluctance" his decision to retire for reasons of health.

The department leaders praised Haggerty's "notable service to the American labor movement for more than half a century" and proposed that the BCTD convention in November name him president-emeritus.

Bonadio, elected to fill out Haggerty's term of office, is a vice president of the Sheet Metal Workers, a former officer of the Baltimore Building & Construction Trades Council, and a former international representative of his union. He is a native of Pittsburgh, Pennsylvania.

He was elected secretary-treasurer of the Building & Construction Trades Dept. in 1954. For four years he served as a member of the National Joint Board for the Settlement of Jurisdictional Disputes.

Haggerty took out his card in the Lathers in Boston in 1915, but he moved to California in 1921 and rose to head the state's labor movement during the period of its greatest growth.

He was elected business manager of his Lathers local in Los Angeles in 1928, and an international vice president a year later. He became secretary of the Los Angeles Building & Construction Trades Dept. in 1933 and president of the California State Federation of Labor in 1937.

In 1943, Haggerty was elected secretary-treasurer of the state federation.

Labor Secretary Hodgson Denies Ceiling on Craft Pay Increases

The Construction Industry Stabilization Committee is not limiting all wage increases in building trades contract settlements to 6 percent a year, Labor Sec. James D. Hodgson emphasized at a special news briefing.

Although he denied that the committee had set a specific limit on construction wage settlements, Hodgson conceded that the committee was working toward bringing the wage increases to the 6 percent range—possibly by 1973.

Hodgson pointed out that two criteria were established by the stabilization panel in dealing with wage contracts. One has been recognized as the 6 percent wage limit. The other covers inequities that may exist in certain situations and allows for adjustments beyond the 6 percent level.

"The 6 percent is not etched in concrete," Hodgson told reporters. But he said that the press had misinterpreted Pres. Nixon's Executive Order as setting a 6 percent guideline for wage increases in construction.

The Secretary said the Administration set no specific "target" for wage increases. He said the objective was not to hold wage increases in a certain range, but to bring them "somewhat lower than the 16 percent" settlements before the stabilization committee was established.

He noted that the stabilization committee has reviewed "10 or 12" contract agreements so far. All have been approved.

The settlements provide for wage increases of up to 13 percent a year, with a "large cluster" in the 6 to 9 percent range, Hodgson reported.

Hodgson stressed that the "stabilization plan was never intended to apply fixed criteria or a figure to all wage increases in the industry."

But he also noted the plan was intended "to retard the level of negotiated increases and the level of strikes."

"Only time and decisions of the stabilization committee will determine the amount of the intended retardation," Hodgson added.

Georgine Named To Secretary Spot

Robert A. Georgine, hard working 39-year-old president of the Wood, Wire and Metal Lathers International Union, has been named secretary-treasurer of the AFL-CIO Building and Construction Trades Department, succeeding Frank Bonadio, who moved up to the presidency.

Georgine was selected for the position by the BCTD executive council, last month. He must subsequently stand for election at the department's biennial convention next November.

The new secretary-treasurer was elected to the presidency of the Lathers' international union at its convention in Vancouver, B.C., last August, succeeding Sal Maso.

He was apprenticed to the lathers' trade in 1949 and became a member of Lathers Local 74, Chicago, in 1953. He has been a journeyman, foreman, and served Local 74 in every major office. He has been financial secretary of the Illinois State Council of Lathers, business manager of the White City District Council, and a member of the board of governors of the National Bureau for Lathing and Plastering.

After serving as an international representative since 1964, Georgine was named by the BCTD to the National Joint Board for the Settlement of Jurisdictional Disputes. He is also co-chairman of the National Lathing Industry's Joint Apprenticeship Program and chairman of the General Pension Fund and General Pension Plan.

He has studied at the University of Illinois and DePauw University. A veteran of two years of U.S. Infantry service during the 50s, he is married and the father of four children.



Bob Georgine, new secretary-treasurer of the BCTD, conducting a recent meeting.

WASHINGTON ROUNDUP

WAGE GAINS AVERAGE 8.4—Major collective bargaining settlements won by unions during the first three months of 1971 contained wage increases averaging 8.4 percent over the life of the contract, the Bureau of Labor Statistics reported.

The average was higher than the 7.7 percent figure recorded in the first quarter of 1970 but lower by one-half of 1 percent than the average increase for all of 1970, the Labor Dept. Agency said.

The BLS said only five major settlements covering 14,000 workers were reported in construction. Last year, relatively large settlements for nearly 700,000 construction workers contributed heavily to the slightly higher nonmanufacturing average for 1970—11.5 percent—according to the BLS.

Adding fringe benefits to wages, the average rate of increase this year to date was 8.5 percent as against 9.1 percent for all of 1970. First-year changes considered alone averaged 10.5 percent in the first quarter of 1971 against 13.1 for all of 1970.

UNEMPLOYMENT TROUBLE SPOTS—The number of major labor areas in the United States with substantial unemployment rose to 52 in April, the highest level since May 1962, the Labor Dept. reported.

The term "substantial" unemployment is applied to areas where joblessness is running between 6 and 12 percent, or higher.

Three of the nation's major job centers were added to the list in April, and one—New Orleans—was taken off after showing increased employment in construction, government, trade, and an upturn in ship and boat building. The newcomers are Hartford, Conn.; Newark, N.J.; and Charleston, W.Va.

5,000,000 BLUE-COLLAR JOBS—While blue-collar skilled jobs will not increase as much as white-collar jobs, some 5,000,000 job openings are expected to develop in the skilled trades over the next ten years.

A report by the U.S. Department of Labor published in "Occupational Outlook Quarterly" says that these jobs will "offer steady work, a chance to earn while learning and a 'heritage of creativity'."

LABOR BOARD RECORD—The National Labor Relations Board processed the heaviest workload in its history in Fiscal 1970 with a staff shrunk by budget cuts to 1965 proportions, the agency's top legal counsel said in his annual report to Congress and the President.

NLRB General Counsel Arnold Ordman reported that a record 33,581 unfair labor practice charges and election petitions were filed in the board's 31 regional offices last year—a flow of new business that keeps increasing every year, regardless of budget cuts.

The 1970 total was a 7 percent increase over Fiscal 1969, and a 56 percent increase in the last 10 years.

CLEAR CUTTING—Forest service officials, last month, defended the clearcutting of timberlands as man-made reproductions of natural catastrophes that produced virgin stands of Douglas fir and certain other trees.

Clearcutting, the cutting of all trees in an area, has come under attack by conservationists as destroying scenic values, watersheds and recreational opportunities.

The practice was defended by forest service chief Edward P. Cliff in testimony before the Senate Interior Committee, which is looking into clearcutting in national forests and other public lands.

Cliff told the committee that a two-year moratorium on clearcutting proposed by Sen. Gale W. McGee, D-Wyo., would cause lumber prices to rise because 60% of timber taken from the national forests results from clearcutting.

In defending the practice, Cliff said many old growth stands of Douglas fir, lodgepole pine and other species were the result of catastrophes such as fire, insect and disease epidemics, or wind storms.

"Clearcutting stimulates the national phenomena that gave birth to the old forest stand," he said.

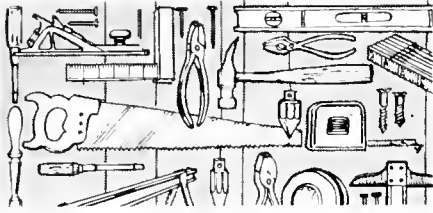

LOCAL UNION NEWS

Floor Coverers Mark 101 Years

The Civil War had ended only a few years before when Resilient Floor Coverers Local 2287 was founded in New York City. Wages for floor coverers—who were mostly staff employees of department stores at that time—amounted to \$2 per day for 12 hours of work.

The local union never achieved a truly firm contract with management until 1902, when the wage structure was \$18 per week for "steady men" and \$21 for "season men", with first-year apprentices receiving \$10 a week. Up until the Second World War, most local 2287 members worked on a six-month, seasonal basis, which caused much financial hardship.

Members were affiliated with the Carpet Upholsterers Benevolent Union in 1870, for the United Brotherhood of Carpenters and Joiners was not established until 1881. In 1937 they made up Carpenters Floor Coverers Local 2070. They became Painters in the late 30's, as members of Linoleum Carpet and Resil-



Participants in the 100th Anniversary Dinner of Local 2287 included: Front Row, Charles Johnson, Jr., Past General Executive Board Member, First District; William Sidell, First General Vice President; Richard E. Livingston, General Secretary; Peter Terzick, General Treasurer, and Patrick J. Campbell, General Executive Board Member, First District. In the second row are the following officers of Local 2287: Thomas Lecato, Co-Chairman of the Dance and Financial Secretary; Joseph Weber, Vice President; Thomas Princee, Warden, Louis Ruggiero, Co-Chairman of the Dance, Business Representative, Frank McHale, Chairman of the Dance, Business Representative Gerald Marehese, Trustee; Michael Coleman, President; Harry Steininger, Trustee, and Philip McTigue, Trustee.

ient Floor Coverers Local 1270. It was February 26, 1941, at the time of a jurisdictional settlement, that the local took on its present name and affiliation.

To celebrate its first century of life, the local held a gala 100th anniversary dinner on April 25, 1970, at the Americana Hotel in Manhattan. More than 1200 persons, including several General Officers of the Brotherhood, assembled to pay homage to this enduring organiza-

tion and its hard-working officers.

The local union has had ten business representatives during its century of existence. John Hanley was the name of the first BA. He served from July 1, 1906, to October 1, 1924. Then followed George Fay, Charles R. Varwig, William Kelly, Joseph Kelly, Edward Rank, John J. Sweeney, and Louis Ruggiero, through 1970. Present business representatives are Francis McHale and Frank Perez.

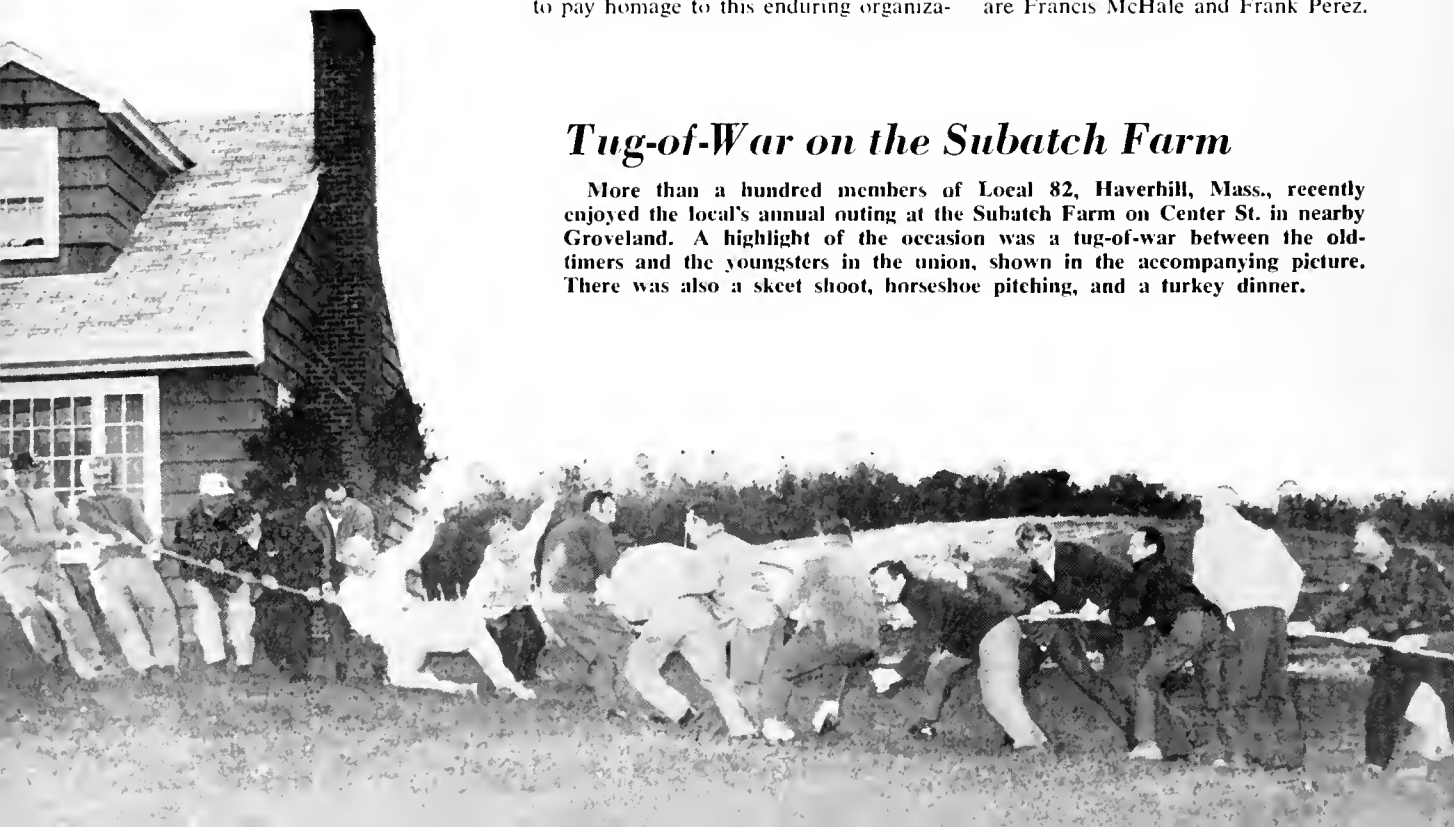

Tug-of-War on the Subatch Farm

More than a hundred members of Local 82, Haverhill, Mass., recently enjoyed the local's annual outing at the Subatch Farm on Center St. in nearby Groveland. A highlight of the occasion was a tug-of-war between the old-timers and the youngsters in the union, shown in the accompanying picture. There was also a skeet shoot, horseshoe pitching, and a turkey dinner.

Auxiliary Established at Kamloops



The officers of Ladies Auxiliary 855, front row, from left: Helen Dupont, recording secretary; Marge Lickacz, president; Evelyn Hopp, vice president; Dorothy Comerford, treasurer; standing, Rozanne Shannon, Elda Lane, trustee; Barbara Bossert, social convener; Susan Bossert, phoning. Not present when this picture was taken were Linn Lewis, warden; Gail Christenson, social editor; and Phyllis Vernerey, trustee.

A meeting of the officers of Local 1540, Kamloops, B.C., was held at the Stockmen's Motor Hotel, Ltd., on September 21, 1970, and attended by the wives of local members. The meeting was chaired by Jack Mobley.

The Ladies Auxiliary No. 855 was established and the officers of the auxiliary were installed, as follows:

Marge Lickacz, president; Evelyn Hopp, vice-president; Margaret Johnson, recording secretary; Dorothy Comerford, treasurer; Linn Lewis, warden; Karen Berger, conductor; Helen Dupont, trustee; Rozanne Shannon, trustee, and Elda Lane, trustee.

Later, on December 12, at a banquet held in the local Moose Hall, presenta-

tion of the charter was made by Lane Vivian, president of Local 1540, and presentation of gavels was made by Jack Mobley, recording secretary of Local 855 and Local 1540. Credit for the donation of these gavels should go to Harold Clarke, who created them.

Due to the sudden illness of the recording secretary, Margaret Johnson, some changes had to be made in the executive, and at the meeting held in Allan Matthews School on January 12, Helen Dupont was appointed recording secretary until the next election. Barbara Bossert, social convener; Susan Bossert, phoning; and Gail Christenson, social editor, were installed. Phyllis Vernery replaces Helen Dupont as trustee.

Local 3206 Night at the Harness Track



On the Saturday night after New Year's Local 3206, Pompano Beach, Fla., held its annual "Night at the Harness Track." This provided entertainment for over 600 persons, including wives and friends. A fine buffet supper was served afterwards.

LABOR and MATERIAL COSTS

NATIONAL CONSTRUCTION ESTIMATOR
ACCURATE BUILDING COSTS IN DOLLARS AND CENTS
LIGHT and HEAVY CONSTRUCTION

1971 UNIT COSTS
COMPILED FROM
THE RECORDS OF
HUNDREDS OF
CONTRACTORS
AND MATERIAL
SUPPLIERS

ONLY \$4.75

- 208 Pages
8 1/2 x 11
NO ADVERTISING
In California a 10 24c tax

- ACCURATE BUILDING COSTS IN DOLLARS AND CENTS
- AVERAGE LABOR COSTS FOR THOUSANDS OF ITEMS
- TYPICAL SUB CONTRACT PRICES INCLUDED
- NEW ESTIMATING RULES OF THUMB

Send for FREE Building Books Catalog

CRAFTSMAN BOOK COMPANY OF AMERICA Dept. C3
124 SO. LA BREA AVE., LOS ANGELES, CALIF. 90036

Please send me the *Nineteenth Edition of the NATIONAL CONSTRUCTION ESTIMATOR*. \$4.75
In California add .24c Sales Tax

Please send me FREE Building Books Catalog.

Firm Name _____
Your Name _____
Address _____
City _____ State _____
AMOUNT ENCLOSED _____ Zip _____

10 DAY FULL MONEY BACK GUARANTEE

LAYOUT LEVEL

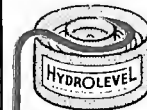

- ACCURATE TO 1/32"
 - REACHES 100 FT.
 - ONE-MAN OPERATION
- Save Time, Money, do a Better Job
With This Modern Water Level

In just a few minutes you accurately set batters for slabs and footings, lay out inside floors, ceilings, forms, fixtures, and check foundations for remodeling.

HYDROLEVEL is the old reliable water level with modern features. Toolbox size. Durable 7" container with exclusive reservoir, keeps level filled and ready. 50 ft. clear tough 3/10" tube gives you 100 ft. of leveling in each set-up, with 1/32" accuracy and fast one-man operation—outside, inside, around corners, over obstructions. Anywhere you can climb or crawl!

Why waste money on delicate instruments, or lose time and accuracy on makeshift leveling? Since 1950 thousands of carpenters, builders, inside trades, etc. have found that HYDROLEVEL pays for itself quickly.

Clip this ad to your business stationery and mail today. We will rush you a Hydrolevel with complete instructions and bill you for only \$7.95 plus postage. Or send check or money order and we pay the postage. Satisfaction guaranteed or money back.

Ask your tool dealer to order it for you. We allow the usual dealer discount on 1/2 Doz. lots and give return-mail service.

HYDROLEVEL

925 DeSoto, Ocean Springs, Miss. 39564
FIRST IN WATER LEVEL DESIGN SINCE 1950

Former BA Honored By Haverhill Local



John F. Burns, right, former business agent of Local 82, Haverhill, Mass., was recently honored by his local union for his long and devoted service to the Brotherhood, Bernard L. Guilford, Jr., left, new business agent, presented Burns a token of the local's esteem. Burns is now secretary of the Massachusetts State Council of Carpenters. The presentation was made in the local union headquarters in Haverhill.

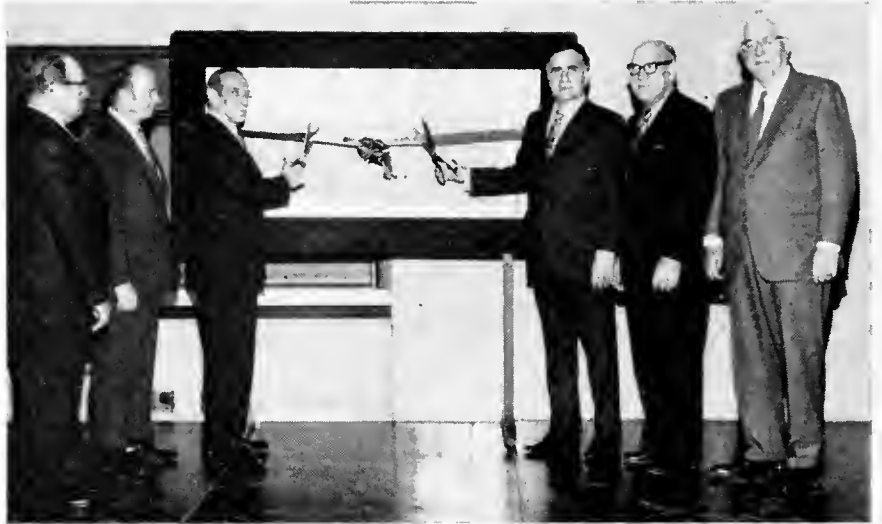

Participating in the symbolic ribbon-cutting marking the dedication of the new training school and headquarters of Carpet, Linoleum, Hardwood and Resilient Tile Layers Local 1310 were these dignitaries. From left: President Gilbert Clark, Local 1310; Howard Kercher, president of the Missouri Floor Covering Co. and Training Fund trustee; William H. Semsrott, president of the Associated Retailers of St. Louis; Perry Joseph, business manager of Local 1310; Executive Secretary-Treasurer Ollie Langhorst of Carpenters District Council, and Alex J. Sobo, president of A. J. Sobo Floor Covering Co., a Training Fund trustee.

St. Louis Floor-Layers Dedicate Building

A symbolic ribbon-cutting ceremony before a large photograph February 27 marked the formal dedication of a new training school and headquarters for the Carpet, Linoleum, Hardwood and Resilient Tile Layers' Local 1310, St. Louis, Mo.

More than 1,000 union members and guests attended the dedication and dinner event at Carpenters' Hall, 1401 Hampton Avenue.

Perry Joseph, Local 1310 business manager, explained that Carpenters' Hall was used because the local's new building was not large enough for such an event. The floor-layers' new 12,000-foot building, located at 6330 Knox Industrial Drive, is large enough, however, to house a unique training school described as the only one of its kind in the nation.

Among guest speakers at the event were Ollie Langhorst, executive secretary-treasurer of the Carpenters' District Council of Greater St. Louis, AFL-CIO, with which Local 1310 is affiliated; Raymond Sacks, divisional director, Vocational, Technical and Adult Education, O'Fallon Technical High School, and William H. Semsrott, representative of the Associated Retailers of St. Louis.

Langhorst presented to Local 1310 an American Flag and Staff, which he said was a gift of the Carpenters District Council. "We hope that it will stand proudly . . . and serve as a vigilant and unending inspiration to those who enter your new building."

In an effort to keep the program part of the dedication dinner-dance short, the union prepared a picture-filled six page brochure which not only outlined the history of the union's training program,

but pointed the direction in which the union was heading.

The brochure was distributed to all guests. It will also be used for mailings across the country to promote understanding of the school to floor laying unions and management groups. The brochure was prepared for Local 1310 by Union Communications Corporation.

The brochure pointed out that on November 19, 1969, ground was broken for the new building which houses not only the school, but offices of Local 1310. The local moved into its new building in August, 1970.

Heart of the two-story building is its first floor, where all major work and training areas are found. Divided into three major work areas—each interchangeable, in case there is a change in the consumer demands—the school accommodates training programs for carpet, vinyl sheet goods, tile and hardwood flooring.

The second floor is dominated by an assembly hall capable of seating more than 200 persons. Used not only for training films and instructional clinics, it also provides manufacturers' representatives with space they need to conduct demonstrations. This gives trainees the opportunity to be exposed to more industry programs. The hall also serves as a social center for the apprenticeship program. Additionally, a portion of the second floor houses offices of Local 1310, thus placing all the union's functions under one roof.

Today, there are more than 70 union members in continual training, including a three-year apprenticeship program that requires 144 hours of instruction in 27 special training areas.

**LEARN SURVEYING
AT HOME!**

APPROVED
VETERANS

**PUT YOURSELF ON THIS
HIGH PAY SURVEYING TEAM**

Prepare now at home for a rewarding Career in Surveying. Excitement! Fun! Prestige! Imagine yourself as part of a Surveying Team — in on planning of highways, bridges, dams, airfields, subdivisions, etc. Wonderful Outdoor Career... ideal for men who like to work with their hands.

We'll Give You This Famous 2X SURVEYOR'S TRANSIT when you train with us for a

HIGH PAY CAREER IN SURVEYING!

... lets you make Surveying measurements the way professionals do! PLUS 3 Big Surveying Kits you use during training... you keep throughout your Surveying Career. You need no previous experience, no technical ability. North American has trained 10,000 to step into good pay positions in every State. Many students report good earnings part time while still learning. Thousands who are Surveyors today get their training through home-study. You can too!

Rush Coupon for FREE 'Surveying Career Kit'

... including 20-Page Book, Sample Lesson and Self-Scoring Aptitude Quiz. No cost or obligation. Rush coupon today.

**NORTH AMERICAN
SCHOOL OF SURVEYING** Dept. 11466
4500 Campus Drive • Newport, Calif. 92660

Rush "SURVEYING CAREER KIT" including Book, Sample Lesson & Aptitude Test — ALL FREE!

Name _____ Age _____

Address _____

City _____ State _____ Zip _____



1

(1) NORWOOD, PA.—Local 845, Norwood, held its annual awards night recently, with 280 members and their wives attending.

On this occasion members with 25 years of active service were honored and presented with membership pins. Those honored are shown on the accompanying photo, from left to right, front row: William Bard, George Vent, Thomas Grant, John Trainer, Doug Quigg, and John Vandergast; in the back row are: Howard Wright, Leonard Whitcomb, Thomas Moran, chairman, Joseph Seefeldt, business representative of Delaware County and member of Local No. 845, Richard O'Driscoll, assistant supervisor of Carpenters Health and Welfare Fund of Philadelphia and Vicinity, George Campbell, and Robert Rudolph. Not pictured but receiving their pins were Garry Brickman, John Cowie, Simon Diehl, George Ernst, Thomas Haslett, Andres Ottoson, Joseph Rose, Stephen Woziak, and Wm. Bell, making a total of 19 twenty-five year pins.

(2) RIVERSIDE, CALIF.—Carpenters Local 235 rewarded 77 members who have 25 or more years continuous membership in the United Brotherhood of Carpenters and Joiners of America, on Monday evening March 22. Each mem-



Service to the Brotherhood



A gallery of pictures showing some of the senior members of the Brotherhood who recently received 25-year or 50-year service pins.

ber was presented a lapel pin designating the years in service. The pins were presented by General Representative J. W. Howard.

Local 235 was chartered November 1, 1888, which was only seven years after the International Union was chartered. The local union maintained its

office at 8th and Orange Streets until 1950 when it purchased property at 3908 Tenth Street where it remained until December 1, 1970, when it moved into a new building at 1064 East La Cadena.

Special guest at the awards ceremonies was R. B. Trail, president of the San Bernardino-Riverside District Council of Carpenters.

L. A. Bigler, past president of the local union, was awarded a 50-year pin.

Shown in the photograph, front row, left to right—D. B. Johnson, L. T. Christensen, Elmer Darr, R. W. Josey, Ed Bodinar, L. A. Bigler, Jay Glover, W. R. Harris, Sid Liebrich, Fritz Szameitat, and Robert Kerr.

Second row—Rentz Jones, Sr., Paul V. Green, and Marvin Hinshaw.

Third row—George A. Brouillette, Elmer M. Eastman, Joe Arzate, Vernon S. Keil, Harland Karge, Clarence C. Farnham, Fred Engel, Alfred A. Henry, Evans Leroy Anderson, Howard D. Mann, and Clarence W. Campbell.

Fourth row—H. E. Blacksten, Gny Marquand, Robert C. Giochrist, Otis W. Fosmo, Frank E. Johnson, Donald W. Bush, Oliver Hansen, Arthur F. Hefley, Orion G. Logan, Merle A. Lewis, LaFayette D. Gentry.

2





1

SERVICE to the BROTHERHOOD

A gallery of pictures showing some of the senior members of the Brotherhood who recently received 25-year or 50-year service pins.



2

(1) UTICA, N.Y.—Service pins were recently presented to three dozen members of Local 125 of Utica at a special dinner, early this year. In addition to those members shown in the accompanying photograph, a 70-year member, George A. Stein, was awarded a service pin in a special presentation at a nursing home where he now resides. Shown in the picture are: Front row, seated, left to right, M. Encarnacao, Earl Simpson (65 year member), Dan Monopoli (President, Local 125), Stan Janus, Henry Majka, and Edward Czupryna. Second row, Carl Falzarine, Joseph Arcuri, Mario De-Stefano, Edward Schroeder, Martin Kutas, Ruppert Gassner, Raymond Gibson, Edward Lynch, and Joseph Cuda. Third row, Alex Dinicola, William Mogenson, John Bolinski, Arthur Reppel, and Raymond Zangrill. Fourth row, John



3

J. Lewck (business representative), Albert Sardino, Arthur Miller, Elmer Knapp, Milton Jones, Sam Tomaselli, Kazimer Jeff, Bob Crowther, and Anthony Weber.

(2) PLAINFIELD, N.J.—Four hundred members, wives and friends attended the 85th Anniversary Dinner Dance of Local 155, Plainfield, N.J., at the Far Hills Inn, Somerville, N.J., on Friday, March 12. Local 155 was founded on March 15, 1886, less than five years after the United Brotherhood was founded in Chicago. Membership pins were presented to Albert Nelson and Clarence Spanginberg for 60 years of continuous membership. Forty year pins went to John Quipp and Frank Trano. Those in attendance who received 25-year pins were Frederick Bechtle, Michael Derewicz, Dominick Falcetano, Rupper Fuchs, Eugene Gottlick, Richard Z. Ilk, Fred J. Nusbaum, Raymond Stem, Russell Stevens and Martin Szoke. Local 115 President Frank Mioarek gave a cordial welcome to those in attendance. Raleigh Rajoppi, General Executive Board Member, discussed the importance of every member and family in the labor movement to become deeply involved politically by registering to vote and financially supporting the political

education groups within the organization. Frederick Porges, assistant superintendent of the Middlesex County Vocational School System, spoke on the many accomplishments and improvements that took place over the last decade in the apprenticeship and training programs through the cooperation of the school faculty and the apprentice committees. Chairman in charge of arrangements was Fred Nusbaum, assisted by Brothers Minarek, Eugene DeFillipo, William Drake, Albert Henbach, Gerard Hickey, Charles Lamb, Norman Laustsen, Edward Margentino, John McAloney, Bernard J. McDonald, George W. L. Page, Anthony Santangelo, Richard B. Snowden and Rudolph Wolf. In Picture No. 2 are shown, left to right, Executive Board Member Raleigh Rajoppi, Albert Nelson, Mrs. Nelson, and Fred J. Nusbaum, business representative.

(3) Left to right, front row, Frank Minarek, president Local 155; Russell Stevens, general representative; Robert F. Ohlweiler; Executive Board Member Raleigh Rajoppi; Raymond Stem; Rupper Fuchs; Martin Szoke. Second row, Master of Ceremonies Fred J. Nusbaum; Dominick Falcetano; Past President Richard Z. Ilk; Eugene Gottlick; Frederick Bechtle; and Michael Derewicz.

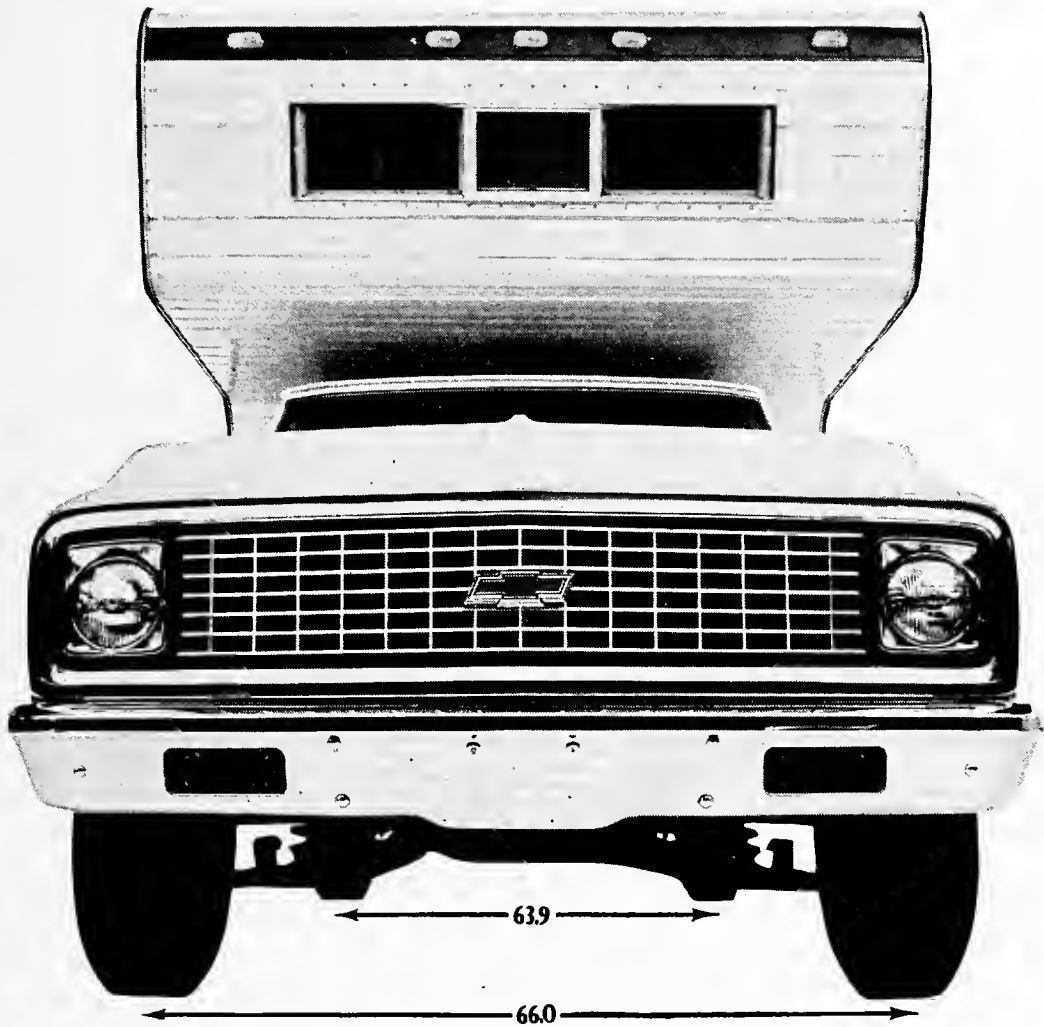

Wide-Stance Super Suspension

(Nobody builds a ¾-ton pickup with a wider stance.)

Now you can set your vacation home on a more solid foundation. Ours. Because nobody builds a ¾-ton pickup with a wider stance than this camper-size Chevy. For better balance, surer handling. And you get independent front suspension, with coil springs, to keep road shock away from the driver and the cargo. Coil or leaf springs are available at the rear to precisely balance your load.

Fade-resistant front disc brakes—standard.

So are power disc brakes standard on popular ¾- and 1-ton models. Disc brakes, if offered, cost extra on most other pickups.

No bigger V8 for campers.

Our available 400 V8 supplies the muscle for big loads, difficult terrain. Yet it uses low-lead regular fuel—and sparingly. If you can get along with less engine, Chevy offers four other V8s and Sixes. Check your Chevy dealer for the special equipment that will tailor your pickup to your kind of camping.



Totally tougher trucks

Chevy trucks last longer.

The chart below, based on latest official figures*, shows how Chevrolets outlast other trucks. Going back as far as 1955, for instance, over 56% of the Chevrolets of that model year are still on the job. No competitive make has as many as half of its 1955 models still working.

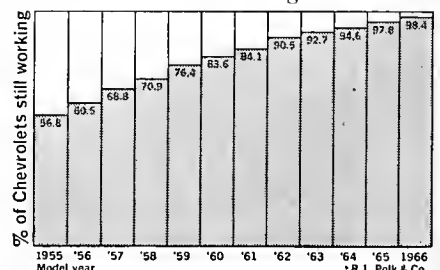



ANADIAN REPORT

Heavy Unemployment, Price Increases, Turn Public from Liberal Program

All signs point to complete public disenchantment with the economic policies of the federal Liberal government.

The resignation of Eric Kierans, a senior cabinet minister in the Trudeau government, emphasizes the wrong-headedness of the perilous course which the administration has been pursuing since it has been in office.

Canada was a relatively prosperous country when it celebrated the 100th year of Confederation in 1967. Business and employment conditions were good.

Today the country is in a state where it has been "getting the worst of both (economic) worlds, with heavy unemployment and unsatisfactory high rates of price increases." This was the view expressed to the Senate banking committee which is in the midst of two months of hearings on the state of the economy.

Kierans' resignation was a bit of a bombshell, as he protested tax concessions to rich resource development industries which employ few people, compared with manufacturing and service industries.

Mr. Kierans is a self-made millionaire and an economist who should know what he is talking about. He charged that the oil, gas and mining industries "are living in the tax rate days of J. P. Morgan."

As an example, he pointed to 1968 figures which showed that the oil and gas industry in 1966 paid taxes on profits of only \$15 million when its book profit was \$380 million.

But in manufacturing, small industries pay taxes on as much as 83% of their profits.

The Senate Committee was told that, even though some economic improvement is under way, "there can still be no grounds for satisfaction about the

recent course of economic events in Canada."

"We have considerably worse unemployment than most other industrial countries, and the uneven regional impact of this and of the slow economic growth has imposed special social and political strain in Canada."

Donald MacDonald, president, Canadian Labor Congress, said that he expected it would take years for the economy to recover from the government's crackdown on inflation, while Arthur Smith, chairman of the Economic Council of Canada, doesn't see the country solving its unemployment problem for at least three years or more.

Smith said that the best way to create full employment is to develop a very strong growth in total demand, both export and domestic.

While inflation must be fought at the same time, wage restraint was not the way to do it.

Instead he proposed stimulating productivity and competitiveness and helping workers and businessmen to move from declining areas of the economy to expanding ones.

The government must find ways to avoid big swings from boom to bust.

He disagreed with another expert, Sir Roy Harrod who, while agreeing that unemployment was a worse problem than inflation, suggested controls on wages and corporate dividends to fight inflation.

ECC chairman Smith argued that wage and price controls would impose an enormous range of difficult problems.

But the consensus of opinion across the country is that the government has been directing its moves against the wrong enemy, that the unemployment situation is a disgrace and that someone at the top better come up with some effective answers soon.

Gross Nat'l Product Tripled by 2000 AD?

A Canadian research group has taken a look into the future and come up with an interesting outlook.

Describing themselves as a Canadian think-tank, the researchers predict that, by the year 2000, the gross national product will have tripled to \$288 billion in constant 1967 dollars, compared with \$75 billion in 1970.

They believe that Canada will be a nation of apartment dwellers, that most adult women will have jobs, that the average work week will fall from the present 40 hours to 28 or 29 hours and that the typical Canadian will work only 1,529 hours during the year compared with 1,990 hours today.

The study prepared for the federal government also predicts that the population will increase by 70 per cent to about 34 million.

Manitoba, Saskatchewan and the Atlantic Provinces will show little growth, while Ontario, British Columbia and Alberta will continue to attract population.

By the year 2,000, Ottawa and Edmonton will have populations over the million mark as Montreal, Toronto and Metropolitan Vancouver have today.

Calgary, Hamilton and Quebec City will have populations above 800,000.

Half the population will live in Canada's eight largest cities, Toronto with over five million people will be Canada's largest city.

Strong housing demand will continue and the present housing stock of about 5.5 million homes will expand to 12.7 million.

The need for rental accommodation will accelerate the trend away from single detached, semi-detached and duplex homes toward row housing and apartments.

There will be greater demand for more public services such as health and welfare, education, transportation, parks and recreation facilities.



Housing Funds Need Careful Use

Last year the federal government embarked on a \$200 million innovative housing program which was supposed to encourage new ideas.

The money was spent. But an assessment of the program by a housing specialist, Alex Murray, is that there was nothing really new developed.

The money was well spent anyway, as it did stimulate home-building for low income families.

The program really amounted to a shot in the arm for housing when it was badly needed.

Mr. Murray thought money still needs to be spent on innovative housing, but more thought should be given to how it is spent.

The Housing and Urban Development Institute of Canada, representing a large segment of the construction industry, has informed the federal minister of housing and urban development Robert Andras of its plan for a 100-acre demonstration project which it hopes will receive cooperation from federal, provincial and municipal governments.

What they want is that normal restraints placed on land developers and builders should be waived to permit what they call free expression of the industry's ingenuity. They expect to show substantial savings.

The industry has been arguing that producing housing for low income Canadians is not a technological problem. It is a matter of clearing away the zoning and building restrictions.

Who is going to speak for the public when the HUDAC proposal is considered? Before zoning and other building restrictions were introduced, slums and shoddy construction were too common.

It may be that the HUDAC idea has good points, but the building industry is a powerful lobby group and their position should be closely examined in the public interest.

Ontario Housing Up 4,000 Units

In its budget for 1971-72, the Ontario Housing Corporation, housing agency for the Ontario government, is expanding its program by over 4,000 units.

OHC built 16,179 units in 1970, is planning for 20,200 in 1971.

Of these 11,000 will be for families and senior citizens, 2,200 will be students' housing and 7,000 will be con-

dominium units built by private interests with OHC funds.

OHC was involved in the pre-construction, construction or management of 60,117 housing units to the end of March 1971.

Of these, 37,000 were completed and rented, 8,500 were under construction and 14,000 were in various stages of development.

Labor Is Strong In New Democrats

About one-third of 1,770 delegates to the 1971 leadership convention of the labor-supported New Democratic Party of Canada were trade unionists.

Their voice and votes were decisive in helping decide major policy issues and in the leadership race.

Noted labor lawyer David Lewis, a veteran parliamentarian, was elected by a solid majority to the party leadership, succeeding T. C. "Tommy" Douglas who led the party since its inception in 1961.

Wage Guidelines and Doctors' Income

The federal government failed in its attempt to impose a six percent wage guideline, and now the Ontario government is attempting to impose a 5% ceiling on the wages and salaries of its civil servants.

The contadictions which any wage restraint policy will run into was very evident just a week after the Ontario guideline proposal was announced.

The Ontario government ordered an investigation into the earnings of the province's doctors.

Health Minister Bert Lawrence made it known that in the past year, some doctors have received over \$200,000 in medical payments from the government-run health insurance plan.

The minister said he was shocked. His investigation would start with the 50 doctors receiving the highest payments. One doctor at least was said to have received about \$350,000 in the year.

While some doctor's seem to have been lining their pockets while treating their patients, the Denturist Society of Ontario charged that the dentures they make and supply to dentists at a cost of between \$75 and \$90, cost the patient anywhere from \$400 to \$1,000.

The denturists are trying to obtain recognition as a legitimate profession which can provide service directly to the public.

AUDEL CARPENTERS & BUILDERS LIBRARY



THESE "PAPER TOOLS" can boost your income!

Their 1,488 pages of practical information and how-to guidance are invaluable "tools" for all in the building trades... a complete course for the apprentice, a ready reference for master workers.

Thousands of photos, diagrams and charts tell and show short cuts, new methods, solutions and money-saving ideas... how to use every tool and building aid... how to build everything from furniture to houses... how to frame, roof, excavate, do carpenter arithmetic, estimate costs, trim, insulate, care for tools, etc. They can help you earn more, fast.

MONEY BACK GUARANTEE—You must be completely satisfied with the Audel Guides you order, or you may return them within 10 days and get your money back.

— SEND COUPON TODAY —

Theodore Audel & Co., 4300 West 62nd St. C-061
Indianapolis, Indiana 46268

Please mail me Carpenters and Builders Library, 4 vols. I agree to mail \$3 in 10 days and to mail 1/2 the total purchase price 30 days later, with the balance plus shipping costs to be mailed within another 30 days. If I am not completely satisfied I may return the books for refund.

Name _____

Address _____

City _____ State _____ Zip _____

Save shipping costs. Enclose \$18.50 (plus sales tax, if any) and we pay postage.



STAIRWAY CONSTRUCTION MADE EASY

WITH THIS NEWEST BOOK

In plain language and with over 50 illustrations and photos, you are shown the methods that years of experience have proven the easiest, fastest, most practical and efficient.

Even with no previous experience you will be able to build a good stair the first time. It gives complete, detailed, easy-to-follow instructions on how to lay out, cut and build a more perfect stair. It shows the basic construction methods of all types, including winder and circular stairs.

This is the most complete book on stair construction published in the past 30 years. Increase your skill and self-confidence now. It saves its cost on the first stair built.

Satisfaction Guaranteed

\$3.50 Postpaid. Washington State residents add 18c tax. For air mail shipment add 60c extra.

Send \$3.50 money order or check to:

DOUGLAS FUGITT
11347 N.E. 124th St., Kirkland, Wash. 98033

ORDER TODAY

Name

Address

City

State Zip Code

**When we couldn't get the
kind of wood we needed for
Lufkin rules, we grew our
own trees.**



That's because in our business you can't take chances on quality or accuracy. We even weave our own cloth tapes for the same reason.

And, knowing the beating a long tape has to take out in the field under many different conditions, we created our famous chrome tapes. They last at least four times as long as the regular white tapes. (Incidentally, we make a white tape that's also long-lasting because it's coated with epoxy.)

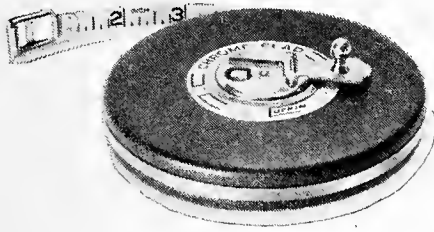

The almost indestructible Chrome Clad® long tape

We've been in this measuring business for over 100 years and we're still proud of our newest developments. The Lufkin power tape which we call the Mezurlok® has a special lock that prevents the tape from creeping. And we built in a patented rubber bumper so the end-hook won't snap off when you return the tape into the case.

We're always working on something new or trying to solve a special problem. That's why we can safely say that whatever your measuring requirement might be, Lufkin has the perfect solution.

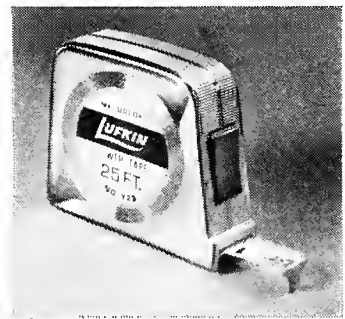

Our Mezurlok® beats the creeps

The Cooper Group

CRESCENT · KEN-TOOL · LUFKIN · WELLER



APPRENTICESHIP & TRAINING



FRONT ROW, (Left to Right): Raymond E. Miller, Jacksonville; Ronald Witcher, Jacksonville; Jesse J. Wright, Jacksonville; Irvin McConaghy, Gainesville (2nd place winner); Billy W. Davis, Jacksonville (1st place winner); Jack McLain, Jacksonville (3rd place winner); Donald L. Verner, Jacksonville; Robert Dunn, Jacksonville; Robert B. Nix, Jacksonville.

BACK ROW: Ed Saxton, business rep. for Local No. 1278, member of committee and judge; John H. Sea, business rep. for Carpenters District Council, secretary-treasurer for committee and judge; George Dinsmore, 3rd year instructor, George Whisman, 2nd year instructor, Kenneth Pittman, business rep. for Local No. 2292; Thomas Thompson, 4th year instructor; W. R. Chesser, Gainesville area instructor, MDTA instructor; Louis E. Toth, apprenticeship director; Earl S. Huff, assistant business rep. for Carpenters Local No. 627; Willard Masters, business rep. for Carpenters Local No. 1200 and assistant business rep. for Carpenters District Council; Bob Dishman, superintendent for the Auchter Company and judge; Clarence E. Pittman, Bureau of Apprenticeship and judge.

THE 1971 CONTEST

The 1971 Carpenters International Apprenticeship Contest will be held in Detroit, Michigan, August 12, 13, and 14. Every state and province should be represented by carpenter, millwright, and mill-cabinet contestants.

North Florida Apprenticeship Contestants Vie For Chance At Statewide Competition

On March 13, 1971, the North Florida Carpenters Joint Apprenticeship and Training Committee Trust Fund held its third Annual Carpenters Apprenticeship Contest at the Normandy Mall in Jacksonville. There were ten contestants in this contest. These young men were completing four years on-the-job training with related classroom instruction and were competing for the honor of representing the North Florida Carpenters Apprenticeship Program in the statewide contest held, last month, at Daytona Beach.

The first-place winner was awarded a trophy, power saw, savings bonds and \$130 worth of hand tools. The second-place winner was awarded a jig saw kit and savings bond; third-place winner was awarded a power drill kit and savings bond. These prizes were donated by the North Florida Carpenters Apprenticeship Committee as well as the business representatives of the local unions and district council and the instructors of the Jacksonville area.

A large group of spectators watched the contest in the shopping center.

The Importance of Safety Hats

'Find A Hard Hat To Fit You, Or We'll Find A Man To Fit The Hat'

The "Hard Hat" has become so much a part of American political and social lingo that the New York State Department of Labor at Albany has decided to tell us what the "real" hard hat is all about.

Here's what it had to say in the March issue of its *Industrial Bulletin*:

"I hate the darn things; you sweat with them; you freeze with them, but I wouldn't be without them." The subject of the discourse was the hard hat.

Although every worker should be encouraged to use his head to absorb knowledge—he should not use it to absorb blows. Men exposed to head hazards must be provided with head protection.

On the job, alert foremen insist that the safety hats be worn; admonishing hatless men with: "Find a hat to fit you, or we'll find somebody to fit the hat."

The item most people call a hard hat is actually a hard cap. The hard hat has a brim; the cap features only a small bill in front. Inside the hat or cap is a sweat-band and a suspension system, usually of plastic,

which rests directly on the head and is designed to help absorb impact. Hats and caps should also meet standards designed to protect wearers from sharp objects, electrical shock, flame and water and should also be adaptable for various accessories like woolen winter linings with ear flaps, and for goggles and visors.

Before each use, hard hats or caps should be inspected for cracks, signs of impact or rough treatment, and wear that might reduce the degree of safety originally provided. Once damaged, protective headgear should be discarded. Alterations of any sort impair the performance of the safety hat.

The hard hats seen today, worn as a matter of pride as well as safety, are fairly new items of personal protective equipment. They are partly the outgrowth of the first World War helmets worn by the doughboys in France and also the derbies worn at the turn of the century by construction union delegates who carried their offices in their derbies and which also protected them from flying objects. (PAI).

Suffolk County Class Registration



The Suffolk County, N.Y., District Council of Carpenters, last January 20, held registration night at its office in Medford, Long Island. The Federally-funded M.D.T.A. (Manpower Development Training Act) program for upgrading journeymen and training apprentices among minority and disadvantage groups was attended by 75 persons who plan to attend classes in acoustical ceilings, welding, blueprint reading and estimating, mill cabinet and on-the-job training apprenticeships.

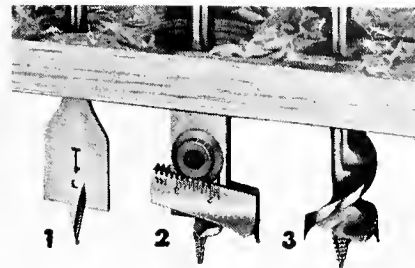

3 easy ways to bore holes faster

1. Irwin Speedbor "88" for all electric drills. Bores faster in any wood at any angle. Sizes 1/4" to 3/8", \$.90 each. 3/8" to 1", \$1.00 each. 1 1/8" to 1 1/2", \$1.50 each.

2. Irwin No. 22 Micro-Dial expensive bit. Fits all hand braces. Bores 35 standard holes, 7/8" to 3". Only \$5.70. No. 21 small size bores 19 standard holes, 3/8" to 1 3/4". Only \$5.00.

3. Irwin 62T Solid Center hand brace type. Gives double-cutter boring action. Only 16 turns to bore 1" holes through 1" wood. Sizes 1/4" to 1 1/2". As low as \$1.60 each.

EVERY IRWIN BIT made of high analysis steel, heat tempered, machine-sharpened and highly polished, too. Buy from your independent hardware, building supply or lumber dealer.

Straight-Line Chalk Line Reel Box

only \$1.35 for 50 ft. size
New and improved Irwin self-chalking design. Precision made of aluminum alloy. Practically damage-proof. Fits the pocket, fits the hand. 50 ft. and 100 ft. sizes. Get Strait-Line Micro-Fine chalk refills and Tite-Snap replacement lines, too. Get a perfect chalk line every time.



IRWIN Wilmington, Ohio 45177

every bit as good as the name

Lil' Doll™

MOST ECONOMICAL WAY TO MOVE MATERIAL AT THE JOB-SITE

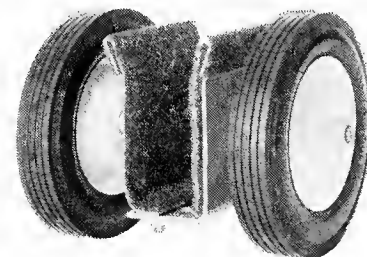

No more back-aches or sore muscles! Our Lil' Doll does all the work—a new idea for on the job transportation of materials. Doors, plywood sheets, counter tops and similar material up to 2-1/4" thick are easily rolled to the point of installation. A padded 3/16" steel carriage and 8" heavy duty ball bearing wheels give Lil' Doll the durability to carry 250 lbs. Lil' Doll easily maneuvers over electrical cords, screpwood and other debris found at job sites.

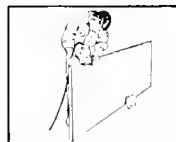

Stable enough to work on material without removal from carriage.



One man can do the work of two without tiring, wheeling material not lifting it.

SCHAEFER MANUFACTURING COMPANY
3022 West Scott Avenue McHenry, Illinois 60050

YOU NEED

The original

"wedge-type" screwdriver

QUICK-WEDGE

SCREW-HOLDING SCREWDRIVER

IT'S YOUR THIRD HAND

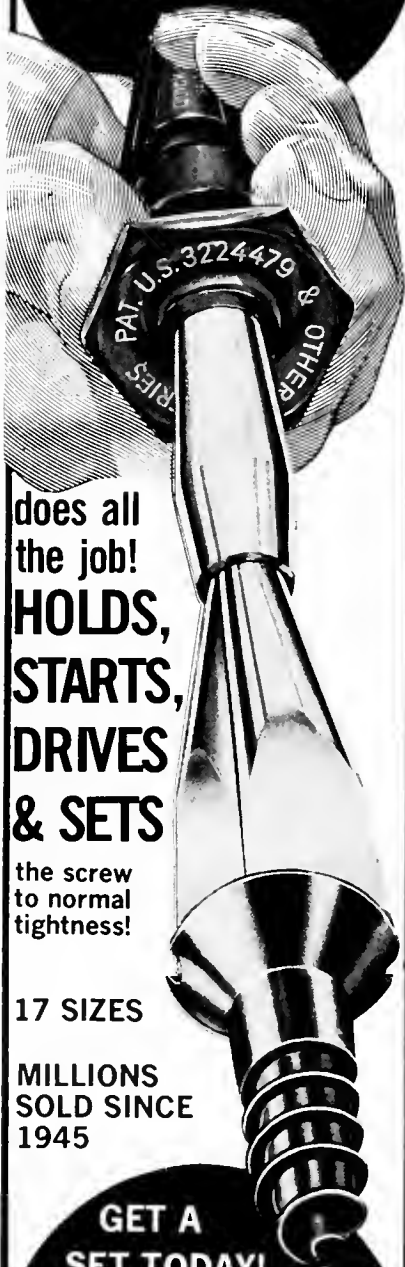

does all
the job!
**HOLDS,
STARTS,
DRIVES
& SETS**

the screw
to normal
tightness!

17 SIZES

MILLIONS
SOLD SINCE
1945

**GET A
SET TODAY!**

Unconditionally Guaranteed
Finest Quality
Workmanship & Materials
At Your Dealers or Write

KEDMAN COMPANY

P. O. Box 267
Salt Lake City, Utah 84110
Phone (801) 363-4413

© 1970 by Kedman Company



YOUR UNION

DICTIONARY

This is the fourth of a new feature series planned to keep you better informed on the meanings of terms related to collective bargaining, union contracts, and union business. Follow it closely, and your union membership will become more meaningful, and your ability to participate in decisions which affect your future and security will be strengthened. It was compiled by the International Labor Press Assn, and is used with permission.

B

business agent: An elected or appointed representative of a local union or district council, with responsibility for negotiating contracts, administering existing contracts, and adjusting grievances. He is usually a full-time unionist, as contrasted with the shop steward or committeeman. He sometimes has organizing duties too.

business manager: A business agent, especially in a large local; the administrative head of a joint board or council.

C

call-back pay: Premium wage to an employee called back to work after completing his regular work shift.

call-in pay: Guaranteed minimum payment to an employee called to work for less than a full shift.

captive audience: The work force, assembled on company property and forced to listen to anti-union propaganda, on company time.

captive shop: A shop whose production is used solely by the company owners.

card check: A check of authorization cards, sometimes resulting in winning recognition of the union by the employer without the necessity of an election.

cease-and-desist order: Direction to management or the union, issued usually by the NLRB, to halt an unfair labor practice. The great bulk of such orders apply to intimidation, threats, dismissals, etc., by management.

central body: A geographical gathering of local unions for political, legislative and other purposes. A central body, state or local, is the focal point for the common efforts of unions within its area.

central labor union: A grouping of local unions in a specific geographical area.

certification: Official designation of a union as collective bargaining agent following proof of majority support among employees in a bargaining unit.

chapel: Members within a single shop of printers belonging to a city-wide local of the Typographical Union. Printers have seniority within the chapel.

checkoff: Withholding of wages by an employer for direct payment to a union of dues and assessments.

closed shop: A place of work in which all covered employees must be union members in good standing before being hired, and new employees are hired through the union. The closed shop as such was outlawed by the Taft-Hartley Act.

MDTA Trainees Aid Benefit Show

Pre-apprenticeship trainees in the District of Columbia-Maryland-Virginia Area performed a public service recently while developing their craft skills. Seventeen young men built a temporary platform over a swimming pool at a plush home in suburban Maryland, so that a benefit performance (under the honorary chairmanship of Mrs. Pat Nixon) could be given for the Christ Child Settlement Home and Camp.

Under the direction of Instructor Chris Jorgensen and JAC Training Director Nick Loope, the pre-apprentices produced a sturdy platform on a Saturday afternoon, and shortly after the charity activity, they tore it all down.

The trainees are recruited, transported, and remunerated by the local Christ Child Society. The Joint Apprenticeship Committee supplies the instructor and training materials.



ABOVE: INSTRUCTOR Jorgensen, William McSorley of the AFL-CIO Building Trades, and JAC Training Director Loope. BELOW: A group of trainees shore up the platform from the pool floor.



Pre-Apprentice Trainees in Seattle



Under the auspices of the King County, (Seattle) Washington, Carpenters Joint Apprenticeship and Training Committee, 15 young men recently completed the institutional phase of their pre-apprenticeship training under the Federal Manpower Development and Training Program.

Rusty Hardin, the instructor, left, above, stresses punctuality, reliability, and productivity, with emphasis on those manipulative skills needed to solve actual construction problems encountered on the job. Pictured with Brother Hardin are five of the young men in the related classes. All are now assigned to the on-the-job phase of their pre-apprenticeship training.

LABOR'S RESPONSIBILITY—"The question propounded centuries ago—'Am I my brother's keeper?'—is being answered by the labor movement and the social conscience it arouses. Yes, you are your brother's keeper, and unless you help lighten his burden, yours will be made so much heavier."—SAMUEL GOMPERS.

CONSTRUCTION RIGGING MANUAL

This is a pocket reference book with basic information for riggers. The author has spent many years in the construction industry so that the material is practical. The first section considers such information as wire rope breaking strengths, machinery specifications, winch line and choker specs, uncoiling and spooling information, wire rope slings and chokers, splicing wire ropes, reeving with wire rope, and wire rope fittings.

The section on synthetic ropes treats splicing, knot efficiency, whipping and safe working loads for rope and tackle blocks. The last section gives general rigging information such as timber and plank strengths, procedures for setting up mobile cranes, signals, chain strengths, guy stresses, inclined planes, siezing wire rope, rigging practices, weights and measures, safety standards, artificial respiration, and rigging terms.

The information is given in precise terms. Many illustrations are included. This is a practical reference source for the man on the job.

WHO IS A RIGGER?

Any person regardless of his classification or trade, who in the performance of his daily work must use hoisting and all that it entails, such as slinging loads, giving signals, etc.

Basic, suitable, and recommended for all construction personnel being purchased 1,000 at a time by the largest safety association in Canada.

\$2.25 P.Pd.

HANDBOOK FOR RIGGERS

P.O. Box 2999

CALGARY 2, ALBERTA, CANADA

BULK ORDER PRICES AVAILABLE

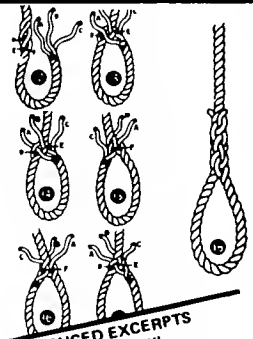

REDUCED EXCERPTS
From 6" x 4"
"HANDBOOK FOR RIGGERS"

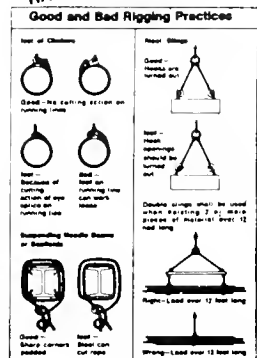

PLANE GOSSIP

SEND YOUR FAVORITES TO:
PLANE GOSSIP, 101 CONSTITUTION
AVE. NW, WASH., D.C. 20001.
SORRY, BUT NO PAYMENT MADE
AND POETRY NOT ACCEPTED.

Light-Hearted Reply

Said the stern father to the new suitor; "We turn off the light in this house at 12 midnight!"

"That's okay, Pop," replied the new boyfriend. "Mary and I ain't gonna be reading!"

MAKE YOUR \$\$\$ CLICK - GIVE TO CLIC



Only Half-Educated

The old hillbilly seated by the fire, was scribbling on paper with a pencil. "Maw!" he shouted, "I done larnt to write!"

"That's great, Paw," agreed his wife. "What did you write?"

"I can't say," he replied disappointedly. "I ain't larnt to read yit!"

R U GOIN 2 D UNION MEETING?

Oh, Good Lord!

One of the oddities of nature is that girls with the least streamlined shapes also offer the least resistance.

UNIONISM STARTS WITH "U"

Artistic License

The woman burst into the room, took off her clothes, and said to the man in white: "Doctor, I want you to

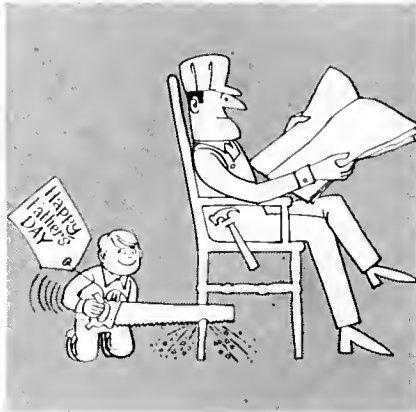

tell me frankly what's wrong with me!"

"I want to tell you three things," replied the man in white. "First, you'd look a lot better if you'd lose about 50 pounds of that fat. Secondly, your looks would also improve if you'd use about one-tenth the make-up you use. And third, I'm an artist . . . the doctor's office is the next floor up!"

I 4 ALL - ALL 4 I

She Was Impatient!

The little boy was attending his first day of school. The teacher patted him on the head and said: "Well, now, little man; do you know your a-b-c's?"

"Hell no!" snorted the tyke. "I only been here ten minutes!"

LIKE TOOLS, BE SHARP & SAFE

A Clinging Vine?

The girl down the block has decided she would rather be a young man's slave than an old man's darling. She said she didn't like the idea of old age creeping up on her.

ALWAYS C D UNION LABEL

Bargain Day!

Daughter: "But Dad, why did you tell Jim I could marry him? I don't want to leave Mother!"

Father: "I understand, and I won't stand in your way. Take your mother with you!"

This Month's Limerick

An adventurous lady named Seale
Once rode on a huge ferris wheel.

When half-way around
She looked at the ground,
And it cost her a four-dollar meal.

Not So George, Dad!

The father was reproving his lazy son who was a college drop-out. "Why, at your time, George Washington had already made a surveyor of himself!"

"Yep," replied the college bum, "and at your age he was President!"

ATTEND YOUR UNION MEETINGS

Tie Onto The Untied

"Grandma," asked the young girl, "what kind of husband should I get?"

"Take my advice," said the modern granny, "and leave the husbands alone; get yourself a single man!"

R U REGISTERED 2 VOTE?

Let's Re-phrase That!

The lawyer was examining a witness during a sanity trial. "Does the defendant often talk to himself while he is alone?" he asked.

"I can't say," replied the witness. "I don't remember ever being with him while he was alone."

UNITED WE STAND



Was He Fuzz-tered!

Minister: I hope you can overlook that parking ticket, officer. I'm just a poor preacher.

Officer: I know . . . I've heard you.

LOOK FOR THE UNION LABEL

Never Misses A Missus

A wolf is a guy who goes out with a lot of pretty girls and never Mrs. a one.

R U A UNION BOOSTER?

Doing The Expected!

The maid was feeling low, but the lady of the house said, "Oh, cheer up and things will get better!"

"No ma'am," replied the maid. "I can't do that. When the Lord sends me tribulations, He sure expects me to tribulate!"

THE CARPENTER



1

SERVICE to the BROTHERHOOD

A gallery of pictures showing some of the senior members of the Brotherhood who recently received 25-year or 50-year service pins.



2

(1) POTOSI, MO.—Twenty-five year pins were recently presented to three members of Local 3244—Lester Woods, Bill Asher and O. G. Reeves. Attending the ceremonies were the following officers and members: Front row, from left—Earl Coleman, Arthur DeClue, Jesse Eckoff, Paul Barton, James Watson (Business Agent), Lester Woods, Clarence Summers, Paul Byers and Delbert Turnbough. Back row, from left, Ed Marris, ex business agent, James Cartwright, Jim Masier, Ross Gafarth Alongo Jarvis, John Sikes, Earl Lee, Lester Watson, George Fenstumaker, Howard Byer, John Swift Dennis Short, and James Shart.

(2) OGDEN, UTAH—Nakor G. Hansen, a member of Carpenters' Local 450, Ogden, Utah, has been a continuous member of his local for almost 65 years.

He was born July 16, 1889, in Norway, coming to Ogden, Utah at the age of 14. He learned his trade in the school of experience and is a craftsman with an enviable record. He worked for one and one half years as maintenance carpenter at the Ogden Tuberculosis Sanatorium and later became a building contractor. In 1942 he was employed as shift foreman in the woodmill branch in the maintenance division at Ogden Air



3

Technical Service Command, Hill Air Force Base.

Hansen has served as president of Carpenters' Local 450, and for several years he served as treasurer.

(3) ST. ALBANS, W. VA.—Twenty-four members of Carpenters Local 128, St. Albans, were honored at a special called meeting on February 9, and presented 25-year pins. Those in attendance and in the picture were:

First row, left to right: Jay Conklin, Jack Cavender, James M. Hayes, John R. Doss, James Whitlock and business representative Johnny E. Harris. Back row, left to right: Jules R. Biron, James Gros-cup, Harold Poff and Paul V. Wilson.

Those unable to attend the meeting, but receiving pins, were as follows: Leonard E. Arnold, Edgar Snow, Harold Henson, Charles K. Goddard, Fred Martin, Walter Lilly, Clyde Erskine, James Barnett, E. G. "Slim" Davis, Richard Faxon, C. K. Townsend, Kenneth Hartley, James Calwell, James D. Justice, and Raymond Jordan.

(4) TONAWANDA, N. Y.—William Schultz was recently presented a 70-year pin by Terrence L. Bodewes, recording secretary of Local 374. Brother Schultz has had continuous membership of 71 years, since April 6, 1900, in Local 374. When he joined Local 374, the local met every week. He thinks he paid an initiation fee of \$5.00 and earned \$12.00 per week based on a 6-day week. He is 93



4

years old and was semi-active until around 1960. His present hobbies are reading the Bible, Old and New Testament, a number of times and repairing old clocks.

NOTE TO LOCAL UNIONS

When sending in photographs for publication in The CARPENTER, please identify each person shown, writing his or her name distinctly and listing current official titles. Start with the front row and list persons shown from left to right in that order.



"We Congratulate..."

... those members of our Brotherhood who, in recent weeks, have been named or elected to public offices, have won awards, or who have, in other ways, "stood out from the crowd." This month, our editorial hat is off to the following:

WISHING WELL—

Ralph Cannizzaro, second from left business agent for Local 163, Peekskill, N.Y., not only played a major role in the recent Cerebral Palsy Telethon of Westchester County, but he also encouraged Robert G. McClernon, right to build this unique portable Wishing Well and information booth for United Cerebral Palsy of Westchester. The Wishing Well is so successful that in one location it raised \$700 in donations. Father of the idea was Joseph Coppola (left), a vice-



president of UCP Westchester and business representative, Bricklayers, Masons & Plasterers Local 48, Thomas Cavanaugh, a Local 163 member standing to the left of McClernon, joins group as seven-year-old Sandy Meikle makes first contribution. Scores of Carpenters from the Westchester area manned phones at local Telethon headquarters for more than 30 hours, contacting friends and business associates in the successful drive for donations.

WORK ACTIVITY CENTER—Members of Carpenters Local 131, Seattle, Wash., recently donated labor and materials in the remodeling of a former residence into a "work activity center" for handicapped persons of the Seattle area.

Through the efforts of Local 131 members and others, "the Shoreline Work Activity is now an operating facility serving handicapped clients who otherwise would have no opportunity to learn work skills and realize their potential for employment," comments Kenneth Pedersen, executive director of the Northwest Center for the Retarded.

Designed for mentally retarded persons of 21 years and older, the center has work facilities for 11 persons at a time. It seeks to prepare the mentally retarded for useful, self-supporting work, and local merchants are using their services in various small assembly projects.

Brotherhood members outside the Work Activity Center in Seattle, left to right, include: Christ O. Olson; Steve Soltis, trustee; Bob Simon, secretary-treasurer; John Olson, district council delegate; Vernon Whiteley; and Victor Long, delegate to district council. All are members of Local 131. Missing from the picture are Anthony T. Lion of Local 131 and William Moore of Local 1289.



COMMUNITY SERVICE—The Union Label and Service Trades Department of New York State, AFL-CIO, recently presented its annual community services award to George Babcock, newly elected president of the Building and Construction Trades Council of Nassau and Suffolk Counties and president of the Suffolk District Council of Carpenters. Participating in the presentation before 400 trade union representatives and guests at Roosevelt Raceway were, left to right: Joann Carroll, Miss Union Maid; Babcock; and Patrick Campbell, General Executive Board Member.

STAIR LAYOUT is the title of a new book written by Stanley Badzinski, Jr., a member of Local 1573, West Allis, Wisconsin. Brother Badzinski was the 1959 winner of a scholarship offered to carpenter apprentices by the Wisconsin State Council of Carpenters. (See the *Carpenter Magazine*, December, 1959). He is presently an instructor of carpenter apprentices at the Milwaukee Area Technical College.

Stair Layout was written especially to teach stair layout and stair building to carpenter apprentices. It has many examples and illustrations to make understanding easy, and it also simplifies self-teaching. The publisher is the American Technical Society, 848 E. 58th St., Chicago, Ill. 60637. (Price \$2.75).

FOR HEROIC ACTION—Dennis Doucette of Local 82, Haverhill, Mass., was recently honored by International Brotherhood of Electrical Workers Local 470 for his heroic action in saving IBEW Member Frederic Bartolo. Bartolo had come in contact with high voltage electricity while wiring along a wall of the First National Store in Newburyport, Mass. Machinegun-like bursts of fire blazed around the fallen worker. Under circumstances of great personal danger, Doucette moved into the area and pulled Bartolo to safety. On behalf of his organization, Edward H. Dufresne, business agent of IBEW Local 470, at left in the picture, presented a token of esteem to Brother Doucette.



IBEW BA Dufresne, left; Doucette, right.

Always look for the union label when you shop. It's your assurance of quality goods and services produced under fair working conditions.

Look for the Brotherhood's union label on many tools and products.

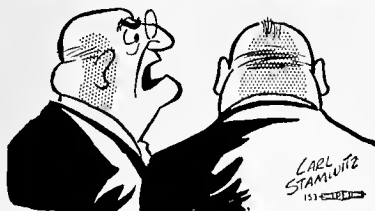
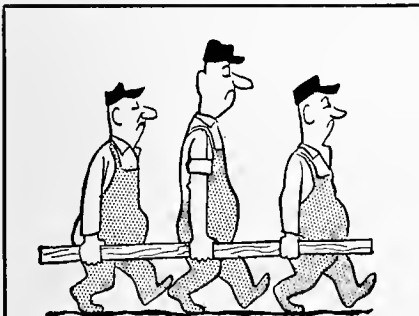

"Let's sign with the Union, J. B.— This scab labor has got to go!"

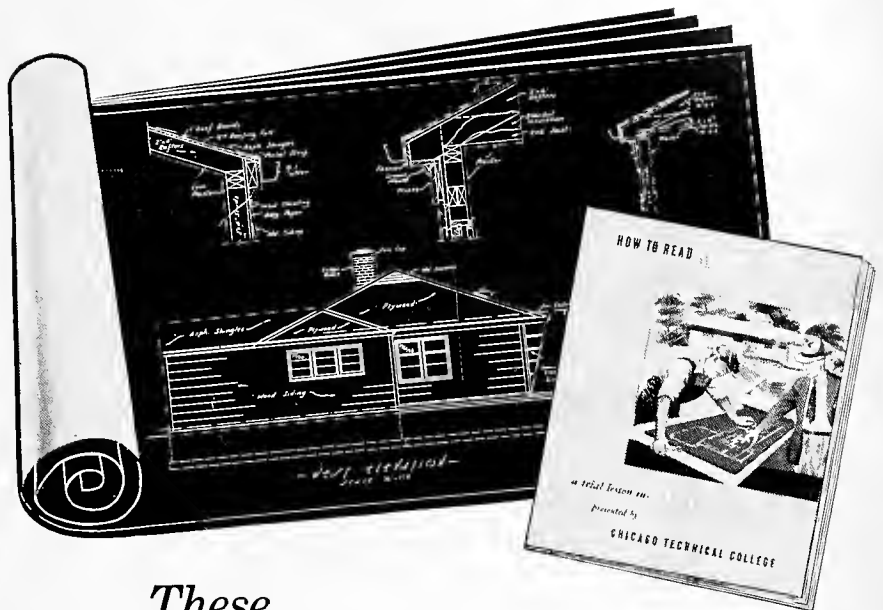

These
FREE BLUE PRINTS
have started thousands toward
BETTER PAY AND PROMOTION

That's right! In all fifty states, men who sent for these free blue prints are today enjoying big success as foremen, superintendents and building contractors. They've landed these higher-paying jobs because they learned to read blue prints and mastered the practical details of construction. Now CTC home-study training in building offers you the same money-making opportunity.

LEARN IN YOUR SPARE TIME

As you know, the ability to read blue prints completely and accurately determines to a great extent how far you can go in building. What's more, you can learn plan reading simply and easily with the Chicago Tech system of spare-time training in your own home. You also learn all phases of building, prepare yourself to run the job from start to finish.

CASH IN ON YOUR EXPERIENCE

For over 67 years, building tradesmen and beginners alike have won higher pay with the knowledge gained from Chicago Tech's program in blue print reading, estimating, foremanship and contracting. Through step-by-step instruction, using actual blue prints and real specifications of modern, up-to-date buildings, you get a practical working knowledge of every building detail—a thorough understanding of every craft. And as a carpenter or apprentice, you already have valuable experience that may let you move up to foreman even before you complete your training.

Don't waste a single day. Start preparing right now to take over a better job, increase your paycheck and command greater respect as the "boss" on the job. Find out about Chicago Tech's get-ahead training in building. Send for your free blue prints and trial lesson — today! Approved for Veterans.

CHICAGO TECHNICAL COLLEGE

G-143 TECH BLDG., 2000 S. MICHIGAN AVE., CHICAGO, ILL. 60616

**FREE
 BLUE PRINTS
 AND
 TRIAL LESSON**

Send for your free trial lesson now. You'll agree that this training is simple yet practical—your surest way to promotion and increased income in building.

MAIL COUPON TODAY

Chicago Technical College New G.I. Bill!
 G-143 Tech Bldg., 2000 S. Michigan Vets check here
 Chicago, Illinois 60616

Please mail me Free Trial Lesson, Blueprints and Catalog.

Name _____ Age _____
 Address _____
 City _____ State _____ Zip _____
 Occupation _____

Accredited Member National Home Study Council

Estwing

FIRST CHOICE of Skilled Craftsmen for Nearly 50 Years

Make Your Next
Hammer An Estwing!

Forged One-
Piece Solia
Steel—

Strongest
Construction
Known

Unsurpassed
Estwing Temper
Balance & Finish

Plus
Exclusive Nylon
Vinyl Deep
Cushion Safe-
T-Grip Molded
on Permanently



E3-16C
16 oz.

Supreme
Nail
Hammer

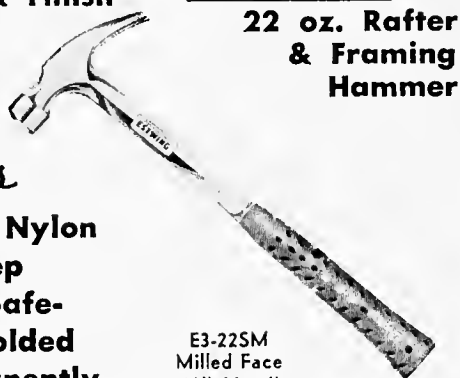

22 oz. Rafter
& Framing
Hammer

E3-22SM
Milled Face
16" Handle

These and Other Quality Estwing Tools
Are Available At Leading Hardware,
Lumber And Building Supply Dealers.

IN SUPPORT OF THE GOVERNMENT CONSUMER PROTECTION PROGRAM

Estwing Tools Carry the Following
Advance Warning

"Nail and Ripping Hammers Are Made
To Drive Or Withdraw Common Nails—
Any Other Use May Be Hazardous"

Always Wear Estwing Safety Goggles

Estwing

Mfg. Co.

2647-8th
Dept. C-6
Rockford, Ill. 61101

Philadelphia Plan 'Absolutely Useless'

AFL-CIO President George Meany has denounced the Labor Department's so-called Philadelphia Plan for bringing minority groups into the building trades as "absolutely useless."

"The Philadelphia Plan does not work; it does not bring a single black worker into the building trades," Meany told a press conference in Atlanta, Ga.

"It merely says that a contractor must get a certain number of black workers on the job and show good faith."

Meany added that what happens is that a contractor calls up on the phone to find black workers on other jobs and shifts them to meet his quota.

"We said that the plan would be a failure and it is a failure," Meany said. He pointed out that the only answers are such programs as Operation Outreach which has brought more than 8,000 black workers into the building trades.

Other points discussed by Meany included:

- Not opposed to trade with Red China but "hoped the U.S. Government would go slow."

- Opposed Nixon's construction wage and price stabilization controls, saying he did not think that the inter-agency committee under Housing and Urban Development Secretary George Romney could evolve a program of price stabilization in construction.

AFL-CIO 11-Point Program For Jobs

Following is the 11-point program which the AFL-CIO is urging the Administration and the Congress to adopt in order to provide for a smooth transition from a defense to a civilian economy:

1. Federal Government policies must be based upon a full employment concept.

2. The Administration should establish a Cabinet-level committee to coordinate Federal programs in the transition to a declining defense sector.

3. Legislation is needed for immediate aid to communities hit by unemployment, similar to the Federal aid that is provided areas hit by natural disasters.

4. A nationwide public service employment program to create jobs for the unemployed and seriously under-employed.

5. Release of the \$12 billion appropriated funds now frozen by Nixon and speedy enactment by the Senate of the House-approved \$2 billion program for accelerated public works construction.

6. Federal grants to state and local governments and non-profit, educational and research institutions to expand research and development in such areas as environment, pollution-control, mass transportation, land use, urban development and health service.

7. Federally-financed, extended Federal unemployment insurance.

8. Federal relocation allowances to assist unemployed workers to move to areas of job opportunity.

9. Increase of education and training allowances under the GI Bill.

10. Special transfer rights and other aids to displaced Defense Department civilian employees.

11. Long-range planning and programming to coordinate national needs in all areas.



1



2

SERVICE to the BROTHERHOOD

A gallery of pictures showing some of the senior members of the Brotherhood who recently received 25-year or 50-year service pins.

Californians Honored

(1) INGLEWOOD, CALIF.—A celebration held recently at Carpenters Local 2435, Inglewood, honored members for longtime service to the Brotherhood.

Harry Dawson, President of the Los Angeles District Council of Carpenters and business representative of Local 1140, made pin presentations to brothers with 25, 30 and 60 years of service.

Robert Clubb, president and business representative of the local union, made the introductions. William Baker, financial secretary of Local 929, gave the invocation.

Many distinguished guests were present, representing the Los Angeles District Council of Carpenters, the Los Angeles Building Trades and the many local unions of the Brotherhood.

Member of Local 2435 who received 30-year membership pins at the ceremonies were, from left First row—W. Derousse, C. E. Patton, P. Brons and F. Cox. Second row—R. J. Adams, H. Hansen, and E. Bode. Third row—W. Hubbard, recipient of 60-year pin; H. Williamson, W. Little, C. Mort, L. Fessenden, C. Harris, E. Struttman, G. Olson, E. Emerick and L. P. Byrne.

(2) Twenty-five-year pins went to the following members of 2436 at the presentation event; 1st row, (from left)—H. Powers, E. Michaels, G. Sparks, H. Irving, M. Fink, F. Pilling, O. Klatre and T. Kilian; 2nd row (from left)—L. Bergeron, J. Deamio, G. Scofield, L. Boutte, F. Finley and A. Woods; 3rd row (from left)—T. G. White, A. Kuhlman, W. Madison, J. Wineinger, N. Gates, R. Higginson, S. Bruning, C. Weiche and J. A. Davis.

(3) 60-YEAR MEMBERSHIP! Inglewood Local 2435 took great pride in presenting a 60-year pin to William A. Hubbard, center, above. On the left, one of our distinguished guests, Harry Daw-



3

son, president of the Los Angeles District Council of Carpenters, who presented the pin and on the right, Robert B. Clubb, president and business representative of Local 2435.



REPORT

Recent Membership Contributions to the Carpenters Legislative Improvement Committee

■ Listed herewith are contributions from local unions to CLIC up to May 15th.

From all indications, the general membership is becoming much more aware of the need for labor having a strong voice on Capitol Hill.

President Nixon's suspension of Davis-Bacon provisions on federally-financed construction made it abundantly clear that the Administration has little sympathy or respect for building trades unions.

Although he soon reversed himself on the Davis-Bacon order, he took another tack for clamping down on construction labor. Without making any effort to control land costs, profits, or other components of construction costs, he placed restrictions on construction wage increases.

All this hanky-panky by the Administration has awakened the membership of building trades unions to the importance of building up our political muscle.

The only way that the building trades can be certain that they will not continue to be a political football is by building up the kind of political strength that is needed to reverse the trend.

A long time ago, a wise labor leader said that government can take away all that has been won at the bargaining table. The present situation tends to bear this out. Therefore, the importance of CLIC is greater than it ever has been, and the need for supporting it is equally great. ■

ALASKA					
1243	Fairbanks	\$10.00*	2789	Arcata	20.00*
2520	Anchorage	72.00	2801	Oroville	10.00*
ARIZONA			2882	Santa Rosa	20.00*
			2907	Weed	10.00*
857	Tucson	100.00	3006	Trinidad	10.00*
906	Glendale	10.00	3074	Chester	30.00*
1089	Phoenix	10.00	3088	Stockton	10.00*
			3184	Fresno	10.00*
CALIFORNIA		COLORADO			
25	Los Angeles	15.00	55	Denver	10.00
36	Oakland	10.00*	362	Pueblo	8.00
162	San Mateo	15.00	418	Greeley	10.00
586	Sacramento	148.00	CONNECTICUT		
668	Palo Alto	10.00	30	New London	10.00*
944	San Bernardino	10.00	43	Hartford	10.00*
1052	Hollywood	60.00	127	Derby	15.00
1113	San Bernardino	10.00	210	Stamford	30.00*
1296	San Diego	100.00	DELAWARE		
1453	Huntington Beach	10.00	626	Wilmington	10.00
1497	E. Los Angeles	10.00	FLORIDA		
1752	Pomona	10.00	627	Jacksonville	154.27
1976	Los Angeles	10.00	1250	Homestead	110.00
2046	Martinez	40.00	1394	Fort Lauderdale	20.00
2164	San Francisco	10.00	1447	Vero Beach	30.00
2288	Los Angeles	10.00*	1515	Pensacola	10.00*
2308	Fullerton	17.00	1554	Miami	10.00
2341	Willits	20.00*	1725	Daytona Beach	80.00
2505	Klamath	30.00*	1766	Boca Raton	20.00
2559	San Francisco	10.00*	2024	Miami	170.00
2608	Redding	40.00*	2795	Fort Lauderdale	30.00
2652	Standard	10.00*			
2728	Oho Ranch	20.00*			

3206	Pompano Beach	90.00
GEORGIA		
225	Atlanta	10.00
IDAHO		
1258	Pocatello	10.00*
2816	Emmett	40.00*
ILLINOIS		
1	Chicago	110.00
13	Chicago	120.00
21	Chicago	10.00
62	Chicago	25.00
183	Peoria	10.00
242	Chicago	10.00
434	Chicago	30.00
448	Waukegan	55.00
480	Freeburg	40.00
644	Pekin	44.00
742	Decatur	10.00
839	Des Plaines	253.00
1128	La Grange	10.00
2014	Barrington	40.00
INDIANA		
565	Elkhart	10.00
694	Boonville	20.00
1003	Indianapolis	20.00
1317	E. Chicago	7.00
KENTUCKY		
1080	Owensboro	60.00
2058	Frankfort	39.00
LOUISIANA		
1846	New Orleans	10.00
MASSACHUSETTS		
32	Springfield	140.00*
33	Boston	115.00*
40	Boston	90.00*
48	Fitchburg	40.00*
49	Lowell	101.00*
51	Boston	80.00*
56	Boston	90.00*
67	Boston	100.00*
82	Haverhill	20.00*
107	Worcester	60.00*
111	Lawrence	60.00*
193	N. Adams	20.00*
218	Boston	70.00*
327	Attleboro	20.00*
351	Northampton	40.00*
390	Holyoke	50.00*
424	Hingham	20.00*
444	Pittsfield	40.00*
549	Greenfield	20.00*
595	Lynn	30.00*
624	Brockton	60.00*
656	Holyoke	30.00*
762	Quincy	30.00*
831	Arlington	20.00*
858	Clinton	10.00*
860	Frammingham	40.00*
866	Norwood	20.00
878	Beverly	99.00*
885	Woburn	40.00*
888	Salem	20.00*
988	Marlboro	20.00*
1035	Taunton	30.00*
1121	Boston Vicinity	20.00*
1144	Danvers	10.00*
1210	Salem	10.00*
1305	Fall River	40.00*
1331	Barnstable Co.	20.00*
1416	New Bedford	20.00*
1459	Westboro	20.00*
1479	Walpole	30.00*
1503	Amherst	30.00*
1531	Rockland	20.00*
1550	Braintree	20.00*
2168	Boston	30.00*
MICHIGAN		
26	E. Detroit	15.00
297	Kalamazoo	10.00
335	Grand Rapids	25.00

674	Mt. Clemens	10.00
898	St. Joseph	10.00
1433	Detroit	20.00
1452	Detroit	10.00
1513	Detroit	100.00
1546	Detroit	10.00
2265	Detroit	20.00

MINNESOTA

87	St. Paul	6.00
1171	Shakopee	3.00

MISSOURI

61	Kansas City	101.00
----	-------------	--------

MONTANA

2405	Kalispell	10.00*
2581	Libby	30.00*
2685	Missoula	30.00*
2719	Thompson Falls	10.00*
3072	Plains	10.00*

NEW HAMPSHIRE

2276	Berlin	20.00
------	--------	-------

NEW JERSEY

15	Hackensack	116.00*
23	Dover	10.00*
31	Trenton	188.00*
155	Plainfield	10.00
325	Paterson	80.00
349	Orange	20.00*
393	Camden	10.00*
432	Atlantic City	30.00*
490	Passaic	70.00*
612	Union Hill	15.00
620	Madison	31.00*
715	Elizabeth	10.00
781	Princeton	10.00*
1006	New Brunswick	10.00*
1107	N. Plainfield	15.00
1209	Newark	10.00*
1489	Burlington	170.00*
1613	Newark	40.00
2018	Lakewood	130.00*
2098	Camden	10.00*
2250	Red Bank	130.00*

NEW MEXICO

1319	Albuquerque	434.00
1962	Las Cruces	5.00

NEW YORK

6	Amsterdam	10.00
53	White Plains	50.00
146	Schenectady	70.00
278	Watertown	10.00*
281	Binghamton	10.00
301	Newburgh	150.00
447	Ossining	80.00
453	Auburn	20.00
488	New York	100.00
502	Canandaigua	10.00
532	Elmira	20.00
603	Ithaca	20.00
608	New York	20.00
740	New York	10.00
808	New York	10.00
1204	New York	60.00
1318	Farmingdale	20.00
1508	Lyons	37.00
2054	Horseheads	10.00
2100	Amityville	20.00
2241	Brooklyn	30.00
2295	New York	10.00

NEVADA

1780	Las Vegas	10.00
------	-----------	-------

NORTH CAROLINA

1469	Charlotte	10.00
------	-----------	-------

OHIO

200	Columbus	5.00
637	Hamilton	10.00

Continued on Page 37

NEW, TOUGH AND DESIGNED

ROLLED EDGES FOR MAXIMUM STRENGTH AND SAFETY

EXTRA HEAVY-DUTY LID SUPPORTS WORK WITH ONE HAND

SLIDING TRAY WITH MOVEABLE PARTITIONS

PIANO HINGES HIDDEN FROM WEATHER & TAMPERING

OVERLAPPING EDGES AND RAIN GUTTER TO KEEP OUT WEATHER

END COMPARTMENT FOR SMALL HAND TOOLS AND MATERIALS

WEATHERGUARD CROSS BOXES

• Four sizes—9 cu. ft. to 18 cu. ft.—answer every need for on-truck storage and protection of tools, equipment and material. Can be used alone or in combinations with side boxes.

MODELS UP TO 18 CU. FT. CAPACITY

\$125.00-\$160.00



weather guard

Weatherguard has been designed with tough 16 ga. steel rolled edges and ribbed sides and bottom to produce a rugged chest that keeps out weather—and pilfers. Easy to install, Weatherguard is by far the best pick-up truck chest for the money available today.



\$175.00-\$205.00 Pair

WEATHERGUARD SIDE BOXES • Big capacity, tough design. Use alone or in combination with cross boxes. Two models.

OVERHEAD RACK • Transportation of ladders and extra-long material is an easy assignment with the Weatherguard overhead rack. Pre-drilled for easy assembly to truck bed.

\$145.00



Direct access from either side



Easy install

100% rear and side visibility



Loading space between chest and truck bed

Use in combination



Stake holes remain clear

KNAACK® MANUFACTURING COMPANY
420 E. Terra Cotta Ave., Crystal Lake, Ill. 60014
815/459-6020

WRITE FOR FREE 1971 WEATHERGUARD CATALOG. Also available on request is Knaack 1971 catalog. Wholesale inquiries invited.

Prices above are F.O.B.





Outdoor Meanderings

Readers may write to
Fred Goetz
 2833 S. E. 33rd Place,
 Portland, Oregon 97202

Looking back over recent months of angling activities by the Brotherhood and their families, it appears that some noteworthy catches were made. Following are but a few which we failed to cover in previous columns:

■ Post-Derby Fish

Before getting off the subject of winter fishing, we're bound to pass on an outstanding catch from Conesus Lake, New York, by Robert A. Tuttle of Rochester, New York, a member of Rochester Local 72 for over 15 years. Here's graphic proof of Brother Tuttle's ice-fishing prowess; he's holding a 14-lb., 12-oz. northern he eased from Conesus this past February 21st. It topped the "Ice Fishing Derby" winner at Conesus by one inch but was, unfortunately, caught a week after the derby closed.



Tuttle and Northern Pike.

■ Clothesline Fish

Sometime ago we received a letter which asked the question: What the heck is a "clothesline specimen?" In our books, it's any kind of fish that is worthy of hanging on the clothesline and here's a good example of the term embodied



Bonvicin and string.

in a photograph sent in by Peter Bonvicin, longtime member of Local 28, Providence, Rhode Island, since retired and living in Bristol, R.I. He clotheslined this quartette of bluefish, which ranged from seven to ten pounds, after easing them from the icy waters of nearby Narragansett Bay.

■ Carefree Californians

There are many phases of the angling pastime, various techniques employed in lake, streams and saltchuck, but I must say I've never met a fisherman in any category who derived more joy and re-



Grace Roberts and Scotty Wagner.

laxation than the "armchair anglers." Two such "light and easy anglers," are Grace Roberts, and M. J. "Scotty" Wagner, a delegate to the District Council for 27 years and a retired member of the Sacramento local. Here's a look-see at the pair while fishing off the bank.

■ The Shark Returns

Cliffside, New Jersey correspondent Albert Mutz actually "caught the big one that got away." He lost hook, line, and sinker to one while fishing the surf off Tuckerton, N.J. Next day he came back to the exact spot, had another vicious strike, and eased a large sand shark to beach. Hanging from the shark's lower jaw was the gear he lost the day before.

■ God's Country?

Sam Nelson of Fort Francis, Ontario, a member of Local 1669, says the air is fresh, the woods are clean and the lake waters sparkling and pure. He refers to the Fox Lake area, 30 miles east of Atihaken. Says Brother Nelson:

"Dear Fred:

"This is wonderful country. The fish in this lake are plentiful, scrappy and excellent eating. We never been out there once when all of us didn't get our limit—a mixed bag of walleyes and north-erns." Enclosed is a picture to show fellow members of the Brotherhood what we mean."



Sam Nelson and crew.

■ Back casts

... Avid anglerette is Mrs. E. L. Birmingham of Kennewick, Washington who, we hear, was the first to join the Ladies Auxiliary of Local 678, Pasco, Washington. Also hear that Marie tapped Jameson Lake on the Cougar State's Douglas County for a limit of hunky rainbow trout.

... Brother J. G. Anderson, retired out of Local 1634, Big Spring Texas, says the bass fishing is great in Madison County in the Lone Star State. Last time out, he brought back a howed-in-the-middle stringer of bass—eight of 'em, weighing 24 pounds in total.

■ Ice Fishing



When "Old Man Winter" comes blowing into town, with freezing winds, ice and snow, it's the sign for most anglers to pull in their necks and store fishing tackle away 'til spring. But not for the Dankovich family, headed by Mitch Dankovich of McKeesport, Pennsylvania, a member of Local 1048. Mitch and wife Gerry give their two children—Karen and Mitch—the high sign when the temperatures start to fall and ice forms over the lake. It is then they get out their winter fishing gear and plenty of warm clothing. In no time at all, they're out on ice-crustured Somerset Lake where

they fish from early morn' 'til dark—and catch fish too.

Here's youngsters Karen and Mitch with but one example, a 26-inch northern they nipped with the temperatures hovering around zero.

■ More Moose Meat

Ilk Iwaniuk of Creston, British Columbia, contends that moose hunting is "the most thrilling and worthwhile sport there is" and sends in the accompanying photograph of himself with the graphic results of a past hunt out of Alexander Creek near Crows-Nest Pass. "This moose," he advises, "dressed out at 960 pounds." Brother Iwaniuk has been a member of Local 3014 for 17 years.



■ Ecology Comment

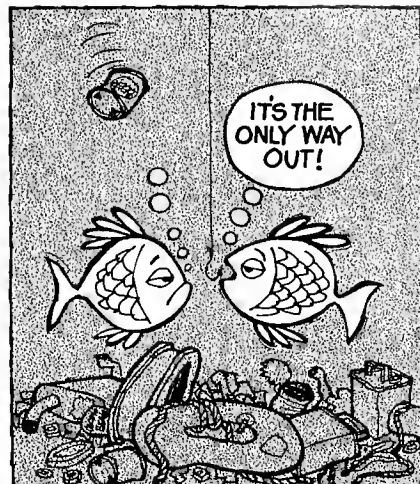

■ Sure-Shot Shooters

When Larry Keck of Sylvania, Ohio, a member of Local 1138, Toledo, and his five hunt buddies set out for a deer hunt in northern Michigan they did so with the advice that only one in six hunters bag a deer in that state. They came back with six deer, and Larry offers the following short but to-the-point explanation for their success: "None of us missed our shot when the chance came."

Contractors, Carpenters, Custom Filers . . . Save Time, Save Money with *FAMOUS* FOLEY Sharpening Equipment

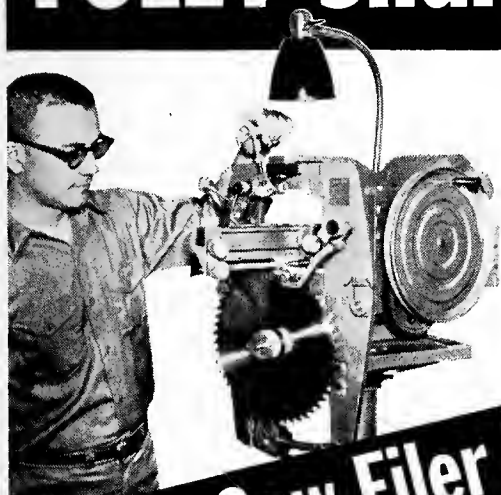

Foley Saw Filer

Sharpens crosscut circular saws, combination (rip and crosscut) circular saws, hand saws and hand saws! Exclusive Foley principle of jointing the saw as it is filed keeps all teeth uniform in size, shape and spacing; keeps circular saws perfectly round, usually doubles saw life. In use today all over America.

SEND FOR FREE LITERATURE TODAY!

Foley automatic sharpening equipment has the skill to do a perfect job every time—NO "human error". And no experience is necessary to accomplish a professional job. All Foley equipment is quality built to precision specifications.

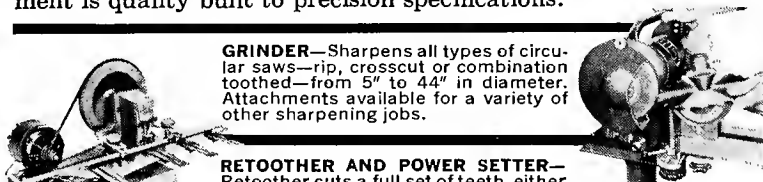

GRINDER—Sharpens all types of circular saws—rip, crosscut or combination toothed—from 5" to 44" in diameter. Attachments available for a variety of other sharpening jobs.



RETOOTER AND POWER SETTER—Retooter cuts a full set of teeth, either rip or crosscut, in less than a minute. Operated either by motor or by hand crank. Power setter automatically sets band saws up to 1½" in width, as well as all carpenter's hand saws, either rip or crosscut.



FOLEY CARBIDE SAW GRINDER—New precision machine grinds face, top, sides of carbide blades. Sharpens old teeth and replacement tips. Reduces saw downtime, high sharpening cost.

FOLEY MANUFACTURING COMPANY

618-1 Foley Bldg. • Minneapolis, Minnesota 55418

Please send me FREE booklets checked below:

"Money Making Facts" Automatic Saw Filer Automatic Grinder
 Carbide Saw Grinder Automatic Retooter Automatic Power Setter

Name _____

Address _____

City _____ State _____ Zip _____



IN MEMORIAM

**L.U. NO. 1
CHICAGO, ILL.**

Berthold, William
Clemensen, Harold K.
Keil, Peter J.
Lynn, Otto
Martin, Glenn
Moran, William T.
Reschke, Arthur M.
Smits, John
Swanson, Trenning

**L.U. NO. 15
HACKENSACK, N.J.**

Eckel, Robert
Marshall, John

**L.U. NO. 18
HAMILTON, ONT.**

Reid, Donald

**L.U. NO. 21
CHICAGO, ILL.**

Lombardo, J.

**L.U. NO. 34
S. FRANCISCO, CALIF.**

Crawford, Arment
Hill, Shellie D.
Prudden, Thomas A.

**L.U. NO. 36
OAKLAND, CALIF.**

Babino, Thomas
Castain, Thurston
Jewell, Robert J.
Morris, Sylvan
Nyquist, Justus
Williams, Albert F.

**L.U. NO. 40
BOSTON, MASS.**

Doiron, Joseph
McLellan, Urban
MacKinnon, John D.
Thistle, Adam C.

**L.U. NO. 50
KNOXVILLE, TENN.**

Mayes, Jack E., Sr.

**L.U. NO. 67
BOSTON, MASS.**

MacDonald, John P.
MacKinmon, Albert E.
MacMillan, Hugh
McEachern, Daniel
Morrison, John R.
Nelson, Carl A.
Vincent, Harry L.

**L.U. NO. 101
BALTIMORE, MD.**

Davis, Stanley W.

**L.U. NO. 117
ALBANY, N.Y.**

Anderson, Raymond G.
Czech, Theodore
Henderson, Charles F.
Jauss, George
Kirchner, Charles
LeClaire, Walter
Mackie, Thomas
Meizinger, Peter A.
Middlebrooks, Eugene
Schramm, Herman
Vermette, Wilfred J.

Weinstein, Samuel
Wilson, Alex

**L.U. NO. 129
HAZLETON, PA.**

Schmerfeld, Howard F.

**L.U. NO. 132
WASHINGTON, D.C.**

Cunningham, Lester Lee
Kenney, Lester Lee

**L.U. NO. 181
CHICAGO, ILL.**

Bovling, Kristian
Burke, Bernt
Holt, Bert
Kiran, Einar

**L.U. NO. 200
COLUMBUS, OHIO**

Park, Robert W.

**L.U. NO. 213
HOUSTON, TEX.**

Rabern, Walter Lee

**L.U. NO. 226
PORTLAND, ORE.**

Davis, J. O.
Wertman, O. S.

**L.U. NO. 246
NEW YORK, N.Y.**

Calvaruso, Anthony
Goldenberg, Abraham H.
Monson, Edward
Nagy, Nicholas, Sr.
Plesz, Vladimir

**L.U. NO. 257
NEW YORK, N.Y.**

Hlinko, John
Jeschke, Andrew E.
Johnson, Knute V.
Lindman, John
Oleskowitz, Joseph
Simonson, C. W.
Solvold, Trygve

**L.U. NO. 264
MILWAUKEE, WISC.**

Juel, Edward
Plasch, Rudolph
Vanselow, Roman
Visnapuns, Karlis T.
Zastrow, Erwin
Zorn, Fritz

**L.U. NO. 272
CHICAGO HGTS., ILL.**

Bovara, Angelo

**L.U. NO. 278
WATERTOWN, N.Y.**

Keller, David
Palmer, Simeon

**L.U. NO. 281
BINGHAMTON, N.Y.**

Benkovsky, William
Russell, George H.

**L.U. NO. 287
HARRISBURG, PA.**

Donaldson, Jesse L.
Fake, William F.

**L.U. NO. 289
LOCKPORT, N.Y.**

Bale, Howard

**L.U. NO. 322
NIAGARA FALLS, N.Y.**

Brown, Homer
Kline, Daniel
Lund, Leif
Moore, Arthur
Wermuth, Fred
Wills, Earl

**L.U. NO. 331
NORFOLK, VA.**

Wear, Ernest G.
Twiford, Earl D.

**L.U. NO. 345
MEMPHIS, TENN.**

Attaway, E. H.
Boehm, L. M.
Bramble, F. E.
Coulter, T. D., Sr.
Curtis, Clay
Harper, W. Q.
Hart, H. R.
Henderson, Jesse
Lawrence, C. L.
Oldham, M. B.
Pulliam, A. H.
Riley, W. M.
Sparks, G. W.
Todd, A. D.
Russell, G. M.
Whitlock, G. L.
Wilshire, C. A.

**L.U. NO. 359
PHILADELPHIA, PA.**

Betson, Thomas
Daszkowski, Walter
Schumacher, William G.

**L.U. NO. 366
NEW YORK, N.Y.**

Hammer, George
Lachter, Abram

**L.U. NO. 406
BETHLEHEM, PA.**

Leister, Edwin S.

**L.U. NO. 413
SOUTH BEND, IND.**

Bowman, Vernon
Ramthun, Richard
Schieber, Paul
Wright, Charles A.

**L.U. NO. 414
NANTICOKE, PA.**

Buczewski, John G., Jr.

**L.U. NO. 434
CHICAGO, ILL.**

Belz, John
Carlson, Oscar
Cubalchini, Richard
Holmgren, H. S.
McDade, Archie
Nystrom, Carl
Orman, Thor
Penn, Nick
Sartori, Cesare

**L.U. NO. 470
TACOMA, WASH.**

Back, Olaf
Cooley, Frank
Dolle, B. C.
Kvamme, J.
Laing, W. W.
v. William F.
Strom, Knute
Therhault, I. E.
Thompson, Ellis
Van Sickle, Alfred

**L.U. NO. 488
NEW YORK, N.Y.**

Ferm, Christian
Gnida, Louis
Pransky, Hyman
Schechtman, Jack

**L.U. NO. 501
STROUDSBURG, PA.**

Winters, Russell

**L.U. NO. 562
EVERETT, WASH.**

Brumbaugh, Michael J.
Carlson, Erick G.
Edwards, William (Bill) M.
Trevallee, Milton

**L.U. NO. 576
PINE BLUFF, ARK.**

Allen, Jeff C.
Barnett, Ralph E.
Dean, W. H.
Griffin, Sykes
Hoyle, Roland
Spakes, Foy
Spakes, Odell
Verdue, John
Waters, Richard R.

**L.U. NO. 586
SACRAMENTO, CALIF.**

Aksdal, Carl
Best, Paul
Brida, John C.
Geist, Adam
Gibson, Robert G.
Griffin, Henry C.
Hewston, Edward R.
Maxwell, Searl A.
Witham, Archie G.

**L.U. NO. 627
JACKSONVILLE, FLA.**

Braddock, Bert D.
Brown, Donald M.
Crawford, P. L.
LeBlanc, Fidel
Scholl, John J.

**L.U. NO. 756
BELLINGHAM, WASH.**

Anderson, Hugh
Baeten, Paul
Fleming, John P.
Flugekvam, Harvey J.
Genger, James L.
Little, Lew C.
Moen, Elmer
Wilson, Raymond

**L.U. NO. 769
PASADENA, CALIF.**

Choate, Bob
Dapper, Harold

Gaulton, Norman
Gnewuch, Ortwin
Hardnock, W. L.
Havlik, Emil
Johnson, Arthur L.
Knudson, Harry
MacDonald, Fred
Miller, Stephen C.
Nemeyer, Clarence D.
Reynolds, William

**L.U. NO. 783
SIOUX FALLS, S.D.**

Loecker, Anton
Michael, Fred

**L.U. NO. 791
NEW YORK, N.Y.**

Bergman, Arthur
Guenckel, Joseph
Lindgren, Victor

**L.U. NO. 916
AURORA, ILL.**

Reed, Joe

**L.U. NO. 982
DETROIT, MICH.**

Williams, Ellis R.

**L.U. NO. 985
GARY, IND.**

Patrick, William
Picket, Linton
Troy, John

**L.U. NO. 1075
HUDSON, N.Y.**

Haviland, John G.

**L.U. NO. 1098
BATON ROUGE, LA.**

Poche, Ned J.
Roach, Frank

**L.U. NO. 1138
TOLEDO, OHIO**

Antoszewski, Leo
Black, Roy
Dibert, Walter
Halsey, Harold
Mollenkopf, Glenard
Pollock, Robert L.

**L.U. NO. 1140
SAN PEDRO, CALIF.**

Anderson, Samuel B.
Brummett, L. L. (Tex)
Goldsbury, Hugh R.
Kristianson, Elinas
Monson, Leslie E.

**L.U. NO. 1154
ALGONAC, MICH.**

Biland, Al

**L.U. NO. 1160
PITTSBURGH, PA.**

Brobst, Sidney H.
Kraly, Joseph

**L.U. NO. 1195
SEATTLE, WASH.**

Conroy, Jack F.

**L.U. NO. 1292
HUNTINGTON, N.Y.**

Candros, Louis
Edwardsen, Tonnes

Michalowski, Ben
Ondalstol, Jonas
Peltola, George
Popp, Samuel
Sinusas, Albert

**L.U. NO. 1332
GRAND COULEE,
WASH.**

Trust, Joe

**L.U. NO. 1335
WILMINGTON, CALIF.**

Armstrong, George B.
Partridge, Ernest

**L.U. NO. 1367
CHICAGO, ILL.**

Donelson, Paul S.
Gross, Anthony
Rodnick, Joe

**L.U. NO. 1397
NORTH HEMPSTEAD,
N.Y.**

Peterson, Austin

**L.U. NO. 1453
HUNTINGTON BEACH,
CALIF.**

Card, Bruce
Guenther, Robert
Montgomery, Harry
Tunnell, Carl
Wheeler, A. M.
Wilson, J. E.

**L.U. NO. 1541
VANCOUVER, B.C.**

Rozewicz, Vincent

**L.U. NO. 1456
NEW YORK, N.Y.**

Boyd, Andrew
Fitzgerald, Michael
Knudsen, Albert
Kristiansen, Enok
Lassila, Aarne
Larsen, Lonis
Latva, George
Lundrigan, William
Mattson, Bengt
Michaelsen, Leandor
Salvesen, Ole
Svennevik, Torvald
Thompson, Hans
Thompson, Theodore
Walstrom, Theodore

**L.U. NO. 1707
LONGVIEW, WASH.**

Hillman, Miles M.
Poston, Barleigh E.

**L.U. NO. 1822
FORT WORTH, TEX.**

Hill, Lawrence

**L.U. NO. 1846
NEW ORLEANS, LA.**

Herzog, Frank
Kuster, John

**L.U. NO. 1849
PASCO, WASH.**

Combs, Wesley J.

**L.U. NO. 1855
BRYAN, TEX.**

Fleckenstein, Johnny

**L.U. NO. 1865
MINNEAPOLIS, MINN.**

Christenson, Martin L.
Dahlberg, William
Olson, Harold
Turnquist, Rager

Wothe, Henry C.

**L.U. NO. 1941
HARTFORD, CONN.**

Tomaiuolo, Carmine

**L.U. NO. 2012
SEAFORD, DEL.**

Dickerson, James B.

**L.U. NO. 2018
LAKEWOOD, N.J.**

Fisher, Charles G.
Mehner, Lenard
Pagles, Herman

**L.U. NO. 2084
ASTORIA, ORE.**

Gann, William V.

**L.U. NO. 2203
ANAHEIM, CALIF.**

Jackson, Charles R.
Martin, G. Wallace
Rosenow, John
Settje, Lawrence
Wiebalck, William H.

**L.U. NO. 2213
MISSION CITY, B.C.**

Raabe, Carl Robert

LEGACIES OF LONG SERVICE

Local 29, Cincinnati, O., recently lost a member who had been in good standing for 68 years. Keller Day was born August 20, 1878, and died on March 7, 1971. He was initiated into the Brotherhood on June 27, 1903.

Local 1135 of Port Jefferson, N.Y., reports the recent death of Samuel E. Faron, who had been a member since October 17, 1907. Faron was born on July 11, 1886, and he died on March 12, 1971.

Local 1128, LaGrange, Ill., mourns the death, last October 30, of its oldest member, John Westphal. Brother Westphal was a charter member and past president of the local union and had been a member of the Brotherhood for 61 years, joining on November 19, 1909. He was 95 when he died.

The oldest member of the Brotherhood in the metropolitan area of Philadelphia, Pa., passed away last year. He was George Dunlop, a member of Local 1856 and a member of the Brotherhood since 1897. He was 92.

CLIC Report

Continued from Page 33

976 Marion 35.00
1079 Steubenville 10.00
1180 Cleveland 10.00
1189 Columbiana Co. 20.00
1426 Elyria 20.00
1454 Cincinnati 24.00
2280 Mt. Vernon 10.00

OKLAHOMA

986 McAlester 10.00

OREGON

190 Klamath Falls 20.00*
226 Portland 180.00*
573 Baker 10.00*
583 Portland 30.00*
738 Portland 60.00*
1020 Portland 60.00*
1065 Salem 30.00*
1094 Albany Corvallis 20.00*
1096 Coquille 20.00*
1120 Portland 30.00*
1157 Lebanon 20.00*
1223 Coos Bay 10.00*
1273 Eugene 30.00*
1277 Bend 10.00*
1388 Oregon City 30.00*
1411 Salem 20.00*
1746 Portland 10.00*
1857 Portland 60.00*
1896 The Dalles 30.00*
2066 St. Helens Vic. 20.00*
2067 Medford 50.00*
2130 Hillsboro 10.00*
2416 Portland 20.00*
2419 Astoria 20.00*
2530 Gilchrist 20.00*
2588 Bates 10.00*
2627 Cottage Grove 10.00*
2636 Valsey 20.00*
2691 Coquille 20.00*
2698 Banden 10.00*
2756 Goshen 10.00*
2784 Coquille 10.00*
2787 Springfield 30.00*

2791 Sweet Home 30.00*
2851 LaGrande 20.00*
2881 Portland 10.00*
2896 Lyons 10.00*
2924 John Day 20.00*
2942 Albany 10.00*
2949 Roseburg 40.00*
2961 St. Helens 10.00*
2970 Pilot Rock 10.00*
3035 Springfield 10.00*
3064 Toledo 10.00*
3091 Vaughn 20.00*

PENNSYLVANIA

8 Philadelphia 43.00
122 Philadelphia 60.00
261 Scranton 5.00
321 Connellsville 39.00
333 New Kensington 50.00
359 Philadelphia 10.00
465 Ardmore 20.00
500 Butler 33.00
709 Shenandoah 10.00
838 Sunbury 241.00
1073 Philadelphia 20.00
1333 State College 162.00
1856 Philadelphia 20.00
2274 Pittsburgh 200.00

RHODE ISLAND

94 Providence 60.00
801 Woonsocket 60.00

SOUTH CAROLINA

1798 Greenville 30.00

TENNESSEE

50 Knoxville 125.00
345 Memphis 15.00

TEXAS

198 Dallas 25.00
425 El Paso 20.00
1565 Abilene 10.00
1822 Fort Worth 15.00

UTAH

722 Salt Lake City 30.00
1498 Provo 10.00

VIRGINIA

388 Richmond 10.00
396 Newport News 122.00
1402 Richmond 20.00
1665 Alexandria 20.00

WASHINGTON

131 Seattle 101.00
338 Seattle 10.00*
470 Tacoma 10.00
770 Yakima 199.00
870 Spokane 20.00*
1036 Longview 20.00
1136 Kettle Falls 20.00*
1289 Seattle 70.00
1707 Kelso-Longview 6.00
1715 Vancouver 19.00
1845 Snoqualmie Falls 60.00*
1849 Pasco 20.00
2519 Seattle 20.00*
2633 Tacoma 40.00*
2659 Everett 10.00*
2767 Morton 20.00*
2805 Klickitat 30.00*
3099 Aberdeen 10.00*

WEST VIRGINIA

3 Wheeling 24.00
128 St. Albans 10.00
1339 Morgantown 10.00
2430 Charlestown 10.00

WISCONSIN

264 Milwaukee 25.00
849 Manitowoc 15.00
2073 Milwaukee 6.00

WYOMING

1564 Casper 164.00

TOTAL

\$11,191.27

* Includes contributions from delegates representing their local unions at the state council conventions. In some instances, these convention contributions were only monies received from the local unions.

You'll Like Being a SKILLED LOCKSMITH



You'll EARN MORE, LIVE BETTER than Ever Before in Your Life

You'll enjoy your work as a Locksmith because it is more fascinating than a hobby—and highly paid besides! You'll go on enjoying the fascinating work, year after year, in good times or bad because you'll be the man in demand in an evergrowing field offering big pay jobs, big profits as your own boss. What more could you ask!

Train at Home—Earn Extra \$\$\$\$ Right Away!

All this can be yours **FAST** regardless of age, education, minor physical handicaps. Job enjoyment and earnings begin **AT ONCE** as you quickly, easily learn to **CASH IN** on all kinds of locksmithing jobs. All keys, locks, parts, picks, special tools and equipment come with the course at no extra charge. Licensed experts guide you to success.

Illustrated Book, Sample Lesson Pages FREE
Locksmithing Institute graduates now earning, enjoying life more everywhere. You can, too. Coupon brings exciting facts from only school of its kind Lic. by N. J. State Dept. of Ed., Accredited Member, Natl. Home Study Council, VA Approved.

LOCKSMITHING INSTITUTE
Div. of Technical Home Study Schools
Dept. 1118-061 Little Falls, N.J. 07424

Earned \$150 During Training
I realized with **LOCKSMITHING** I'd be able to double my income. During my training period I made \$150.
Paul Finnes, New York, N.Y.



LOCKSMITHING INSTITUTE, Dept. 1118-061 Little Falls, New Jersey 07424 Est. 1948

Please send **FREE** Illustrated Book—"Your Big Opportunities in Locksmithing," complete Equipment folder and sample lesson pages—**FREE** of all obligation—(no salesman will call).

Name..... (Please Print)
Address.....
City..... State..... Zip.....
 Check here if Eligible for Veteran Training

Planer·Molder·Saw!

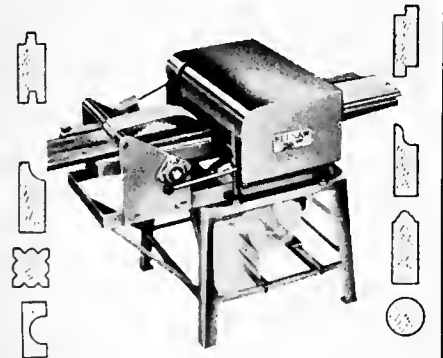

Now you can use this **ONE power feed** shop to turn rough lumber into high-value moldings, trim, flooring, furniture... **ALL** popular patterns.

RIP... PLANE... MOLD... separately or all at once by power feed... with a one horsepower motor. Use 3 to 5 HP for high speed commercial output.

LOW COST... You can own this **MONEY MAKING POWER TOOL** for only... **\$30.00** down.
Send coupon today

BELSAW POWER TOOLS
942-H Field Bldg., Kansas City, Mo. 64111
Send me complete facts on the **MULTI-DUTY Power Tool**. No obligation.
Name.....
Address.....
City..... State..... Zip.....



Lakeland News

Items of interest from the Brotherhood's retirement home at Lakeland, Florida

Four 'Arrivals' at Home During April

DeWitt Simmons of Local 1098, Baton Rouge, La., arrived at the Home April 6, 1971.

Louis, Mo., arrived at the Home April 26, 1971.

Evard M. Gentry of Local 64, Louisville, Ky., arrived at the Home April 9, 1971.

Rudolph Vettor of Local 1456, New York, N.Y., arrived at the Home April 26, 1971.

Wm. J. Cunningham of Local 185, St.

James W. Copithorne of Local 860, Framingham, Mass., withdrew from the Home April 2, 1971.

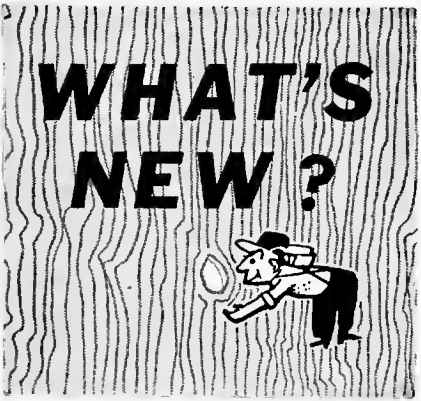

NARROW TONGUE-AND-GROOVE

Every now and then someone comes up with an idea for preventing waste. The latest to come to notice is a proposal to save waste by reducing the tongue on tongue-and-groove flooring from its present 3/16th inch width to 1/8th inch; a saving of 1/16th inch. A study by the U.S. Forest Service has shown that the load-bearing ability of a floor of the shorter-tongued flooring would be reduced although it is contended that it would not "cause problems in residential construction."

Percentage-wise, it would appear that 1/16th inch is not much to save. A greater saving might be effected by keeping the tongue at its present width, widening the boards themselves which have continuously grown narrower through the years.

FASTENER CATALOG

The job of specifying, buying, selling, or using structural wood fasteners is made easier with a 16-page catalog available from **TECO**.

Using columnar format for easier

readability, **TECO's** publication offers complete details on each of the company's many products including joist hangers, framing anchors, post and beam connectors, bridging, truss connectors, and other fasteners for wood construction. In addition to usage, complete information such as design values, dimensions, and packaging is clearly shown.

The catalog also contains an easy to read chart showing the correct installation tools for **TECO** shear plates, split rings, and spike grids.

To receive a copy of **TECO's** catalog, write **TECO**, 5530 Wisconsin Avenue, Washington, D.C. 20015.

INDEX OF ADVERTISERS	
Audcl, Theodore	19
Belsaw Power Tools	38
Chevrolet	17
Chicago Technical College	29
Cooper Industries	20
Craftsman Book Co.	13
Estwing Manufacturing	30
Foley Manufacturing	35
Fugitt, Douglas	19
Handbook for Riggers	25
Hydrolevel	13
Irwin Auger Bit Co.	23
Kedman Co.	24
Knaack Manufacturing	33
Locksmithing Institute	38
North American School of	
Surveying	14
Schaefer Manufacturing	23
Stanley Power Tools	Back Cover



MEMBER PRAISES LAKELAND HOME FOLLOWING TOUR WITH FATHER

Robert J. Cunningham
504 Kennerly Road
Springfield, Pa. 19064

April 30, 1971

Mr. Maurice A. Hutcheson, President
United Brotherhood of Carpenters and Joiners of America
101 Constitution Avenue, N. W.
Washington, D. C. 20001

Dear Maurice:

Over the weekend my Dad and I arrived at the Carpenters' Home in Lakeland, Florida and on Monday, Mr. Plymate officially accepted Dad as one of the permanent residents of the home.

During my visit there, Dad and I were received in a most hospitable manner. We were given a grand tour of the home and its wonderful facilities and I am frank to state that it was with a great source of fraternal pride that I learned for the first time and at first hand about the wonderful home, and the facilities which are afforded the senior members of the Brotherhood. I salute you and the Brotherhood for having had the foresight, the patience and the will to have established what I believe to be the finest home on the continent for the senior members of the Brotherhood.

Both my Dad and I wish to thank you for your kindness in having written to Financial Secretary, Otto Oelger.

It was a great source of satisfaction too, to learn about the nursing and health facilities and the recreation which has been provided such as shuffle-board, fishing, game rooms, T.V., etc.

I might add that my Dad was highly pleased as well as I was, to find that the Carpenters' Home was such an outstanding establishment.

Please be assured of our genuine appreciation.

Fraternally yours,

Robert Cunningham
Robert Cunningham



In Conclusion

M. A. Hutcheson, *General President*



Runaway Dollars Overseas Mean More Unemployment Here

■ At its Atlanta meeting, last month, the AFL-CIO Executive Council issued an exceptionally strong statement demanding sweeping new legislation to halt the export of American jobs.

Year-by-year since the end of World War II, American corporations have invested growing amounts of money in foreign countries. They have bought factories and built factories all over the world. They equip them with the latest and most efficient machines American technology has been able to develop. They send their best technicians to get the factories rolling.

As a result, competition from abroad, financed by American corporate dollars, is contributing very substantially to the better than 6% unemployment figure in the United States and Canada.

Much of this exodus of corporate dollars from the United States to foreign lands was made possible by existing tax structures which enable corporations to bypass the payment of U.S. taxes.

A showdown on the matter of multi-national corporations channeling more and more of their capital abroad to take advantage of low-wage labor is in the making. The trend towards greater corporate investments abroad is reaching disaster proportions which cannot be ignored any longer.

The proponents of free trade have one argument they constantly use in their efforts to thwart any legislative controls. They maintain that cheaper goods brought in from foreign countries keep the cost-of-living down in the U.S. and Canada. I wonder how much truth there is in this kind of argument.

As a case in point, let me cite the matter of transmission tower components recently purchased by a West Coast power authority. According to

the Labor Management Committee for Fair Foreign Competition, the amount of work involved in producing the tower components added up to about 2400 man-years of employment. I suppose the foreign-made components were cheaper in price than American-made might be. But this only tells part of the story.

Some 2400 Americans lost a year's work. Because they did not work, they did not pay taxes. If they averaged only \$300 per year in Federal income taxes, the nation lost 300 times 2400, or \$720,000 which other taxpayers had to make up. In addition, the 5% of pay which the workers would have contributed to Social Security was also lost. Again, this is money which had to be made up by the general public.

If only half of the 2400 wound up drawing unemployment insurance, this drained away tax dollars that also had to be made up, and I did not even mention the loss of revenue from taxes on profits paid by domestic but not foreign production.

When you add all these things together, I doubt if the purchase price of the foreign-made product was any bargain.

The main thrust of the statement issued by the Executive Council of the AFL-CIO revolved around the need for more effective controls on foreign investments. The statement also urged that some method of keeping the outflow of American technology in balance with domestic economic conditions be devised. Furthermore, I believe that some real attention needs to be given to the development of international fair labor standards, with the aim of gradually elevating wage rates throughout the world to end the wide disparity now existing. ■

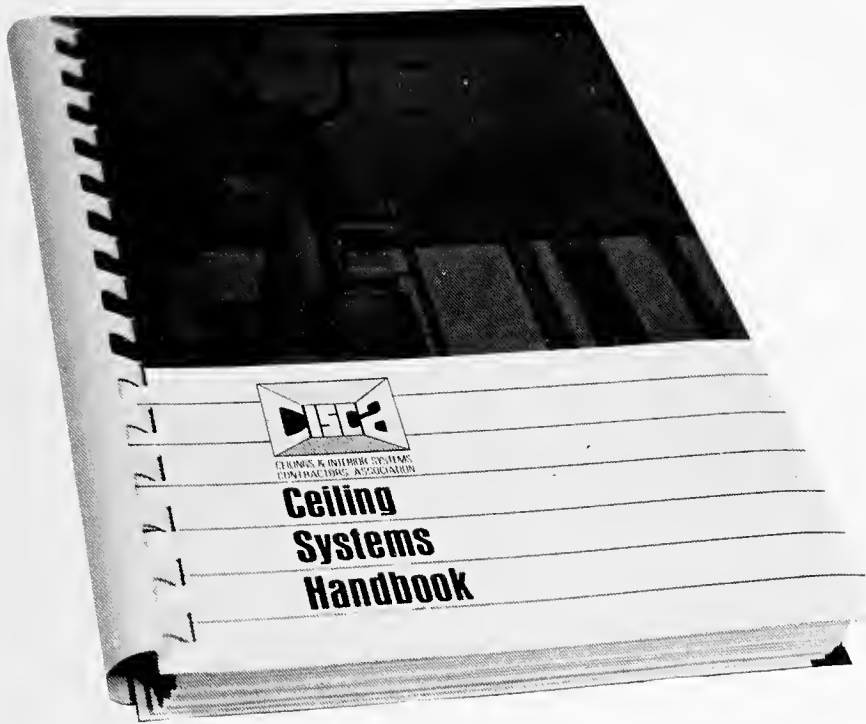

**LOOK
IT UP!**

**PUT
IT UP!**

... with this authoritative and comprehensive book on acoustical ceiling installation techniques. Years of planning and research have gone into this contractor-written training tool.

You'll find it easy-to-read, easy-to-follow with hundreds of illustrations showing important techniques ... in

concise, step-by-step form. A programmed learning section — LEARN THROUGH REVIEW — follows each of the 14 chapters.

6" x 9" pocket size book with durable, plasticized cover fits easily in toolbox or glove compartment.

**Order
Today!**

**FIND OUT WHY HUNDREDS
OF MEN IN YOUR TRADE
HAVE BOUGHT AND KEPT
THIS BOOK HANDY!**

Special Price:
\$4.25 per copy

(includes handling and postage)



**CEILINGS & INTERIOR SYSTEMS
CONTRACTORS ASSOCIATION**

To: **CEILINGS & INTERIOR SYSTEMS
CONTRACTORS ASSOCIATION**
1201 Waukegan Road
Glenview, Illinois 60025

Please enter my order for _____ copy(ies) of the
CEILING SYSTEMS HANDBOOK.

My check for \$ _____ is enclosed.

NAME _____

ADDRESS _____

CITY _____

STATE _____

ZIP _____

Stanley

cuts the chatter

(to make smoother work for you)

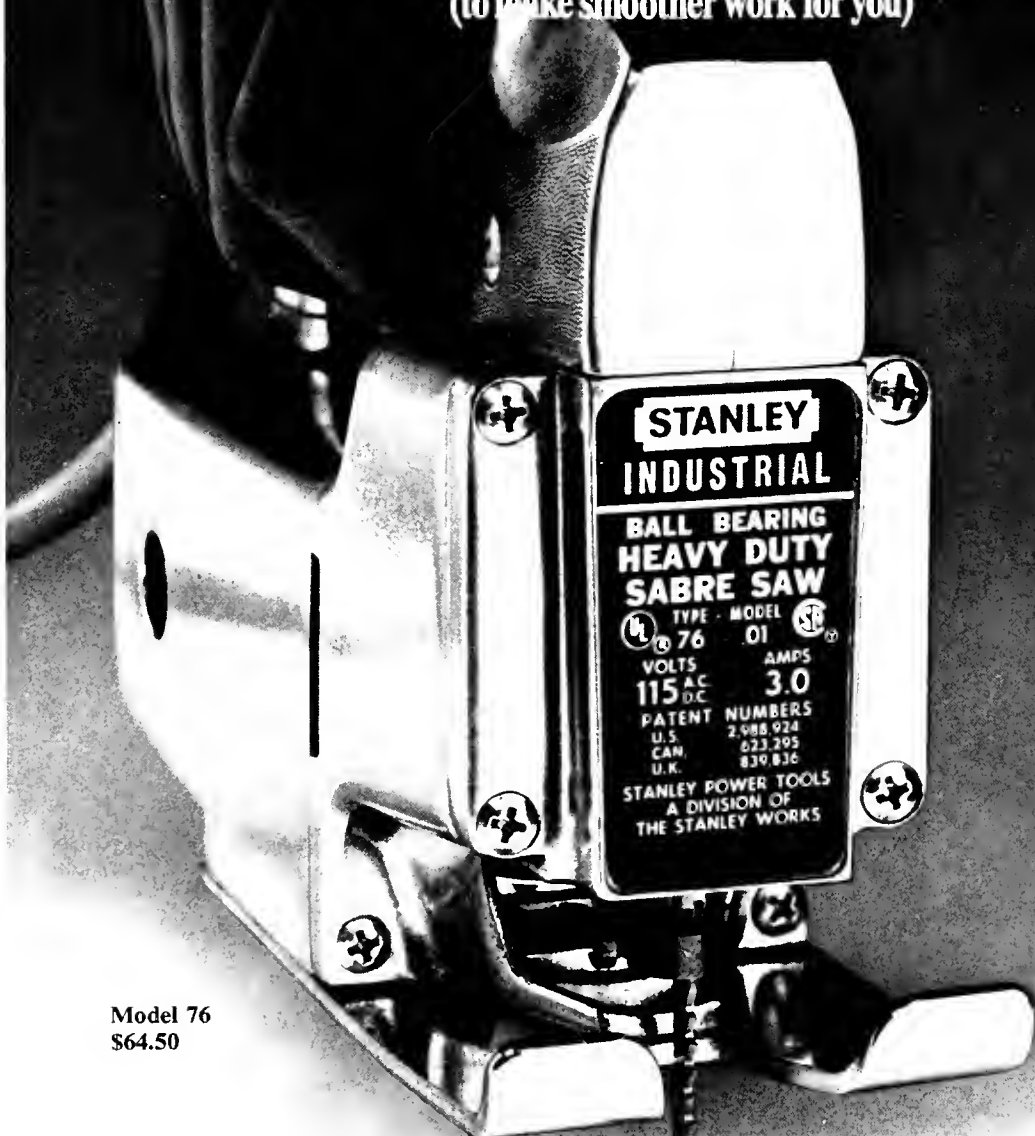

Model 76
\$64.50

No chatter. No rough edges. Less blade breakage. With Stanley sabre saws, a patented anti-vibration mechanism assures smooth, vibrationless cutting. Felt seals at each end of the plunger provide constant lubrication. Keeps oil in – dirt out. Like on our Model 76. A real “do anything saw.” Cuts curves, scrolls, fancy patterns – or rips 2” lumber and 1/2” steel, aluminum, brass and other metals. An oversized fan directs its powerful air blast toward your cutting line – to keep it clear of chips. An adjustable 2-position, non-marring base lets you flush cut right up to a vertical surface.

If that's not enough reason to buy a Stanley, consider this. The Model 76 is equipped with sealed ball-bearings to give you smooth transmittal of power from its 3.0 amp Stanley-made motor to the blade end of the saw. Separate handle for cool comfort and more control. Single slotted screw to hold blade rigid. See the complete line of Stanley sabre saws at your distributor. Stanley Power Tools, Division of The Stanley Works, New Bern, North Carolina 28560.

STANLEY
helps you do things right

P.S.: made by the same Stanley that makes the finest hand tools.

The CARPENTER

Official Publication of the UNITED BROTHERHOOD OF CARPENTERS AND JOINERS OF AMERICA • FOUNDED 1861



THE END OF AN ERA

LAST OF THE GREAT
WHITEWATER SAWLOG DRIVES

SEE STORY INSIDE

OFFICIAL INFORMATION

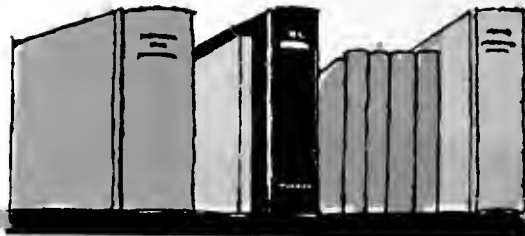

GENERAL OFFICERS OF THE UNITED BROTHERHOOD of CARPENTERS & JOINERS of AMERICA

GENERAL OFFICE:
101 Constitution Ave., N.W.,
Washington, D. C. 20001

GENERAL PRESIDENT

M. A. HUTCHESON
101 Constitution Ave., N.W.,
Washington, D. C. 20001

FIRST GENERAL VICE PRESIDENT

WILLIAM SIDELL
101 Constitution Ave., N.W.,
Washington, D. C. 20001

SECOND GENERAL VICE PRESIDENT

HERBERT C. SKINNER
101 Constitution Ave., N.W.,
Washington, D. C. 20001

GENERAL SECRETARY

R. E. LIVINGSTON
101 Constitution Ave., N.W.,
Washington, D. C. 20001

GENERAL TREASURER

PETER TERZICK
101 Constitution Ave., N.W.,
Washington, D. C. 20001

DISTRICT BOARD MEMBERS

First District, PATRICK J. CAMPBELL
130 North Main Street
New City, Rockland Co., New York
10956

Second District, RALEIGH RAJOPPI
2 Prospect Place, Springfield, New Jersey
07081

Third District, WILLIAM KONYHA
1830 Ledge Rd., R.D. No. 4
Medina, Ohio 44256

Fourth District, HAROLD E. LEWIS
340 Northwest 148th St.
Miami, Florida 33168

Fifth District, LEON W. GREENE
2800 Selkirk Drive
Burnsville, Minn. 55378

Sixth District, FREDERICK N. BULL
P.O. Box 14279
Oklahoma City, Okla. 73114

Seventh District, LYLE J. HILLER
Room 722, Oregon Nat'l Bldg.
610 S.W. Alder Street
Portland, Oregon 97205

Eighth District, CHARLES E. NICHOLS
Forum Building, 9th and K Streets
Sacramento, California 95814

Ninth District, WILLIAM STEFANOVITCH
2418 Central Avenue
Windsor, Ontario, Canada

Tenth District, GEORGE BENGOUGH
2528 E. 8th Ave., Vancouver 12, B. C.

M. A. HUTCHESON, *Chairman*
R. E. LIVINGSTON, *Secretary*

Correspondence for the General Executive Board
should be sent to the General Secretary.



Secretaries, Please Note

If your local union wishes to list deceased members in the "In Memoriam" page of *The Carpenter*, it is necessary that a specific request be directed to the editor.

In processing complaints, the only names which the financial secretary needs to send in are the names of members who are NOT receiving the magazine.

In sending in the names of members who are not getting the magazine, the new address forms mailed out with each monthly bill should be used. Please see that the Zip Code of the member is included. When a member clears out of one Local Union into another, his name is automatically dropped from the mail list of the Local Union he cleared out of. Therefore, the secretary of the Union into which he cleared should forward his name to the General Secretary for inclusion on the mail list. Do not forget the Zip Code number. Members who die or are suspended are automatically dropped from the mailing list of *The Carpenter*.

PLEASE KEEP *THE CARPENTER* ADVISED OF YOUR CHANGE OF ADDRESS

PLEASE NOTE: Filling out this coupon and mailing it to the *CARPENTER* only corrects your mailing address for the magazine. It does not advise your own local union of your address change. You must notify your local union by some other method.

This coupon should be mailed to *THE CARPENTER*,
101 Constitution Ave., N.W., Washington, D. C. 20001

NAME _____ Local No. _____
Number of your Local Union must
be given. Otherwise, no action can
be taken on your change of address.

NEW ADDRESS _____

City

State

ZIP Code

THE CARPENTER

VOLUME XCI

No. 7

JULY, 1971

UNITED BROTHERHOOD OF CARPENTERS AND JOINERS OF AMERICA

Peter Terzick, Editor



IN THIS ISSUE

NEWS AND FEATURES

Last of the Great Whitewater Sawlog Drives	2
Billion-Dollar Levitt Systems Now Tri-Trades	6
Breakthrough Housing Unit Undergoes Evaluation	8
The Bonds of International Brotherhood	11
Memo to Today's Youth: Look to Labor	14
Workers Hurt the Most in Trade Falloff	23

DEPARTMENTS

Washington Roundup	10
Canadian Report	Morden Lazarus 12
We Congratulate	18
Local Union News	20
Plane Gossip	22
Service to the Brotherhood	29, 30, 34
Apprenticeship and Training	24
Your Union Dictionary	28
CLIC Report	32
Outdoor Meanderings	Fred Goetz 33
In Memoriam	36
What's New?	38
Lakeland News	39
In Conclusion	M. A. Hutcheson 40

POSTMASTERS, ATTENTION: Change of address cards on Form 3579 should be sent to THE CARPENTER, Carpenters' Building, 101 Constitution Ave., N.W., Washington, D. C. 20001

Published monthly at 810 Rhode Island Ave., N.E., Washington, D. C. 20018, by the United Brotherhood of Carpenters and Joiners of America. Second class postage paid at Washington, D. C. Subscription price: United States and Canada \$2 per year, single copies 20¢ in advance.



Printed in U. S. A.

THE COVER

The great whitewater sawlog drives of the Pacific Northwest, a colorful, exciting chapter in American history, ended for all time a few weeks ago when Potlatch Forests, Inc., completed its 1971 log drive down the turbulent North Fork and main Clearwater Rivers to Lewiston, Idaho.

Doomed by the impending completion of the giant Dworshak Dam on the North Fork of the Clearwater, the last drive got underway when Potlatch drive crews entered the upper reaches of the North Fork behind some 51 million board feet of prime Idaho logs. It ended in May and June as river conditions permitted completion of the work.

The last Potlatch drive, the 40th to be held on the Clearwater since the first drive was organized in 1928, brought footage totals to more than one billion, 774 million board feet of logs delivered to the mill pond at Lewiston. (A board foot is one inch thick and 12 inches square.)

Led by Charles "Red" McCollister, log drive foreman and a veteran of 21 years on the river, the drive crews followed the logs downriver, breaking up jams and forcing stranded logs back into the main current. Armed with the lumberjack's traditional pike pole and peavey hook, the 34 members of the drive crews worked, ate, and slept on the river until the drive was completed. Trucks and trains will haul logs to the mill in the future.

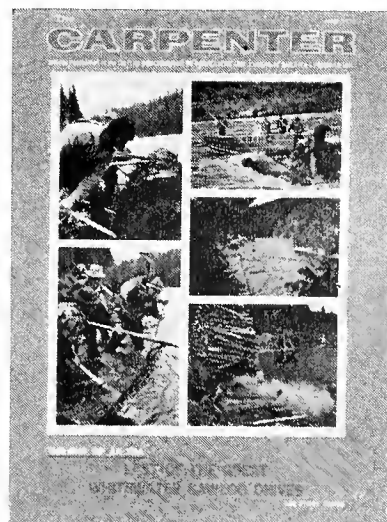

The End of An Era

Last of the Great Whitewater Sawlog Drives

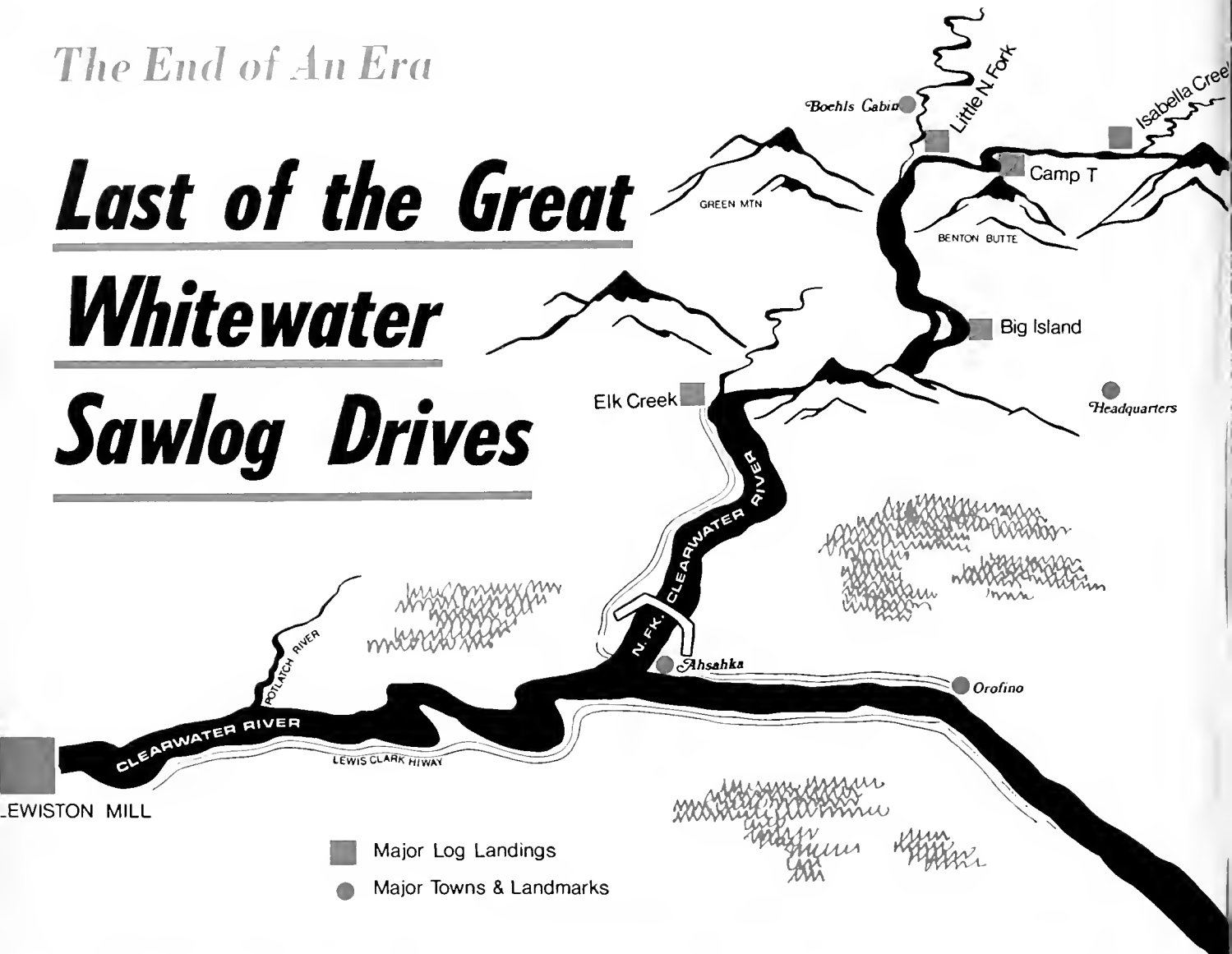

A Potlatch rearing crew seeks the key log that will permit this center jam to "haul" and, hopefully, unravel itself. Only experienced drivers are permitted to work center jams, while beginners are restricted to jams along the river's banks.



■ Doomed by the impending completion of Dworshak Dam, which will transform Idaho's turbulent North Fork of the Clearwater River into a placid reservoir, this country's last major sawlog drive got underway a few weeks ago when "rearing" crews from Potlatch Forests, Inc., entered the North Fork at Camp T behind some 51 million board feet of prime Idaho logs.

It ended 90 miles downstream when the final logs reached the Potlatch mill pond at Lewiston, Idaho, bringing footage totals for all the Clearwater River drives to more than one billion, 774 million board feet of logs.

Listed as Log Drive Number 40 in Potlatch records, the drive officially began with the start of rearing work. However, a great deal of preparatory effort was necessary before it could begin.

Logs harvested from the surrounding forests during the past year had to be hauled to several points along the river's edge, stockpiled in huge decks 40 feet high and up to half a mile long, and then dumped into the North Fork at just the proper moment. Only when all the decks were dumped did the rearing crew begin its operations.

When to "water" the logs is a decision made by Charles "Red" McCollister, log drive foreman and a veteran of more than 30 years in the logging camps and 21 years on the river. "We trip the decks with bulldozers or grapple cranes when the river is high and rising," McCollister says. "Under those conditions, the logs are drawn to the center of the stream for a fast, 18-hour trip to the mill pond."

Conditions change, however, and undesired cold snaps can cause the river to drop quickly, stranding and jamming thousands of logs along its banks, islands, and sandbars. It is then that the rearing crews begin to earn their pay, working, eating, and sleeping on the river for weeks and sometimes months before the drive is completed.

Armed with the traditional pike poles, peavey hooks and "corked" (caulked) boots, the 34 members of the rearing crews operate in a man-

Backbreaking stamina was needed by these oarsmen of several decades ago, when all they had to fight the river was a wooden bateau and sturdy arms.



"She's Hauling!" Scrambling for safety, a Potlatch driver "walks on water" as a wing jam begins to pull itself free.

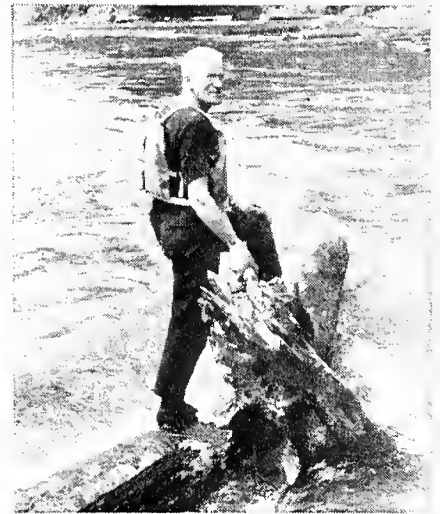

Log drive foreman "Red" McCollister, sizes up the river before sending rearing crews into the frigid, 37°F. water.

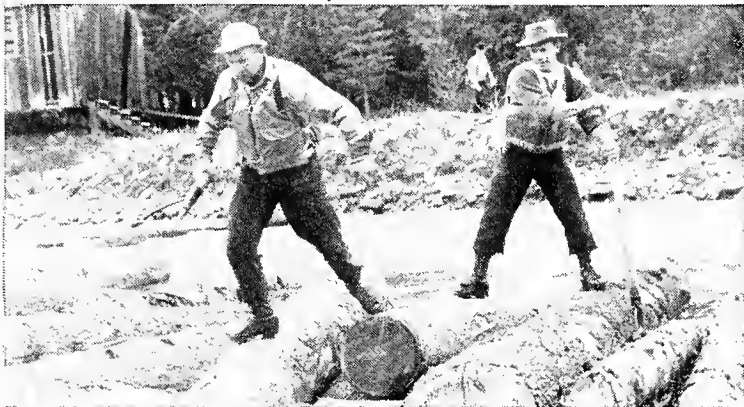

Spiked boots and the agility of a cat are prerequisites in a business where one misstep could lead to an icy dunking in the river.

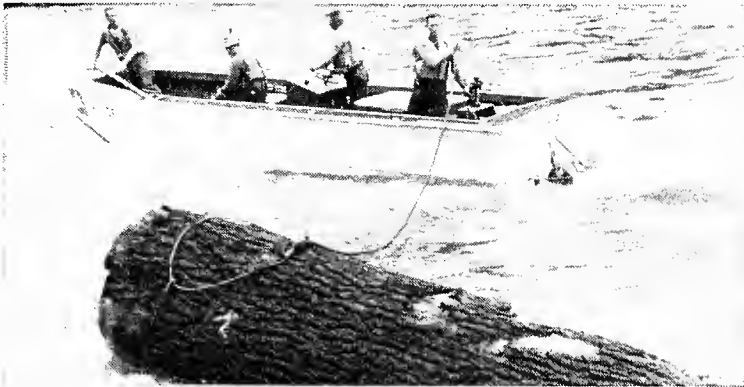

Whenever possible, modern, high-powered jet boats are used to pull stranded logs back into midstream, where they are refloat.



ner that has changed little over the ensuing years.

Their home for the duration of the drive is a floating "wanigan," consisting of a cookhouse and two 16-man bunkhouses mounted on huge rubber pontoons. More than 115 feet long and 26 feet wide, the wanigan precedes the crews downstream, usually tying up at different, and sometimes two or three sites each day.

"We keep the wanigan ahead of the crews for one reason," says McCollister. "I never knew a 'jack yet that didn't 'lean towards the mill,' and I find they work better when they know the wanigan's up ahead instead of behind. They just don't like going back upriver."

Aboard the wanigan, three heaping, hot meals are provided each day. A typical breakfast menu includes hot or cold cereal; bacon, ham or sausage, fried eggs; rolls; potatoes; fresh and canned fruit; hotcakes; toast and black coffee, with fresh fruit available for between-meal snacks.

Following breakfast, the men don their "corked" boots, pick up their peaveys or pike poles, and board one of three powerful jet boats to return to the spot where work stopped the previous night. The center crew works those jams in the middle of the river, while two other crews attack the wing jams and stranded logs along the banks. Each of the three crews is always accompanied by its boat, stationed nearby for rescue work. Wearing of life jackets, required since 1956, has saved more than one man's life following a misstep and a tumble into the raging 37° F. water.

At each new jam, a crew foreman determines the one or two "key" logs that will permit it to pull or unravel of its own accord. The crew then "guts the face" until such time as the jam is about to break. At the first indication that the jam is pulling, usually a slight sinking sensation, someone yells, "She's hauling!" and the crew takes off in a wild scramble for the boat or bank.

Running along these surging logs is the most dangerous part of the drive, and many a lumberjack has found himself "walking on water" to reach the safety of the boat.

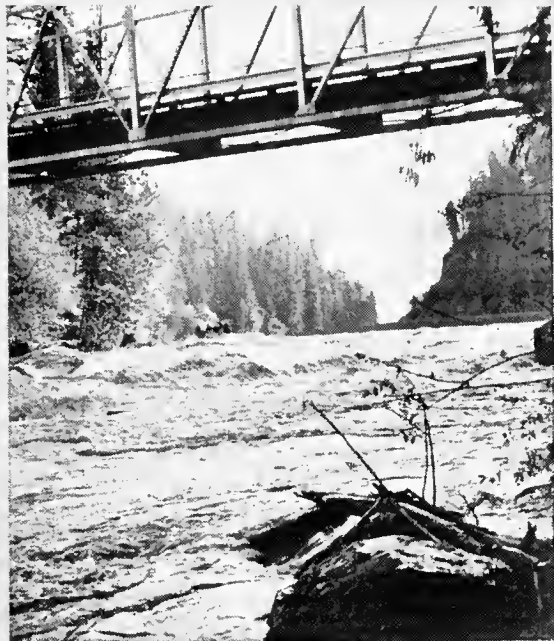

In the distance a Potlatch rearing crew runs Horror Rifle in search of stranded logs.



Muscles straining, half-a-dozen drivers "lean into it" as they manhandle a log back into the mainstream.

While some jams will unravel completely as a happy crew looks on, others are not so cooperative and require additional hard work with peaveys and pike poles. Jet boats are used to move the logs into the current whenever possible, and some small jams are broken by sending other logs into them as battering rams. On rare occasions, dynamite is used sparingly and only as a last resort.

Considering the dangers involved, there have been relatively few serious injuries or tragedies. However, several decades ago a lumberjack slipped and caught his foot between two grinding logs as a jam began to unravel. A crew member named

Jimmy Holmes reacted instinctively by grabbing a double-bladed axe, running to the trapped man, and severing his foot with a single swipe. Despite the fact that he saved the man's life, Holmes has since been immortalized in logging legend as "Cruel Jimmy," along with such other legendary figures as "Circus Joe," "Sandbar Stewart," "Cucumber Slim," "Michigan Bill," "Coyote Joe," "Birdeye," and "Butterfly Pete."

Ask any 'jack, and he'll tell you that working on a log drive is hard, back-breaking labor involving hour after hour of wading in ice-cold water where one misstep means a

Continued on page 16



PHOTOS ON THIS PAGE, CLOCKWISE

■ Working in a space smaller than the average home kitchen, chief cook Harvey Spears prepares more than 100 hot meals daily.

■ Spears pops another batch of his famous biscuits into the wani-gan's old, wood-burning stove.

■ Dinner over, a driver spends a few moments repairing the "corked" (caulked) boots so vital to safety while working log jams.

■ Besides his regular duties on the wani-gan, the cook's flunky gets a daily workout chopping firewood for the "drying fires".

■ Floating home for the Potlatch rearing crews during the log drive is the wani-gan, comprising two bunk houses, fore and aft, plus the cook house and dining hall, center.

■ Hot, soapy water feels mighty good after a long, chilling day on the Clearwater.



LIFE ON THE WANIGAN

■ "Six hundred pounds of beef, 80 pounds of pork, 24 pounds of link sausages, 100 pounds of smoked ham, two cases of cooked ham, 80 pounds of slab bacon, 15 pounds of cheese, and 35 pounds of fryers, cut up."

No, it isn't someone buying a year's provisions. It's only the wani-gan's chief cook, Harvey Spears, ordering just two weeks' supplies for the Potlatch log drive on the North Fork of the Clearwater River in Northern Idaho.

Add to this case on case of fresh eggs, fresh milk, cottage cheese, canned fruits and vegetables, honey, margarine, syrup and cereals; sacks of flour, sugar, peas and beans, potatoes

and onions; crates of lemons, oranges, bananas, cabbages and carrots, and you begin to get some idea of the food and work involved in feeding 34 ravenous lumberjacks three hot meals a day during the log drive.

Hopefully, the supplies are sufficient for the drive to reach the halfway point at Elk Creek, where the larder can be replenished for the balance of the trip to the Potlatch mill pond at Lewiston, Idaho.

Working out of a floating kitchen smaller than that of an average home, Spears and two assistants spend most of their waking hours preparing meals that would do justice to Paul Bunyan

in both variety and magnitude.

A typical lunch, for instance, would include steak and potatoes, salad, gravy, canned corn and asparagus, beans or peas, canned and fresh fruit, hot rolls, pie, doughnuts and cookies, with plenty of fresh milk and hot, black coffee.

The wonder of it is that each meal is prepared in quantities sufficient for two to three times the number of men eating it—or up to 100 portions each meal! 'Jacks have rarely been known to take less than two, and more often than not, three servings at a sitting.

A "normal" day for the wani-gan

Continued on page 35

BILLION-DOLLAR LEVITT BUILDING SYSTEMS GOES UNION-MADE, WITH TRI-TRADES LABEL



Tri-Trades leaders sign the joint pact, as labor and management leaders gathered for discussions. Seated, from left, are Electrical Workers' President Charles Pillard, General President M. A. Hutcheson, and Plumbers' President Emeritus Peter Schoemann. Standing, from left, are General Treasurer Peter Terzick, Joe Walsh of the Plumbers, Kim Parker of the IBEW, First General Vice President William Sidell, Organizing Director Pete Ochocki, Levitt & Sons Inc. President Richard M. Wasserman, and company officials.



■ When you think of the superbuilder, you think of Levitt & Sons, Inc., which reached the \$100-million mark in sales in 1968 and approached sales of \$250-million in 1970.

Now a subsidiary of International Telephone and Telegraph Corp., Levitt has moved into modular home manufacturing and plans to eventually become a billion-dollar superbuilder in the new and mushrooming packaged-home industry.

On May 3, 1971, Levitt Building Systems, Inc., signed a collective

bargaining agreement with the Tri-Trades Unions (Carpenters, Plumbers, and Electrical Workers) covering workers in its big, new modular-home plant at Battle Creek, Mich., and the installation and creation of all modular housing units coming from the plant . . . wherever such installation occurs.

Measured in dollars and cents and in job opportunity, the pact is an important breakthrough in the Brotherhood's continuing effort to keep abreast of trends in the housing industry. Three months of ne-



The 140,000-square-foot plant south of Battle Creek, Mich., where Levitt Building Systems, Inc. has begun its first modular homebuilding operation. The assembly line at this plant is expected to turn out colonial-style townhouses to sell for \$20,000 to \$25,000 (with land) plus models for Operation Breakthrough (See Pages 8 and 9). The Tri-Trades Label at upper left, combining union labels of each of the three unions, is to appear on each new modular home produced by Levitt.



Labor and management agree to a joint approach to the nation's housing needs, as three craft leaders (seated)—IBEW President Pillard, Brotherhood General President Hutcheson, and Plumbers' President Emeritus Schoemann sign the Levitt agreement. Levitt President Wasserman stands behind them, prepared to sign the document.

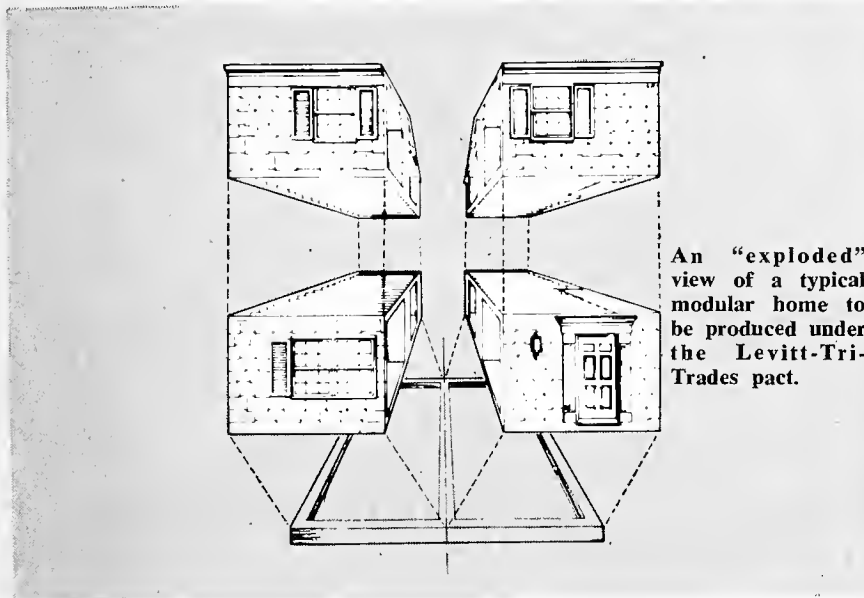

An "exploded" view of a typical modular home to be produced under the Levitt-Tri-Trades pact.

gotiations preceded the agreement. The latest pact is a sequel to a collective bargaining agreement established earlier, which covers Levitt's prototype plant at Kalamazoo, Mich.

The formal opening of the Battle Creek facility, which is expected to employ 300 persons, was held in May. This plant is only one of seven such installations which Levitt plans to put into operation across the United States. Each plant will be capable of producing an estimated 4,000 homes annually.

Levitt is the largest home builder in the world, although this is contested by Boise Cascade Co., which had a volume last year of close to \$300 million, including a substantial number of mobile homes.

Others in the \$50-million-and-up

housing-unit class are National Homes Corp., Ryan Homes, Kaufman & Broad, Inc., a subsidiary of CNA Financial Corp. Major newcomers include International Paper Company, Inland Steel Co., and Weyerhaeuser Co.

Richard M. Wasserman, president of Levitt & Sons, Inc., says: "The dynamics of the industry are changing dramatically. It's a different industry today from what it was a few years ago."

The Brotherhood, along with the International Brotherhood of Electrical Workers and the United Association of Journeymen and Apprentices of the Plumbing and Pipe Fitting Industry of the United States and Canada, hopes to make it an all-union operation. ■

U.S. Population Density Deepened Over Past Decade

If you want to be let alone as Greta Garbo once did, the best place to do it is Alaska, where there is only half a person to the square mile, or Wyoming where there are 3.4, or Nevada where there are 4.4.

On the other hand, if you like to get chummy with people, New Jersey is your state, with 953.1 persons per square mile, or Rhode Island, where it is 905.4, or Massachusetts, where it is 727.

These are the latest findings by the Bureau of the Census and are based on last year's count of the American population.

On an overall basis, the density of the population grew from 50.6 persons per square mile to 57.4 during the past decade. With a total land area of 3,536,855 square miles including Alaska and Hawaii, the total population is 203,184,722 spread unevenly over the country

Rhode Island from the very beginning has always been the most densely populated of the states, but during the 1960-1970 period, New Jersey grew from 805.5 persons to the square mile to 953.1, putting it first in the somewhat doubtful distinction of being more crowded than anyplace in the United States except for the District of Columbia where it is a whopping 12,401.8.

While there has been a tremendous shift of population from the East Coast toward the West, the fact remains that the Northeast still remains the most densely populated part of the country with 300.1 persons to the square mile and the West the least densely populated with only 19.9. The North Central area contains 75.3 to the square mile and the South 71.9. The percentages, of course, reflect the number of square miles in each area. The West leads with 1,748,019; the South comes second with 873,743; North Central is third with 751,824 and the North East comes last with 162,269. (PAI)



Architect's rendering of a row of townhouses constructed from several modular units.

BREAKTHROUGH HOUSING UNIT UNDERGOES EVALUATION

Railroad Cars Are Banged Together to Check Shipping Problems

■ The first full-scale, factory-built housing module constructed for the U.S. Department of Housing and Urban Development's Operation Breakthrough recently arrived at the National Bureau of Standards test facilities at Gaithersburg, Md., to undergo several weeks of evaluation.

Rigorous tests on the unit will determine if such industrialized housing can be successfully built and shipped for erection on sites miles away and still maintain performance standards. The evaluation will mark the first occasion that such housing has been directly designed to meet performance criteria and tested to see if the criteria are met.

NBS's Building Research Division will conduct the tests on the unit—a prefabricated 60-foot, 30,000-lb. module—manufactured by a national firm. The prototype unit is the top front portion of a two-living unit building. The module is comprised of three bedrooms and a 20-foot long cathedral ceiling of a first-floor living room.

The shipping procedure from Kalamazoo, Michigan, was actually part of the testing program. Part of this evaluation was a "bump test" in which the railway car loaded with the module was rammed by another car to test the unit under simulated coupling action. Careful checks were made

from the construction site of the unit through its 500-mile journey along lines of the Penn Central, and C & O/ B & O railroads to determine whether any structural deformation or other damage had occurred in transit.

The Bureau will evaluate the module solely on the basis of performance criteria, which state the ends desired (for example; a wall shall withstand 90 mile-per-hour winds) instead of specifying the means of accomplishment (example; wall uprights shall be spaced 16 inches on center). One goal of performance standards is providing a means for introducing innovations, which are not possible under many existing buildings codes.

Initially, the module will be subjected to racking tests in which force is applied by pneumatic jacks horizontal to the walls in simulation of wind loads. Strain gauges attached throughout the module yield stress/strain data during these tests. Impact tests will also be conducted on the walls and floors. In the floor test a weighted bag is dropped from a holding rack three feet above the floor. Transducers detect vibrations to determine vibration damping characteristics. For wall impact tests the weighted bag, suspended on a line, is swung into the wall. These tests simulate a person falling into or bumping the wall for obtaining strength-to-fracture criteria. Other tests to determine fire safety and effectiveness of resistance to flow of smoke and toxic gas are anticipated.

HUD's objectives for Operation Breakthrough are far-reaching and include the following: To develop increased production of housing to assure the supply needed for our total population in the years ahead. To modernize zoning regulations. To attract into the housing business architects, planners, suppliers, engineers, a broad range of industrial capacities, financial institutions, management organizations, builders, and developers that have the ability to develop improved housing system approaches. To encourage developments and use of new techniques and materials. To encourage the development at the state government level a concern with and a capability for the development of housing based on the improved approaches that are expected from this program. To seek innovative and expanding financing mechanisms, recognizing that basic reform in monetary institutions and regulatory laws may be needed.

In short, to provide a significant increase in industrialized housing in the United States with improved de-

Continued on page 37

After arriving at a railroad siding in Gaithersburg, Maryland (upper right) the 60-foot modular unit was transferred to a flatbed trailer for its 1 mile trip to the Bureau's structural laboratory.

The modular unit is being positioned (center right) in the Bureau's structural laboratory.

Factory-built module with testing instrumentation installed (right) NBS is evaluating the full-scale structure by subjecting it to racking and floor and wall impact tests.

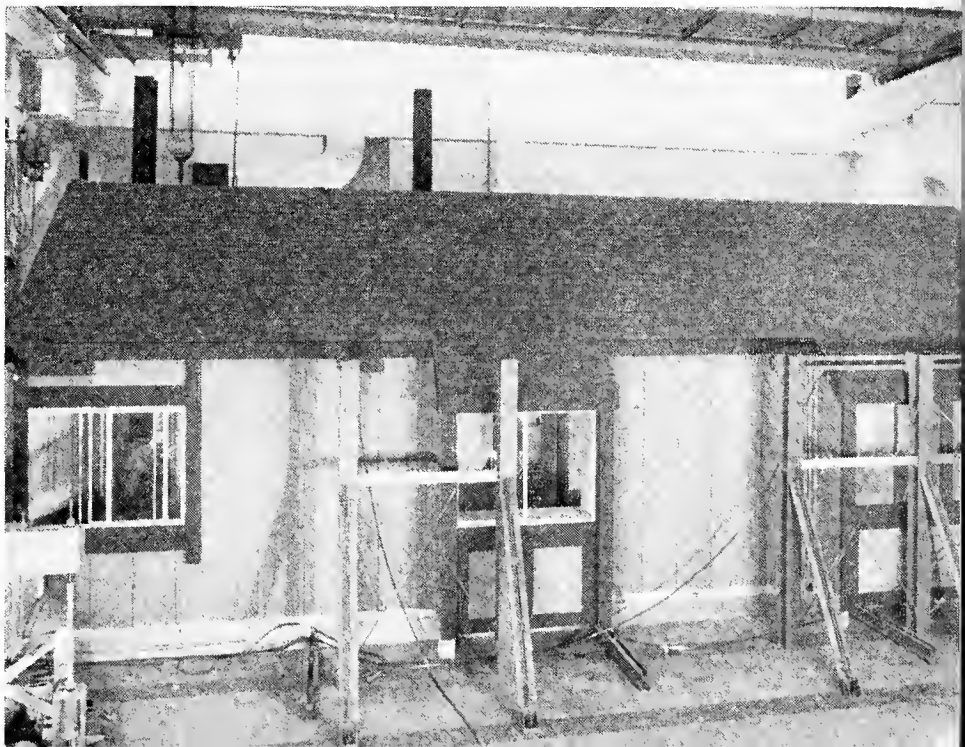

WASHINGTON



ROUNDUP

\$2 MINIMUM—The AFL-CIO, in unusually blunt testimony before the Senate Labor Committee, has rejected the Nixon Administration's "low-wage" policies and has called for an immediate \$2 an hour minimum wage with "substantial" boosts over the next two years.

Legislative Director Andrew J. Biemiller told the committee that "there is a concerted campaign—and this Administration is part of that campaign—to force a 'low-wage' economy on America," and that the AFL-CIO is having none of it.

NATIONAL HEALTH SECURITY—The AFL-CIO has sounded the warning that it is determined to throw its full weight into the fight for a National Health Security Program and that it will "fight—to the fullest extent of our ability—any effort to dilute or undermine it."

The Federation, AFL-CIO Secretary-Treasurer Lane Kirkland declared, completely rejects the Nixon Administration's version of health care legislation, declaring that while it states the problems of medical care, from that point on "old guard opposition takes over, with a few small concessions to the climate of the times."

OUTSIDE INCOME—Of the 434 members of the House of Representatives who filed financial disclosure reports for 1970, 265 reported that they had outside business or professional interests.

This information is now reported each year in accordance with rules adopted by the House in 1968 which require members to file their statements with the Committee on Standards of Official Conduct.

The second part of the report is confidential and includes the dollar value of outside assets held by members.

TRIAL EXAMINER AUTHORITY—Labor Board General Counsel Arnold Ordman defended the NLRB's record in handling its mounting case load, but endorsed proposals to speed board processes by giving trial examiners greater authority in routine unfair labor practice cases.

Testifying before the House Special Labor subcommittee, Ordman said that authorizing the board to delegate to trial examiners power to decide the cases is "an administrative necessity for the continued successful disposition of the agency's growing caseload."

MADISON AVENUE APPROACH—Sen. Henry M. Jackson (D-Wash.) scored the Nixon Administration's so-called Inflation Alerts, stating that they "simply do not work."

Jackson's comments were recorded in a special interview for COPE Report, the new cassette tape program of the AFL-CIO Committee on Political Education. The June issue of the program included a special report on America's economic problems.

"I reject the approach of this Administration in singling out particular price schedules or wage settlements on an arbitrary basis," Jackson said. "This is a little more of that Madison Avenue approach."

He called for an "equitable" and "systematic wage-price policy based on publicly stated rules."

SKYJACKING AGREEMENT—Ways and means to bring all hijackers to the bar of justice and make them subject to severe punishment for any act that endangers the safety and well-being of airline passengers and crews should be found, President John J. O'Donnell of the Air Line Pilots Association (ALPA) urged before the Senate Foreign Relations Committee.

Captain O'Donnell asked support of the immediate ratification by the United States of the convention for the suppression of unlawful seizure of aircraft, signed at the Hague by 50 nations last December, and strongly urged that the U.S. enter into bilateral agreements with nations that are not members of the International Civil Aviation Organization (ICAO), especially Cuba, as one more step to prevent skyjacking.



Old Glory is raised at a recent picnic of Local 82, Haverhill, Mass., as members prepare for a day's festivity.

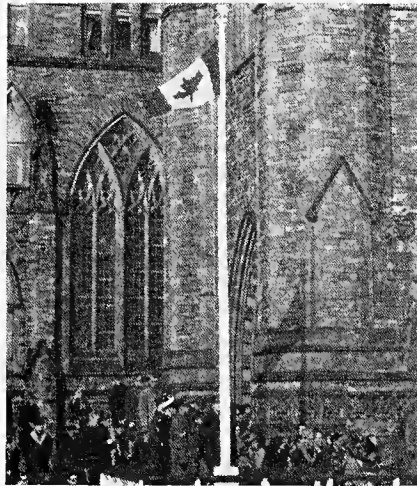

The Canadian flag was first raised at the Peace Tower, Ottawa, at 12 noon on February 15, 1965, as shown here.



A monument to international goodwill at the border between the Province of Manitoba and the State of Minnesota.

The Bonds of International Brotherhood

TWO JULY COMMEMORATIONS

■ A survey line 5,000 miles long separates Canada and the United States. It runs from the Atlantic to the Pacific and from the coast of British Columbia to the Arctic Sea, through forests, mountains, lakes, rivers, farmlands, and even through houses which straddle the line itself. It is the longest unfortified boundary line in the world.

Brotherhood has meaning when it is applied to U.S., Canadian relations. We have fought side by side in two World Wars and in Korea. We have united in a common defense of the continent. When we speak of an international labor union in North America we usually mean United States citizens and Canadian citizens joined together.

Like identical twins, we approach the future united in outlook and purpose. We are truly neighbors in democracy.

We share in common the month of July for our national rededications. July 1 is Confederation Day in Canada. July 4 is Independence Day in the United States.

The United States began its national existence in 1776. By the end of the 18th century its national

independence and the basic principles of its system of government had been firmly established.

Comparable developments did not begin north of the border until nearly a hundred years later, and they came about in a much more gradual fashion. The Dominion of Canada, as established by the British North America Act of 1867, was not an independent nation. Its foreign affairs were still controlled exclusively by Great Britain, and even its domestic affairs were not wholly free. Its rise to sovereign statehood was accomplished not, as in the United States, by a single revolutionary act, but by a slow process of constitutional evolution. Canada's sovereign status was finally confirmed in 1931 with the passage of the Statute of Westminster by the British Parliament. Its own distinctive maple-leaf flag was adopted in the early 1960's.

When we use the "editorial 'we'" in *The Carpenter*, we refer to Brotherhood members in the United States and in Canada. It's a proud and lasting partnership, by which we are now completing our 90th year as an international union. It is an example for the people of all nations to follow. ■



The International Peace Arch, Peace Portal Park, between Douglas, British Columbia and Blaine, Washington, bears the words: "Brethren dwelling together in unity."



At the Canadian National Exhibition grounds, Toronto, this statue commemorates more than 100 years of peace.



CANADIAN REPORT

Government Initiative Proves Value In Stimulating Economy, Aiding Workers

Government interference is opposed by a majority of people in a private enterprise economy, but government initiative in stimulating the economy to create full employment conditions and to improve living standards is still expected.

This seeming contradiction is becoming more and more evident. The general trend is to greater acceptance of the role of government in running the affairs of the nation and playing an increasingly important part in economic and social development.

The area in which concern for government intervention still exists is where it affects the right of the individual.

A case where a government was praised by the public for its initiative and condemned by private enterprise was the establishment in Manitoba of public no-fault auto insurance.

Another was the example of the B.C. government in banning liquor and tobacco advertising.

Unions have long been accustomed to working within the framework of government regulation. They often and necessarily object to particular legislation which affects their own jurisdiction, but no unions would want their members to be deprived of the benefits of labor legislation, workmen's compensation, safety regulations, minimum wage laws, pension plans, not to mention a relatively free educational system and a dozen or more other benefits.

All these have a price, paid through our tax system. But on any reasonable analysis the price is really small compared with the advantages.

More and more of our earnings are going into taxation.

In 1870, taxes took only 7% of the gross national product. Of course there was no free education in Canada nor any other benefits.

By 1957 taxes took 27.1% of the GNP. Today the tax take is over 35% of the GNP.

Much of the increased taxes has been in the service area. Outlays on health, education and welfare rose from 7.7% of the GNP in 1933 to 13% in 1965. It is probably over 15% now, especially with the heavy welfare costs due to unemployment.

In the offing is some kind of guaranteed income program which will push up the tax take on the one hand and the benefit payments on the other.

Is the business community going to adjust to this welfare state within the private enterprise economy?

They will have to, according to an influential lawyer who acts for big business.

Edwin Goodman, formerly a power in the Conservative Party, told a business conference in June, "Governments are not going to go away. They are not going to leave you alone."

He urged his listeners to take more interest in government, which is already setting zoning and building

Time to Play Ball



Two Canadian Cub Scouts choose up sides and prepare to play ball. Labor union leaders are assisting their summer program and year-round activities.

standards affecting the construction industry, writing and administering labor and other legislation governing "working hours and vacations . . . (while business) operates its machinery under standards of safety set by the government, with conditions of health set by the government."

Money, transportation and even marketing are now controlled more or less by government, so are shareholders' reports.

He called for more co-operation between business and government as in Japan, where, he said, the high degree of co-operation has been a success on an international scale.

Mr. Goodman's comments came as a bit of a surprise to many people who were under the impression that the governments across Canada were already too co-operative with the business community . . . at least with some parts of it.

As former cabinet minister Eric Kierans said recently (see last month's Carpenter between 1965-68, the oil and gas industry in Canada paid taxes on only 5.7% of their book profits, while retailers paid taxes on 90% of their profits.

And as everyone should know by now, most of the taxes are paid by the lower income groups.

Guaranteed Income Experiment Noted

Talking about the possibility of a guaranteed income in Canada, the Trudeau government has thrown cold water on the idea because, among other things, it contends, it would destroy people's desire to work.

However, an experiment being conducted in the United States is being closely watched here as it seems to prove otherwise. The preliminary finding is that people with some assured income are more likely to look for work to improve their lot in life.

The experimental project is being conducted by the Office of Economic Opportunity, a U.S. federal agency, and the University of Wisconsin's Institute of Research on Poverty.

The project started in New Jersey in 1968 and in Pennsylvania in 1969. It was then extended to the South and Mid-West to include rural poor families.

The families received a variety of income guarantees up to \$4,606 for a family of four. This is close to the minimum income accepted by the Economic Council of Canada as the

poverty line. About four million Canadians live on incomes below this figure.

After about three years' research, the U.S. report says: "There is still no indication of a precipitous withdrawal from the labor force by families who receive income maintenance payments."

And, "It appears that an income assistance system may give poor people, particularly working poor, the ability to seek out better jobs."

The report views this as "a significant step forward in our policies for dealing with poverty."

The experiment has still two years to go.

Construction Feast, Famine

The Construction Industry Development Council, a 35-member federal committee under the Department of Industry, Trade and Commerce, is working on ways and means of smoothing out the ups and downs of the building industry.

Construction seems to be either a feast or a famine. Due to federal restrictive policies, last year was more like a famine in both industrial, commercial and residential construction.

This year residential construction is more normal, but the upsurge in other sectors has not come about.

The industry has repeatedly told the government that using building as an economic football has created a great deal of instability in the business.

And in the unions, too.

Economist Scores Jobless Policies

A leading Canadian economist, Dr. Harry Johnson, who is now professor of economics at the University of Chicago and the London School of Economics, says that the government's policies of deliberately creating unemployment to control inflation are wrong.

He criticized the government for its undue concern over inflation, and stated that it would be more efficient to compensate pensioners, social security recipients and civil servants for rising living costs than to battle inflation head-on by creating large scale unemployment.

Another leading Canadian economist, Professor Clarence Barber, said that the federal government's decision to push the unemployment rate over 6% in the past 18 months has cost

the country more than \$5 billion a year in lost production.

Ontario Health Plan Costs Under Study

The administrative cost of operating the public Ontario Health Services Insurance Plan is only about 6%, according to figures released by the Ontario health department.

Total revenue is about \$541 million for the current fiscal year while administration costs are only about \$32 million.

When Health Minister Lawrence reported to the Ontario Legislature, he was critical of the medical profession which, he said, should be doing a better job of policing its own members.

Some doctors have been sending in such heavy bills to the public health service that their gross incomes exceed \$200,000 and in some cases, \$300,000.

The average income per patient for a general practitioner has been around \$18.67 over a three month period, but a few doctors have been getting over \$300 per patient.

Some doctors seem to be abusing the use of laboratory services.

Some laboratories owned by doctors received an average per contract of \$24.53. But independent labs received only \$12.29, while hospital outpatient labs averaged only \$8.92.

More will be heard about all this in the future when more data comes off the OHSIP computers.

The high cost of drugs is again under investigation also, as the government's PARCOST program to reduce drug costs has not been as effective as hoped.

New Democrats Win in Ontario

The New Democratic Party won an important by-election in the Brant constituency of Ontario May 31st when 36-year-old teacher Derek Blackburn was elected to the House of Commons.

This was a gain for the Liberals and taken as a sharp rebuke to the Trudeau government for its policies. Unemployment in the Brant area has been running around 10 percent.

The trade union vote in the industrial area of Brant was important but the fact that the farmers in the rural area also voted NDP made for the decisive victory.

The Liberals held on to two seats in Quebec province, both by reduced majorities. The Conservatives held their seat in Nova Scotia.

But it was the Ontario seat that made the big news. A provincial election will likely be held this year and the NDP is now gunning for government.

The party's analysis, based on the results in Brant, is that if the Brant results are projected over the province, the NDP would win 60 seats in the next election, the Conservatives 46 and the Liberals 11.

One-Year Extension Of Ontario Agreement

A one-year extension of collective agreements was agreed upon by the negotiating committee of the Ontario Council of the United Brotherhood of Carpenters and Joiners on the basis of a 68-cents-an-hour increase in two stages.

The purpose of the extension is to allow adequate time for the committee and industry representatives to negotiate a provincewide agreement.

The 68-cents interim settlement, payable 40 cents May 1st and 28 cents November 1st, has to be ratified by the locals.

A total of 33 locals representing 16,000 members are involved.

Carpenters' wage rates in Ontario run from \$4.50 to \$7.10 an hour. The new increase adds just over 10 percent to the present wage and benefit package in Toronto, for example, of \$6.58 an hour. This latter amount is made up of \$6 wages, 10 cents in welfare payments and 8 percent vacation pay.

The negotiating committee was to meet again with the construction industry's representatives in mid-June to continue discussions on the provincial agreement.

TOOL TALK

By B. Jones

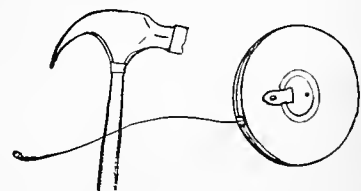

Would you please get your feet out of the way?

A Memo to Today's Youth: **LOOK TO ORGANIZED LABOR FOR MEANINGFUL SERVICE**

BY THE REV. J. L. DONAHUE

Father Donahue is Chaplain to the Chicago and Cook County Building Trades Council. Before becoming a clergyman, he was an apprentice in Lathers' Local 74, Chicago, and he has maintained membership there. This article was written especially for THE CARPENTER.

■ These are trying and troublesome days that challenge the very souls of men. Conditions are so critical, so strategic, that one trembles over his personal responsibility, lest he be accused of not being alert, lest when the history of the times is written, it can be said he did not measure up to the opportunity and to the responsibility that confronted him.

The loudest and the most frequent cry emerging from the lips of the American youth of our day is: "We know it is possible to have a more abundant life while living." As we listen to their cries and look into the faces of these boys and girls, we ask ourselves: "What kind of life are these youngsters going to have?"

I believe that all of us can say to these young men and women: "What is life about, after all?"—"Are we simply trying to take so many dollars and pile them up in so many vaults, or does life have more meaning to us?"

Recently, I met a man whose labor organization had been on strike for several months, and I said to him: "Jim, why do you hold out like this and make so many sacrifices in doing so?" And this is what he said to me: "Father, I have five boys at home. It is my hunch that all of them will someday work at my trade, and if they do I want them to have a better life. I want them to love America for the opportunities she gives them, and I want them to enjoy their homes and their families with the means their labor will bring them.

"When my work days are over," he said, "I don't want my boys looking at me and saying that when it came to a crisis their father failed them. He did not have the courage to stand up and be counted. I want them to say of me, 'Dad stood true and sacrificed for a bigger and better life.'"

If all Americans would live for the next generation in the same spirit that this father does for his boys, America would continue to grow. This is the richest country in the world, but unless we can build a society that will make a better and a finer life for every American, the country will not be worth very much as far as human values are concerned.

Let our aims be to create morale, to create vision, to create unselfishness, to create a sense of comradeship among all Americans. Then we will be able to face each other as partners, translating patriotism in terms of building a larger life.

A few moments with our young people will convince one that most of them are wanting to get into something that will make their lives count. The American

Labor movement offers them that opportunity.

Not too many of these young men and women are aware that no other American institution has done more than organized labor in bringing to the workers of our nation the dignity due them and a chance to share in the beauty and wealth of the land.

This movement has always supported the principle that no one should be without adequate food, clothing or shelter. She is not a neophyte in the war against poverty. Her proud scars of battle have been won in almost a century of wars for the poor, the down-trodden, the neglected.

It was she who went into battle for a free and equal education for all; she led the way for the abolishment of child-labor and the ten-hour day; her patience and perseverance won the struggle to outlaw sweat shops, to win the right for women to vote. It was her deep concern that created the Workmen's Compensation and Occupational Health and Safety Acts, and the Unemployment Compensation Act now of benefit to our workers in many states. She was the leader in the struggle for Social Security and medicare benefits.

All of these were gained not through voluntary concessions but only through heartaches, sufferings and sacrifices of organized labor members.

Should it be that the young men and women of our nation do not know the history of the labor movement, then it is our duty to tell them. Not a single applicant should be accepted into any labor organization without telling them there is blood on the labor movement in the sense that men have sacrificed their lives for it. Many workers have gone to jail in order to maintain their labor organizations. Others have been ostracized from society because they supported the labor movement. Thousands of workers have been denied work because they dared to fight for labor's cause. If the young people who have been demonstrating in our cities, disrupting our schools and tearing up our colleges, and even destroying our Nation's Capitol really wish to do something practical for bettering the lives of their fellowmen, let them join organized labor in its struggle for the poor, the underprivileged, the abused.

We confess to the young people of America that the labor movement is not all it might have been, and certainly this society is not all it could have been, and our part in the world is not all it ought to be, but we of organized labor dream dreams and see visions of a better day for all workers. ■

Where Lies the Wave of the Future?



I'll run over and pick up my unemployment check and then go by the university and see what's holding up my Federal education grant and then pick up our food stamps . . . Meanwhile, you pick up my free glasses at the Health Center, see if you can get some more methedone at the People's Narcotic Center, check up on our test at the Neighborhood VD Clinic . . . Better go by the Welfare Offices and try to increase our eligibility limit again . . . I'll meet you at the Federal Building for the demonstration against the rotten establishment."

"Gee, I'd love to go bowling with you, but it's my Army Reserve night. We're getting special training in disaster relief work. Anyway, I don't have any money. I only got in 14 days last month, and after all the tax deductions that doesn't leave much for fun on an apprentice's pay. Besides we got a kid coming in a couple of months, and I don't like to leave Norma alone any more than I have to.

"Thank the Lord that the union health and welfare plan will pick up the tab for Norma and the kid."

"While everyone in our country should be provided for when they are in need, Hawaii alone cannot accommodate the inundation of transients who have been flocking to our shores in search of the nearest social service office.

"Those who rail against the establishment at the same time they demand bread from the hand they discredit are guilty of intellectual and moral dishonesty."

—Hawaii's Lt. Gov. George Ariyoshi

Whitewater Drive

Continued from page 4

dunking at the very least. Highly abrasive sand carried by the fast-flowing river plays havoc on cold, tender feet; and "squeak heel," a tightening of the ankle tendons caused by continued immersion in the snow-fed waters, brings added agony.

After four hours on the river, the crews are more than ready to board their boats and head for the wanigan and another piping hot lunch. A roaring fire awaits the men at lunch and dinner time, and plenty of steaming hot water is available for washing up. A hearty meal, an hour of rest, and the crews are back on the river for another four hours of work.

With the 'jacks gone, the wanigan's mooring lines are cast off and it's moved downstream to the next predetermined landing. Steering with outboard motors mounted fore and aft, the pilot guides the huge raft through treacherous rapids and eddies, often requiring some tricky maneuvering to land at a particular point. Mooring lines are once again secured, and chief cook Harvey Spears hurries to prepare another gigantic meal for the near famished men.

Evenings aboard the wanigan are a time to relax, spin a few yarns, and clean and repair personal equipment. Sand is washed from heavy woolen socks and soggy boots, torn clothing is mended, and the never ending job of replacing worn "corks" is accomplished. By nine p.m., however, most men are asleep in their bunks, gathering energy for the next day's battle against the river.

And so it goes—seven days a week, week after week—until the last log reaches its destination at Lewiston.

Recognized in its day as the most economical means of transporting logs, the river drive first reached the Clearwater in 1928, when the Clearwater Timber Company, one of the predecessors of the present firm, organized Log Drive Number 1 from Camp B, 60 miles upstream from Lewiston.

No wanigans were used in the drives of 1928, '29, and '30. Instead, permanent camps were established several miles apart along the river, and supplies were moved in by strings of pack horses. Heavy wooden bateaus, powered by four or six oarsmen, were used to haul the men downriver and for rescue work. Impossible to move upstream in a fast current, a loaded bateau occasionally was swept past a jam or camp, and the men would have to walk back upstream, pulling the boat with a tow line from shore.

The first wanigan made its appearance on the Clearwater in 1931. Built on red cedar pole rafts, 80 feet long and 22 feet wide, the early wanigans included a cookhouse and a bunkhouse, with a third, smaller in size, sometimes used as a freighter for supplies. Steering sweeps were fashioned from cedar poles with a 16-foot plank, 12 to 16 inches wide, attached as a blade. Mounted fore and aft, the sweeps often required three strong men to handle them in whitewater.

Twenty years later, in 1951, a major change in wanigan construction occurred when the cedar pole rafts were replaced with air-filled, rubber pontoons; and one large wanigan took the place of the two smaller ones. Outboard motors replaced the large steering sweeps in 1955; however, short sweeps are still carried for emergencies arising from power failure or propeller damage.

For the bateaus, the first change came in 1949, when the stern of one boat was cut back and a small, 22-hp outboard motor was mounted. In the following years, two other bateaus were converted and equipped with slightly larger, more efficient outboards. In 1959, a large, metal barge-like boat powered by twin outboards replaced one of the bateaus. Aptly named "Cleopatra's Barge", the boat proved difficult to handle in fast water, and has since been augmented with today's powerful aluminum jet boats.

With the exception of the years 1934, '45, and '46, Potlatch has conducted the Clearwater log drive annually, and each drive has its own history to tell. Some were more ex-

citing than the others, but all were colorful, nonetheless.

Several spectacular jams have formed in past years, resulting in tremendous problems for the drive crew. Jams in 1938, '42, and '51 were estimated to contain between 10 and 20 million board feet of logs.

Whenever a jam of such magnitude unravelled, it also meant trouble at the Lewiston mill pond. Moving as a solid body, often mixed with great quantities of river ice, the logs would exert tremendous pressure on the fin beams leading into the pond.

Drive Number 10, in 1938, is still noted as being the fastest in Clearwater history. Thirty-four million board feet of logs reached Lewiston in five hectic days when a natural dam on a side creek collapsed and sent water, huge boulders, and entire trees churning into the North Fork.

A daylight inspection revealed that the flood swept both banks clear of logs, tore out two huge jams downriver, and sent the whole thing streaming into the Lewiston pond.

Conversely, Log Drive Number 20 is remembered as the longest in elapsed time, requiring over 80 days to rear more than 62 million board feet of logs.

For chief cook Harvey Spears, however, Log Drive Number 18, in 1949, will always remain a vivid memory. For that was the year the wanigan was nearly lost in an encounter with "Big Eddy" on the main Clearwater. Treacherous currents in the eddy nearly upended the raft, and only the quick actions of an unknown 'jack saved him from almost certain death. To this day, Spears wonders who his benefactor was.

And now, with Dworshak Dam soon to be completed, trucks and trains will take up the job of hauling the logs to the mill, and Log Drive Number 40 will go down in logging annals as the last of its kind. Colorful and exciting, the old-fashioned, rip-roaring whitewater sawlog drive is a thing of the past—destined to take its place alongside the iron horse and the paddlewheel riverboat as another victim of progress. ■

The trucks that ride smoother



Smoother wide-stance Super Suspension

Over the years Chevrolet has led the way in engineering a smooth truck ride.

We were the first to introduce independent front suspension. We've built 1½ million more light-duty trucks with this type of suspension than anybody else.

In the rear Chevy leads the way by making available two-stage coil or leaf springs. Most

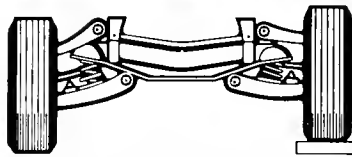

trucks don't give you a choice.

And most trucks don't give you Chevy's steady wide stance ride.

Chevy's Super Suspension. The smoothest truck suspension system going. And the trucks that ride smoother, work longer.

That's a fact.

Look at Chevy's work record

The chart below, based on the latest official figures,* shows how Chevrolets outlast other trucks.

Going back as far as 1956, for example, over 55% of the Chevy trucks of that model year are still going strong.

No competitive make has as many as half of its '56 models still working. Chevrolet trucks last longer because they're built tougher.

last longer

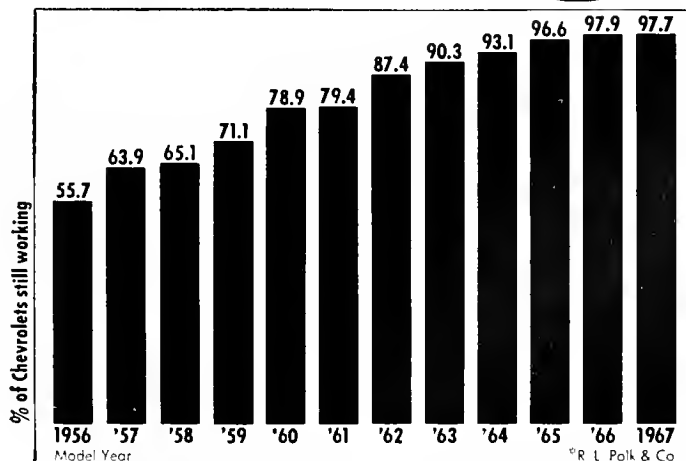

Totally tougher trucks
Buckle up for safety.



"We Congratulate.."

... those members of our Brotherhood who, in recent weeks, have been named or elected to public offices, have won awards, or who have, in other ways, "stood out from the crowd." This month, our editorial hat is off to the following:



A SHIP'S WHEEL—from the AFL-CIO Maritime Trades Department was only one of several gifts and mementos presented to General Secretary R. E. Livingston, May 17, at a special dinner in his honor, arranged by the AFL-CIO Secretary-Treasurers' Conference during its meeting in Atlanta, Ga. The gifts were presented in appreciation for Secretary Livingston's leadership of the organization—three years as treasurer, three years as vice chairman, and three years as chairman. Making the presentation above are AFL-CIO Secretary-Treasurer Lane Kirkland and Maritime Trades Executive Secretary Peter McGavin.

MAN OF THE YEAR—On April 19, 1971, Arvid Anderson of Dockbuilders Local 1456, New York City, experienced one



ANDERSON

of the most thrilling moments in his lifetime when he received a communication from the chairman of the Sweden Day Association and the United Swedish Societies of New York advising him that the committee had selected him to be the honored guest as "Man of the Year" at the Sweden Day Festival, held on June 27, 1971.

Arvid (Al) Anderson first joined Local 1456 in 1924, after having worked with the Machinists and the Millwrights. He learned his trade well and soon rose to foreman, general foreman and construction superintendent. In 1955, he was appointed by then Local President

Charles Johnson, Jr. to the position of assistant to the president. He remained in this position for about five years, when he was appointed a full business representative and vice president of the local union. Toward the end of 1969, Charles Johnson, Jr. announced his retirement as president of Local Union 1456 effective December 31, 1969, and Arvid Anderson was officially installed as president on January 12, 1970.

USS DETROIT VETS—Members of the crew of the *USS Detroit* who survived the attack on Pearl Harbor, December 7, 1941, held a reunion at North Island Naval Air Station, San Diego, Calif., last March 21. W. C. Knotts, USN, Ret., a member of Local 1571, San Diego, and one of the survivors, discovered several former shipmates assembled at North Island to be members of the United Brotherhood of Carpenters and Joiners of America. Our best wishes are offered to these veterans of a tragic war encounter.

FEDERAL POSTS—A Brotherhood member and a former Brotherhood member moved into Federal government positions in recent weeks:

Michael D. Banko, Jr., a former member of Millwrights Local 2235, Pittsburgh, Pa., has been named assistant regional administrator for technical assistance, U.S. Department of Labor. He will work out of the Labor Department's Philadelphia office. Banko is a former vice chairman of the Lawrence County, Pa., Building Trades Association.

Meanwhile, Henry Saracusa, business agent of Local 111, Boston, has been appointed labor relations advisor to the regional administrator of the Department of Housing and Urban Development. He will work in HUD's regional office at Boston.

BAKER HALL DEDICATED—An industrial building was dedicated March 31, at Daytona Beach Junior College, Daytona Beach, Fla. It will bear the name of Baker Hall in honor of Brother Paul R. Baker, business representative, Carpenters Local 1725, Daytona Beach. Brother Baker has been business representative of Local 1725 for 20 years and has served on the advisory board of the college for 12 years, three of which he served as chairman of the board.

During his term as a trustee, more than seven million dollars of construction has been done on this campus. All projects have been built union, mainly through the efforts of Brother Baker.



General Rep. J. E. Sheppard stands outside Baker Hall, named for a Brotherhood member. Sheppard served as official International representative at the dedication ceremonies at Daytona Beach.

Whatever you saw, see Rockwell.

Aluminum.
Oak.
Masonite.
Pine.

A pro runs into a lot of different things on the job. Rockwell can handle them all. We have more ways to saw than anyone else.

Portable Saws

Rockwell's 14 portable circular saws give you a choice in the size, speed, power, special features and price you want: 8" to 12" extra heavy-duty saws, 4½" trim to 10¼" heavy-duty models, 6¾" and 7½" high-torque worm drive saws.

They have parts that are easy to replace at high wear points, ball bearing construction and failure-protected motors. Some have unique features like Rockwell's exclusive external gear lubricator. All have the feel and balance a pro can really appreciate.

Table Saws

Rockwell Delta has many table saws to choose from, for in shop or on site use. For example: Rockwell tilting arbor bench saws have big capacity, extra large table surface, adjustable positive stops. All controls are grouped right up front.

The Rockwell radial saws have famous double overarm action for greater left hand miter capacity. And up-front controls.

Whatever you saw, see the tool for the job at your Rockwell distributor. He's listed under "Tools Electric" in the Yellow Pages.

Free Catalogs

Or write for our catalog: Rockwell Manufacturing Company, 654 N.



Lexington Avenue, Pittsburgh, Pennsylvania 15208.

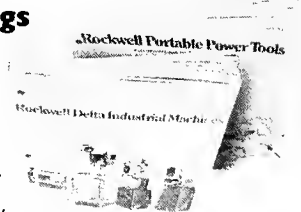

Rockwell Power Tools

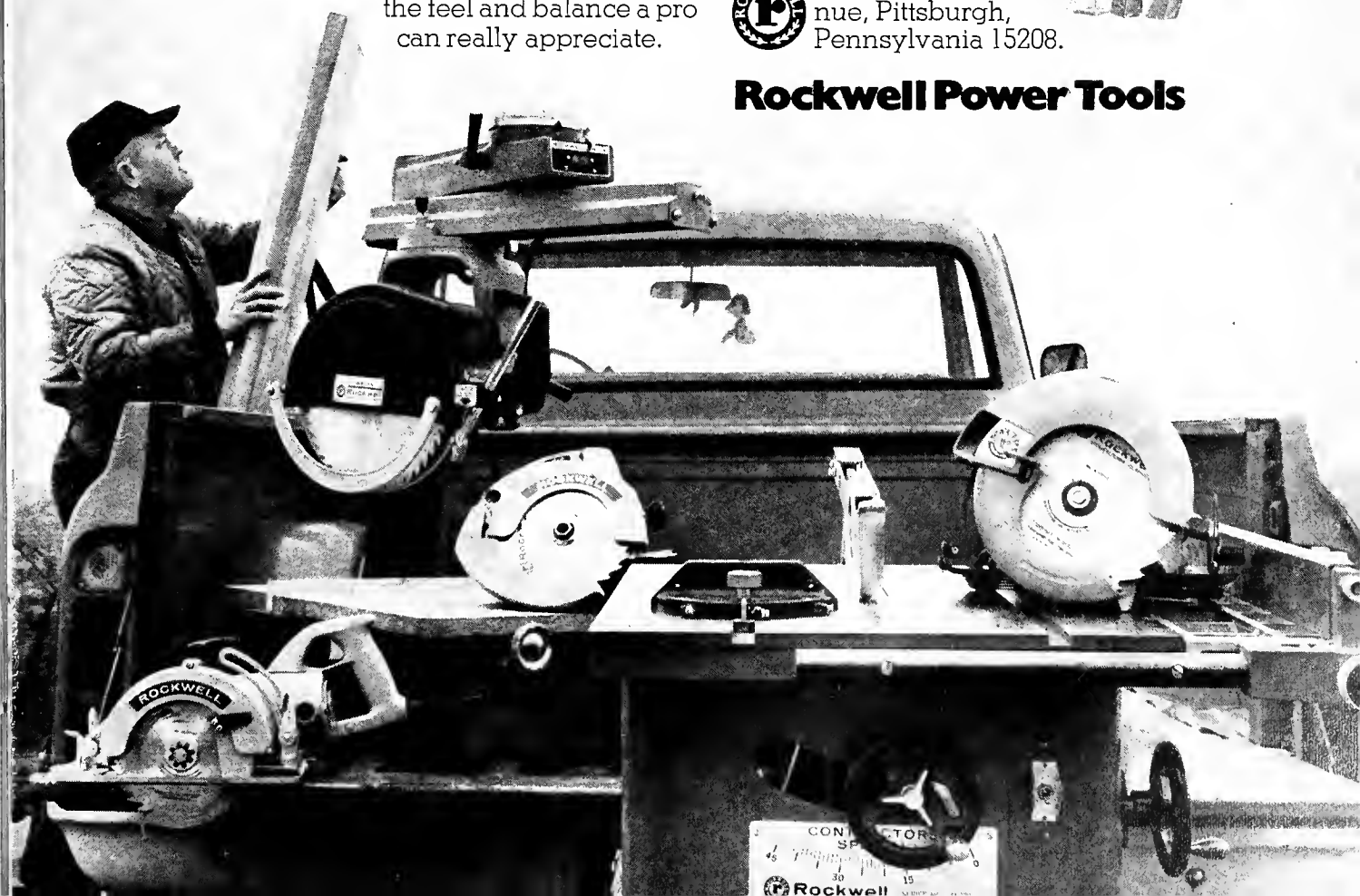

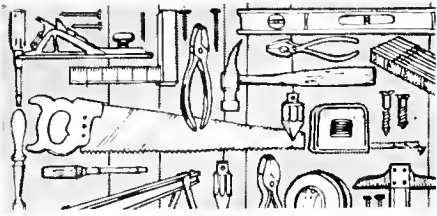

LOCAL UNION NEWS

Local 275, Newton Grows from Merger

Last January 21, all the local unions of the Newton District of Massachusetts were merged into Local 275 of Newton. The former locals included 708, 693, 847, 680, 1593. The local union meets at 263 Washington Street in Newton on Tuesdays.

Last December, the officers of Local 708 held a final banquet before the merger, and they invited officers and wives of the other local unions to the festivities. The pictures shown at right were taken on this occasion.

Mortgage Fund In Greater St. Louis

The Carpenters' District Council of Greater St. Louis, Mo., has established a mortgage loan fund financed by an initial two-and-one-half-million dollar investment from the union's pension trust fund. Approximately another million-and-one-half dollars will be added annually to the fund.

The fund is being administered by General American Life Insurance Company. The monies are designated for first mortgage loans on homes which must be built somewhere within the metropolitan St. Louis area in the 22-county area served by the Carpenters District Council.

The general purpose of the investment fund, Executive Secretary Ollie W. Langhorst said, is to provide more work for union carpenters in this area, encourage needed residential construction and stimulate the local economy.

He noted that projections made by the Regional Industrial Development Corporation show that this initial investment into the local economy will stimulate an additional three-and-one-half million dollars in spending throughout the area's economy for a total of almost six million dollars in new monies being pumped into this community.

Warren Millwrights Start New Addition

Millwrights Local 1102 of Warren, Mich., recently broke ground for a 40' x 80' addition to its headquarters. The addition will house the local's credit union, and its dental and optometric programs. Officers and members played host to area and national craft leaders at ground-breaking ceremonies early this year.



Pension members of the West Newton local union and their wives at the last get-together of the local union. From left, Mr. and Mrs. Ferdinando Pacione; standing behind them, Oscar Nelson; then, seated and standing, from left: Mr. and Mrs. Andrew Thompson, Mr. and Mrs. Gordon Woodworth, Mr. and Mrs. John Ross, Mr. and Mrs. Clarence MacRae, and Mr. and Mrs. James Chandler.



Participants in the West Newton merger gathering, from left: Local 1593 President Gilbert Smith and wife, Local 680 President George Haines and wife, Local 847 President Fred McDonough and wife, Local 275 Business Representative John Kelleher and wife, Local 693 President John Lombardo and wife, and Local 708 President Torstein Newmann and wife.



Officers of West Newton Local 708 at their last banquet before the merger with Local 275. From left: Recording Secretary Andrew Kuhn and wife, Vice President and Trustee Donald Watson and wife, President Torstein Newmann and wife, Financial Secretary Clinton Hunt and wife, Treasurer David Carder and wife, Trustee Joseph Brennan and wife.

New US Senator



Charles L. Carter, right, business representative of Local 819, West Palm Beach, Fla., extends best wishes to new U.S. Senator from the State of Florida, Lawton Chiles, and Mrs. Chiles. The occasion was a reception in Florida, early this year. Brother Carter presented the Brotherhood's official hammer tie clasp as a memento.

Retired Members Of Local 743 Busy

The Retired Carpenters Assn. of Local 743, Bakersfield, Calif., was formed last November 17 at Carpenters Hall. Temporary officers were elected at that time, with Lloyd E. Johnson heading the organization.

Much credit is given to Local 743 President A. V. Geer for getting the new group formed.

Last March, the group held its first regular election, and the following were selected: Lloyd E. Johnson, president; Virgil Trotter, first vice president and program chairman; Dillard Morse, second vice president and membership chairman; Barney Johnston, third vice president and social chairman; Bert Hamble, recording secretary; Thelma Bennett, corresponding secretary; R. C. Speake, treasurer; Ed Ruzicka, conductor; and W. H. Pickett, warden. Two committees were formed—a sick visitation committee and a ways and means committee.

The organization has had guest speakers from the Social Security Administration, the sheriff's office, and other official bodies. It has a magazine and book exchange, and there are drawings for door prizes at its regular monthly meetings—the first Tuesday of each month.

Big Striped Bass

Shown proudly displaying this catch is Trustee William "Bo" Perry from Carpenters Local Union No. 200, Columbus, Ohio. "Bo" caught the 32-pound striper while fishing in the surf at Cape Hatteras on Thanksgiving Day.

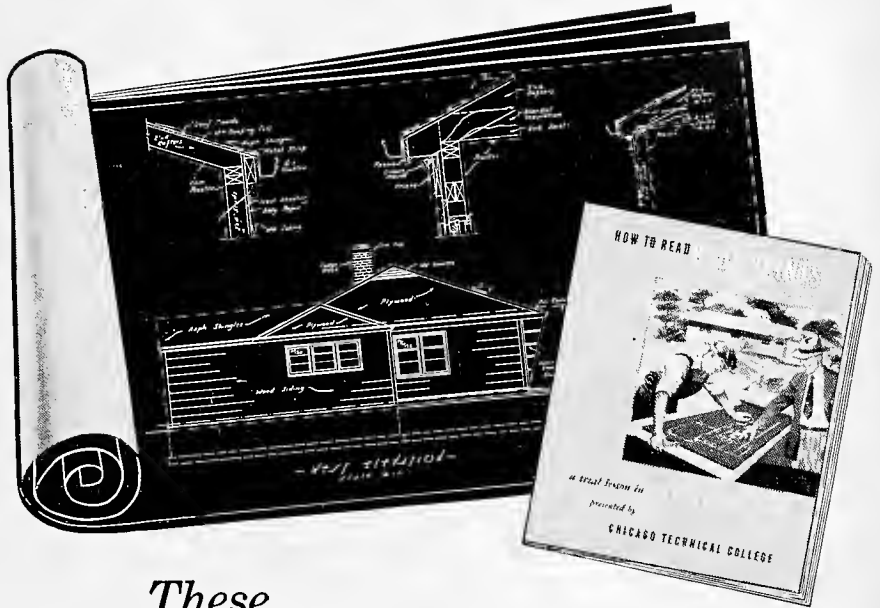

These
FREE BLUE PRINTS
have started thousands toward
BETTER PAY AND PROMOTION

That's right! In all fifty states, men who sent for these free blue prints are today enjoying big success as foremen, superintendents and building contractors. They've landed these higher-paying jobs because they learned to read blue prints and mastered the practical details of construction. Now CTC home-study training in building offers you the same money-making opportunity.

LEARN IN YOUR SPARE TIME

As you know, the ability to read blue prints completely and accurately determines to a great extent how far you can go in building. What's more, you can learn plan reading simply and easily with the Chicago Tech system of spare-time training in your own home. You also learn all phases of building, prepare yourself to run the job from start to finish.

CASH IN ON YOUR EXPERIENCE

For over 67 years, building tradesmen and beginners alike have won higher pay with the knowledge gained from Chicago Tech's program in blue print reading, estimating, foremanship and contracting. Through step-by-step instruction, using actual blue prints and real specifications of modern, up-to-date buildings, you get a practical working knowledge of every building detail—a thorough understanding of every craft. And as a carpenter or apprentice, you already have valuable experience that may let you move up to foreman even before you complete your training.

Don't waste a single day. Start preparing right now to take over a better job, increase your paycheck and command greater respect as the "boss" on the job. Find out about Chicago Tech's get-ahead training in building. Send for your free blue prints and trial lesson — today! Approved for Veterans.

CHICAGO TECHNICAL COLLEGE

H-143 TECH BLDG., 2000 S. MICHIGAN AVE., CHICAGO, ILL. 60616

FREE
BLUE PRINTS
AND
TRIAL LESSON

Send for your free trial lesson now. You'll agree that this training is simple yet practical—your surest way to promotion and increased income in building.

MAIL COUPON TODAY

Chicago Technical College
H-143 Tech Bldg., 2000 S. Michigan
Chicago, Illinois 60616

New G.I. Bill!
Vets check here

Please mail me Free Trial Lesson, Blueprints and Catalog.

Name _____ Age _____

Address _____

City _____ State _____ Zip _____

Occupation _____

Accredited Member National Home Study Council

PLANE GOSSIP

SEND YOUR FAVORITES TO:
PLANE GOSSIP, 101 CONSTITUTION
AVE. NW, WASH., D.C. 20001.
SORRY, BUT NO PAYMENT MADE
AND POETRY NOT ACCEPTED.

For The Thinking Man

Girl: Would you call it mental telepathy if I was thinking about the same thing you were thinking about?

Boy: No indeed—I'd call it just plain blind luck!

MAKE YOUR \$\$\$ CLICK—GIVE TO CLIC

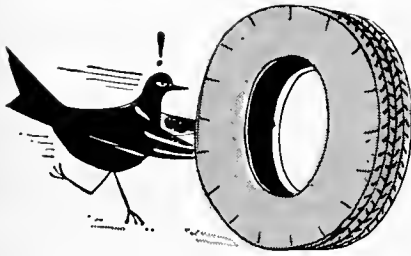

Something for the Birds

"How far to the next filling station?" the motorist asked the farmer.

"About two miles as the crow flies," replied the farmer.

"How far is it if the crow has to walk and roll a flat tire?"—LaVern Richards, Sr., Local 1074, Cadott, Wisc.

R U REGISTERED 2 VOTE?

Really A Mental Case!

Doctor: "I don't understand your complaint. You're 69 years old. How can you say your virility is too high?"

Senior Citizen: "What I mean, Doc, is that it's all up in my head!"

BUY ONLY UNION-MADE TOOLS

Picture Perfect!

The new steno was young and pretty, so the office Don Juan lost no time in recounting for her his exploits: on the gridiron, dance floor, tennis



court, in the war, et cetera, et cetera, ad nauseum. She listened attentively and, when he finally was finished, she nailed him with: "That's wonderful! Did you ever have a group photo made of yourself?"

—H. E. Millham, Fullerton, Pa.

UNION DUES—TOMORROW'S SECURITY

Short and Long of It

The mechanic said: "Lady, I've discovered what is wrong with your car. You have a short circuit in your wiring!"

"All right," said the lady driver. "How long will it take you to lengthen it?"—Judy Rohner, Waterloo, Iowa.

UNITED WE STAND

Cloudy, Not-too-Bright

The meteorologist for a shipping company announced to his wife with great glee: "I've been transferred to the south!"

"That's wonderful!" she exclaimed. "Especially since the weather here doesn't agree with you!"

GIVE A DOLLAR TO CLIC

Art of Staying Elected

The Senator's clerk was worried. "Senator, according to the volume of your mail, more and more of your con-



This Month's Limerick

An ardent young cowboy out west
Once loved a young lady with zest.

So hard did he press her
To make her say "Yes sir"
That he broke two cigars in his vest!

stituents are beginning to disagree with you."

"Keep a close record of the mail," replied the Senator, "and when enough disagree with me to get me re-elected, I'll certainly find a way to agree with them!"

LOOK FOR THE UNION LABEL

High Cost of Loving

The much-married actor, almost broke with paying alimony, asked his lawyer: "Isn't there any way to avoid paying alimony?"

"Sure," replied the lawyer. "Either stay single or stay married!"

WORK SAFELY—ACCIDENTS HURT

Depends on The View

The conceited actress was boasting. "I was offered \$4,000 a week to stay in New York," she bragged.

"And where did the offer come from," she was asked, "Hollywood?"

UNION-MADE IS WELL MADE

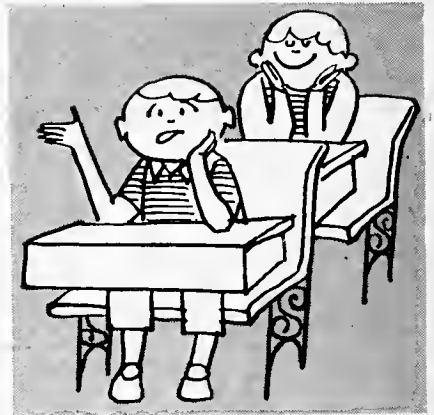

Willie Was Earthy

"What is the shape of the earth?" asked the teacher.

"It's round," responded Willie.

"Can you prove it is round?" replied the teacher.

"All right, it's square, then," answered Willie. "I don't feel like arguing!"

R U GOIN 2 D UNION MEETING?

No Change In Sight

Our nominee for the guy with the greatest nerve is the one who sent the Internal Revenue Service a tax return with a two-bit piece attached. He explained that he understood he could pay his taxes by the quarter!

THE CARPENTER

Workers Hurt the Most in Trade Falloff, Meany Tells Congress

The American worker is the major victim of the falloff in exports and the flood of imports or both, AFL-CIO President George Meany told the Senate Finance Committee in calling for sweeping reform of United States trade policy.

"Tens of thousands of American workers are suffering loss of jobs, underemployment, a lowered standard of living, and loss of their dignity and their role in our work-oriented society," Meany said. "These workers' grievances are with the Government of the United States because it is the Government's foreign trade and investment policies that have been responsible in most part for this situation."

To be specific, Meany listed:

- The United States has failed to react to the trade policies of other governments which depend on direct and indirect subsidies for exports and barriers for imports.

- The United States has encouraged "the soaring rate of investment by American companies in foreign operations." This has been done through tax concessions, facilitation of the movement of American corporations to foreign countries where they take advantage of low wages and failure of the United States to put a check on subsequent imports in competition with American-made products.

- The United States is permitting the export of U.S. technology to the point where American jobs are now gravely threatened and American national defense compromised.

- The United States is permitting the growth of multinational firms in defiance of antitrust legislation—multinational firms which ironically are the first to cry "free trade."

All of these developments, Meany said, "have had a serious impact on U.S. international economic relations and have displaced large portions of U.S. production."

The impact on jobs, he continued, represented a loss of some 700,000 job opportunities in 1966-69 because of imports. During the same period another 400,000 job opportunities were lost to a decrease in exports because of the growth of American production facilities abroad.

Meany also noted that there has been a tremendous development of U.S.-based international banks which have been financing foreign subsidi-

aries of U.S. companies to compete against American-made products.

"How long can the United States Government and the American people permit such operations of private companies and banks to continue without regulation?" Meany asked.

Meany insisted that the AFL-CIO is not "isolationist and has no intention of becoming isolationist." But, he said, the Federation wants "expanded trade that expands employment at home and abroad and that improves living standards and working conditions here and abroad," and it is not getting that kind of policy.

He called for a stop to subsidizing and helping American companies to set up and operate abroad; for regulation of the export of American capital for foreign operations; for regulation of the export of American technology; for pressure on international agencies to work for fair labor standards in world trade, and for an "orderly marketing mechanism" to regulate the flow of imports which are displacing American production. (PAI)

Busting Hard Hats



A cartoonist named Long drew the interpretation above of President Nixon's clamp-down on construction wages. The cartoon was supplied by Don Overhiser, business representative of San Diego County, Calif., District Council of Carpenters.

**For Nearly 50 Years ESTWING
Tools have been First Choice
of Expert Craftsmen the World Over!**



Of Course—There's A Reason—

Forged One-Piece Solid Steel, Strongest Construction Known, Unsurpassed Estwing Temper Balance and Finish. PLUS Estwing's Exclusive Nylon-Vinyl Cushion Grip—Won't Loosen, Come off, or Wear Out.

Estwing 

Dept. C-7
MFG. CO. 2647-8th St. ROCKFORD, ILLINOIS

APPRENTICESHIP & TRAINING



First Stuart Proctor Memorial Award



FIRST-PLACE WINNER in the Detroit, Mich., Carpentry Apprentice Contest at Cobo Hall was Armin Gollanek, shown here accepting the championship trophy from Chris Magnusson, executive secretary of the Michigan Carpentry Contractors Association and a co-ordinating judge in the sixth annual competition. From left, are Magnusson, Alfred Schack, third-place winner, Gollanek, Wallace Wallington, second-place finisher, and Henry Tuck, head carpentry instructor at the Detroit Apprentice School. In addition, Gollanek was presented the new rotating trophy (foreground) presented in honor of the late Stuart Proctor, veteran head carpentry instructor, by the Detroit Carpentry Joint Apprenticeship Committee. Gollanek holds membership in East Detroit 26, Wallington in Mt. Clemens Local 674, and Schack in Berkley Local 998.

Minneapolis Awards To Driver, Heiman



William Driver, Local 87, St. Paul, Minn., left, and Florent Heiman, Local 1644, Minneapolis, right, with L. J. Shosten, Apprenticeship Director, after receiving awards for outstanding service in related training and day school training. These awards were given by the Twin City Carpenters Joint Apprenticeship Committee at the annual completion banquet.

A total of 84 carpenter apprentices, 49 floor coverers, 18 cabinet makers, and 15 drywall trainees were honored at the banquet and received their certificates of completion. The master of ceremonies was Lawrence Knutson, Business Representative, Local 7. Warren Wildasin, Executive Director, St. Paul Home Builders Association, was the main speaker.

Floor Coverings Is Subject of Seminar

Labor and management leaders of the floor covering industry in St. Louis, Mo., received a two-day briefing and "a glimpse of tomorrow" recently, as Carpet, Linoleum and Resilient Tile Layers' Local 1310 held special training sessions at its new training school at 6330 Knox Industrial Drive.

The first day of the seminar was for industry and labor guests. It offered an explanation of the local's apprenticeship program and included a tour of the school. The second day's program consisted of an informal meeting for representatives of floor covering locals.

Tops in Memphis Apprentice Test



Earl Thomas Brents, right, was first place winner in the Memphis, Tenn., Annual Carpenters Apprenticeship Contest.

New Journeymen in Wyoming

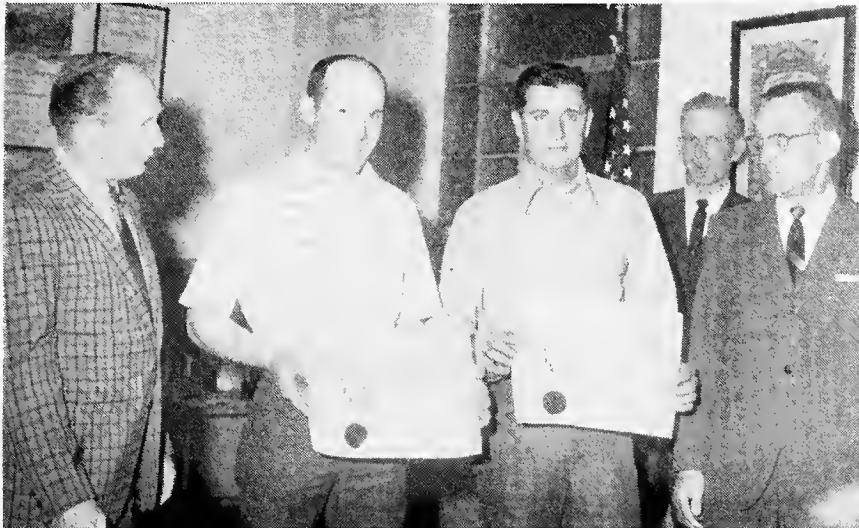

Members of Local 1564, Casper, Wyoming, receiving journeyman certificates and pins on completion of four years' apprenticeship training are Robert W. Lamb and Michael F. Skinner. Pictured from left to right: H. P. Johnson, business representative; Robert Lamb; Michael Skinner; Ralph Davidson, apprenticeship coordinator and, in the background, Carleton Key, recording secretary.

Madison County, Illinois, Winner

Thomas Thorp of Local 1808, Wood River, Ill., was named first-place winner in the annual manipulative test for fourth-year apprentices sponsored by the Madison County District Council of Carpenters which was held April 3, 1971, at the district council headquarters in Granite City, Illinois.

Runner-up honors went to Larry Brooks of Granite City Local 633. Five apprentice participants were selected for the practical segment of the contest from those achieving top scores in a written test.

This year contestants constructed a scale model of an "A" frame vacation-style cottage based on plans drawn by the architectural firm of Haldi and Loyet.

Journeymen carpenters acting as judges were Marvin Wallace, Local 633; John Jones and Nelson Miller, Alton Local 377; and Dean Warner, Local 1808.



Thorp and A-frame model.

Michael Ulizza, Cleveland Winner

Michael Ulizza, Richmond Heights, Ohio, was named winner of the Greater Cleveland carpenter apprentice contest held recently at the Parmatown Shopping Center in Parma, Ohio.

Ulizza, a member of Carpenters' Local 105, won a \$100 savings bond and the opportunity to represent Cleveland in the Ohio State contest in Cincinnati on May 26 and 27.

The other winners were: Thomas Peters, Local 1750, 2nd prize \$75 bond; Franklin Blaney, Ashtabula, Local 1643, 3rd prize \$50 bond; and Roger Solomon, Local 1108, and Michael Strainic, Local 105, each of whom won a \$25 bond for 4th and 5th place.

William Friedson, carpenter apprentice coordinator, supervised the contest. Forest City Material Company donated the material, and Ernest F. Donley's Sons provided the power equipment.



Michael Ulizza, first place winner.

LABOR and MATERIAL COSTS

NATIONAL CONSTRUCTION ESTIMATOR
NINETEENTH EDITION
ACCURATE BUILDING COSTS IN DOLLARS AND CENTS
LIGHT and HEAVY CONSTRUCTION

1971 UNIT COSTS
COMPILED FROM
THE RECORDS OF
HUNDREDS OF
CONTRACTORS
AND MATERIAL
SUPPLIERS

— 208 Pages ONLY \$4.75
8 1/2 x 11
NO. ADVERTISING In California add .24c tax

- ACCURATE BUILDING COSTS IN DOLLARS AND CENTS
- AVERAGE LABOR COSTS FOR THOUSANDS OF ITEMS
- TYPICAL SUB CONTRACT PRICES INCLUDED
- NEW ESTIMATING RULES OF THUMB

Send for FREE Building Books Catalog

CRAFTSMAN BOOK COMPANY OF AMERICA Dept. C4
124 SO. LA BREA AVE., LOS ANGELES, CALIF. 90036

Please send me the *Nineteenth Edition of the NATIONAL CONSTRUCTION ESTIMATOR*. \$4.75
In California add .24c Sales Tax

Please send me FREE Building Books Catalog.

Firm Name _____
 Your Name _____
 Address _____
 City _____ State _____
 AMOUNT ENCLOSED _____ Zip _____

10 DAY FULL MONEY BACK GUARANTEE

Made to put in a hard day's work

*Designed by Carpenters
Especially for Carpenters*

There's plenty of comfort, convenience and work-saving features in these overalls. Made just like you want 'em... because they're designed by workers like yourself. Guaranteed to be the best you've ever worn or we'll take 'em back. No questions asked.

Lee® UNION MADE
M.R. CARPENTERS' OVERALLS

H. D. LEE COMPANY, INC.
SHAWNEE MISSION, KANSAS 66201
"World's largest manufacturer of union-made work clothes."





Western and Central Washington apprentices. Row One, Left to Right: Dennis Abel, Samuel Deary, David Arne, Norman Stewart, Daniel Christiansen, Andrew Bitz, Eddie Bird, Gary Rhoads, David Landree, and David Uhron.

Row Two: John Gala, Heinz Deuman, Carl Edminister, Paul Edminister, Darryl Armitage, Tom Johansson, Roger Swearinger, Gerald Snyder, Ronald Thorpe, Donald Jones, John Absten, Ben Diebert, instructor, and Leonard Liebelt, Southwest Washington coordinator.

Row Three: Larry Hooper, Phillip Woods, Galen Dillard, Michael Wagner, Murray Kotas, John Trumbly, Vernon Sponberg, Gary Benn, Thomas Bacon, Charles Alexander, David Clymer, Kenneth Madden, Royace Marler, Wayne Malray, and Rodrick Rice.

Tacoma, Wash., Honors Apprentices

The Tacoma Carpenters and Shipwrights Joint Apprenticeship Committee recently assembled its fourth year apprentices. The fourth year manipulative completion examination and local contest was held on Saturday, May 1, at the L. H. Bates Vocational Technical Institute of Tacoma, Wash.

Each apprentice was required to build a tool bench and tool box. Each was graded by four Judges, two from management and two from labor. Participating were (36) young men who graduated May 26.

The winners were: first place John Absten; second place, Tom Johansson; and third place, Dan Christainsen. Absten will represent Local 470 in the state contest.

On Saturday evening, Carpenters Local 470 hosted the apprentices and their wives at an open house, awards banquet and dinner and dance.



Officers and Joint Apprenticeship Committee Members of the Western and Central Washington Carpenters Joint Apprenticeship and Training Committee.

Front Row, Left to Right: Elmer Chulupa, judge, Local 470; Joseph Zinski, Local 470 member and JAC member and designer of project; Elvet Whitelock, president, Local 470 and JAC member; Percy B. Watkins, financial secretary, Local 470 and JAC member; John Paul Jones, trustee of Local 470 and JAC member.

Second Row: Leonard J. Liebelt, Southwest Washington Apprenticeship & Training coordinator, Local 470 member; Larry Bartolatz, judge, Local 470; Jack Skanes, 3rd year instructor, Local 470 member; Lloyd Mathison, judge from Home Builders Association; William Goettling, Jr., judge from Associated General Contractors of America; Reno Switzer, Federal representative, Bureau of Apprenticeship and Training.

Third Row: Harold P. Miller, trustee of Local 470 and JAC member; Norman Nagel, business representative of 470 and secretary of the JAC; Edwin De Tray, Washington State Department of Labor Area Representative for Apprenticeship Division; Leroy Fithen, business representative of 470 and member of Drywall JTC.

THE 1971 CONTEST

The 1971 Carpenters International Apprenticeship Contest will be held in Detroit, Michigan, August 12, 13, and 14. Every state and province should be represented by carpenter, millwright, and mill-cabinet contestants.



64 New Journeymen in Chicago District Council

Chicago District Council of Carpenters recently welcomed 64 new journeymen at Apprenticeship Completion Exercises. The graduates completed 12 weeks of classroom work in the pre-apprenticeship program and four years of classes and on-the-job training. Classwork was done at the Washburne Trade School, one day a week for the first 18 months. In lower photo, graduates receive completion certificates from the United Brotherhood of Carpenters and Joiners, Washburne Trade School and the U.S. Department of Labor's Bureau of Apprenticeship and Training. From left are Richard Pepper, trustee, Carpenters Apprentice Program; A. "Duffy" Dardar, coordinator, Carpenters Apprentice Program; Herb Skinner, second general vice president, Brotherhood of Carpenters; George Vest, president, Chicago District Council of Carpenters, and graduates, Dennis Sexton, of Local 13; Ronald Johnson, of Local 141; and Arthur E. Christiansen, of Local 141.



Pre-Apprentices Graduated in DC

The Manpower Development and Training Program administered in the District of Columbia and vicinity recently held graduation ceremonies.

Left to right at D.C. Ceremonies: Nicholas R. Loope, director, JCAC; James Roberts; Delbert Branham; H. E. Morris, project coordinator, UB-MDTA; and Harlin Whiting.



Honored at the recent MDTA ceremonies in the Nation's Capitol were: First Row, left to right, William Smith; David Bodie; H. E. Morris; Harlin Whiting; Charles Butler; Second Row, Delbert Branham; James Roberts; Richard Roberts; James Brown; Gary Clifton; Ernest Edwards; Leroy Coates; Third Row, James Jones; Roger Burton; Melvin Chambers; Arthur Bullock; William Lynch; Norman Fenwick.



APPROVED VETERANS



These 3 BIG DRAFTING KITS GIVEN TO YOU!
when you train at home with NASD for a **HIGH PAY JOB IN DRAFTING!**

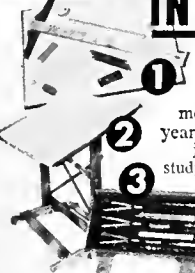

Take your pick of 1000s big salary jobs open to Draftsmen. U.S. Labor Dept. reports "42% more Draftsmen needed in next 10 years—not enough applicants to fill jobs available now." Easy home-study plan has helped 100s beginners toward \$\$\$\$\$, security, prestige as Draftsmen—many with only grade school training. Others report good earnings drafting part time while still learning. Why not you?

RUSH COUPON FOR FREE KIT!
Mail coupon for **FREE "DRAFTING CAREER KIT,"** Sample Lesson, Drafting Aptitude Test including new 5-Way Drafting Instrument & 20-Page Book, "Your Future in Drafting" — **ALL FREE.** No salesman will call. G.I. Bill approved. Write today.



NORTH AMERICAN SCHOOL OF DRAFTING, Dept. 11467
4500 Campus Drive, Newport, California 92660

Rush "DRAFTING CAREER KIT," including Book, Sample Lesson, Aptitude Test & Drafting Instrument—**ALL FREE!**

NAME _____ AGE _____

ADDRESS _____

CITY _____ STATE _____ ZIP _____

BE A PANELING EXPERT

Take all the guesswork out of aligning and marking corner panels with our kit of rugged aluminum off-set jigs and marking gauges.

Increase your speed and accuracy as you scribe perfect panels marked for a "pressed-in" fit. Panel-by-panel instructions included for inside and outside corners and for the location of cut-outs, for plywood panels of 1/4" or less.



NOW... OFFSET JIGS FOR ROUTERS

A Cut-In-Place method of fitting inside corner panels. The router takes the place of the marking gauge or scriber and precisely cuts over 90% of an 8 ft. panel. Complete instruct.

- Offset jigs and marking gauges. \$9.95 Postpaid. (Calif. tax 50c)
- Cut-In-Place jigs for your router. \$6.95 Postpaid. (Calif. tax 35c)

Only Californians add sales tax.
C.O.D. orders: you pay postage and charges.
Satisfaction guaranteed or money refunded.

A revolutionary new tool dolly!

Heavy duty compact design • turns on a dime • jumps electric cords with ease

Detailed Construction Plans — \$1.95.
Check or M.O. Californians add 10c tax.

PANELING SPECIALTIES CO.
Box 11764 • Palo Alto, Calif. 94306

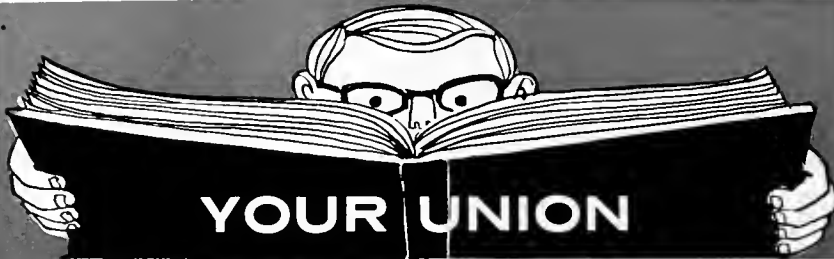

YOUR UNION DICTIONARY

This is the fifth of a new feature series planned to keep you better informed on the meanings of terms related to collective bargaining, union contracts, and union business. Follow it closely, and your union membership will become more meaningful, and your ability to participate in decisions which affect your future and security will be strengthened. It was compiled by the International Labor Press Assn, and is used with permission.

C

Code of Ethics: A declaration of principles and practices adopted by the AFL-CIO for the guidance of its affiliated unions, together with provisions of enforcement. Several international unions, and other bodies such as ILPA, have codes of ethics relating to their own operations.

collective bargaining: Negotiations between an employer or group of employers and a labor union for a contract covering employees in a bargaining unit. First established as a legal right by the National Industrial Recovery Act of 1933, and reconstituted by the Wagner Act and other subsequent legislation. The process is regulated by the National Labor Relations Board. Basic requirements are good faith of the parties, free choice of spokesmen and the signing of a formal contract if agreement is reached.

company store: In former years, the only shopping facility for residents of a company town (see below). Wages were often paid in scrip, redeemable nowhere else. Abuses were rampant, especially in mining and southern textile areas. Few company stores, in the classic sense, remain.

company town: A community dominated entirely or chiefly by one concern, with homes and other facilities owned by the company, and the company being the de facto municipal government.

company union: A one-company group of employees, frequently organized or inspired by management and always dominated by the employer; outlawed as an unfair labor practice.

compulsory arbitration: Arbitration compelled by order of a judicial body, or in rare instances agreed to by the parties in a labor-management dispute. Arbitration is a common device for settling disputes that arise under existing contracts but this is not considered "compulsory" in ordinary usage.

compulsory retirement: Separation from employment at age specified by union contract or company policy.

concerted activities: Joint action for organizing, bargaining, processing grievances, etc., "protected" under Taft-Hartley.

conciliation: A process which attempts to resolve labor disputes by compromise. It is advisory and non-compulsory, but under the law a union must notify the appropriate federal agency of an impending strike. Most conciliation work is done by the Federal Mediation and Conciliation Service.

consent decree: A decree by a court to which the parties consent.

consent election: A labor board vote among employees in a bargaining unit as to their choice of union (or no union), in which management and the union or unions have agreed on the terms of the election.

SERVICE TO THE BROTHERHOOD

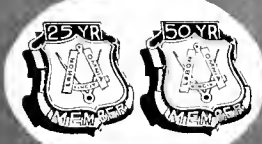

A gallery of pictures showing some of the senior members of the Brotherhood who recently received 25-year or 50-year service pins.

NEWPORT, R.I.—An "Old Timers Night" was held by Local 176 on April 5. Twenty-three retired brothers received special pensions and membership buttons. The pension pays \$75 per quarter for the rest of their lives. None of the brothers receiving the pension has ever contributed toward it.

Our oldest member, William Foster,

received a 65-year membership button and special pension.

In Photo No. 1A 23 members of Local 176 who received special pension checks and membership buttons at an old-timers' night held on April 5 at Local No. 176, Newport, Rhode Island. Shown in the photograph are: Front Row, Left to Right: Brothers Clifford S. Chace, 30 years; Tito Boiani, 35 years; Joseph Perry, 45 years; William Foster, 65 years; Harold Bradley, 50 years. Second Row, left to right: Arthur Davis, general representative; James K. Behan, 30 years; Frank Deegan, 30 years; Roland Manchester, 30 years; Manuel Amaral, president of Local No. 176; Napoleon Couture, 30 years; Rodney P. Bowley, B.A. of Local No. 176; Raymond Johnson, 45 years; and Leroy K. Bartlett, Administrator of the Rhode Island Pension Plan.

In Photo No. 1B William H. Foster receives a 65-year membership button and a special pension check. General Representative, Arthur H. Davis, is making the presentation. Others in photo, from left to right are: Rodney P. Bowley, B.A., Local No. 176; General Representative Arthur H. Davis; Brother Foster; Leroy K. Bartlett, Administrator of Rhode Island Pension Plan; and Manuel Amaral, President of Local No. 176.



1A



1B

This point lets you bore holes up to 1 1/2" with small electric drill

IT'S HOLLOW GROUND to bore cleaner, faster at any angle

Now step-up the boring range of your small electric drill or drill press to 1 1/2" with Irwin Speedbor "88" wood bits. 1/4" shank chucks perfectly. No wobble. No run-out. Sharp cutting edges on exclusive hollow ground point start holes faster, let spade type cutters bore up to 5 times faster. You get clean, accurate holes in any wood at any cutting angle.

Each Irwin Speedbor "88" forged from single bar of finest tool steel. Each machine-sharpened and heat tempered full length for long life. 17 sizes, 1/4" to 1 1/2", and sets. See your Irwin hardware or building supply dealer soon.



IRWIN SPEEDBOR "88" WOOD BITS
at Wilmington, Ohio, Since 1885

LAYOUT LEVEL

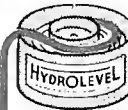

- ACCURATE TO 1/32"
- REACHES 100 FT.
- ONE-MAN OPERATION

Save Time, Money, do a Better Job With This Modern Water Level

In just a few minutes you accurately set batters for slabs and footings, lay out inside floors, ceilings, forms, fixtures, and check foundations for remodeling.

HYDROLEVEL is the old reliable water level with modern features. Toolbox size. Durable 7" container with exclusive reservoir, keeps level filled and ready. 50 ft. clear tough 3/10" tube gives you 100 ft. of leveling in each set-up, with 1/32" accuracy and fast one-man operation—outside, inside, around corners, over obstructions. Anywhere you can climb or crawl!

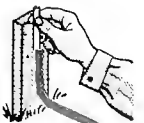

Why waste money on delicate instruments, or lose time and accuracy on makeshift leveling? Since 1950 thousands of carpenters, builders, inside trades, etc. have found that HYDROLEVEL pays for itself quickly.

Clip this ad to your business stationery and mail today. We will rush you a Hydro-level with complete instructions and bill you for only \$7.95 plus postage. Or send check or money order and we pay the postage. Satisfaction guaranteed or money back.

Ask your tool dealer to order it for you. We allow the usual dealer discount on 1/4 Doz. lots and give return-mail service.

HYDROLEVEL
925 DeSoto, Ocean Springs, Miss. 39564
FIRST IN WATER LEVEL DESIGN SINCE 1950



1



2

SERVICE TO THE BROTHERHOOD

A gallery of pictures showing some of the senior members of the Brotherhood who recently received 25-year or 50-year service pins.



3

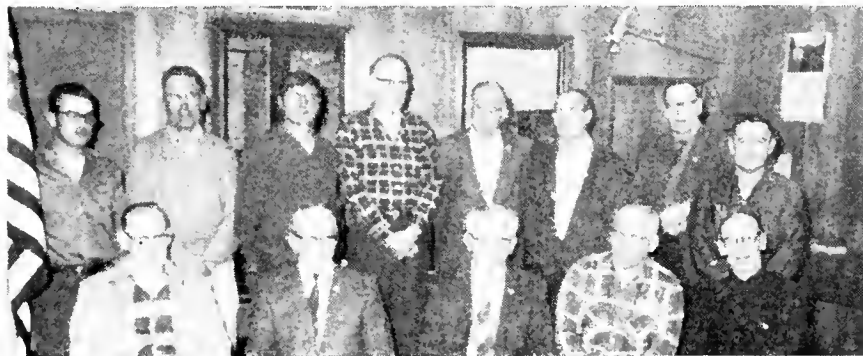

4

(1) HAVERTHILL, MASS.—Local 82 recently honored its 25 and 50-year members in brief but inspired ceremonies. Those present to receive service pins are shown in the photograph, seated from left, John H. Subatch, Sr., (30 years), William Q. MacKinnon (49 years), Edward P. McLaughlin (49 years), and Phileo Lessard (31 years). Standing behind them is Bernard L. Guilford, Jr., business agent. Those awarded 25-year pins who were unable to attend the presentation ceremonies were Maurice Amiro, Stanley Fabiyan, Lester Langtin, Anthony J. Noon, Sr., Harlan E. Noyes, Anthony Pasquale, Joseph A. Poulin, Arthur Robidoux, Mike Woron, and Max E. Welch.

Four members were awarded 50-year pins—Gust Cosio, Fred G. Ellis, Irvin W. Felch, and Harris Slavenwhite. These members were presented their pins individually at their homes.

(2) NAPLES, FLA.—Seven members of Local 1641, Naples, were recently presented 25-year pins. They are, left to right: Curtis Gayhart, Gerhart Gulder, Raymond Dulaney, C. V. Raulerson, and Jim P. Cooper. Not present for the picture were Albert Brown and Thomas P. Winn.

(3) VALLEJO, CALIF.—Local 1068, with only 130 members, recently pre-

sented its fourth 50-year pin in a little more than one year. Henry Mahony, shown at center in the picture, a joiner, is the latest to receive such a pin. Presenting the pin to him is Local President Paul Kanouff, second from right. Also shown is Ralph Ellis, a carpenter, 25 years; Roy Jenson, a shipwright, 25 years; and Haskell Kitchens, a shipwright, 25 years.

(4) BEMIDJI, MINN.—Twenty-five year pins were presented to a group of members of Carpenters Local 1934 at the March 17 meeting. Several members had longer records, but received 25-year pins. Hugh Swift, business representative from Crookston, spoke to the group on several issues concerning the construction

industry now and in future years. Pictured, left to right, back row: John Heath, recording secretary; Fred Manecke, 25 years; Paul Hannem, president; Hugh Swift of Crookston; Roy Lind, 32 years; Terry Taunt, 29 years; Andy Edstrom, 28 years; Lawrence Wallace, 25 years. Seated, Stanley Guest, 25 years; Olaf Hannem, treasurer and 29-year member; Edwin Burud, business representative and financial secretary of Local 1934, 25 years; Jerry Herman, 29 years; Elmer Nolting, 25 years. Cliff Thompson, a 28-year member and M. W. Aldrich, 29-year member, were not present but received their 25-year pins. Scott Woodward, deceased, had been a 29-year member. Lunch was served by Olaf Hannem and Lawrence Wallace.

Substitool.

The new Skil Tradesman's Program: if one of your Skil tools breaks down, you can use one of ours free.

From now on, when you buy a Skil Tradesman's tool and it goes down, you get another like it to use while yours is being fixed at your nearest Skil Service Center.

Usually, they can do the job while you wait. But if they can't, you get a service replacement tool to keep you going until yours is ready.

A Registration Card now comes with all the tools in the program. Just fill it out and send it in. Once you're registered, you're covered. And all the Skil tools you use the most and the hardest are included.

As a member of the Tradesman's Program, you get a special Tradesman's identification card. And a free personalized label for your Skil tool.

Also, you're eligible to apply for credit so you can even charge service. So that's it—get Skil and you've always got tools. Is it a deal?

Please send me details of the Substitool™ Program and a free Tradesman's catalog.

Name _____

Address _____

City _____ State _____ Zip _____

Mail to: Skil Corporation,
Dept. TC, 5033 Elston Ave., Chicago, Ill. 60630.

SKIL®

Nobody was ever sorry he bought the best there is.



REPORT

■ With unemployment reaching ten-year highs, during a time when prices keep spiraling upward at an alarming pace, it seems to follow that the need for political action is greater than it has been at any time since the end of World War II.

The Nixon brand of economics defies all accepted theories.

When unemployment is climbing, it is normal for prices to decrease, as the purchasing power of the nation is diminished by layoffs. Only President Nixon has been able to achieve the worst of two worlds at the same time. Prices keep sky-rocketing, even as joblessness continues to grow. Obviously, only political solutions are capable of remedying the situation. President Nixon is sitting on nearly \$13 billion of money already appropriated for construction of hospitals, sewers, water-purification plants, etc. Only strong prodding from the Legislative Branch of the Government can force him to turn the construction money loose.

Bills to speed up public works programs are hanging fire in the Congress. They must be blasted out by political pressure from labor and other liberal groups, if unemployment in construction is to be lowered significantly. Through "CLIC", our Brotherhood is working diligently to force removal of the roadblocks which stand in the way of a growing and more prosperous America.

Our success will be closely tied to the success we have in raising voluntary "CLIC" contributions to assist our friends in Congress who depend to a great extent on our help.

The following list of donations to "CLIC" is both encouraging and disappointing; it is encouraging because delegates to various conventions and conferences responded quite generously. It is disappointing because contributions from rank and file members of our local unions have not been all that they should be. ■

Recent Membership Contributions to the Carpenters Legislative Improvement Committee

SPECIAL CONTRIBUTIONS		
Local	State	Amount
CALIFORNIA		
34	San Francisco	\$ 60.00
483	San Francisco	608.70
771	Watsonville	10.00*
828	Menlo Park	5.00
1400	Santa Monica	107.00
1622	Hayward	22.00
COLORADO		
362	Pueblo	2.00
1351	Leadville	10.00*
CONNECTICUT		
1520	Bridgeport	20.00
DELAWARE		
1545	Wilmington	30.00

Local	State	Amount
DISTRICT OF COLUMBIA		
2311	Washington	\$ 30.00
FLORIDA		
959	Boynton	20.00
1765	Orlando	40.00
GEORGIA		
225	Atlanta	60.00
HAWAII		
745	Honolulu	10.00
IDAHO		
1482	Grangeville	10.00*
2816	Emmett	20.00
ILLINOIS		
13	Chicago	10.00
62	Chicago	10.00
174	Joliet	65.00
181	Chicago	55.00
839	Des Plaines	335.75
INDIANA		
215	Lafayette	40.00
232	Fort Wayne	41.00
1858	Lowell	20.00
3154	Monticello	6.00
IOWA		
4	Davenport	40.00
948	Sioux City	48.00
KANSAS		
168	Kansas City	50.00*

Local	State	Amount
201	Wichita	\$ 40.00*
561	Pittsburgh	20.00*
714	Olarhe	48.00*
750	Junction City	10.00*
797	Kansas City	10.00*
918	Manhattan	10.00*
1198	Independence	10.00*
1212	Coffeyville	10.00*
1224	Emporia	10.00*
1445	Topeka	60.00*
1529	Kansas City	60.00*
1542	Dodge City	10.00*
1724	Liberal	10.00*
1926	Chanute	20.00*
2279	Lawrence	20.00*
2383	Winfield	10.00*
2417	Osawatomie	10.00*
3234	Hays	10.00*
MASSACHUSETTS		
32	Springfield	56.00
107	Worcester	60.00
866	Norwood	13.00
885	Woburn	20.00
MICHIGAN		
337	Detroit	49.00
MISSOURI		
61	Kansas City	91.00*
110	St. Joseph	15.00
1635	Kansas City	10.00*
MONTANA		
1172	Billings	20.00
NEW JERSEY		
118	Jersey City	20.00
391	Hoboken	12.00
2018	Lakewood	100.00
2315	Jersey City	20.00
NEW YORK		
125	Utica	60.00
146	Schenectady	20.00
502	Canandaigua	60.00
1134	Mount Kisco	80.00
1135	Port Jefferson	50.00
1483	Patchogue	46.00
1577	Buffalo	40.00
1649	Woodhaven	100.00
1973	Riverhead	20.00
OKLAHOMA		
329	Oklahoma City	10.00*
986	McAlester	10.00
OREGON		
1388	Oregon City	25.00
PENNSYLVANIA		
122	Philadelphia	40.00
514	Wilkes Barre	40.00
838	Sunbury	300.00
900	Altoona	20.00
TENNESSEE		
50	Knoxville	50.00
2473	Bristol	20.00
TEXAS		
213	Houston	110.00
963	Houston	10.00
1066	Houston	10.00
1084	Angleton	10.00
1226	Pasadena	10.00
1334	Baytown	10.00
2232	Houston	40.00
VIRGINIA		
396	Newport News	101.00
1534	Petersburg	20.00
WASHINGTON		
98	Spokane	30.00*
131	Seattle	70.00*
313	Pullman	20.00*
317	Aberdeen	23.00
338	Seattle	30.00*
470	Tacoma	70.00*

Continued next page

Local State	Amount
562 Everett	30.00*
770 Yakima	40.00*
954 Mount Vernon	30.00*
1148 Olympia	30.00*
1303 Port Angeles	10.00*
1332 Grand Coulee	10.00*
1532 Anacortes	30.00*
1597 Bremerton	40.00*
1689 Tacoma	20.00*
1699 Pasco	20.00*
1707 Kelso-Longview	20.00*
1708 White River Valley	20.00*
1715 Vancouver	40.00*
1797 Renton	20.00*
1849 Pasco	30.00*
1862 Spokane	10.00*
1974 Ellensburg	10.00*
1982 Seattle	20.00*
2127 Centralia	10.00*
2205 Wenatchee	10.00*
2207 Enumclaw	10.00*
2317 Bremerton	10.00*
2382 Spokane	19.00*
2403 Richland	30.00*
2498 Longview	50.00
2536 Port Gamble	20.00
3119 Tacoma	10.00*

WYOMING

1564 Casper	44.00
-------------	-------

TOTAL \$4,864.45

*Includes contributions from delegates representing their local unions at the state council conventions. In some instances, these convention contributions were the only monies received from the local unions.

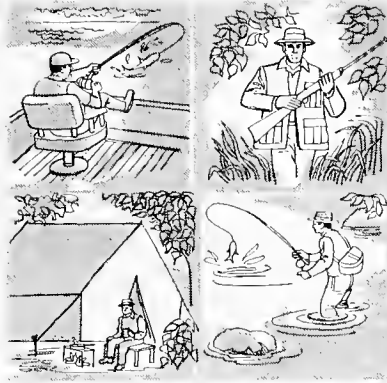

Outdoor Meanderings

Readers may write to
Fred Goetz
 2833 S. E. 33rd Place,
 Portland, Oregon 97202

Back Casts

... Sherwood P. Sanders of Buffalo, New York, a member of Local 1978, duped a 4½-lb. largemouth bass on a "Silver Rapola" lure from Canandaigua Lake.

... Carl Naugher of Knoxville, Tennessee, a member of Local 50 for over 25 years, tripped to the briny off Florida in company with friend Homer Greenway. They made it back to shore with as nice a catch of bluefish as we've seen in many a day. Here's the lucky—and skillful—pair with their blues—44 of 'em.



Naugher and Greenway

For Sparetime or Full Time Income, There's Good Money In Sharpening



Here's a proven practical way to earn extra dollars in spare time — to develop a money-making repair business of your own. Investment is small. There's no overhead, no stock of goods to carry. No experience needed, no canvassing. You do it with the famous Foley Saw Filer that automatically sharpens all kinds of saws — and the Modern Lawn Mower Sharpener that precision sharpens all types of mowers.

EARN \$3 to \$6 An Hour Sparetime

Hundreds of people like yourself are making cash like this — \$20 to \$30 a week — right now in spare time. "My spare time saw filing business has made me \$952 these first ten months" — says R. T. Chapman. Many have built a complete sharpening service with such year-around profits. You can too, simply by following the sure, easy Foley Plan.

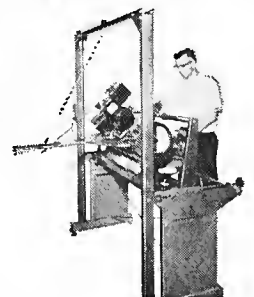

Foley

MANUFACTURING CO.
 MINNEAPOLIS, MINN.

**GET FREE BOOK NOW
 "MONEY MAKING FACTS"**

This valuable book shows you how to start, how to get business from home owners, factories, carpenters, etc., and how to make profits fast. Mail coupon today. No salesman will call.

FOLEY MFG. CO. 718-1 Foley Bldg., Minneapolis, Minn. 55418

Saw Filer information. Lawn Mower Sharpener information. Money Making Facts booklet.

NAME _____

ADDRESS _____

CITY _____ STATE _____



1

(1) EL DORADO, ARK.—Here are members of Local 1683 who have been members of the Brotherhood 25 or more years. This picture was taken at a supper given in their honor on April 16. The supper was attended by 126 members and their families. Cooksey Morgan has been a member for 51 years.

The members in the picture and their years of service are: 50 years: Cooksey Morgan; charter members with 35 years: Loy Swilley, Ben Murphrey and W. G. Whatley; 30 years or more: J. K. Bass, J. S. Bates, O. E. Kinard, W. N. Mitcham, C. H. Skinner, Coy Ellis; 25 years or more: Grady Blann, E. H. Cottrell, Proctor Hux, J. W. Holder, J. H. Lowery, M. E. Roark, L. C. Aycock, Floyd Babel, C. D. Brown, T. A. Davis, Q. E. Ethridge, Grady Fuller, J. A. Glaze, B. F.

SERVICE TO THE BROTHERHOOD



A gallery of pictures showing some of the senior members of the Brotherhood who recently received 25-year or 50-year service pins.

Hannegan, Oscar Hill, W. M. Holder, Frank Nichols, C. B. Perdue, C. H. Pickering, J. O. Taylor, Oren West, I. T. Strickland. Members not present: 25 years or more: Glen Barksdale, George Hux, T. J. Kelly, F. D. Shockley, B. B. McAvoy, Lee Cheatham, C. H. Freeman, Roy Halligan, J. L. Hampton, Ernest Henderson, Robert Hux, Clyde Jinks, J. C. Lewis, Ed Love, W. P. Mitcham, E. E. Stanley. 30 years or more: Paul Brewer, D. C. Davis, Ben Dumas, E. A. Hines, Raymond Ogle.

to attend. The presentations are made at regular meetings, instead.

In Photo No. 2A, left to right: President Arthur Prokaski presents Raymond Swanson with past officer's (trustee) pin upon his retirement after many years of service.

In Photo No. 2B, left to right: Anthony Ortloff, 25-year pin; Ralph VanDorpe, former officer, 50-year pin; President Arthur Prokaski; John Martin, 25-year pin.

In Photo No. 2C, left to right: Myron Bentley, past trustee; George Vix, past president and charter member; President Arthur Prokaski; Herbert Rhoads, past trustee; on the occasion of presentation of past officers' pins to Myron Bentley and Herbert Rhoads.

2A



2B



2C



Wanigan

Continued from page 5

cook crew begins at 3:30 in the morning, when the bull cook climbs out of his bunk to start the fire in the cookhouse's old wood-burning range. He's joined a few minutes later by Harvey Spears and the "flunky," who ready the breakfast in preparation for the daily 6:00 a.m. onslaught by the ravenous 'jacks. Little conversation takes place during the meal, as the flunky stands by, replacing empty platters with heap- ing new ones.

Log drive foreman, Charley McCollister, credits this lack of conversation to two factors: the flunky, who's waiting to remove the dishes as soon as the meal is finished, and common courtesy on the part of the 'jacks. "No one asking for something to be passed wants to have to shout over a conversation to be heard," he says. "So they save their talk until they're out of the cookhouse."

With one meal over and the drive crew back on the river, the bull cook washes up the pots, pans and dishes, while Spears and the flunky start on the next.

At this point, if the wanigan is to be moved downriver, Charley McCollister will check with Spears to see if the cookhouse is cleared to go.

Given the go-ahead, McCollister and his assistant drive foreman, Clayton McManus, start up two 35-hp outboards mounted fore and aft on the wanigan and head out into the river's current for a free-float downstream to the next tie-up point. Using the motors only for steering, McCollister and McManus guide the wanigan through the Clearwater's many rapids and eddies. Assisting them are two pike-pole men, who ward off any logs that might damage the motors and also assist in mooring the wanigan.

During the float, it's not unusual for the cook crew to begin preparing the next meal, pausing only for the few minutes it takes the wanigan to pass each series of rapids.

McCollister recalls one flunky who had the habit of grabbing the end of a dining table and bracing himself, head down, eyes closed, and feet spraddled, each time they hit rough water. "One day, just as we reached a good-sized riffle, one of the men grabbed a bucket of water and tossed it over the flunky's head. He never budged an inch," McCollister says, "but for days he bragged about 'the roughest stretch of whitewater' he'd ever seen."

Mooring at a preselected site is an art in itself; as the steering motors are not powerful enough to move the wanigan upstream against the current, and the first attempt has to be the right one.

Lunch is served promptly at 11:20 and dinner at 5:00. By 6:30, the cook crew's work is usually finished for the day; although they might prepare some of the next day's breakfast, just to get the jump on it.

Evenings on the wanigan are spent repairing personal gear and equipment, spinning yarns about past drives, and reading or playing cards. By 9:00 p.m., however, most of the men are in their bunks, storing energy for the next day's battle against the river.

Never lacking in imagination, the crews have, from time to time, devised other means of filling their off-duty hours.

Several years ago, for example, it was considered high sport at the Falls Creek landing for a 'jack to toss a rope over a branch about 20 feet from the ground, place the back of his neck in a wide noose, and haul himself up to the branch by pulling on the other end of the rope. The only problem was, according to McCollister, it took a great deal more coordination to get down, and many a 'jack suffered from rope-burned ears after slipping out of the noose to drop to the ground. To prevent further maiming, McCollister finally ordered the tree cut down. And that didn't really stop them.

He remembers a time when they were tied up at Cherry Lane in the main Clearwater, where the highway runs along the river. "I was driving a pickup down the road," McCollister says, "and up ahead I could see one of the 'jacks doing the old rope trick, dangling from a branch about 15 feet off the ground. That was okay, but there was a fellow in a sedan just ahead of me, and when he saw that 'jack hanging up there, he must have thought we'd lynched him. He jammed on the brakes, and it was all I could do to keep from running him down."

In previous years when the drive ended, the wanigan was dismantled, trucked back upriver, and stored for the next drive. Watching it go, many a 'jack has been heard to say, "You'll never catch me on that S.O.B. again," knowing full-well he'd be there when the Clearwater rose once more.

This year, when this country's last whitewater sawlog drive ends for all time, they'll probably say it again, but with deep regret in the knowledge that this time they mean it. ■

You'll Like Being a SKILLED LOCKSMITH



You'll EARN MORE, LIVE BETTER than Ever Before in Your Life

You'll enjoy your work as a Locksmith because it is more fascinating than a hobby—and highly paid besides! You'll go on enjoying the fascinating work, year after year, in good times or bad because you'll be the man in demand in an evergrowing field offering big pay jobs, big profits as your own boss. What more could you ask!

Train at Home—Earn Extra \$\$\$\$ Right Away!

All this can be yours **FAST** regardless of age, education, minor physical handicaps. Job enjoyment and earnings begin **AT ONCE** as you quickly, easily learn to **CASH IN** on all kinds of locksmithing jobs. All keys, locks, parts, picks, special tools and equipment come with the course at no extra charge. Licensed experts guide you to success.

Illustrated Book, Sample Lesson Pages FREE

Locksmithing Institute graduates now earning, enjoying life more everywhere. You can, too. Coupon brings exciting facts from only school of its kind Lic. by N. J. State Dept. of Ed., Accredited Member, Natl. Home Study Council, VA Approved.

LOCKSMITHING INSTITUTE
Div. of Technical Home Study Schools
Dept. 1118-C71 Little Falls, N. J. 07424

Earned \$150 During Training
I realized with **LOCKSMITHING** I'd be able to double my income. During my training period I made \$150.
Paul Funes
New York, N. Y.



LOCKSMITHING INSTITUTE, Dept. 1118-071
Little Falls, New Jersey 07424 **Est. 1948**

Please send **FREE** illustrated Book—"Your Big Opportunities in Locksmithing," complete Equipment folder and sample lesson pages—**FREE** of all obligation—(no salesman will call).

Name.....
(Please Print)

Address.....

City..... State..... Zip.....

Check here if Eligible for Veteran Training

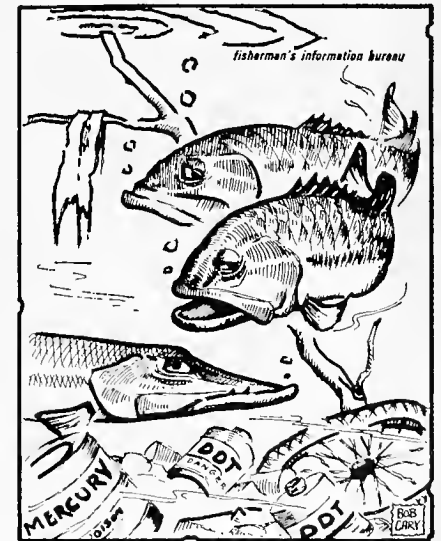

"We're not spawning this year. This is no place to try and raise a family."

The fight against water pollution is now in full swing. Keep our streams clean . . . Don't dump trash; don't use the detergents which kill fish!



IN MEMORIAM

**L.U. NO. 12
SYRACUSE, N.Y.**

Goettel, Gould
Rapp, Lewis

**L.U. NO. 15
HACKENSACK, N.J.**

Markowitz, John

**L.U. NO. 19
DETROIT, MICH.**

Elmer, Frank
Mitchell, Marion
Ridge, Orval C.
Vian, Glen

**L.U. NO. 22
SAN FRANCISCO, CAL.**

Anderson, Helmer
Bart, Robert
Borsi, C. L.
Bouchell, Harry W.
Bullock, H.
Deweese, B. R.
Ellisen, Martin
Erickson, Arne
Fletcher, Frank
Grenno, Angelo M.
Hall, Earl
Hansen, Axel
Herberth, E. H.
Jackson, E. F.
Jester, Paul
Kari, Kalle
Klar, Albert
Kleinwachter, Max C.
Larsen, O.
Lazarett, Fred
Lees, William F.
Lind, Carl E.
Miller, Herbert
Miller, William H.
Platt, Clarence H.
Poli, A.
Powell, R. L.
Ridondelli, P. R.
Schulte, Theodore
Thelman, Fred
Thomsen, Nels
Trautner, Rudolph
Wells, James

**L.U. NO. 36
OAKLAND, CAL.**

Baum, Frank H.
Elze, Fred
Ray, Dave J.

**L.U. NO. 44
CHAMPAIGN-URBANA,
ILL.**

Dickens, Paul E.
Grein, Louis J.
Kuhlman, Elmer
Sinkes, Ernest E.

**L.U. NO. 50
KNOXVILLE, TENN.**

Williams, L. E.

**L.U. NO. 61
KANSAS CITY, MO.**

Bauer, Ferdinand
Becker, Emil A.
Brandes, H. N.
Cates, James R.
Clevenger, Raymond
Davidson, Harold
DeShazer, Elmer F.

Donelson, James T.
Hawkinson, Conrad
Kugler, Henry
Ozburn, Albert
Porter, James M.
Rosenbaum, W. E.
Scott, Alva H.
Vollnogel, Allen A.

**L.U. NO. 62
CHICAGO, ILL.**

Beukinga, Henry
Bohman, Daniel
Carlson, John
Classon, Lloyd
Nies, Joseph
Ulmenstine, George

**L.U. NO. 64
LOUISVILLE, KY.**

Baysinger, Clarence
Childers, Paul
Collins, Walter N.
Jones, Walter
Littrell, Ed
Mason, Warren
Meihous, John
Street, Ernest

**L.U. NO. 100
MUSKEGON, MICH.**

Bogema, Manna
Gilroy, Grant
Herald, George
Johnson, Roland

**L.U. NO. 104
DAYTON, OHIO**

Covey, Nehemiah J.
Fry, Marion C.
Guthrie, James
Hibbs, J. D.
Jones, Harry R.
Kuns, Earl
Neeley, Luther
Spence, John

**L.U. NO. 109
SHEFFIELD, ALA.**

Trousdale, E. A.

**L.U. NO. 129
HAZLETON, PENN.**

Ziegler, Paul

**L.U. NO. 131
SEATTLE, WASH.**

Barnes, William J.
Berg, John
Christensen, E. O.
Christensen, Thorwald
Elken, Carl M.
Flynn, Leo F.
Hendrix, Robert E.
Lastor, Eugene W.
Loewen, Jacob
Nordness, Einar
Peterson, Juneau
Schmitz, E. M.
Shelman, John E.
Wilson, Roy G.
Wolfe, W. R.

**L.U. NO. 132
WASHINGTON, D.C.**

Hollidge, Albert L.
McKay, John W.
Sacchet, Peter
Swab, William K.

**L.U. NO. 133
TERRE HAUTE, IND.**

Harper, James H.
Mullen, Mack
Storm, George M.

**L.U. NO. 146
SCHENECTADY, N.Y.**

Brown, Harwood
Fagle, Chris
Malony, James
Nielsen, Chris
Stanton, Charles
Vedder, George

**L.U. NO. 180
VALLEJO, CAL.**

Boyd, M. V.
Jones, Dennis B.
Lambrecht, Emil

**L.U. NO. 181
CHICAGO, ILL.**

Andracki, Edward
Kwiatkowski, Alex

**L.U. NO. 182
CLEVELAND, OHIO**

Bisch, Philip
Dech, Fred
Fieldhouse, Ronald
Jackson, Thomas
Hauth, Robert
Krieger, Peter, Jr.
Krueger, Carl
Lackner, Joseph
Schermer, George
Sweeney, Frank
Tjarks, Alvin
Wendt, Henry
Zenk, Adam

**L.U. NO. 198
DALLAS, TEX.**

Barnwell, J. D.
Bartel, A. A.
Beaver, J. M.
Conner, Charles L., Jr.
Davis, Daniel W.
Donaldson, Julius J.
Hines, B. P.
Hubbard, T. B.
Janousek, A. M.
Patton, Joe
Roberts, John J.
Shanz, W. R.
Still, W. O.
Thompson, Lyles S.
Townley, Ira A.
Townley, L. C.
Turner, V. A., Sr.
Warren, G. B.

**L.U. NO. 201
WICHITA, KAN.**

Mellies, Robert I.

**L.U. NO. 213
HOUSTON, TEX.**

Burrus, O. L.
Menefee, Wallace E.
Pledger, H. N.
Powell, C. P.
Spears, Thomas L.

**L.U. NO. 226
PORTLAND, OREG.**

Bartel, R. E.

Christensen, A. C.
Gardner, Robert L.

**L.U. NO. 257
NEW YORK, N.Y.**

Hagelin, Fred
Kostyal, Frank
Leitner, Michael
Schuere, Werner
Wasserman, Sam

**L.U. NO. 283
AUGUSTA, GA.**

Meckes, Earl J.
Prescott, Broadus D.

**L.U. NO. 298
NEW YORK, N.Y.**

Dubors, John A., Jr.
Sadowski, Anthony
Schneider, Henry
Vondrasek, Josef
Weiler, Fred

**L.U. NO. 301
NEWBURGH, N.Y.**

Tapley, Lloyd A.

**L.U. NO. 304
DENISON, TEX.**

French, C. A.
Jones, Roy

**L.U. NO. 325
PATERSON, N.J.**

Stein, Alex

**L.U. NO. 341
CHICAGO, ILL.**

Chenko, Vladimar
Glitman, Jack
Hetlinger, John
Knaga, Joseph
Lobadzinski, William
Novak, Max
Sasak, Philip

**L.U. NO. 343
WINNIPEG, MANI.**

Bates, George S.
Burdzy, Kazimer
Chambers, Frank H.
Diachek, William
Graham, James B.
Lucko, Mike
Pedersen, Jens
Schultz, George
Walker, Hollis
Westberg, H. R.

**L.U. NO. 344
WAUKESHA, WISC.**

Spellman, N. C.

**L.U. NO. 361
DULUTH, MINN.**

Bakke, Ragnar
Hansen, Henry
Stark, Joseph F.
Thobison, Christ
Whitney, Ellis E.
Wutz, Joseph

**L.U. NO. 366
NEW YORK, N.Y.**

Cioffi, Ralph
Rosen, Gershon

**L.U. NO. 393
CAMDEN, N.J.**

Anderson, Howard S.

Blackburn, Edward W.
Boch, George
Crosby, Emmet
Foust, William
Hall, Donald
Hanson, Robert
Perry, Frank
Pierson, Daniel K.
Rib, Alexander
Stewart, William R.
Westerberg, Albert
Wright, Frank

**L.U. NO. 507
NASHVILLE, TENN.**

Belt, Walter, Sr.
Binkley, Eddie
Blackwell, Arthur R.
Clardy, Alvis
Cravens, Allen E.
Duer, Claud
Joyner, Emmett
Pack, William H.
Stephens, Samuel F.
Sweatt, Albert J.
Sweeney, Joseph E.
Wiser, Thomas B.

**L.U. NO. 531
ST. PETERSBURG, FLA.**

Dewald, Joseph
Strawn, Joseph

**L.U. NO. 533
JEFFERSONVILLE, IND.**

Castetter, Harry E.
Gilchrist, Virgil J.

**L.U. NO. 558
ELMHURST, ILL.**

Arniel, Mark
Malmberg, A. G.
Wagner, Quillar I.

**L.U. NO. 562
EVERETT, WASH.**

Berg, Clarence
Gaswint, George
Verlinde, Ernest E.

**L.U. NO. 620
MADISON, N.J.**

Korkes, Joseph D.

**L.U. NO. 639
AKRON, OHIO**

Beaver, Howard
Blair, George D.
Butcher, L. H.
Crissinger, B. R.
Hoylman, Elliott
Poux, Melcourt
Rayburn, Otto G.
Slack, Francis E.
Sliger, R. E.
Smith, Ralph
Spaugy, Paul
Wickline, Harry
Williams, F. A.

**L.U. NO. 661
OTTAWA, ILL.**

Locke, Benjamin
Struel, William F.
Walling, Gerald C.

**L.U. NO. 751
SANTA ROSA, CAL.**

Meyer, Les

L.U. NO. 770
YAKIMA, WASH.
Jundt, Adam

L.U. NO. 787
NEW YORK, N.Y.
Canticalli, Antone
Merikosky, Ossi

L.U. NO. 844
RESEDA, CAL.
Beard, Dan
Bennett, Lewis
Berg, Bror
Berggren, Otto N.
Coats, Jack C.
Collins, Grant
Hartley, Roy F.
Jobbe, John F.
Kyle, Joseph
McKinnon, Dan T.
Moad, Gerald G.
Owens, Ira T.
Sahlin, Elof
Starr, Patrick
Stoneking, Clint
Szabo, Joseph
Townsend, George
Vaughan, Albert C.
Wood, Jack P.
Word, James W.

L.U. NO. 848
SAN BRUNO, CAL.
Dittner, Albert
Ragan, Fred

L.U. NO. 871
BATTLE CREEK, MICH.
Morgan, B. O.

L.U. NO. 916
AURORA, ILL.
Mead, Robert
Moser, William

L.U. NO. 971
RENO, NEV.
Maryland, Edward

L.U. NO. 982
DETROIT, MICH.
Gitzel, Emil
Kelm, Ivory

L.U. NO. 1031
DOVER, N.H.
Wiggin, Perley E.

L.U. NO. 1093
GLENCOVE, N.Y.
Donaldson, Adam
Marrone, Joseph

L.U. NO. 1128
LA GRANGE, ILL.
Goodsell, Lawton H.
Lord, David F.

L.U. NO. 1149
SAN FRANCISCO, CAL.
Alexander, Edgar
Basford, Garth X.
Boyer, Richard J.
Fouch, Harry A.
Green, Norman L.
Harris, Clifford H.
Pasquinucci, Joseph
Scotness, Julius
Whitcher, George P.

L.U. NO. 1160
PITTSBURGH, PA.
Alberts, Paul
Stevens, Edward A.

L.U. NO. 1162
COLLEGE POINT, L.I., N.Y.
Patelli, Peter

L.U. NO. 1185
CHICAGO, ILL.
Bauer, Julian J.

L.U. NO. 1243
FAIRBANKS, ALAS.
Meek, Richard L.

L.U. NO. 1265
MONMOUTH, ILL.
Ahlstrand, Axel F.

L.U. NO. 1274
DECATUR, ALA.
Armor, A. M.
Shirley, James E.

L.U. NO. 1363
OSHKOSH, WIS.
Houston, Roy O.

L.U. NO. 1382
ROCHESTER, MINN.
Renaux, Milton

L.U. NO. 1397
N. HEMPSTEAD, N.Y.
Zotto, William E.

L.U. NO. 1471
JACKSON, MISS.
Caughman, W. P.
Coleman, Roy L.
Collum, Lavon
Davis, T. J.
Demars, Octave J.
Fesackerly, George M.
Fountain, Delma M.
Kiser, Willie M.
McBride, L. J.
Murphy, L. J.
Musgrove, W. W.
Pigg, Woodrow V.
Smith, Luther E.
Terry, Joseph F.
Wilkinson, William H.

L.U. NO. 1598
VICTORIA, B.C.
Rayment, Percy

L.U. NO. 1609
HIBBING, MINN.
Erickson, Leonard

L.U. NO. 1654
MIDLAND, MICH.
Weinert, John C.

L.U. NO. 1667
BILOXI, MISS.
Dismuke, Frank
Smith, Bond J.

L.U. NO. 1693
CHICAGO, ILL.
Cameron, Duncan
Cleinmark, Henry
Cosgrove, William
Hobday, Charles
Hockinson, Oscar
Mayhall, Gene
Sheridan, William
Sleider, Adolph
Tomis, Paul

L.U. NO. 1699
PASCO, WASH.
Ferrin, Lyle

L.U. NO. 1764
MARION, VA.
Adams, Blair
Aker, Wayman
Pennington, David
Pierce, Glen
Poe, Camet
Richardson, Thomas M.
Russell, William O.
Scott, Kyle
Sherwood, Arthur
Shuler, Stuart
Testerman, Baker L.
Tilson, James M.

L.U. NO. 1784
CHICAGO, ILL.
Palueska, Martin

L.U. NO. 1793
MILFORD, ILL.
Hupens, Bernard

L.U. NO. 1846
NEW ORLEANS, LA.
LaFontaine, Eugene
Legendre, Richard A.
Lopiparo, August
Munn, Arthur
Poolson, John D.
Schexnaydre, Nolan

L.U. NO. 1963
TORONTO, ONT.
Gutauskas, Walter
Kalliomaki, Eino
Prevedel, Ettore

L.U. NO. 2114
NAPA, CAL.
Butler, Guy

L.U. NO. 2143
UKIAH, CAL.
Burnett, Ray

L.U. NO. 2274
PITTSBURGH, PA.
Henretta, Hugh
Kopchik, Joseph

L.U. NO. 2311
WASHINGTON, D.C.
Felts, Lewis W.

L.U. NO. 2794
MATTOON, WIS.
Bossell, Alfred
Crisclone, Sam
Jahnke, Henry
Slater, Valentine
Stark, Raymond

L.U. NO. 3268
HAWKESBURY, N.S.
Stone, Leo H.

Breakthrough

Continued from page 9

sign, high quality, good living configuration, and more effectively controlled costs.

In the area of health and safety, the BREAKTHROUGH criteria were designed to produce levels of performance at least as good as those obtained under the present codes. In addition, "targets of opportunity" were incorporated; for example, the BREAKTHROUGH criteria call for more smoke detectors than do most building codes. Because they are aimed at housing that is not only safe but of improved quality, the BREAKTHROUGH criteria are quite broad, ranging into areas of liveability and durability. This need to go beyond the concerns of the codes stems from the nature of some of the housing systems; innovations that have not withstood the test of time or the natural selection processes of the marketplace necessitate criteria offering as-

urance of certain measures of liveability and durability.

The criteria for BREAKTHROUGH housing were designed and developed by a team of NBS building research experts. The team in only two months time produced the first of four volumes of guide criteria. The team also provided HUD with climatological and regulatory (codes, etc.) data pertaining to the sites for housing. In July, Secretaries George Romney and Maurice H. Stans signed a HUD/Department of Commerce interdepartmental agreement authorizing use of the technological resources of the Bureau in broad HUD programs dealing with housing.

The 22 housing system producers for BREAKTHROUGH will construct prototype housing at nine sites—representative of every sector of the country. The nine sites are located in Indianapolis; Jersey City; Kalamazoo; Macon, Georgia; Memphis; Sacramento; St. Louis; Seattle; and King County, Washington. ■

Press Management On Alcoholism, Unions Are Urged

Carry the ball to management, if they are reluctant to start a program to help alcoholics, advises Ray Andrus.

Andrus, on the staff of the national AFL-CIO Community Services, was a member of a panel which discussed joint labor-management understanding on alcoholism at the recent seminar on human needs.

Statistics indicate that five percent of the U.S. population will be alcoholics eventually, he said. With 18 million union members in the U.S., this means that more than 900,000 of these members will be alcoholics. "This is why we encourage labor to take the initiative on this problem," he explained.

"Organize to protect your people—see that management shares the responsibility." (PAI)

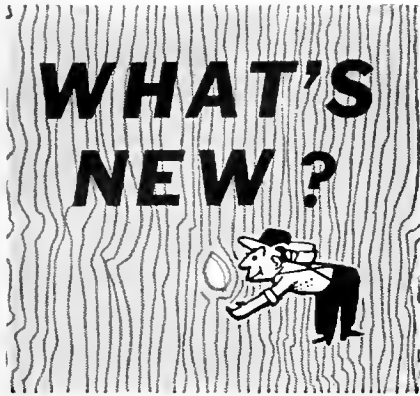

HYDRAULIC LIFT



Variable level access for maintenance and stocking work can now be quickly and efficiently handled by a new twin-platform hydraulic lift recently introduced by the Ballymore Company. The new twin-platform lift includes a platform that serves the lift's operator and a sturdy material platform positioned top and forward of the operator's platform. The second platform easily accommodates large maintenance tools and materials to be moved to and from overhead stock bins.

In a fully-lowered position, the operator's platform is 3' above the floor—the tool/stock platform 6'4" high. A platform-located power control for the lift's electric drive system is used by the operator to raise the lift as much as 8', thus providing variable level platform heights up to 14'4" on the upper platform. When fully lowered, the lift is easily stored in small areas. For ready mobility, the unit is mounted on two fixed-position and two swivel-type, locking casters. Combined lifting and holding capacities of the lift are 800 lbs.—300 lbs. on the lower platform and 500 on the tool/stock platform.

Complete information on the new twin-platform lift is available from the manufacturer, Ballymore Company, West Chester, Pa. 19380.

DOOR SHIMMING DEVICE

Timber Engineering Company has announced the introduction of a new product designed for use with pre-hung solid jamb doors. Called the "TECO Shim", the device replaces conventional methods of shimming doors prior to nailing them into position.

Conventional methods of shimming doors call for the use of scrap pieces of wood or shingles found on the job site. Use of such materials is not always satisfactory because it is difficult to control accuracy. In addition, it is frequently not possible to find suitable scrap material for shimming. According to Timber Engineering Company, the "TECO Shim" not only facilitates the installation of the door but it provides a firm support once the door unit is placed in its opening.

Manufactured from 18 gauge galvanized steel, the "TECO Shim" features a positioning tab that fits on the jamb and holds the door unit in place during the squaring operation. Once the door unit has been squared, the "Shim" is secured to the stud or header by nailing a 6d nail through a hole provided in a stud tab. While the shim still holds the jamb in position, the door unit is secured by nailing a 10d finishing nail through the jamb and into the stud. The positioning tab, called the "bend-off tab", is then removed by bending it along score lines. When the casing is applied, the "Shim" is completely hidden from view.

An average installation will call for four "TECO Shims" along each side of the door jamb and one at the top. This means an average of 9 per door would be required to complete a normal installation.

For more information on "TECO Shims", write Timber Engineering Company, 5530 Wisconsin Avenue, Washington, D.C. 20015.

PORTABLE HEATER

"Infra Ready," a new line of portable infra-red heaters operating on LP gas solves industrial, commercial, and recreational heating problems, indoors or outdoors, with high intensity directional heat.

Four lifetime ceramic generators with over 4,000 burner ports give instant, glowing heat rated at 30,000 BTU/HR in a stainless or aluminized steel, wind resistant burner with a safety grille.

The unit, mounted on a free standing portable cart, is 48 inches high and includes a low pressure 11-inch W. C. regulator. Weight is 20 pounds without tank. A 100 percent safety control is optional equipment.

For additional information and nearest dealer, write Infrared Dynamics, 2112 W. Commonwealth Avenue, Alhambra, California 91802.



NOISE, HEAT WALL DATA

Sound conditioning for outside walls, plus bracing and thermal insulation, with insulation board sheathing are described in an illustrated eight-page brochure. Compares heat resistance factor (R-value) for typical sheathing materials. Also, how to apply for single or multi-family units. Free. Write: Acoustical and Insulating Materials Assn., 205 W. Touhy Ave., Park Ridge, Ill. 60068.

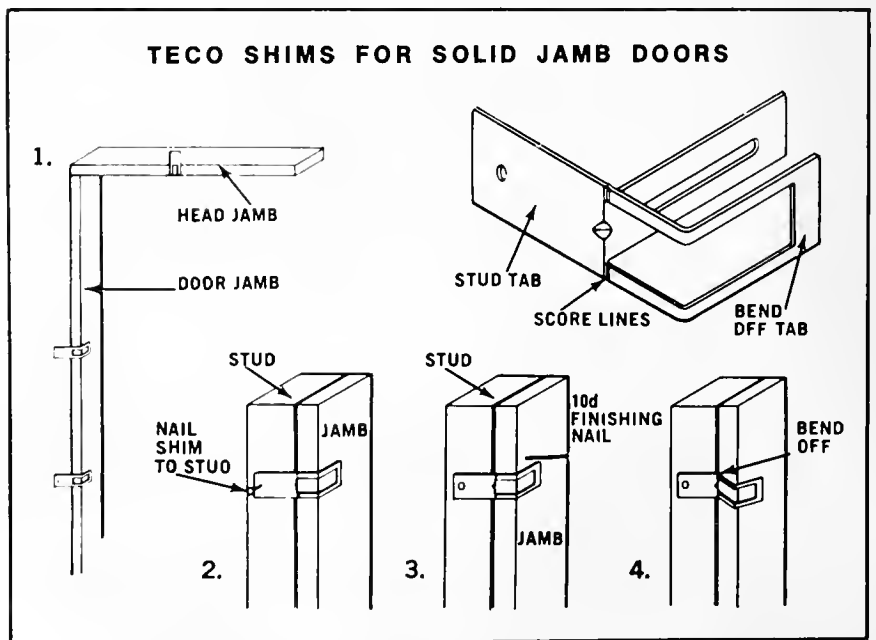



Lakeland News

Items of interest from the Brotherhood's retirement home at Lakeland, Florida

M. Pierre Champlin, Sr., of Local 251, Kingston, N.Y., arrived at the Home May 3, 1971.

Jesse M. Kuykendall, of Local 2523, Memphis, Tenn., arrived at the Home May 10, 1971.

Harry S. Meckley, of Local 1441, Cannonsburg, Pa., died May 2, 1971. He was buried in Halifax Cemetery, Dauphin County, Pa.

Jesse M. Kuykendall, of Local 2523, Memphis, Tenn., died May 14, 1971. Burial was in Memphis.

R. Wilson Ranson, of Local 993, Miami, Fla., died May 16, 1971. His body was cremated and his ashes were sent to St. Augustine, Fla., for burial.

Wm. A. Boehmer, of Local 62, Chicago, Ill., died May 22, 1971. He was buried in the Home Cemetery.

August Spei of Local 105, Cleveland, Ohio, died May 26, 1971. He was buried in the Home Cemetery.

John Ziebur, of Local 277, Philadelphia, Pa., died May 28, 1971. He was buried in the Home Cemetery.

Wm. J. Cunningham, of Local 185, St. Louis, Mo., died May 30, 1971. Burial was in Lemay, Mo.

Earl Martin, of Local 104, Dayton, Ohio, withdrew from the Home, May 20, 1971.

ANGLE-READING LEVEL

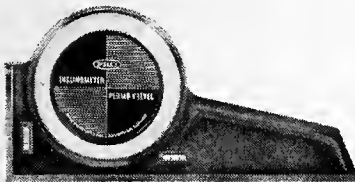

A new #1300 Series level for tradesmen and craftsmen with a novel built-in feature for measuring angles has been introduced.

INDEX OF ADVERTISERS

Audel, Theodore	39
Chevrolet	17
Chicago Technical College	21
Craftsman Book Co.	25
Estwing Manufacturing	23
Foley Manufacturing	33
Hydrolevel	29
Irwin Auger Bit Co.	29
Lee, H. D.	25
Locksmithing Institute	35
North American School of Drafting	28
North American School of Surveying	39
Paneling Specialties	28
Rockwell Manufacturing	19
Skil	31
Stanley Works	Back Cover

This level is an improved departure from the conventional cumbersome wood or extrusion levels now in common use. It offers ease of handling, storage, durability and compactness. Horizontal and vertical leveling and plumbing vials are permanently mounted on the aluminum cast frame that can be used as a square as well as a level.

The plus features of this level include a 4" diameter dial that provides instant error free direct reading of any angle from 0° to 90° in any quadrant with accuracy of 1/2° of 1°; thus saving time and eliminating errors in computing angles.

A handy angle conversion chart is permanently attached on the back of the angle reading dial for easy computation or selection of angles in pitch per inch or pitch per foot.

The cast aluminum level only weighs one (1) lb. and is a very practical, useful "easy to grip" instrument, machined on the vertical and horizontal square surfaces with "V" grooves for ease of checking round, as well as flat, surfaces. The physical size is 4 3/4" x 10" x 1" thick and the angle reading face is protected with a "glass clear" acrylic plastic cover.

The instrument is finished in durable black wrinkle paint and individually packed in a handy leather covered container. Retail: \$18.95. For information write: Pro Products Company, Inc., of 812 22nd Street, Rockford, Illinois.

AUDEL CARPENTERS & BUILDERS LIBRARY

4 vols.
\$18.50



THESE "PAPER TOOLS" can boost your income!

Their 1,488 pages of practical information and how-to guidance are invaluable "tools" for all in the building trades . . . a complete course for the apprentice, a ready reference for master workers.

Thousands of photos, diagrams and charts tell and show short cuts, new methods, solutions and money-saving ideas . . . how to use every tool and building aid . . . how to build everything from furniture to houses . . . how to frame, roof, excavate, do carpenter arithmetic, estimate costs, trim, insulate, care for tools, etc. They can help you earn more, fast.

MONEY BACK GUARANTEE—You must be completely satisfied with the Audel Guides you order, or you may return them within 10 days and get your money back.

SEND COUPON TODAY

Theodore Audel & Co., 4300 West 62nd St. C-071
Indianapolis, Indiana 46268

Please mail me Carpenters and Builders Library, 4 vols. I agree to mail \$3 in 10 days and to mail 1/2 the total purchase price 30 days later, with the balance plus shipping costs to be mailed within another 30 days. If I am not completely satisfied I may return the books for refund.

Name _____

Address _____

City _____ State _____ Zip _____

Save shipping costs. Enclose \$18.50 (plus sales tax, if any) and we pay postage.

LEARN SURVEYING AT HOME!

APPROVED VETERANS

PUT YOURSELF ON THIS HIGH PAY SURVEYING TEAM

Prepare now at home for a rewarding Career in Surveying. Excitement! Fun! Prestige! Imagine yourself as part of a Surveying Team — in on planning of highways, bridges, dams, airfields, subdivisions, etc. Wonderful Outdoor Career . . . ideal for men who like to work with their hands.

We'll Give You This Famous 2X SURVEYOR'S TRANSIT when you train with us for a HIGH PAY CAREER IN SURVEYING!

... lets you make Surveying measurements the way professionals do! PLUS 3 Big Surveying Kits you use during training . . . you keep throughout your Surveying Career. You need no previous experience, no technical ability. North American has trained 1000s to step into good pay positions in every State. Many students report good earnings part time while still learning. Thousands who are Surveyors today get their training through home-study. You can too!

Rush Coupon for FREE 'Surveying Career Kit' . . . including 20-Page Book, Sample Lesson and Self-Scoring Aptitude Quiz. No cost or obligation. Rush coupon today.

NORTH AMERICAN SCHOOL OF SURVEYING Dept. 11467
4500 Campus Drive • Newport, Calif. 92660
Rush "SURVEYING CAREER KIT" including Book, Sample Lesson & Aptitude Test — ALL FREE!

Name _____ Age _____

Address _____

City _____ State _____ Zip _____



In Conclusion

M. A. Hutcheson, *General President*



Clear Cutting and the Super-Conservationists

■ There seems to be building up in this country a concerted program aimed at crippling or perhaps even eliminating the forest industry.

On the one hand, the super-conservationists are determined that not one more tree should be cut. They ignore the fact that trees are living things. They get old and die. They are subject to attack by insects and diseases. Wind storms often blow them down.

However, the pure conservationist thinks it a crime against humanity that trees should be put to use building homes, schools, churches and all sorts of structures that add to man's comfort and happiness. If they get their way, our forests will be reserved for the exclusive recreational uses of the small percentage of people wealthy enough to be able to visit our forest areas.

The worker in the Bronx, or Chicago's Southside, or in an Omaha packing plant, seldom has a ghost of a chance of ever visiting a forest.

In league with the super-conservationists are the super-planners who equate home construction with the mass production of automobiles in Detroit. These eggheads who never drove a nail and perhaps never even visited a construction site know all about super-efficient building. They visualize molded houses turned out like pretzels. Wood, they say, is outmoded as a building material.

Many of them can be found in high places in HUD. Joining hands with these groups are some Senators and Congressmen who have been taken in by the slick propaganda of the groups mentioned above.

As a case in point, Senator Gale McGee of Wyoming has introduced a bill to place a moratorium on clear cutting; that is, cutting all the trees in a particular tract.

Now, clear cutting is not a particularly attractive way of harvesting timber. On the other hand, it is the best way in certain instances. Some very desirable species of trees including Douglas fir, must have plenty of sunshine to allow seedlings to get a healthy start. If clear cutting is done in a

properly supervised manner, so that sufficient seed trees are left in strategic spots, it is not the detriment to reforestation that the super-conservationists claim it to be.

If a moratorium is declared on all clear cutting, a substantial percentage of the West Coast lumber industry will be seriously handicapped. In addition, the supply of lumber will be seriously curtailed, with the result that prices will climb and the housing program will be adversely affected.

The Forest Service estimates that enactment of the moratorium would reduce national forest timber harvests from 11.5 billion board feet a year to 4 billion. Naturally this means a death sentence to the jobs of many mill workers all over the country, with the result that many communities depending on such forest industry will suffer greatly.

Clear cutting is a useful tool in some instances, and a good deal of study ought to be given to the subject before any serious legislation is considered.

Furthermore, I think that those who are sincerely concerned in protecting the environment should take a long, hard look at the factors involved in using wood in construction as opposed to the use of metals and plastics.

Metals come from ores. Ores are mined with heavy equipment which burns fossil fuels. Fossil fuels are directly or indirectly involved in smelting ore into a useful metal. Plastics, too, require great amounts of heat and energy which mostly come from the burning of fossil fuels. The amount of pollution created thereby is staggering. Anyone traveling through the parts of the country producing metals or plastics can see the visible proof of this fact.

Most important of all, once the ore is taken out of the earth, it is gone forever. On the other hand, a tree that is harvested is eventually replaced by another one.

I admit a clear cut area is not very beautiful, but neither is a mountainside gutted by strip mining for coal. The difference is the clear cut land regenerates itself in a short while. The strip mined area remains an eyesore for generations, if not forever. ■

WHO WILL WIN THESE TROPHIES?

The International Carpenters Apprenticeship Contest in Detroit, Michigan, August 12, 13, 14 will provide the answers.

Champions from 37 states and 4 provinces will be vying for these beautiful trophies in the three categories—carpentry, millwright, and mill-cabinet.

Here's a chance to see craftsmanship in the making. If you're in or around Detroit during these days in August, visit the contest. The location: Cobo Hall, Detroit, Michigan.



MILLWRIGHT



MILL-CABINET



CARPENTER

What makes the Stanley Steelmaster your kind of hammer?



The face is rim-tempered, for a safer hammer. Rim-tempering minimizes chipping in case of a foul blow. That's on-the-job safety.

Handle is hydraulically driven into the handle hole under 10,000 lbs. force. Permanently locked head and handle can't twist or loosen.

Notice the clean, sharp edges on the claw. This makes it easier to grip the shank of any nail and pull it, without effort, from the toughest wood.

Finally, it's a perfectly balanced hammer. Set it on its claws and notice the exact 45° angle. Perfect.



Don't settle for anything less than the best, time-tested tools. Stanley has been known for excellence in hand tools for over a century. Buy the tool that makes a difference. Stanley Tools, Division of The Stanley Works, New Britain, Connecticut 06050.

STANLEY
helps you do things right

P.S. Made by the same Stanley that makes the finest power tools.

The **CARPENTER**

AUGUST 1971

Official Publication of the UNITED BROTHERHOOD OF CARPENTERS AND JOINERS OF AMERICA • FOUNDED 1831



90th ANNIVERSARY
OF THE UNION

OFFICIAL INFORMATION



GENERAL OFFICERS OF THE UNITED BROTHERHOOD of CARPENTERS & JOINERS of AMERICA

GENERAL OFFICE:
101 Constitution Ave., N.W.,
Washington, D. C. 20001

GENERAL PRESIDENT

M. A. HUTCHESON
101 Constitution Ave., N.W.,
Washington, D. C. 20001

FIRST GENERAL VICE PRESIDENT

WILLIAM SIDELL
101 Constitution Ave., N.W.,
Washington, D. C. 20001

SECOND GENERAL VICE PRESIDENT

HERBERT C. SKINNER
101 Constitution Ave., N.W.,
Washington, D. C. 20001

GENERAL SECRETARY

R. E. LIVINGSTON
101 Constitution Ave., N.W.,
Washington, D. C. 20001

GENERAL TREASURER

PETER TERZICK
101 Constitution Ave., N.W.,
Washington, D. C. 20001

DISTRICT BOARD MEMBERS

First District, PATRICK J. CAMPBELL
130 North Main Street
New City, Rockland Co., New York
10956

Second District, RALEIGH RAJOPPI
2 Prospect Place, Springfield, New Jersey
07081

Third District, WILLIAM KONYHA
1830 Ledge Rd., R.D. No. 4
Medina, Ohio 44256

Fourth District, HAROLD E. LEWIS
340 Northwest 148th St.
Miami, Florida 33168

Fifth District, LEON W. GREENE
2800 Selkirk Drive
Burnsville, Minn. 55378

Sixth District, FREDERICK N. BULL
P.O. Box 14279
Oklahoma City, Okla. 73114

Seventh District, LYLE J. HILLER
Room 722, Oregon Nat'l Bldg.
610 S.W. Alder Street
Portland, Oregon 97205

Eighth District, CHARLES E. NICHOLS
Forum Building, 9th and K Streets
Sacramento, California 95814

Ninth District, WILLIAM STEFANOVITCH
2418 Central Avenue
Windsor, Ontario, Canada

Tenth District, GEORGE BENGOUGH
2528 E. 8th Ave., Vancouver 12, B. C.

M. A. HUTCHESON, *Chairman*
R. E. LIVINGSTON, *Secretary*

Correspondence for the General Executive Board
should be sent to the General Secretary.



Secretaries, Please Note

If your local union wishes to list deceased members in the "In Memoriam" page of *The Carpenter*, it is necessary that a specific request be directed to the editor.

In processing complaints, the only names which the financial secretary needs to send in are the names of members who are NOT receiving the magazine. In sending in the names of members who are not getting the magazine, the new address forms mailed out with each monthly bill should be used. Please see that the Zip Code of the member is included. When a member clears out of one Local Union into another, his name is automatically dropped from the mail list of the Local Union he cleared out of. Therefore, the secretary of the Union into which he cleared should forward his name to the General Secretary for inclusion on the mail list. Do not forget the Zip Code number. Members who die or are suspended are automatically dropped from the mailing list of *The Carpenter*.

PLEASE KEEP *THE CARPENTER* ADVISED OF YOUR CHANGE OF ADDRESS

PLEASE NOTE: Filling out this coupon and mailing it to the *CARPENTER* only corrects your mailing address for the magazine. It does not advise your own local union of your address change. You must notify your local union by some other method.

This coupon should be mailed to *THE CARPENTER*,
101 Constitution Ave., N.W., Washington, D. C. 20001

NAME _____ Local No. _____

Number of your Local Union must be given. Otherwise, no action can be taken on your change of address.

NEW ADDRESS _____

City

State

ZIP Code



THE CARPENTER

VOLUME XCI

No. 8

AUGUST, 1971

UNITED BROTHERHOOD OF CARPENTERS AND JOINERS OF AMERICA

Peter Terzick, Editor

IN THIS ISSUE

NEWS AND FEATURES

Our 90th Anniversary	2
World's Largest Airport Rises on North Texas Plain	4
Jobs, Jobs, Jobs	9
Apprentices Build Their Own School	12
Collective Bargaining Seminar	19

DEPARTMENTS

Washington Roundup	8
Service to the Brotherhood	14, 17, 18
Canadian Report	Morden Lazarus 15
Local Union News	23
We Congratulate	27
Apprenticeship and Training	28
Your Union Dictionary	32
Plane Gossip	33
Outdoor Meanderings	Fred Goetz 34
CLIC Report	36
In Memoriam	37
Lakeland News	39
In Conclusion	M. A. Hutcheson 40

THE COVER

On August 12, 1881, 36 delegates from 14 local unions convened in Chicago, Illinois, and founded the United Brotherhood of Carpenters and Joiners of America. In that period of \$2-a-day wages, ten-hour work days, and six-day work weeks, the premise upon which they based their creation of a union was a simple one: "In the present age, there is no hope for workmen outside of organization."

As our August cover demonstrates, America has grown at a fantastic pace since 1881. It has progressed from the age of the big-funnel steam locomotive to the age of the giant airliner, from an age of limited dreams to an age of unbridled possibility.

Accompanying America in every step of this growth has been the United Brotherhood of Carpenters and Joiners of America. As were our forebears of 1881, and as is further indicated by our August cover, we are creators. Taking the raw materials of America's plans for progress and expansion, we convert the dream into the reality. Our role has been an important one in the past and is an even more important one today. At a time when so many individuals in America appear to have dedicated themselves to the task of destruction, we must dedicate ourselves to the responsibility of building. In assuming this responsibility, our hope for increased strength and unity in the future will be realized.

POSTMASTERS, ATTENTION: Change of address cards on Form 3579 should be sent to THE CARPENTER, Carpenters' Building, 101 Constitution Ave., N.W., Washington, D. C. 20001

Published monthly at 810 Rhode Island Ave., N.E., Washington, D. C. 20018, by the United Brotherhood of Carpenters and Joiners of America. Second class postage paid at Washington, D. C. Subscription price: United States and Canada \$2 per year, single copies 20¢ in advance.



Printed in U. S. A.

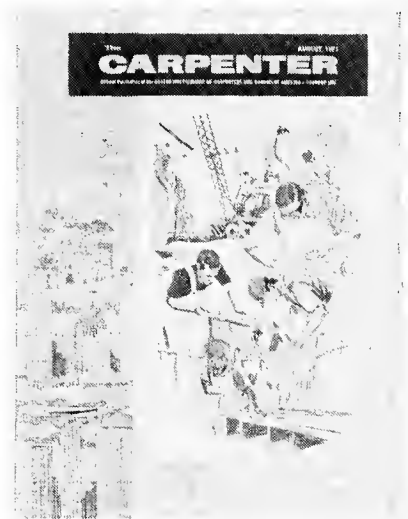



Our 90th Anniversary

“If the Strong Combine, Why Should Not the Weak?” - Peter McGuire

■ In referring to the British airmen who fought the Luftwaffe in the Battle for Britain. Winston Churchill made his now-famous comment: “Never in the field of human conflict was so much owed by so many to so few.”

Perhaps a similar comment can be made in reference to the humble beginnings of the United Brotherhood of Carpenters and Joiners of America and to the subsequent effect which the Brotherhood has had on the struggle of the working man to achieve just treatment.

On August 8, 1881—90 years ago, this month—36 delegates from 14 local unions in 11 cities convened at Trades Assembly Hall in Chicago, Illinois. They met for only a short time. However, out of their deliberations came the decision to establish an international organization of workers in the carpentry craft.

Initially, the United Brotherhood of Carpenters and Joiners of America was conceived out of concern—a very ardent concern for the individual working man, imprisoned in the traditional stronghold of the powerful employer. Today, as in the period of the Brotherhood’s infancy, *concern* is still the driving force behind our Union’s continued growth. Indeed, its strong position could not have developed through an indifferent membership. The Brotherhood has grown through struggle, persistence, patience, and courage. As Peter McGuire, founder of the Brotherhood, had envisioned in 1881, the weak have combined and have become the strong.

In its early years, the Brotherhood concentrated upon the upholding and advancement of wages—not so much to lessen the toil as to spread the work among more mem-

bers. However, at the 1884 convention of the Federation of Organized Trades and Labor Unions (soon to become the AFL). General President of the Carpenters Union Gabriel Edmonston proposed the eight-hour day as labor’s new target.

The only organization to make a determined effort at that time in the eight-hour battle was the Brotherhood of Carpenters. Considering the Federation as a whole, the battle was not a success. However, due to the singular efforts of the Carpenters union, the principle of the eight-hour day emerged as a rallying point for all labor. By 1890, more than 23,000 carpenters in 36 cities gained the eight-hour day, and some 32,000 more in 234 cities gained the nine-hour day.

Between the start of the century and William Hutcheson’s elevation to the Brotherhood presidency in 1915, the Carpenters had grown spectacularly in numerical strength: from 679 locals with 69,000 members to 2,015 locals with 261,000 members. However, these gains had been counter-balanced by other circumstances. The labor supply was running ahead of demand. The growth of corporations and the concentration of economic power had weakened the bargaining position of the labor unions. In many cases, bargaining was impossible.

It was rapidly becoming apparent that the Brotherhood was in need of increased authority. Accordingly, the 1916 convention enacted constitutional changes granting this increased authority to the principal officers and the General Executive Board. Their position was that a union, like an army, can attain its objectives only by achieving disci-

pline within its own ranks.

Upon entering World War I, the nation faced production requirements such as it had never known. Again, the Brotherhood rose to the challenge, yielding to none in eagerness to help the war effort.

President Hutcheson was mindful of the favorable situation that had developed: the demand for labor was fast running ahead of the supply. Here was a major opportunity to organize the unorganized and extend the union shop. Doing so, Hutcheson emphasized, would *help* the war effort. Nevertheless, he was subjected to vicious attack, and accused of impeding the war effort. The idea seemed to be that it was “patriotic” for employers to gorge themselves with profits, but *unpatriotic* for labor to ask for justice.

Early in 1918, the government called a conference of management and labor leaders to develop workable principles for the handling of industrial disputes. President Hutcheson played a major role in the development of a plan for a National War Labor Board for mediation and arbitration of labor disputes, and was commended by President Wilson for his dedicated effort. For the first time, government had a clear-cut labor policy. Order replaced confusion, and labor assumed an equal place in its dealings with management.

After World War I, the big industrial firms were loaded with war profits. They wanted to get rid of the collective bargaining processes which the National War Labor Board had bolstered. The weapon they hit upon was the so-called “American Plan” based on the argument that every law-abiding American has the “right to work” when

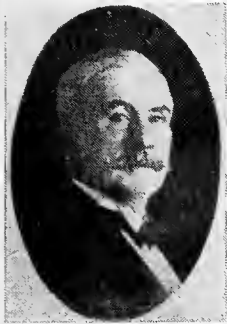

GABRIEL EDMONSTON

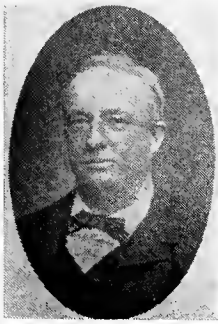

PETER MCGUIRE

and where he pleases without "interference."

The drive was waged with particular vigor against the building trades, and once again, the leadership in labor's long plight was provided by the United Brotherhood. Perceiving that the American Plan had as its real goal the destruction of the labor movement, the Brotherhood was prepared to do battle. By 1928, after years of struggle, the American plan was defeated and the Brotherhood emerged stronger than ever.

The working man, however, was on the verge of terrible days. By 1933, almost 13 million persons were out of work due to the depression. Brotherhood Secretary Frank Duffy reported that less than 30% of the members were employed. Yet, through all these years of trial, members fought against the squeeze by employers. In 1934, the United Brotherhood and other AFL unions joined forces to win supporters in Congress for what was to become a labor milestone: The Wagner Act. Signifying a major victory for labor, this Act not only reaffirmed workers' right to organize, but declared it to be United States policy to encourage the practice of collective bargaining. The fortitude of Brotherhood members had been tested and proven.

As the 1940's began and as the depression gradually eased, America found itself thrust into World War II. Immediately, the Brotherhood pledged its cooperation to President Roosevelt and urged the erection of a National War Labor Board similar to that of 1918. In one of the first issues to confront the board, union membership was generally upheld.

The Brotherhood not only contributed to the war effort by keeping war projects supplied with skilled craftsmen, but was able to protect its members simultaneously.

Few of the actions by the Carpenters, however, have had greater significance to labor than the one that was brought on by the Department of Justice's anti-trust onslaught. The on-slaughter had begun in 1939 with a barrage of indictments against literally scores of labor leaders, charging that they had acted in restraint of trade through monopolistic practices. Unlike many other labor leaders, President Hutcherson not only rejected the Justice lawyers' overtures, but denounced them to their faces. The Justice Department decided to make the Carpenters the test target of its whole "anti-monopoly" drive against organized labor. The issue, whether or not actions of labor organizations are subject to the provisions of the Anti-Trust Act, was decided by the Supreme Court in favor of the Carpenters. It was a spectacular victory for labor—and it was won by the Brotherhood, fighting while others were surrendering.

Success, however, has also been accompanied by disappointment. In the mid-forties, demands for stiffer controls over labor became overpowering. Despite the tenacious efforts of Brotherhood officials and other union leaders, the Taft-Hartley Act was enacted by Congress, establishing a veritable "can't do" manual for labor. On the Brotherhood's 90th anniversary, these so-called "right to work laws" remain a challenge to be met and disposed of.

Throughout the Sixties, the United Brotherhood of Carpenters and Joiners continued to persevere and to struggle for the working man. It is this dedication and perseverance which has been carried over into this young decade of the Seventies. On this 90th birthday of our union, we should both reflect on our triumphs of the past and on our hopes for the future. What was begun by a few is being carried on today by hundreds of thousands. The weak have united, and have become strong. Indeed, their strength is increasing every day. ■

PRESIDENTIAL VISITORS

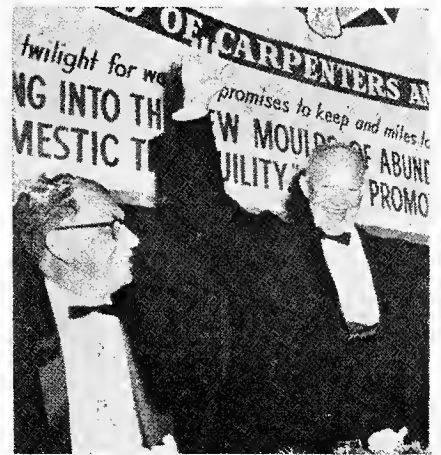

President Eisenhower attended the Diamond Jubilee Celebration of the Brotherhood in Washington, D.C., in 1956.



Presidential Candidate Richard Nixon was a visitor to a Special General Convention held in Chicago in 1960.



Presidential Winner John Kennedy spoke to delegates attending the special Chicago convention in 1960.

WORLD'S LARGEST AIRPORT RISES ON NORTH TEXAS PLAIN



Brotherhood Members Employed on Dallas-Fort Worth Regional Airport

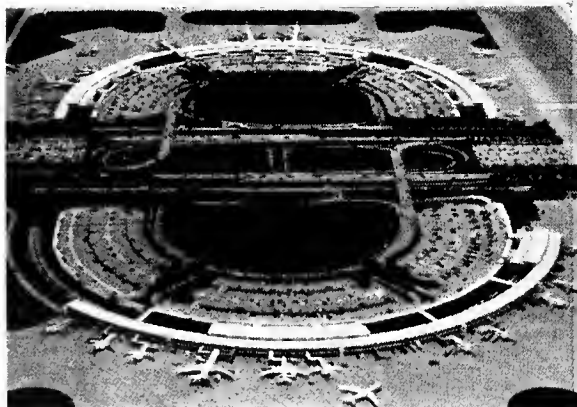

ABOVE: Two terminal buildings of the big airport create a full loop. A spine roadway cuts through the center. Seven such full loops will operate in the completed airport (see drawing at right).

RIGHT: Like a giant aircraft carrier, the completed Dallas-Fort Worth Airport will dominate its surroundings.

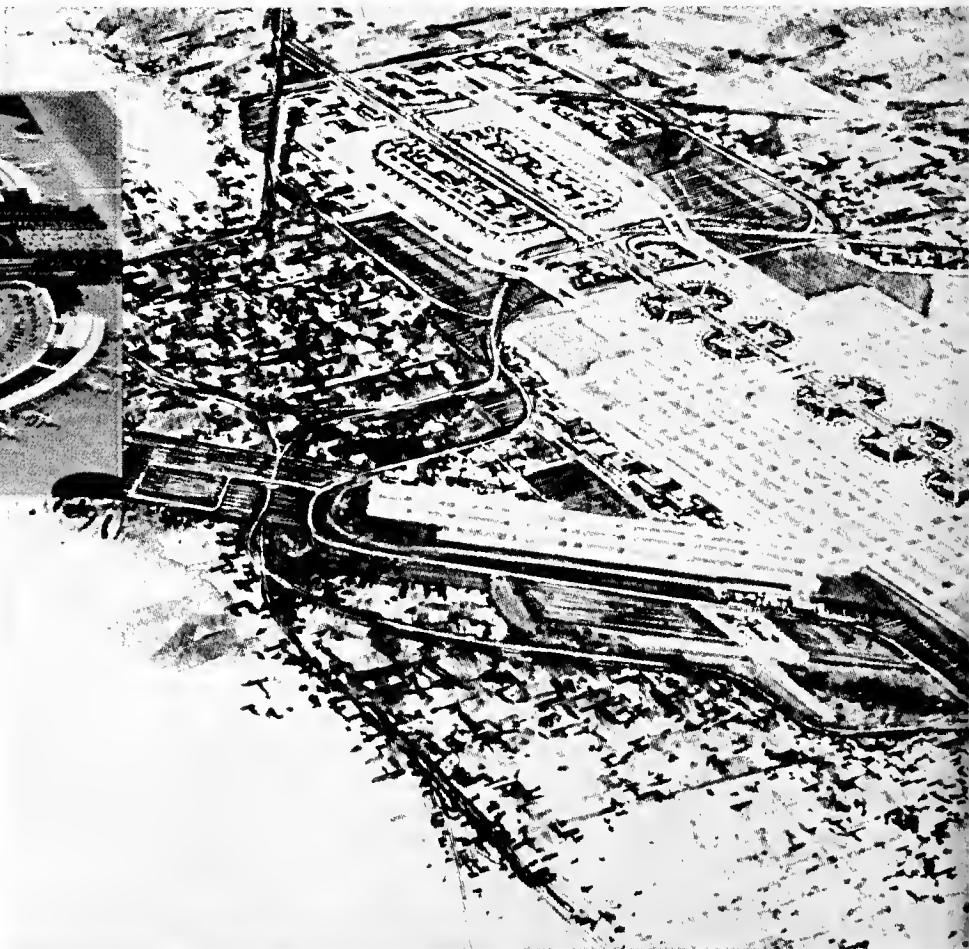

■ **THE FIRST** major structures of the Dallas-Fort Worth Regional Airport are rising above the ground, giving substance to a plan for the world's largest air terminal facility.

Scheduled for a mid-1973 completion date, the mammoth project now involves more than 500 construction craftsmen, scattered over an 18,300-acre site, working on a battery of contracts now exceeding \$100 million.

In the forefront of this construction activity are members of the North Central Texas District Council of Carpenters, now celebrating its first anniversary. The District Council was established to meet the work demands of the Dallas-Fort Worth Regional Airport Authority, a community effort drawing its support from Dallas and Fort Worth and satellite cities.

In storybook Texas style, the Regional Airport will set several

records for bigness, outstripping anything else used by commercial aviation anywhere in the world—in physical size, capacity, and modern equipment. At the moment of its completion, it will be twice the size of Kennedy International Airport in New York, presently the nation's largest, and far overshadowing the size of Paris' famous Orly Airport, now the world record-holder.

The Dallas-Fort Worth facility will open with four independent terminals which will accommodate 64 747-type superjets at one time, and three major runways (two of them more than two miles long). Within two years of operation, the on-site work force at the airport and its supporting services will be in the neighborhood of 20,000.

At midpoint in its construction, however, airport activity to date has been focused on earthwork, grading, drainage and foundation work. Only

now is above-ground work to be found at the 25 square mile site. The work is growing as carpenters and other workmen begin such airport components as terminals, bridges, apron and taxiway paving, parking, an administration building, FAA control tower and other structures.

The Regional Airport is located equidistant between the "All-American Cities" of Fort Worth and Dallas. One segment of the airport lies in Fort Worth's Tarrant County and the other in Dallas County. Several interstate, federal, regional and state highways—plus a high-speed toll road—serve as transportation spokes from the airport to the surrounding areas.

The airport is the brainchild of the North Central Texas Council of Governments, a somewhat loose association of municipal governments of ten cities and towns in a five-

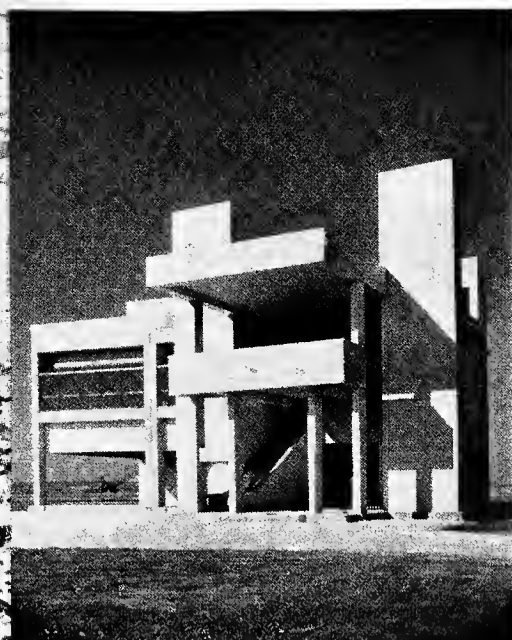
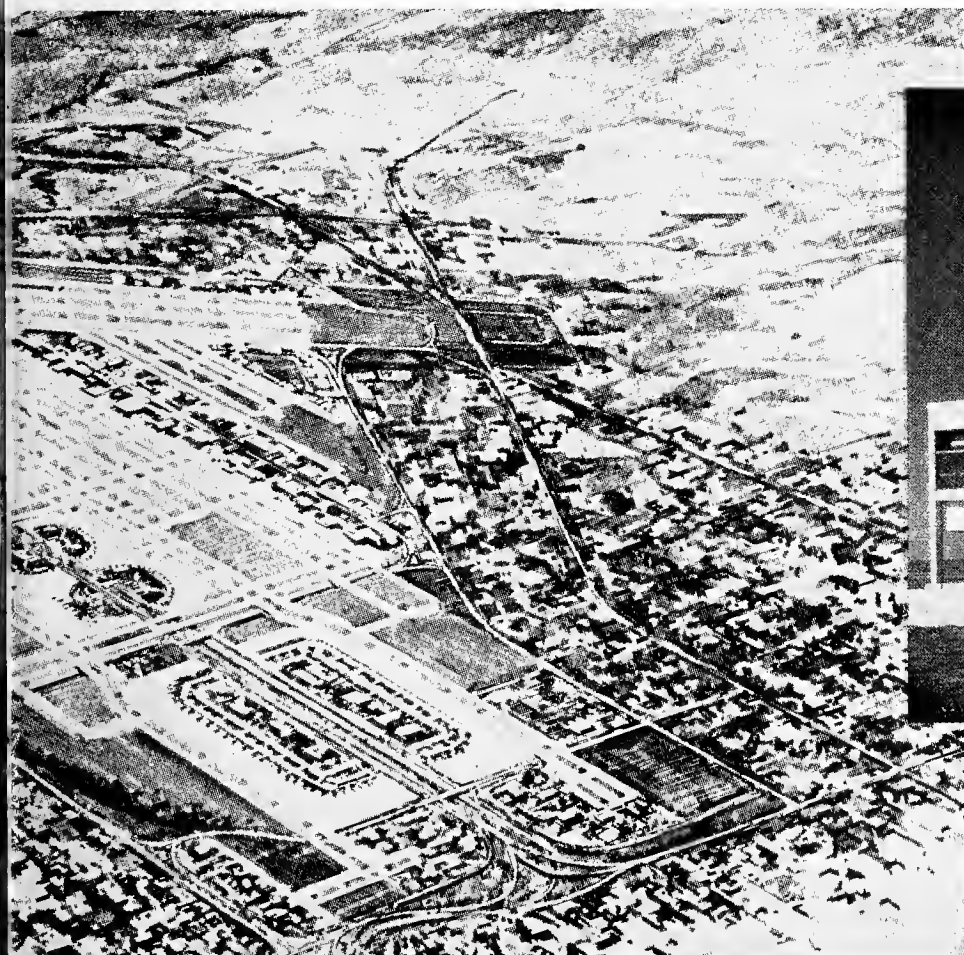

ABOVE: A mockup of a terminal module built as a prototype to demonstrate construction styles and methods.



county cluster making up Texas's largest metropolitan area. NCTCOG, incidentally, has no legislative or taxation powers, but nevertheless has performed wonders. The group was organized in 1965 to bring about orderly growth to the booming central Texas region; in three years, the group broke ground for the airport, which it considered would be the hub of a steppingstone for the burgeoning trade of the area in years to come.

The Airport Authority, given authority by the Council of Governments to construct the air terminal facility, engaged airport planners to devise a master plan whereby immediate needs could be met and at the same time provide for a program of orderly growth to serve the community until the turn of the century.

The result was a program that called for the immediate construction of a common airport facility now being served by Dallas Love Field and Fort Worth's Greater

Southwest International Airport. The plan devised is being looked upon by the government as a prototype for major airports of the future.

Phase 1 of the 30 year overall airport development plan involves the construction of four passenger terminal "half-loops" and three runways. This basic system—in itself the world's largest in terms of physical size and capacity—will accommodate nearly 1000 aircraft movements daily. The four terminal buildings gates provide more than 60 aircraft gates forecast to handle almost 20 million airline passengers in 1975. The Phase 1 plan provides for road and taxiway access to over 1000 acres of airline maintenance areas in close proximity to the passenger terminal complex. The central area of the airport will be served by several highways from without, and by an automated transit system from within that will move passengers and employees, baggage, mail and even solid waste.

The land has been purchased and

prepared for unhampered fulfillment of the full 30 year plan. By the year 2000, the airport will stretch approximately nine miles from north to south, and nearly eight miles in width. Two of its runways will be expanded to lengths of almost four miles. The passenger terminal complex, four mile long, will consist of 13 of the "half-loop" modules capable of processing in excess of 50 million passengers annually. More than 220 jumbo jets can be parked at the passenger terminals at one time. Convenient, covered parking for more than 40,000 cars will be provided within the terminal areas (at not more than 30 feet from any aircraft entrance gate). Two fully-automated air cargo terminal centers, each capable of handling over 100 future cargo aircraft, flank the ends of the passenger terminal complex. Completely separate STOL and executive aviation airfields will operate independently of the central terminals. A major industrial airport is also planned, as well as are





major hotel, commercial, and shopping areas within the airport's boundaries. The terminal facility is designed to avoid congestion and safety hazards which have come to haunt so many metropolitan airport areas.

Already 17 prime contractors have been named to carry out various segments of Phase 1. About 500 construction workers of various crafts are presently on the airport site, plus about 160 major pieces of earthmoving and similar large equipment. With runway and taxiway preparation almost 100 percent complete, contractors are progressing on other major drainage and foundation work. Up until a month ago, carpenters were primarily engaged in form work. Now, however, above-ground work is underway on a communications center, an administration building, and one of the terminal buildings. With most of the terminal work forthcoming, the need for carpenters and other

Continued on page 22

THE PICTURES, TOP ROW, from left: 1. Douglas Oslick, Thorndale, Local 198, and Joe Hudgins, Fort Worth, Local 1822, at the Communications Center . . . 2. Remind you of a former president from Texas? Actually, it's Urban Brown of Local 1822, Fort Worth, steward for Cadenhead Construction Co. of Fort Worth. . . 3. Patrick Carlton of Local 1822 . . . 4. W. G. Oster of Dallas, Local 198, steward at Communications Center, and Carpenter Foreman James Hearrell . . . 5. Richard Schroeder of Enless, a member of Local 1423, general carpenter foreman . . . 6. Tom

Mooney of Local 1822, Fort Worth, at work on the Administration Building . . . 7. Edsel Keel, Local 1822, superintendent, and Ronald Bonner, Local 1822, foreman for Cadenhead Construction Co., look over plans . . . 8. Charlie Garcia of Cleburne, a member of Local 1822. BOTTOM ROW, from left: 1. Joe Hudgins, right, saws with the help of Jack Welch of San Antonio, Local 859 . . . 2. Charles Williams, Fort Worth, Local 1822, and J. W. Barber, Dallas, Local 196 . . . 3. Members at work on forms for the big and complex Airport Communications Center.



ABOVE: A recent aerial view of the airport work site, looking north by northwest. The passenger terminal complex at center, with its seven full loops of loading ramps, is four miles long. The airport extends approximately nine miles north to south and eight miles in width.



WASHINGTON



ROUNDUP

ANTI-LABOR APPOINTEES—Nixon appointees on the National Labor Relations Board are increasingly revealing their management viewpoints as expressed in two recent Board decisions.

Chairman Edward B. Miller and member Ralph E. Kennedy, both Nixon appointees, were the nucleus of a three-man majority in a case involving the Teamsters and Linden Lumber Division of Sumner & Co. of Columbus, Ohio, in which an employer was found to be justified in his refusal to bargain with a union despite a card count showing a clear union majority.

Members John H. Fanning and Gerald Brown, both Democratic appointees to the Board, dissented contending that under settled Board policy, an employer was under the obligation to recognize a union whenever it presented "convincing evidence of majority support." They held that in the case in question there was no legitimate reason for assuming that the card count was erroneous.

In a second case, Kennedy dissented from a decision, his dissent narrowing picketing rights in a secondary boycott case.

CONSUMER LEGISLATION—The Senate has passed a warranty and guarantee bill which will cover products costing more than \$5.00. Guarantees will have to be written to conform to Federal standards. As it is now, said one government study, most guarantees just don't mean anything at all.

The bill also calls for additional powers for the Federal Trade Commission, including preliminary injunctive powers to stop businesses from engaging in unfair practices, the right to assess civil penalties up to \$10,000 per violation, the right to seek court action to gain other remedies for injured consumers such as money refunds, and the right to issue new regulations declaring certain business practices as unfair or deceptive.

WORKMEN'S COMPENSATION—President Nixon has named a 15-member commission, established under the 1970 Occupational Safety and Health Act, to study and evaluate state Workmen's Compensation laws. The commission will report not later than July 31, 1972.

Named as labor representatives on the National Commission on Workmen's Compensation Laws are James R. O'Brien, assistant director of the AFL-CIO Department of Social Security, and Michael R. Peevey, director of research, California AFL-CIO.

MADISON AVENUE GIMMICKRY—"Jobs are the keys to today's problems," in the view of AFL-CIO President George Meany, and as far as the Nixon Administration is concerned, "what we are getting is a blue bird atmosphere at the White House and Madison Avenue gimmickry."

"The Nixon economic policies all add up to failure," Meany declared. "The Nixon Administration has failed to take the needed steps to provide jobs which are the key to the whole situation."

SUPREME COURT BACKS UNIONS, NLRB POWER—In two highly important cases, the positions of the unions involved have been sustained by the Supreme Court.

In the first case, involving Local 6799 of the United Steelworkers and Secretary of Labor James D. Hodgson, the Court decided that the Secretary of Labor does not have the power to investigate union procedures that are not specifically complained of.

At issue in the second decision, involving a member of the Transit Union, was whether the case fell under the jurisdiction of the state court or of the National Labor Relations Board. The five-man majority held that under the long-established pre-emption principle, behind which principle was "the Congressional purpose for effectuating a comprehensive national labor policy to be administered by an expert central agency rather than by a Federalized judicial system," the proper forum was the NLRB rather than the state court.

JOBS JOBS JOBS JOBS



Union carpenters—a group of those building tradesmen whom President Nixon blames for current inflation—wait around for jobs in a Washington, D.C. union hall.

WASHINGTON CONFERENCE OFFERS SOME ANSWERS

"They blame inflation on inflation's chief victims.

"They blame unemployment on those who are losing their jobs.

"They blame high prices on those who cannot afford to pay them."

These comments, directed towards President Nixon and his administration, were made by AFL-CIO president George Meany at a recent two-day AFL-CIO conference on the state of unemployment in America.

The special Conference on Jobs brought out one indisputable point: the number of jobs available to the total American working force is pitifully inadequate. According to Congressman Carl Albert, Speaker of the House and one of the participants in the two-day session, the crisis of unemployment in our country is reaching "bread-line proportions."

As an apparent sop to angry trade unionists, the White House announced the signing on July 12 of the Emergency Employment Act, which is designed to create city and state public-service jobs for the unemployed under a two-year, \$2.25 billion program. This would permit the hiring of more fire fighters, policemen, and other public workers.

However, the big and most vital avenues for opening jobs—as defined in the 11 point AFL-CIO program shown on Page 10 of this issue—have been virtually ignored.

President Nixon has vetoed the pub-

lic works bill, which would have pumped funds into the economy just as quickly and effectively as such legislation did back in the 1930's.

He has failed to call for adequate funding of housing legislation, which would put our craft and all other building trades into high gear all over the United States. The basic housing act was passed by Congress under President Lyndon Johnson. Only a small portion of the funds needed for carrying out this Act has ever been appropriated.

Another area of concern to the participants in the Conference on Jobs was the problem of reconverting the country from a wartime back to a peacetime economy. Senator Henry Jackson, addressing the conference on the problem, placed major emphasis on the need to achieve economic growth and full employment. He pointed out that retraining programs, while important, are a waste of time and money and are a cruel joke on the newly retrained workers if no jobs are available.

Further, Jackson indicated that any reconversion plan must include the advancement of consumer buying power, and he stressed the importance of raising the minimum wage to at least \$2 an hour. Raising the minimum wage raises the buying power of the people who need it most. It is necessary, he indicated, to maintain the purchasing power of the civil-

ian economy as we make the reconversion transition. Raising the minimum wage, he believes, will enable us to do just that.

Jackson also stressed his belief that a successful reconversion program is particularly dependent upon government efforts to boost the economy. As he expressed it: "The most important single responsibility facing any administration is the wise management of the nation's economy. A stable, vigorous economy is the key to all our other national goals. A full employment economy provides jobs and a sense of purpose for Americans. It builds tax revenues for states and local governments. It releases money for housing, for automobiles, for new investment by businesses and families. It provides the resources to protect our environment, rebuild our cities, improve our health care, and assist the poor. It is the key to equal opportunity for young people and minorities of all races."

Perhaps one of the most apparent problems in employment today is the rapidly expanding loss of jobs in many key industries due to the lack of a constructive trade policy in the United States. Addressing the conference on this matter were Congressmen Jackson E. Betts and James A. Burke. Both congressmen agreed that the time had come for new trade legislation to be enacted.

Continued on page 10

"Didn't Nixon Promise to get the country pulling together?"



Cartoon by Bassett, Washington Daily News

Continued from page 9

Betts and Burke urged the leadership of the AFL-CIO to implore Congress to move toward consideration of remedial trade legislation.

Congressman Betts specifically urged that trade-implementing decisions be taken out of the hands of the Executive Department, with its over-emphasis on diplomacy, and be put under the control of the Congress. He also proposed that in any international negotiations affecting trade, representatives of labor and affected industries be included in the deliberations.

Congressman Burke cited the relationship between the nation's present trade deficits and the heavy joblessness now being suffered in this country.

Multinational corporations, he indicated, have no sense of responsibility to the United States. Their companies go from country to country, staying only as long as they can exploit the resident workers. Multinational companies, he further stated, will not be concerned about the loss of jobs in the United States. They are only concerned with the loss of their own rights. However, he feels that such events as the recent international monetary crises will eventually cause the companies to be "caught in their own net."

Also discussed during the session on trade was the AFL-CIO's proposed nine-point program for international trade and investment legislation. The

broad legislation, embracing taxes, trade, consumer standards, and labor standards, is now in the process of being drafted into specific legislative form. Among the provisions included in the proposal are the cessation of the export of U.S. jobs, the removal of the incentive to establish production and assembly facilities abroad, the regulation of the export of technology, the establishment of international fair labor standards in world trade, the modernization of existing anti-dumping and escape clauses in trade legislation, the developing of a truth-in-labeling policy, and the institution of laws to protect the safety and health of American consumers.

Chairman of the House Ways and Means Committee Wilbur D. Mills (D-Ark.) addressed those who attended the conference on the problem of unemployment compensation. Referring to unemployment insurance as the first line of protection for unemployed workers, Mills discussed with particular emphasis the Employment Security Amendments of 1970. He stressed the fact that these amendments constituted the most sweeping changes made in the unemployment compensation program since its conception. The changes included extension of coverage to small firms, non-profit organizations, state hospitals, and state institutions of higher education; a permanent federal and state extended benefit program; modifications of harsh state disqualification provisions; and substantial improvements in the financing of unemployment insurance.

As yet, Arkansas is the only state to fully implement the amendments, and is the first state in recent years to enact legislation establishing a weekly maximum benefit amount of 66 2/3 percent of the statewide average weekly wage. This increased to four the number of states and U.S. possessions that have now met this goal—Arkansas, Hawaii, Utah, and the Virgin Islands.

Chairman Mills stated that "while we hope that other states will follow their lead, this matter of adequacy of benefits is too important to be left to hope alone. In the best interests of the American worker, you who represent organized labor must continue to give us and the state legislatures the benefit of your experience and your views and those of the members of your organizations, because as you here will recognize, your members are on the firing line—literally and figuratively—when recession or depression occurs."

AFL-CIO 11 Point Program for Jobs

1. Federal Government policies must be based upon a full employment concept.

2. The Administration should establish a Cabinet-level committee to coordinate Federal programs in the transition from a defense-oriented to a peacetime economy.

3. Legislation is needed for immediate aid to communities hit by unemployment, similar to the Federal aid that is provided areas hit by natural disasters.

4. A nationwide public service employment program to create jobs for the unemployed and seriously underemployed.

5. Release of the \$12 billion appropriated funds now frozen by Nixon and speedy enactment of a multi-billion, accelerated public works bill

similar to the one vetoed by President Nixon last month.

6. Federal grants to state and local governments and non-profit, educational and research institutions to expand research and development in such areas as environment, pollution-control, mass transportation, land use, urban development and health service.

7. Federally-financed, extended Federal unemployment insurance.

8. Federal relocation allowances to assist unemployed workers to move to areas of job opportunity.

9. Increase of education and training allowances under the GI Bill.

10. Special transfer rights and other aids to displaced Defense Department civilian employees.

11. Long-range planning and programming to coordinate national needs in all areas.

Wide-stance Super Suspension—the best thing that ever happened to a bad road. Nobody makes a 3-ton pickup that stands wider than this Chevy, a stabilizing influence on campers. Super Suspension, coil-sprung up front, snuffs out bumps before they can get to you. Coil or leaf rear springs available.

Power for hard climbs—heavy loads. Specify V8s up to 402 cubic inches in Chevy pickups and the Suburban you see here. It takes nine passengers with the available third seat and tows a trailer besides. Because it acts like a station wagon and pulls like a truck, Suburban is *Camping Guide's* "Tow Car of the Year."

Fade-resistant disc brakes—for downgrades and downpours. They throw off brake-fading heat efficiently. And they shrug off the effects of rain and slush. Front disc brakes come standard now on all light-duty Chevy trucks. Illustrated here is a Chevy Van Motor Home Conversion.

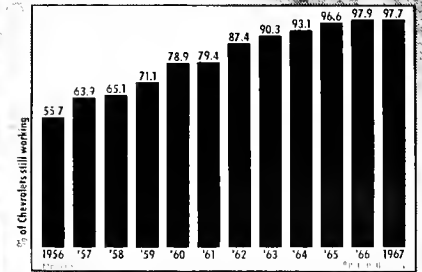

Chevy lasts longer. Here's proof. The latest official figures* show how Chevrolets outlast other trucks. Going back as far as 1956, for example, over 55% of the Chevrolets of that model year are still on the road. No competitive make has as many as half of its 1956 models still going.

*Source: R. L. Polk & Co.

Buckle up for safety.

Camper country and Chevy's totally tougher trucks were made for each other.



Totally tougher trucks.

APPRENTICES BUILD THEIR OWN SCHOOL

This article is based upon a feature story by Rachel Kearns in The Naples Daily News.

ON-THE-JOB TRAINING—Carpentry students are erecting their own classroom building on Enterprise Avenue in East Naples. The four-year course is sponsored by the Collier County school system and Carpenters Union Local 1641.



■ The carpentry apprenticeship program in Naples, Fla., has been in existence for only three years. Forty-two students, however, are already demonstrating their talent in what is undoubtedly a unique educational endeavor. They are building their own school!

The building of the \$38,000 facility is a class project which is being handled completely by the apprentices under the direction of the program's two instructors, Carl Ahlbrandt and John Steinhauer.

With materials paid for by the carpenters' union through an agreement with local construction firms, work on the new structure has been underway for several months. Both Mr. Ahlbrandt and Mr. Steinhauer are anticipating the completion of the school by the fall. The students, however, are in no hurry. The building serves as

an excellent instructional project, giving every apprentice the opportunity to expose himself to all phases of construction, including the task of supervision. A student foreman and a student steward are appointed for each three-hour construction session.

Naples' four-year carpentry apprenticeship program is co-sponsored by the Naples Joint Apprenticeship Council of Carpenters, which is composed of members from labor (Local 1641) and management, and by the Collier County School Board, which provides qualified staff certified by the State Department of Education to supervise and instruct apprentices.

In addition to the time spent gaining practical experience on the actual construction project, many of the students' sessions are held at Local 1641 headquarters, next door to the school. There the students study construction methods and techniques, blueprint

reading, building codes, and building-related mathematics. Obviously, the course is a well-rounded one.

When completed, the new school facility will house a large shop area, two large classrooms, a visual aid and tool storage room, offices, and kitchen facilities. "We had some difficulty getting this program off the ground," said instructor Carl Ahlbrandt. "The first year it was nip and tuck. But last year we took second place in state competition, and it was the first time we had ever entered. Now we have raised enough money to build our own school and to get our own equipment. I think there are only two other carpentry apprentice programs in the nation that have built their own school." Local contractors agree to pay three cents per hour per man for the education of their apprentice employees. This comprises the school's entire income. ■

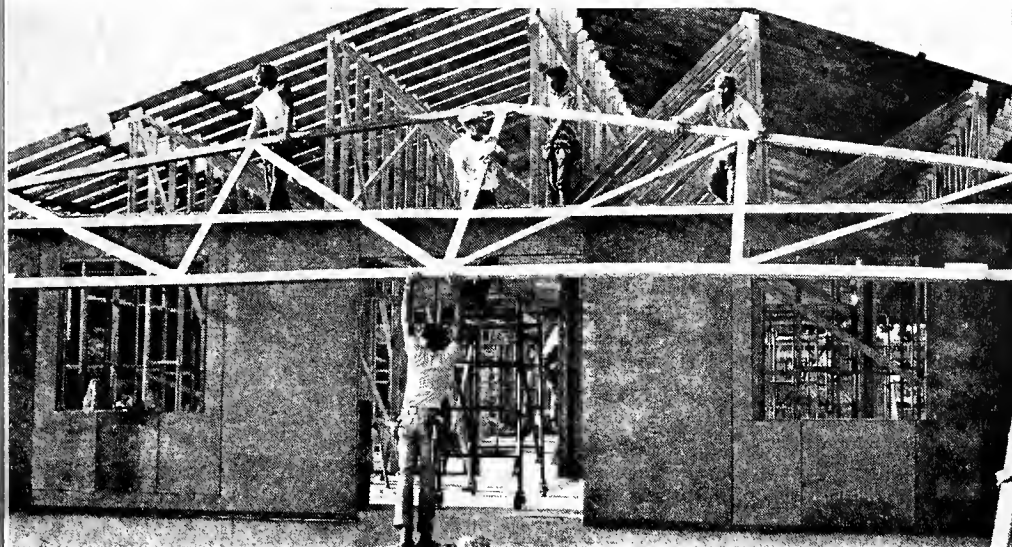

HEAVE HO!—Carpenters apprentices decided to hoist up roof trusses themselves after their crane operator failed to show up for a recent building session. The trusses weigh 1,000 pounds each.

All photos except the one of the group of men below are courtesy of Naples Daily News, Naples, Fla. The one below is by John Norman of the Naples Star.

INSPECTING the new carpentry apprentice training facility are, from left, H. L. Stoneburner, Jr., general contractor and chairman of the Naples Carpentry Apprenticeship Training Program; Lewis E. Predmore, Collier County Vocational School director; and John K. Steinhauer and Carl L. Ahlbrandt, the program's instructors.



SATISFACTION—Instructor Carl L. Ahlbrandt says he gets a kick out of working with young men in the carpenter training course he helps teach. The pipe, ruler stuck in his hip pocket and pencil behind his ear are Ahlbrandt's constant companions as he guides the young men through construction of a classroom building.



TAKING A READING—Carpentry students Danny Freeland, top, and Mike Lee check placement of a heavy roof truss with level and rule. The young men and their 40 classmates work as carpenters by day and study the trade further during late afternoons.

KEEP YOUR EYE ON EVERY MAN—Instructor John Steinhauer, left, gives pointers to Jimmy Hurley, who acted as student foreman one day last week in carpenter training class.

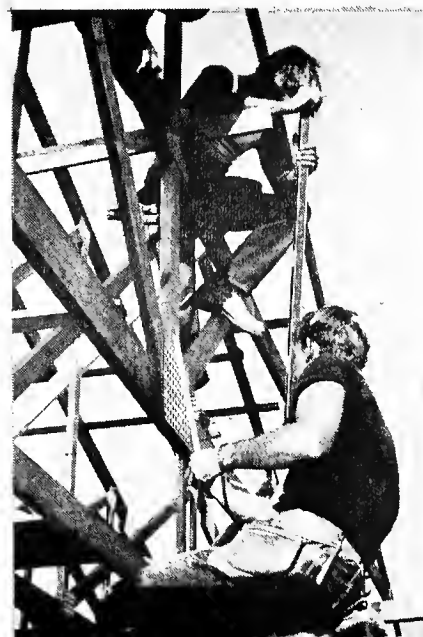



1A



1B

(1) BERKELEY, CALIF.—On April 22, 1971, Local 1158 of Berkeley held a pin presentation dinner at His Lordship's Restaurant on the Berkeley Marina. Seventeen 30-year pins and 19 25-year pins were presented.

Charles S. Spainhower, the only living Past President of Local No. 1158, served as chairman for the occasion. A total of 234 dinners were served to No. 1158 members and their wives and guests. President Don Keebler presented the pins.

In Photo No. 1A, 25-year pin honorees are shown. Seated, left to right: Willie Lee, Jr., Robert Ferguson, John Herbert, Farrell England, Arne Olsen, Kenneth Henning, and Perkins Lovelace. Standing, left to right: William Mahaffey, Flournoy Sheppard, Bert True, Carl Nelson, Elmer Emmett, Henry Barr, Ed Goodwin, E. L. Grant, Elmer Larsen, Harold Schlaffer, Roger Washington, and John Miller.

In Photo No. 1B, 30-year pin honorees are shown. Seated, left to right: Con O'Keefe, Andrew Abeles, Orville Arneson, Chas. Barham, Elwin Barham, Henry Sherman, Robert Schwinger, and Raymond Rice. Standing, left to right: Melvin Kinnick, Sigvard Jensen, Albert Smith, Amil Keleva, Frank Henning, Lloyd Bredchoft, H. E. Stephens, W. C. Johnson, and Chas. Spainhower.

SERVICE TO THE BROTHERHOOD

A gallery of pictures showing some of the senior members of the Brotherhood who recently received 25-year or 50-year service pins.

(2) MONROE, MICH.—Here are members of Local 1301 honored for 25 years of service to the Brotherhood. A party was held at the Eagles Hall in Monroe. Shown in the picture are: Chester Barnes, George Becker, Edward Bitz, Dwain Brown, Arthur Chapman, Winifred Cribbs, Harry Duncan, Charles Engel, Haston Estus, Emil Gekle, Carl Geyman, Henry Grassley, Richard Greer, Leo Hayes, Louis Heinzerling, Howard Hoffman, Earbie Jones, Arnold Kinne, Stanley Kolassa, John Kreuger, Allison Miller, Albert Miller, Harold Moth, James Osinek, Joseph Palmer, Joseph Pope, Robert Reinking, Walter Rieker, Elmer Smith, Nathan Uhl, William Valimont, C. V. Wagoner, Charles Walker, Homer Wells. Also honored were Vern Wells, Carl Zumfelde, and Carl Miller for more than 30 years of membership.

2





CANADIAN REPORT

House of Commons to Debate Proposed Labor Code Next Month

New federal labor legislation introduced a few weeks ago includes the creation of a revamped and more effective labor board which will replace the present Canada Labor Relations Board made up of employer and employee representatives.

The new board will be made up of members of the public chosen by the government.

While this change in the new Canada Labor Code which replaces the old Industrial Relations and Disputes Investigation Act is dismissed as unnecessary by the Canadian Labor Congress, it does not go as far as the recommendation of the Woods Task Force report which proposed a powerful independent commission to deal with public interest disputes.

The Code, like the old Act will govern collective bargaining in industries under federal jurisdiction such as banks, shipping, railways, airlines and broadcasting.

These industries employ about 550,000 people. The rest of the working force numbering around seven million are covered by provincial legislation.

Numerically the provincial jurisdiction in Canada is more important than the federal, but the federal legislation, especially when it is so important as the new Code, is bound to have a big influence on the future direction of provincial labor laws.

For example, the Labor Code gives unions the right to negotiate the effects of technological change during the life of a collective agreement.

The board to be appointed will decide the circumstances in which unions will be allowed to strike, while an agreement is still in effect, in order to protect employees against the impact of technological change.

Labor Minister Bryce Mackasey said the Code will not appease those em-

ployers who were looking for restrictive legislation. He contended that the collective bargaining process can be made to work without arbitrary intervention by the state.

It should be easier for unions to get certification under the new Code as it allows for a vote with membership support of 35 to 50 percent. In addition the results of the vote would be determined by a majority of employees voting instead of a majority of those eligible to vote.

These and other changes have been welcomed by the trade union movement.

The new legislation will be debated in the House of Commons in September.

Improvements Seen In 1971-72 Budget

Other major legislation out of Ottawa in which the labor movement was keenly interested was the federal budget.

The 1971-72 budget included some major changes. They did not go as far as the trade union wanted in terms of an equitable system of taxation, but they made considerable improvements.

The most immediate benefit was the removal of the three percent surtax on personal and corporate income effective July 1, 1971.

On the same date all taxpayers with taxable income under \$500 will be exempted. The guaranteed income supplements payable to old age pensioners are also eliminated.

The main charge against the budget is that it does very little to make jobs. Government economists predict that the jobless situation will be greatly eased by the end of 1972, but by this they mean, unemployment will be

down to about five percent as a national average.

But trade union leaders considered this discouraging.

However they welcomed the first capital gains tax in Canada even though they protested that it should tax 100 percent of capital gains instead of 50 percent as the legislation intends.

Another welcome feature is that basic personal income tax exemptions will be increased from \$2,000 to \$2,850 for married persons, and from \$1,000 to \$1,500 for single persons effective January 1, 1972.

Federal finance minister Benson said that the budget will reduce taxes for five out of eight taxpayers, but opposition spokesman David Orlikow, NDP-Winnipeg North, said it was just a shuffling of privileges and inequities. They are just tax changes, not tax reform.

He pointed to the fact that wage-earners will be taxed on 100 percent of income less exemptions but speculative gains will be taxed on only 50 percent.

The budget does ease the burden of taxation on the lower income groups but they will still be paying a disproportionate share of overall taxation.

Ontario Introduces No-Fault Insurance

The Ontario government has introduced a scheme of no-fault auto insurance which goes part way toward eliminating some of the worst deficiencies of present private insurance practices.

This is the fourth province to introduce the principle of no-fault insurance. Two of them, Saskatchewan and Manitoba, are overall plans under government ownership and control; the other two, in British Columbia and now Ontario, lay down the rules for private insurance coverage.

In Ontario policies now held by about 70 percent of motor vehicle owners covering accident benefit insurance will automatically become no-fault insurance coverage which pays benefits in case of death or disability regardless of fault in a mishap.

Present accident benefit coverage costs \$9 a year. The 900,000 auto owners who do not now carry it will have to, starting January 1, 1972.

The Ontario plan does not cover property damage insurance as do those in Saskatchewan and Manitoba.

On this score it has been criticized, not only by the NDP and the Ontario Federation of Labour, but by private insurance underwriters.

They realize that accident benefit in-

Continued on page 16

SERVICE TO THE BROTHERHOOD

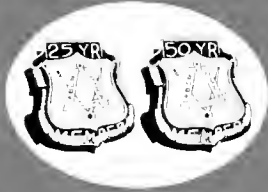

A gallery of pictures showing some of the senior members of the Brotherhood who recently received 25-year or 50-year service pins.

BELLEVILLE, ILL. — Several members of Carpenters Local 433 were honored at an awards night Friday, March 26 at the V.F.W. Hall. Honored were retired Business Representative and Recording Secretary Thomas Wright, who was presented with a Carpenters' emblem watch; retired Assistant Business Representative and Financial Secretary Edward J. Kalkbrenner, who was presented with a Carpenters' emblem ring.

The following members were presented

1A



1B



50 year pins: John Abendroth, Louis Hackman, Fred Anderson and Emil Faessler.

25-year pins were awarded to: Rudy Wothouse, Norbert Wolf, Henry Von-Bokel, Kenneth Voland, Charles Cook, Tom Boller, Harold Duff, Gordon Bien, Wm. E. Flach, Jr., William Allan, William Schwebel, Armin Ackerman, Alfred Kraft, Harold Rickert, Norbert Wenzel, Leonard Kunkelman, and Harry Bostick.

In Photo No. 1A, front row, left to right: Kenneth Voland, Edward J. Kalkbrenner, Thomas Wright, Leonard Kunkelman, Emil Faessler, Louis Hackman, Harry Bostick and Fred Anderson.

Last row: Norbert Wolf, Armin Ackerman, Charles Cook, Norbert Wenzel, Henry VonBokel, Lester Appel, Harold Duff, Tom Boller, Wm. E. Flach, Jr., Alfred Kraft, Gordon Bien, William Schwebel, Harold Rickert.

In Photo No. 1B, from left to right: Alfred A. Kraft, business representative and recording secretary since 1965; Thomas T. Wright, who retired from that position after 28 years; Robert Wright, chairman of the committee for awards night; Lester Appel, president of Local 433; Edward J. Kalkbrenner, who retired in October, 1970, as assistant business representative and financial secretary after 16 years; and Harold Rickert, who succeeded him in that office.

insurance covers only about 30 percent of accidents.

The Ontario superintendent of insurance says that about 90 percent of complaints received by his department come from vehicle to vehicle damage disputes.

Private insurance industry knows that, if it does not come up with better coverage without higher costs, the public will look to a New Democratic government to step in and introduce a compulsory auto insurance plan providing universal coverage at rates up to 30 percent below present rates.

This will be an issue in the Ontario election expected this fall.

Labor Jubilant Over Political Changes

The New Democrats backed by organized labor are establishing themselves as a growing threat to the old line parties in Canada.

This is the consensus after the NDP won a federal by-election in Ontario from the Liberals and then followed it up with an unexpected and decisive victory in Saskatchewan to win the government away from the Liberals.

In Ontario the win by a 36-year-old school teacher Derek Blackburn was in the Brant seat, part industrial, part rural. Labor gave the NDP a solid vote while, for the first time in Brant's history, the farm vote also swung NDP.

In the western province the farm vote is of course dominant. Liberal premier Ross Thatcher campaigned on an anti-labor platform and the trade unions feared another wave of anti-labor legislation if the Liberals were re-elected.

Thatcher tried to make sure of reelection by redistributing the seats in his favor to such an extent that he might have held on to government with only 36 percent of the vote. But both the farm vote and the labor vote went NDP and Allan Blakeney, NDP leader, won 45 seats to only 15 for the Liberals. The Conservatives won zero.

Needless to say, the trade union movement is jubilant. Under the CCF government which governed Saskatchewan between 1944 and 1963, the labor legislation was the most advanced in Canada up to that time.

The NDP will continue in the CCF tradition. People remember that the old CCF under Tommy Douglas brought in the first universal hospital, and medical, and auto insurance plans on the North American continent.



1

(1) SAN PEDRO, CALIF.—On Saturday, March 27, Local 1140 held its annual pin presentation ceremony honoring brothers having 25 years of membership in the Brotherhood. The honored members and their wives were guests of the local at a dinner held at Del Conte's Steak House in Torrance, California. After dinner, 25-year pins were presented to the following:

From left to right, first row: F. J. Walters, Jess Salcido, Lloyd Letcher, and Hubert W. Dobbins; second row; Joseph H. Smith, Lewis Moore, Tranquilino Valdez, Walter A. Wallace, Kenneth K. Thompson, and Okey Edwards; third row; James E. Dickens, Earl Eberly, Charles Haler, Lee Bowen, R. D. Morris, Julian Luna, Paul V. Jones, and E. A. King; fourth row: Gordon A. McCulloch, Roy Skorpanich, Roy J. Phillips, Jr., T. J. Carpenter, and George Jurado.

The following brothers were unable to attend: F. B. Acuna, L. C. Alkire, Doyle Davis, Frank Friesen, David Healy, Roy Howard, A. C. Jensen, Les Johnson, Jack Ketch, C. D. Kette, John Kilpatrick, N. C. Madril, Sil Martinez, John S. McCarthy, John Metzger, D. E. Mills, James R. Ponder, and Howard Price.

The master of ceremonies was Harry V. Dawson, business representative of Local 1140 and president of the Los Angeles District Council. The awards were presented by Anthony Ramos, executive secretary of the California State Council of Carpenters. Also on hand to

2

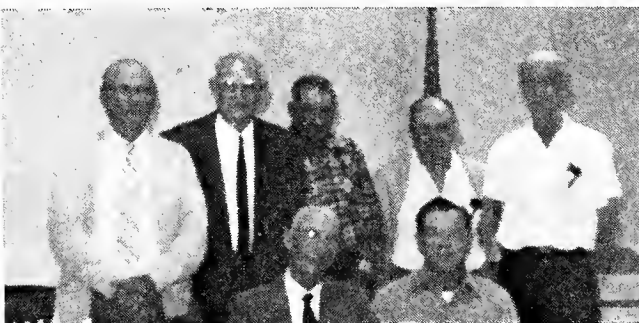

AUGUST, 1971

SERVICE TO THE BROTHERHOOD

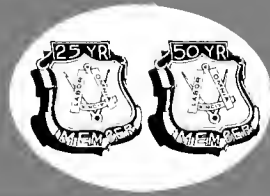

A gallery of pictures showing some of the senior members of the Brotherhood who recently received 25-year or 50-year service pins

participate in the ceremony were: John Cinquemani, executive secretary of the Los Angeles Building Trades Council; Russ Auten, assistant secretary of the Los Angeles District Council of Carpenters; Art Eisele, State Council of Carpenters; Terry Slawson and Pat McDonald, business representatives of the Los Angeles District Council of Carpenters. Robert B. Clubb, business representative of Local 2435; Robert Schafer, business representative of Local 2375; and Mrs. Gertie Schafer of the California State Council of Ladies Auxiliaries.

(2) MELBOURNE, FLORIDA—Here is a picture of seven members of Local 1685, Pineda, Florida, who were presented their 25-year pins at a meeting recently. They are, from left to right, in the back row, Donald M. Kelly, Oscar F. Goltz, Ernest W. Findley, Harold F. Condon and Alvin H. Bishop. Seated in front, left to right, Barney C. Kerr and Leonard Simpson.

3



Also presented pins but unable to be present were Adolph Cavel, G. A. Durand, Elmer J. Langford, John W. Morrison, Kelly Motherspaugh, Lonnie B. Thompson and Earl A. Tinney. Making the presentation at extreme right, Stuart T. Price, president of Local 1685.

(3) HUNTINGTON BEACH, CALIF.—The following members recently received service pins: The first row includes from left to right James Barker, Philip L. Barnes, Joe Biniewski, Clem W. Blythe and Cyril Fritz. Row Two begins with Charles Trenta, secretary O.C.D.C. In back of Charles Trenta is Art Turney, a visitor from Local 1648. The following are the names in order from left to right: Clarence Fleming, Dyas Hooper, Carl Elgin, George Coleman, Harold Knipp, and Bernie Heitkemper.

Those not present were Jack Herndon, Roy Hayes, Leo Fryer, Sidney Hayward, Jay Johnson, H. B. Kimbrough, and W. E. Moore.



1A

(1) BELLINGHAM, WASH.—Carpenters Local 756, celebrated its 70th Anniversary March 20th, with a banquet and dance held in the Crystal Ballroom of the Leopold Hotel.

In Photo No. 1A, members of Local 756, who received their 25-year pins at the anniversary banquet. Pictured are: Front row, Claude Gorrie, James Ryan, Harold Robinson, Earl Fralick, Otie Olmstead, Albert M. Hanson, Orin Willett, Warren Bailey, M. E. DelePlanque, Harold I. Hanson, Joe LaFreniere, Austin Beasley, Marion Libby, and Ray Clary. Middle row, left to right: Maynard Minge, Ellis Adams, Kenneth Blonden, Dale Monroe, M. W. Little, Frank Hatley, Calvin Heuer, Otto Fullner, Jorgen Jorgenson, Math. Nordgaard, Raymond J. Bajema, Denton Sutton, Fred Neely, Ed Weden, and Arthur Meyer. Back row, left to right: Brothers Verle Copeland, Paul Kirkpatrick, Arthur Anderson, Wilbur Kirkpatrick, Ole Frostad, Dan Carmichael, Leslie Lingbloom, John Roosendaal, Robert Brown, Bernard Dunnigan, Verne Martin, John Gustafson, Wayne Quimby, E. A. Becker, and John Seutvick.

In Photo No. 1B, Emil Olsen receives a gift of luggage, along with his 50-year pin, from International Representatives Paul Rudd and Hal Morton. Pictured, left to right, are: Local 756 Business Representative James H. Freeman, Representative Paul Rudd, Olsen, Representative Hal Morton and Local President Russell Haggan.

2



18

SERVICE TO THE BROTHERHOOD

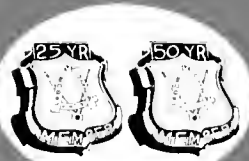

A gallery of pictures showing some of the senior members of the Brotherhood who recently received 25-year or 50-year service pins.



1B

(2) MORTON, WASH.—Twenty-five year pins were presented to six members on February 26 at the office of Local 2767 in Morton by Wes Johnson, secretary of the Puget Sound District Council. Sixteen members were eligible to receive their pins but were unable to attend due to the bad weather.

Those receiving their pins are pictured, left to right. In the front row: Paul Reed, Henry Stiltner, Edward Dunaway; back row left to right: Roy Percy, Ray Reed, John Rosenquist and Les Johnson, who presented the pins. Members eligible to receive their pins but not present were: A. R. Alderman, Albert Bangs, William Beckman, Robert Games, B. G. Hardy, Franklin Klassy, Cecil Rhoades, Yngve Soderlind, Tom Stamper and Ivan Stout.

Construction Worker Not Causing Inflation, General Secretary Assures University Seminar

■ "The average wage rate of a worker matters little, if he's not working."

This comment was expressed by Richard E. Livingston, General Secretary of the United Brotherhood of Carpenters and Joiners of America, at a recent day-long seminar held at Niagara University in Niagara Falls, N.Y. Under the title "The Challenges of the 70's," the program afforded representatives of labor, management, government, and public employee organizations the opportunity to come together and to exchange viewpoints concerning the future of collective bargaining.

Livingston's comments were particularly directed towards the present state of bargaining in the construction industry. He said, in essence, that the construction worker is tired of being cast as the villain in America's inflation problems. As he expressed it, "working an average of less than 1400 hours a year—and in many localities only 800 hours a year—at the average \$6.39 an hour paid to union building tradesmen, as reported by the Bureau of Labor Statistics last February, surely does not represent much of a chance for the construction worker to cause inflation."

The General Secretary acknowledged that there have been some excesses in wage settlements in the construction industry. However he emphasized that these large wage increases have been awarded

to only a fraction of all construction workers.

"To be quite blunt about it," Livingston summarized, "construction wage settlements in 1969 failed to meet the \$10,933 annual income which the Federal government has determined as a moderate budget for an urban family of four."

Gerald A. Brown of Washington, D.C., a member of the National Labor Relations Board and another seminar speaker, commented on what he foresees as a "merger of labor unions comparable to that taking place in the industrial community, resulting in more multi-plant, multi-employer, and industry-wide bargaining." Noting the rising number of company mergers and conglomerates, Brown pointed out that "the structure of labor unions has always been a derivative of the structure of industry, which is a product largely of technology."

Representing the views of management at the seminar was Eric Jensen of New York City, vice-president for industrial relations of ACF Industries, Inc. Jensen stated that the collective bargaining sys-



Livingston

tem is now on trial, threatened by the frustrations of unemployment and inflation, and by the increase of strikes which produce higher and higher settlements. For the system to survive in the 70's, he feels, it will have to undergo many changes.

According to John A. Fillion of Detroit, associate general counsel of the United Auto Workers and another of the program's labor representatives, the 1970's hold three challenges for industrial bargaining. Unions, he feels, will have to recognize their responsibility to give fair representation to their members; solutions will have to be found to the "non-life" of work on mass-production lines; and avenues will have to be discovered to convert our nation to a peacetime economy.

The seminar's two other main speakers were Kenneth E. Moffett of Washington, special assistant to the director of the Federal Mediation and Conciliation Service, and Dr. R. D. Helsby of Albany, N.Y., chairman of the State Public Employment Relations Board. Moffett felt that new pressures such as inflation, race, poverty, unemployment, and environment will have a great influence at the bargaining tables in the 1970's. Helsby stressed that increasing emphasis in bargaining must be placed on the acceptance by both parties of the responsibility for reaching an agreement with minimal outside assistance.

The Niagara University seminar was jointly sponsored by the university, the Industrial Relations Research Association of Western New York, the Federal Mediation and Conciliation Service, and the State Public Employment Relations Board. ■

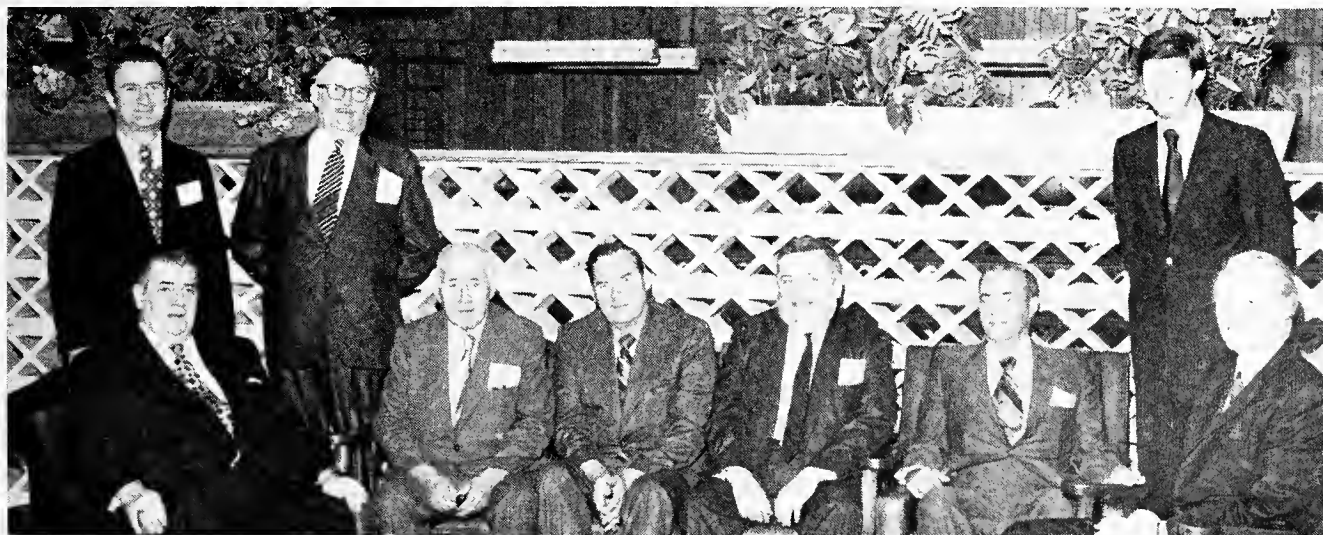

General Secretary Richard E. Livingston, seated left, with other seminar leaders, from left, seated, they include: Frank H. Brown, regional director of Federal Mediation and Conciliation Service; Dr. Robert Helsby, chairman of the New York State Public Employment Relations Board; Charles C. Hillegas, Dean of the College of Business Administration, Niagara University; Honorable Gerald A. Brown, Member of National Labor Relations Board; Eric F. Jensen, vice president, Industrial Relations of ACF Industries, Incorporated. Standing, left to right: John A. Fillion, associate general counsel of International Union of United Automobile, Aerospace and Agricultural Implement Workers; Nelson Duerr, president of Industrial Relations Research Association for Western New York; and Kenneth Moffett, special assistant to the director, Federal Mediation and Conciliation Service.

**When we couldn't get the
kind of wood we needed for
Lufkin rules, we grew our
own trees.**



That's because in our business you can't take chances on quality or accuracy. We even weave our own cloth tapes for the same reason.

And, knowing the beating a long tape has to take out in the field under many different conditions, we created our famous chrome tapes. They last at least four times as long as the regular white tapes.



The almost indestructible Chrome Clad® long tape

(Incidentally, we make a white tape that's also long-lasting because it's coated with epoxy.)

We've been in this measuring business for over 100 years and we're still proud of our newest developments. The Lufkin power tape which we call the Mezurlok® has a special lock that prevents the tape from creeping. And we built in a patented rubber bumper so the end-hook won't snap off when you return the tape into the case.

We're always working on something new or trying to solve a special problem. That's why we can safely say that whatever your measuring requirement might be, Lufkin has the perfect solution.



Our Mezurlok® beats the creeps

The Cooper Group

CRESCENT • KEN-TOOL • LUFKIN • WELLER



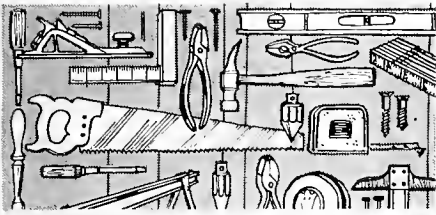

LOCAL UNION NEWS

St. Louis Carpenters Complete Rigging of Santa Maria Replica

Scoring another "first" in St. Louis, four members of the city's Carpenters District Council provided the expertise to complete the rigging of the replica of **The Santa Maria**, the famous sailing ship of Columbus, now moored on the St. Louis waterfront. Ollie W. Langhorst, executive secretary-treasurer of the district council, announced that carpenters, aided by a helicopter, which provided the power rigging, quickly and efficiently braced the 20-foot top mast in place above the crow's nest, 80 feet above the ship's deck. The event signified the first time in which this particular form of power rigging has been used in St. Louis.

The carpenters who performed the task are employees of Parks Engineering and Construction Company. Parks supervised the erection of the mast, the placement of an 1800-pound rudder onto the ship's deck, and the movement of two one-ton anchors to the top of the levee adjacent to the Santa Maria's sign. The helicopter, donated for the hour-long task by St. Louis Helicopter Airways, Inc., was used to move all the items. **The Santa Maria** is one of six ships available for touring on the St. Louis Riverfront.

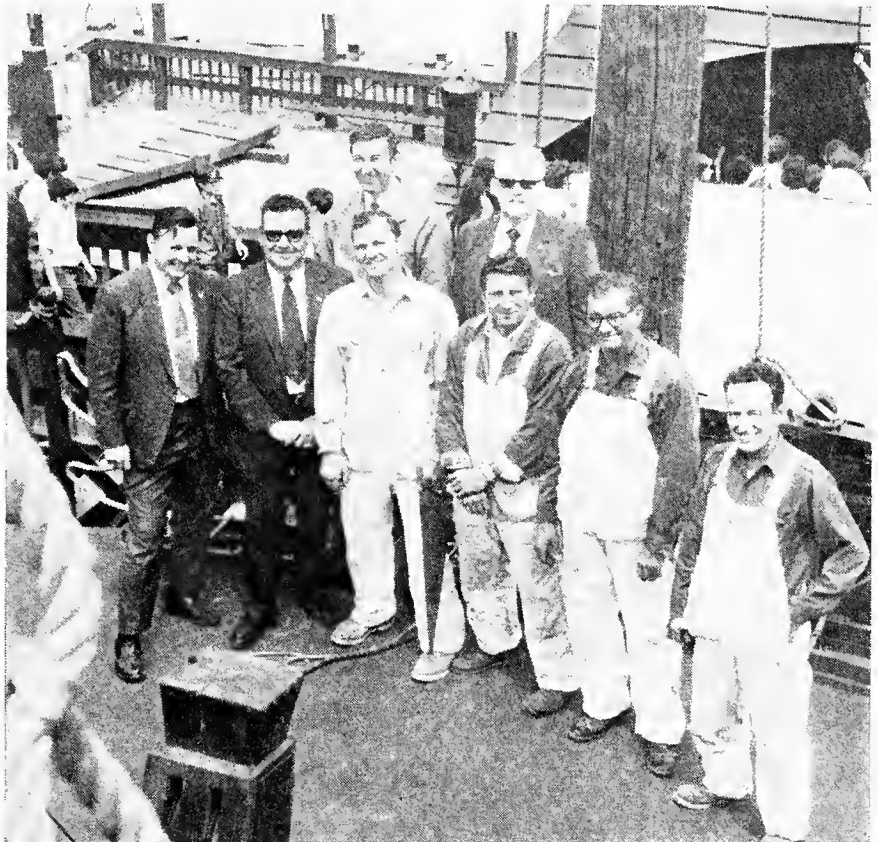

The Carpenter experts who accomplished the job: Front row, from left, Business Representatives Bill Fields and Larry Daniels, John Miller (Local 2119), Don McAllister (Local 602), Foreman Clarence Miller (Local 1739), and Vernon Madden (Local 47). Back row: Clark Parks, Parks Engineering and Construction Co.; and Pleasant Jenkins, Council Director of Jurisdictional Research.



A carpenter nails braces to hold down the top mast, as the helicopter which lifted the mast in place hovers overhead.

Local 2514 Members Take Service Course

On June 2, 1971, Herman E. L. Hunt, Bruce E. Childs, John H. Hollomand, Cecil A. Bell, and Billy G. Bynum, all of Local 2514, Chesapeake, Va., graduated in the Community Services Counsellors Course of the Old Dominion University. The course, sponsored by the Norfolk Union Labor Council, the Health-Welfare-Recreation Planning Council, and the United Communities Fund, is designed to acquaint concerned individuals in the field of organized labor with methods for making their communities better places in which to live.



Graduates in the Community Services Counsellors Course of the Old Dominion University include, from left, John H. Hollomand, Bruce E. Childs, and Herman E. L. Hunt. All are members of Local 2514, Chesapeake, Virginia.



Pictured with 25-year pin recipients are, seated from left, Chris Jensen, First Gen. V.P. William Sidell, and District Council Secretary Gordon McCulloch. The list of 25-year pin honorees of Local 1506 includes Wm. J. Amos, C. W. Barnett, Albert Barrett, Raymond G. Berg, Wm. Bodinar, Frank Bruck, Lue Burnett, K. A. Bushman, George Byssing, Elmer J. Campbell, Ray Carpenter, Douglas Coffin, D. B. Deaton, H. J. DeVilbiss, Ralph Fivelstad, Harold Fountain, Lee Garrecht, Daniel Gillespie, James H. Gilliam, Nelson Gravelin, Benj. Graves, Sr.; Roy Hamilton, George Hisel, Frank Johnston, Daniel Jordan, Norman Kelley, Everett Kelley, Robert Luley, Bill McCormick, Thurman Manns, William Midgett, Russell Mullins, Walter Newman, Stan Norton, Paul Ogaz, Forrest Ottman, Joseph Ozuna, Carmen Pagano, Ray Paterson, Clarence Philippi, Toney Pyle, Emmitt Ramsey, Ray Redmond, Ray Rice, James Rowan, Kenneth Sand, Theo. Settanni, Sam Sivigliano, Richard Spicer, Clyde St. Amant, Virgil Stearman, George Stoner, V. L. Stults, Guy Weaver, Fred Warren, Billy Wilson, George Witt, Joseph Woods, and Ray Yeomans.

Local 1506 Celebrates 20th Anniversary

On the evening of May 22, 1971, Local 1506 held a three-fold celebration, attended by 250 members and their guests. One of the reasons for the festivities was Local 1506's celebration of the 20th anniversary since the issuance of its charter. The charter was originally issued on April 15, 1951. In the relatively short amount of time which has elapsed, Local 1506 has grown from its original 152 charter members to its present size of 2,200 members. Today, it has jurisdiction within Los Angeles County over the areas of drywall, accoustical tile, insulation, weatherstripping, and scaffold building.

A second reason for celebration was the opening of the new hall and offices of Local 1506, which were occupied on

April 1, 1971. The building, purchased from sister Local 946, had undergone extensive remodeling. Local 1506 occupies the second floor of the building which has facilities for business representatives, the financial office, and a meeting hall with a room capacity of 275.

Finally, included in the affair was the presentation of 25-year pins to 42 recipients. The awards were presented by William Sidell, first general vice-president of the United Brotherhood of Carpenters, and by Gordon McCulloch, secretary-treasurer of the Los Angeles District Council of Carpenters. Sidell and McCulloch also acted as the evening's special guest speakers.

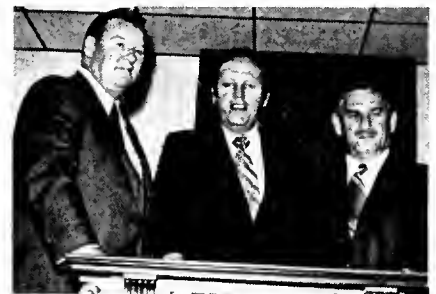

Presiding at Local 1506's recent celebration were, from left, Gordon A. McCulloch, secretary-treasurer of the Los Angeles District Council of Carpenters; Chris Jensen, president and business representative of Local 1506; and William Sidell, First General Vice-President of the United Brotherhood of Carpenters.

Local 608, New York, is Honored for Immigration Efforts



Carpenter's Local 608, New York, recently joined with numerous national, state and local unions in honoring Congressman William F. Ryan, D-N.Y., for his outstanding efforts to secure a fair immigration law for all nationalities. The Congressman was presented a special plaque in recognition of his work. At the presentation, left to right: Paul Sullivan, business representative; Michael Keane, dinner chairman; Congressman Ryan; John J. O'Connor, president, business representative and chairman of labor committee, making the presentation, and Pascual McGuiness, financial secretary.

Local 483 Sponsors Senior-Citizen Units

Rotary Plaza
SENIOR CITIZENS
RETIREMENT CENTER

SPONSORS: SO. S. F. ROTARY CLUB
LOCAL 483 CARPENTERS

ARCHITECT: MARKLING & YAMASAKI, INC.

STRUCT. ENG: RENAN DOMINGUES

COORDINATOR: E. M. SCHAFFRAN & CO.

CONTR.: CHALLENGE DEVELOPMENT, INC.

FARGO BANK BRENTWOOD BRANCH

Construction has begun on a \$3½ million, 180-unit senior citizen retirement center in South San Francisco. Sponsored jointly by Carpenters Local 483 and the South San Francisco Rotary Club. The project is one of seven being sponsored by Carpenter affiliates in California and is representative of the excellent community relations work going on in that state. Standing in the foreground, from left are Ray Scheffel, business representative of Local 483; Ray Winther, district governor of the Rotary Club; and William Meehan, director of the South San Francisco Rotary Club. A. A. Figone, president of Local 483 and executive secretary of Bay Counties District Council of Carpenters, is also shown as he adds finishing touches.

Local 1098 Pension Recipients Honored

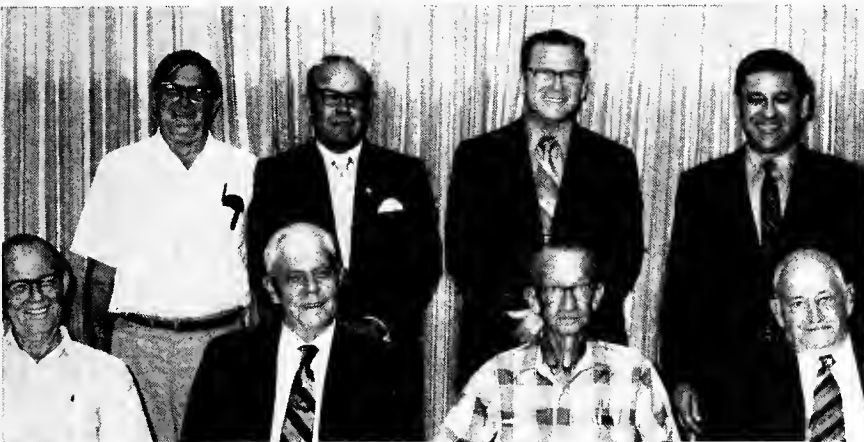

Six members of Local 1098 of Baton Rouge, La., qualified for the first pension checks issued under its newly-established pension trust program. The benefits provided are financed entirely from employer contributions made on the union member's behalf. Shown here, seated from left, are Elliott Jerome McGraw, 25 years service; Carey Otis Montgomery, 25 years service; Franklin Eugene Thornton, 10 years service; and Charles William Hutchinson, 17 years service. Standing, from left, are James Edward Adams, 31 years service; E. J. Ardoin, union trustee; Johnny Hodges, union trustee; and W. J. Spano, employer trustee. Not present was Russell M. Atkinson, 30 years service.

AUDEL CARPENTERS & BUILDERS LIBRARY



4 vols.
\$18.50

THESE "PAPER TOOLS" can boost your income!

Their 1,488 pages of practical information and how-to guidance are invaluable "tools" for all in the building trades... a complete course for the apprentice, a ready reference for master workers.

Thousands of photos, diagrams and charts tell and show short cuts, new methods, solutions and money-saving ideas... how to use every tool and building aid... how to build everything from furniture to houses... how to frame, roof, excavate, do carpenter arithmetic, estimate costs, trim, insulate, care for tools, etc. They can help you earn more, fast.

MONEY BACK GUARANTEE—You must be completely satisfied with the Audel Guides you order, or you may return them within 10 days and get your money back.

SEND COUPON TODAY

Theodore Audel & Co., 4300 West 62nd St. C-081
Indianapolis, Indiana 46268

Please mail me Carpenters and Builders Library, 4 vols. I agree to mail \$3 in 10 days and to mail ½ the total purchase price 30 days later, with the balance plus shipping costs to be mailed within another 30 days. If I am not completely satisfied I may return the books for refund.

Name _____

Address _____

City _____ State _____ Zip _____

Save shipping costs. Enclose \$18.50 (plus sales tax, if any) and we pay postage.

Made to put in a hard day's work

*Designed by Carpenters
Especially for Carpenters*

There's plenty of comfort, convenience and work-saving features in these overalls. Made just like you want 'em... because they're designed by workers like yourself. Guaranteed to be the best you've ever worn or we'll take 'em back. No questions asked.

Lee® UNION MADE
M.R. CARPENTERS'
OVERALLS

H. D. LEE COMPANY, INC.
SHAWNEE MISSION, KANSAS 66201
"World's largest manufacturer of union-made work clothes."



French Carpentry In The Altogether

In Toulouse, France, 14 union carpenters, hired to construct a group of attractive cabins, a recreation hall and a dining room at a beautiful summer resort, arrived on the scene and discovered it was a nudist camp. That didn't bother them the least—until they were informed that the resort rules would require them to do their carpentry in the altogether. One carpenter protested. He was the roofer, and if he had to work naked, where, he demanded to know, would he carry the nails for the shingles? After lengthy debate and threats of a union walk-off, a compromise was reached. The roofer could wear an apron with little pockets for the nails. But the apron would have to be plastic—transparent plastic!



Presentation of the George Burger Traveling Trophy, which is presented to the joint apprenticeship committee of Michigan sponsoring the winning carpentry participant. Left to right, Tyler Jenkins of the Flint Joint Apprenticeship Committee; Dennis Castles, of Flint Local #1373, winner of the 6th Annual Contest; Keith Clinton, secretary-treasurer of the Southwestern Michigan Carpenters District Council and master of ceremonies for the awards banquet; and Ray Cebalt, president of the Michigan State Carpenters' Council.

TOOL TALK by 3. Jones

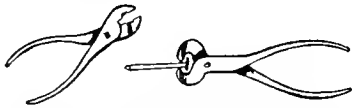

Melvin, stop biting your nails.

Vancouver Rest Home Supported by Local 452



Knut Peterson of Local 452, Vancouver, B. C., left, above, chairman of the Swedish Canadian Rest Home situated in North Burnaby, a suburb of Vancouver. He is shown here with Carl Erickson, financial secretary of Local 452, one of the directors of the Home. Retired members of the Brotherhood on the board of directors are Eric Matson, John Leander and Arvid Anderson. Former member Andy Juvelyn is a guest at the Home, which has been in operation for 24 years, and which has been supported by Local 452 for many years.

NEW, TOUGH AND DESIGNED

ROLLED EDGES FOR MAXIMUM STRENGTH AND SAFETY

HEAVY-DUTY LID SUPPORTS WORK WITH ONE HAND

SLIDING TRAY WITH MOVEABLE PARTITIONS

OVERLAPPING EDGES AND RAIN GUTTER

FULL LENGTH HIDDEN PIANO HINGES

END COMPARTMENT FOR SMALL ITEMS

WEATHERGUARD CROSS BOXES

Four sizes—9 cu. ft. to 18 cu. ft.—answer every need for on-truck storage and protection of tools, equipment and material.

MODELS UP TO 18 CU. FT. OF STORAGE

\$125.00-
\$160.00



weather guard®

OVERHEAD RACK • Transportation of ladders and extra-long material is an easy assignment with the Weatherguard overhead rack.

Pair
\$175.00-\$205.00

WEATHERGUARD SIDE BOXES

Big capacity, tough design. Use alone or in combination with cross boxes. Two models.

WRITE FOR FREE 1971 WEATHERGUARD CATALOG
Wholesale inquiries invited. Prices above are F.O.B.
KNAACK® MANUFACTURING COMPANY
420 E. Terra Cotta Ave., Crystal Lake, Ill. 60014
815/459-6020 \$145.00





"We Congratulate..."

... those members of our Brotherhood who, in recent weeks, have been named or elected to public offices, have won awards, or who have, in other ways, "stood out from the crowd." This month, our editorial hat is off to the following:

WEST POINT CHAMP—The 1971 graduating class at West Point included Cadet Captain and Brigade Athletic Officer Patrick Dennis McDonald, light heavyweight boxing champion at the military academy for four years and the son of Patrick McDonald, business representative of the Los Angeles County District Council of Carpenters.

Young Pat, now a second lieutenant in the US Army, was a 1967 graduate of Redondo Beach High School in California. He was an Eagle Scout at 14 and has maintained his interest in scouting an avocation which permitted him to spar recently with World Heavyweight Champion Joe Frazier (see photo).

As president of the West Point Cadet Scoutmasters Council, Pat represented the Point at the National Explorer Olympics, held at Ft. Collins, Colo., last year. Frazier was one of several sports celebrities attending the Olympics.

McDonald describes his first meeting with the champ: "My first impression of Joe was physical. I was taken aback by his size, for I had figured him to be much taller than 6'1". What he may lack in height, Joe more than makes up in

breadth. He is powerfully built, with tree trunks for legs and a pair of arms that would make any shotputter jealous.

"After talking with the champ for a few moments, I felt quite at ease. Here



McDonald

is a guy who is world famous and yet, from his big smile and his hip lingo, you knew that he wanted to be treated like one of the guys . . ."

A public relations man for the Olympics asked Cadet McDonald if he'd like to drive Frazier around the next day and act as his escort for the awards presentations.

"Needless to say, I jumped at it," says Pat.

He questioned the champ as to how he would do against Muhammed Ali.

"All he said as he slowly clenched his fists was, 'I've got something for that man!' After reviewing the results of their encounter, it was plain to see what he meant."

SCHOLARSHIP WINNER—James Wicks has been selected as the 1971 winner of the \$500 scholarship awarded

to a son or daughter of a member by Local 1772, Hicksville, N.Y. In the fall, James plans to attend Hobart College in Geneva, N.Y. He is a graduate of St. Dominick's School in Oyster Bay, N.Y., where he resides with his mother and father, Henry Wicks.



Wicks



SHOW WINNER—Jack Baler, standing beside his wife and son, above, had the winning ticket in a drawing for a piano at the recent AFL-CIO Union Industries Show at Atlanta, Ga. Baler is a member of Millwrights Local 1263. The Balers are shown with Howard McVey, exhibit coordinator for the Hotel and Restaurant Employees and Bartenders International Union, which sponsored the drawing.



OUTSTANDING TEENAGER—Vanola V. Kennedy, daughter of John G. Kennedy of Local 1281, Anchorage, Alaska, has been selected as Alaska's Outstanding Teenager. Miss Kennedy, 18, was presented with her award by Governor William A. Egan at graduation ceremonies of Wasilla High School. Miss Kennedy displays the trophy, above. On her left is her father, John G. Kennedy. On her right is Ben I. Perkins, financial secretary of Local 1281.

ON COMPULSORY ARBITRATION—*"Compulsory arbitration of labor disputes destroys the principles of bargaining for both employers and workers, which the voluntary system accepts and, in a measure, guarantees. By the compulsory methods, neither employers nor workers have any right in the selection of an arbitrator."*—The Carpenter, July 1921



World heavyweight boxing champion Joe Frazier spars with Pat McDonald, son of Los Angeles Business Representative Patrick McDonald.

APPRENTICESHIP & TRAINING



Arizona Honors Graduate Apprentices and '71 Contest Winners

A Phoenix, Arizona, shopping center was recently transformed into a "construction site" on the occasion of the annual Arizona Carpenters Apprentice Contest. Under the careful scrutiny of a panel of judges and before a crowd of curious spectators, four carpenters and two millwrights demonstrated their proficiency. The carpenters were each assigned the task of building a child's playhouse. The millwrights were required to drill and tap a 12-inch width channel in order to mount a motor/base unit.

Archie Ferguson of Local 1216, Mesa, was selected as the winning contestant in the carpenter competition. He was presented with the "Cliff Maddox Award" by the Arizona chapter of the Associated General Contractors and with a "Golden Hammer of Merit" award. Norman Larson of Local 1914, Phoenix, was judged the winning millwright. He was presented with a "Golden Hammer of Merit" award and also with the "Jesco Award." The latter honor was originated this year by the Jesco Company, millwright contractors.

Ben Collins, general representative of the United Brotherhood of Carpenters and Joiners and one of the coordinators of the days activities, presented journeymen certificates to the graduating apprentices. Perhaps the happiest people of the entire day, however, were the patients of the Samuel Gompers' Memorial Children's Clinic, who were presented with three of the four playhouses. The fourth playhouse was awarded to a spectator in a raffle.



Graduating Apprentices, seated, left to right, Norman B. Larson, Millwright Local 1914, Phoenix; Dale A. Harvey, Local 1914; Danny M. Slaysman, Carpenters Local 906, Glendale; John A. Reynolds, Local 1216, Mesa; Brian F. Abel, Local 1089, Phoenix; Larry M. Clark, Local 1089; Bryan L. Barnes, Local 906. Standing, left to right, Michael J. Kelley, Local 906; Jimmie R. Draper, Local 1583, Miami; Arthur D. Guerra, Local 1089; Tony R. Valenzuela, Local 906; Charles P. Hernandez, Local 906; Gary W. John, Local 1089; John D. May, Local 1089; Robert L. Davis, Local 1089; Eugene S. Burks, Local 1089; Archie L. Ferguson, Local 1216; Bernard L. Garrison, Local 1089; Terry R. Grant, Local 1089; George A. Balandran, Local 1089; Not pictured: Ricky L. Kennedy, Dennis R. Laffredi, Nolberto M. Ortega, Jr., Local 1089, and Thomas W. Nugent, Local 906.



Standing, left to right, Carpentry judges; E. J. Wasielewski, Jr., contractor; Dean Glasco, architect; Robert Knox, carpenter, member of State Compensation Fund. Millwright Judges, William R. McKinley, millwright; Dwight Vencill, millwright; Don Keatts, ELT Construction Company. Seated, Carpentry contestants, John W. Craven, Local 857, Tucson; Russell B. Griffin, Local 857; Archie L. Ferguson, Local 1216, Mesa; Bryan L. Barnes, Local 906, Glendale; Norman B. Larson, Millwright Local 1214, Phoenix; Dale A. Harvey, Local 1214.

1971 New Jersey Apprentice Competition

The Third Annual New Jersey Carpenters Apprentice Training and Educational Contest was held on June 5 and 12, 1971, at the Bergen County Vocational-Technical High School in Hackensack, N.J. A total of 17 graduating apprentices from throughout the state competed in carpentry, millwright, and mill-cabinet contests.

Each contestant, completing his fourth year of apprentice training and a member of one of the state's locals, participated in a four-hour written test and in an eight-hour manipulative project. The projects consisted of stud-framing, door-hanging, the setting and lining of shafts, or cabinet-building.

At awards presentation ceremonies at the Bergen County Vocational-Technical High School, the winners in each of the three categories were presented with \$100 savings bonds and with sets of tools. Second and third place finishers were presented with \$50 and \$25 savings bonds, respectively, and with sets of tools.

Contestants participating in the competition included Edward Solomon, Local 1743, Wildwood, winner in the carpentry contest; Conrad Elkin, Local 2315, Jersey City, winner in millwright; John Malloy, Local 455, Somerville, winner in mill-cabinet; Robert Corby, Local 2250, Red Bank, second-place finisher in carpentry; Nicholas Marsicano, Local 455, Somerville, second place in millwright; Frank Falinus, Local 715, Elizabeth, second place in mill-cabinet; Gerald Bounach, Local 781, Princeton, third-place finisher in carpentry; Thomas Soltis, Local 715, Elizabeth, third place in millwright; Charles Crawbuck, Local 1489, Burlington; Paul Kusic, Local 1006, New Brunswick; Michael Daly, Local 393, Camden; David Zamara, Local 620, Madison; Robert Booraem, Local 2018, Ocean County; Michael Polsky, Local 155, Plainfield; Michael Motyleski, Local 564, Jersey City; Andrew Nowakowski, Local 2018, Ocean County; and John Carroll, Local 1006, New Brunswick.

THE 1971 CONTEST

The 1971 Carpenters International Apprenticeship Contest will be held in Detroit, Michigan, August 12, 13, and 14. Every state and province should be represented by carpenter, millwright, and mill-cabinet contestants.



Winners in the New Jersey Apprenticeship Contest were (kneeling, from left) John Malloy of Local 455, Somerville, for mill-cabinet; Edward Solomon of Local 1743, Wildwood, for carpentry; and Conrad Elkin of Local 2315, Jersey City, for millwright. Seen with the winners are (standing, from left) Robert Ohlweiler, General Representative; Russell Hugus, apprentice coordinator of the West Virginia District Council of Carpenters; Bernard Johnson, secretary of Local 15, Hackensack; Paul Brienza, managing director of the Building Contractors Association of New Jersey; Nicholas Loope, apprentice director of the Washington, D.C., area; Joseph J. D'Aries, director of the New Jersey Carpenters Apprentice Training and Educational Fund, Springfield, N.J.; and Raleigh Rajoppi, General Executive Board Member.



Participants in the New Jersey apprenticeship contest included, from left, John Schuler, education director of the Building Contractors Association of N.J.; John Ambrose of Ambrose Construction; Sigurd Lucassen, business representative of Local 2250, Red Bank; Robert Corby of Local 2250, Red Bank, second-place winner for carpentry; Samuel Barratt, business representative of Local 455, Somerville; Nicholas Marsicano of Local 455, Somerville, second-place winner for millwright; Frank King, state supervisor of the Bureau of Apprenticeship and Training, U.S. Department of Labor; and Joseph J. D'Aries, director of the New Jersey Carpenters Apprentice Training and Educational Fund, Springfield. Not shown is Frank Folinus of Local 715, Elizabeth, the second-place winner for mill-cabinet.



Third-place winners in the New Jersey apprenticeship contest were (kneeling, from left) Gerald Bannach of Local 781, Princeton, for carpentry, and Thomas Soltis of Local 715, Elizabeth, for millwright. Seen with them are (standing, from left) Sigurd Lucassen, bus. rep. of Local 2250, Red Bank; Joseph J. D'Aries, director of the N.J. Carpenters Apprentice Training and Educational Fund, Springfield; Frank Krajacich, bus. rep. of Local 2018, Ocean County; James Wilson, Apprentice Director of the Bergen County Vocational-Technical High School, Hackensack; Bernard Johnson, secretary of Local 15, Hackensack; Wallace Whitford, bus. rep. of Local 399, Phillipsburg; and Fred Nusbaum, bus. rep. of Local 155, Plainfield.



Contestants and judges at the 6th Annual Michigan Carpentry Apprenticeship Contest, held May 24 and 25 at Kalamazoo. Standing, left to right, George Millsap, millwright field judge and member of Millwright Joint Apprenticeship Committee of Detroit; Leonard Mandeville, millwright field judge and chief engineer of Argonaut Realty Division of General Motors of Detroit; John De'Bona, millwright field judge and president of De'Bona Construction Company of Novi; Kenneth Perry, millwright, Local 1102, Detroit; Salvatore Spano, millwright, Local 1102, Detroit; James Wright, millwright, Local 1102, Detroit; Richard Elkins, millwright, Local 1102, Detroit; Alfred Schack, carpenter, Local 998, Royal Oak; Tom Kett, carpenter, Local 512, Ann Arbor; Philip Moore, carpenter, Local 335, Grand Rapids; John Kalleward, carpenter, Local 297, Kalamazoo; Chris Magnusson, chief coordinating judge from Detroit; Wallace Wallington, carpenter, Local 674, Mt. Clemens; Jerry VandenBeldt, carpenter, Local 1908, Holland; Tyler Jenkins, assistant coordinating judge from Flint; John Steele, assistant coordinating judge from Benton Harbor; Don B. Smith, carpenter field judge and President of Don B. Smith, Inc. of Portage; Lewis Scarborough, carpenter field judge and business representative of Carpenters Local 871, Battle Creek; Marvin Thomas, carpenter field judge and project engineer of R. C. Byce and Associates of Kalamazoo.

Seated left to right, James Hegedus, carpenter, Local 19, Detroit; Armin Gollanek, carpenter, Local 26, Detroit; Dennis Castles, carpenter, Local 1373, Flint; Daniel Goldsworthy, carpenter, Local 871, Battle Creek; Douglas Sundman, carpenter, Local 898, St. Joseph; and Mark Dennis, carpenter, Local 982, Detroit.

For Extra Income, Here's Excellent Plan to Start Business of Your Own



Here's a proven practical way to earn extra dollars in spare time — to develop a money-making repair business of your own. Investment is small. There's no overhead, no stock of goods to carry. No experience needed, no canvassing. You do it with the famous Foley Saw Filer that automatically sharpens all kinds of saws — and the Modern Lawn Mower Sharpener that precision sharpens all types of mowers.

EARN \$3 to \$6 An Hour Sparetime

Hundreds of people like yourself are making cash like this — \$20 to \$30 a week — right now in spare time. "My spare time saw filing business has made me \$952 these first ten months" — says R. T. Chapman. Many have built a complete sharpening service with such year-around profits. You can too, simply by following the sure, easy Foley Plan.

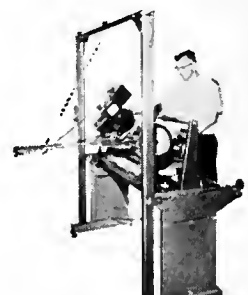

MANUFACTURING CO.
MINNEAPOLIS, MINN.

**GET FREE BOOK NOW
"MONEY MAKING FACTS"**
This valuable book shows you how to start, how to get business from home owners, factories, carpenters, etc., and how to make profits fast. Mail coupon today. No salesman will call.

FOLEY MFG. CO. 818-1 Foley Bldg., Minneapolis, Minn. 55418

- Saw Filer information. Lawn Mower Sharpener information. Money Making Facts booklet.

NAME _____
ADDRESS _____
CITY _____ STATE _____

New Orleans Picks Top Carpenter Apprentice, Selects Contest Queen

The fourth annual Carpentry Apprenticeship Contest of New Orleans, La., and vicinity was held on June 5. The contest, sponsored by the Associated General Contractors-Carpenters District Council of New Orleans Joint Apprenticeship and Training Program, was held in the enclosed mall of the Lakeside Shopping Center and was observed by at least 40,000 shoppers.

News coverage was provided by Channels 4, WWL-TV, and 6. WDSU-TV, which broadcast one and one-half minutes of film coverage each on both of their afternoon and evening local news programs that day.

The 20 carpentry contestants were honored and encouraged by the queen of the contest, Miss Mildred Relayson of New Orleans, who was selected from among the wives and sweethearts of the competing apprentices by a special panel of judges. The selection of a queen is an extra touch of glamour that the New Orleans, La. AGC-CDC-JATC and apprentices have added to the annual contest and plan to continue.

The winners were announced at an awards banquet on June 5 at La Charcuterie Restaurant in Metairie, La. They are: first place, Larry G. McHenry; second place, Albert J. Charbonnet; and third place, Robert S. Heaslip.

Miss Relayson presented the awards to the winners as they were announced and also a special award to the judges, who were: Ed. Holmes, construction superintendent, Fruin-Colnon Corporation; Roy Guderian of Spangenberg & Associates Architectural Firm; and W. J. "Red" Duplechin, a member of Local 1846. Larry G. McHenry competed in the Louisiana State Contest held on June 25-26 in Monroe.

Florida Winners

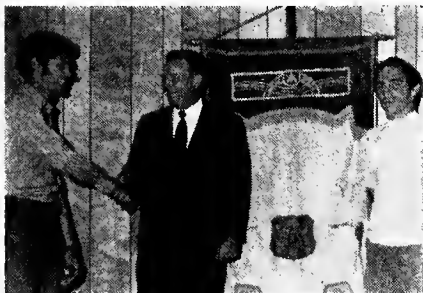

First place winner in the Miami, Fla., carpenter apprentice contest was James Bouchard of Local 1509. Following that victory, Bouchard went on to capture first place in the state apprenticeship contest held in Daytona Beach and, consequently, will compete in the national contest to be held in Detroit, Mich., August 14-16. Seen here congratulating Bouchard, left, and Rinaldo Ciuffertelli, second place finisher in the Miami contest and also a member of Local 1509, is International Representative John E. Sheppard.



The New Orleans Apprenticeship Queen, Miss Mildred Relayson, surrounded by carpentry winners and training leaders. Standing from left: Robert Heaslip, third place winner; Albert Charbonnet, second place winner; Larry McHenry, first place winner; D. P. Laborde, Sr., co-chairman of the JATC and executive secretary of the district council; Thomas J. Laborde, JATC coordinator; and John J. Wright, assistant JATC coordinator.



Participants in the New Orleans competition included, kneeling, left to right: Tony Pohlman, Richard Lusey, Carl Hammer, Ellis Fontenot, Ronald De Bautte and Alton Coleman. Standing, left to right: John A. Thomas, Barry Palmisano, Robert Heaslip, Charles Beck, Mitchell White, Paul Dichiaro, Frank Lombard, Joseph N. Breaux, Miss Mildred Relayson, queen of the competition, and Thomas Kinter, (Miss Relayson's suitor) Ronald Dufour, Michael Veade, Harold Zimmerman, Albert Charbonnet and Larry McHenry.

Local Winner

Dean Warner of Local 1808, left, Chairman of the apprenticeship contest for the Carpenters District Council of Madison County and Vicinity, Illinois, congratulates Thomas Thorp of Local 1808, who was the winner of this year's local contest.



Lil' Doll

**MOST ECONOMICAL WAY
TO MOVE MATERIAL AT
THE JOB-SITE**

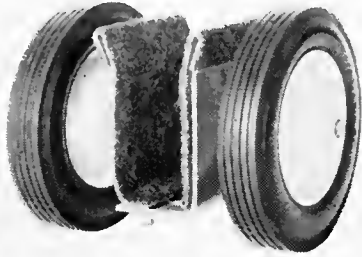

No more back-aches or sore muscles! Our Lil' Doll does all the work—a new idea for on the job transportation of materials. Doors, plywood sheets, counter tops and similar material up to 2-1/4" thick are easily rolled to the point of installation. A padded 3/16" steel carriage and 8" heavy duty ball bearing wheels give Lil' Doll the durability to carry 250 lbs. Lil' Doll easily maneuvers over electrical cords, screpwood and other debris found at job sites.



Stable enough to work on material without removal from carriage.



One man can do the work of two without tiring, wheeling material not lifting it.

SCHAEFER

MANUFACTURING
COMPANY

3022 West Scott Avenue McHenry, Illinois 60050

You'll Like Being a SKILLED LOCKSMITH



**You'll EARN MORE, LIVE BETTER
than Ever Before in Your Life**

You'll enjoy your work as a Locksmith because it is more fascinating than a hobby—and highly paid besides! You'll go on enjoying the fascinating work year after year, in good times or bad because you'll be the man in demand in an evergrowing field offering big pay jobs, big profits as your own boss. What more could you ask!

**Train at Home—Earn Extra \$\$\$\$
Right Away!**

All this can be yours **FAST** regardless of age, education, minor physical handicaps. Job enjoyment and earnings begin **AT ONCE** as you quickly, easily learn to **CASH IN** on all kinds of locksmithing jobs. All keys, locks, parts, jacks, special tools and equipment come with the course at no extra charge. Licensed experts guide you to success.

**Illustrated Book, Sample Lesson
Pages FREE**

Locksmithing Institute graduates now earning, enjoying life more everywhere. You can, too. Coupon brings exciting facts from only school of its kind. Lic. by N. J. State Dept. of Ed., Accredited Member, Natl. Home Study Council. Approved for Veteran Training.

LOCKSMITHING INSTITUTE
Div. of Technical Home Study Schools
Dept. 1118-081 Little Falls, N. J. 07424

Earned
\$150
During
Training

I realized with
LOCKSMITHING I'd be able
to double my income. During
my training period I made \$130.
Paul Funes
New York, N. Y.



LOCKSMITHING INSTITUTE, Dept. 1118-081
Little Falls, New Jersey 07424 Est. 1948

Please send **FREE** illustrated Book—"Your Big Opportunities in Locksmithing," complete Equipment folder and sample lesson pages—**FREE** of all obligation—(no salesman will call).

Name..... (Please Print)

Address.....

City..... State..... Zip.....

Check here if Eligible for Veteran Training

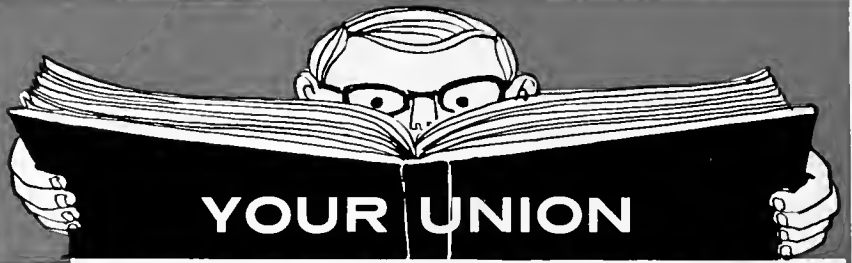

YOUR UNION DICTIONARY

This is the 6th of a new feature series planned to keep you better informed on the meaning of terms related to collective bargaining, union contracts, and union business. Follow it closely, and your union membership will become more meaningful, and your ability to participate in decisions which affect your future and security will be strengthened. It was compiled by the International Labor Press Assn, and is used with permission.

C

constructive discharge: Prejudicial treatment of a worker to force him to quit.

consumer picketing: Picketing of an establishment to persuade consumers to stop shopping there or to stop buying certain products or services.

Consumer Price Index: A monthly measurement by the Department of Labor's Bureau of Labor Statistics, which estimates changes in the average family's cost of living.

contract bar: Bar preventing a rival union from seeking a representation election during the life of the contract, unless otherwise ruled by the NLRB.

contributory pension plan: Sharing of the premium cost of a pension plan by both management and the employees.

cooling-off period: Suspension of a planned or announced strike in the hope the dispute can be settled during the term of suspension.

COPE: The AFL-CIO's Committee on Political Education.

cost of living adjustment: Periodic pay increase based on changes in Consumer Price Index, sometimes with a stated top limit.

cost-of-living-index: Popular term for the Consumer Price Index issued monthly by the U.S. Department of Labor.

Council of Economic Advisers: See full employment.

cross-check: Check by National Labor Relations Board (some state boards), of union authorization cards against employer payroll to determine whether union in fact has a majority. With employer's consent, such cross-check brings the union recognition and certification without formal hearing and an election. (See card check.)

covered employees: See bargaining unit.

covering letter: A letter from management to the union, stating understandings reached during contract negotiations, but not included in the contract itself.

CPI: Consumer Price Index.

craft union: A trade union which limits membership to persons holding some specific skill, i.e. electricians, plumbers, etc. Generally, the craft unions control apprenticeship training, and are termed "horizontal" in structure. Many traditional craft unions now also include industrial membership.

cutback: Layoff of employees caused by reduction in available work.

cyclical unemployment: Caused by fluctuations in the economy due to downward trend in business cycle. See seasonal, technological, frictional unemployment.

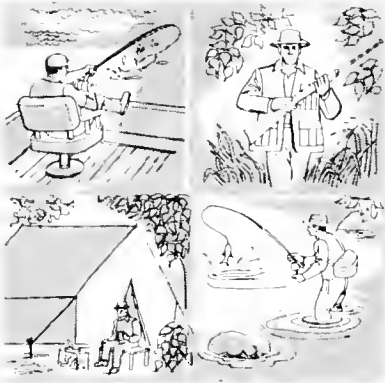

Outdoor Meanderings

Readers may write to
Fred Goetz
 2833 S. E. 33rd Place,
 Portland, Oregon 97202

According to recent letters from hunt fans, we've been skimping on tales and photographs in that department. This column, a rundown on past-season action by the membership and their families, seeks to rectify that impression.

■ Canadian Big Game

James R. Miller of Pico Rivera, Calif., a member of Local 1497, Los Angeles, promised himself that someday he would trek north to hunt for big game, really big stuff, and after recently acquiring a new Model 70 Winchester rifle, he figured the time had arrived.

He took off out of L.A. and wound up at Fort Nelson in northern British Columbia, then flew 85 miles north into the back country with Guide Gary Powell—and that's almost as far north as you can go in B.C. before crossing into the Yukon in the Northwest Territories. When he came back to California he had a cherished recollection of country which he describes as the most magnificent he's ever seen and two trophy heads from the big game he downed—a bull elk and moose. There's a photograph here of Brother Miller with one of his prizes.



Miller and moose

■ Muzzle Loader

One of the shiniest examples of wise game management in this country is that which has taken place in Pennsylvania in the last 30 years or so. After the deer herds had fallen off to a dangerous low in

1920, the seasons were closed and new hunting guidelines set after the herds were built up again. Now, heavily-populated Pennsylvania has one of the best deer herds in the nation and as long as only a modest portion is cropped by hunters each year, good deer hunting will prevail.

One hunter lad who appreciates the big game bounties of the Keystone State is Beryl D. Sink, a resident of Home, Pa., and a member of Local 811, New Bethlehem. His hunt proved successful and was doubly significant when he downed a 5-point whitetail with one clean shot from a muzzleloader which he made himself.

Hunters who cast a wary eye at the impact ability of the "ball," may be interested to learn that Brother Sink shot from less than 90 ft. The projectile struck true and continued clear through the rib cage, while the buck—which dressed out at 120 pounds—lay dispatched at about 65 yards from point of contact.

■ Price of Turkeys

Bernice Jones, wife of Bob Jones of Herndon, Va., a member of Local 132, says she didn't have to worry about the rising price of turkeys around the Thanksgiving holiday. Bob went to the nearby wildwoods and came home with a nice one, downed near Vances Cove, a wild one, of course.

■ Lucky Number 14

Fred Scherle of Joplin, Miss., a member of Local 311 for close to a quarter-century, gets his deer the hard way. This past season he downed No. 14, Largest he's ever taken—all have been downed via the archery route—was a 14-point specimen with a 22" spread which dressed out at 180 pounds. I guess "14" is your lucky number, Fred.

■ King-Size Elk Racks

Talk about your king-size elk racks, last year's big game hunting produced some big ones for O'Neal Burns of Post Falls, Idaho, a member of Local 98, Spokane, and his son Gerald. Brother Burns and Gerald follow the trail, stalking their game with patience and quiet-

ness. Total for the pair this past season was two elk—a six pointer which dressed out at 568 pounds; a five pointer and two mule deer bucks.

"If you think our hunting is great, you oughta try our fishing," suggests Burns.

■ "A Perfect Day"

Two Members of Local 275 at Waltham, Mass.—Eugene Boudreau and Arthur Le Blanc—wound up the migratory waterfowl season with what they consider "a perfect day;" and Mrs. Boudreau sends in graphic proof of why they felt that way. Depicted are Brothers Boudreau and Le Blanc with a pair of Canadian honkers, shot over their favorite hunting grounds, the Barnstable Marsh on Cape Cod.



Boudreau and Le Blanc

■ New York Pheasant

According to a note and a photograph from John G. Lindstrom, a member of the Brotherhood for 54 years, the pheasant season near his home out of Highland Mills, New York, was good. He says he got off to a good start and sends in the accompanying proof depicting himself with a nice pair of ringnecks downed the first day of the season.



Lindstrom and luck

■ Delay the Strike

In bottom fishing, whether it be mooching for salmon or other denizens of the saltchuck, bait angling for strippers,

worming for catfish or other bottom feeders, we've found it a good idea to delay the strike a bit. Let your finny adversary gulp the bait, then reef back with gusto to set the hook.

■ Salton Sea, Corvina

When R. J. Brady of Pomona, Calif., longtime member of Local 1752, gets a yen to go fishing, he goes, and it doesn't matter what time of year it is, for he heads southeast a couple of hundred miles across the southern portion of his home state for the fabulous Salton Sea where lunkers are caught the year around. Last junket to this great, man-made lake, which is 235 ft. below sea level, he boated a nice catch of corvina, a saltwater species which has adapted to the waters of this fish-lush body of water. Largest of the catch was a 15 pounder, caught on a live mudsucker off Bombay Beach along the lake's shore.

■ "Three Ace" Hand

Past president of Local 2256, White River, Vt., Calvin Ackerman, can lay claim to what is known as a "Three Ace" hand in deer hunter's jargon. Hunting with two sons, the Ackerman menfolk scored as follows: Michael got a 7-pt. buck which dressed out at 170 pounds; Peter, utilizing a doe permit, nailed a chunky specimen which dressed out at 130 pounds and dad nailed a 5-pointer dressing out at 155 pounds. This was a result of the 1969 deer season in Vermont. They took two days to score and we're anxious to learn how they made out this past season.



The Ackerman Party

■ "Deer Hunter's Aid"

Most hunters will tell you that the toughest part of the hunt, after the deer is downed, is getting it out of the woods and back to camp. One in particular being Harold W. Vaughn of Walton, Oregon, a member of the Lumber and Sawmill Workers Local 3091. In view of this, he has devised what he calls a "motorized deer-hunter's aid." On a past junket to the deep-canyon country of the Smith River, he and son Barry nailed a blacktailed buck apiece and with the aforementioned contrivance, which has a capacity of 200-ft. of 1/4-inch line and features a 4-hp, gas, air-cooled motor, pulled the bucks 1,800 feet up the canyon wall.



These
FREE BLUE PRINTS
have started thousands toward
BETTER PAY AND PROMOTION

That's right! In all fifty states, men who sent for these free blue prints are today enjoying big success as foremen, superintendents and building contractors. They've landed these higher-paying jobs because they learned to read blue prints and mastered the practical details of construction. Now CTC home-study training in building offers you the same money-making opportunity.

LEARN IN YOUR SPARE TIME

As you know, the ability to read blue prints completely and accurately determines to a great extent how far you can go in building. What's more, you can learn plan reading simply and easily with the Chicago Tech system of spare-time training in your own home. You also learn all phases of building, prepare yourself to run the job from start to finish.

CASH IN ON YOUR EXPERIENCE

For over 67 years, building tradesmen and beginners alike have won higher pay with the knowledge gained from Chicago Tech's program in blue print reading, estimating, foremanship and contracting. Through step-by-step instruction, using actual blue prints and real specifications of modern, up-to-date buildings, you get a practical working knowledge of every building detail—a thorough understanding of every craft. And as a carpenter or apprentice, you already have valuable experience that may let you move up to foreman even before you complete your training.

Don't waste a single day. Start preparing right now to take over a better job, increase your paycheck and command greater respect as the "boss" on the job. Find out about Chicago Tech's free-ahead training in building. Send for your free blue prints and trial lesson—today! Approved for Veterans.

CHICAGO TECHNICAL COLLEGE

K-143 TECH BLDG., 2000 S. MICHIGAN AVE., CHICAGO, ILL. 60616

FREE
BLUE PRINTS
AND
TRIAL LESSON

Send for your free trial lesson now. You'll agree that this training is simple yet practical—your surest way to promotion and increased income in building.

MAIL COUPON TODAY

Chicago Technical College
 K-143 Tech Bldg., 2000 S. Michigan
 Chicago, Illinois 60616

New G.I. Bill!
 Vets check here

Please mail me Free Trial Lesson, Blueprints and Catalog.

Name _____ Age _____

Address _____

City _____ State _____ Zip _____

Occupation _____

Accredited Member National Home Study Council



REPORT

Let Your Voice Be Heard on Trade Policies

■ Last month, the AFL-CIO sponsored a Conference on Jobs at the Statler-Hilton in Washington.

The purpose of the conference was to assess the rapidly deteriorating economic situation.

The main thrust of the conference was to hammer out a program capable of getting people back to work.

After a plenary session, the conference was broken down into four discussion groups, each charged with responsibility for delving into one or more of the factors which are responsible for the continuing increase in unemployment.

When these work sections reported back to the general conference, it was clear that foreign imports are one of the major causes of the current deterioration in the job picture.

American corporations, using American capital, armed with American technology, are invading all parts of the world where cheap labor can be found. These industrial giants build factories and manufacture their products in low-wage countries and ship most of them back to the United States and Canada. Because of tax loopholes, they can juggle the profits they make abroad so that they pay little or no taxes at all on those profits.

In addition to the capital and know-how they export to their foreign factories, they export the jobs of U.S. and Canadian workers.

From all of this, it is impossible to escape the conclusion that the answer to more jobs for our work-

ers is political action. The Administration and the Congress determine what our trade policies should be. The only way that bad trade policies can be changed is by electing to office, both in the White House and on Capitol Hill, men who appreciate that a decent job is the birthright of every citizen.



The following contributions were received since the report published in last month's issue of the magazine:

Local	State	Amount
ALASKA		
1281	Anchorage	\$ 100.00
ARIZONA		
1153	Yuma	42.60
CALIFORNIA		
483	San Francisco	121.50
COLORADO		
1396	Golden	20.00
DISTRICT OF COLUMBIA		
1694	Washington, D.C.	28.50
FLORIDA		
1379	N. Miami	44.00
2340	Bradenton	7.00
IDAHO		
1482	Grangeville	5.00
ILLINOIS		
62	Chicago	10.00
272	Chicago Heights	17.00
839	Des Plaines	134.00
999	Mt. Vernon	14.00
1092	Marseilles	23.00
1996	Libertyville	40.00
MASSACHUSETTS		
48	Fitchburg	40.00
444	Pittsfield	20.00
624	Brockton	21.00
860	Framingham	57.00
MICHIGAN		
2026	Coldwater	20.00
MISSOURI		
978	Springfield	69.00
1795	Farmington	8.00
MONTANA		
153	Helena	20.00
NEBRASKA		
1055	Lincoln	60.00

Local	State	Amount
NEW JERSEY		
821	Newark	51.00
1489	Burlington	500.00
NEW YORK		
9	Buffalo	40.00
12	Syracuse	260.00
117	Albany	506.00
357	Islip	30.00
808	New York	60.00
1536	New York	165.00
1657	New York	51.00
1757	Buffalo	20.00
1888	New York	200.00
2241	Brooklyn	30.00
OHIO		
525	Coshocton	39.00
OREGON		
226	Portland	15.00
1120	Portland	66.00
PENNSYLVANIA		
122	Philadelphia	100.00
321	Connellsville	18.50
414	Nanticoke	10.00
773	Braddock	21.00
1044	Charleroi	30.00
1759	Pittsburgh	62.00
WASHINGTON		
1148	Olympia	15.00
1689	Tacoma	4.00
2382	Spokane	19.00
2498	Longview	32.00
WEST VIRGINIA		
3	Wheeling	20.00
1159	Point Pleasant	29.00
WISCONSIN		
161	Kenosha	22.00
1582	Milwaukee	15.00
WYOMING		
1564	Casper	80.00
TOTAL		\$3,432.10

Safety in Training



The Construction Industry Advancement Program, a contractor-funded group of Cleveland, Ohio, purchased 500 pairs of safety goggles last year, for the construction apprentices at Max Hayes Trade School. A. R. Klashak, a safety spokesman for the contractor group, noted: "It is important that young people develop good safety habits early in their career. From 1965 to 1969, eye injuries for Ohio construction workers numbered over 2,000. We hope that the use of these glasses will decrease this number in the future." Here, Apprentices John Colagiovanni and Bob Hasman use the goggles in training at the trade school.



IN MEMORIAM

**L.U. NO. 4
DAVENPORT, IOWA**
Hamdorf, Ray C.

**L.U. NO. 13
CHICAGO, ILL.**

Butler, George
Costello, Bernard
Elmier, Erick
Finnegan, Robert J.
Huber, Robert
Larson, Alfred
O'Brien, Tim
Pettis, Dennis
Quinlivan, Joseph
Randall, Owen H.
Rosenfelder, Simon
Ryan, Michael
Zigman, Oscar

**L.U. NO. 14
SAN ANTONIO, TEX.**

Ball, Anthony
Creamer, Charles P.
Curless, Sidney A.
Franz, John F.
Simpson, C. D.
White, W. B.

**L.U. NO. 15
HACKENSACK, N.J.**

Barrett, James
Pettersen, Arthur H.

**L.U. NO. 31
TRENTON, N.J.**

Brady, John
Terracino, John
Warner, Howard

**L.U. NO. 35
SAN RAFAEL, CAL.**

Rockwell, F. C.
Sorth, Ezra

**L.U. NO. 36
OAKLAND, CAL.**

Austin, Samuel W.
Christensen, Emil C.
Hoidal, William J.
Johnson, C. F.

**L.U. NO. 40
BOSTON, MASS.**

Cooper, Paul
Lavacehia, Charles
Reilly, Howard

**L.U. NO. 51
BOSTON, MASS.**

Carder, Chester D.
Stefaney, Cosmo

**L.U. NO. 53
WHITE PLAINS, N.Y.**

Wilson, Douglas

**L.U. NO. 54
CHICAGO, ILL.**

Lipensky, Edward
Mateja, Ignac

**L.U. NO. 61
KANSAS CITY, MO.**

Pierson, Alfred

**L.U. NO. 88
ANACONDA, MONT.**
Bucholz, Ben J.

**L.U. NO. 89
MOBILE, ALA.**

High, Harry

**L.U. NO. 90
EVANSVILLE, IND.**

Frank, George
Roth, Owen

**L.U. NO. 98
SPOKANE, WASH.**

Anderson Henry E.
Boulac, Clifford
Day, Proctor A.
Funk, Henry P.
Jones, Leon
Landt, L. E.
Mace, Charles
Magnuson, Ernest J.
Miner, Claude
Newton, Gerald
Olinger, Clarence L.
Parker, Ben
Relling, Harry G.
Remmick, Rinhard
Rinke, K. W.
Saylor, Robert
Tinkey, Oakley

**L.U. NO. 103
BIRMINGHAM, ALA.**

Embree, Arthur
Fretwell, Hugh
Roan, Carl A.
Zachero, Robert

**L.U. NO. 109
SHEFFIELD, ALA.**

Barber, C. E.
Koonce, T. R.
Mitchell, L. C.
Morgan, W. T.

**L.U. NO. 121
VINELAND, N.J.**

Nystrom, Robert

**L.U. NO. 132
WASHINGTON, D.C.**

Daley, Frank E.
Decatur, Frank M.
Shirley, Ernest L.

**L.U. NO. 133
TERRE HAUTE, IND.**

Blocksom, Walter
Jones, John L.
Virgil, Shirley

**L.U. NO. 186
STEUBENVILLE, OHIO**

Barnes, George
Snodgrass, Ray

**L.U. NO. 198
DALLAS, TEX.**

Nemec, George W.

**L.U. NO. 200
COLUMBUS, OHIO**

Minnix, Charles
Pennington, William E.
Wakefield, Edwin

**L.U. NO. 206
NEWCASTLE, PA.**
Aubel, Grover C.

**L.U. NO. 213
HOUSTON, TEX.**

Burnett, Robert R.
Driver, Johnny W., Jr.
Seelke, H. J.

**L.U. NO. 218
BOSTON, MASS.**

Biutanitti, Joseph
DeLuca, Samuel
Hanson, Merle C.
Rumson, Samuel

**L.U. NO. 225
ATLANTA, GA.**

Black, Lawrence A.
Brooks, William T.
Haines, Travis W.
Hamilton, A. D.
Ingram, Ernest P.
Johnson, Luverne C.
Morris, Robert D.
Shaw, M. H.
Stewart, W. A.
Thompson, W. W.
Tingle, Floyd
Woods, R. E., Jr.
Yarbrough, E. W.

**L.U. NO. 226
PORTLAND, ORE.**

Doughty, J. E.
Steinhaus, J. H.

**L.U. NO. 266
STOCKTON, CAL.**

Hollingsworth, James B.
Johnson, John H.
Tomasi, Angelo
Woodson, D. E.

**L.U. NO. 272
CHICAGO HGTS., ILL.**

Garzelloni, Thomas
Warning, Loyd
VanDerNoord, John

**L.U. NO. 298
NEW YORK, N.Y.**

Petersen, B. M.

**L.U. NO. 314
MADISON, WIS.**

Chambers, Kenneth
Hrabovsky, Frank
Pedracine, Christ
Shutvet, Lyal R.
White, Benjamin

**L.U. NO. 317
ABERDEEN, WASH.**

Carlson, Milton
Erickson, Evold
Franich, Frank
Grey, William
Gurrad, Harold
Harden, Reno
Peterson, John
Young, Ed
Zwcth, Martin

**L.U. NO. 323
BEACON, N.Y.**
Papo, John J., Sr.

**L.U. NO. 331
NORFOLK, VA.**

Bright, Jesse W.
Webb, Eurnell E.

**L.U. NO. 366
NEW YORK, N.Y.**

Fridel, Nicholas
Martucci, Anthony
Sisto, Pasquale

**L.U. NO. 379
TEXARKANA, TEX.**

Alford, Fred
Smith, Roscoe F.
Spencer, Ira L.
Stanley, C. A.
Suiter, Clyde W.
Warnock, L. G.

**L.U. NO. 440
BUFFALO, N.Y.**

Casper, Stanley

**L.U. NO. 488
NEW YORK, N.Y.**

Langiahr, Ernest
Lehtanen, Carl
Linguadoca, Emilio
Lipshitz, Abe
Olson, Albert
Strand, Harold

**L.U. NO. 490
PASSAIC, N.J.**

DeBiase, Carmelo
Reutter, Fred R.
Roskos, Samuel, Jr.

**L.U. NO. 494
WINDSOR, ONT.**

Mackie, R.
Marcuz, B.
Meter, William

**L.U. NO. 501
E. STROUDSBURG, PA.**

Bush, Charles
Walters, Roy

**L.U. NO. 512
ANN ARBOR, MICH.**

Alstetter, Louis L.
Deacon, William P.
Hill, Donald F.
Hollinger, Daniel F.
Mitchell, Thomas
Stutus, James L.

**L.U. NO. 569
PASCAGOULA, MISS.**

Ashton, Pat
Canterbury, M. L.
Gardie, G. J.
Mills, R. P.
Oakes, A. L.
Odum, Bryan
Rasco, C. C.
Todd, T. L.

**L.U. NO. 599
HAMMOND, IND.**

Argus, Gus

Beird, Charles
Donnell, Joseph
Poole, James
Sahlie, John

**L.U. NO. 608
NEW YORK, N.Y.**

Furlani, Como
Nordmann, Otto
Rohan, Peter, Jr.
Russo, Louis

**L.U. NO. 627
JACKSONVILLE, FLA.**

Barrett, Edward
Crawford, P. L.
Johnson, L. G.
Parker, D. J.

**L.U. NO. 792
ROCKFORD, ILL.**

Anderson, Richard
Epperson, Dewey
Reichenbaugh, O. H.
Worthington, Monroe

**L.U. NO. 848
SAN BRUNO, CAL.**

Dittner, Albert
Marrett, Paul

**L.U. NO. 948
SIOUX CITY, IOWA**

Krom, Frank
Vandermeer, D. H.

**L.U. NO. 956
NEW YORK, N.Y.**

Kurikjan, Oskar

**L.U. NO. 974
BALTIMORE, MD.**

Bauer, John
Gatzke, William
Hafner, Rudolf
Heim, Edward
Laffler, Max
Magaziner, Harry
Mytych, Anthony
Price, Edward
Tessau, Bernhard
Wilkerson, William E.
Worthen, Clifford

**L.U. NO. 982
DETROIT, MICH.**

Kettle, James H.
McLaren, Bennie
Martin, Mervin
Wakefield, Philip C.

**L.U. NO. 999
MT. VERNON, ILL.**

Sharp, Charles A.

**L.U. NO. 1035
TAUNTON, MASS.**

Cambra, John

**L.U. NO. 1055
LINCOLN, NEB.**

Eisele, S. H.

**L.U. NO. 1065
SALEM, ORE.**

Karnes, William
Salter, Charles

In Memoriam, Cont'd

L.U. NO. 1098 BATON ROUGE, LA.

Clark, Clarence
Poche, Ned
Rials, Homer
Roach, Frank
Turner, Macey

L.U. NO. 1138 TOLEDO, OHIO

Barber, L. Jacob

L.U. NO. 1172 BILLINGS, MONT.

Kuntz, Walter

L.U. NO. 1256 SARNIA, ONT.

Robert, Paul

L.U. NO. 1266 AUSTIN, TEX.

Coop, R. A.
Grant, E. G.
Norwood, David D.

L.U. NO. 1296 SAN DIEGO, CAL.

Abelard, L. E.
Bawden, F. W.
Beeson, J. A.
Bridges, R. E.
Brunberg, Alfred
Fretwell, Earl
Hall, James R.
Hall, M. R.
Hardina, Frank
Hudkins, Kent
Kanich, Stephen
King, Albert E.
Mitchell, C. D.
McCall, Lawrence A.
Poole, Roger
Preman, Roy N.
Price, Holden
Scott, Charles W.
Southern, Albert

Walker, William
Wallace, John, Sr.
Webb, Arthur
Woodward, F. Stanley

L.U. NO. 1367 CHICAGO, ILL.

Johnson, Hjalmar
Keilhack, Robert J.
Mostowski, Frank B.
Ottens, Leo
Wolodymyr, Szuster

L.U. NO. 1373 FLINT, MICH.

Brown, Homer
Dunkel, Nelson
Shaw, Vernon
Shelf, Andrew
Smith, John
Smith, Wilbur
Wallace, Charles
Wright, Henry

L.U. NO. 1394 FT. LAUDERDALE, FLA.

Snowden, Arthur

L.U. NO. 1397 N. HEMPSTEAD, N.Y.

Veronko, Gustave J.

L.U. NO. 1400 SANTA MONICA, CAL.

Bixler, W. L.
Blaauw, Jacob
Burrows, Clarence W.
Gustafson, John
Henderson, Philip T.
James, Frank C.

L.U. NO. 1453 HUNTINGTON BEACH, CAL.

Atkins, Marcus
Bone, Stanley

Borden, Harold
Cepeaglia, A. G.
Petty, Tom
Price, James R.
Smith, Clyde
Thompson, Walter

L.U. NO. 1469 CHARLOTTE, N.C.

Swindell, Larry D.

L.U. NO. 1485 LAPORTE, IND.

Bowers, Charles W.

L.U. NO. 1511 SOUTHAMPTON, N.Y.

Rose, Clarenee

L.U. NO. 1513 DETROIT, MICH.

Burstein, Isidor
Etkin, Joe
Feldman, Martin
Kittner, Ben
Roehlin, Isidore

L.U. NO. 1533 TWO RIVERS, WIS.

Bohne, Alvin L.

L.U. NO. 1598 VICTORIA, B.C.

Fox, John M.

L.U. NO. 1689 TACOMA, WASH.

Carlson, Alfred
Letourneau, Bert
Meath, Richard E.
Nuttelman, Ivan
Overhuls, C. C.
Sorbo, Nick
Wayne, Joseph

L.U. NO. 1699 PASCO, WASH.

Yetter, Earl

L.U. NO. 1772 HICKSVILLE, N.Y.

Fasula, Ignazio
Thorman, Frank

L.U. NO. 1822 FORT WORTH, TEX.

Ammons, Warren C.
Hook, Monroe

L.U. NO. 1846 NEW ORLEANS, LA.

Koehl, Charles
Murphy, August

L.U. NO. 1849 PASCO, WASH.

Roberts, J. F.

L.U. NO. 1971 TEMPLE, TEX.

Courtney, S. R.
Lewis, Robert O.

L.U. NO. 1976 LOS ANGELES, CAL.

Masada, Noboru
Maslen, Sam
Miller, Edward

L.U. NO. 2203 ANAHEIM, CAL.

Buckley, James
Hanlon, Paul
Judkins, Ken
Lipich, Joseph B.

L.U. NO. 2375 LOS ANGELES, CAL.

Barriga, Miquel
Fitzsimmons, A. L.
Florence, Robert
Gault, Rupert
Gay, Garland
Schorr, Gus

L.U. NO. 3182 PORTLAND, ORE.

Birch, Francis H.
Crown, Bernhard
LeMont, Henry
Meister, George
Saffel, William
Vanis, Frank

Legacies of Long Service

On March 8, 1971, Ray Snodgrass of Local 186 in Steubenville, Ohio, passed away. Snodgrass was one of Local 186's oldest members, having served continuously for more than 63 years.

Local 186 also mourns the death of George Barnes who died on March 20, 1971. Barnes had been a member of Local 186 for 50 years.

Local 498 of Brantford, Ontario, mourns the death of Leonard Lear who died on Saturday, November 28, 1970. Brother Lear was 85 years old and a 50-year-pin member.

New York State Apprentice Contest

New York held its statewide apprenticeship contest in Rochester, N.Y., on May 5, 6, and 7, 1971. In all, there were nine contestants, representing six district councils and two local unions with a membership of 50,000 men. The contestants were received at a luncheon held at the Flagship Hotel where they were addressed by General Executive Board Member Patrick J. Campbell, guest speaker, and General Representative Joseph Lia.

The manipulative test was held at the War Memorial Civic Center in Rochester and was open to the public. The written test was held at the Flagship Hotel.

The winner of the carpenter contest was David Peet of Rochester, N.Y. The millwright winner was Joseph Polashock, Jr., of New Suffolk, N.Y. Ralph Avellino was the mill cabinet winner.



Participants in the 1971 New York State Apprenticeship Contest included, left to right, seated, Robert H. Griffith of Builders Exchange of Rochester, Ralph Avellino, Joseph Polashock, Jr.; General Executive Board Member Patrick J. Campbell, David Peet, and Robert Forster, employer co-chairman of the State Apprenticeship Committee. Seen standing, left to right, are contestants James F. Seamon, Joseph Montanino, Russell Fairchild, Anthony Mafire, Neal Lennstrom, and Charles Chicola; and George Frank, Secretary of the New York State Apprenticeship Committee.



Lakeland News

Items of interest from the Brotherhood's retirement home at Lakeland, Florida



A group of Lakeland residents enjoy lawn bowling by the Home lake.

LAYOUT LEVEL

- ACCURATE TO 1/32"
- REACHES 100 FT.
- ONE-MAN OPERATION

Save Time, Money, do a Better Job With This Modern Water Level

In just a few minutes you accurately set batters for slabs and footings, lay out inside floors, ceilings, forms, fixtures, and check foundations for remodeling.

HYDROLEVEL is the old reliable water level with modern features. Toolbox size. Durable 7" container with exclusive reservoir, keeps level filled and ready. 50 ft. clear tough 3/10" tube gives you 100 ft. of leveling in each set-up, with 1/32" accuracy and fast one-man operation—outside, inside, around corners, over obstructions. Anywhere you can climb or crawl!

Why waste money on delicate instruments, or lose time and accuracy on makeshift leveling? Since 1950 thousands of carpenters, builders, inside trades, etc. have found that HYDROLEVEL pays for itself quickly.

Clip this ad to your business stationery and mail today. We will rush you a Hydrolevel with complete instructions and bill you for only \$7.95 plus postage. Or send check or money order and we pay the postage. Satisfaction guaranteed or money back.

Ask your tool dealer to order it for you. We allow the usual dealer discount on 1/2 Doz. lots and give return-mail service.

HYDROLEVEL

925 DeSoto, Ocean Springs, Miss. 39564

FIRST IN WATER LEVEL DESIGN SINCE 1950

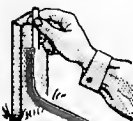

Wm. A. Walker, of Local 764, Shreveport, La., arrived at the Home June 9, 1971.

Leslie D. Kellogg, of Local 1328, Deland, Fla., arrived at the Home June 15, 1971.

Edwin Wahlgren, of Local 257, New York, N.Y., arrived at the Home June 16, 1971.

C. Ray Carlson, of Local 171, Youngstown, Ohio, died June 6, 1971. Burial was at Austintown, Ohio.

Fred C. Bauer, of Local 618, Sikeston, Mo., died June 6, 1971. Burial was at Sikeston.

Robert W. Stobaugh, of Local 345, Memphis, Tenn., died June 19, 1971. Burial was in Memphis.

W. P. Davidson, of Local 2217, Lakeland, Fla., withdrew from the home (to be married) June 30, 1971.

INDEX OF ADVERTISERS

Audel, Theodore	25
Chevrolet	11
Chicago Technical College	35
Cooper Industries	20
Craftsman Book Co.	39
Estwing Manufacturing	22
Foley Manufacturing	30
Goldblatt Tool Co.	22
Hydrolevel	39
Irwin Auger Bit Co.	39
Knaack Manufacturing	26
Lee, H. D.	25
Locksmithing Institute	32
Schaefer Manufacturing Co.	32
Stanley Power Tools	Back Cover

LABOR and MATERIAL COSTS

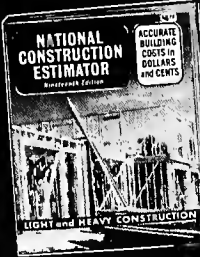

1971 UNIT COSTS
COMPILED FROM
THE RECORDS OF
HUNDREDS OF
CONTRACTORS
AND MATERIAL
SUPPLIERS

— 208 Pages

ONLY \$4.75

8 1/2 x 11
NO. A. WERTISING

In California add 24c tax

- ACCURATE BUILDING COSTS IN DOLLARS AND CENTS
- AVERAGE LABOR COSTS FOR THOUSANDS OF ITEMS
- TYPICAL SUB CONTRACT PRICES INCLUDED
- NEW ESTIMATING RULES OF THUMB

Send for FREE Building Books Catalog

CRAFTSMAN BOOK COMPANY OF AMERICA Dept. CS
124 SO. LA BREA AVE., LOS ANGELES, CALIF. 90036

- Please send me the *Nineteenth Edition* of the NATIONAL CONSTRUCTION ESTIMATOR. . \$4.75
In California add .24c Sales Tax
- Please send me FREE Building Books Catalog.

Firm Name _____
Your Name _____
Address _____
City _____ State _____
AMOUNT ENCLOSED _____ Zip _____

10 DAY FULL MONEY BACK GUARANTEE

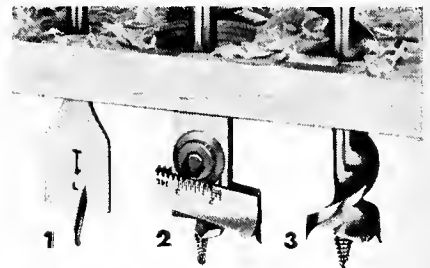

3 easy ways to bore holes faster

1. Irwin Speedbor "88" for all electric drills. Bores faster in any wood at any angle. Sizes 1/4" to 3/8", \$.90 each. 5/8" to 1", \$1.00 each. 1 1/8" to 1 1/2", \$1.50 each.

2. Irwin No. 22 Micro-Dial expensive bit. Fits all hand braces. Bores 35 standard holes, 7/8" to 3". Only \$5.70. No. 21 small size bores 19 standard holes, 5/8" to 1 1/4". Only \$5.00.

3. Irwin 62T Solid Center hand brace type. Gives double-cutter boring action. Only 16 turns to bore 1" holes through 1" wood. Sizes 1/4" to 1 1/2". As low as \$1.60 each.

EVERY IRWIN BIT made of high analysis steel, heat tempered, machine-sharpened and highly polished, too. Buy from your independent hardware, building supply or lumber dealer.

Strait-Line Chalk Line Reel Box
only \$1.35 for 50 ft. size

New and improved Irwin self-chalking design. Precision made of aluminum alloy. Practically damage-proof. Fits the packet, fits the hand, 50 ft. and 100 ft. sizes. Get Strait-Line Micro-Fine chalk refills and Tite-Snap replacement lines, too. Get a perfect chalk line every time.



IRWIN Wilmington, Ohio 45177
every bit as good as the name



In Conclusion

M. A. Hutcheson, *General President*



Our 90th Anniversary—A Period of Shortchange

■ This month marks the 90th anniversary of the founding of our Brotherhood.

During the past nine decades, there have been wars, panics, depressions, booms and busts. All of them have exerted pressures and presented challenges to our union.

In the 1880's, the problem was organizing. Communication was slow. Travel was expensive and difficult. Three-quarters of the people in the United States and Canada lived on farms which were largely self-sufficient. Unfriendly courts often threw curves to block organizing efforts of unions.

In spite of these difficulties, the men who founded our Brotherhood kept persevering with their organizing efforts, so that our Brotherhood by the 1890's was the best organized trade in the nation.

In that decade, our Brotherhood spearheaded the fight for the 8-hour day. It was through our efforts that the 8-hour day was finally achieved by the end of the 1800's.

In the early years of this century, numerous court decisions harassed unions and undercut their efforts to achieve economic and political maturity. Employer organizations bent on destroying unions proliferated rapidly. Often the labor movement had its back to the wall, but it held together and endured.

Two world wars, separated by a long and disastrous depression, offered a challenge of considerable magnitude to the continued growth and progress of organized labor.

Through time-tested policies and strict adherence to fundamental union principles, our Brotherhood has managed to survive and to grow through the last nine-tenths of a century. Now, we are facing new challenges—challenges which were pinpointed at the recent Conference on Jobs, sponsored by the AFL-CIO in Washington.

At a time when unemployment is keeping some six workers out of a hundred on the jobless rolls, inflation is driving prices up steadily. There is depression and inflation at the same time.

Unfortunately, the building trades are the hardest hit of any segment of the economy. The rate of joblessness in construction runs as high as 40 and 50 percent in some areas. Yet, of all segments of labor, the building trades alone are placed under wage controls.

The President signs a bill, which in theory, at least is supposed to add public service jobs in states and municipalities, but vetoes a bill aimed at accelerating public works construction projects, although the need for safer airports, better sewage disposal plants, and more hospital beds, grows daily.

Building trades workers thus are shortchanged again by the Administration.

In apprenticeship, too, the government is chipping away at time-tested procedures which have served the industry long and well. It is no exaggeration to say that apprenticeship training, as we know it, may be unrecognizable a decade from now, if the present sniping continues.

All this means that the years between our 90th and our 100th birthdays will not be easy ones. There is too much rosy rhetoric regarding economic conditions and too little constructive action to get the nation moving again on the economic front.

However, with 90 years of experience under our belts, we ought to have what it takes to hold our own in this troubled age. I believe we have every right to be proud of our past, and I do not believe there is any more sure guarantee of a sound future than a sound past. ■



Campers don't mean to start forest fires but they do. If you take pride in being a good campfire builder, save some for being a good putter out.

Leaving a fire to smolder alone is just inviting an inferno. And there are few enough good spots to go around now. Douse before you drive away. Only you can prevent forest fires.



Stanley cuts the chatter

(to make smoother work for you)

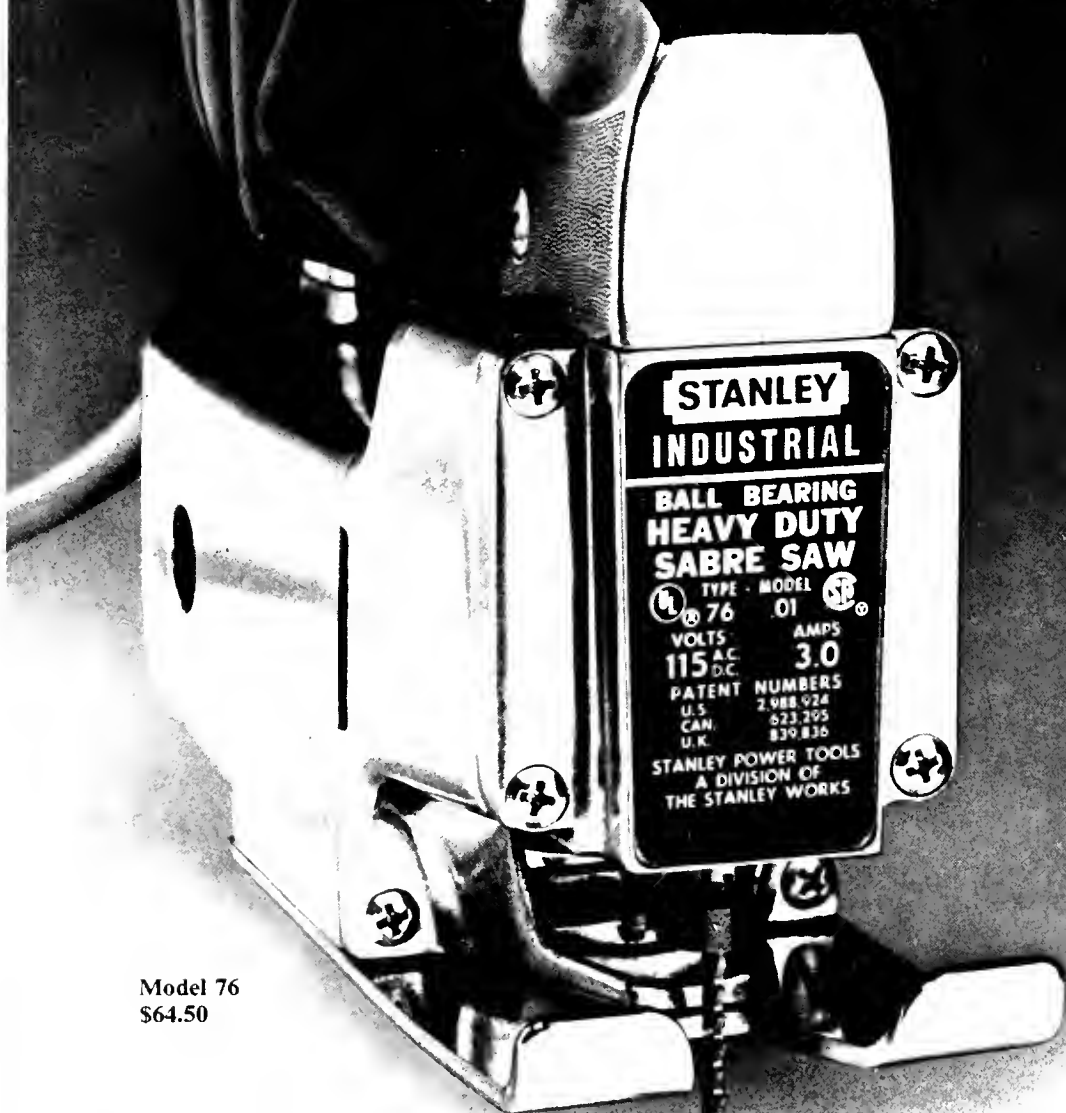

Model 76
\$64.50

No chatter. No rough edges. Less blade breakage. With Stanley sabre saws, a patented anti-vibration mechanism assures smooth, vibrationless cutting. Felt seals at each end of the plunger provide constant lubrication. Keeps oil in - dirt out. Like on our Model 76. A real "do anything saw." Cuts curves, scrolls, fancy patterns - or rips 2" lumber and 1/2" steel, aluminum, brass and other metals. An oversized fan directs its powerful air blast toward your cutting line - to keep it clear of chips. An adjustable 2-position, non-marring base lets you flush cut right up to a vertical surface.

If that's not enough reason to buy a Stanley, consider this. The Model 76 is equipped with sealed ball-bearings to give you smooth transmittal of power from its 3.0 amp Stanley-made motor to the blade end of the saw. Separate handle for cool comfort and more control. Single slotted screw to hold blade rigid. See the complete line of Stanley sabre saws at your distributor. Stanley Power Tools, Division of The Stanley Works, New Bern, North Carolina 28560.

STANLEY
helps you do things right

P.S.: made by the same Stanley that makes the finest hand tools.

The CARPENTER

Official Publication of the UNITED BROTHERHOOD OF CARPENTERS AND JOINERS OF AMERICA • FOUNDED 1881



THE 1971
INTERNATIONAL
APPRENTICESHIP
CONTEST
WINNERS

JOHN DAVID
TRIMBLE
MILL/CABINET
JAMES WRIGHT
MILLWRIGHT
CHRISTOPHER
COTTIER
CARPENTER



OFFICIAL INFORMATION



GENERAL OFFICERS OF THE UNITED BROTHERHOOD of CARPENTERS & JOINERS of AMERICA

GENERAL OFFICE:
101 Constitution Ave., N.W.,
Washington, D. C. 20001

GENERAL PRESIDENT

M. A. HUTCHESON
101 Constitution Ave., N.W.,
Washington, D. C. 20001

FIRST GENERAL VICE PRESIDENT

WILLIAM SIDELL
101 Constitution Ave., N.W.,
Washington, D. C. 20001

SECOND GENERAL VICE PRESIDENT

HERBERT C. SKINNER
101 Constitution Ave., N.W.,
Washington, D. C. 20001

GENERAL SECRETARY

R. E. LIVINGSTON
101 Constitution Ave., N.W.,
Washington, D. C. 20001

GENERAL TREASURER

CHARLES E. NICHOLS
101 Constitution Ave., N.W.,
Washington, D. C. 20001

DISTRICT BOARD MEMBERS

First District, **PATRICK J. CAMPBELL**
130 North Main Street
New City, Rockland Co., New York
10956

Second District, **RALEIGH RAJOPPI**
2 Prospect Place, Springfield, New Jersey
07081

Third District, **WILLIAM KONYHA**
1830 Ledge Rd., R.D. No. 4
Medina, Ohio 44256

Fourth District, **HAROLD E. LEWIS**
340 Northwest 148th St.
Miami, Florida 33168

Fifth District, **LEON W. GREENE**
2800 Selkirk Drive
Burnsville, Minn. 55378

Sixth District, **FREDERICK N. BULL**
P.O. Box 14279
Oklahoma City, Okla. 73114

Seventh District, **LYLE J. HILLER**
Room 722, Oregon Nat'l Bldg.
610 S.W. Alder Street
Portland, Oregon 97205

Eighth District,
Forum Building, 9th and K Streets
Sacramento, California 95814

Ninth District, **WILLIAM STEFANOVITCH**
2418 Central Avenue
Windsor, Ontario, Canada

Tenth District, **GEORGE BENGOUGH**
2528 E. 8th Ave., Vancouver 12, B. C.

M. A. HUTCHESON, Chairman
R. E. LIVINGSTON, Secretary

Correspondence for the General Executive Board
should be sent to the General Secretary.



Secretaries, Please Note

If your local union wishes to list deceased members in the "In Memoriam" page of *The Carpenter*, it is necessary that a specific request be directed to the editor.

In processing complaints, the only names which the financial secretary needs to send in are the names of members who are NOT receiving the magazine. In sending in the names of members who are not getting the magazine, the new address forms mailed out with each monthly bill should be used. Please see that the Zip Code of the member is included. When a member clears out of one Local Union into another, his name is automatically dropped from the mail list of the Local Union he cleared out of. Therefore, the secretary of the Union into which he cleared should forward his name to the General Secretary for inclusion on the mail list. Do not forget the Zip Code number. Members who die or are suspended are automatically dropped from the mailing list of *The Carpenter*.

PLEASE KEEP *THE CARPENTER* ADVISED OF YOUR CHANGE OF ADDRESS

PLEASE NOTE: Filling out this coupon and mailing it to the *CARPENTER* only corrects your mailing address for the magazine. It does not advise your own local union of your address change. You must notify your local union by some other method.

This coupon should be mailed to *THE CARPENTER*,
101 Constitution Ave., N.W., Washington, D. C. 20001

NAME _____ Local No. _____

Number of your Local Union must
be given. Otherwise, no action can
be taken on your change of address.

NEW ADDRESS _____

City

State

ZIP Code



THE CARPENTER

VOLUME XCI

No. 9

SEPTEMBER, 1971

UNITED BROTHERHOOD OF CARPENTERS AND JOINERS OF AMERICA

Peter Terzick, Editor

IN THIS ISSUE

THE 1971 APPRENTICESHIP CONTEST

Canada, Midwest Dominate 1971 Apprenticeship Contest	2
Carpenter Contestants at Work	6
Busy Days at the Light Guard Armory	8
Mill-Cabinet Contestants at Work	10
The Written Test Checks Craft Knowledge	12
Contest Featured on TV	13
Millwright Contestants at Work	14
The Saturday Discussion Session	16
The Ladies Enjoy Detroit	17
New Prizes Add Sparkle to 1971 Awards Banquet	18
National Joint Apprenticeship Committee Guides Contest	22

NEWS AND FEATURES

Peter Terzick Retires as General Treasurer	25
Charles Nichols Succeeds Terzick in Finance Post	25
The Freeze Hits Wage Earner Hardest	26

DEPARTMENTS

Local Union News	32
CLIC Report	34
In Memoriam	37
Lakeland News	38
In Conclusion	M. A. Hutcheson 39

POSTMASTERS, ATTENTION: Change of address cards on Form 3579 should be sent to THE CARPENTER, Carpenters' Building, 101 Constitution Ave., N.W., Washington, D. C. 20001

Published monthly at 810 Rhode Island Ave., N.E., Washington, D. C. 20018, by the United Brotherhood of Carpenters and Joiners of America. Second class postage paid at Washington, D. C. Subscription price: United States and Canada \$2 per year, single copies 20¢ in advance.



Printed in U. S. A.

THE COVER

We might call our September cover the winners' circle. It's a montage of pictures of the winners in the 1971 International Carpenters Apprenticeship Contest in Detroit, Michigan, August 12 and 13.

The three first place winners are in the gold seal at lower right on our cover.

Surrounding them, from the bottom of the page, clockwise, are: Dwight Robert Smith of Toledo, O., second place millwright; Robert Jacobsen of Calgary, Alta., second place carpenter; John E. Sample of Walpole, Mass., second place, mill-cabinet; (in the upper left hand corner) Robert Freeman of Stockton, Calif., third place mill-cabinet; (in the striped shirt) William D. Lester of Windsor, Ont., fifth place carpenter; (wearing glasses) C. J. Edward Smith of Winnipeg, Man., fourth place carpenter; (upper right hand corner) Kenneth B. Danielsen of Davenport, Ia., third place carpenter; and, finally, Bruce Maes of Los Angeles, Calif., third place millwright.

It's a busy cover, and the Brotherhood is proud of every contestant shown there, as well as the 60 other contestants who made strong bids for the prizes.

The 1971 competition, held in the Light Guard Armory in Warren, Mich., was the fifth such contest to bear the stamp "International". A full report appears on the next 21 pages.



CANADA AND THE MIDWEST DOMINATE

...SOLID



■ In two tense, busy days, last month, 71 of the best carpenters, mill-cabinet, and millwright apprentices in North America competed in Detroit, Michigan, for the title of champion of their respective fields.

When it was all over—the eight hours of hard labor over manipulative projects and the four hours of written tests—contestants from Canada and the Middle West took most of the awards.

A tall, slim carpenter apprentice from Victoria, B.C., won the top money of \$1500, plus the Olav Boen Trophy, the International Carpentry Trophy, a collection of tools, and a lot of other prizes. Robert Jacobsen of Calgary, Alberta, picked up \$1,000 and the other second prizes. C. J. Edward Smith of Winnipeg, Manitoba, took fourth, and William D. Lester of Windsor, Ontario, placed fifth. The only non-Canadian in the top carpenter five was Kenneth Danielsen of Davenport, Iowa, who came in third.

There were only four carpenter entries from Canada, and everyone of them won!

Midwesterners fared well in the competition, too. John David Trimble of Moline, Illinois, won first place in the mill-cabinet competition; James Wright of Detroit was first-place millwright; and Dwight Robert Smith of Toledo, Ohio, was third-place millwright.

A loud burst of applause greeted the announcement at the awards banquet that James Wright had taken top honors in the millwright competition. It marked the third time in four years that Millwrights Local 1102 of Detroit has groomed a winner.

The California team, traditionally strong contenders, wound up in show positions with two third-place winners. Bruce Maes of Los Angeles was third place millwright and Robert Freeman of Stockton was third-place mill-cabinetmaker. Freeman brought his bride of one week to Detroit for a busy honeymoon.

Of the 71 contestants in the 1971 contest, 40 were carpenters, 14 mill-cabinetmakers, and 17 millwrights. They represented 35 states, the Dis-

Big picture, left: Lumber is stacked "backstage" at the Light Guard Armory, ready for the contest to start.

Insert, left: Team No. 2 of carpenter judges, from left: Tyler Jenkins, employer; Jim Sawyer, UBC; and Joseph L. Fleshner, AIA.

1 John Ohler
Local 168
Kansas City, Kansas

2 Jack Wormdahl
Local 1273
Eugene, Oregon

3 Edward K. Solomon
Local 1743
Wildwood, New Jersey

4 Van L. Teager
Local 55
Denver, Colorado





It's standing room only as this shuttle-bus load of contest spectators heads for the Light Guard Armory. It was shirtsleeve weather for most of the men.

At right, Frank Hutnik of Local 494, Windsor, Ont., left, and GEB Member William Stefanovitch, right, watch a millwright contestant at work.



PERSONAL PHOTO PRINTS

On the front cover and throughout the first 22 pages of this issue of *The Carpenter* are pictures of the International Carpenters Apprenticeship Contest in Detroit, Michigan. Many sponsors, visitors, and participants have asked how they may obtain prints of these pictures which were taken by the official photographer.

We have arranged with our printer, Merkle Press, Inc., to supply 8" x 10" glossy prints at a nominal cost to all who request them.

Simply list the pictures you wish to order. (Please describe fully, including page number and, where it is indicated, the picture number and identification.) Each print costs \$2.00, which covers handling and mailing. State the quantity of each photo desired and send your order with your name and address plus cash, check, or money order (payable to Merkle Press, Inc.) to: Carpenters Contest Photos; Merkle Press, Inc.; 810 Rhode Island Avenue, N.E., Washington, D.C. 20018.

trict of Columbia, and four provinces of Canada. Many wives attended this year's contest.

Growing steadily since it changed from a Western States competition to an International competition in 1967, the contest is sponsored by the United Brotherhood of Carpenters and Joiners of America, the Associates General Contractors of America, and the National Association of Home Builders. It was given further impetus this year by the National Forest Products Institute, which offered all-expense-paid trips to the first place winners and their wives, taking them on a tour of North America forest industry facilities later this year.

Contest officials were pleased with the excellent work performed by the state champions. The competition was close, and it was late on Saturday, August 14 before the winners were decided. ■



Above: General President Huteson and First General Vice President Sidell talk with a contestant who has completed his project and his wife—Mr. and Mrs. William Mays of Minneapolis.

Right: The briefing for the manipulative portion of the contest completed, the contestants study the instructions and plans before going to work.



An interested spectator and maybe a future apprentice.



On Wednesday, August 11, coordinators and instructors discussed their problems with a special panel, which included William Pemberton of the AGC; Jack Thompson, San Diego, Calif., contractor; William Dennis of HEW; and John Douthitt of the US Bureau of Apprenticeship and Training. Jim Tinkcom was panel chairman.

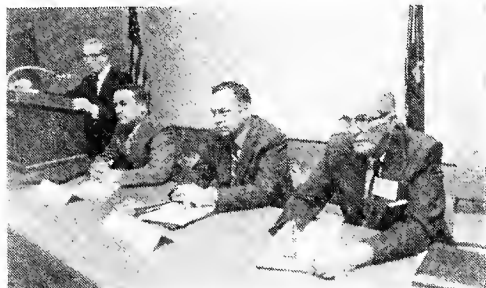

Three men who helped to keep the contest moving: Gen'l. Rep. Len Timmerman; Hal Bell, director of labor relations, Michigan Chapter, AGC; and Detroit Council President Ray Fair.

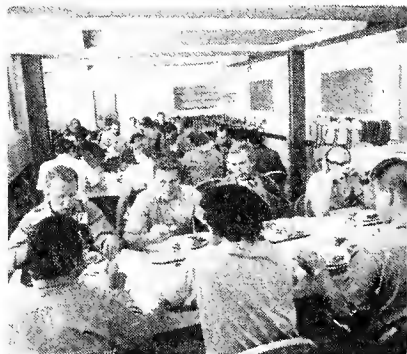

A lunch break in the armory cafeteria finds contestants tired, but happy that their work is half done.



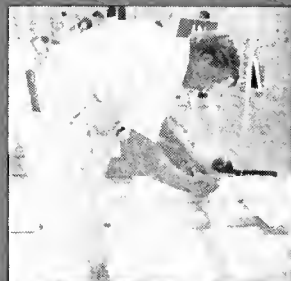

1 Wayne T. Bouille
Local 745
Honolulu, Hawaii

2 Franklin W. Madison
Local 329
Oklahoma City, Oklahoma

3 Sebron E. Henderson
Local 184
Salt Lake City, Utah

4 Gerd-Horst Feierlein
Local 764
Shreveport, Louisiana

5 William May
Local 7
Minneapolis, Minnesota

6 Tommy Steve Jenkins
Local 74
Chattanooga, Tennessee

7 Eloy L. Candelaria
Local 1319
Albuquerque, New Mexico

8 Larry Pendergrast
Local 61
Kansas City, Missouri

9 Conrad Lavoie
Local 43
Hartford, Connecticut

10 Christopher T. Cottier
Local 1598
Victoria, British Columbia



Judges, Team No. 1: Joseph J. D'Aries, UBC; John Andrews, AIA; and Stanley Veighey, AGC.

11 Raymond Neil Berger
Local 1597
Bremerton, Washington

12 James David Bouchard
Local 1509
Miami, Florida



17



18



19

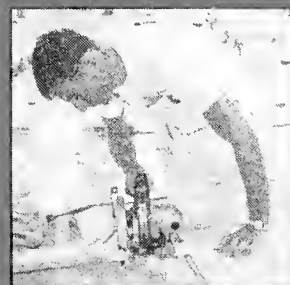

20



21

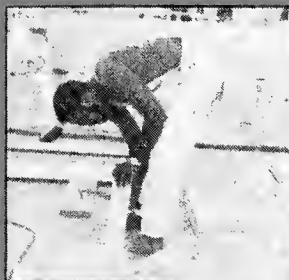

22



23



24



25



26



27



28



29



30



31



32

13 Philip R. Bough
Local 599
Hammond, Indiana

14 Myron John Martin
Local 1780
Las Vegas, Nevada

15 John W. Ritter, Jr.
Local 101
Baltimore, Maryland

16 Joseph R. Strunk
Local 213
Houston, Texas

17 Richard O. Cournoyer
Local 94
Providence, Rhode Island

18 William Mac Mullican
Local 103
Birmingham, Alabama

19 Glen M. Knickerbocker
Local 1281
Anchorage, Alaska

20 Archie L. Ferguson
Local 1216
Mesa, Arizona

21 Albert M. DeAngelis, Jr.
Local 1296
San Diego, California

22 William Shelby Champ
Local 132
Washington, D. C.

23 David Francis Peet
Local 72
Rochester, New York

24 Michael V. Ulizzo
Local 105
Cleveland, Ohio

25 James Schott
Local 1606
Omaha, Nebraska

26 Dennis E. Castles
Local 1373
Flint, Michigan

27 Albert Hopkins
Local 1073
Philadelphia, Pennsylvania

28 Vance A. Gray, Jr.
Local 626
Wilmington, Delaware

29 Donald E. Eisler
Local 792
Rockford, Illinois

30 Gary Belanger
Local 111
Lawrence, Massachusetts

31 William R. McGraw
Local 1432
Laramie, Wyoming

32 Bruce F. Licht
Local 1074
Eau Claire, Wisconsin

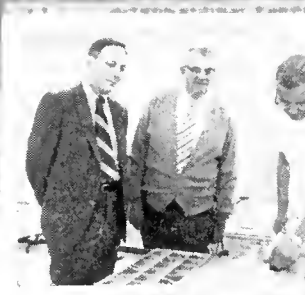

1. *Wives and visitors are unloaded at the entrance to the Light Guard Armory. Shuttle buses departed every hour for the contest site.*

2. *General Executive Board Member Lyle Hiller, center, with a contestant and sponsor from his district.*

3. *GEB Member Frederick Bull watches Millwright Contestant Burke of Texas complete his project.*

4. *Plastic welding was demonstrated by a manufacturer's representative in a booth at the rear of the contest hall.*

5. *Milan Marsh, GEB Member William Konyha, and First General Vice President Sidell observe Millwright Apprentice Dwight Robert Smith of Toledo, O., at work.*

6. *General President Hutcheson and GEB Member Patrick Campbell note the skills of a carpenter contestant.*

7. *GEB Member Harold Lewis admires the work of a millwright contestant from his district—Danny Hibbs of Chattanooga, Tenn.*

8. *Early in the morning contestants load their tools aboard a truck outside the Pick-Fort Shelby Hotel before departing by bus for the Light Guard Armory and their manipulative test.*

9. *GEB Member Leon Greene stops a moment beside the project of Millwright Contestant Ervin Krueger of Denver.*

■ For two days in mid-August the polished, hardwood floors of the Light Guard Armory in Warren, Michigan, bore the busy footsteps of 71 apprentices at work on their manipulative projects, plus the weight of the hundreds of visitors who watched them compete.

Each state champion worked in a 20-foot-square roped-off area. All the necessary lumber and power tools were assembled for the carpenter and mill-cabinet contestants. The gears, shafts, and other items needed by the millwrights were ready.

Aisles between the work area were wide enough to accommodate hundreds of spectators. In fact, the site was excellent for its assigned purpose.

Originally, the 1971 contest was to be held in Detroit's big Cobo Hall, as was announced earlier in *The Carpenter*, but differences between members employed by Cobo Hall and its management resulted in a picket line around the big downtown facility, and contest directors were forced to switch to a new location.

The local arrangements committee provided shuttle buses to the Light Guard Armory from the downtown hotels, and the alternate plans worked beautifully. ■



■ Fourteen mill-cabinet apprentices competed in the 1971 contest. They came primarily from the West and North. Canada had only one mill-cabinet competitor: Thomas H. Lowdon of Local 1598, Victoria, British Columbia. This year, the South, a stronghold of the Building Trades, had none.

The competition was sharp, as the young men trimmed down top grade lumber and plywood into upright gun cabinets.

New power tools were in adequate supply. A Detroit distributor, Andrews and Owen, and Rockwell Manufacturing Co. supplied 10-inch table saws with stands and extension wings, 6-inch jointers, 6-inch, 1/3 hp grinders, bayonet saws, routers, and sanders. The contestants were well equipped for work on their manipulative projects.

(After the contest was over, the distributor offered the power tools —“used for one day only” at sharply reduced prices to contestants, sponsors, and spectators.)

The 1971 manipulative project, when completed, stood 6 feet tall, 2'6" wide, by 12" deep. It was an attractive gun cabinet, constructed to hold 4 shotguns or rifles, with a pull drawer at the bottom for ammunition storage. Made of white pine, the cabinet was a good eight-hour test for any apprentice. Pre-tested as to construction time required and facility of production, the project proved worthy of the state champs. Most cabinets were nearly completed when the whistle blew to stop work in the afternoon.

The pictures at left show all but two of the contestants at work on their projects. Two of the winners, not shown here, appear on our front cover. These men are Robert Freeman of Local 266, Stockton, Calif., and John E. Sample of Local 1479, Walpole, Mass. ■

MILL- CABINET CONTESTANTS AT WORK





1 Anthony Macciocca
Local 1050
Philadelphia, Pennsylvania

2 John David Trimble
Local 166
Rock Island, Illinois

3 Donn L. Markwardt
Local 1120
Portland, Oregon

4 Thomas H. Lowdon
Local 1598
Victoria, British Columbia

5 Mark E. Shinabarger
Local 565
Elkhart, Indiana

6 Daniel Sanchez
Local 1583
Englewood, Colorado

7 John Malloy
Local 455
Somerville, New Jersey

8 William A. Hester, Jr.
Local 1694
Washington, D.C.

9 Eugene C. Chose
Local 338
Seattle, Washington

10 William R. Schultz
Local 101
Baltimore, Maryland

11 Joseph A. Clemenza
Local 1365
Cleveland, Ohio

12 Ralph Avellino
Local 1164
New York, New York

13 Mill-cabinet judges:
from left, Nelson
Kropik, employer; Clif-
ford Kott, Detroit
Lumbermen's Assn., and
Joseph Pinto, UBC.

**14 Gun cabinets after
eight hour's work.**

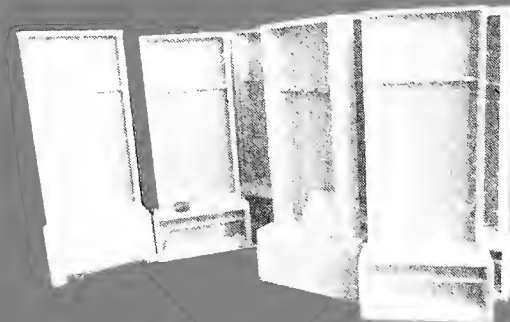
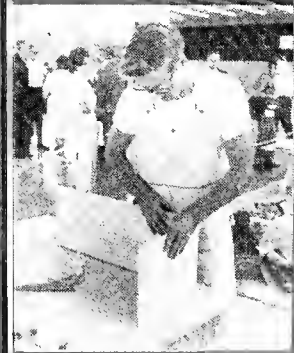

THE WRITTEN TEST CHECKS CRAFT KNOWLEDGE

■ The four-hour written tests given participants in the annual International Carpenters Apprenticeship Contest can make the difference between winning and losing. They rate 40% of the overall score.

With competition so close that a fraction of a point can decide the outcome, contestants are urged to take their time and think carefully before writing down their answers.

Tests, this year, were held in a banquet room of the Pick-Fort Shelby Hotel. Carpenters took theirs on August 12; millwrights and mill-cabinetmen convened for their brain-drain the following morning.

Contestants could complete their written work early and leave, but they were encouraged to stay and check their work. The afternoon was then free for sightseeing or for visiting the Light Guard Armory, where other contestants were struggling over their manipulative projects. ■



Above: Contestants in the midst of their test problems.

Right: Coordinator Charles Allen with the test monitors—Coordinator Jim Tinkcom and MDIA Coordinator H. E. Morris.





First General Vice President Sidell is interviewed by Bob Hines.

CONTEST FEATURED ON TV

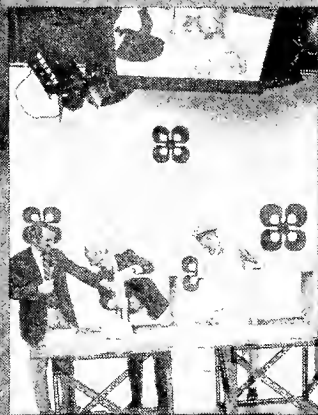

Detroit apprentice Gordon Gray, right, demonstrates the construction of a work bench "live" on the WXYZ-TV show.

■ The International Carpenters Apprenticeship Contest drew the attention of Detroit broadcasting stations during its two-day run in the Motor City.

In addition to on-the-spot news coverage by radio and television stations, Television Station WXYZ, an ABC Network facility, drew attention to the competition on a morning "talk show." First General Vice President William Sidell discussed the contest with Station Personality Bob Hines as a Detroit Apprentice Gordon Gray put together a pre-cut work bench. Bob Hines, supplied with a hard hat of his own, attempted to duplicate the skilled work of Apprentice Gray only to go down in laughing defeat under lights and cameras when he nailed the right board in the wrong place . . . or vice versa.

Following this presentation, Vice President Sidell answered questions from the television audience. ■

■ A selective collection of gears, bearings, shafts, and a chain was the millwright manipulative project this year.

Linked to a 1/3 horsepower motor, it excited spectators when it took life and began to whirl and hum at the end of the work day. Excitement mounted as project after project began to spin during the late afternoon. By the close of the "work day" every millwright apprentice had completed his project, and the Light Guard Armory was filled with smiling contestants.

This was the first time that an electric motor has been used in the millwright manipulative test, and the results were gratifying.

Shown on these two pages are all of the millwright contestants at work except two of the winners, who are shown on the front cover. These two are Bruce D. Maes of Los Angeles, Calif., and Dwight Robert Smith of Toledo, Ohio.

Millwrights and mill-cabinet contestants performed their manipulative tests on the same day—Thursday, August 12. Millwrights were on one side of the center aisles, and mill-cabinetmen were on the other.

Millwright judges took careful note of many things in toting up points for each contestant. Walking quietly from booth to booth, they noted the neatness of the work area, the use of tools, working procedures, working clothes and equipment, and much more.

By the end of the test day they had a total of so-many points for each state champion. These points, when added to the points scored on the written test, created grand totals for each contestant and the final decisions on winners. ■

MILLWRIGHT CONTESTANTS AT WORK



1 James Wright
Local 1102
Detroit, Michigan

2 Joseph Polashock, Jr.
Local 740
New York, New York

3 Charles Phillip Burke
Local 963
Houston, Texas

4 Carl Norred
Local 720
Baton Rouge, Louisiana

5 Richard A. Bullie
Local 1857
Portland, Oregon

6 Edward J. Clark
Local 1693
Chicago, Illinois

7 Robert F. Guinn
Local 1831
Washington, D.C.

8 Michael Karnaghan
Local 1780
Las Vegas, Nevada

9 Norman Barry Larson
Local 1914
Phoenix, Arizona

10 John Fretchel
Local 1906
Philadelphia, Pennsylvania

11 Eric Randall
Local 101
Baltimore, Maryland

12 Conrad Elkin
Local 2315
Jersey City, New Jersey

13 Paul Bennett
Local 1592
Sarnia, Ontario

14 The winning contestant's tools spread neatly on the floor and ready for action.

15 Danny Hibbs
Local 654
Chattanooga, Tennessee

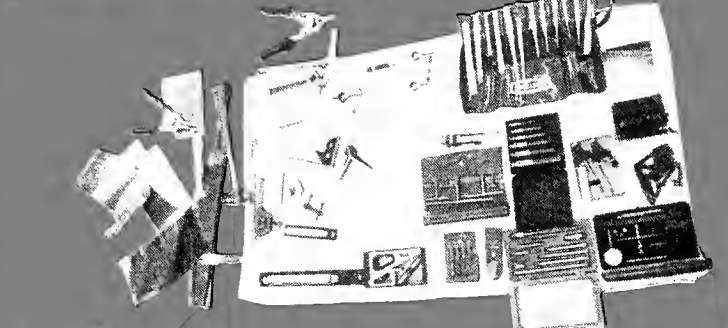

16 Ervin L. Krueger
Local 2834
Denver, Colorado

17 From left: Coordinator Gordon Littman, Coordinating Judges Dick Hutchinson and Paul Rudd, Gen'l. Rep. Ben Collins, and Technical Director Leo Gable.

18 Millwright Judges Mike Shalhope, employer: Jack DeBona, employer: and Dick Miller, UBC.



THE SATURDAY DISCUSSION SESSION

■ To some of its participants the traditional Saturday morning discussion session which follows the annual apprenticeship contest might seem like a gathering of Monday-morning quarterbacks.

It's a free and open discussion of the contest, the apprenticeship program and the merits and demerits of both. And, actually, it is one of the most valuable huddles of the annual competition.

This year's "Saturday session" gathered in a basement meeting room of the Pick-Fort Shelby Hotel.

It was a three-hour assembly in which the National Joint Apprenticeship Committee fielded questions from the audience.

A large group had assembled when the gavel sounded. Ed Wasielewski, chairman of the National Joint Apprenticeship and Training Committee, served as moderator of the discussion.

The room began to fill as the meeting progressed, with several wives sitting "along the sidelines."

It was an opportunity to talk about the many aspects of the con-

test, while the activities of the past two days were fresh in mind.

Among the topics discussed were the possibility of district or regional contests in addition to state contests, the feasibility of holding the contest during the school year so more youngsters can attend, the methods of scoring the written test, and the practicality of various manipulative tests.

Apprentices and sponsors alike were urged to join the discussions, and many did. ■

Left: The National Joint Apprenticeship Committee awaits the next question.

Below left: A sponsor offers a suggestion.

Below: A sponsor from Alberta makes a point, and a Wyoming apprentice contestant speaks up.



THE LADIES ENJOY DETROIT

A room on the top floor of the Hotel Pontchartrain served as a hospitality center for wives and guests attending the International Contest. They watched the long ore boats passing on the Detroit River below, enjoyed coffee and conversation, and departed each day for sightseeing, shopping, and visits to the Light Guard Armory.



NEW PRIZES ADD SPARKLE TO 1971 AWARDS BANQUET



General President Hutcheson addresses the awards banquet.

■ A glittering awards banquet capped the two-day competition on Saturday night, August 14. Site of the banquet was the Light Guard Armory in Warren, Michigan, where the manipulative tests were held.

A 30-foot-long table loaded with plaques, certificates, trophies, and other prizes stood before the head table awaiting the winners.

The list of prizes was longer than ever before, as the National Forest Products Institute added all-expense-tours of forest industry centers for the top winners and the wives to the grand array. Cufflinks, tie tacks, certificates, and craft books added to the gifts presented the contestants.

Lee Rice, secretary of the International Carpenters Apprenticeship Contest Committee, was master of ceremonies. Following opening remarks by First General Vice President William Sidell and invocation by the Rev. V. F. Halboth, Sr., of the Grace Lutheran Church, Redford, Michigan, several speakers of industry, government, and labor were introduced.

Dominic J. Rossi, vice president of Darin & Armstrong Co. and president of the Detroit Chapter of the Associates General Contractors, told

the audience that the work of the contestants reflected the fine skills of the union building tradesmen of the host city and he stated that organized labor had played a growing and progressive role in the Motor City. He extended an official welcome to the visitors.

John Doughit, director of national industry promotion for the U.S. Bureau of Apprenticeship and Training, called the contest "a shining example" of labor, management, and government working together. This kind of competition is needed all over America, he said.

Saul Horowitz, Jr., president of the HRH Construction Co., of New York City, speaking on behalf of the AGC, told the assembled apprentices that "at other times in our nation's history this contest might have seemed like the attainment of a final goal."

"From now on the opportunity to practice your skills and to be adequately paid and fully employed would be assured by your membership in a great union," he commented, "but forces are at work in our country and in the world which lead me to caution you that you are not at the end but, instead, at the

beginning of the greatest challenge labor and management have ever faced. Labor and management must produce more and better construction at reasonable costs so that we both can survive."

A principal speaker was General President M. A. Hutcheson, who told the audience that "union carpenters have invested a tremendous amount of money in apprenticeship training" and that the annual competition shows the value of this investment.

He vowed that the Brotherhood "does not intend to passively submit to the destruction of a good apprenticeship program by accepting the dictates of government."

Hutcheson attacked the Federal government for trying to "force upon us" programs which would "destroy our whole apprenticeship structure."

He particularly assailed a government proposal whereby apprentice committees would place names in a fishbowl and choose the successful applicants at random. Such a system, Hutcheson said, would destroy procedures that select apprentices based on previous preparation, potential ability to master the trade, interest



Lee Rice



William Sidell



Rev. Halboth



Saul Horowitz



Edward J. Pratt



Dominic Rossi



John Doughit

and desire.

Hutcheson said the Carpenters recognize the "vital importance" of bringing youths from minority groups into apprenticeship and is actively participating in many government programs to bring them into the trade.

He pointed out that the Carpenters are now operating pre-apprentice training programs in 27 Job Corps Centers and 10 military installations that will prepare more than 3,300 previously unqualified youths for apprenticeship each year.

Edward Pratt, a member of the executive committee of the National Assn. of Home Builders, called upon members of the craft to turn out quality products.

"Though we supply a basic prod-

uct, we *still* must turn out a *quality* product," he emphasized.

Pratt told how he had started his career as a carpenter helper in Canada many years before, working at one time in Detroit.

The climax of the gala evening was the announcement of contest winners and the presentation of certificates to each contestant.

The award presentations were made by Technical Director Leo Gable and the Coordinating Judges, Paul Rudd and Richard G. Hutchinson.

The Finlay C. Allan Trophy was presented for the first time. Named for the late First General Vice President of the Brotherhood, a Detroit member, the Allan trophy is an impressive, pyramid-shaped award

which will bear the names of top winners, year by year for a period of 20 years. It was presented by John Harrington, secretary of the Detroit District Council, and will bear the names of this year's winners and be on display at the Brotherhood's Headquarters in Washington, D.C.

Richard G. Hutchinson, apprenticeship coordinator of the Seattle Chapter of AGC and a coordinating judge in the competition, presented the Olav Boen Trophy to the top carpenter winner. Paul Rudd presented the John R. Stevenson Trophy.

The Olav Boen trophy is named for a one-time West Coast leader in the training program. The late John R. Stevenson was a First General Vice President of the Brotherhood. ■

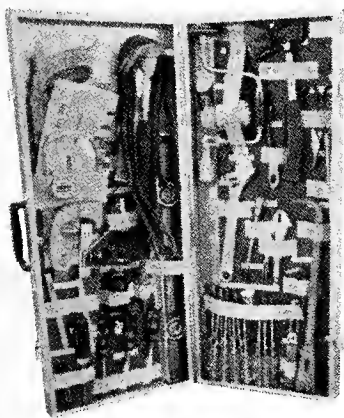

The tool box presented to the Carpenter winner by the Aluminum Box Manufacturing Company.

A view of the large audience of wives, sponsors, officers and guests who assembled for the awards banquet.





A view of the head table at the awards banquet.

A "Get Acquainted Dinner" was held on the evening preceding the International Apprenticeship Contest. Contestants, their wives, sponsors, and scores of guests assembled in a ballroom of the Hotel Pontchartrain for introductions of contest officials and members of the National Joint Apprenticeship Committee, for brief preliminary instructions, for dinner, and for photographs. The pictures below, taken at that time, show all of the contestants with the International Apprenticeship and Training officials, plus the wives and other women guests.



Working "behind the scenes" in the contest office were General Representative Joseph Lia; June Waddell, secretary to Technical Director Leo Gable; and Teresa Driver of the Detroit Apprenticeship Committee office.





Mr. and Mrs. Leo Gable were presented a special memento. They are shown with B. F. Sanford and William Sidell.



Grouped with the three top winners on the awards platform are from left: General President Hutcheson, Detroit Council Secretary John Harrington, the winners, Mrs. Finlay C. Allan, Technical Director Gable, and First General Vice President Sidell.



Shown with the new Finlay Allan Trophy are GEB Member William Konyha, First General Vice President Sidell, Technical Director Gable, and Editor Terzick.

Contestants and sponsors registered at the Contest Registration desk in the lobby of the Pick-Fort Shelby Hotel. Here Ken Danielson, Iowa Carpenter champion, and John David Trimble, Illinois Mill-cabinet champion, and their wives register with General Representative John Sheppard, Detroit Business Agent John E. Rogers, J. W. Howard of California, and Marlene Stanek, secretary to Ralph Caruso, president of Millwrights Local 1102.



TOOL COLLECTION IS CONTEST ATTRACTION



An extensive collection of antique craft tools was exhibited at the International Carpenters Apprenticeship Contest by Ed Cooper of Local 1461 Traverse City, Michigan.

The collection assembled over a period of more than 30 years, contains more than 1,100 tools.

The collection is inspected here by General President Hutcheson, First General Vice President Sidell, and Editor Peter E. Terzick.

Larry Johnson, executive director of the Vocational Industrial Clubs of America, at the far right end of the table, describes the work of his organization at the meeting of the National Joint Apprenticeship Committee in Detroit.



NATIONAL JOINT APPRENTICE- SHIP COMMITTEE GUIDES CONTEST

■ Twelve stout-hearted union and management leaders and two men who serve as professional advisors make up the National Joint Apprenticeship and Training Committee, which directs the year-round program of education and training in the craft.

Four men of this committee plus four more men from labor and management make up the International Carpenters Apprenticeship Contest Committee.

Both of these committees convened just prior to the annual contest to review plans for the pending competition and plan for the ones of future years.

Their sessions were held last month in the Hotel Pontchartrain, where plans were laid to hold next

year's contest in Las Vegas, Nevada.

Current membership of the National JAC includes: For the employers—Ed Wasielewski, chairman; Syd Carnine, George D. Johnson, Jr., Fred A. Lehn, Lee Rice, and David Rutherford. For the Brotherhood—Nicholas Loope, secretary; Leo Gable, Frank J. McNamara, C. M. Sanford, William Sidell, and George Vest, Jr. Advisory members are Dr. Frank E. Biley and Hal Jennrich.

The International Contest Committee is composed of the following: For the employers—Lee Rice, secretary; Bruce Campbell, Syd Carnine, and Richard Hutchinson. For the Brotherhood—Leo Gable, chairman; Raymond Fair, Paul Rudd, and C. M. Sanford. ■

A Note of Thanks...

The International Carpenters Apprenticeship Contest Committee is deeply grateful to the organizations which, through their cooperation, contributed to the success of the 1971 Contest. The contributors included:

Aluminum Box Mfg. Company
American Plywood Association
American Technical Society
Anchor Steel & Conveyor Company
Andrews & Owens-Rockwell Manufacturing Co.
Black and Decker Tool Company
Commercial Contracting Company
Darin & Armstrong Company
Detroit Ball Bearing Company
Detroit Carpentry Apprentice School
Greenfield Tap & Die, Greenfield, Massachusetts
Wally Kosorski

Light Guard Armory
Link Belt Company
National Forest Products Association
Overhead Conveyor Company
The Pick-Fort Shelby
Hotel Pontchartrain
Rapidstan Company
Charles Strelinger Company
J. B. Webb Company
Whitman & Barnes Company
James B. Willer Company



The placard shown above was one of many displays at the 1971 Contest which acknowledged the support of manufacturers, organizations, and suppliers.

*We Urge You To Patronize These Organizations
And Manufacturers Whenever Possible*



PETER E. TERZICK

Peter Terzick Retires as General Treasurer

■ After 34 years of service as Local Union officer, District Council secretary, editor of THE CARPENTER, and General Treasurer of the United Brotherhood, Peter E. Terzick decided last July that the time had come to retire. He tendered his resignation as General Treasurer to the July meeting of the General Executive Board, and the Board accepted it with regret.

Brother Terzick began his union career as a vice president of Local Union 2635, Seattle, Wash., which later merged into Local Union 2519, also of Seattle where he still holds membership.

In 1937, he assumed editorship of THE UNION REGISTER, the Brotherhood's West Coast publication for lumber workers. He served as secretary of the Puget Sound District Council for several years prior to moving to the General Office in 1943 to become editor of THE CARPENTER.

In January of 1961, he was appointed General Treasurer by General President M. A. Hutcheson, when the office was left vacant by the death of Brother Frank M. Chapman. He was subsequently elected by the Conventions of 1962, 1966, and 1970.

Throughout the years he has continued to edit the journal. Under his directorship, THE CARPENTER has won a number of awards for editorial excellence. In 1957 he was elected president of the International Labor Press Association.

Brother Terzick has been active in many fields closely related to labor—education, conservation and legislation.

Over the years, he has served as president of the Indiana State Association for Adult Education and vice

Continued on Page 30

Charles Nichols Succeeds Terzick in Finance Post

■ Charles E. Nichols of Sacramento, Calif., who represents the Eighth District on the General Executive Board, has been named to succeed Peter E. Terzick as General Treasurer of the Brotherhood.

Nichols, 50, a native of Desdemona, Tex., joined the union on June 3, 1946, in Crystal Bay, Nev. He moved his book from Local 2035 (now defunct) to Local 180, Vallejo, Calif., in October, 1946, where he worked in the Vacaville area.

With a daughter of school age, he and his wife moved to Visalia, Calif., where he transferred his book into Local 1484. He took an active part in the local union's affairs, becoming its recording secretary. Later he was secretary-treasurer of the Tulare and Vicinity District Council of Carpenters, president of the Tulare and Kings Counties Central Labor Council, and president of the Tulares and Kings Counties Building Trades Council.

He was a leader in many other labor organizations in California when, in June, 1956, General President M. A. Hutcheson called him to the Brotherhood Headquarters, then located in Indianapolis, Ind., and appointed him a general representative and assigned him to the Hawaiian Islands.

He moved his family to the islands and began to organize. Starting with 126 union carpenters as a nucleus, he and a small staff succeeded in three and a half years in organizing more than 1800 carpenters into Local 745. (Today this local has in excess of 5,000 members and is one of the largest in the Brotherhood.)

He left Honolulu in July 1959, and was assigned to Fresno, Calif., where he assisted in a campaign

Continued on Page 30



CHARLES E. NICHOLS

Substitool.

The new Skil Tradesman's Program: if one of your Skil tools breaks down, you can use one of ours free.

From now on, when you buy a Skil Tradesman's tool and it goes down, you get another like it to use while yours is being fixed at your nearest Skil Service Center.

Usually, they can do the job while you wait. But if they can't, you get a service replacement tool to keep you going until yours is ready.

A Registration Card now comes with all the tools in the program. Just fill it out and send it in. Once you're registered, you're covered. And all the Skil tools you use the most and the hardest are included.

As a member of the Tradesman's Program, you get a special Tradesman's identification card. And a free personalized label for your Skil tool.

Also, you're eligible to apply for credit so you can even charge service. So that's it—get Skil and you've always got tools. Is it a deal?

Please send me details of the Substitool™ Program and a free Tradesman's catalog.

Name _____

Address _____

City _____ State _____ Zip _____

Mail to: Skil Corporation,
Dept. CA9, 5033 Elston Ave., Chicago, Ill. 60630.

SKIL®

Nobody was ever sorry he bought the best there is.



THE FREEZE HITS WAGE EARNER HARDEST

Do You Know What to Expect?

■ After three years of peering at the nation through rose-colored glasses, President Nixon last month finally looked reality straight in the face. What he saw jolted him into establishing a wage and price freeze of questionable effectiveness and considerable injustice to the nation's wage earners.

For three years joblessness has been growing alarmingly; prices have been skyrocketing at a rate unknown since the days of World War II. But month after month, Nixon spokesmen have been telling the world things were wonderful. The month joblessness jumped two-thirds of one percent, they would pick out something like a tenth of a percent drop in wholesale prices and say: "See, things are working out. Just be patient."

Then the following month when

wholesale prices jumped a full percentage point, they would boast: "Unemployment only rose one-fifth of a point last month as compared to two-thirds of a point the month before. This shows we are on the right track. Just be patient."

Month after month, labor has warned the Administration that the fiscal policies and foreign trade policies followed by the President were heading the nation toward a depression.

On August 14, the President finally conceded this fact. On that day he ordered his freeze on wages and prices.

The freeze hits hardest at the wage earner. Wages are rigidly frozen in virtually every category. On the other hand, a complicated and cumbersome program is supposed to freeze prices. The trouble

is that no one, including the people who wrote it, really know what it means.

Worse yet, there is no freeze on profits. They are free to climb as fast and as far as corporations can build them up. The wages which are denied workers through the freeze naturally will wind up in the coffers of corporations as additional profits.

Nearly every day since the freeze was announced, there have been statements and edicts supposedly designed to clarify the provisions of the freeze. Mostly these tend to obfuscate rather than illuminate.

The following analysis of the freeze consists of questions and answers officially expressed by the Cost of Living Council . . . for what they are worth . . . we are presenting them to our members:

GENERAL

Q: Does the wage-price freeze include Puerto Rico and the Trust Territories?

A: The U.S. Customs Zone is the boundary for the freeze. Puerto Rico is within the Customs Zone so it is included. The Trust Territories which are outside of the Customs Zone are not included.

Q: Does the freeze cover state payments under workmen's compensation laws to people disabled in job-related accidents?

A: No. These aren't prices, wages or rents.

WAGES AND SALARIES

Q: What is the definition of "wages and salaries"?

A: As used in the Executive Order, the term "wages and salaries" includes all forms of remuneration or inducement to employees by their employers, including but not limited to: vacation and holiday payments; bonuses; layoff and supplemental unemployment insurance benefits; night shift, overtime and other premiums; employer contributions to pension or annuity funds; payments in kind, job perquisites, cost-of-living allowances, expense accounts, commissions, discounts, stock options, payments for deferred compensation, and all other "fringe" benefits.

In addition, there may be no changes in working conditions which result in more pay per hour worked (for

example, a schedule which shortens the workweek without a proportionate decrease in pay).

Q: Can an employer reduce the official work day from eight hours to seven hours, and pay overtime beginning after the seven hours?

A: No. Wages and salaries include all forms of compensation including overtime. Indirect means to increase compensation above ceiling rates aren't permitted.

Q: Can an employer increase the number of days allowed off for purposes such as funerals, etc.

A: No. This constitutes an increase in fringe benefits.

Q: Are Americans working abroad for companies that are incorporated in the U.S. subject to the freeze?

A: Yes.

Q: Are deferred wage or salary increases which have been negotiated to take effect in the future permitted by the freeze?

A: No.

Q: How does the freeze affect people who work on commission or piece rates?

A: Commission rates or piece rates cannot be increased over those existing in the base period.

Q: How will wages and salaries be determined for new jobs?

A: Scales will be determined on the basis of compar-

able jobs within the affected business or firm. If no comparability exists within such entities, such scales will be determined on the basis of comparable jobs in nearby firms.

Q: Does the wage freeze apply to all employers regardless of the number of employees he employs?

A: Yes.

Q: In the case of a negotiated increase that became effective August 9, 1971, with payment for that week received by the employees on August 13, 1971, is it permissible to pay the retroactive portion of the increase which is currently being computed for the employees involved?

A: Yes.

Q: If a salary increase was granted and the employee actually performed under the new rate prior to August 15, 1971, can he be paid the higher rate if the pay day is after August 15?

A: Yes, if there are adequate records to demonstrate that the increase was put into effect prior to the freeze date.

Q: May scheduled pay raises which are dependent upon employees completing certain educational requirements be paid during the freeze?

A: Yes. Where the employer is willing to certify that an agreement was in existence that provided for increases in pay dependent on the employees' completing educational requirements for specific job levels, the pay increase can be granted. In effect, the action is a bona fide promotion. For example, a teacher who has been awarded a master's degree can receive the increment which is normally given. If the effective date of the teacher's contract is after August 14, the increment must be the amount that was granted last year.

Q: Employees are being severed for various reasons and will be due severance pay. Can they receive their severance pay if it is in excess of their normal pay rate that was in effect as of August 14.

A: Yes. If severance pay procedures are a part of the understood corporate procedure and the firm is willing to certify that this was the procedure they had in effect, severance pay may be paid.

Q: Are wage increases permitted during the freeze for workers whose wages are closely tied to increases for other workers that were negotiated before the freeze?

A: If the following conditions prevail, the increase may be granted:

1. the agreement to which the increases are linked was reached before August 15;

2. prior to August 15 work was performed (by the workers whose wages are closely tied to the increases reached before the freeze) that would be eligible for payment at the new rate;

3. the increased wage rate for the workers whose wages are closely tied to negotiated increases was scheduled to go into effect on the same day as the negotiated wage increases as a matter of established practice;

4. the workers are employees of the same firm; and

5. the company is able to demonstrate that this procedure is an established practice.

PROMOTIONS

Q: What is the policy on promotions?

A: (a) Bona fide promotions that constitute an ad-

vancement to established job with greater responsibility are allowed.

(b) Increases in certified apprentice and learner's rates under programs established prior to August 15 are allowed.

(c) Merit and longevity increases are not allowed.

COST-OF-LIVING AND AUTOMATIC INCREASES

Q: Are future cost-of-living increases built into wage contracts or provided by management exempt?

A: No. There will be no cost-of-living increases during the 90-day freeze.

BENEFITS

Q: Can an employer reduce wages and other benefits to employees and use the President's freeze as a justification?

A: The President's program does not require a reduction in compensation levels below those in effect on August 15.

FEDERAL GOVERNMENT

Q: Are Federal Government employees wages and salaries frozen?

A: Yes.

STATE AND LOCAL GOVERNMENT

Q: What effect does the Executive Order have on cost-of-living wage or salary increases ordered by a municipal government and to become effective subsequent to the date of the Executive Order?

A: State and local governments are subject to the Executive Order freezing wages and prices.

Q: Are the wages of such state and local governmental employees as firemen, policemen, and the like included in the freeze order?

A: They are subject to the freeze just as are all wages in private industry.

LABOR CONTRACTS AND NEGOTIATIONS

Q: Does the freeze terminate bargaining for wage changes during the 90-day period or can these proceed, with the understanding that they cannot take effect until the Federal Government permits?

A: The freeze does not terminate bargaining for wage changes during the 90-day period. However, no wage increase negotiated during the 90-day period can go into effect during the period of the freeze.

Q: If a strike is now in progress, what kind of contract can be approved?

A: Contract negotiations can proceed during the course of the freeze. However, as indicated, no increases can go into effect during the period the freeze is in effect. In addition, no strike can occur aimed at increasing wages not permitted by freeze.

Q: Can a union and management negotiate for pay increases to be effective after the date of the freeze but also retroactive to cover the freeze period?

A: No.

Q: A labor agreement ratified by the union membership on which the company was notified by the union 1:00 p.m. on August 14 was retroactive to the date the contract expired. The agreement included the special

allowance for employees working in special areas in certain cities which were payable beginning August 15, 1971. Certain employees were, in fact working throughout the day on August 15. Can employees so covered be paid at the new rate during the freeze period?

A: Yes, the key point is that all terms of the agreement were reached and are considered in effect before the freeze began.

FOREIGN EMPLOYEES

Q: Are employees who are U.S. citizens employed by U.S. firms abroad subject to the freeze?

A: Yes.

SERVICES

Q: Are fees for professional services such as doctors and lawyers included in the freeze order?

A: Yes. No increases in rates or fees for particular services are permitted during the freeze.

EDUCATION, TUITION

Q: Are previously announced increased tuition rates for the 1971-72 school year permitted by the freeze?

A: Yes. These are considered transaction prices, since commitments have been made, and there are a number of cases where payments have been made.

INSURANCE

Q: Will the freeze apply to insurance rates?

A: Yes, and to all other similar fees and rates.

Q: Where insurance policies are being renewed at a higher price rate that has been in effect prior to August 15, is the price of an individual policy frozen at the old rate or may the new rate be applied across-the-board since it was in effect prior to August 15?

A: Yes. Policies can be renewed at the higher price that was the prevailing price for that product for substantial transactions prior to August 15 in the month period ending August 14.

BUSINESS SERVICES

Q: If a business reduces services and maintains the same price, is this permitted by the freeze?

A: No, this amounts to an increase in price for a product.

PRICES

Q: Are wholesale and retail prices included in the freeze?

A: Yes.

Q: If a business reduces services and maintains the same price, is this permitted by the freeze?

A: No, this amounts to an increase in price for a product.

Q: Can merchants and other commercial businesses pass on to consumers the cost of an increase in local and state taxes; i.e., property tax or business tax increases.

A: No.

Q: How will a substantial volume of transactions be determined for use in establishing the ceiling prices?

A: The ceiling price is the price at or above which 10% of the actual transactions during the base period were made, except that in the case of increases in posted

and effected prices during the base period, the base period itself will be considered to have begun at the time of the increase in posted and effective prices.

Q: If price increases were announced prior to August 14, but no transactions took place, can they proceed with the price increase?

A: No.

Q: What is the selling price for a material if there have been dual price situations, i.e., a published price and a discounted price at which actual transactions were made?

A: The maximum price at which sales may be made is the highest price at which a substantial volume of actual transactions were made during the 30-day period of time ending August 14. If products have been selling at a discounted price and not at the published price during the base period, the effective price would be the highest discounted price at which substantial transactions were made.

Q: Should records be maintained for other than the specified base period (Sec. 1(b)) if another period is used to establish prices?

A: The Order is interpreted to require this.

Q: Does the freeze on prices prevent lowering of prices?

A: No, on the contrary, it is hoped that this will occur.

Q: Are prices of used commodities, such as used cars, antiques, and resales of housing included in the freeze?

A: Yes.

Q: How do you price new products?

A: Use the price of the most nearly comparable product sold by your closest comparable competitor.

Q: May price increases announced prior to August 15 take effect in the future?

A: No, all prices, unless specifically exempted, are frozen according to terms of the Order.

Q: I want to sell something I own. I have no idea what its price was during the month prior to August 15. What should I do?

A: Inquire locally as to what comparable items sold for during the period July 15-August 15. Note down and retain these facts for your own records before selling.

Q: What is the price-freeze basing-point for national or regional retail chains?

A: Price ceilings are to be set on the basis of the normal procedures used in establishing market prices. Market price ceilings are to be established at no greater than the highest price at which substantial volume of transactions were carried out by the firm's individual normal pricing areas, regardless of whether these pricing areas are national, regional, or individual stores.

PUBLIC UTILITIES

Q: Are rates charged by common carriers and public utilities included in the freeze?

A: Yes, whether regulated by government agencies or set independently.

RENTS, HOUSING

Q: How will the rent ceiling be determined for new or previously unrented units.

A: The standard will be that generally prevailing for comparable units in the immediate area.

Q: Are apartment house and other rent fees included in the freeze?

A: Yes.

Q: If a rent agreement is signed August 1 but effective date is after August 15, does increase apply.

A: No.

Q: Are increases in rents allowed, if major improvements in the rental property are made?

A: If substantial improvements are made in the rental property, an increase to the level of rents charged for comparable properties in the area is allowable.

Q: Are motel, hotel, etc., rates included in the freeze?

A: Yes.

IMPORTS

Q: Can the 10 percent import tax be applied to goods already in stock?

A: No.

EXPORTS

Q: Is there any price control over exports?

A: No.

INVESTMENTS, FINANCE

Q: Are stock and bond prices included in the freeze?

A: No.

Q: Why are stocks different from other types of property?

A: Basically, there is no difference. However, an exception has been made to facilitate equity adjustments related to stabilization actions and to avoid major market disruptions at the end of the freeze period.

INTEREST RATES

Q: Are interest rates included in the freeze?

A: No.

TAXES, GENERAL

Q: In cases where surcharges or other sales or excise taxes have been increased, is the ceiling for the price paid by the customer (including these taxes) raised by a like amount?

A: Yes. The price the customer pays is equal to the base price, plus these taxes. This ruling applies to imported goods as well as other goods which are directly taxed.

AUTOMOBILE EXCISE

Q: Must auto dealers continue to charge the 7% excise sales tax on 1971 model year-end automobile sales?

A: Yes, the excise tax remains in effect and must be collected until such time as Congress rescinds it. The President has requested authority to rescind the excise tax, retroactive to August 15. If this authority is approved by Congress, rebates will be made to automobile purchasers.

STATE AND LOCAL TAXES

Q: Are state and local tax rates frozen during this period?

A: No.

Q: Can merchants and other commercial businesses pass on to consumers the cost of an increase in local and state taxes; i.e., property tax or business tax increases.

A: No.

LAYOUT LEVEL



- ACCURATE TO 1/32"
- REACHES 100 FT.
- ONE-MAN OPERATION

Save Time, Money, do a Better Job
With This Modern Water Level

In just a few minutes you accurately set batters for slabs and footings, lay out inside floors, ceilings, forms, fixtures, and check foundations for remodeling.

HYDROLEVEL is the old reliable water level with modern features. Toolbox size. Durable 7" container with exclusive reservoir, keeps level filled and ready. 50 ft. clear tough 3/10" tube gives you 100 ft. of leveling in each set-up, with 1/32" accuracy and fast one-man operation—outside, inside, around corners, over obstructions. Anywhere you can climb or crawl!

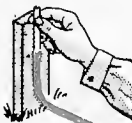

Why waste money on delicate instruments, or lose time and accuracy on makeshift leveling? Since 1950 thousands of carpenters, builders, inside trades, etc. have found that HYDROLEVEL pays for itself quickly.

Clip this ad to your business stationery and mail today. We will rush you a Hydrolevel with complete instructions and bill you for only \$7.95 plus postage. Or send check or money order and we pay the postage. Satisfaction guaranteed or money back.

Ask your tool dealer to order it for you. We allow the usual dealer discount on 1/4 Doz. lots and give return-mail service.

HYDROLEVEL

925 DeSoto, Ocean Springs, Miss. 39564

FIRST IN WATER LEVEL DESIGN SINCE 1950

Made to put in a hard day's work

Designed by Carpenters
Especially for Carpenters

There's plenty of comfort, convenience and work-saving features in these overalls. Made just like you want 'em... because they're designed by workers like yourself. Guaranteed to be the best you've ever worn or we'll take 'em back. No questions asked.

Lee

[®] UNION MADE
M.R. CARPENTERS'
OVERALLS

H. O. LEE COMPANY, INC.
SHAWNEE MISSION, KANSAS 66201

"World's largest manufacturer of
union-made work clothes."

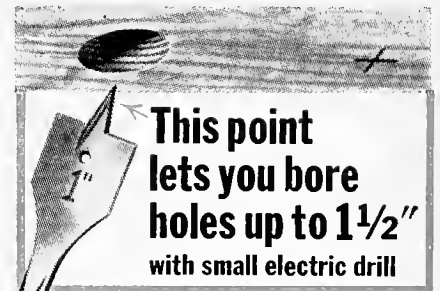

This point
lets you bore
holes up to 1 1/2"
with small electric drill

IT'S HOLLOW GROUND to bore
cleaner, faster at any angle

Now step-up the boring range of your small electric drill or drill press to 1 1/2" with Irwin Speedbor "88" wood bits. 1/4" shank chucks perfectly. No wobble. No run-out. Sharp cutting edges on exclusive hollow ground point start holes faster, let spade type cutters bore up to 5 times faster. You get clean, accurate holes in any wood at any cutting angle.

Each Irwin Speedbor "88" forged from single bar of finest tool steel. Each machine-sharpened and heat tempered full length for long life. 17 sizes, 1/4" to 1 1/2", and sets. See your Irwin hardware or building supply dealer soon.

IRWIN SPEEDBOR "88" WOOD BITS

at Wilmington, Ohio, Since 1885

Figure The Odds!

Something unusual occurred during the British Columbia Carpentry Apprenticeship contest, held in Burnaby, B.C., on June 10 and 11, 1971. Chris Cottier of Local 1598, Victoria, repeated the performance of his brother during the previous year's contest and was judged the first-place winner. The mathematical odds against two brothers winning a state or provincial competition in successive years are tremendous, so don't bother trying to figure them out. After his victory in Burnaby, Cottier went on to win in the International Apprenticeship Contest in Detroit, Michigan.

TERZICK RETIRES

Continued from Page 24

president of the American Forestry Association.

Currently, he is chairman of the AFL-CIO Technical Committee on Problems of Older and Retired Workers.

As director of the Carpenters Legislative Improvement Committee (CLIC), he has worked diligently and effectively for the kind of legislation the labor movement is particularly concerned with.

His appearances before various Congressional committees considering specific legislation of importance to the working man have been numerous.

Although officially retiring as General Treasurer as of July 31, Brother Terzick will continue to edit the Journal and to cooperate with our Brotherhood's legislative programs.

He and Mrs. Terzick will continue to reside in the Washington area.

The editorial office of *The Carpenter* will be maintained at the General Office.

NICHOLS SUCCEEDS

Continued from Page 24

against District 50. While there, President Hutcheson reassigned him to Alaska, where he helped to defeat an independent union attempting to raid the Brotherhood jurisdiction.

He left Alaska for a special Brotherhood Convention in Chicago,

Nichols Receives 1971 Bent Nail Award; First General Vice President Honored



At ceremonies held during the recent 1971 Legislative Conference of the California State Council of Carpenters, General Executive Board Member Charles E. Nichols was presented with The Bent Nail Award, highest award which can be received by a carpenter in California, in recognition of his great contributions to the Brotherhood in California and to the labor movement in general. Presenting the award to Nichols were, from left, Dean Wittle, secretary of Local 1507 in El Monte, Calif., and Bill Walker, financial secretary of Local 1109 in Visalia, Calif.



Also honored at the California State Conference was William Sidell, First General Vice-President. Both Sidell and Nichols received gold watches, presented here by the secretary of the Los Angeles County District Council, Gordon A. McCulloch, in recognition and appreciation of work done on behalf of the Los Angeles County District Council.

where President Hutcheson assigned him to work in Northern California, Nevada, and Utah. He handled jurisdictional disputes, internal problems and served as chairman and secretary of the National Highway Committee for Nevada and Utah.

On July, 1966, he received a telegram from General Headquarters in Washington, D.C., notifying him

that he had been named to fill a vacancy on the General Executive Board.

He served in this capacity until the new appointment. He and Mrs. Nichols have now moved to the Washington Metropolitan area and established residence. He began work at the General Headquarters early in September.

Land Costs Create Crisis in Canada

Canada faces a serious urban crisis unless it pays more attention to the needs of large low-income families and elderly people.

This doesn't sound like anything new but it was said by Professor Lawrence Smith of the University of Toronto even as he admitted that Canadians are better housed than ever before.

The things that have to be changed, he said, are transportation, zoning, taxation and building code policies.

Rising land costs in urban areas are making older single family dwellings uneconomical.

So these are converted into high priced town houses or torn down for high rise developments. The former tenants are forced to move.

The basic problem is not so much one of housing as of incomes. Private enterprise cannot produce large, low-cost dwellings under present procedures and regulations.

He suggested that more land be opened for development.



These FREE BLUE PRINTS have started thousands toward BETTER PAY AND PROMOTION

That's right! In all fifty states, men who sent for these free blue prints are today enjoying big success as foremen, superintendents and building contractors. They've landed these higher-paying jobs because they learned to read blue prints and mastered the practical details of construction. Now CTC home-study training in building offers you the same money-making opportunity.

CASH IN ON YOUR EXPERIENCE

For over 67 years, building tradesmen and beginners alike have won higher pay with the knowledge gained from Chicago Tech's program in blue print reading, estimating, foremanship and contracting. Through step-by-step instruction, using actual blue prints and real specifications of modern, up-to-date buildings, you get a practical working knowledge of every building detail—a thorough understanding of every craft. And as a carpenter or apprentice, you already have valuable experience that may let you move up to foreman even before you complete your training.

Don't waste a single day. Start preparing right now to take over a better job, increase your paycheck and command greater respect as the "boss" on the job. Find out about Chicago Tech's get-ahead training in building. Send for your free blue prints and trial lesson — today! Approved for Veterans.

LEARN IN YOUR SPARE TIME

As you know, the ability to read blue prints completely and accurately determines to a great extent how far you can go in building. What's more, you can learn plan reading simply and easily with the Chicago Tech system of spare-time training in your own home. You also learn all phases of building, prepare yourself to run the job from start to finish.

CHICAGO TECHNICAL COLLEGE

M-143 TECH BLDG., 2000 S. MICHIGAN AVE., CHICAGO, ILL. 60616

FREE BLUE PRINTS AND TRIAL LESSON

Send for your free trial lesson now. You'll agree that this training is simple yet practical—your surest way to promotion and increased income in building.

MAIL COUPON TODAY

Chicago Technical College New G.I. Bill!
M-143 Tech Bldg., 2000 S. Michigan Vets check here
Chicago, Illinois 60616

Please mail me Free Trial Lesson, Blueprints and Catalog.

Name _____ Age _____

Address _____

City _____ State _____ Zip _____

Occupation _____

Accredited Member National Home Study Council

You'll Like Being a SKILLED LOCKSMITH

You'll EARN MORE, LIVE BETTER
than Ever Before in Your Life

You'll enjoy your work as a Locksmith because it is more fascinating than a hobby—and highly paid besides! You'll go on enjoying the fascinating work, year after year, in good times or bad because you'll be the man in demand in an evergrowing field offering big pay jobs, big profits as your own boss. What more could you ask!

Train at Home—Earn Extra \$\$\$\$
Right Away!

All this can be yours FAST regardless of age, education, minor physical handicaps. Job enjoyment and earnings begin AT ONCE as you quickly, easily learn to CASH IN on all kinds of locksmithing jobs. All keys, locks, parts, picks, special tools and equipment come with the course at no extra charge. Licensed experts guide you to success.

Illustrated Book, Sample Lesson
Pages FREE

Locksmithing Institute graduates now earning, enjoying life more everywhere. You can, too. Coupon brings exciting facts from only school of its kind. Lic. by N. J. State Dept. of Ed., Accredited Member, Nat'l Home Study Council. Approved for Veteran Training.

LOCKSMITHING INSTITUTE

Dept. of Technical Home Study Schools
Dept. 1118-091 Little Falls, N. J. 07424



Earned \$150 During Training
I realized with LOCKSMITHING I'd be able to double my income. During my training period I made \$150.
Paul Funes
New York, N.Y.



LOCKSMITHING INSTITUTE, Dept. 1118-091
Little Falls, New Jersey 07424 Est. 1948

Please send FREE illustrated Book—"Your Big Opportunities in Locksmithing," complete Equipment folder and sample lesson pages—FREE of all obligation—(no salesman will call).

Name _____ (Please Print)

Address _____

City _____ State _____ Zip _____

Check here if Eligible for Veteran Training

YOU GET MORE
OUT OF THEM
'CAUSE
VAUGHAN
PUTS MORE
INTO THEM!

... AND HAS FOR
MORE THAN
100 YEARS



999

A 20 oz.
heavy duty
beauty. Large
striking face.
14" or 16"

top grade
hickory
handles.
Plain or
millet face.



FIBERGLASS

Exclusive hollow core
design adds greatest
strength, better
balance, absorbs
more shock,
13 to 20 oz.
sizes, nail
and rip.



**RIG
BUILDER'S
HATCHET**

Polished 22 oz.
striking head with
flat milled face.
Special 17"
hand
comfort
handle.

Superbar
with fins secures

SUPER BAR

15" all
purpose pry bar.
A must for every
tool box.

Request catalog illustrating
complete line of striking
tools and pry bars.



**VAUGHAN & BUSHNELL
MFG. CO.**

11414 MAPLE AVE., HEBRON, ILL. 60034

Black & Decker Recalls 30,000 Radial Saws

The Black & Decker Manufacturing Co. has recalled about 30,000 units of one of its saws because of a potential safety hazard. The company sent letters to all known owners of its stationary radial arm saw, model No. 7700, asking them to return the arm and motor assembly unit of the saw to the company, at the company's expense for changes.

"There are conditions when operating the saw that could cause the sawhead to separate from the radial arm and present a potential safety hazard," a company statement said. Company engineers have developed safety features that provide a safeguard against the possibility of such occurrences, the statement added.

Any Model 7700 saws should be shipped to: Mr. Charles Costa, Black & Decker Manufacturing Co., 701 East Joppa Road, Towson, Md. 21204

Lambert, Ernst Honored in N. Y.



Erving B. Lambert, former business agent of Local 281 Binghamton, N.Y., and Arthur Ernst, business agent for Plumbers' Local 112 for 28 consecutive years, were the special guests of the Binghamton, N.Y., Building Trades Council at a recent luncheon honoring their 62 years of combined service to the labor movement.

Mr. Lambert, who served 34 years as Carpenter business agent, told the gathering that the jurisdictional disputes which have been plaguing the construction industry in recent years can be eliminated. "The device," he said, "is to put the articles of jurisdiction in the proper agreement, and to withhold them from the agreements in which they don't belong." He added that the place to settle jurisdictional disputes is the bargaining table, not the picket line.

THE THIRD HAND OF A PANELING MAN

Take all the guesswork out of aligning and marking corner panels with our kit of rugged aluminum off-set jigs and marking gauges.

Increase your speed and accuracy as you scribe perfect panels marked for a "pressed-in" fit. Panel-by-panel instructions included for inside and outside corners and for the location of cut-outs. Designed for plywood panels of 1/4" or less.

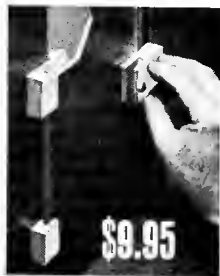

Patented U.S.A.

OFFSET JIGS FOR ROUTERS

A Cut-In-Place method of fitting inside corner panels. The router takes the place of the marking gauge or scriber and precisely cuts over 90% of an 8 ft. panel. Any router can be adapted to these jigs. Cut-In-Place kits are designed for plywood panels of 1/2" or less.

- Offset jigs and marking gauges, \$9.95 Postpaid.
- Cut-In-Place jigs for your router, \$6.95 Postpaid.

C.O.D. orders: you pay postage and charges. Satisfaction guaranteed or money refunded.

For rush orders please add 50¢
PANELING SPECIALTIES CO.
Three Lakes, Wisconsin 54562

Full Length Roof Framer

A pocket size book with the ENTIRE length of Common-Hip-Valley and Jack rafters completely worked out for you. The flattest pitch is 1/2 inch rise to 12 inch run. Pitches increase 1/2 inch rise each time until the steep pitch of 24" rise to 12" run is reached.

There are 2400 widths of buildings for each pitch. The smallest width is 1/4 inch and they increase 1/4" each time until they cover a 50 foot building.

There are 2400 Commons and 2400 Hip, Valley & Jack lengths for each pitch. 230,400 rafter lengths for 48 pitches.

A hip roof is 48'-9 1/4" wide. Pitch is 7 1/2" rise to 12" run. You can pick out the length of Commons, Hips and Jacks and the Cuts in ONE MINUTE. Let us prove it, or return your money.

Getting the lengths of rafters by the span and the method of setting up the tables is fully protected by the 1917 & 1941 Copyrights

In the U.S.A. send \$3.00. We pay the postage. California residents add 15¢ tax. C.O.D. orders O.K. See your Post Office for a Money Order.

We also have a very fine Stair book 9" x 12". It sells for \$2.00. We pay the Postage. California residents add 10¢ tax.

A. RIECHERS

P. O. Box 405 Palo Alto, Calif. 94302

Local Officers Installed in Pomona



Last July 13, Local 1752, Pomona, Calif., installed its officers for the next three years. They are:

Front row, left to right, warden: Bob Doty; trustee: Richard DeMars; financial secretary: Joseph C. Eickholt; business representative: George E. Berard; recording secretary: Marlin E. Harris; trustee: Herbert Gee; vice president: Deeden Scruggs.

Back Row, L. to R. conductor: Aurelio Ruiz; treasurer: James Stoddard; president: Clyde Cable; assistant secretary-treasurer of Los Angeles County District Council of Carpenters: Russel Auten; trustee: Ralph Snedeker; business representative: Elmer Torgersen.



On July 13, Ladies Auxiliary No. 647, Pomona, Calif., installed officers for the ensuing year. They are, front row, left to right: recording secretary: Mary Svedas; president: Margaret Berard; vice president: Sharon Eickholt; treasurer: Doris Hietikko.

Back row, left to right: conductor: Sue Snedeker; trustee: Buena Lance; trustee: Thelma Rogers. Not in picture: Trustees Ruth Doty and Florence Stinson.

Local 1296 Officers, San Diego, California



During recent ceremonies honoring the 25-year members of the union, Local 1296 officers assembled for a group picture. They included, from left: George Murrell, vice president; Neal Cole, conductor; King Taylor, Sr., trustee; Earl Emmert, trustee; Lawrence McDaniel, president; Luis P. Adams, financial secretary; and Henry Kuehn, warden.

My Spare Time Hobby Makes Me

\$5⁰⁰ AN HOUR

**CASH
PROFIT**



Here's How You Can Start Your Own Spare Time Business!

There's a lot of business waiting for the man who can sharpen saws, planer knives, jointer blades, wood chisels, scissors, axes and other garden, shop and home tools.

Belsaw SHARP-ALL does all these jobs quickly with precision and at a big profit for you. You can become Sharpening Headquarters for carpenters, builders, lumber yards, factories, home workshop hobbyists. And, you can start this Money-Making business for less than \$50.

FREE BOOK tells how to start your own spare time business while you are still working at your regular job. People bring in their work and pay cash—over 90c of every dollar you take in is cash profit, *David Swanson—Utica, Michigan*: "Last year I earned \$3500.00 just in my spare time. Now I am retired from my daily work so I can put in full time sharpening. It's great to be your own boss. I can thank Belsaw for the success I have accomplished."

C. A. Cossgrove—Winter Haven, Fla.: "I am presently working as much as I care to. My Belsaw grossed me over \$500 a month for the past four months. Pretty good for a 78 year old man."

Donald Harker—Aurora, Illinois: "Work is wonderful here in Aurora. Have been doing about \$350 to \$450 a month worth of saws and other tools."

Take advantage of my 30-DAY FREE TRIAL and let me prove how you too can start a low-cost, high paying sharpening business of your own.

RUSH COUPON TODAY!

**FREE
BOOK**

No Obligation...No Salesman Will Call

BELSAW SHARP-ALL CO.

Stan Field, President

7325 Field Bldg., Kansas City, Mo. 64111

Send Free Book "LIFETIME SECURITY".

Name _____

Address _____

City _____ State _____ Zip _____



REPORT

'Enclosed Find My Check for One Buck'

Every dollar donated to the Carpenters Legislative Improvement Committee is naturally appreciated. However, a dollar recently donated by Brother Peter J. Wadika is especially appreciated, because it represents a personal sacrifice. The following letter, which accompanied Brother Wadika's contribution, speaks for itself:

Mr. Peter E. Terzick
 Director
 Carpenters Legislative Improvement Committee

Dear Sir and Brother:

On March 16, 1971, I suffered a myocardial enfarction. I am a journeyman millwright. I am married—three children and am 47 years old. My future as a craftsman looks bleak, as I am unable to resume my regular duties since March 16, 1971.

I have been a member of Local 261 for over five years. I intend to continue paying dues.

I read with interest the March issue of THE CARPENTER and have been waiting since then to make my contribution to CLIC's '71 drive. Enclosed find my check for one buck. If this is all it takes to be a charter member, count me in; if not, how much?

Please forward any pertinent literature pertaining to CLIC.

Yours truly,
 /s/ Peter J. Wadika

"CLIC" CONTRIBUTIONS (as of 7-17-71)			Local	City	Amount	
Local	City	Amount	COLORADO			
			2834	Denver	24.00	
			CONNECTICUT			
			30	New London	40.00	
			DISTRICT OF COLUMBIA			
			2311	Washington, D.C.	30.00	
			FLORIDA			
			819	W. Palm Beach	30.00*	
			1308	Lake Worth	10.00*	
			1379	N. Miami	40.00	
			1966	Miami	20.00*	
			2024	Miami	30.00*	
			2770	W. Palm Beach	8.00	
			2795	Ft. Lauderdale	23.50	
			3206	Pompano Beach	10.00*	
			GEORGIA			
			225	Atlanta	10.00*	
			ILLINOIS			
			58	Chicago	1,521.50	
			80	Chicago	753.50	
			169	E. St. Louis	48.00	
			242	Chicago	29.00	
			461	Highwood	100.00	
			1784	Chicago	61.00	
			2014	Barrington	27.00	
			2094	Chicago	48.00	
			CALIFORNIA			
				162 San Mateo	11.00	
				483 San Francisco	229.00	
				586 Sacramento	243.00	
				751 Santa Rosa	22.00	
				1300 San Diego	13.00	
				1358 La Jolla	32.00	
				1381 Woodland	6.00	
				1479 Redondo	8.00	
				2020 San Diego	16.00	
				2048 Corona	20.00	
				71 Fort Smith	\$ 1.00*	
				529 Camden	1.00*	
				576 Pine Bluff	2.00*	
				690 Little Rock	1.00*	
				891 Hot Springs	1.00*	
				1249 Fayetteville	20.00	
				1470 Conway	1.00*	
				1627 Mena	1.00*	
				1683 El Dorado	1.00*	
				1836 Russellville	2.00*	
				2045 Helena	1.00*	
				2697 Magnolia	1.00*	
				625 Manchester	51.00	
				921 Portsmouth	10.00	
				253 Omaha	27.00	
				325 Paterson	118.00	
				399 Phillipsburg	20.00	
				490 Passaic	40.00	
				1489 Burlington	500.00	
				1132 Alpena	10.00*	
				1615 Grand Rapids	11.00	
				548 Minneapolis	18.00	
				766 Albert Lea	32.50	
				28 286 557 670 718 911 1172 1639 2225 2405 2581 2719 2812 3038	Missoula Anaconda Great Falls Bozeman Polson Havre Kalispell Billings Thompson Fall Libby Kalispell Libby Thompson Fall Missoula Bonner	3.00* 1.00* 4.00* 4.00* 1.00* 3.00* 6.00* 4.00* 2.00* 2.00* 2.00* 1.00* 1.00* 2.00* 6.00*
				670 718 911 1172 1639 2225 2405 2581 2719 2812 3038	Polson Havre Kalispell Billings Thompson Fall Libby Kalispell Libby Thompson Fall Missoula Bonner	1.00* 3.00* 6.00* 4.00* 2.00* 2.00* 2.00* 1.00* 1.00* 2.00* 6.00*
				253 Omaha	27.00	
				625 Manchester	51.00	
				921 Portsmouth	10.00	
				325 Paterson	118.00	
				399 Phillipsburg	20.00	
				490 Passaic	40.00	
				1489 Burlington	500.00	
				1319 Albuquerque	62.00	
				6 Amsterdam	40.00	
				53 White Plains	100.00	
				117 Albany	417.00	
				135 New York	218.00	
				257 New York	520.00	
				543 Mamaroneck	80.00	
				1135 Port Jefferson	30.00	
				1167 Smithtown Branch	60.00	
				1772 Hicksville	41.00	
				1978 Buffalo	20.00	
				29 Cincinnati	286.00	
				200 Columbus	135.00	
				248 Toledo	66.00	
				650 Pomeroy	60.00	
				329 Oklahoma City	10.00*	
				2013 Ada	1.00*	
				738 Portland	40.00	
				1157 Lebanon	18.00	
				261 Scranton	1.00	
				288 Homestead	1.00*	
				833 Berwyn	20.00	

Local	City	Amount
RHODE ISLAND		
176	Newport	84.00
TEXAS		
14	San Antonio	30.00*
198	Dallas	120.00*
213	Houston	75.00*
379	Texarkana	40.00*
411	San Angelo	30.00*
425	El Paso	25.00*
526	Galveston	30.00
610	Port Arthur	35.00*
622	Waco	15.00*
665	Amarillo	25.00*
724	Houston	20.00*
753	Beaumont	40.00*
973	Texas City	75.00*
977	Wichita Falls	15.00*
1066	Houston	15.00*
1084	Angleton	10.00*
1097	Longview	10.00*
1104	Tyler	15.00*
1226	Pasadena	30.00*
1334	Baytown	25.00*
1421	Arlington	30.00*
1423	Corpus Christi	55.00*
1634	Big Spring	30.00*
1751	Austin	20.00*
1822	Fort Worth	60.00*
1855	Bryan	15.00*
1884	Lubbock	45.00*
1971	Temple	10.00*
2190	Harlingen	25.00*
2232	Houston	10.00*
2534	Texarkana	20.00*
2572	Wichita Falls	10.00*
2848	Dallas	35.00*
3106	San Antonio	15.00*
VIRGINIA		
388	Richmond	78.00
WASHINGTON		
98	Spokane	10.00
756	Bellingham	31.00
770	Yakima	1.00*
1849	Pasco	2.00*
WYOMING		
1384	Sheridan	2.00
1564	Casper	35.00
WISCONSIN		
161	Kenosha	30.00
252	Oshkosh	12.00
264	Milwaukee	60.00
290	Lake Geneva	10.00
314	Madison	55.00
344	Waukesha	10.00
460	Wausau	30.00
630	Wisconsin Rapids	12.00
657	Sheboygan	10.00
755	Superior	10.00
836	Janesville	30.00
849	Manitowoc	35.00
955	Appleton	30.00
1053	Milwaukee	20.00
1074	Eau Claire	30.00
1143	La Crosse	25.00
1146	Green Bay	30.00
1181	Milwaukee	20.00
1208	Milwaukee	20.00
1344	Portage	10.00
1363	Oshkosh	10.00
1364	New London	20.00
1521	Algoma	10.00
1573	West Allis	15.00
1709	Ashland	20.00
1741	Milwaukee	50.00

* Includes contributions from delegates representing their local unions at the State Council Conventions. In some instances, these convention contributions were the only monies received from the local unions.

**Carpenters,
Contractors,
Custom Filers**

Save Time, Save Money

with **FAMOUS**

Foley
®

Sharpening Equipment

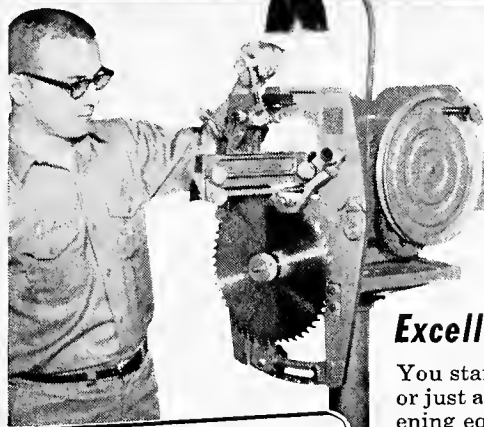

Amazing Foley saw filer sharpens circular, band and hand saws automatically. Exclusive jointing principle assures uniform teeth; assures perfect circular saw roundness. Does a perfect job every time. No experience or training needed. The Foley automatic saw filer is the ideal way to start a profitable business of your own.

Excellent Business Opportunity

You start large or small—put in a full day or just a few hours each week. Foley sharpening equipment does all the work for you and you make all the money. Foley saw filer, retoothing, power setter, 314 grinder and special precision carbide saw grinder will go to work providing a pleasurable, profitable business for you. Start in your basement or garage.

Earn \$6 an Hour

People just like you, all over the U.S.A. are making excellent profits right now. Many started small and expanded to full time rewarding businesses. You can, too, with Foley's exclusive money making plan.

FREE BOOKLET

Easy-to-read booklet, "Money Making Facts" tells how you can start profitable business of your own. Send now! No obligation. No salesman will call.



FOLEY MFG., Minneapolis, Minnesota 55418

Foley Manufacturing Co., 918-1 Foley Bldg.
Minneapolis, Minnesota 55418

Send Free Booklet today.

Name _____

Address _____

City _____

State _____ Zip Code _____

Other Foley Equipment

RETOOTHER cuts full set of even crosscut or rip teeth in less than a minute.

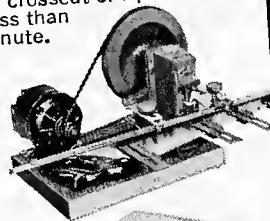

POWER SETTER

gives hand and band saw teeth perfect set automatically.

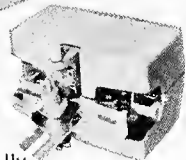

GRINDER

sharpens all rip, crosscut and combination circular saws.

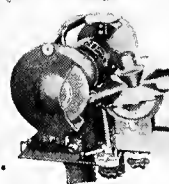

CARBIDE GRINDER

precision grinds top, face, sides of carbide tipped teeth.



Planer·Molder·Saw!

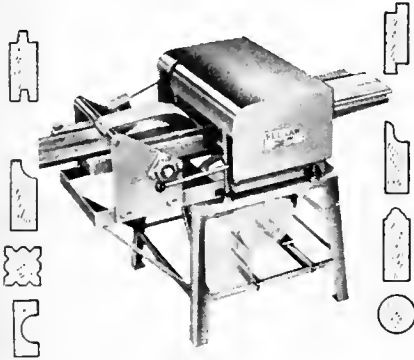

Now you can use this ONE power feed shop to turn rough lumber into high-value moldings, trim, flooring, furniture... ALL popular patterns.

RIP... PLANE... MOLD... separately or all at once by power feed... with a one horse-power motor. Use 3 to 5 HP for high speed commercial output.

LOW COST... You can own this MONEY MAKING POWER TOOL for only... **\$30.00** down.

Send coupon today

BELSAW POWER TOOLS
942-S Field Bldg., Kansas City, Mo. 64111
Send me complete facts on the MULTI-DUTY Power Tool. No obligation.

Name _____
Address _____
City _____ State _____ Zip _____

MAKE \$20 to \$30 EXTRA
on each
STAIRCASE

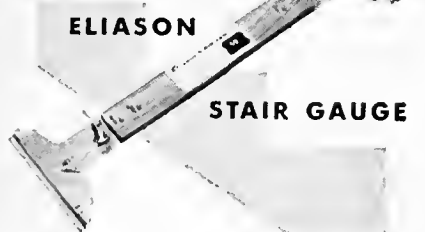

Saves its cost in ONE day—does a better job in half time. Each end of Eliason Stair Gauge slides, pivots and locks at exact length and angle for perfect fit on stair treads, risers, closet shelves, etc. Lasts a lifetime.

Postpaid if payment sent with order, or C.O.D. plus postage. Only **\$19.95**

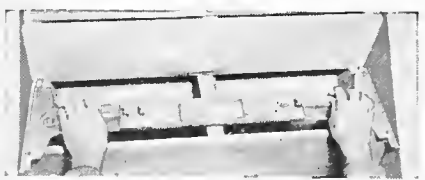

ELIASON STAIR GAUGE CO.
6005 Arbour Lane
Minneapolis, Minn. 55436



Signing contracts of Six Flags over Mid-America are, on left, Six Flags Vice-President Wayne Gallagher and Executive Secretary-Treasurer Ollie W. Langhorst, Carpenters' District Council of Greater St. Louis.

Six Flags Signs Contract in St. Louis

Permanent employees of the Six Flags over Mid-America amusement center have voted to join the Carpenters' District Council of Greater St. Louis. The Council has signed a four and one-half year agreement which became effective on May 3, 1971, and which is scheduled to expire on December 31, 1975. Also included in the contract is a wage re-opening clause for December, 1973.

According to Wayne Gallagher, vice-president of Six Flags, Inc., "there is a misconception about the size of this unit. Rumors about there being 1000 permanent employees are not accurate. There will be some 85 maintenance people and only about 65 professional staff." Concurrent with the terms of the contract, all of the permanent maintenance employees will be in the bargaining unit. They include carpenters, electricians, millwrights, plumbers, gardeners, and janitors. However, as of the date of the contract agreement, only 35 employees had been hired.

Gallagher indicated that Six Flags would also employ another 1200 seasonal workers, presently being recruited from high schools and colleges from throughout the state. Noting that Six Flags uses student employees because the work is seasonal, Gallagher said that he felt "this would do a great deal to help the youth unemployment situation in the area." These employees, however, will not be members of the bargaining unit.

The amusement center had its grand opening on June 5, 1971, and will be open until Labor Day. The park will be open only on weekends throughout October, then will reopen in mid-April. Similar amusement parks in Georgia and Texas have been completely organized by the carpenters. "When we learned they were coming here," said Council Executive Secretary-Treasurer Ollie W. Langhorst, "we began working to extend our jurisdiction to all the permanent employees."

APPROVED VETERANS

These 3 BIG DRAFTING KITS GIVEN TO YOU!

when you train at home with NASD for a **HIGH PAY JOB IN DRAFTING!**

Take your pick of 1000s big salary jobs open to Draftsmen. U.S. Labor Dept. reports "42% more Draftsmen needed in next 10 years—not enough applicants to fill jobs available now." Easy home-study plan has helped 100s beginners toward \$5555, security, prestige as Draftsmen—many with only grade school training. Others report good earnings drafting part time while still learning. Why not you?

RUSH COUPON FOR FREE KIT!

Mail coupon for FREE "DRAFTING CAREER KIT." Sample Lesson, Drafting Aptitude Test including new 5-Way Drafting Instrument & 20-Page Book, "Your Future in Drafting" — ALL FREE. No salesman will call. G.I. Bill approved. Write today.

NORTH AMERICAN SCHOOL OF DRAFTING, Dept. 11469
4500 Campus Drive, Newport, California 92660

Rush "DRAFTING CAREER KIT," including Book, Sample Lesson, Aptitude Test & Drafting Instrument—ALL FREE!

NAME _____ AGE _____
ADDRESS _____
CITY _____ STATE _____ ZIP _____

AUDEL CARPENTERS & BUILDERS LIBRARY



4 vols. \$18.50

THESE "PAPER TOOLS" can boost your income!

Their 1,488 pages of practical information and how-to guidance are invaluable "tools" for all in the building trades... a complete course for the apprentice, a ready reference for master workers.

Thousands of photos, diagrams and charts tell and show short cuts, new methods, solutions and money-saving ideas... how to use every tool and building aid... how to build everything from furniture to houses... how to frame, roof, excavate, do carpenter arithmetic, estimate costs, trim, insulate, care for tools, etc. They can help you earn more, fast.

MONEY BACK GUARANTEE—You must be completely satisfied with the Audel Guides you order, or you may return them within 10 days and get your money back.

SEND COUPON TODAY

Theodore Audel & Co., 4300 West 62nd St. C-091
Indianapolis, Indiana 46268

Please mail me Carpenters and Builders Library, 4 vols. I agree to mail \$3 in 10 days and to mail 1/2 the total purchase price 30 days later, with the balance plus shipping costs to be mailed within another 30 days. If I am not completely satisfied I may return the books for refund.

Name _____
Address _____
City _____ State _____ Zip _____

Save shipping costs. Enclose \$18.50 (plus sales tax, if any) and we pay postage.



IN MEMORIAM

**L.U. NO. 12
SYRACUSE, N.Y.**

Cardinal, James
Pieterck, Clarence
Young, William H.

**L.U. NO. 15
HACKENSACK, N.J.**

DaCosta, Hedley

**L.U. NO. 33
BOSTON, MASS.**

Butland, Robert
Butterfield, Lawson
Foster, George
Laing, John
Lupi, Joseph I.
Nelson, Robert
Nickerson, Gordon
O'Neil, Paul R.
Saulniers, Rene
Stewart, Baldwin
Stone, George

**L.U. NO. 34
SAN FRANCISCO, CAL.**

Arnold, William
Johnson, Ulysses
Kuisma, John
Porter, George G.
Ripley, Charles J.
Sheehan, Dan
Wheeler, Francis J.

**L.U. NO. 35
SAN RAFAEL, CAL.**

Ivani, Harold

**L.U. NO. 40
BOSTON, MASS.**

Godett, Joseph
Lane, Bernard
Lowell, John N.
Mercer, Sidney

**L.U. NO. 50
KNOXVILLE, TENN.**

Cockrum, William H.
Cowden, Carl B.
Slingluff, S. R.

**L.U. NO. 51
BOSTON, MASS.**

Davis, William P.

**L.U. NO. 53
WHITE PLAINS, N.Y.**

Capece, Vito

**L.U. NO. 54
CHICAGO, ILL.**

Marecek, James

**L.U. NO. 59
LANCASTER, PA.**

Erb, Willis
Mast, Fred

**L.U. NO. 64
LOUISVILLE, KY.**

Dahlman, H. J.
Durbin, J. F.
Hilts, H.
Kaufman, N.
Young, L.

**L.U. NO. 74
CHATTANOOGA, TENN.**

Bandy, Thomas D.
Haven, Claude
Maynard, O. L.
Moon, Roy M.
Thompson, Hugh M., Sr.

**L.U. NO. 100
MUSKEGON, MICH.**

Andreas, Orin
Bonse, Jerome
Perna, Steve

**L.U. NO. 101
BALTIMORE, MD.**

Greenwalt, Joseph C.

**L.U. NO. 102
OAKLAND, CAL.**

Baur, Toney
Garrison, Oran
Hieb, Alvin

**L.U. NO. 121
VINELAND, N.J.**

Netolicka, Theodore

**L.U. NO. 132
WASHINGTON, D.C.**

Copeland, J. H.

**L.U. NO. 198
DALLAS, TEX.**

Dobson, George O.
Ketron, W. B.
Money, Edmond F.

**L.U. NO. 200
COLUMBUS, OHIO**

McCarley, Franklin G.
Rohr, Robert
Schneider, Elmer

**L.U. NO. 213
HOUSTON, TEX.**

Abbott, Ralph W.
Castleman, T. D.
Dunnahoe, George E.
Gray, E. V.
Haldeman, Ezra P.

Redler, Albert
Thornton, J. H.

**L.U. NO. 226
PORTLAND, ORE.**

Bengtson, Carl H.
Bunn, Loyde
Campbell, Reuben P.
Davidson, E. C.
Foster, John T.
Wadman, Loran W.
Weinheimer, Robert

**L.U. NO. 246
NEW YORK, N.Y.**

Commisso, Giuseppe
Kaufman, Albert

**L.U. NO. 257
NEW YORK, N.Y.**

Antonsen, Jacob
Armstrong, Alfred
Lachance, Hector
McColl, Frank B.
Scuderi, Ignatius
Sirianni, Peter

Sottosanti, Michael
Thompson, Maldus
Weisz, Mathias

**L.U. NO. 278
WATERTOWN, N.Y.**

Boscoe, Robert
Santimoor, Robert M.

**L.U. NO. 325
PATERSON, N.J.**

Bowe, Thomas

**L.U. NO. 340
HAGERSTOWN, MD.**

Schroyer, Herman H.

**L.U. NO. 366
NEW YORK, N.Y.**

Vollmer, Otto

**L.U. NO. 372
LIMA, OHIO**

Long, Paul
Smith, Carl

**L.U. NO. 403
ALEXANDRIA, LA.**

Heimbach, Herbert H.
McMillan, Andrew R.
Price, W. E.

**L.U. NO. 419
CHICAGO, ILL.**

Defner, Joseph
Eissing, Felix
Erker, August.
Frank, Joseph
Hubner, Anton
Hupperich, Henry
Kallinger, Joseph
Mann, Edwin J.
Peraino, Joseph
Stueber, John
Zimmer, George

**L.U. NO. 436
NEW ALBANY, IND.**

Martin, Clarence

**L.U. NO. 470
TACOMA, WASH.**

Dixon, F. M.
Divis, Fred
Erickson, Victor
Hembroff, Earl
Maw, Edward J.
Noel, Theophile, J.
Neumann, Samuel
Roley, Richard

**L.U. NO. 483
SAN FRANCISCO, CAL.**

Beyers, William
Bostrom, John
Bustad, C. J.
DiMarco, Bruno
Garside, Joseph
Maynard, Al
Olofson, Simon
Payne, Elmer
Pierotti, Peter

**L.U. NO. 494
WINDSOR, ONT.**

Robichaud, Eugene

**L.U. NO. 533
JEFFERSONVILLE, IND.**

Duncan, Harold
Voit, Otto S., Jr.

**L.U. NO. 562
EVERETT, WASH.**

Ayer, Edward J.
Funk, Elmer C.
Green, Leonard H.

**L.U. NO. 586
SACRAMENTO, CAL.**

Forbes, James H.
Hale, Carter R.
Kent, Lloyd
Pritchett, Charles W.
Shirley, O. C.

**L.U. NO. 668
PALO ALTO, CAL.**

Carlson, Elof W.
Stenbit, Paul C.

**L.U. NO. 678
DUBUQUE, IOWA**

Bardell, Roy

**L.U. NO. 710
LONG BEACH, CAL.**

Bakke, H. J.
Bonney, Freeland F., Sr.
Burrell, Elmer A.
Dangremond, Donald
Griffiths, O. W.
Miller, Soren J.
Parsons, William E.

**L.U. NO. 729
LIBERTY, N.Y.**

Huebsch, Carl

**L.U. NO. 848
SAN BRUNO, CAL.**

Lee, Charles

**L.U. NO. 871
BATTLE CREEK, MICH.**

Wagner, R. Z.
Yeager, George

**L.U. NO. 937
DUBUQUE, IOWA**

Breckler, Albert

**L.U. NO. 943
TULSA, OKLA.**

Benton, C. L.
Boone, A. C.
Bullard, C. F.
Caldwell, F. A.
Coats, W. F.
Gideon, L. A.
Hughes, V. W.
Hutson, Ray
Inglett, Dewey K.
Little, Wesley R.
Parker, Archie
Reininger, Monzy
Wilton, Heldric

**L.U. NO. 950
NEW YORK, N.Y.**

Grohs, Raymond

**L.U. NO. 972
PHILADELPHIA, PA.**

Patterson, Fred

**L.U. NO. 982
DETROIT, MICH.**

Johnson, William

**L.U. NO. 1108
CLEVELAND, OHIO**

Courcy, Emery
Gilson, William
Johnson, John
Kangas, Wilho
Nagay, Andrew
Ruple, B. A.
Sadlon, Peter
Satrianno, Anthony

**L.U. NO. 1149
SAN FRANCISCO, CAL.**

Jones, Floyd
McManus, John
Sheppard, George

**L.U. NO. 1160
PITTSBURGH, PA.**

Meess, Otto

**L.U. NO. 1248
GENEVA, ILL.**

Johnson, A. W.

**L.U. NO. 1363
OSHKOSH, WIS.**

Neubauer, Louis

**L.U. NO. 1367
CHICAGO, ILL.**

Mathson, Enoch
Sheinkop, Edward

**L.U. NO. 1394
FT. LAUDERDALE,
FLA.**

Shelby, Paul L.
Wilson, Ellwood, G.

**L.U. NO. 1396
GOLDEN, COLO.**

Carmony, Francis D.
Clare, Charlie R.
Kramer, Jake M.
Peterson, Lloyd C.
Pickell, Miner C.
Sullivan, Raymond
White, Chester L.

**L.U. NO. 1397
N. HEMPSTEAD, N.Y.**

DaCunha, Adrian

**L.U. NO. 1408
REDWOOD CITY, CAL.**

Crowell, Harvey
Gegax, William
Hanna, Joseph
James, Wilton K.
Sparks, Robert
Tower, Carlos

**L.U. NO. 1433
DETROIT, MICH.**

Brown, James S.
Donohue, James, Jr.
Jennings, Leman
Lindstrom, Walter
Merrihew, Orley
Mills, John
West, John E.
Woods, Vern

STAIRWAY CONSTRUCTION MADE EASY



WITH THIS NEWEST BOOK

In plain language and with over 50 illustrations and photos, you are shown the methods that years of experience have proven the easiest, fastest, most practical and efficient.

Even with no previous experience you will be able to build a good stair the first time. It gives complete, detailed, easy-to-follow instructions on how to lay out, cut and build a more perfect stair. It shows the basic construction methods of all types, including winder and circular stairs.

This is the most complete book on stair construction published in the past 30 years. Increase your skill and self-confidence now. It saves its cost on the first stair built.

Satisfaction Guaranteed

\$3.50 Postpaid. Washington State residents add 18c tax. For air mail shipment add 55c extra.

Send \$3.50 money order or check to:

DOUGLAS FUGITT

11347 N.E. 124th St., Kirkland, Wash. 98033

ORDER TODAY

Name

Address

City

State Zip Code

INDEX OF ADVERTISERS

Audel, Theodore	36
Belsaw Power Tools	36
Belsaw Sharp-All Co.	33
Chicago Technical College	31
Eliason Stair Gauge Co.	36
Estwing Manufacturing	40
Foley Manufacturing	35
Fugitt, Douglas	38
Hydrolevel	29
Irwin Auger Bit Co.	29
Lee, H. D.	29
Locksmithing Institute	31
North American School of Drafting	36
Paneling Specialties	32
Riechers, A.	32
Skil Corporation	25
*Stanley Power Tools	Cover 3
*Stanley Power Tools	Cover 4
Vaughan & Bushnell	32

In Memoriam, *Concluded*

L.U. NO. 1438
WARREN, OHIO
Hill, Taunus

L.U. NO. 1598
VICTORIA, B.C.
Gravelle, Earl
Sumner, Lyle A.

L.U. NO. 1667
BILOXI, MISS.
Crochet, Dewey
Morris, Joseph L.
Wade, Albert B.

L.U. NO. 1683
EL DORADO, ARK.
Langley, Marcus G.
Nichols, Frank
Poole, H. C.

L.U. NO. 1725
DAYTONA BEACH,
FLA.
Ellis, Jesse
Metts, Walter
Parker, Floyd
Walker, Benjamin

L.U. NO. 1784
CHICAGO, ILL.
O'Conner, Arthur E.
Pinter, Philip
Umlauf, Jacob
Witzman, Carl

L.U. NO. 1822
FORT WORTH, TEX.
Baley, William F.
Turpin, James L.
Wilson, Robert

L.U. NO. 1840
FARIBAULT, MINN.
Supple, Ambrose

L.U. NO. 1846
NEW ORLEANS, LA.
Graff, Walter
Lenoir, Ollice

L.U. NO. 1849
PASCO, WASH.
Trowbridge, Roy

L.U. NO. 1922
CHICAGO, ILL.
Alilunas, Anton
Anderson, Carl O.
Hickey, George
Myers, Albert F.
Raaber, William C.

L.U. NO. 1941
HARTFORD, CONN.
Kasko, Andrew

L.U. NO. 1997
COLUMBIA, ILL.
Eckert, Theodore F.

L.U. NO. 2073
MILWAUKEE, WIS.
Bleth, Frank
Hogler, Henry
Prell, Roman
Siellaff, John

L.U. NO. 2103
CALGARY, ALTA.
Schmitz, Heinz

L.U. NO. 2130
HILLSBORO, ORE.
Baldwin, Carl

L.U. NO. 2205
WENATCHEE, WASH.
Syriny, J. H.

L.U. NO. 2400
WOODLAND, ME.
Allen, Herbert W.
Clark, William D.

L.U. NO. 2523
MEMPHIS, TENN.
Nash, Clinton
Patterson, Albert, Jr.

L.U. NO. 2674
LECENTER, MINN.
Trimbo, Charles

L.U. NO. 2762
NORTH FORK, CAL.
Licon, Daniel W

L.U. NO. 3268
HAWKESBURY, N.S.
Hearn, Bert

Legacy of Long Service

In May, Local 1248, Geneva, Ill., mourned the passing of its last charter member, Brother August W. Johnson, at Hayward, Calif. He was 96 years old. He joined the Brotherhood on April 17, 1903 and was a continuous member in good standing until his death. In October, 1968, he was sent his 65-year service pin and in return wrote a letter of thanks and remarked that he had just finished reroofing his house himself. He also enclosed a snapshot of himself and his wife who was then 82 years old and just as active as he was.



Lakeland News

Items of interest from the Brotherhood's retirement home at Lakeland, Florida

Rudolph A. Janca, of Local 1128, Brookfield, Ill., arrived at the Home July 20, 1971.

Carl Ralston, of Local 183, Peoria, Ill., arrived at the Home July 26, 1971.

John V. Sundberg, of Local 488, Bronx, N.Y. arrived at the Home July 28, 1971.

John Kattelus of Local 454, Philadelphia, Pa., arrived at the Home July 28, 1971.

Charles Johnson, of Local 1367, Chicago, Ill., arrived at the Home July 20, 1971.

Phil Berard, of Local 36, Oakland, California, withdrew from the Home July 4, 1971.



In Conclusion

M. A. Hutcheson, General President



The Wage Freeze: One Horse and One Rabbit

■ A few years ago, a fellow named Elroy Hirsh was burning up the National Football League. He was nicknamed "Crazylegs" because of his unique ability to confuse defenders by appearing to run in several directions while he was really running straight ahead.

This makes him the exact opposite of President Nixon, who somehow or other has managed to run in half a dozen directions at once while actually sliding backward. His maneuverings and faking must make "Crazylegs" green with envy.

Because of Mr. Nixon's economic signal calling, the number of unemployed workers nearly doubled over the last two and a half years. More than five million workers are without jobs; 14,500,000 Americans are on the relief rolls; the number of persons living in poverty has risen to 25,500,000—the first increase in 10 years. More than 800 communities are economic disaster areas.

At the same time, instead of reducing inflation, the Administration's misguided policies actually accelerated it. The 4.2 per cent inflation rate rose to 5.4 per cent in 1969, Mr. Nixon's first year in office. It climbed to 5.9 per cent in 1970, the highest rate in 20 years, and the end is not in sight.

Following three years of fumbling, bumbling, and losing ground, the President, on August 14 once more reversed his field. He abandoned the game plan which brought the nation to the very brink of economic catastrophe. In its place he substituted an ill-conceived, unfair and uncoordinated wage and price freeze.

This may constitute his greatest fumble of all. He called the new play far too late in the game. The score was already Inflation 300; Economic Stability 0. He failed to call a huddle to explain the play to all the players. His play places too much of the burden on some players while others get a free ride.

In keeping with all his previous actions, the President's newest pipe dream falls heaviest on the building trades. From the beginning of his term, the President has confined his efforts at stabilizing the economy to shackling building trades workers.

When, after two years of prodding by labor, it

finally dawned on him early this year that inflation was a serious matter, his first action was to order a 75-per cent cut-back in Federal construction; this despite the fact that the need for hospitals, schools, sewage plants, etc., adds up to the major problem of our time.

This initial kick-in-the-teeth for construction workers was followed by an Executive Order suspending Davis-Bacon provisions. When the chaos and confusion created by this order finally percolated through to the President, he rescinded his order and instituted a program of wage controls for the construction industry exclusively.

Prior to the August 14 freeze, the construction workers were the only group whose wage rates had to run the gamut of a bureaucratic obstacle course.

In an effort to get the economy moving again, Congress earlier this year enacted two bills; one was a bill to speed up Public Works Programs, the other was a bill to provide several billion dollars to cities and states for the purpose of allowing these cities and states to hire more service personnel. The President vetoed the bill designed to speed up construction; however, he signed the bill to allow communities to hire more service personnel even if nothing more constructive resulted than leaf-raking.

In vetoing the construction bill, the President said it would take too long to get the authorized money translated into jobs. This ignores the true facts; namely, that many of the projects closed down by the construction cutback are ready to go at once. Many desperately needed projects are held up only by a lack of money. And unemployment in construction has run twice as high as the national average for all industry.

It is no wonder that construction workers are both confused and angry, a fact that may have a difficult time penetrating the layers of insulation in the form of flunkies which surround President Nixon. It may be November 1972 before he learns how angry construction workers really are.

Under the construction wage freeze, building trades

Estwing

FIRST CHOICE of Skilled Craftsmen for Nearly 50 Years

Make Your Next Hammer An Estwing!

Forged One-Piece Solid Steel—



Supreme Nail Hammer

Strongest Construction Known



22 oz. Rafter & Framing Hammer

Unsurpassed Estwing Temper Balance & Finish

Plus Exclusive Nylon Vinyl Deep Cushion Safe-T-Grip Molded on Permanently



Drywall Hammer

These and Other Quality Estwing Tools Are Available At Leading Hardware, Lumber And Building Supply Dealers.

Estwing 

Mfg. Co. 2647-8th Dept. C-9 Rockford, Ill. 61101

unions have had wage boards and stabilization commissions holding a club over their heads. So they negotiated wage increases in multiple steps as a means of fighting inflation and satisfying the bureaucrats.

Now, the Nixon Administration infers that all deferred increases are out of the window for the next 90 days; and he further indicates any hope of retroactivity after 90 days is out.

I doubt if business has ever received a greater windfall than the present freeze President Nixon engineered. Hundreds upon hundreds of industrial and service agreements have been negotiated this year calling for deferred increases some time after August 14. Every one of these increases snatched away from the workers naturally ends up in the pockets of employers in the form of added profits. There is no freeze on profits.

Neither is there any rollback of interest rates, the greatest contributor of all to inflation. Testimony presented before the House Banking and Currency Committee indicates that a one per cent increase in mortgage rates costs the home buyer more than all the wages labor got for building the house. Yet, Mr. Nixon is cracking down on wage rates while virtually ignoring interest rates.

The little guy with a few cents an hour coming to him as a cost-of-living increase is out of luck. However, the banker, the money-lender, the investor, and the speculator have clear sailing. There is no freeze on profits, but there is a freeze on profit-sharing with employees.

It is the old one horse and one rabbit formula carried to its ultimate end. The speculator who picks up an extra \$50,000 gets to keep it. The factory worker with 8 cents an hour coming in the form of a cost-of-living increase gets the back of the President's hand.

Elroy Hirsh retired a few years ago. I am sure the suggestion that Mr. Nixon join him next year is not an unpopular idea among building trades workers. ■



Stanley gives today's best routers even more power



Two of today's most popular ball bearing routers have been given even greater power and capacity.

Model 91264 at \$77.00 now produces a full 1 h.p.; Model 91267 at \$87.00 has a full 1½ h.p. Each router will now accept ⅜" shank diameter bits, as well as ¼", using either of two collets furnished. Use of heavier ⅜" shank bits, however, assures less breakage under heavier torques and feeds.

Motors have welded (not soldered) leads. Micrometer depth settings are in .004" increments. Three position handles provide fatigue-free operation, bet-

ter control, with convenient thumb switching without removing either hand. A switch-operated shaft lock permits one-wrench bit changes. And *only* Stanley routers have a built-in light for better visibility for the operator.

Stanley's complete line of routers range from ¼ h.p. to 8 h.p. in electric, air and high-frequency power sources. See them at your distributor. Stanley Power Tools, Division of The Stanley Works, New Bern, No. Carolina 28560.

STANLEY
helps you do things right

P.S. Made by the *same* Stanley that makes the finest hand tools.

What makes the Stanley PL320 your kind of rule?

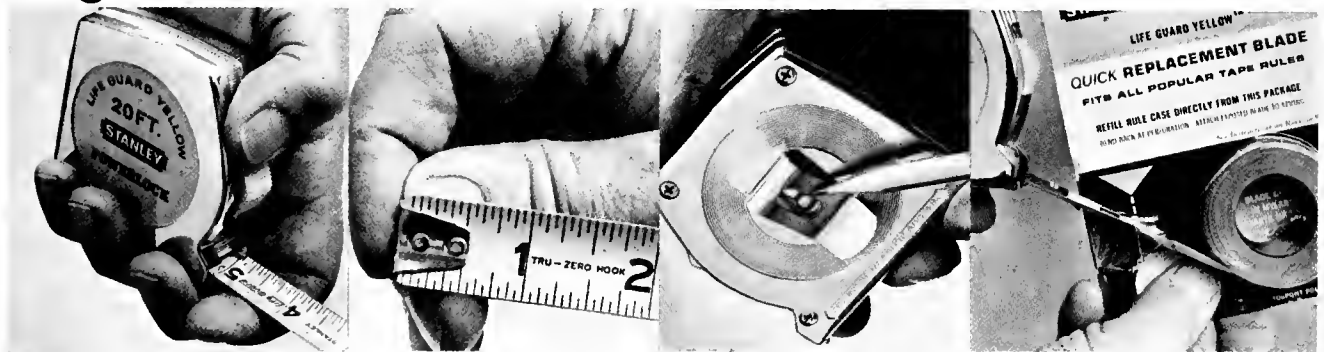

The exclusive Stanley POWERLOCK® locks on the blade, not the drum. This eliminates slip in either direction – positively prevents creep.

"True zero" hook adjusts automatically to precisely measure outside areas or harder-to-get-at interiors. Underside of hook is serrated to grip work, keep blade from slipping.

Back of your PL320 features a clip that snaps tightly over belt or apron pocket. It helps make sure you always have your rule handy – lessens chance of loss or theft.

Lifeguard® Yellow blade takes tough use. But if you ever have to replace one, get a refill – do it on the job, in seconds! No need to send the whole rule back to the factory.

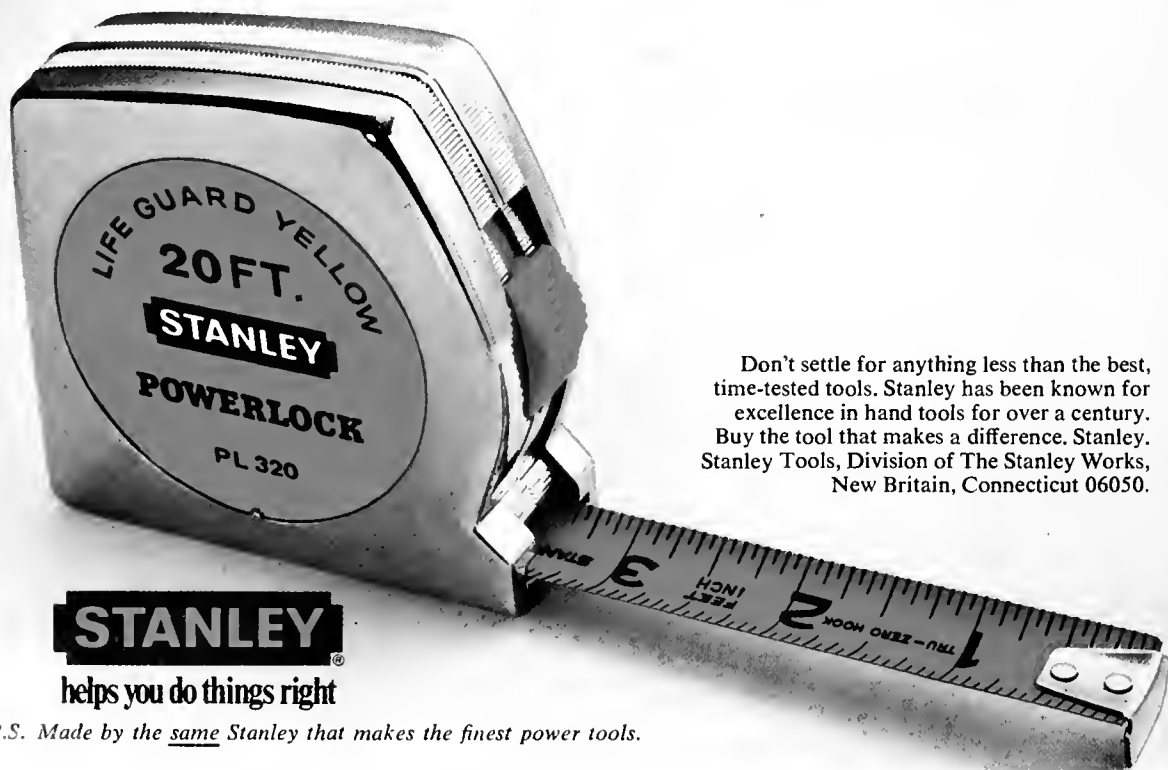

Don't settle for anything less than the best, time-tested tools. Stanley has been known for excellence in hand tools for over a century. Buy the tool that makes a difference. Stanley, Stanley Tools, Division of The Stanley Works, New Britain, Connecticut 06050.

STANLEY

helps you do things right

P.S. Made by the same Stanley that makes the finest power tools.

The

OCTOBER 1971

CARPENTER

Official Publication of the UNITED BROTHERHOOD OF CARPENTERS AND JOINERS OF AMERICA • FOUNDED 1881



NOAH
The World's
most famous
wooden shipbuilder

OFFICIAL INFORMATION

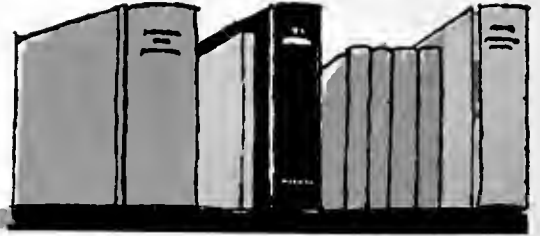

GENERAL OFFICERS OF THE UNITED BROTHERHOOD of CARPENTERS & JOINERS of AMERICA

GENERAL OFFICE:
101 Constitution Ave., N.W.,
Washington, D. C. 20001

GENERAL PRESIDENT

M. A. HUTCHESON
101 Constitution Ave., N.W.,
Washington, D. C. 20001

FIRST GENERAL VICE PRESIDENT

WILLIAM SIDELL
101 Constitution Ave., N.W.,
Washington, D. C. 20001

SECOND GENERAL VICE PRESIDENT

HERBERT C. SKINNER
101 Constitution Ave., N.W.,
Washington, D. C. 20001

GENERAL SECRETARY

R. E. LIVINGSTON
101 Constitution Ave., N.W.,
Washington, D. C. 20001

GENERAL TREASURER

CHARLES E. NICHOLS
101 Constitution Ave., N.W.,
Washington, D. C. 20001

DISTRICT BOARD MEMBERS

First District, PATRICK J. CAMPBELL
130 North Main Street
New City, Rockland Co., New York
10956

Second District, RALEIGH RAJOPPI
2 Prospect Place, Springfield, New Jersey
07081

Third District, WILLIAM KONYHA
1830 Ledge Rd., R.D. No. 4
Medina, Ohio 44256

Fourth District, HAROLD E. LEWIS
340 Northwest 148th St.
Miami, Florida 33168

Fifth District, LEON W. GREENE
2800 Selkirk Drive
Burnsville, Minn. 55378

Sixth District, FREDERICK N. BULL
P.O. Box 14279
Oklahoma City, Okla. 73114

Seventh District, LYLE J. HILLER
Room 722, Oregon Nat'l Bldg.
610 S.W. Alder Street
Portland, Oregon 97205

Eighth District, M. B. BRYANT
Forum Building, 9th and K Streets
Sacramento, California 95814

Ninth District, WILLIAM STEFANOVITCH
2418 Central Avenue
Windsor, Ontario, Canada

Tenth District, ELDON T. STALEY
4706 W. Saanich Rd.
RR #3, Victoria, B. C.

M. A. HUTCHESON, *Chairman*

R. E. LIVINGSTON, *Secretary*

Correspondence for the General Executive Board
should be sent to the General Secretary.



Secretaries, Please Note

If your local union wishes to list deceased members in the "In Memoriam" page of *The Carpenter*, it is necessary that a specific request be directed to the editor.

In processing complaints, the only names which the financial secretary needs to send in are the names of members who are NOT receiving the magazine.

In sending in the names of members who are not getting the magazine, the new address forms mailed out with each monthly bill should be used. Please see that the Zip Code of the member is included. When a member clears out of one Local Union into another, his name is automatically dropped from the mail list of the Local Union he cleared out of. Therefore, the secretary of the Union into which he cleared should forward his name to the General Secretary for inclusion on the mail list. Do not forget the Zip Code number. Members who die or are suspended are automatically dropped from the mailing list of *The Carpenter*.

PLEASE KEEP THE CARPENTER ADVISED OF YOUR CHANGE OF ADDRESS

PLEASE NOTE: Filling out this coupon and mailing it to the CARPENTER only corrects your mailing address for the magazine. It does not advise your own local union of your address change. You must notify your local union by some other method.

This coupon should be mailed to **THE CARPENTER**,
101 Constitution Ave., N.W., Washington, D. C. 20001

NAME _____ Local No. _____

Number of your Local Union must be given. Otherwise, no action can be taken on your change of address.

NEW ADDRESS _____

City

State

ZIP Code

THE CARPENTER

VOLUME XCI

No. 10

OCTOBER, 1971

UNITED BROTHERHOOD OF CARPENTERS AND JOINERS OF AMERICA

Peter Terzick, Editor



IN THIS ISSUE

NEWS AND FEATURES

Noah in Legend and Life	2
Rhetoric Ain't Got No Calories	Peter E. Terzick 6
Walt Disney World	8
Bengough Retires, New Board Members Named	13
General Secretary Attends Geneva Meetings	13
People with Ideas	16
The Negative Side of Apprenticeship	William Sidell 18

DEPARTMENTS

Washington Roundup	14
CLIC Report	20
We Congratulate	21
Plane Gossip	22
Canadian Report	Morden Lazarus 23
Local Union News	25
Apprenticeship and Training	27
Service to the Brotherhood	30, 33
What's New?	32
Outdoor Meanderings	Fred Goetz 34
Union Dictionary	36
In Memoriam	37
In Conclusion	M. A. Hutcheson 40

THE COVER

The story of Noah and the Flood as related in the Old Testament of the Bible has long intrigued mankind. The story is one of faith and perseverance against seemingly impossible odds.

It is also a story of a man of unquestionable skill in the use of ancient tools . . . a man who worked with wood to produce the most famed wooden vessel of all time.

We asked a skilled young artist, Miss Sherry Wolf of Baltimore, Md., to prepare for us a special cover picture, showing Noah as a ship builder. Miss Wolf, who recently prepared special drawings of Tricia Nixon's wedding at the White House for NBC News and is currently at work on a series of illustrations for the National Geographic Society, set about her task with the patience of her subject. From the Smithsonian Institution in Washington and the University of Pennsylvania Museum in Philadelphia she obtained information on the tools which might have been used more than 2,000 years ago. She went to reference books and government agencies for information on the types of trees and grasses prevalent in ancient Babylonia.

Her finished picture tells part of the story. Some of the animals are there. Members of the old patriarch's family are at work. In the distance, beyond the palm trees, a storm is brewing. The bow of the Ark has taken shape, and the saga will soon begin.

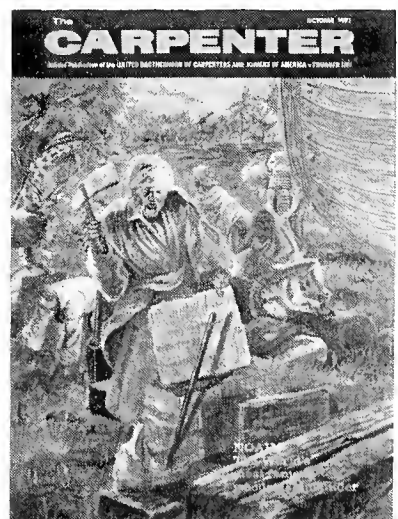

POSTMASTERS, ATTENTION: Change of address cards on Form 3579 should be sent to THE CARPENTER, Carpenters' Building, 101 Constitution Ave., N.W., Washington, D. C. 20001

Published monthly at 810 Rhode Island Ave., N.E., Washington, D. C. 20018, by the United Brotherhood of Carpenters and Joiners of America. Second class postage paid at Washington, D. C. Subscription price: United States and Canada \$2 per year, single copies 20¢ in advance.



Printed in U. S. A.

NOAH

in Legend and Life

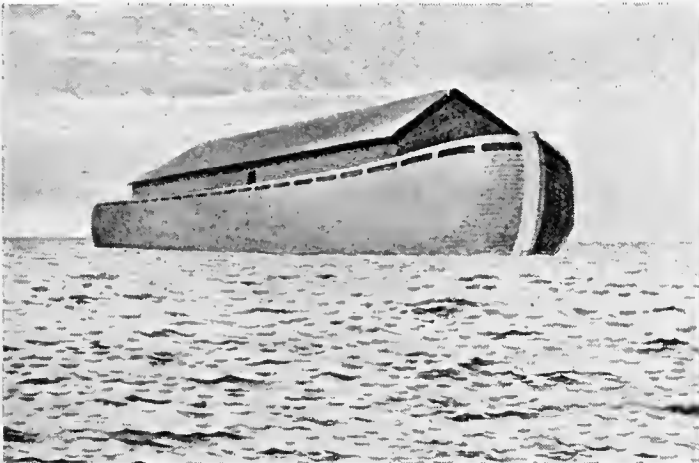

After the deluge, the Ark afloat on an endless sea.

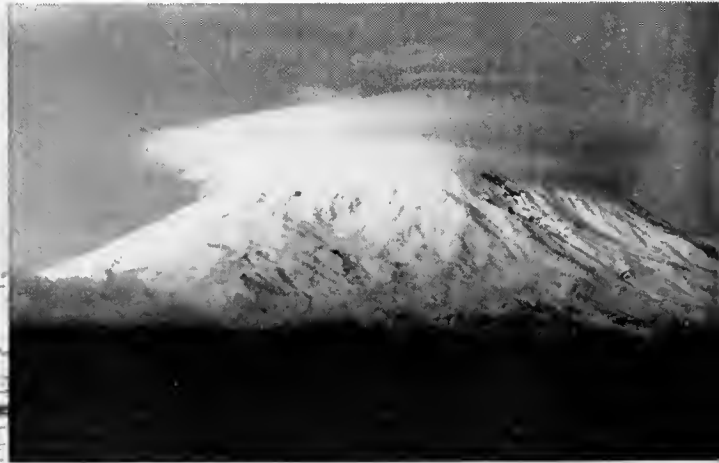

Mount Ararat in Turkey, where the Ark came to rest.

■ The story of Noah, his ark, and the great flood which washed the world clean of sinners is told in a few brief paragraphs of the Bible, and yet it is one of the most intriguing stories of all time.

It goes back to the early days of man, into the mists of pre-history. To some it seems more legend than fact.

This is how the King James Version of the Bible relates the story:

"And God said unto Noah, The end of all flesh is come before me; for the earth is filled with violence through them; and, behold, I will destroy them with the earth.

"Make thee an ark of gopher wood; rooms shalt thou make in the ark, and shalt pitch it within and without with pitch.

"And this is the fashion which thou shalt make it of: The length of the ark shall be three hundred cubits, the

breadth of it fifty cubits, and the height of it thirty cubits.

"A window shalt thou make to the ark, and in a cubit shalt thou finish it above; and the door of the ark shalt thou set in the side thereof; with lower, second, and third stories shalt thou make it. . . ."

Has ever a man, before or since, had such a construction job presented to him? It seems such an impossible task that comedians like Bill Cosby and Danny Kaye have had fun playing Noah before delighted audiences for years.

Noah, nevertheless, must have been a good carpenter. The Ark he built stayed afloat 150 days during one of the heaviest rainstorms and worst floods ever recorded in history. And it was a sizable vessel he constructed, even by today's standards and using today's tools.

The ark was to be 300 cubits long. The cubit of Noah's time was the length of a man's forearm. It was the distance from the tip of his elbow to the end of his middle finger. A worker measured timber by simply moving his forearm along the line. A cubit was roughly 18 inches long. This meant that Noah's floating menagerie was about 450 feet from stem to stern!

Of course, if Noah was a little fellow, the ark might have ended up about 400 feet long. If he was a big man, the vessel may have stretched 500 feet from bow to stern. The Bible tells us that Noah lived 950 years. So, big or not, he must have been a sturdy man, undoubtedly capable of hard labor.

The old patriarch lived in the area of the Earth which has been called the Cradle of Civilization—the Tigris and Euphrates Valley of Ancient Persia—in the land of the Garden of

The world's most famous wooden ship builder set an example of faith and perseverance



Inside the Ark with the animals.

"Make thee an ark of gopher wood," the Lord told Noah, according to the King James Version of the Bible. . . . "Build a barge of cypress wood," the Lord told Noah in the James Moffatt translation of the Bible. . . . "Make thee an ark of timber planks," God said in the Catholic Bible, and the wood is not identified.

Of what material would the ark have been constructed? What is gopher wood? Neither our historians, our museums, nor our foresters have certain answers to these questions. An old timer in West Florida told the U.S. Forest Service recently that Noah must have built his Ark in his home state because gopher wood grows in his state, and that Florida was the only place it did grow. Actually, "gopher wood" is a local Florida term for stinky cedar, we are told, and no shipbuilder would have used that. Our experts suggest that an ark of Noah's time would probably have been built of cypress, or white oak (left, above), which grows also in the Middle East, or cedars of Lebanon (right, above), famous as the wood of Solomon's Temple.

Eden, according to Biblical scholars. This was the land of Sumeria and Babylonia, a fertile land, fed by two mighty rivers.

From the dawn of Creation to the Great Flood was approximately 1,657 years, according to scholars. This was the Antediluvian Period of Bible history. Man was just coming out of the Stone Age. Archeologists tell us that man had only begun to work with soft copper and that his cutting tools—his axes, chisels, and the like—were made of flint and other hard stones. The age of bronze did not come until later. (If we take the King James Bible literally, however, man did have brass and iron during this period. See Genesis 4:22.)

It is hard to put exact dates on these early years of mankind. The men who translated the Bible worked with faintly-marked ancient scrolls and used phrases handed down through the gen-

erations by word of mouth. Time was relative. Woods and metals of the Middle East were not always familiar to the scholars of King James' court.

Man's earliest known metal tools—cold hammered copper pins—were used in Cayonu, Turkey, almost 9,000 years ago. Man built his houses of clay and straw and simply-fashioned wood.

But man's skills grew through the centuries, and by the time of Noah he was sailing on the open sea. Earliest Sumerian records refer to shipwrights and seafarers. Some of man's earliest ventures on the sea occurred in the Persian Gulf.

As to the story of the Great Flood, there is no doubt that this region was swept by floods from time to time. A great pit dug at Ur in 1929 revealed three levels of human occupation covered by 11 feet of water-laid silt, deposited by a great flood like the one

described in Genesis. Archeologists tell us that there was a tremendous flood disaster in southern Mesopotamia about 4000 B.C.

In 1872 an Englishman named George Smith was piecing together some Babylonian clay tablets in the British Museum. What he read on the tablets, once his jigsaw puzzle was assembled, filled him with excitement. They began to tell a familiar story.

But the story was incomplete, and Smith journeyed to the ruins of Ninevah, home of the Babylonian kings, and there he uncovered more tablets, 12 in all, which completed the story—the Epic of Gilgamesh, with its account of a great flood, strikingly similar to the tale of Noah.

Bible historians soon discovered that the story of Gilgamesh was part of the rich heritage of many nations of the ancient world. Hittites and Egyptians translated it into their own

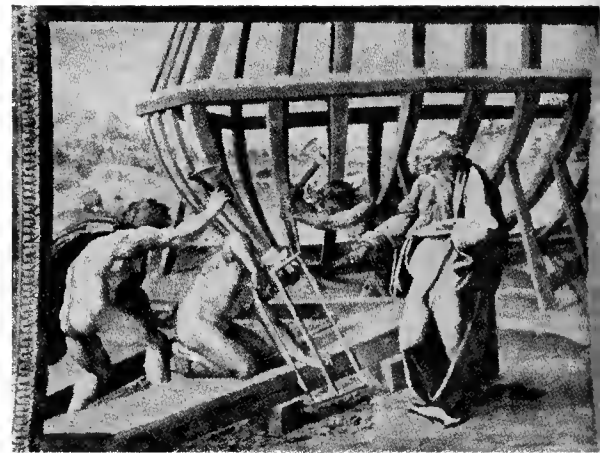
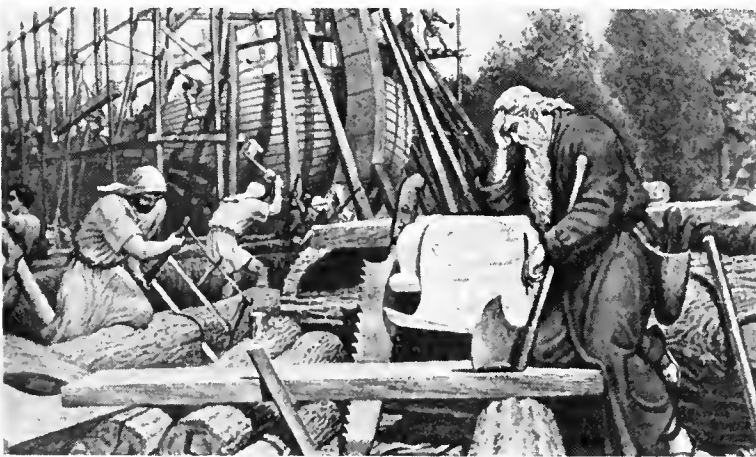
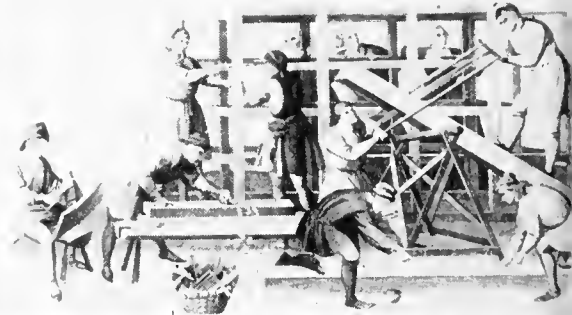
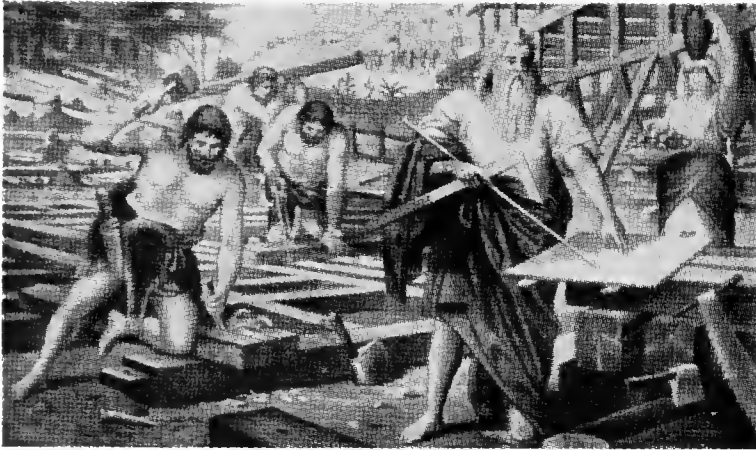

tongues. Cuneiform tablets discovered by the Nile still show clearly the marks in red ink opposite those parts of the story which Egyptian scribes found difficult to translate.

Gilgamesh was an early Sumerian king, as the legend goes. He wanted to insure his immortality, and to do so he set out on a long journey to find his ancestor Utnapishtim, from whom he hoped to learn the secret of everlasting life.

When Gilgamesh reached the island on which Utnapishtim lived, Gilgamesh asked of him the secret of life. Utnapishtim replied that he had once lived in Shuruppak and had been a true worshipper of the god Ea. When the gods decided to destroy man by a flood, Ea warned Utnapishtim by issuing this command:

"O man of Shuruppak, son of Ubar Tutu, tear down thy house, build a ship; abandon wealth, seek after life;

scorn possessions, save thy life. Bring up the seed of all kinds of living things into the ship; the ship which thou shalt build. Let its dimensions be well measured. . . ."

We know the story which follows. The story of Gilgamesh varies somewhat from that of Noah . . . Noah's time afloat was much longer. Gilgamesh's vessel came to rest on Mt. Nisir, which is in Kurdistan, south of Turkey and Mt. Ararat.

Nevertheless, the similarities are amazing, as are the findings of archeologists as to the floods of Mesopotamia.

Equally amazing are the many tales of a great ship reported buried beneath the ice of snow-capped Mt. Ararat.

A Dr. Aaron Smith of Greensboro, N.C., is considered the foremost expert on the Flood. He collected a complete history of the literature on Noah's Ark, according to an authori-

tative book, *The Bible as History*. There are 80,000 works in 72 languages about the Flood, he estimates of which 70,000 mention the legendary wreckage of the Ark. In 1951 Dr. Smith spent 12 days with 40 companions searching through the ice cap of Ararat without success.

"Although we found no trace of Noah's Ark," he said later, "my confidence in the Biblical description of the Flood is no whit the less. We shall go back."

Ararat lies in eastern Turkey, near the borders of Russia and Iran. Its snow-capped summit reaches 16,946 feet. Though Mt. Nisir has never tempted the curious, Mt. Ararat has lured ark searchers for more than a century.

The people of the little Armenian village of Bayazit, at the foot of the isolated mountain, recounted the re-

Far left, top: Building the Ark by a master of the Wandsbeck School.

Far left, bottom: A wash drawing of the building of the ark by an unknown artist.

Left, top: conception of ark construction by an artist of the Middle Ages.

Left, bottom: Noah Supervises the Building of the Ark by Raphael.

Below: The building of the ark as portrayed in a 1675 engraving. Biblical scenes were favorite subjects of Renaissance artists.

Pictures from the Bettmann Archives.

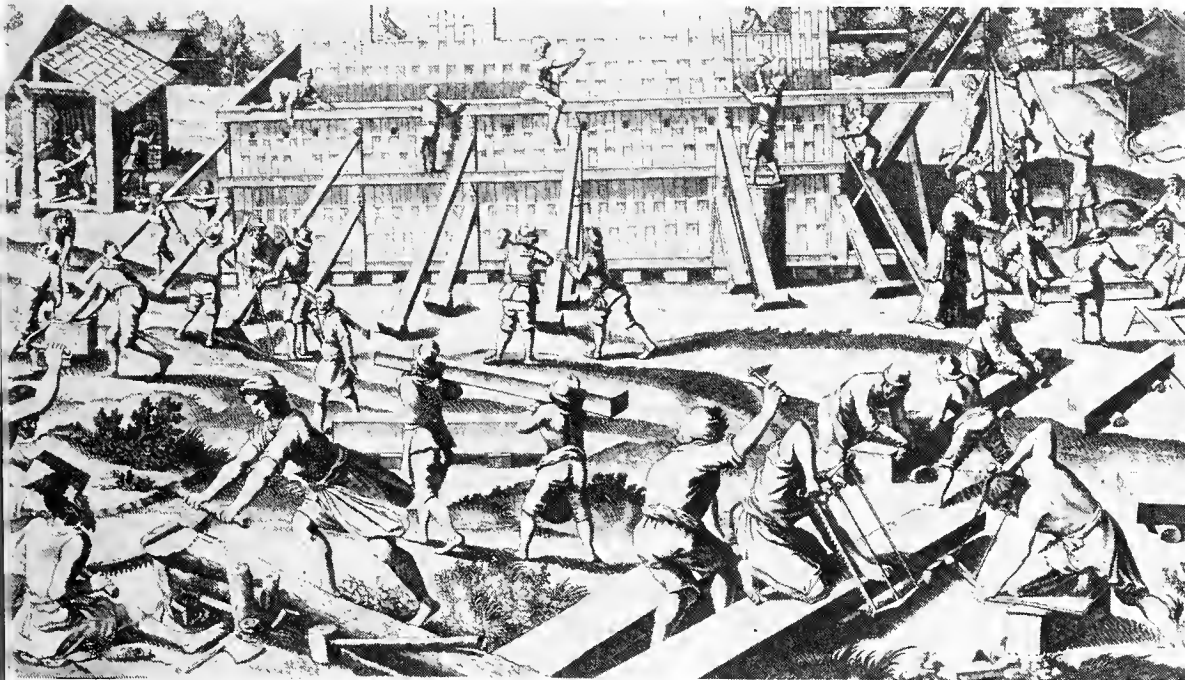

markable experience of a shepherd who was said to have once seen a great wooden ship high up the mountain. In 1833 there was a Turkish expedition which seemed to confirm the shepherd's story. The expedition left a report which mentioned sighting the bow of a ship jutting from a glacier on the south slope during the summer months.

The next person to report a ship on Ararat was a Dr. Nouri, Archdeacon of Jerusalem and Babylon. In 1892 this active clergyman began searching for the headwaters of the Euphrates River. On his return he told of the wreckage of a ship in Ararat's eternal ice.

"The interior was full of snow. The outer wall was of a dark red color," is the way he described the hulk of the vessel.

Russian, French and American ex-

peditions have tried to find an ark. Turkish Air Force pictures were once published in *Life* magazine, which showed something suspiciously like a large ship under the ice of the mountain.

We talked to Dr. Bernard Kukachka of the U.S. Forest Products Laboratory in Madison, Wis., who examined pieces of timber discovered high above the timber line by one of the most recent expeditions to Ararat. Under the microscope, Dr. Kukachka found the wood to be white oak. Carbon dating indicated that the wood was, perhaps, as ancient as Noah.

But these pieces of wood were only fragments and not conclusive proof that an ark had rested there.

So the mystery remains—in a combination of legend and fact—to intrigue builders and historians, perhaps, for centuries to come. ■



Tools of Noah's era: an axe head, a chatelaine, chisels, tongs, an awl, a sickle, a mold.

The University Museum, Philadelphia.

Rhetoric ain't got no calories

■ The June 7th issue of the Department of Labor's Press Service carried the following paragraph:

"On the basis of a ruling by President Nixon, approximately 1050 workers in four New England shoe plants who lost their jobs due to increased imports of shoes have been certified by the Labor Department as eligible to apply for trade-adjustment assistance."

Translated into everyday English, trade-adjustment assistance means \$87 per week, plus free testing, counseling, and training for new careers.

The following stirring drama is inspired by this great open-handed action of President Nixon:

The cast of characters consists of T. Otal Bust, a 60-year old laid-off shoe worker; his wife, Lotsa Bust; and T. Otal Bust, Jr., age 12.

As Scene I opens, Mrs. Bust is at the kitchen stove stirring the hominy grits bought with the last of the money from the last unemployment check that T. Otal has coming. Junior is sitting at the kitchen table studying a year-old copy of PLAYBOY, which he has hidden behind his history book. The door bursts open, and T. Otal, Sr., rushes into the room, waving a copy of the evening paper.

OTAL: "Our troubles are over! Just look at this piece in the paper. President Nixon has declared me eligible for trade-adjustment assistance. And you thought Nixon didn't give a damn for the working man."

MRS. B: "Gee, that sounds good. What is trade adjustment assistance?"

OTAL: (studying paper) "Well, it says here I will get \$87 per week. But I'll also get free training."

MRS. B: "Ain't that something. Let me see—you dropped out of school in the 6th grade to help feed your family. Maybe you want to train for a brain surgeon. Let's see, two years of grade school, four years of high school, four years of college, six years of medical school—you can make it by the time you're 76, if you can afford \$3,000 a year for college and \$10,000 per year for medical school on \$87 per week."

OTAL: "You're just trying to be funny. You know I can't. . . ."

MRS. B: "Or maybe you can be an architect in only 11 years."

OTAL: "Aw, you're funnin' with me. Maybe I can train to be a mechanic."

MRS. B: "A mechanic? You know my sister's husband, Clancy, is a mechanic. He ain't worked but three months all year."

OTAL: "How about if I ask for training to be a bartender?"

MRS. B: "At your age? They want younger guys who can jump around like a cat on a hot tin roof. Besides you would be your own best customer. You wouldn't have time to wait on anyone else."

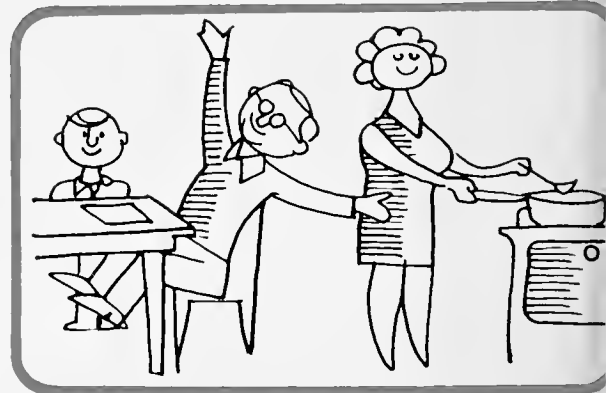
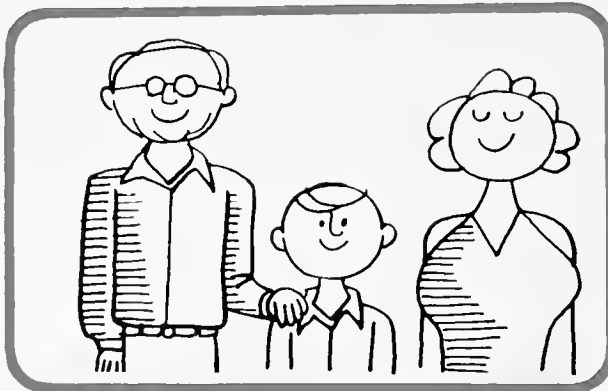

A Stirring Drama of the Shoe Factories that went over the Hill

JUNIOR: "I've got an idea. Since all the shoe jobs have been exported to Spain, Italy and Japan, how about moving to Japan? I hear those Jap babes are really something."

OTAL: "Shut your mouth, Junior. All you ever think of is babes. That kind of talk ain't patriotic. You know we got the richest country on earth."

JUNIOR: "Then how come we ain't rich?"

OTAL: "I said shut up. That sounds like communist crap. Is that what they teach in school these days?"

MRS. B: "Aw, leave the boy alone. He's only trying to help."

OTAL: "If he wants to help, why don't he get a job mowing lawns or something?"

MRS. B: "Lay off the kid. I know you are worried, but don't take it out on him."

OTAL: "If I just knew what kind of training Mr. Nixon had in mind, I would feel better. I guess I just have to have faith. I heard him say lots of times he is for the working man."

MRS. B: "If he's for the working man, it must be the working man in Japan and Spain. That's where he allowed the shoe jobs to go."

OTAL: "You sound more like your mother every day. She always knows everything. Wait till we find out what kind of training I'm going to get."

MRS. B: "At your age, the only kind of training that's practical is training on how to live the rest of your life on \$87 per week. We already had six months' experience living on unemployment insurance."

JUNIOR: "Our economics teacher said free trade helps everyone. We get cheaper shoes from Japan and that helps keep the cost of living down."

MRS. B: "It sure is keeping our cost of living down. We ain't spending hardly anything, because all we got is unemployment insurance for the last six months."

JUNIOR: "But he says free trade makes prosperity for everyone."

MRS. B: "Ask him how it makes prosperity for the Busts. We used to pay taxes. Now we're living off them. We used to buy new clothes and furniture once in a while. That day is gone."

OTAL: "CRIMINY! I just got a brilliant idea. Quick, get me a pen and paper so I can write to President Nixon. Let's bring the shoe factories back here and export the trade-adjustment allowance to the Japanese and Spanish workers. That way everyone can be happy. Maybe this is too important to write about. Maybe I better take it right to the White House."

CURTAIN

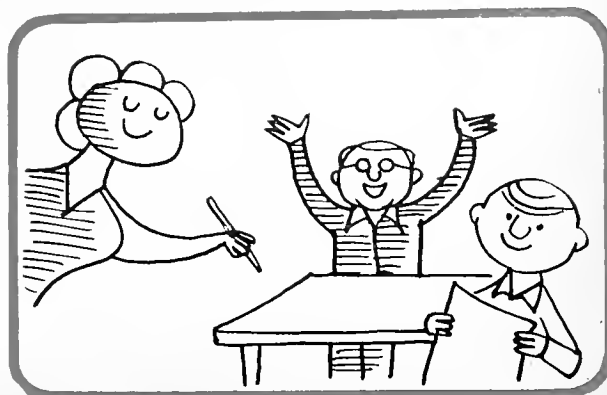
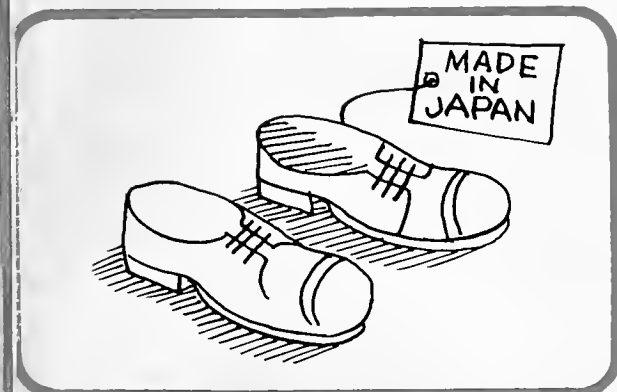

Walt Disney World

World's first "Vacation Kingdom"
to open this month in Florida,
thanks to round-the-clock efforts
of skilled building tradesmen



■ "Who's the leader of the club that's made for you and me?" These simple words, when set to music, comprise what may have been the most frequently-posed question in recent American history. Indeed, they are part of what has become a modern, American folk-hymn. Undoubtedly, few Americans would respond to such a query with something other than the familiar, resounding refrain: "M-i-c-k-e-y M-o-u-s-e."

Of course, a great many things have changed since the days during which Mickey Mouse was the American symbol of lighthearted fantasy. Today, Walt Disney Productions, Mickey's "alter ego," is nearing the completion of the first phase of its incredible 27,400-acre Walt Disney World—"made for you and me."

Situated 20 miles southwest of Orlando, Florida, Walt Disney World easily represents the largest and busiest private construction project in the country. Four years of site preparation and two years of construction have already gone into the tremendous undertaking. Phase 1 of

Continued on page 10

• Below, left: Ed Hubmaier, Roger Dennis, and Cal Owens at work.

• Below, top: Members work on a store front in the Magic Kingdom.

• Below, bottom: Magic Kingdom theme park. In front is Main Street, USA.

• Below, right: Beside Bay Lake rises the Contemporary Resort-Hotel.

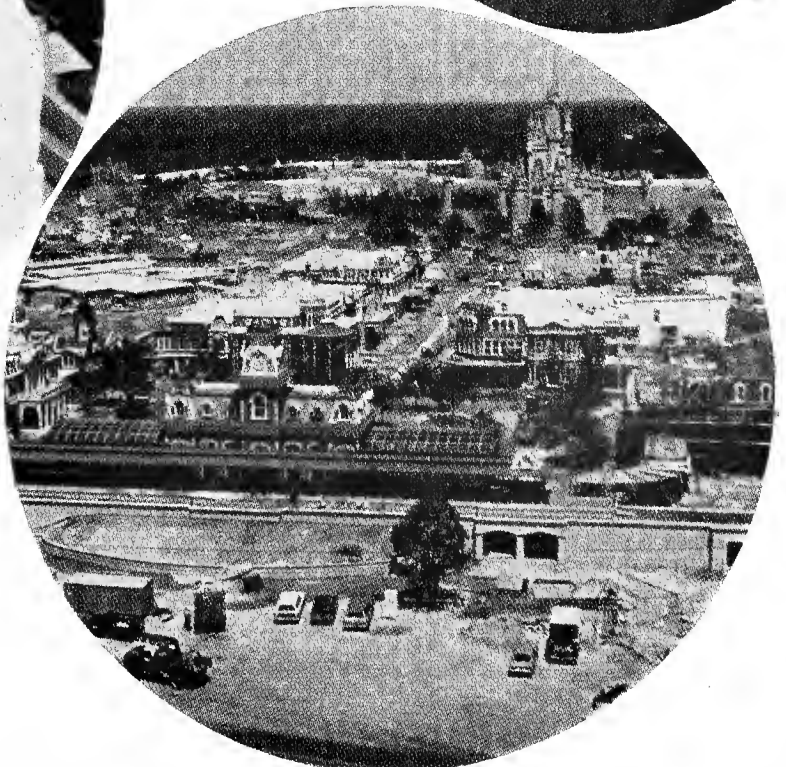
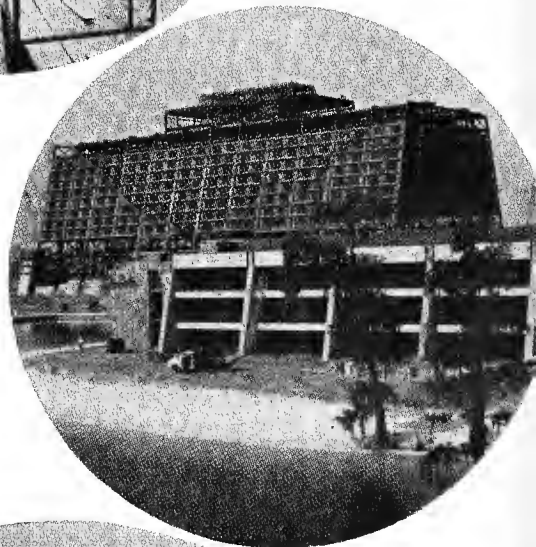
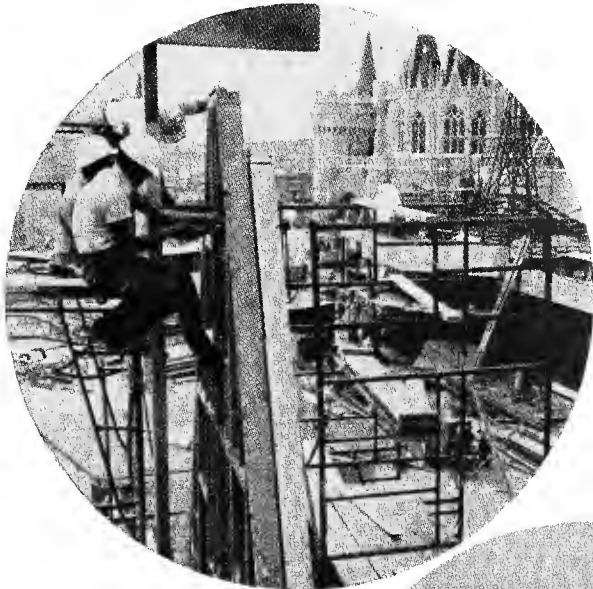



• Above: Hank Tulp and Ken Gilding apply finishing touches to one unit.

• Below: A model of Walt Disney World's Vacation Kingdom indicates its size.

• Below, right: Members at work on a Magic Kingdom store front.

the project involves Walt Disney World's Vacation Kingdom: a \$300 million, 2,500-acre, family-oriented, destination resort. In order to insure the scheduled October opening, a peak force of 8,000 construction workers is presently on the job.

In light of our country's sagging economy, the devastating rate of unemployment, and the Nixon Administration's insensitive attitude towards the construction industry, the Disney World project has been of inestimable benefit to the carpentry trade in central Florida. According to Bill Wilson, business agent of Local 1765 in Orlando, the project has been a "lifesaver." At present, approximately 1,650 carpenters are employed at the Disney World site. Membership in Local 1765, Wilson points out, has risen from 800 to 2,000 since the project's inception. In view of the fact that the Vacation Kingdom represents only the first phase of the total three-phase Disney project, requiring an estimated 15 years for completion, Wilson is confident that this heartening trend will continue. The project is being constructed under a 100% union agreement.

Thus far, carpenters have worked on everything from Cinderella's Castle to turn-of-the-century Main Street, U.S.A. Walt Disney World's Vacation Kingdom will revolve



around a Magic Kingdom theme park, similar in concept to California's Disneyland. At the October opening, approximately 40 attractions will be available, set in six different "lands": Adventureland, Frontierland, Liberty Square, Fantasyland, Tomorrowland, and Main Street, U.S.A. The Magic Kingdom, in turn, will revolve around its major theme building, Cinderella's Castle. Inspired by some of France's most famous palaces, the castle has gold-crested turrets which rise 186 feet into the air.

However, that's only the beginning. On opening, the Vacation Kingdom will also include a spectacular 1,057-room Contemporary Hotel. Built in the shape of a capital letter "A" with its top lopped off, the hotel will have monorail trains gliding between its two 14-story legs. In addition, an exotic Polynesian Village hotel with 500 rooms will also be ready to help accommodate some of the estimated 10 million people who are expected to visit Walt Disney World in its first full year. Three other hotels will be added during the five-year Phase I period, each with a different and exciting theme: Persian, Venetian, and Asian. They will surround a 650-acre lake and lagoon area in the heart of the vacation resort.

Continued on page 31

• *Below, left:* Scott Richardson and Don Provost cut 2 x 4's in a Magic Kingdom street.

• *Below, top:* Danny Tater and Edgar Atkinson work on a cupola.

• *Below, bottom:* Bill Major works on the butt of a door for Cinderella's Castle.

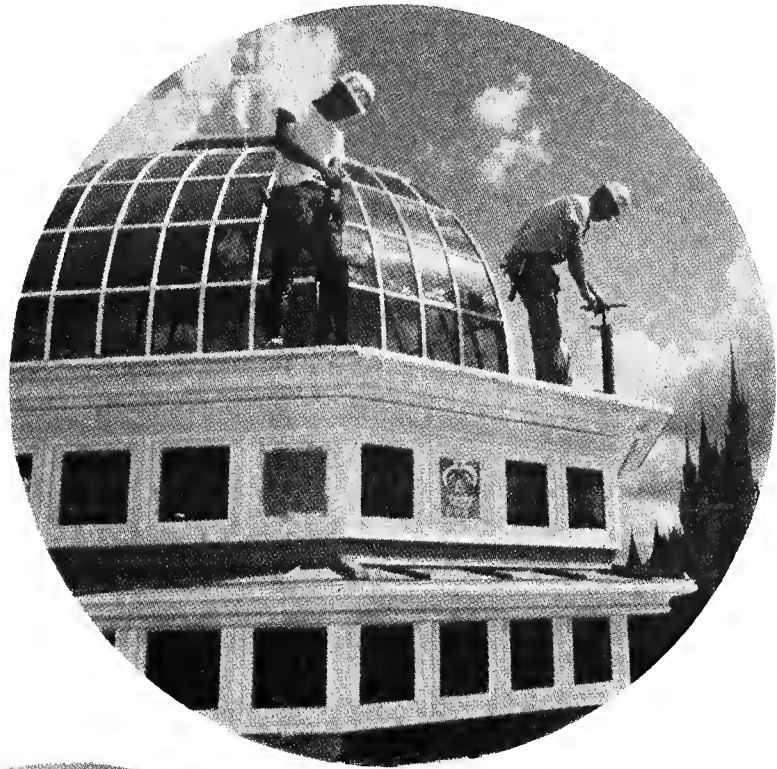

Whatever you saw, see Rockwell.

Aluminum.
Oak.
Masonite.
Pine.

A pro runs into a lot of different things on the job. Rockwell can handle them all. We have more ways to saw than anyone else.

Portable Saws

Rockwell's 14 portable circular saws give you a choice in the size, speed, power, special features and price you want: 8" to 12" extra heavy-duty saws, 4½" trim to 10¼" heavy-duty models, 6¾" and 7½" high-torque worm drive saws.

They have parts that are easy to replace at high wear points, ball bearing construction and failure-protected motors. Some have unique features like Rockwell's exclusive external gear lubricator. All have the feel and balance a pro can really appreciate.

Table Saws

Rockwell Delta has many table saws to choose from, for in shop or on site use. For example: Rockwell tilting arbor bench saws have big capacity, extra large table surface, adjustable positive stops. All controls are grouped right up front.

The Rockwell radial saws have famous double overarm action for greater left hand miter capacity. And up-front controls.

Whatever you saw, see the tool for the job at your Rockwell distributor. He's listed under "Tools Electric" in the Yellow Pages.

Free Catalogs

Rockwell Manufacturing Company
654 N. Lexington Avenue
Pittsburgh, Pennsylvania 15208

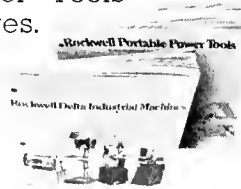

Name _____
Address _____
City _____ State _____ Zip _____



Rockwell
MANUFACTURING COMPANY

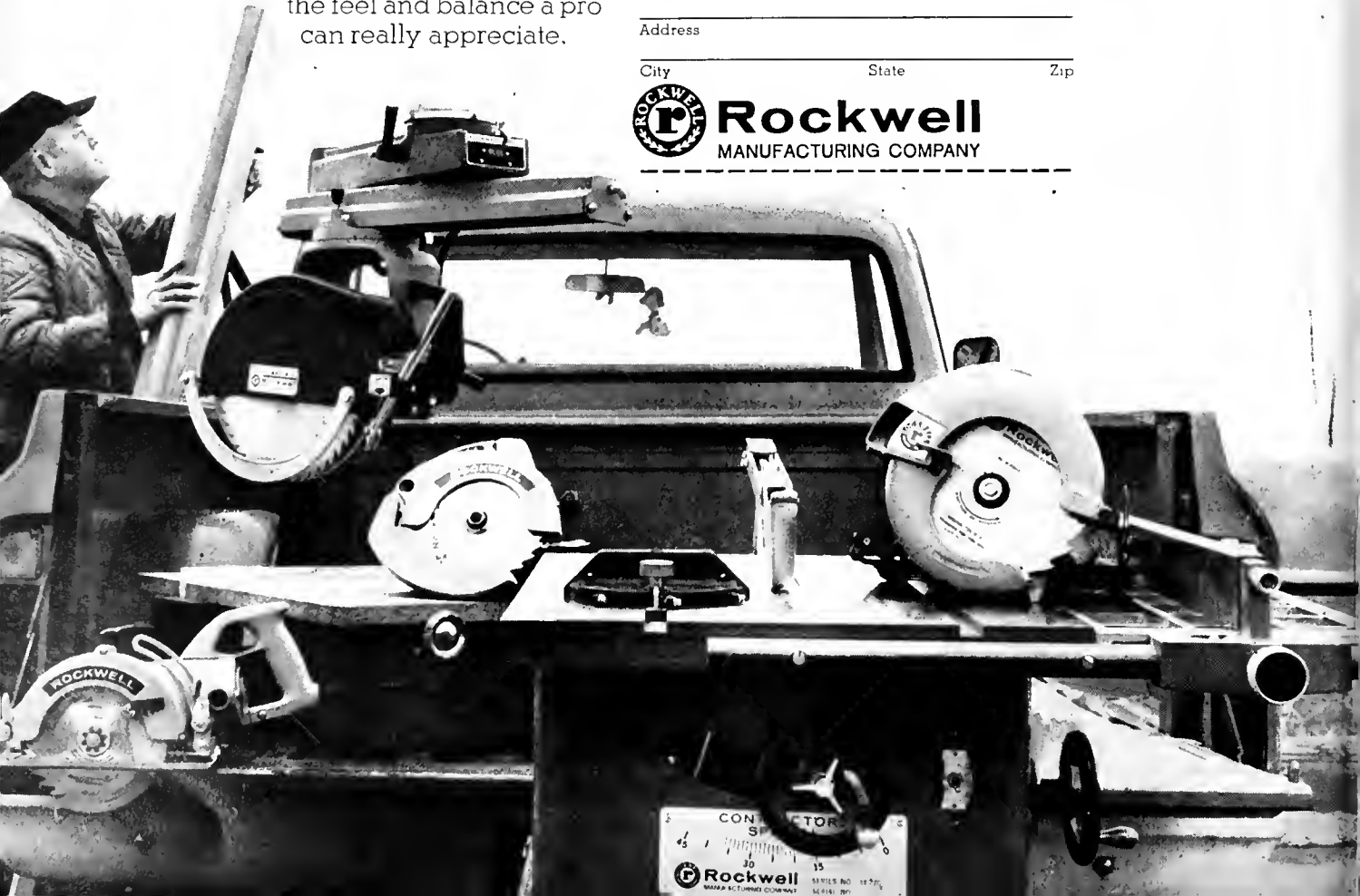

Bengough Retires from Board, Two Members Fill Vacancies

■ George Bengough, General Executive Board Member from the Tenth District, tendered his retirement to General President M. A. Hutcheson in August, and he officially retired last month.

At age 60, he has devoted 36 years of his life to the labor movement. He joined Local 452, Vancouver, B. C., on April 22, 1935, and he immediately became active in union affairs. He has been a pillar of strength for the Brotherhood in Western Canada, serving three terms in the 50's as president of the British Columbia Provincial Council.

He was named a special representative of the Brotherhood in 1947 by the late President, William L. Hutcheson, and he was named to the General Executive Board in the late 50's.

Brother Bengough's father, the late Percy Bengough, was at one time president of the Trades and Labor Congress of Canada and a leader in the International Assn. of Machinists. The elder Bengough died two months ago.

Succeeding George Bengough as Tenth District Board Member is Eldon T. "Al" Staley, a longtime friend of the retiree.

Born in Ontario on April 20, 1917, Staley began his apprenticeship in his native province in 1936. He joined the Canadian Army in 1940, serving for five years. On October 21, 1946, he joined Local 1598, Victoria, B. C., was elected the local union's financial secretary two years later and later held office as president.

He was elected president of the Vancouver Island District Council in 1950, serving two years. In 1951 he was elected executive secretary

of the British Columbia Provincial Council of Carpenters and served in that office for 11 years.

In 1962 he became a Brotherhood general representative. Two years after that he was elected president of the B. C. Federation of Labor and served in that office for six years. Elected a regional vice president of the Canadian Labor Congress in 1966, he will continue to serve in this capacity while a member of the Brotherhood's General Executive Board.

The retirement of Bengough created a second vacancy on the GEB. The first vacancy occurred, two months ago, with the elevation of Eighth District Board Member Charles Nichols to the position of General Treasurer, following the retirement of Peter E. Terzick.

Filling the Eighth District vacancy is M. B. "Bud" Bryant of Sacramento, California.

Bryant is a second-generation Brotherhood member. He and his late father, M. B., Sr., were both members of Local 586, Sacramento. The new GEB member joined that local union in 1946.

Born in Kansas City, Mo., February 16, 1925, Bryant served two years with the Air Force in the China-Burma-India Theatre during World War II. He attended Sacramento State College, attending night classes while working at the trade.

He served the 42 Northern California Counties of Carpenters and other area and state groups in many capacities before being appointed a special representative by General President M. A. Hutcheson in 1965. In 1966 he was appointed a general representative, and he served in that capacity until he assumed the new position. ■

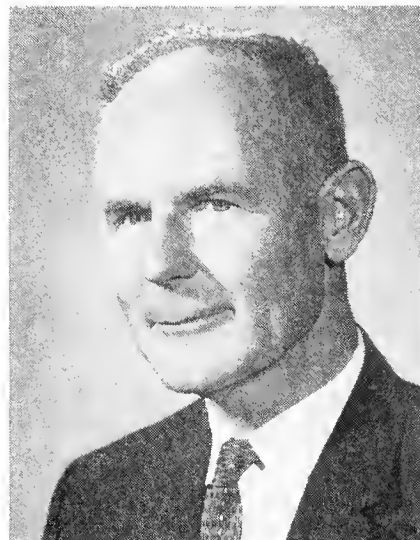

GEORGE BENGOUGH



ELDON STALEY



M. B. BRYANT



UNION MEMBERSHIP is a significant factor in whether the protection of a retirement plan is made available to a worker, a Labor Dept. economist observed in the Monthly Labor Review.

Only 18 percent of unionized workers did not have the option of a retirement plan while 58 percent of nonunion workers had no retirement plan available to them, according to a survey on which the article is based.

The author, Emerson Beier, is an economist for the Bureau of Labor Statistics, which publishes the Monthly Labor Review.

Beier also found that the incidence of pension plans or other deferred profit-sharing programs increased proportionately with wage levels and that the incidence of retirement plans varied with types of occupations.

In cases where wages averaged less than \$2.50 an hour, eight of 10 workers were in groups with no retirement plan available.

Where wages were \$5 or more an hour, however, eight of 10 workers had a pension plan available.

The proportion of workers with no plan available varied from industry to industry.

The survey found that overall, less than 45 percent of the nation's private, nonfarm workers had some type of retirement security available to them.

CREDIT CARDS—The Federal Trade Commission has issued a warning to issuers of credit cards, such as oil companies and department stores, to stop the practice of overstating the holder's legal liability on the cards they issue. The FTC noted that many companies have failed to change the wording on their credit cards as directed by a recent amendment to the Truth-In-Lending Act. The amendment limits liability for lost or stolen cards to \$50 on cards issued prior to January 25, 1971. Holders of cards issued after that date are subject to no liability.

PRODUCT STANDARD Approved for Hardwood and Plywood—The National Bureau of Standards, U.S. Department of Commerce, has announced that a Voluntary Product Standard, PS 51-71, for "Hardwood and Decorative Plywood" has been approved for publication. Effective as of August 15, 1971, the standard was developed as a revision of Commercial Standard CS 35-61, "Hardwood Plywood," at the request of the Hardwood Plywood Manufacturers Association. The purpose of the standard is to establish nationally recognized dimensional and quality requirements for the principle types and grades of hardwood and decorative plywood. It is further intended that the standard provide producers, distributors, and users with a basis for common understanding of the characteristics of the product.

OCCUPATIONAL OUTLOOK—"Among individual occupations, the largest number of openings during this decade will be for carpenters (39,300 yearly), electricians (21,200 yearly), automobile mechanics (19,600 yearly), and plumbers and pipefitters (19,500 yearly)." This prediction comes from the Bureau of Labor Statistics of the Department of Labor.

'DISCOURAGED' JOB SEEKERS—The number of "discouraged workers"—those outside the labor force who want jobs but are not looking for work because they are convinced they could not find it—increased by 150,000 in the last year bringing the total to about 750,000, according to Labor Dept. report.

"Discouraged" workers are not included in government estimates of the labor force or in official unemployment statistics. Only jobless workers who have recently tested the job market by unsuccessfully seeking work are counted in the monthly unemployment reports by the Bureau of Labor Statistics.

Secretary Livingston is Delegate to ILO, Geneva; Calls for Fair Labor Standards in Developing Nations

■ Fair labor standards should be a basic part of every contract and sub-contract negotiated by workers in the developing countries of the world, General Secretary R. E. Livingston told a special subcommittee of the International Labor Organization in Geneva, Switzerland, recently.

Serving as an official U.S. delegate to the gathering, Livingston stated that workers in developing nations lack adequate fair-labor protections. He and the U.S. employer delegates on the subcommittee joined in supporting an ILO resolution to establish such standards through the laws and regulations of the member nations.

The U.S. position was timely, in view of the current imbalance of U.S. import-export trade created by cheap labor overseas. Only by raising the standards of living of foreign workers, expanding purchasing power in each country, can U.S. workers compete in many areas today.

Secretary Livingston, served as a deputy member of The Workers Committee on Social Problems in the Construction Industry Arising Out of the Industrialization of Developing Countries. He was recommended for the post by AFL-CIO President George Meany and the Brotherhood's General President M. A. Hutcheson.

The Brotherhood leader also took a strong position on another item on the subcommittee agenda. The government representative from the Ukraine, proposed that "the activities of private foreign contracting firms in developing countries should be regulated, particularly with a view to insuring that the profits earned by such firms be used to accelerate the social progress of the developing country in question." Some delegates agreed and urged that foreign contractors be compelled to invest their profits in the country in which those profits are earned. A resolution to this effect was introduced by the Ukraine and supported by Uruguay, the USSR, and Byelorussia.

Secretary Livingston opposed the resolution on the grounds that it would permit foreign powers to subsidize international contractors who would agree to invest their profits in the developing country and prevent legitimate international contractors from bidding on such projects.

Livingston was supported in his

US delegation opposes resolution permitting foreign powers to subsidize international contractors who reinvest profits locally.



The two building trades leaders who represented US labor at the recent sessions of the International Labor Organization in Geneva, Switzerland, are shown attending a plenary session. At left, Joseph T. Power, general president of the Operative Plasterers and Cement Masons' International Assn., and, second from left, the Brotherhood's General Secretary, R. E. Livingston.



Labor and management representatives of many nations discuss mutual problems in a meeting room in ILO headquarters in Geneva. Secretary Livingston served on The Workers Committee on Social Problems in the Construction Industry arising Out of the Industrialization of Developing Countries.

move to defeat the resolution by his co-delegate, Joseph T. Power, general president of the Operative Plasterers and Cement Masons International

Assn., and the US employer delegates, William Dunn and Frederick W. Mast of the Associated General Contractors. ■

People With Ideas...

RESTORATION OF A MONUMENT

In 1871, Milton S. Latham, former California governor and United States senator, bought 380 acres of land in Menlo Park, California, for a price of \$75,000. He proceeded to build a 50-room mansion on the property, and furnished it at a cost of \$200,000. In 1879, Senator Latham built a gatehouse, then named "Thurlow Lodge," to accommodate the supervisor of the estate.

In the years that followed, the property changed hands numerous times. Today, the only remaining vestige of the original 380-acre estate is 1.1 acre on which stands the old gatehouse and a garage. Purchased from Stanford University by the City of Menlo Park, the Hopkins Gatehouse, as it is now called, has been restored as an historical monument. Restoration of the building's shingled roof was handled by the Dan Goodwin Roofing Company. However, the actual work of cutting and replacing shingles to match the original design was done by Oris J. Watts, member of Local 162 in San Mateo, Calif. Watts ably demonstrated his craftsmanship by producing the perfect triangular design which can be seen on the gatehouse roof today. Each shingle had to be cut perfectly and then placed without the slightest variation in order to achieve the beautiful overall effect. ■



REINHARD'S HOME FIRE ESCAPE

■ Fire strikes when we least expect it, and statistics show that the majority of fire victims perish in upstairs rooms. Fire departments everywhere urge residents of two-story dwellings to provide for a second means of escape.

The SureSafe escape system, developed by a Brotherhood member, is the answer to this problem, and it is available at a price which most pocketbooks can afford.

The retractable ladder is the brainchild of C. A. Reinhard, a member of Local 1622, Hayward, Calif.

SureSafe, which will not open from the bottom, opens instantly from the top at the touch of even a small child. When closed, it resembles a rain downspout and does not detract from the beauty of a home.

Further information on the SureSafe Retractable Ladder can be obtained from C. A. Reinhard at 594 Beatrice Street, San Leandro, Calif. 94579 ■

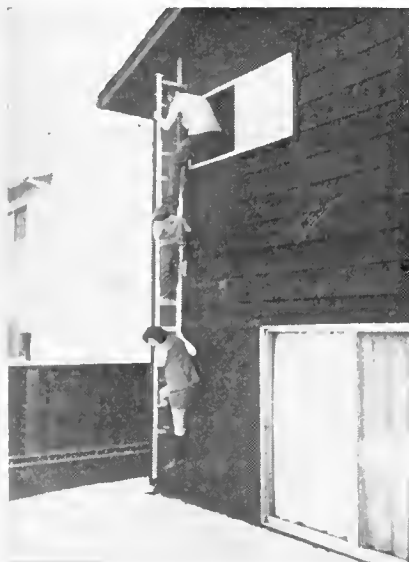

MAN'S BEST CADDY

■ Pat Pattison, an avid golfer and a member of Local 1453 in Huntington Beach, Calif., has undoubtedly been asked a thousand times why he persists in treating his caddy "like a dog." The question is always posed with a wry smile, however, Pattison's caddy is a dog.

Kari, a mixture of German shepherd and collie, has been Pattison's partner on the golf course for years. Not only is she an uncomplaining caddy, attached to a cart by means of a customized harness, but is also an adept retriever. Anyone who has ever watched her as her master engages in one of his practice sessions could attest to that fact. As Pattison takes his practice shots, Kari snatches the balls out of the air on the second or third bounce. She dutifully deposits each one in a rattan basket and, when Pattison has exhausted his supply of balls, returns the full container to her partner.

"It took me about 200 hours to teach her to do that," Pattison said. "I wouldn't have tried it if I hadn't realized right away that she's really an intelligent dog.

"My stepson, Mike, got her out of a pound 10 years ago while he was a student at UCLA. He thought it would be a good idea to have a dog around his apartment. Kari was just a pup then and she immediately started having accidents all over the place. Mike knew I'd trained dogs when I

Continued on page 39

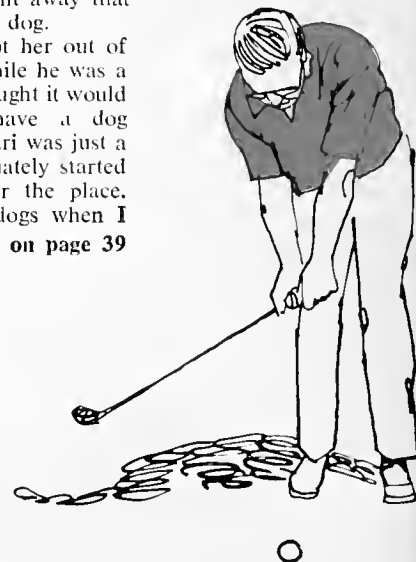



HARPS ON CHALLENGE

■ Retired carpenter, Albert Pschirer, of Millvale, Penna., is not one to avoid a challenge. While reading a carpenter's trade book one evening, he noticed a sketch detailing how to build a "mini" concert harp. The book specified, however, that the harp could not be built without the aid of a kit, which he could obtain for a price.

"I knew I could build a harp without buying their kit," said Pschirer. The challenge had been made, and he readily accepted.

He decided the first thing to do was contact a music dealer in order to find out exactly what a harp looked like. Previously, he had only seen the instrument in books or in movies. To his surprise, Pschirer learned that one of the top local music dealers had not sold a harp in eight years. "Few people know how to play them anymore," he was told.

The music dealer gave him the names of two firms, one in New York and one in California, which handle the necessary materials for making harps. Pschirer contacted the New York firm and obtained the names of two professional harpists in the Pittsburgh area. After several sessions with the harpists, he decided that he was ready.

Having completed his research and having obtained the necessary materials, Pschirer retreated to his basement workshop. Using black walnut for the handle and spruce for the sound box, he worked for four months on the project. Pschirer estimates that the materials in each harp cost him \$125, but the finished instruments could easily be sold for \$600 each.

"My only complaint," said Mrs. Pschirer, "was the dust. It also gave me something to do, going through the house with a duster after Al was through at the lathe." ■

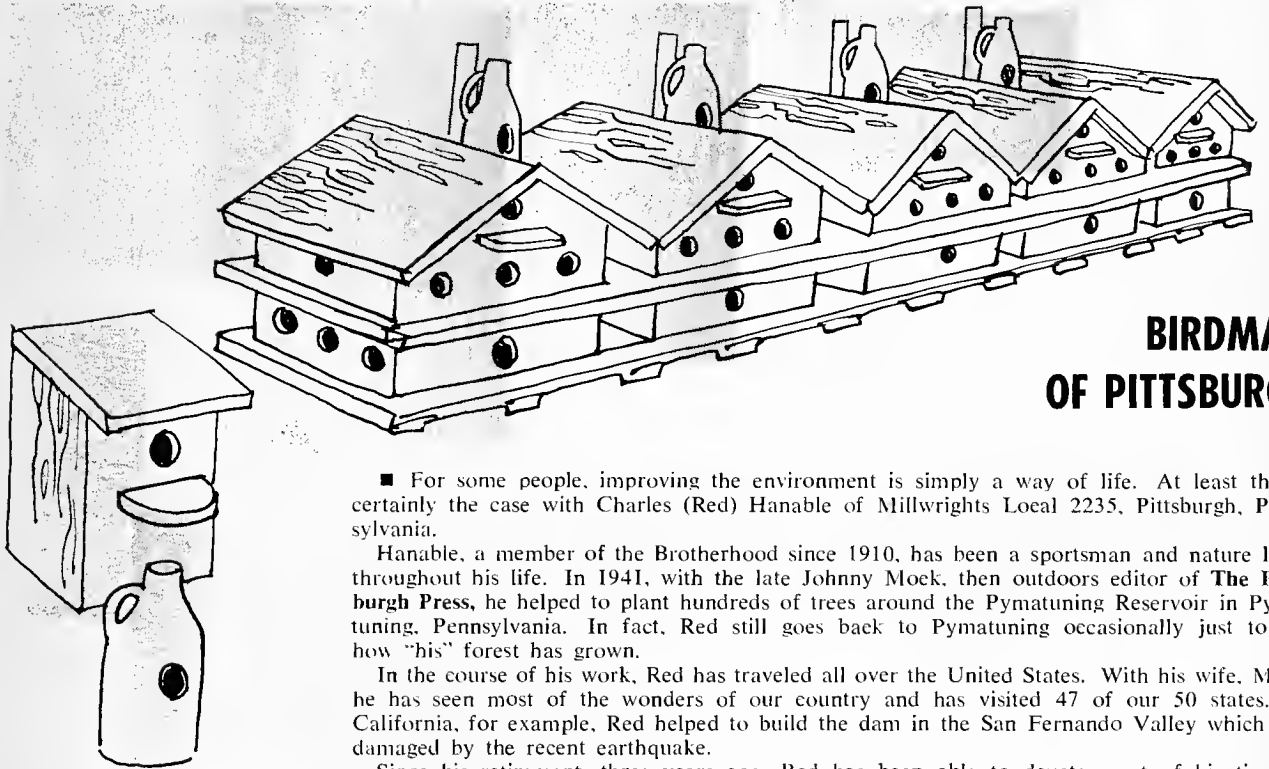

BIRDMAN OF PITTSBURGH

■ For some people, improving the environment is simply a way of life. At least this is certainly the case with Charles (Red) Hanable of Millwrights Local 2235, Pittsburgh, Pennsylvania.

Hanable, a member of the Brotherhood since 1910, has been a sportsman and nature lover throughout his life. In 1941, with the late Johnny Mock, then outdoors editor of *The Pittsburgh Press*, he helped to plant hundreds of trees around the Pymatuning Reservoir in Pymatuning, Pennsylvania. In fact, Red still goes back to Pymatuning occasionally just to see how "his" forest has grown.

In the course of his work, Red has traveled all over the United States. With his wife, Mary, he has seen most of the wonders of our country and has visited 47 of our 50 states. In California, for example, Red helped to build the dam in the San Fernando Valley which was damaged by the recent earthquake.

Since his retirement, three years ago, Red has been able to devote most of his time to his interest in nature and in our environment. On a hilltop behind his home in the Ross Township area of Pittsburgh, he has built a haven for birds. In fact, Red has some 60 birdhouses around his home, the building materials for which were donated.

Red says that his \$30-a-month Carpenter pension just about sees that the birds are fed through the winter. He fills his 30-gallon barrel feeders with 100 pounds of corn and with a quantity of grit in order to accommodate them. As a result, the Hanables have been host to an innumerable number of birds, during both winter and summer. Indeed, for the Hanables, concern for our environment is nothing new. For them, it is just a way of life. ■

The Negative Side of Apprenticeship

By WILLIAM SIDELL
First General Vice President

Our first General Vice President, William Sidell, was a speaker at the Southern State Apprenticeship Conference, held in Hollywood, Fla., last July. His remarks to that gathering indicated the general feelings of the Building Trades regarding their apprenticeship training programs and the "built-in obstacle courses" which make it difficult to carry on such programs. Here are excerpts from his address:

■ We need and are going to need many well-trained craftsmen to build and rebuild our country; but such craftsmen, in the numbers we're going to need, don't just happen. They are produced by large numbers of well-conceived, well-financed, and efficient local apprenticeship programs. And they will not be produced without such programs. My concern is that our programs are not going to be allowed to get on with the job with a maximum of help and resources, and a minimum of interference.

It is an ironic sign of the times that those of us above the operating level who are trying to do something about apprenticeship spend more time defending ourselves against governmental attacks on our programs than we do in developing better programs. Any apprenticeship program these days has to face a built-in obstacle course of basic social and economic realities which makes it very difficult to find competent apprentices, to train them, and to provide them the employment they need to learn and to earn a living.

Those of you in the business need no reminder that it is a tough job under the best of circumstances, and I imagine that what you expect most from those of us who are responsible for general policy is help in improving your programs, materials and teaching. And speaking for my own union, I think it's fair to say that in recent years our General Office has provided the leadership for a tremendous improvement in our apprenticeship programs, training methods and materials. But if one of our local apprenticeship directors were to ask me today: "What are you doing for us lately?" I'm afraid my honest answer would have to be:

"We're spending most of our time trying to keep the Federal government off your backs so you can be free to run your own programs for the benefit of your apprentices and the industry in your area." And I believe our experience is typical at least of the building trades in general.

All of this wouldn't be quite so hard to take, if we could feel that we were at least succeeding with this negative task of maintaining the freedom of our local programs to carry on their business in a sensible way. Unfortunately, the latest developments in Federal apprenticeship policy threaten to impose new and perhaps intolerable burdens on our local programs.

Federal apprenticeship policy in the past has been based upon the simple premise that apprenticeship was socially and economically desirable, and that it was good public policy to encourage apprenticeship and to maintain high standards in Federally approved programs. Although apprenticeship today has many enemies, I don't believe that anyone can successfully maintain that the competence of a craftsman is not of great value both to society and to the craftsman.

In spite of the opinions of many educated theorists with little experience of the workaday world, a great deal of the work that has to be done in the real world has not been reduced to pushing buttons on an assembly line. This is certainly true in the construction industry, and in many other areas as well. In this day of glorified incompetence, society has a pressing need for men who really know their jobs. I don't believe I need to belabor this point for this audience; and in theory at least basic Federal policy still rests on the social and economic value of apprenticeship.

The trouble, of course, comes when the basic aim of governmental policy is frustrated or sometimes perverted by those who are charged with the responsibility of administration. As usual these days, basic apprenticeship policy is created by law, but it is left to the agency administering the law to spell out the details in its administrative

orders or regulations. This has been done by the U. S. Department of Labor in regulations identified as Title 29 CFR. Recently, in spite of vigorous and reasoned opposition from those of us with a real stake in making apprenticeship work, the Department of Labor, by executive order, put into effect an extensive revision of Title 29 CFR, Part 30, which deals with equal employment opportunities.

This action came after more than a year of frustrating meetings of the Building and Metal Trades with the Department of Labor in which we tried to convince the Department's representatives of the harm that these revisions would bring to apprenticeship and to our industries. Maybe the new regulations aren't quite as bad as they would have been if we hadn't fought the good fight; but they represent a real threat to the existence of our programs.

Our basic objection to the revised version of Part 30 is that the Department of Labor, in its eagerness to assure fairness to minority groups, is setting up requirements far beyond those necessary for that purpose, and in so doing is imposing on all programs vague and unreasonable demands which may make it impossible for them to function at all. After all, an ineffective or non-existent program cannot afford a fair opportunity for apprenticeship to anyone.

Our opposition to the revision of Part 30 was not based on any denial of the proposition that young men from minority groups are entitled to a square deal in apprenticeship. We also believe that past discrimination justified extra steps to prepare minority youths for apprenticeship and to assure them a fair opportunity. But, as we pointed out to the Department of Labor, under the 1963 provisions of Part 30 the growth of minority participation in construction industry apprenticeship programs was already significant. In fact continued growth at the rate already achieved would have, within a year, have brought the percentage of minority apprentices considerably above the percentage of minority population to the total population of the United States. Unfortunately the doctrinaire views of bureaucrats who have already made up their minds are often difficult to change by an appeal to common sense. So until we can get legislative relief, we're stuck with the Labor Department's new version of Part 30.

The new regulation first of all requires that all apprenticeship programs have an affirmative, active program.

We're not sure just what will constitute a satisfactory affirmative action program for any particular Apprenticeship Committee: and we don't believe the Department of Labor is either.

In general it appears to mean that every apprentice program must assume the burden of doing its best to seek out all potential minority group apprentices in its area and persuade them to become apprentices. This requirement seems to us to place an unrealistic and unbearable logistic and financial burden on program sponsors. There just isn't that kind of manpower and money available. Moreover, this requirement is so vague that no program sponsor could ever be sure that he had done enough to satisfy such a requirement.

We will, of course, as we must, comply with the regulations in force to the best of our ability. We are already deeply committed to many kinds of activities which will surely qualify as affirmative action. We will continue our support and operation of such programs as MDTA-Pre-apprenticeship Development, Job Corps, Operation Transition, and Outreach, as well as other programs which promise to expand opportunities for apprenticeship and training.

The regulations further require that program sponsors determine the percentage of minorities in their areas and set goals and timetables for bringing minority participation in their organizations up to that arbitrary percentage. This is a requirement for a quota system, which we believe to be not only unfair and impractical, but also unconstitutional. We shall continue our efforts to increase minority participation, but not at the expense of other potential apprentices. As a matter of fact Sec. 30.18 of these regulations appears to forbid such a quota system.

The third major requirement of the new regulations strikes directly at the normal admission procedures which attempt to select candidates who will have a reasonable chance to be successful apprentices. It calls for abolishing existing lists of apprenticeship candidates and the procedures by which they are selected, and the choice of apprentices by lottery from a non-selective pool which meets only minimum age and physical requirements. The only alternative is selection of apprentices by statistically validated tests, whatever that means. Presumably you should be able to show that apprenticeship candidates who pass such a test will be more likely to succeed as apprentices than those who do not. We believe that the usual kinds of tests used by our programs fit that definition; we intend to use what we think are valid selection criteria unless it is found to be discriminatory. It makes no sense at all to accept candidates for apprenticeship without regard to their ability to complete their apprenticeship and become competent craftsmen.

Continued on page 39

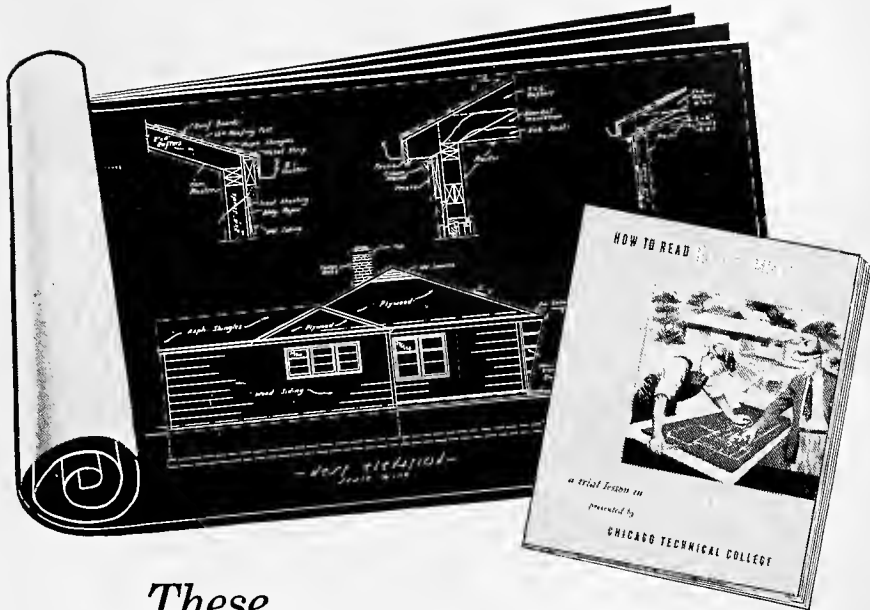

These
FREE BLUE PRINTS
have started thousands toward
BETTER PAY AND PROMOTION

That's right! In all fifty states, men who sent for these free blue prints are today enjoying big success as foremen, superintendents and building contractors. They've landed these higher-paying jobs because they learned to read blue prints and mastered the practical details of construction. Now CTC home-study training in building offers you the same money-making opportunity.

LEARN IN YOUR SPARE TIME

As you know, the ability to read blue prints completely and accurately determines to a great extent how far you can go in building. What's more, you can learn plan reading simply and easily with the Chicago Tech system of spare-time training in your own home. You also learn all phases of building, prepare yourself to run the job from start to finish.

CASH IN ON YOUR EXPERIENCE

For over 67 years, building tradesmen and beginners alike have won higher pay with the knowledge gained from Chicago Tech's program in blue print reading, estimating, foremanship and contracting. Through step-by-step instruction, using actual blue prints and real specifications of modern, up-to-date buildings, you get a practical working knowledge of every building detail—a thorough understanding of every craft. And as a carpenter or apprentice, you already have valuable experience that may let you move up to foreman even before you complete your training.

Don't waste a single day. Start preparing right now to take over a better job, increase your paycheck and command greater respect as the "boss" on the job. Find out about Chicago Tech's get-ahead training in building. Send for your free blue prints and trial lesson — today! **Approved for Veterans.**

CHICAGO TECHNICAL COLLEGE

N-143 TECH BLDG., 2000 S. MICHIGAN AVE., CHICAGO, ILL. 60616

**FREE
 BLUE PRINTS
 AND
 TRIAL LESSON**

Send for your free trial lesson now. You'll agree that this training is simple yet practical—your surest way to promotion and increased income in building.

MAIL COUPON TODAY

Chicago Technical College
 N-143 Tech Bldg., 2000 S. Michigan
 Chicago, Illinois 60616

New G.I. Bill!
Vets check here

Please mail me Free Trial Lesson, Blueprints and Catalog.

Name _____ Age _____

Address _____

City _____ State _____ Zip _____

Occupation _____

Accredited Member National Home Study Council

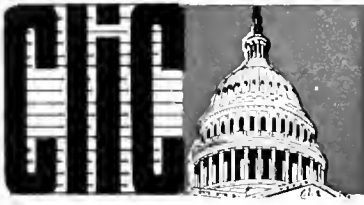

REPORT

- MANY MEMBERS CONTRIBUTE 1% OF PAY
- STATE CONVENTIONS AID THE CAUSE
- PLAQUES PLANNED FOR HIGH % LOCALS
- GENERAL TREASURER NICHOLS, DIRECTOR



Edward Bjork, first to contribute 1% of pay.

■ The tempo of activity for the Carpenters Legislative Improvement Committee is picking up during the fall months. Indications are that the remaining 1971 state conventions of the Brotherhood will add substantially to the total funds already contributed to CLIC this year.

Among the recent state-convention collections were the following: Texas, \$1,090; Arkansas, \$24; Indiana, \$1,621; Wisconsin, \$602; New York, \$1,925; Mississippi, \$70; New Jersey, \$1,105; Michigan, \$1,425; Ohio, \$3,030; Illinois, \$1,105; and Pennsylvania, \$1,465.

These funds were collected through the sale of the gold lapel pins and tie clips, and all contributions were, of course, voluntary.

In addition to these, the Montana South Central District Council sent in \$45; \$100 was collected at the Southern States Apprenticeship Conference.

On August 9, the South Jersey District Council turned over to CLIC Director Peter Terzick checks totaling \$1,500, which represented a \$1 contribution from each member of the local unions comprising this district council.

The \$1,105 contributed by the New Jersey State Convention was in addition

to \$510 contributed by delegates to the recent meeting of the New Jersey Non-Partisan Political Committee.

Big givers on a per capita basis were the 74 delegates to the Michigan State Council Convention, who contributed an average of almost \$20 each, and the 218 delegates to the Ohio State Council Convention, who contributed an average of \$14 each.

■ Several district council officers and business agents have started to follow the lead of the General Officers in

contributing 1% of their pay each week to CLIC.

First to join the parade was Edward Bjork, secretary of the New York City and Vicinity District Council, who was first to make a 1% yearly contribution in January, 1969, and has continued to do so every year since. In April, 1970, Warren Conary, organizer for the Florida State Council, signed up for a 1% checkoff. David Hedlund, business agent of Local 1489, Burlington, N.J., joined the elite in May, 1971. Then on August 9 Thomas Ober, John Holzermer, and Deno Venturi, business agents, and Paul Jackson, secretary-treasurer, all of the South Jersey DC, also signed up. At the New Jersey State Council Convention in September, business agent Harry Sipes of Local 191, York, Pa., requested to be allowed to join this select group.

■ When Peter Terzick retired as General Treasurer of the Brotherhood recently, he also retired as director of CLIC. This position has now been filled by the new General Treasurer, Charles Nichols.

■ Nichols has announced that plans are being formulated to present plaques, next year, to the local union in each state with the highest percentage of CLIC contributors during 1972. More about that in another issue. ■



CLIC BOOSTERS at a recent meeting in New Jersey display a CLIC poster and pledge continued support of the year-round program. All of them have subscribed 1% of their pay to CLIC. Left to right: John H. Holzermer, business representative, South Jersey District Council; Harry H. Sipe, financial secretary and business representative, Local 191, York, Pa.; Thomas C. Ober, business representative, South Jersey District Council; Robert Ohlweiler, general representative; Raleigh Rajoppi, board member, Second District & pres., New Jersey State Council of Carpenters; David R. Hedlund, business representative Local 1489, Burlington, N. J.; Deno Venturi, business representative, South Jersey District Council; and Paul Jackson, secretary-treasurer, South Jersey District Council.



"We Congratulate..."

... those members of our Brotherhood who, in recent weeks, have been named or elected to public offices, have won awards, or who have, in other ways, "stood out from the crowd." This month, our editorial hat is off to the following:



HELPFUL BROTHERS—Jack More (in wheelchair) and his wife, Ivy, found that the spirit of brotherhood was still very much alive when Jack, of Local 452, Vancouver, B.C., was seriously injured on a job in 1970.

More found it very difficult to come home from the hospital, as it was hard for him to get into the house. Brothers of Local 452, in the background, left to right, Ewald Ginter, John Hanna, John Marcher, Mel Campsall, Fred Roberts and Joe Balabuk volunteered to build him a ramp and sundeck, so now Brother More is home on a three-month leave from the hospital, and he hopes this becomes permanent.—Photo by Carl Erickson.



Carl Reiter and Robert Filler

A SIGNAL HONOR . . . Carl Reiter, left, assistant executive secretary-treasurer of the Carpenters' District Council of Greater St. Louis, Mo., accepts the Veterans of Foreign Wars' "Americanism Award" from Robert L. Filler, commander of the Missouri Department of the VFW. The award was presented to the Council at ceremonies marking the 51st Annual Convention of the Missouri Department of the VFW.

The citation accompanying the award read: "The Veterans of Foreign Wars of the United States awards this citation to the St. Louis Carpenters' District Council as an expression of sincere appreciation and full praise for patriotic services rendered to this community."

Planer · Molder · Saw!

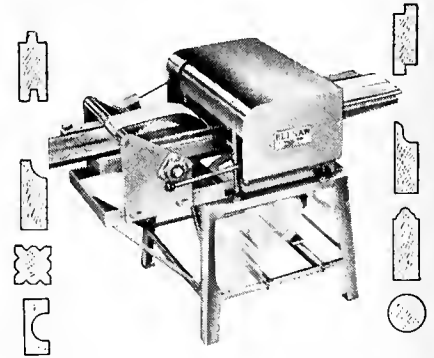

Now you can use this **ONE** power feed shop to turn rough lumber into high-value moldings, trim, flooring, furniture . . . **ALL** popular patterns.

RIP . . . PLANE . . . MOLD . . . separately or all at once by power feed . . . with a one horsepower motor. Use 3 to 5 HP for high speed commercial output.

LOW COST . . . You can own this **MONEY MAKING POWER TOOL** for only . . . **\$30.00** down.

Send coupon today

BELSAW POWER TOOLS
 9421 Field Bldg., Kansas City, Mo. 64111
 Send me complete facts on the **MULTI-DUTY Power Tool**. No obligation.

Name _____
 Address _____
 City _____ State _____ Zip _____

You'll Like Being a SKILLED LOCKSMITH

You'll **EARN MORE, LIVE BETTER** than Ever Before in Your Life

You'll enjoy your work as a Locksmith because it is more fascinating than a hobby—and highly paid besides! You'll go on enjoying the fascinating work, year after year, in good times or bad because you'll be the man in demand in an evergrowing field offering big pay jobs, big profits as your own boss. What more could you ask!

Train at Home—Earn Extra \$\$\$\$ Right Away!
 All this can be yours **FAST** regardless of age, education, minor physical handicaps. Job enjoyment and earnings begin **AT ONCE** as you quickly, easily learn to **CASH IN** on all kinds of locksmithing jobs. All keys, locks, parts, picks, special tools and equipment come with the course at no extra charge. Licensed experts guide you to success.

Illustrated Book, Sample Lesson Pages FREE
 Locksmithing Institute graduates now earning, enjoying life more everywhere. You can, too. Coupon brings exciting facts from only school of its kind Lic. by N. J. State Dept. of Ed., Accredited Member, Natl. Home Study Council. Approved for Veteran Training.

LOCKSMITHING INSTITUTE
 Div. of Technical Home Study Schools
 Dept. 1118-101 Little Falls, N. J. 07424

LOCKSMITHING INSTITUTE, Dept. 1118-101
 Little Falls, New Jersey 07424 Est. 1948

Please send **FREE** illustrated Book—"Your Big Opportunities in Locksmithing," complete Equipment folder and sample lesson pages—**FREE** of all obligation—(no salesman will call).

Name (Please Print)
 Address
 City State Zip
 Check here if Eligible for Veteran Training



Earned \$150 During Training
 I realized with **LOCKSMITHING** I'd be able to double my income. During my training period I made \$150.
 Paul Funes
 New York, N. Y.



PLANE GOSSIP

SEND YOUR FAVORITES TO:
PLANE GOSSIP, 101 CONSTITUTION
AVE. NW, WASH., D.C. 20001.
SORRY, BUT NO PAYMENT MADE
AND POETRY NOT ACCEPTED.

Couldn't Agree Quicker!

The express train of the subway had operating difficulty and stopped at an unscheduled station. There a man jumped aboard. "Wait!" cried the conductor, "this train doesn't stop at this station!"

"Well, then," said the man, "it's good that I didn't get aboard it!"

STRIKE A LICK—GIVE TO CLIC



That Sinking Feeling!

A sailor in a Navy swimming class balked at jumping from a 30-foot platform. The instructor tried to persuade him. "What would you do if you were that high on a sinking ship?"

"Sir," replied the quaking gob, "I'd wait for it to sink about 20 feet or so!"—Hans Haase, Local 2155, Dix Hills, N.Y.

ATTEND YOUR UNION MEETINGS

Bound to Complain

Modern cruelty: the airline stewardess who straps you securely in your seat, then asks: "Is there anything you'd like?"



Quite An Operator!

The little boy recovering in the hospital told his mother that God had taken his tonsils out. Pressed for an explanation, he told this story: "They wheeled me into a shiny room where there were two lady angels in white dresses and two men angels in white suits. One of the men angels opened my mouth, looked in it, and said: 'God! . . . Look at this kid's tonsils!'"

"Then God came over," the boy continued, "took a look at my tonsils and said, 'Yes . . . well, I'll take them out right now!'"—Norman Craven, Anchorage, Alaska.

BE UNION—BUY LABEL

A Gay Non-Deceiver!

The used-car dealer, selling a clunker, kept referring to it as "an honest car." He finally made the sale, then the buyer asked: "Why did you keep calling this 'an honest car?'"

"Because every time I started it up, it threatened to die . . . and it never deceived me!"

I 4 ALL—ALL 4 I

Landing a Judgeship

The lawyer was stating his opinion that no attorney should be made a judge unless he owned real estate. "Tell us," asked an opponent, "how many acres does it take to make a wise-acre?"

This Month's Limerick

A corpulent old man from Dorem
Bought pants too tight, but he wore 'em
When he stooped down and
laughed
He felt a cool draft
And he knew right then that he'd
tore 'em!

Earl H. Benner, Sr.
Local 696, Tampa, Fla.

The Super-Salesman

The department store clerk had broken all sales records, and was explaining how he did it. "A customer came in and I sold him some fish hooks. Then I sold him some line for the hooks. Next I convinced him he needed a rod to go with the line. After he bought that, I sold him a boat so he could use his rod in deep water. Next I told him he had to have a trailer for the boat and I sold him that. Finally, when I found out he didn't own a car, I sold him mine!"

"But I assigned you to the greeting-card department," objected the boss.

"That's right," the super-salesman agreed. "Originally he came in for a get-well card for his girlfriend, who has a broken hip. I told him that, since he wouldn't have anything much to do for six weeks or so, he might as well go fishing!"—F. S. Millham, Fullerton, Pa.

LOOK FOR THE UNION LABEL



No Stomach For It!

Said the man to the panhandler; "No, I won't give you a quarter, but I'll buy you some breakfast."

"Forget it," replied the bum. "I already had three breakfasts, trying to get a quarter!"

WORK SAFELY—ACCIDENTS HURT

Got Roped In!

Pat and Mike, riding in a carriage, passed a gallows. "Where would you be now," said Pat, "if the gallows had its due?"

"Be hanged 'f I know," replied Mike. "Riding alone, I reckon!"

TEL M U R UNION!

Not As A Last, Either!

Girls who look good in the most expensive resorts generally get taken there.



CANADIAN REPORT

Temporary Health Agencies Keep Wages Low; Government Employment Substitutes Needed

Temporary help agencies, so-called, are not a form of endeavor which have been favored by the trade union movement. There was one era during the life of the province of Ontario, at least, when it had a Farmer-Labor government after World War I, when their activities were restricted.

Eventually, after the Second World War the federal government set up its own employment bureaus, now known as Canada Manpower Centers.

But after a lull in their activities, temporary help agencies are again thriving. They are looked upon by some as a necessary supplement to the government employment offices. To others, especially trade unionists, they are looked upon like hangovers from the slave trade.

In any case, these agencies offer anti-labor employers one means of discouraging unionization by holding over the heads of their employees the threat of being replaced by readily-available job-seekers and another means of providing the employer with scab labor in the event his regular employees venture to strike.

There are, no doubt, temporary help agencies both good and bad, some ethical, some unethical; but the fact is that all these agencies deal with humans as a commodity from whose sale they derive their earnings and profits.

The products they sell, of course, are blue collar workers, farm workers, trained technical personnel and white collar workers.

The industry is profitable enough to have attracted firms which operate on both sides of the border, like Office Overload, probably the best known and a division of the Drake International company; Industrial Overload, a subsidiary of Office Overload; Staff Builders Temporary Personnel; and

Manpower Temporary Help and Business Services Ltd.

Some trade union organizations have gone on record—the Ontario Federation of Labor is one—in favor of expansion of the government agencies to eliminate the need for private companies which charge employers high hourly rates which do not necessarily accrue to the employee.

These so-called temporary help firms can do very well indeed when an employee hired presumably for a short period remains for a long time.

One specific case which can be cited involved a relatively new English-speaking immigrant who signed up with a temporary help agency and was sent to work on a job on an assembly line.

Fee charged to the client for this particular worker by the agency was to be based on \$2.75 an hour. The employee herself was paid only \$1.75 an hour for an 8-hour day over a six-month period. Yet the average wage paid by the employer to his other non-union employees was only \$2.25 an hour.

The agency was clearing one dollar an hour for the employee it supplied, or \$8 a day and \$40 a week. In the six-month period, it grossed over \$900 on one worker in half a year.

If Ontario is any criterion, the regulations covering these agencies only try to assure that they meet the requirements of the Employment Standards Act and the fees due to the Ontario Workmen's Compensation Board.

Compensation Board fees to agencies are higher than those charged regular employers, due to lack of control temporary agencies have over working conditions of their employees.

Yet some companies prefer to hire help from these agencies just for this reason—the agency and not the com-

pany is responsible for safety conditions.

Once a person registers with an agency, his or her services are in fact for sale by that agency.

Employees of agencies in the blue collar field are usually expected to arrive by 6:30 a.m. and may well sit from then until noon waiting for assignment—without pay or compensation.

Canada Manpower Centers do not seem to be too interested in the temporary help field. As one official in Canada Manpower said, “. . . it is the policy of the Manpower Department not to interfere in the activities of private Temporary Help Agencies.”

It is also the policy of Canada Manpower not to separate in their research statistics those who are permanently employed from those who are temporarily employed.

Because unemployment figures do not distinguish between those who work a full day and those who may work only part-time, national employment figures distort the true picture, if one considers that normal employment means a full day's work, and a full week's work.

So, while Canada Manpower Centers do act as general public placement agencies, they have failed to specialize in providing temporary help, so the private help agencies have filled the gap and are doing a profitable business in the sale of human labor.

Housing Minister Taking Initiative

Canada finally has a housing minister who doesn't sit on his hands either hoping that something will come along, or maybe hoping that nothing will come along.

Robert Andras is federal minister of state for urban affairs, and as such, is the first cabinet minister who has the responsibilities which include housing as a fulltime job.

One of his latest moves is to initiate a program to teach specialists in local government administration.

This will be the first step in a broader program to step up the status of local government administrators to the level of those in senior government positions and private industry.

This action by housing minister Andras will be coordinated with those of Central Mortgage and Housing Corporation, also under his jurisdiction, which is contributing \$925,000 for

**YOU GET MORE
OUT OF THEM
'CAUSE
VAUGHAN
PUTS MORE
INTO THEM!**

**... AND HAS FOR
MORE THAN
100 YEARS**



999

A 20 oz. heavy duty beauty. Large striking face. 14" or 16" tap grade hickory handles. Plain or millet face.



FIBERGLASS

Exclusive hollow core design adds greatest strength, better balance, absorbs more shock. 13 to 20 oz. sizes, nail and rip.



SUPER BAR

15" all purpose pry bar. A must for every tool box.

Request catalog illustrating complete line of striking tools and pry bars.



**VAUGHAN & BUSHNELL
MFG. CO.**

11414 MAPLE AVE., HEBRON, ILL. 60034

graduate students in urban and regional studies.

Getting more experts into local government will help both the community and the trade union movement.

Labor Short-Changed In History Books

A recent study by the Ontario Human Rights Commission shows that labor is discriminated against in the history books.

Every union educator knows this and many have protested against it, but to have it proved to public satisfaction may mean that something will be done about it.

The 131-page survey included only a page and a half on the labor movement, but this was enough to show that what little labor history was contained in school text books put the emphasis on violence. For example, the history of the Winnipeg General Strike 1919, a turning point in trade union history, is full of errors and prejudiced against union leaders.

Now what will be done about it?

U. S. Travel Service Opens New Office

The United States Travel Service is opening an office in Canada for the first time. It is being located in Toronto, starting this month.

The U.S. never seemed to worry about Canadian visitors until now that its adverse balance of payments is causing concern.

Canadians have, of course, the impression that the majority of the population visits some part of the United States some time or other, with New York, Florida and California the chief areas of interest: New York for business and pleasure, the two southern states for those who want to escape the Canadian winter for a few months, or want to retire to a warmer climate.

Last year, however, U.S. visitors to Canada spent \$164 million more than Canadian visitors to the United States which was one part of the adverse balance on tourist business which the U.S. experienced. Americans spent over \$5 billion away from home last year compared with just \$2,665,000,000 which other people spent in the U.S.A.

In 1970, about 1,600,000 Canadians spent three nights or more south of the border while 14,300,000 tourists from the United States spent at least that amount of time in Canada.

Lil' Doll.

**MOST ECONOMICAL WAY
TO MOVE MATERIAL AT
THE JOB-SITE**

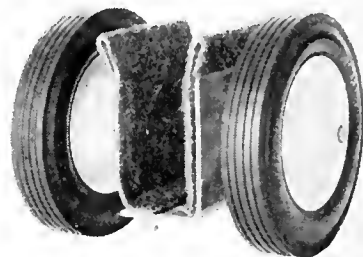

No more back-aches or sore muscles! Our Lil' Doll does all the work—a new idea for on the job transportation of materials. Doors, plywood sheets, counter tops and similar material up to 2-1/4" thick are easily rolled to the point of installation. A padded 3/16" steel carriage and 8" heavy duty ball bearing wheels give Lil' Doll the durability to carry 250 lbs. Lil' Doll easily maneuvers over electrical cords, scrapwood and other debris found at job sites.



Stable enough to work on material without removal from carriage



One man can do the work of two without tiring, wheeling material not lifting it.

SCHAEFER

MANUFACTURING
COMPANY

3022 West Scott Avenue, McHenry, Illinois 60050

THE THIRD HAND OF A PANELING MAN

Take all the guesswork out of aligning and marking corner panels with our kit of rugged aluminum off-set jigs and marking gauges.

Increase your speed and accuracy as you scribe perfect panels marked for a "pressed-in" fit. Panel-by-panel instructions included for inside and outside corners and for the location of cut-outs. Designed for plywood panels of 1/4" or less.



Patented U.S.A.

OFFSET JIGS FOR ROUTERS

A Cut-In-Place method of fitting inside corner panels. The router takes the place of the marking gauge or scribe and precisely cuts over 90% of an 8 ft. panel. Any router can be adapted to these jigs. Cut-In-Place kits are designed for plywood panels of 1/2" or less.

- Offset jigs and marking gauges. \$9.95 Postpaid.
- Cut-In-Place jigs for your router. \$6.95 Postpaid.

C.O.D. orders: you pay postage and charges. Satisfaction guaranteed or money refunded.

For rush orders please add 50¢
PANELING SPECIALTIES CO.
Three Lakes, Wisconsin 54562

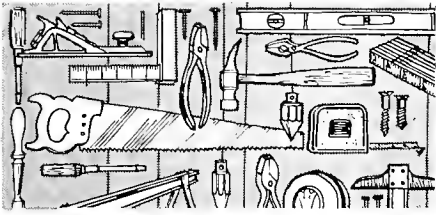

LOCAL UNION NEWS



Local leaders and guests at the recent Local 964 dinner-dance. From left, on the lower dias: Milton Frey, Frank McHale, Ralph Cannizarro, Domonic Popo, William Lawyer, Bill Johnson, and Rabbi Krantz. On the upper dias: Vice Pres. Thomas Sherwood, Jr., Fin Sec. Joseph Moreno, 2nd Gen'l. Vice Pres. Herbert Skinner, First Gen'l. Vice Pres. Wm. Sidell, GEB Member and Local President Patrick Campbell, Business Agent William Sopko, Conrad Olsen, GEB Member Wm. Konyha, Milan Marsh, Herman Bodowes, and Joseph Lia.

Local 964 Dedicates Building, Honors Vet. Members at Dance

Local 964 of New York City recently dedicated a new headquarters building, as the county American Legion post performed in opening ceremonies, as shown at right.

Below left: General Agent William Sopko, 25-Year-Member Emil Marinozzi, General Exec. Bd. Member Patrick Campbell, and 25-Year-Member Benjamin Ardire at the local's 10th annual dance.

Below right: General Agent Sopko presents a \$100 check to Howard Nikerson, honored for 25 years of service as local trustee and 51 years of Brotherhood membership. Mrs. Nikerson was presented red roses.

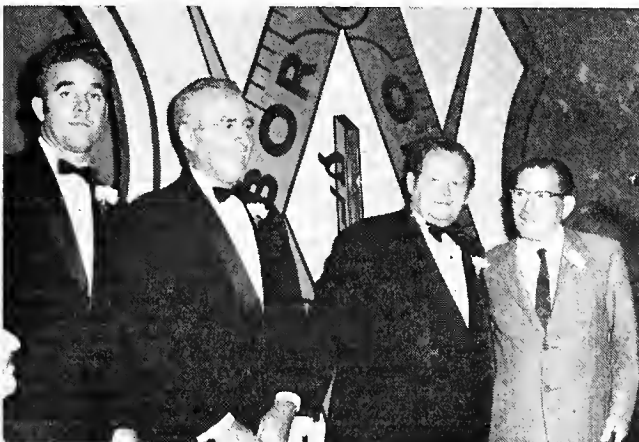

GIVE HIM THE RIGHT
TO BARE ARMS !!



HIRE THE
HANDICAPPED VETERAN

The President's Committee on Employment of the Handicapped - Washington, D.C. 20510

Be Better Informed!
Work Better! Earn More!
ORDER YOUR COPY
of
SIGMON'S
**'A FRAMING GUIDE
and STEEL SQUARE'**



- 312 Pages
- 229 Subjects
- Completely Indexed
- Handy Pocket Size
- Hard Leatherette Cover
- Useful Every Minute

Gold mine of understandable, authentic and practical information for all carpenters and building mechanics, that you can easily put to daily use. Dozens of tables on measures, weights, mortar, brick, concrete, cement, rafters, stairs, nails, steel

beams, tile, many others. Use of steel square, square root tables, solids, windows, frames. Every building component and part.

SATISFACTION GUARANTEED OR MONEY REFUNDED

ORDER TODAY **\$4.00** Postpaid, or COD, you pay charges.

CLINE-SIGMON, Publishers

Department 1071

P. O. Box 367 Hickory, N. C. 28601

An Hawaiian Tribute to Vice President



Leaders of Local 745, Honolulu, Hawaii, recently paid tribute to First General Vice President William Sidell, in recognition of his efforts on behalf of the local union's apprenticeship training program. Vice President Sidell was presented a lifesize replica of a hard hat, created from the state's monkey-pod wood, during the recent International Carpenters Apprenticeship Contest in Detroit, Mich. Shown with Vice President Sidell, center, are Harry Fukuyama, Carl H. Levey, Masayuki Yamamoto, and Stanley Ito.

Body Is Moved In Labor Dispute

In the course of a labor dispute between the Tulsa-Whisenhunt Funeral Homes in Tulsa, Okla., and Local 245 of the Service Employees International Union, the body of a longtime Tulsa Teamsters Union figure was taken from its casket at one of the Tulsa-Whisenhunt homes and placed in that of another funeral home. The body of Enos E. Boyd, retired Teamsters business agent and editor of the Tulsa *Labor News*, was transferred to Moore Memory Chapel after Mr. Boyd's widow learned that Tulsa-Whisenhunt's three locations were being picketed.

"I went over there," said the president of Local 245, John B. Irby, "and took him out of the casket. I took him to Moore's and put him in a casket there." Irby's union has contracts with the Moore and the Tulsa-Whisenhunt funeral homes, and represents embalmers, drivers, and funeral directors. The day before the removal of Mr. Boyd's body, four Tulsa-Whisenhunt employees were fired. Irby contends that the dismissals were in violation of the seniority articles which were included in contracts signed last November.

Irby said that the union's attorney, Woodrow Pendergrass, III, would be given information about the dispute in order to prepare a complaint for filing with the National Labor Relations Board. However, he emphasized that they were "definitely not on strike."

A spokesman for the funeral home operations contended that the management has neither refused to meet with the union nor violated its contract. "It's a misunderstanding all the way around," he stated.

Mrs. Boyd said that she approved the

transfer of her husband's body after learning of the dispute from Irby and a group of Teamsters agents. "I found out another union was picketing," she said. "I practically had to do it under the circumstances."

Local 1246 Retirees Receive Checks

Members of Local 1246, Marmette, Wis., recently received their first pension checks from the Wisconsin State Carpenters Pension Fund. Receiving checks were Otto Carlson, Harry Carlson, Louis Modsen, and Clarence Carlson, Hjalmer Hall, Arthur Carlson (now deceased), Ernest Erdman, Dominic Abietto, and Joseph Muchynski. Otto Carlson is now the only living charter member of Local 1246. (Editor's Note: We were unable to use the picture submitted.)

Largest Emblem?



What may be the largest Brotherhood emblem ever created is now displayed in the Carpenters Hall in Tucson, Arizona. Shown with the emblem is Local Financial Secretary Oscar C. Truex.

APPRENTICESHIP & TRAINING



New Journeymen in Seattle Honored

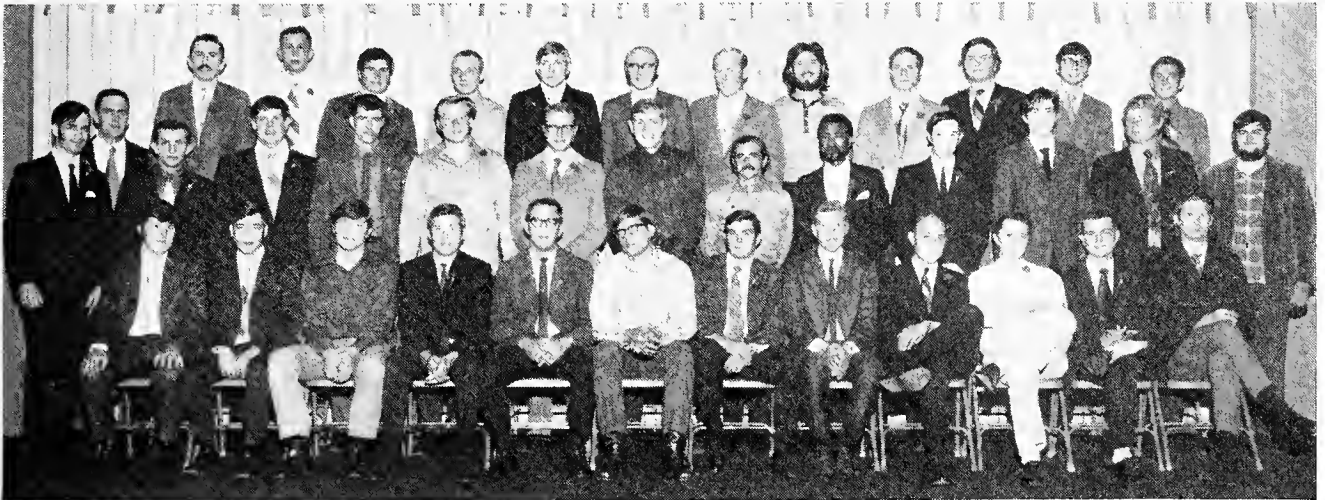

The King County Carpenters Joint Apprenticeship and Training Trust in Seattle, Washington, recently honored its graduating apprentices. Graduating were Dennis Anderson, James Bannister, Gary Barstow, Donald Beazley, Randy Biller, Max Bloomquist, George Bucholtz, Richard Buffon, Donnie Bunch, James Clark, Thomas Colvin, Norman Courtney, Paul Edminister, John Frederick, Gordon Gallagher, Leroy Goodfellow, James Grantham, Robert Hayes, Donald Helseth, Clifford Johns, Thomas Johnson, Jerry Kelvin, Dwane Kilgore, Melvin Kratz, Albert Leese, William Lessley, Donald Lindbo, Roger Lochridge, Blaine Lynch, Conrad Olsen, Robert Paasch, David Pollock, Gerald Porter, James Portman, Lynn Reynolds, Joseph Rice, Kenneth Robitaille, Warren Rosand, Stephen St. Clair, Ronald Scott, Robert Simmons, Michael Sparks, Glenn Stroup, Gary Uphaus, Charles Vetter, Edward Willis, Lynn Andrew, Brian Champion, Stephen Chaussee, Eugene Chose, Gerald Connor, Wayne Dodgson, David Green, Mike Rados, Lowell Jacobson, and Gary Golden.



Also honored at the ceremonies in Seattle, Wash., was Olav Boen who was awarded a Certificate of Meritorious Service. He is shown here with members of the King County JAC.

Future Carpenter?

Michael Valentine Amorin, son of Mr. and Mrs. Michael Amorin of East Meadow, N.Y., appears to have some definite ideas about what career he is ultimately going to select. Mike received his new outfit from, and has obviously been greatly influenced by, his grandfather Valentine Dietz, a long-time member of Local 1921, Hempstead, N.Y. If Mr. Dietz and his grandson continue to see things eye-to-eye, Mike may indeed be a "carpenter of the future"—year 1985.



Apprentice Graduation, Central New Jersey



The Central N.J. District Council of Carpenters recently conducted its 1970-71 apprentice graduation with a dinner and dance at the Arbor Inn in Piscataway, N.J. Among the participants were, left to right: First row—Harry Rushton, Arthur Jensen, Robert Lyons, Committee Member Maurice Cash, and Edward Riordan; Second row—David Orr, Leo Durko, William Moore, Gen. Rep. Ohlwieler, Coordinator D'Aries, Lawrence Puerschner, Paul G. Kusic, Michael Bialek and Joseph Sacco. Third row—John Brennan, U.S. Dept. of Labor, Ferdinand Prehn, Richard Kubian, David Briggs, John Bray, Ralph Kovach, William Courter, Kenneth Kennedy, David Zamaro, Leonard Pennucci, Gregory McCleary, and Chairman Peckham. Fourth row—Co-Chairman Nusbaum, Andrew Karabinchak, Thomas Jacobs, Frank Meehan, Dennis Lonergan, Frank Bars, Frank King and Mr. McDermott both of the U.S. Dept. of Labor, and Committee Member Grobleski. Fifth row—Lewis E. Miciak, Frank Nigro, Harry Bridgeman, Frank Carlomagno, Richard Hoffman, Stanley Macioch, Charles Cullinan, Stephen Laskowski, Michael Polsky, Walter Kwiatek, and Committee Members Zahayda and Szyrwiel.

Contractors, Carpenters, Custom Filers . . . Save Time, Save Money with *FAMOUS* FOLEY Sharpening Equipment

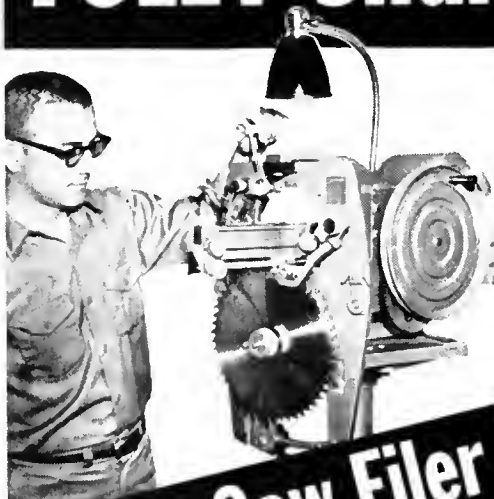

Foley Saw Filer
Sharpens crosscut circular saws, combination (rip and crosscut) circular saws, band saws and hand saws! Exclusive Foley principle of jointing the saw as it is filed keeps all teeth uniform in size, shape and spacing; keeps circular saws perfectly round, usually doubles saw life. In use today all over America.

SEND FOR FREE LITERATURE TODAY!

Foley automatic sharpening equipment has the skill to do a perfect job every time—NO "human error". And no experience is necessary to accomplish a professional job. All Foley equipment is quality built to precision specifications.

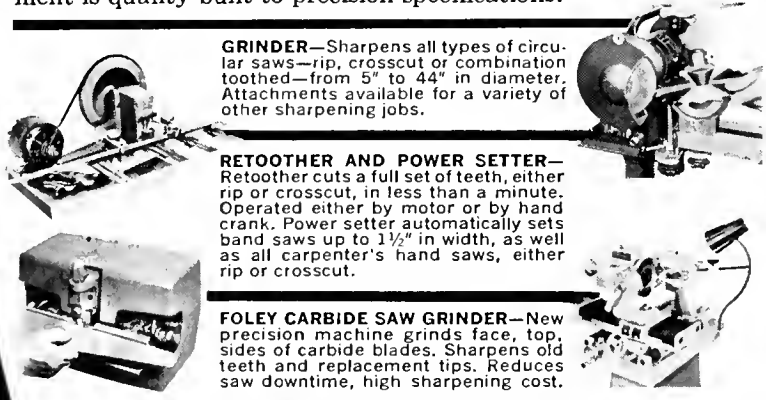

GRINDER—Sharpens all types of circular saws—rip, crosscut or combination toothed—from 5" to 44" in diameter. Attachments available for a variety of other sharpening jobs.

RETOOTER AND POWER SETTER—Retooter cuts a full set of teeth, either rip or crosscut, in less than a minute. Operated either by motor or by hand crank. Power setter automatically sets band saws up to 1 1/2" in width, as well as all carpenter's hand saws, either rip or crosscut.

FOLEY CARBIDE SAW GRINDER—New precision machine grinds face, top, sides of carbide blades. Sharpens old teeth and replacement tips. Reduces saw downtime, high sharpening cost.

FOLEY MANUFACTURING COMPANY

1081-I Foley Bldg. • Minneapolis, Minnesota 55418

Please send me FREE booklets checked below:

- "Money Making Facts" Automatic Saw Filer Automatic Grinder
 Carbide Saw Grinder Automatic Retooter Automatic Power Setter

Name _____
Address _____
City _____ State _____ Zip _____

Training in Russellville, Arkansas



The Russellville, Ark., Joint Apprenticeship and Training Committee—a joint operation of Local 1836 and local contractors—recently sponsored an MDTA pre-apprenticeship class. Most of the trainees are moving into regular apprenticeship training. Completing the first phase of a four-year course are these young men of Russellville area, from left: front row, Larry Tipton, Joe Simpson, Mike Sights, Gary Pettit, Tim Ulery and Donny Helm. Middle, Jerry Workman, Leonard Bowen, Mike Foster and Larry Rodgers. Back, Dean Freeman, Romy Barter, Thomas Freeman, and David Staggs. At right rear is W. H. Brady, project coordinator. Next to him is Bobby Keeling, pre-apprentice course instructor. (Russellville Courier-Democrat Photo)

Madison County, Illinois, Graduates

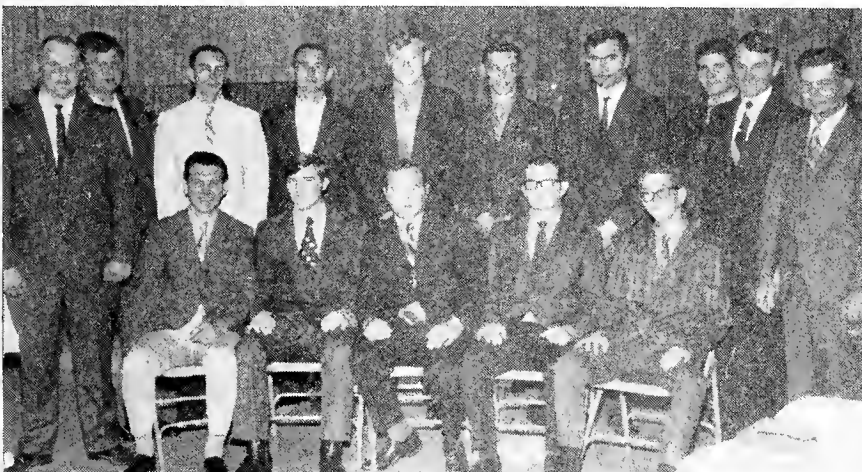

Here are recent apprentice graduates of the Carpenters District Council of Madison County and Vicinity, Illinois. They were honored at a banquet May 4. Left to right, standing: Cleo Kruckeberg, Local 633; Jackie Thomas, Local 633; R. Jack Rogers, Local 633; Howard Acord, Local 1808; James Zeller, Local 1535; Thomas Thorp, Local 1808; Orville Rinderer, Local 1535; George Wolfe, Local 633; Roger Czaja, Local 377; and Program Coordinator E. L. Rule. Seated: David Beckemeyer, Local 295; Thomas Eversmann, Local 295; Larry Reynolds, Local 295; Gerald Ketten, Local 990; and Larry Brooks, Local 633.

75 New Journeymen, Miami District Council

At the Tenth Annual Completion Banquet of the United Joint Apprenticeship Committee of Miami, Fla., 75 carpenter apprentices received their completion certificates.

The banquet was held at the fabulous Dupont Plaza Hotel, overlooking Bis-

cayne Bay. There were over 600 people in attendance.

In addition to the certificates, James Bouchard was presented the "Arthur E. Stewart" Memorial Trophy as the "Apprentice of the Year." James also won the state contest.

START A MONEY-MAKING BUSINESS FOR LESS THAN \$50!

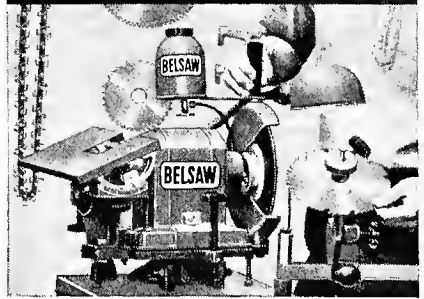

You can have your own lifetime business right at home...work in spare time... and make up to \$200 a month CASH! My FREE PLAN gives you all the facts: How to start, how to grow. You don't need previous experience. You don't have to sell. I'll even finance you. People bring you the work and pay cash. Over 90¢ of every dollar you collect is clear cash profit. And you work when you want to. Let me prove you can't find a more certain, lower cost, higher paying business of your own.

Just Mail Coupon—No Salesman Will Call

BELSAW SHARP-ALL CO.
Stan Field, President
7327 Field Bldg., Kansas City, Mo. 64111

FREE BOOK

Name _____
Address _____
City _____ State _____ Zip _____

LAYOUT LEVEL



- ACCURATE TO 1/32"
- REACHES 100 FT.
- ONE-MAN OPERATION

Save Time, Money, do a Better Job With This Modern Water Level

In just a few minutes you accurately set batters for slabs and footings, lay out inside floors, ceilings, forms, fixtures, and check foundations for remodeling.

HYDROLEVEL is the old reliable water level with modern features. Toolbox size. Durable 7" container with exclusive reservoir, keeps level filled and ready. 50 ft. clear tough 3/10" tube gives you 100 ft. of leveling in each set-up, with 1/32" accuracy and fast one-man operation—outside, inside, around corners, over obstructions. Anywhere you can climb or crawl!

Why waste money on delicate instruments, or lose time and accuracy on makeshift leveling? Since 1950 thousands of carpenters, builders, inside trades, etc. have found that HYDROLEVEL pays for itself quickly.

Clip this ad to your business stationery and mail today. We will rush you a Hydrolevel with complete instructions and bill you for only \$7.95 plus postage. Or send check or money order and we pay the postage. Satisfaction guaranteed or money back.

Ask your tool dealer to order it for you. We allow the usual dealer discount on 1/4 Doz. lots and give return-mail service.

HYDROLEVEL

925 DeSoto, Ocean Springs, Miss. 39564

FIRST IN WATER LEVEL DESIGN SINCE 1950

SERVICE TO THE BROTHERHOOD



A gallery of pictures showing some of the senior members of the Brotherhood who recently received 25-year or 50-year service pins.



1

(1) GLEN COVE, N.Y.—Local 1093 celebrated its 69th anniversary on April 23, 1971, with 400 members and wives attending the ceremonies. The festivities included the presentation of 50-year pins to the following members: Seated, from left, are Leroy Seaman, John Donaldson, Michael Macedonio, Henry Olsen, Robert Donaldson, and William Peet. Seen standing, from left, are Harry Roslund, president of Local 1093; John Kasso, Elis Goranson, Walter Carruthers, Daniel Fresiello, George Basile, business representative, and John Edquist.

(2) Local 1093 also honored those members who have compiled 40 years of service. Presented with 40-year pins were, seated from left, George Basile, George Cunningham, Emanuel Thompsen; John Rosenstrom, who presented the awards; Joseph Minicozzi, and Malcolm Dorber. Standing, from left, are Arthur Velsor, Coraell Kasso, Donald Whyte, Ejner Mikkilsin, Duncan Whyte, and Salvatore Romano.

(3) Service pins were also awarded to 25-year members of Local 1093. Those members honored included, seated from



2

left, Kenneth Brady, William Standly, Edwin Swenson, Anthony Carbo, John Del Ferraro, Ernest Pascucci, Rudolph Anfiere, Alfred Nigro, Floyd Seaman, Balic Groblewski, Michael Carbo, Nicholas D'Alessio, and Anthony Gallo. Standing, from left, are Benjamin Rant, An-

thony Peirone, Joseph Stanco, Arnold Sanders, Harry Roslund, Iver Roslund, Angelo Silipo, Anthony Anfiere, George Nigro, John Pascucci, Angelo Simoneschi, Joseph Famiglietti, Runar Tast, William Kurka, and George Basile, business representative.



3

Disneyworld

Continued from Page 11

Another kind of accommodations for Walt Disney World guests will be provided at the nearby Fort Wilderness camping area. With over 230 campsites available, Fort Wilderness will provide its own shopping and recreational facilities. Individual campsites will have complete utilities. In addition, both hotel and camping rates will include unlimited use of the various kinds of transportation—monorail trains, surface vehicles, steamboats—which will link the vast recreation, sports, and entertainment facilities of the Vacation Kingdom.

Golfing on two 18-hole championship courses, horseback-riding, swimming along 4½ miles of beaches, sailing, motorboating, water skiing, tennis, steamboat excursions, picnicking, and many unique, organized activities will be among the many available recreational opportunities. In addition, top-name entertainers in lounges and nightclubs, parades, water-staged spectaculars, musicals and theatrical productions and holi-

day extravaganzas will be regular features both inside the theme park and at each of the theme resort hotels. In short, Walt Disney World's Vacation Kingdom has been designed so that guests may "play for a day" or stay for an entire vacation.

Actually, the newest and most exciting things about Walt Disney World will not be immediately apparent upon its opening in October. Starting from scratch, with local and state legislative support, the Disney operation has been able to obtain full and complete control of every acre of its Florida land. Legally, Disney World holds every government power to dictate with absolute authority the design, construction, and operation of its Florida empire, now and in the future. Indeed, it is with the future that Disney World is primarily concerned.

Walt Disney once stated that he did not believe that there is "a challenge anywhere in the world that's more important to people everywhere than finding solutions to the problems of our cities." He was convinced

that the need was not one of "curing the old ills of old cities." Rather, he believed that "the need is for starting from scratch on virgin land and building a community that will become a prototype for the future." Deep inside the 27,400-acre Disney property, his dream is slowly being realized. There, the Experimental Prototype Community of Tomorrow, or EPCOT as it is called, is gradually developing.

Walt Disney envisioned EPCOT as a living blueprint—a community which could put into practical use the newest innovations of American industry and technology. Many of the innovations in construction, communications, waste disposal, and utility services which are being incorporated into the Vacation Kingdom will provide an experience base for the future development of Disney's greatest dream. It is a dream which will require tremendous imagination and pioneering spirit in order to be fulfilled. It is also a dream in which carpenters will play an extremely important role. ■

THESE 3 BIG DRAFTING KITS* GIVEN TO YOU!

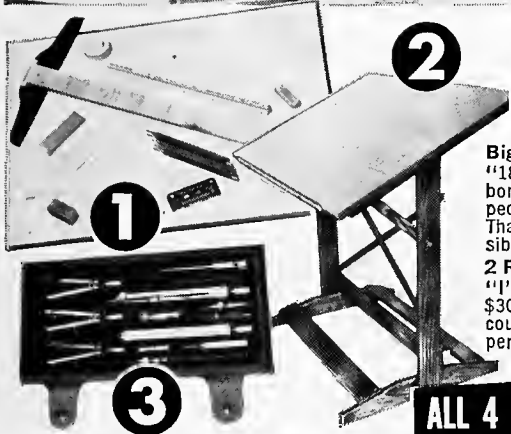

*Precision Drawing Instrument Set, Professional Drafting Board Outfit & Fingertip Tilting Drafting Table are given to you with your complete North American Course in Drafting.

... when you train at home with us for a **HIGH PAY JOB IN DRAFTING**

Big Promotion!

"18 months ago I was a laborer. Now I am foreman of 22 people in the Drafting Room. Thanks for making this possible." S. D., Mass.
2 Raises and \$300 Bonus!
 "I've had 2 boosts in salary and a \$300 bonus in 11 months. Wish I could shake hands with your staff in person." A. C., Calif.



RUSH COUPON FOR FREE KIT...

Mail coupon today for FREE "DRAFTING CAREER KIT," Sample Lesson, Drafting Aptitude Test including intriguing new 5-Way Drafting Instrument & 20-page Book "Your Future in Drafting!"—jam-packed with revealing facts on your opportunities to win top pay and job security in Drafting. No salesman will call. Everything sent FREE and WITHOUT OBLIGATION. Write today!

North American School of Drafting, Dept. 1146A
 4500 Campus Dr., Newport Beach, CA 92663

Rush "DRAFTING CAREER KIT" — ALL FREE!

Name _____ Age _____

Address _____

City _____ State _____ Zip _____

A home-study program in association with Cleveland Engineering Inst.

ALL 4 FREE!
 Rush Coupon today!

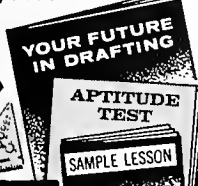



DOOR-CUTTING GUIDE

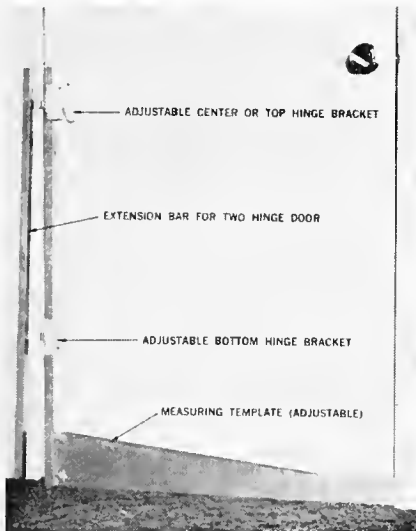

A time-saving, no-guessing "door-cutting guide" that will measure exact cutting of most types of doors; hinged, swinging, sliding, folding, etc. Doors may be cut to exact measurements before or after carpets are installed. The adjustable template swung over the floor or carpets adjusts to clear high points of the carpets caused by floors out of level and frames out of plumb.

With the door removed, slide the hinge brackets of the door guide so that they are aligned with the door frame hinges and insert hinge pins. With the guide in position on the door frame, swing guide out over carpet and make adjustments to clear carpet by releasing locking arm at top hinge bracket, raising or lowering guide as needed; then lock arm of top bracket. Further adjustments can be made on the bottom template for out-of-plumb door frames.

After adjustments have been made, remove door guide from door-frame and transfer measurements by placing guide on top of door, marking and cutting door resting on saw horses.

The door guide will also show the exact thickness of any filler needed to raise existing wooden or metal threshold for outside doors.

For more information, write to John E. Berquist, P. O. Box 4632, Santa Barbara, California 93103.

ONE-PIECE, METAL, MARKING TEMPLATE FOR SAWHORSES

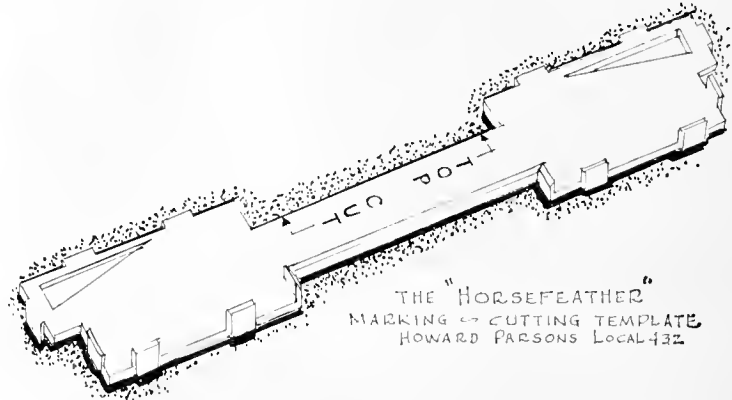

It sometimes takes an experienced journeyman as much as two hours to turn out a proper pair of sawhorses.

Howard Parsons, Jr., of Local 432, Atlantic City, N.J., had been in construction work for 32 years, and he totaled many hours in this kind of work . . . and he got tired of it.

So he developed a master template to simplify the job. He has patented it and is looking around for a manufacturer interested in mass-producing it.

His patent, shown in the illustration, is a one-piece metal, marking template which makes all necessary layouts and initial chisel cuts for the angular mortises.

While the carpenter's sawhorse is a

comparatively simple construction item, it is not so easily built with good results, due to the angularity of the legs, which must have the correct spread in two directions. To lay out these angular mortises, eight of which are required for a pair of horses, is time consuming.

Parson's template requires no measuring of any nature. It can be used for 4-inch or 6-inch stock lumber, regardless of thickness. The wedge-lock fit which Parsons has incorporated into the design accommodates itself to a variance in the width of the leg boards.

For further information, write: Howard Parsons, Jr.; 157 Old New York Road; Port Republic, N.J.

SHALLOW-DEPTH HOLE SAWS

Simonds Saw and Steel Division of Wallace-Murray Corporation is introducing new shallow-depth hole saws of novel design. The new saws are made of a patented body material which not only provides a high-hardness, high-speed edge but also possesses sufficient toughness below the tooth tips to withstand the shock and impact of breaking through thin-wall metal such as electrical boxes and for cutting holes in auto body and trailer panels, boats and aircraft and for installing air conditioning and ventilating ducts, etc.

Due to the shallow depth feature ($\frac{1}{2}$ " cutting depth) the new Simonds saws run truer and are easier to handle with hand held drills than regular depth saws. In solid materials, holes can be sawed in up to 1" thickness by sawing $\frac{1}{2}$ " in from each side. Pilot drill will assure proper line-up of saw cut holes.

In addition to providing a shallow depth saw for sawing thinner materials, Simonds arbors are equipped with drills which have points especially ground for each penetration of sheet metal. This prevents walking of the point and requires only low pressure to start cuts, therefore there is no need to push hard and ram the saw into the work when the drill breaks through.



The new Simonds Shallow Depth Hole Saws are made in 12 sizes covering a range from $\frac{1}{16}$ " to 3" dia., thus providing all the diameters needed to make holes for pipe taps and pipe or conduit entrance holes through $2\frac{1}{2}$ " pipe.

The new Shallow Depth Hole Saws are available now from your Simonds Industrial Supply Distributor.

PLEASE NOTE: A report on new products and processes on this page in no way constitutes an endorsement or recommendation. All performance claims are based on statements by the manufacturer.

SERVICE TO THE BROTHERHOOD



A gallery of pictures showing some of the senior members of the Brotherhood who recently received 25-year or 50-year service pins.

(1) STATE COLLEGE, PA.—On April 3, 1971, Local 1333 of State College, celebrated its 45th anniversary.

At the time, 25-year pins were presented to members of Local 1333 and members of sister Local 2329 of Lock Haven, Pa. Shown at the presentation are:

Front, left to right: John P. Adams, Local 1333; Ferd Miller, 2329; Charles Spotts, 1333; and Joseph A. Senge, secretary-treasurer, Carpenter District Council of Western Pa., who made presentations. Second row, Robert Bowmaster, 2329;

George M. Walsh, President, Pa. State Council of Carpenters; and Warren Grimm, secretary-treasurer, Pa. State Council and general representative. Third row, Thomas Kustanbauer, 1333; Roland Kessler, 1333; Harry Schilling, 1333. Fourth row, John Smiley, 1333; George Wright, 1333; and Andy Zovko, president, Carpenters District Council of Western Pa. Fifth row, Harry Knepp, 2329; John Shively, 1333; Clair Moore, 1333; and Joseph Kozar, 1333.

Members not present include: Harold Benner; Arthur Hirsch; Eldon Ilgen; Joseph Kelley; John Loope; N. E. McClellan; Jacob Musick; Charles Poorman; Robert Sanker; and Earl Zettle, all of Local 1333.

(2) NEW CASTLE, PA.—Local 206 recently honored members entitled to 25-year pins at a dinner at The Castle Arms Motor Motel. Seated, left to right, George Nesbitt, 46 years; Gregory De Caprio, 28 years; Barney De Santis, 33 years; Martin Schlager, Sr., 33 years; and Mearle Brunton, 25 years. Standing, left to right, Clare Stitt, 25 years in June; Samuel Leonard, 28 years; J. W. Fullerton, 28 years; Millard Lund, 28 years; Einar Tuuri, 25 years; Kenneth Lutz, 28 years; William Kelley, 25 years; Eugene Arnold, 25 years; and Patric Cosgrove, 25 years.

Two members who could not attend due to illness were Grover Abel, 67 years, and George McCormick, 29 years.

1

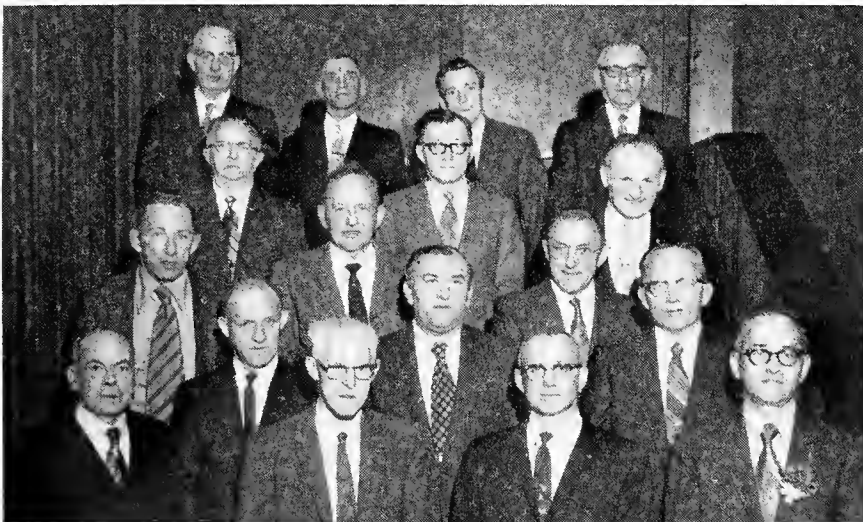

2



AUDEL CARPENTERS & BUILDERS LIBRARY

4 vols.
\$18.50

THESE "PAPER TOOLS" can boost your income!

Their 1,488 pages of practical information and how-to guidance are invaluable "tools" for all in the building trades . . . a complete course for the apprentice, a ready reference for master workers.

Thousands of photos, diagrams and charts tell and show short cuts, new methods, solutions and money-saving ideas . . . how to use every tool and building aid . . . how to build everything from furniture to houses . . . how to frame, roof, excavate, do carpenter arithmetic, estimate costs, trim, insulate, care for tools, etc. They can help you earn more, fast.

MONEY BACK GUARANTEE—You must be completely satisfied with the Audel Guides you order, or you may return them within 10 days and get your money back.

SEND COUPON TODAY

Theodore Audel & Co., 4300 West 62nd St. C-101
Indianapolis, Indiana 46268

Please mail me Carpenters and Builders Library, 4 vols. I agree to mail \$3 in 10 days and to mail 1/2 the total purchase price 30 days later, with the balance plus shipping costs to be mailed within another 30 days. If I am not completely satisfied I may return the books for refund.

Name _____

Address _____

City _____ State _____ Zip _____

Save shipping costs. Enclose \$18.50 (plus sales tax, if any) and we pay postage.

MAKE \$20 to \$30 EXTRA
on each
STAIRCASE



ELIASON

STAIR GAUGE

Saves its cost in ONE day—does a better job in half time. Each end of Eliason Stair Gauge slides, pivots and locks at exact length and angle for perfect fit on stair treads, risers, closet shelves, etc. Lasts a lifetime.

Postpaid if payment sent with order, or C.O.D. plus postage Only **\$19.95**

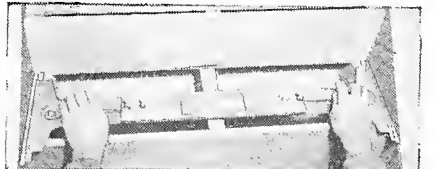

ELIASON STAIR GAUGE CO.

6005 Arbour Lane
Minneapolis, Minn. 55436



Outdoor Meanderings

Readers may write to
Fred Goetz
 2833 S. E. 33rd Place,
 Portland, Oregon 97202

■ Catfish Records

Recent column item about a 22½-lb. catfish prompts note calling attention to another catch by E. L. Childs of Marshall, Tex., a member of Local 776. We're informed that Brother Childs nipped a 45-lb. catfish from the Lake of the Pines this past April and we adjust "column catfish records" accordingly.

■ Drop Him a Line

Open letter to Carpenter Clyde M. Baker about whom we ran a column item regarding his outstanding catch of catfish: Your friend and fellow Carpenter, Norman Winchell of 724 10th Ave. S., Issaquah, Washington 98027, a retired member of Local 1797 in Renton who worked with you on the Priest Rapids Dam, is anxious to get in touch with you and asks that you write to him at the above address.

■ Mississippi Catfish

Before getting off the subject of catfish angling, the following note from W. R. Buchanan of Bay Springs, Mississippi, a member of Local 205 at Laurel, Mississippi.

"Thought fellow members and catfish anglers might like to know that we get some pretty good fish down here in Mississippi. Enclosed is a news clip (Sorry, Brother Buchanan, we can't reproduce) depicting my son and me with a 25 pounder from a stream near home. We get much larger ones than this on occasion. Actually, this is referred to as a tabby."

■ Choice of Rods

In most instances, it's impractical to pack two rods when you're tramping your favorite trout stream. When limited to one, I take my spinning outfit; with it you can also fish flies, providing you augment your cast with weight. I use the following setup for wet fly fishing, namely a wingless nymph with a pair of the smallest split shot attached to the leaders, said shot positioned from 18 to 24 inches from the fly. A like setup can also be used with a spin rig for dry fly fishing if a clear, plastic bubble, sold at most sporting goods stores, is used. These

spheres, less than an inch in diameter, have a little trap door for injecting water which provides the necessary weight for casting. Take along an eye dropper for injecting the water into the bubble.

■ Second Try

It's not very often that one can catch the lunker that got away but Kerry Magolis, son of J. Eric Magolis, Front Royal, Virginia, a member of Local 2033, did just that while fishing in the South Fork of the Shenandoah River.

Kerry hooked a chunky largemouth bass on a fast retrieve with a Mepps spinner. After rolling to the surface, the fish darted swiftly to the bottom and broke the line in the process. Undaunted, Kerry began to fish again, tying on another spinner. As he stood knee deep, out from the bank, ready to follow through after his back cast, the hooked bass broke the river's surface, close enough for Kerry to grab the line and ease the fish ashore!

Top that.

■ Texas Report

Before getting off the subject of largemouth bass, we're bound to pass on the following photograph sent in by Donald Tolbert, Business Representative of Local 753, Beaumont, Texas. It depicts fellow Local member Harmon Perryman with a nice 7½ pounder he eased from Village Creek, not more than a few miles from the Union Hall.



Perryman and Bass

■ Yellowtail Prizes

Louise McDougall, wife of Donald A. McDougall of Cardiff-by-the-Sea, Cali-



Henry Moser and Halibut



Louise McDougall and Yellowtail

fornia, a member of San Diego's Local 1296, is a chip off the old piscatorial block. Both Mrs. McDougall and her husband are ardent anglers and so was Lousie's dad, Henry Moser of Santa Monica, California, deceased, a long-time member of Carpenters' Utica, New York Local.

Mrs. McDougall missed by a sardine winning first prize in the California Yellowtail Derby some years ago. But she did win second prize, a \$1,200 camping trailer. The first prize winner nabbed the last sardine out of the bait tank, secured it to hook and nabbed the winning fish—right under Louise's nose.

Here's a photograph of her father Henry Moser with a 125-lb. halibut he caught while fishing off the pier at Ocean Park, Santa Monica, California, the largest ever taken from off the pier on rod and reel, and a photograph of Mrs. McDougall with her prize winning 27-lb., 5-oz. yellowtail.

Last we heard, Don was pressing Louise for a family record on yellowtail as he recently racked up a 26-lb., 4-oz. specimen.

Retiree's Great Catch



Burgbacher

Many members of Chicago Local 1367 will remember long time member of the Carpenters' Union, William Burgbacher, I'm sure. Be it known that Brother Burgbacher, retired recently from the workaday world and enjoying his 78th birthday, racked up a nice catch—a 16-

lb. northern from Camp Lake at Lakewood, Wisconsin, which measured forty inches from nose to tail. (We're indebted to William Binning of Chicago, also a member of Local 1367, for the following photo of Brother Burgbacher and his catch.)

Parts of the Game

Many of my hunt friends look forward the year around to the opening of the deer season. There's more to it than the "kill." Most deer hunters will tell you it's just part of the game. Much of the joy and lore is in the anticipation of it all; talking over prospects with fellow hunters, cleaning the rifle or shot-



Borne

gun; readying camp gear; discussing possible areas where a prize trophy might prevail; it's a twelve-month hope which, for the true hunter, never dies, year after year. Ofttimes the shooting ends as quickly as it begins and such has been the case for two years for Brother Carpenter Henry Borne of Murphysboro, Ill., a longtime member of Local 604. Usually he waits 'til the third day of the hunt, when the smoke has cleared a bit. In 1969, he downed an 8-point buck which field dressed at 161 pounds, 35 minutes after he left home and this past year, 1970, he nailed an 8-pointer which dressed at 178 pounds, 45 minutes after he left home.

Here's a photograph of Brother Borne with one of those big Illinois whitetails.

Duo Lure Salmon

Recent word from John. D. Panici of Orchard Lake, Michigan, a member of Detroit Local 337 recalls an outstanding junket to Lake Michigan, a productive day when he and partner Les Reitz caught a limit of Chinook, ranging from 34 to 41½ pounds. "It took Les almost an hour to land the big one," said Panici and it wound up as the second largest Chinook ever taken by a Michigan angler.

All salmon were taken on a lure that Panici has fashioned himself and patented, called the "Genus" lure.

NEW, TOUGH AND DESIGNED

ROLLED EDGES FOR MAXIMUM STRENGTH AND SAFETY

EXTRA HEAVY-DUTY LID LIP — PORTS WORK WITH ONE HAND

SLIDING TRAY WITH MOVEABLE PARTITIONS

FLANG HINGES HIDDEN FROM WEATHER & TAMPERING

OVERLAPPING EDGES AND RAIN GUTTER TO KEEP OUT WEATHER

END COMPARTMENT FOR SMALL HAND TOOLS AND MATERIALS

\$125.00-\$160.00



WEATHERGUARD CROSS BOXES

• Four sizes—9 cu. ft. to 18 cu. ft.—answer every need for on-truck storage and protection of tools, equipment and material. Can be used alone or in combinations with side boxes.

MODELS UP TO 18 CU. FT. CAPACITY

weather guard®

Weatherguard has been designed with tough 16 ga. steel rolled edges and ribbed sides and bottom to produce a rugged chest that keeps out weather—and pilferers. Easy to install, Weatherguard is by far the best pick-up truck chest for the money available today.



\$175.00-\$205.00 Pair

WEATHERGUARD SIDE BOXES • Big capacity, tough design. Use alone or in combination with cross boxes. Two models.

OVERHEAD RACK • Transportation of ladders and extra-long material is an easy assignment with the Weatherguard overhead rack. Pre-drilled for easy assembly to truck bed.

\$145.00



Direct access from either side



Easy install

100% rear and side visibility



Loading space between chest and truck bed

Use in combination



Stake holes remain clear

KNAACK® MANUFACTURING COMPANY
420 E. Terra Cotta Ave., Crystal Lake, Ill. 60014
815/459-6020

WRITE FOR FREE 1971 WEATHERGUARD CATALOG. Also available on request is Knaack 1971 catalog. Wholesale inquiries invited. Prices above are F.O.B.

KNAACK

New Improved
Estwing
HAMMERS

Last Longer
 Than All Others!



"Mark of
 the
 Skilled"

New Safe-T-Shape Grip

- Unsurpassed, Estwing Temper, Balance and Finish
- Forged One-Piece Solid Steel
- Strongest Construction Known

plus

- Exclusive Nylon-Vinyl Deep Cushion Grip (not rubber)
- Molded Permanently to Steel Shank
- Won't Loosen, Come Off or Wear Out
- Easiest on the Hands

Estwing MFG. CO.

Dept. C-10 Rockford, Ill.

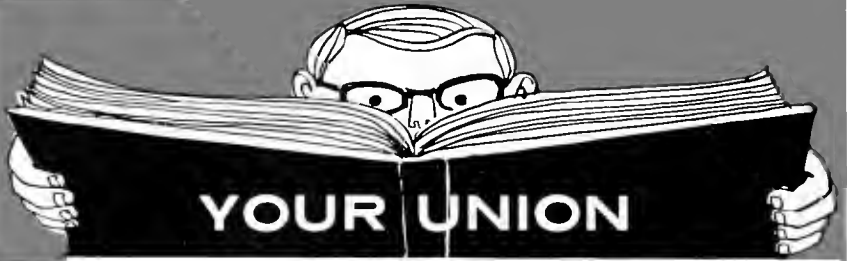

**YOUR UNION
 DICTIONARY**

This is the 6th of a new feature series planned to keep you better informed on the meaning of terms related to collective bargaining, union contracts, and union business. Follow it closely, and your union membership will become more meaningful, and your ability to participate in decisions which affect your future and security will be strengthened. It was compiled by the International Labor Press Assn, and is used with permission.

D

- day work:** Work for which pay is figured by the day, as opposed to piece work.
- dead time:** Time lost by worker for lack of materials, machine breakdown or other causes beyond his control.
- decertification:** An order by the NLRB ending the representation rights of a union if the workers, in an NLRB election, so vote.
- defense fund:** Another term for a union's strike fund.
- deferred wage increase:** A future increase specified in a union contract, e.g., 5 cents the second year, 3 cents the third.
- direct affiliation:** The status of a local union which holds its charter from the AFL-CIO rather than from a national or international union.
- disaffiliation:** Separation by a local union from its international (usually by membership vote), or by an international from the federation.
- disciplinary layoff:** Suspension because of violation of company rules.
- discrimination:** Distinctions based on race, religion, sex, national origin or other factors, unrelated to job performance, and applied to hiring, promotions, wages.
- discriminatory discharge:** Firing of an employee for union activity. An unfair labor practice under Taft-Hartley.
- dismissal pay:** A payment in addition to regular wages to an employee who has been dismissed; severance pay; termination pay. Usually based on both wage rate and length of service, and frequently with the option of lump sum or deferred-plan payments. In some contracts dismissal pay is due on resignation as well.
- disposable income:** Net take-home pay after deductions for taxes, social security, union dues and the like.
- district director:** See regional director.
- docking:** Pay deduction for breakage, poor work, absenteeism, etc.
- double time:** Twice the regular rate of pay for overtime, Sunday work or holiday work.
- downgrading:** Reassignment to job with lower rate. Sometimes job itself is downgraded, with resulting cut in pay.
- downtime:** A period during which a worker is idled because a machine breaks down or the flow of materials is interrupted. In contracts providing incentive pay, provision is made to compensate such workers for such time, under a stated formula.



IN MEMORIAM

**L.U. NO. 1
CHICAGO, ILL.**

Dixon, William
Gomsky, Edmund
Hoffman, Axel
Lilly, Earl M.
Pederson, Hans P.
Schreiber, Fred, C.
Sittig, Rudolph
Wolff, Harry H.
Zanger, Richard

**L.U. No. 4
DAVENPORT, IOWA**

Warnstradt, Kenneth

**L.U. NO. 5
ST. LOUIS, MO.**

Bayer, John
Bischoff, Fritz
Carroll, Clifford E.
Gibson, William
Holden, Grover
Oswald, Leonard
Schiller, George M.
Schroeder, Joseph L.
Susek, John F.
Toebben, John G.

**L.U. NO. 7
MINNEAPOLIS, MINN.**

Anderson, Herbert M.
Arnstrom, John
Aurness, Olaf
Bachleitner, Stanley
Bacon, Archie
Barnett, John G.
Berg, William
Berglund, Gordon
Bjur, Palmer
Bligard, Olaf
Buttweiler, John
Carlson, Carl G.
Clift, Douglas
Cossins, James
Cottrell, C. L.
Edholm, Claus
Ellefson, Andrew
Elmblad, John A.
Engel, L. W.
Erickson, Werner
Fahlgren, Fritz
Gavic, Harold
Grimm, F. M.
Gustner, Charles
Hansen, John R.
Hanson, Olaf S.
Heilmer, Anton
Hoffstrom, William
Holmberg, Oscar
Honeck, LeRoy
Hoyer, John
Johnson, A. D.
Johnson, Albert
Johnson, John A.
Jones, John
Kallestad, Torkel
Kiehn, Herman
Koch, Ernest
Kumbits, Oskar
Lane, Fred T.
Larson, Evdorus
Larson, Louis
Leonard, Roy
Lind, Rudolph
Maerklein, Robert
Mills, Walter
Moonen, George

Nelson, Martin
Nelson, P. O.
Olson, Torkel
Oman, Marcel
Palmer, Raymond
Paulson, Paul
Pederson, Peder N.
Peterson, Raymond
Peterson, Sam
Reckmo, John
Rusten, Iver
Sanders, Bert
Snabb, Clarence
Stone, Hans
Tjosvold, Carl
Treakle, Jess
Turnwall, Stanley
VanHeel, Leander
Waby, Vernon
Walgren, Fritz
Wallin, Walter
Westmark, Conrad
Young, Earl

**L.U. NO. 12
SYRACUSE, N. Y.**

Brown, Frank E.
Corruccio, Ciro

**L.U. NO. 20
NEW YORK, N. Y.**

Cocozza, Michael
Finnegan, Jerry
Gaudet, Patrick
Grecsek, Gus
Hemmingstad, Carl
Johnsen, Adolf
Nelson, John
Nesvold, Herbert
Pearson, Sigfrid Sr.
Terjesen, Alf
Vreeland, James

**L.U. NO. 35
SAN RAFAEL, CAL.**

Sahlin, Alex E.

**L.U. NO. 36
OAKLAND, CAL.**

Carlsen, Carl J.
Cox, Frank
Grisso, Paul A.
Jack, W. F.
Johansen, Odin
McCrea, A. A.

**L.U. NO. 51
BOSTON, MASS.**

Dmiterko, Simeon

**L.U. NO. 54
CHICAGO, ILL.**

Voslar, Joseph

**L.U. NO. 89
MOBILE, ALA.**

Baggett, Robert J., Sr.

**L.U. NO. 94
PROVIDENCE, R.I.**

Baillie, Donald S.
Borges, Joseph
Burdick, N. Edward
Houle, Joseph
Martin, Leroy
Pearson, Albert S.
Pearson, Charles
Rose, John

**L.U. NO. 101
BALTIMORE, MD.**

DeSombre, Milton C. R.
Dulaney, Gilbert
Greenwalt, John J.
Schratke, Harry A.
Schultz, Charles L.

**L.U. NO. 109
SHEFFIELD, ALA.**

Walker, W. P.

**L.U. NO. 129
HAZLETON, PA.**

Mausser, David

**L.U. NO. 133
TERRE HAUTE, IND.**

Clossin, Harry L.
Smith, Ralph

**L.U. NO. 141
CHICAGO, ILL.**

Benson, Roy T.
Bokowski, Stanley
Bonnevier, C. L.
Hagenauer, Michael
Heigl, Frank
Johnson, Carl J.
Landers, Ralph
Long, Steve
Pearson, Gus
O'Reilly, Jack

**L.U. NO. 171
YOUNGSTOWN, OHIO**

D'Urso, Andrew F.

**L.U. NO. 181
CHICAGO, ILL.**

Anderson, Albin
Borg, Ray
Pearson, Amandus

**L.U. NO. 188
YONKERS, N. Y.**

Blomquist, Karl A.
Chesney, John G.

**L.U. NO. 200
COLUMBUS, OHIO**

Cook, John J.

**L.U. NO. 213
HOUSTON, TEX.**

Forcier, Ralph
Harrison, Norman
Nall, Herman W.
Riley, L.R.

**L.U. NO. 226
PORTLAND, ORE.**

Cernyar, Godfrey
Eilers, Gerhard
Harnett, Joe
Jensen, Alvin S.
Klingenberg, William G.
Posedel, Michael
Wirkkala, Eino A.

**L.U. NO. 242
CHICAGO, ILL.**

Ginder, Alex
Wielgosz, Bruno

**L.U. NO. 246
NEW YORK, N. Y.**

Piterman, Yehoshua

**L.U. NO. 264
MILWAUKEE, WISC.**

Johnson, Nels
Kuge, Albert
McFarlane, Henry
Otto, Alvin
Porte, John
Ruper, Louis

**L.U. NO. 283
AUGUSTA, GA.**

Ghann, L. F.
Mills, E. J. Sr.
Moss, J. B.

**L.U. NO. 301
NEWBURGH, N. Y.**

Cornelius, Jesse

**L.U. NO. 304
DENISON, TEX.**

Feath, William A.

**L.U. NO. 314
MADISON, WISC.**

Christopherson, John
Hames, Harold
Small, Ford D.
Strand, Milo

**L.U. NO. 335
GRAND RAPIDS, MICH.**

Gillett, Glen
Lackey, Harrison
Vugteveen, Benjamin

**L.U. NO. 403
ALEXANDRIA, LA.**

Cooley, Kay

**L.U. NO. 440
BUFFALO, N. Y.**

LeBlanc, George

**L.U. NO. 517
PORTLAND, ME.**

Baril, Raymond M.
Butler, Harland
Cronkite, Guy
Delaney, Edward L.
Downs, Harry
Elliot, Merle
Flannery, Stacy
Gailbraith, Wesley
Howard, Daniel
Konan, Ingus
Olsen, Herbert
Ourlette, Vital
Philippon, Jerry
Raymond, Emile
Roy, J. Napoleon
Therio, Ernest
Tweedie, Perley
Tyler, Arthur
Ward, Lawrence

**L.U. NO. 579
ST. JOHN'S NFLD.**

Connors, Thomas
Hynes, Eugene
Legrow, Eli
Piercey, Harold

**L.U. NO. 583
PORTLAND, ORE.**

Baldwin, Ralph S.
Clay, Glen W.
Ethell, Kenneth R.

Harris, William P.
Stout, Leonard J.

**L.U. NO. 584
NEW ORLEAN, LA.**

Cobden, E. L.

**L.U. NO. 590
RUTLAND, VT.**

Delpha, John
Thorne, Gilbert

**L.U. NO. 639
AKRON, OHIO**

Calvert, Elmer
Croasmun, John
Harnar, Ivan C.
Markle, Francis J.
Petrovics, Paul
Pressen, James

**L.U. NO. 668
PALO ALTO, CAL.**

Haseltine, Clarence
Herndon, Clifford E.

**L.U. NO. 674
MT. CLEMENS, MICH.**

Bradley, Charles N.

**L.U. NO. 696
TAMPA, FLA.**

Adriaansen, T. C.
Awtrey, H. J.
Futch, J. H.
Nichols, D. L.
Noto, A. M.
Sanchez, Carlos
Sanders, H. H.
Sanders, J. H.
Truett, G. H.

**L.U. NO 698
NEWPORT, KY.**

Eicher, Bill
Walsh, Harry

**L.U. NO. 751
SANTA ROSA, CAL.**

Kahl, W. A.

**L.U. NO. 770
YAKIMA, WASH.**

Bishop, Darley

**L.U. NO. 844
RESEDA, CAL.**

Carter, Lester H.
Higginbotham, J. T.
Mathisen, Henry L.
Runner, E. G.

**L.U. NO. 950
NEW YORK, N. Y.**

Knudsen, Charles

**L.U. NO. 958
MARQUETTE, MICH.**

Olsen, Russell
Oman, Ivan
Peterson, John A.

**L.U. NO. 964
ROCKLAND CO., N. Y.**

DeSantis, John
Kusnir, Mike
Nickerson, Howard

Continued, next page

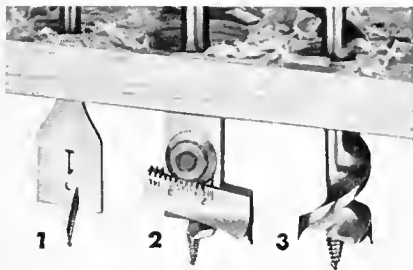

3 easy ways to bore holes faster

1. Irwin Speedbor "88" for all electric drills. Bores faster in any wood at any angle. Sizes 1/4" to 3/8", \$.90 each. 5/8" to 1", \$1.00 each. 1 1/8" to 1 1/2", \$1.50 each.

2. Irwin No. 22 Micro-Dial expensive bit. Fits all hand braces. Bores 35 standard holes, 7/8" to 3". Only \$5.70. No. 21 small size bores 19 standard holes, 5/8" to 1 3/4". Only \$5.00.

3. Irwin 62T Solid Center hand brace type. Gives double-cutter boring action. Only 16 turns to bore 1" holes through 1" wood. Sizes 1/4" to 1 1/2". As low as \$1.60 each.

EVERY IRWIN BIT made of high analysis steel, heat tempered, machine-sharpened and highly polished, too. Buy from your independent hardware, building supply or lumber dealer.

Strait-Line Chalk Line Reel Box only \$1.35 for 50 ft. size

New and improved Irwin self-chalking design. Precision made of aluminum alloy. Practically damage-proof. Fits the pocket, fits the hand, 50 ft. and 100 ft. sizes. Get Strait-Line Micro-Fine chalk refills and Tite-Snap replacement lines, too. Get a perfect chalk line every time.

IRWIN Wilmington, Ohio 45177

every bit as good as the name



Trick or Treat



IN MEMORIAM, Continued

L.U. NO. 971
RENO, NEV.

Gallagher, N. B.
Pancho, Hastings

L.U. NO. 972
PHILADELPHIA, PA.

Wiley, Alfred

L.U. NO. 977
WICHITA FALLS, TEX.

Hinton, Abner H.

L.U. NO. 981
PETALUMA, CAL.

Mindham, John

L.U. NO. 1035
TAUNTON, MASS.

Craig, Arthur P.

L.U. NO. 1040
EUREKA, CAL.

Stevens, Calvin

L.U. NO. 1065
SALEM, ORE.

Polk, John

L.U. NO. 1098
BATON ROUGE, LA.

Evans, C. E.
Haas, John

L.U. NO. 1160
PITTSBURGH, PA.

Mitri, Elisio
Zelik, John

L.U. NO. 1185
CHICAGO, ILL.

Jones, Robert W.

L.U. NO. 1204
NEW YORK, N. Y.

Cohen, Oscar
Lubitow, Abe
Ziegelman, Morris

L.U. NO. 1214
WALLA WALLA, WASH.

Pelam, Frank

L.U. NO. 1235
MODESTO, CAL.

Mount, Frederick T.
Peeples, Chester D.

L.U. NO. 1236
MICHIGAN CITY, IND.

Bartels, Fred

L.U. NO. 1243
FAIRBANKS, ALASKA

Bones, Hollis

L.U. NO. 1274
DECATUR, ALA.

Baher, John M.

L.U. NO. 1289
SEATTLE, WASH.

Bassett, Shelby J.
Bellinger, Clyde N.
Bruse, Gustav
Chase, Arthur E.
Dodge, David D.
Grow, Claude D.
Jones, Quincy D.
Knapp, Loren
Patrick, John
Tomlin, Adolph
Torbergson, Miles T.

L.U. NO. 1292
HUNTINGTON, N. Y.

Alvar, Olav

L.U. NO. 1331
BARNSTABLE CO. MASS.

Brown, Wilbert

L.U. NO. 1367
CHICAGO, ILL.

Amato, Robert K.

L.U. NO. 1397
N. HEMPSTEAD, N. Y.

Marion, Michael G.

L.U. NO. 1426
ELYRIA, OHIO

Rollins, George

L.U. NO. 1452
DETROIT, MICH.

Alcini, Joseph
Bonn, Arthur
Hoover, Adam
Kaltz, Peter
Kawalsky, Joseph
Kleino, Walter
Osten, Louis
Ross, Roy
Tibbs, Charles
Whitacre, Mary

L.U. NO. 1515
PENSACOLA, FLA.

Cobb, Wiley M.

L.U. NO. 1599
REDDING, CAL.

Houston, Roy O.

L.U. NO. 1613
NEWARK, N. J.

Condura, Gaetano
DeCroste, Andrew
Evans, Joseph P.

L.U. NO. 1707
**KELSO-LONGVIEW,
WASH.**

Alston, Daniel E.
Flaskerud, Jerome J.
Hoyt, Homer S.
Jones, Alva A.
Nielson, Viggo
Tarvin, Joseph
Westling, Norman H.

L.U. NO. 1764
MARION, VA.

Adams, Blair
Aker, Wayman
Pennington, David
Pierce, Glen
Poe, Camet
Richerson, Thomas M.
Russell, William O.
Scott, Kyle
Sherwood, Arthur
Shules, Stuart
Testerman, Baker L.
Tilson, James M.

L.U. NO. 1846
NEW ORLEANS, LA.

Sanchez, Wilfred

L.U. NO. 1849
PASCO, WASH.

Thomas, Orlan L.

L.U. NO. 1884
LUBBOCK, TEX.

Cates, G. F.
Craven, D. B.
McGaw, E. C.

L.U. NO. 1934
BEMIDJI, MINN.

Larson, Lester M.

L.U. NO. 2028
GRAND FORKS, N. D.

Amsbaugh, Marvin
Johnson, Edward
Schindler, John

L.U. NO. 2046
MARTINEZ, CAL.

Carbaugh, Floyd
Fassio, Mario
Giampapa, Joseph
Griffin, D. N.
Heath, Errold E.
Humphreys, F. E.
Lombarido, Joseph A.
Sanders, L. L.
Stafford, Virgil D.
Stevens, John W.
Younce, James D.

L.U. NO. 2114
NAPA, CAL.

Kennedy, Lawrence
Swift, Leland

L.U. NO. 2274
PITTSBURGH, PA.

Gargotta, Joseph
Laney, Paul J.

L.U. NO. 2422
EL VERANO, CAL.

Stovall, Robert

L.U. NO. 3206
POMPANO BEACH, FLA.

McVay, Robert
Plummer, James T.
Williams, Otis

LEGACY OF LONG SERVICE

Millmen's Local 1160 of Pittsburgh, Pa., recently lost a veteran member, John Zelik, who was born in 1873, was initiated into the Brotherhood on April 7, 1904. Brother Zelik died May 4, 1971. He was the oldest member of Local 1160.

NEGATIVE SIDE

Continued from page 19

In general then we're going to continue in good faith to operate our programs for the benefit of all the young men who need and deserve a fair chance to learn a trade. As I stated before, this includes doing everything we can to help assure minority youths a fair chance to become and to succeed as apprentices. We hope that we will be able to carry out that policy without the kind of harassment that will keep our programs from operating for anyone's benefit.

The new regulations also contain revisions to Parts 5 and Part 20 of Title 29 CFR, both of which seem to us well calculated to make it even more difficult for our apprenticeship programs to function.

Part 5 now requires a minimum ratio of apprentices or trainees on government-funded projects and provides further that at least 25% of all apprentices or trainees must be in the first year of training. Such a policy is guaranteed to displace both journeymen and advanced apprentices from employment. To require that first-year apprentices take the jobs of older journeymen who perhaps can't produce quite as fast as they used to makes no sense, either economically or socially. To require that first-year apprentices take the jobs of advanced apprentices doesn't make any sense, even in terms of the immediate goal of apprenticeship, which is to train as many journeymen as possible. The net result would be to make our programs expend their resources on the highest possible number of apprentice drop-outs and the lowest possible proportion of successful apprentices who complete their training and become journeymen.

Part 20 of the new regulations now eliminates the previously existing requirements that approved programs be based on an agreement between management and labor as to the content of a program and the rate of wages to be paid. This is an obvious invitation to set up a worthless program and use it as an excuse to pay sub-standard wage rates by calling them training rates. This is not apprenticeship; it is simple exploitation of every young man who is induced to participate in such a program.

I don't think those of us in both management and labor who have worked together on genuine apprenticeship programs can be blamed if we regard such government action as hostile to real apprenticeship. In our joint programs, our aim has always been to provide our apprentices with real knowledge of a real trade. Anything less than that is a cheat to the apprentice and, in the long run, to the industry. And I believe that over the years this policy has proved itself. The quality of the apprentices turned out by our joint programs has made them a credit both to themselves and to the industry. We at least intend to keep on developing young craftsmen who can

carry their weight in a changing and competitive industry.

I assume that this kind of government action is based on a belief that our established programs do not train as many apprentices as they should. A considerable part of such a belief rests on a misunderstanding of the nature of the construction industry, or a willingness to have an oversupply of construction labor which spends half its time in idleness. Quite aside from the fact that you can't train young men if you can't find work for them, it's simply impossible to meet immediately every unpredictable and temporary demand for craftsmen no matter where or when that demand may be. A big job in a rural area is going to completely distort the area's normal labor needs; and no reasonable person can expect otherwise. The number of craftsmen in any area cannot for long exceed the number of craftsmen that the area can support.

Although we have of necessity been focusing our attention on governmental problems, we know very well that all local apprenticeship committees must continue to deal with the day-to-day bread and butter problems that plague all apprenticeship programs.

One of the most basic of those problems is that of finding good apprentice material . . . young men with the background, knowledge and motivation to become successful craftsmen. As you know that isn't so easy as some people seem to think it is. One approach to the long range problem is to join industry, government, and educators in encouraging the development of vocational education as a vital part of our educational system. We are doing this through the Construction Industry Collective Bargaining Commission. We firmly believe that vocational education can never be a substitute for apprenticeship . . . but a good vocational educational system could certainly turn out many more people ready to profit from apprenticeship.

Probably the biggest headache of all to those who run local programs is keeping their apprentices supplied with the employment they must have to learn their trade and to make a living. Even in times of full employment, it is difficult to find enough employers who will give apprentices the variety of work experience they need. In times like these, when there is widespread unemployment, just finding reasonably steady work for apprentices is a major problem. Lack of employment causes more competent apprentices to give up and drop out than all other causes combined, at least in the construction industry.

Now that I've made a whole speech on the negative side of apprenticeship, I suppose the least I can do is try to conclude on a happier note. On the plus side, I think we can honestly say that we are organized to do a much better job of training apprentices than we ever were before. The number and quality of well-organized programs is much greater than a few years ago. All across the board, we

have a real commitment to making our programs work. In spite of the obstacles, I'm sure we're going to keep on with the job of turning out more and better mechanics to do the important work of our industries and our nation.

HARPS ON CHALLENGE

Continued from page 17

The harps are only two of the many items which Pschirer has turned out since his retirement three years ago. He has also built a spinning wheel, candle holders, a bar for his basement, jewelry boxes, writing boxes, and gavel for his club friends.

"I don't sell anything" Pschirer said. "This is strictly enjoyment for me. I don't want it to become a business." Of course, who ever heard of a businessman whose hobby is building harps. ■

MAN'S BEST CADDY

Continued from page 16

was a kid, so one weekend he brought her home and asked me to housebreak her.

"Well I could see right away how intelligent she was. Mike never got her back."

On the golf course, Kari is always on her best behavior. According to Pattison, "you couldn't make this dog bark on a golf course, and you'd have to drag her into a sandtrap or onto a green."

Despite her accomplishments as a caddy and practice partner, Kari's most important trick, according to Pattison, is a little movement she makes upon a signal from her master just as an opposing player is about to putt. The movement is a slight one, just a quick half-step, but it can be very disrupting to the concentration. "We don't do that much," smiles Pattison, "only when I need it to win a match." ■

INDEX OF ADVERTISERS

Audel, Theodore	33
Belsaw Power Tools	21
Belsaw Sharp-All Co.	29
Chicago Technical College . . .	19
Cline-Sigmond, Publishers . . .	26
Eliason Stair Gauge Co.	33
Estwing Manufacturing	36
Foley Manufacturing	28
Hydrolevel	29
Irwin Auger Bit Co.	38
Knaack Manufacturing	35
Locksmithing Institute	21
North American School of Drafting	31
Paneling Specialties Co.	24
Rockwell Manufacturing Co. . .	12
Schaefer Manufacturing Co. . .	24
Stanley Works	Cover 4
True Temper Corp.	Cover 3
Vaughan & Bushnell Manu- facturing	24



In Conclusion

M. A. Hutcheson, *General President*



Runaway Jobs—1971 Style

■ The ranks of the unemployed in this country are continuing to swell, and much of the fault lies in the fact that more and more multinational U.S. corporations are taking much-needed jobs overseas to cheap labor areas.

One American firm after another has closed down parts of its operations here and reopened them abroad, sometimes paying its new workers as little as 25 to 50 cents an hour; then shipping the cheaply-produced items back to the U.S. market for quick profits.

Zenith Radio Corporation, for example, recently built a large plant in Taiwan that cost thousands of U.S. workers their jobs. Bendix Corporation moved part of its operations out of York, Pa., to 42-cents-an-hour workers in Mexico. As a result, 600 Americans went on the unemployment rolls.

The automobile industry has been hard-hit by the job-export situation. For example, Chrysler is distributing in the U.S. the new Dodge Colt—an American brand-name compact imported from Japan and actually manufactured by the Mitsubishi company of Tokyo. In turn, Mitsubishi will distribute in the Orient the Plymouth Valiant. That sounds like a fair exchange, except for the fact that the Valiants are manufactured by a Chrysler subsidiary in Australia.

To make matters worse, some goods now coming into this country from overseas bear phony labels

which imitate U.S. labels . . . even hard-won union labels.

Lumber and sawmill workers saw the tragic situation developing a few years ago when Japan began to pay premium prices for logs in the Pacific Northwest, shipping the logs back to their own mills for manufacture and then returning the finished products to this country for sale at cut-rate prices.

The time has come to tackle this problem of exported jobs with all the expert knowledge which the Federal Administration can bring to bear. As things now stand, the AFL-CIO and its affiliates are almost alone in their fight to protect the livelihood of millions of their fellow Americans.

The AFL-CIO has proposed a five-point program to stem the outflow of American workers' jobs:

1. The government should tax runaway firms sufficiently to make it less attractive for them to go overseas. Present minimal taxes on them amount to a government subsidy of their overseas operations.

2. The government should regulate, supervise and curb large outflows of American capital for investment by U.S. companies in foreign operations.

3. The government should regulate the foreign license and patent arrangements of U.S. companies to curb the export of American technology, a technology paid for in many cases by the money of American taxpayers.

4. The government should press for international fair-labor standards in world trade.

5. The government should set up an orderly system to regulate the flow of imports into the U.S. where they are significantly displacing American production and jobs.

To these I would add one more point: that money would not be used as the exclusive measuring stick for foreign trade. Rather, a system of measuring the value of exports and imports be devised to give weight to the man hours of labor required to produce each item. Obviously a million dollars worth of raw cotton exported to Japan involves very little American labor. On the other hand, a million dollars worth of motorcycles, cameras, or automobiles imported into the United States involves large amounts of labor for Japanese workers.

The time has come to recognize this principle in foreign trade matters. ■





...because it lasts!



...and lasts...and lasts. When you purchase a True Temper striking tool, you purchase durability — durability which results from 138 years of manufacturing skill and craftsmanship. This same craftsmanship creates the precision balance and comfortable design of True Temper striking tools.

You get what you pay for when you purchase True Temper products. You get quality, integrity, and most of all, you get a product that will last.



"You'll be glad you bought the best!"

TRUE TEMPER

A MEMBER COMPANY OF ALLEGHENY LUDLUM INDUSTRIES

Stanley gives today's best routers even more power

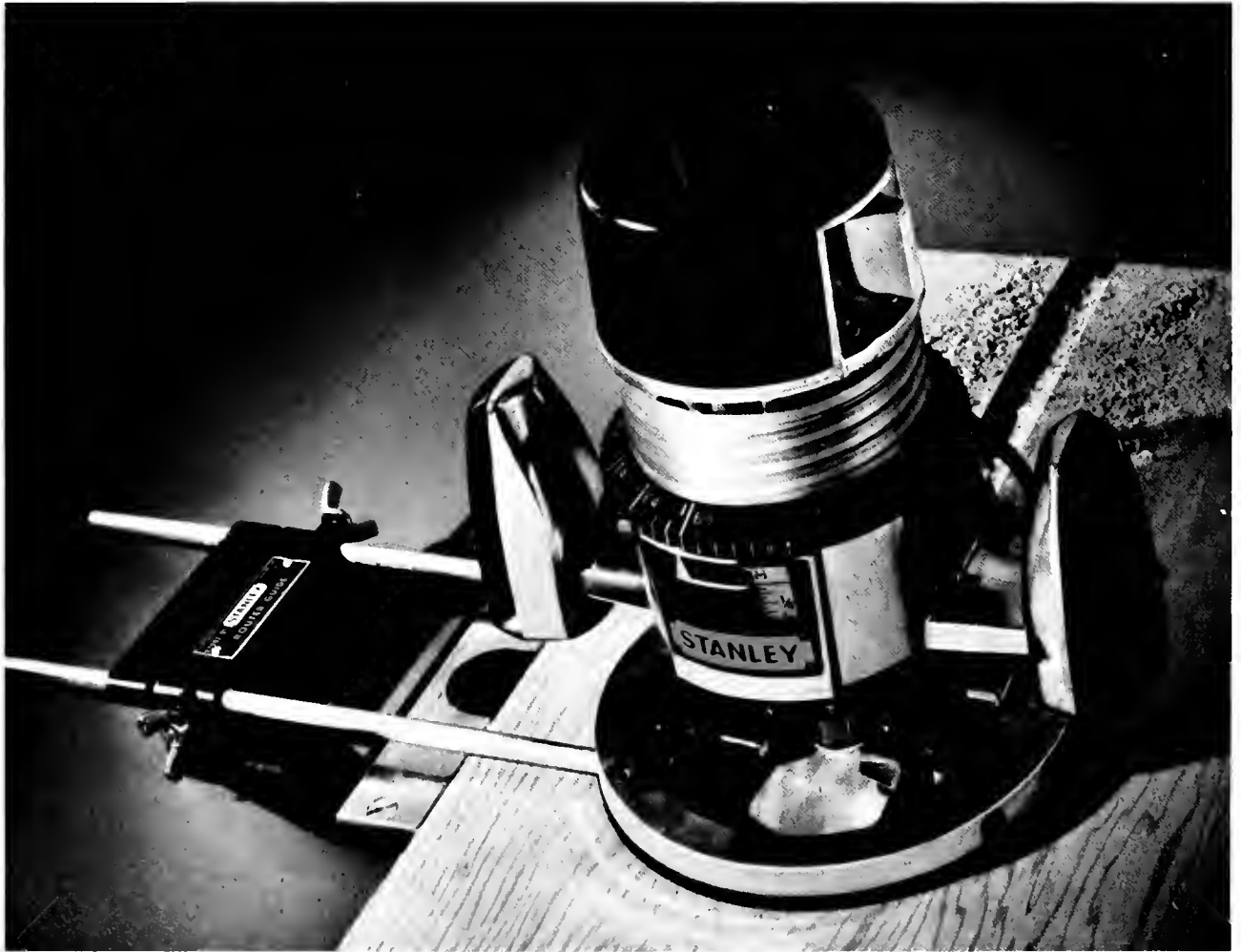

Two of today's most popular ball bearing routers have been given even greater power and capacity.

Model 91264 at \$77.00 now produces a full 1 h.p.; Model 91267 at \$87.00 has a full 1½ h.p. Each router will now accept ⅜" shank diameter bits, as well as ¼", using either of two collets furnished. Use of heavier ⅜" shank bits, however, assures less breakage under heavier torques and feeds.

Motors have welded (not soldered) leads. Micrometer depth settings are in .004" increments. Three position handles provide fatigue-free operation, bet-

ter control, with convenient thumb switching without removing either hand. A switch-operated shaft lock permits one-wrench bit changes. And *only* Stanley routers have a built-in light for better visibility for the operator.

Stanley's complete line of routers range from ¼ h.p. to 8 h.p. in electric, air and high-frequency power sources. See them at your distributor. Stanley Power Tools, Division of The Stanley Works, New Bern, No. Carolina 28560.

STANLEY
helps you do things right

P.S. Made by the same Stanley that makes the finest hand tools.

NOVEMBER 1971

The

CARPENTER

Official Publication of the UNITED BROTHERHOOD OF CARPENTERS AND JOINERS OF AMERICA - FOUNDED 1821

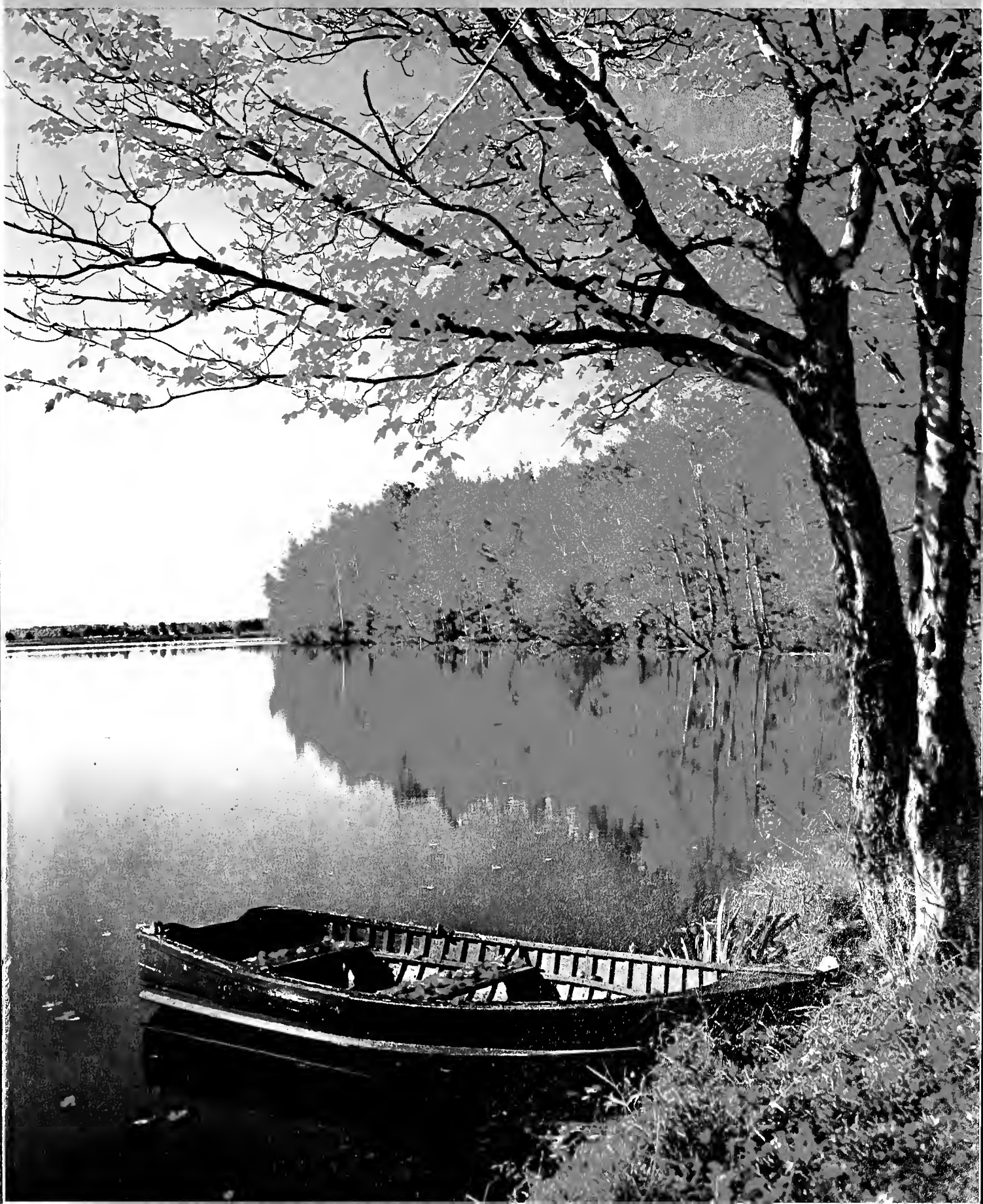

OFFICIAL INFORMATION



GENERAL OFFICERS OF THE UNITED BROTHERHOOD of CARPENTERS & JOINERS of AMERICA

GENERAL OFFICE:
101 Constitution Ave., N.W.,
Washington, D. C. 20001

GENERAL PRESIDENT

M. A. HUTCHESON
101 Constitution Ave., N.W.,
Washington, D. C. 20001

FIRST GENERAL VICE PRESIDENT

WILLIAM SIDELL
101 Constitution Ave., N.W.,
Washington, D. C. 20001

SECOND GENERAL VICE PRESIDENT

HERBERT C. SKINNER
101 Constitution Ave., N.W.,
Washington, D. C. 20001

GENERAL SECRETARY

R. E. LIVINGSTON
101 Constitution Ave., N.W.,
Washington, D. C. 20001

GENERAL TREASURER

CHARLES E. NICHOLS
101 Constitution Ave., N.W.,
Washington, D. C. 20001

DISTRICT BOARD MEMBERS

First District, PATRICK J. CAMPBELL
130 North Main Street
New City, Rockland Co., New York
10956

Second District, RALEIGH RAJOPPI
2 Prospect Place, Springfield, New Jersey
07081

Third District, WILLIAM KONYHA
1830 Ledge Rd., R.D. No. 4
Medina, Ohio 44256

Fourth District, HAROLD E. LEWIS
340 Northwest 148th St.
Miami, Florida 33168

Fifth District, LEON W. GREENE
2800 Selkirk Drive
Burnsville, Minn. 55378

Sixth District, FREDERICK N. BULL
P.O. Box 14279
Oklahoma City, Okla. 73114

Seventh District, LYLE J. HILLER
Room 722, Oregon Nat'l Bldg.
610 S.W. Alder Street
Portland, Oregon 97205

Eighth District, M. B. BRYANT
Forum Building, 9th and K Streets
Sacramento, California 95814

Ninth District, WILLIAM STEFANOVITCH
2418 Central Avenue
Windsor, Ontario, Canada

Tenth District, ELDON T. STALEY
4706 W. Saanich Rd.
RR #3, Victoria, B. C.

M. A. HUTCHESON, *Chairman*
R. E. LIVINGSTON, *Secretary*

Correspondence for the General Executive Board
should be sent to the General Secretary.



Secretaries, Please Note

If your local union wishes to list deceased members in the "In Memoriam" page of *The Carpenter*, it is necessary that a specific request be directed to the editor.

In processing complaints, the only names which the financial secretary needs to send in are the names of members who are NOT receiving the magazine.

In sending in the names of members who are not getting the magazine, the new address forms mailed out with each monthly bill should be used. Please see that the Zip Code of the member is included. When a member clears out of one Local Union into another, his name is automatically dropped from the mail list of the Local Union he cleared out of. Therefore, the secretary of the Union into which he cleared should forward his name to the General Secretary for inclusion on the mail list. Do not forget the Zip Code number. Members who die or are suspended are automatically dropped from the mailing list of *The Carpenter*.

PLEASE KEEP *THE CARPENTER* ADVISED OF YOUR CHANGE OF ADDRESS

PLEASE NOTE: Filling out this coupon and mailing it to the *CARPENTER* only corrects your mailing address for the magazine. It does not advise your own local union of your address change. You must notify your local union by some other method.

This coupon should be mailed to *THE CARPENTER*,
101 Constitution Ave., N.W., Washington, D. C. 20001

NAME _____ Local No. _____

Number of your Local Union must be given. Otherwise, no action can be taken on your change of address.

NEW ADDRESS _____

City

State

ZIP Code

THE CARPENTER

VOLUME XCI

No. 11

NOVEMBER, 1971

UNITED BROTHERHOOD OF CARPENTERS AND JOINERS OF AMERICA

Peter Terzick, Editor



IN THIS ISSUE

NEWS AND FEATURES

- The Carpenters Labor-Management Pension Fund ... William Sidell **2**
- Apprentice Champs Tour America **4**
- Rediscovering American Labor Penn Kemble **7**
- The New Western Forestry Center **10**
- St. Louis Consumercare Bus Reaches Carpenters **18**
- Avoid Blood Poisoning from Rusty Nails ... Dr. W. Schweisheimer **23**

DEPARTMENTS

- Washington Roundup **9**
- We Congratulate **12**
- Local Union News **14**
- Service to the Brotherhood **19, 20, 25, 27**
- Canadian Report Morden Lazarus **21**
- Plane Gossip **26**
- Apprenticeship and Training **28**
- Your Union Dictionary **32**
- CLIC Report **33**
- Outdoor Meanderings Fred Goetz **35**
- In Memoriam **37**
- Lakeland News **38**
- In Conclusion M. A. Hutcheson **40**

THE COVER

The brilliant autumn leaves of North America are unmatched anywhere else in the world. In Great Britain, damp weather tones down the display. Moreover, fewer of the most colorful trees grow there.

In continental Europe, Asia, and the Southern Hemisphere, the climates tend to be too damp or too dry, temperatures too hot or too cold, or evergreens too predominant, for a generally colorful autumn.

North American hardwood forests, however, have all the essentials to produce nature's brightest pageant. The forests support a great variety of deciduous trees, species whose broad leaves turn color and drop in autumn. More than a hundred kinds of deciduous trees grow in some areas.

Autumn weather in the eastern forests is just right for development of leaf color: clear, bright days and cool, crisp nights.

Two pigments, carotene and xanthophyll, give leaves their yellow and orange colors. Reds and purples are produced by a group of pigments called anthocyanins. Brown tannin pigments blend with the xanthophylls to produce yellow-gold and gold-brown leaves.

Some botanists suggest that the pigments may act as a protective screen against certain harmful rays of light. Others believe that fall coloration serves no essential purpose for trees, though the sheer beauty delights the eyes of human beings.

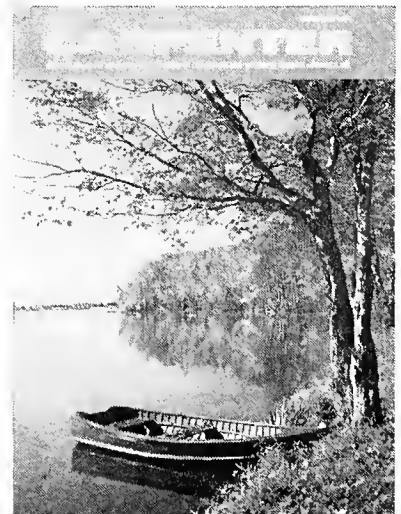

POSTMASTERS, ATTENTION: Change of address cards on Form 3579 should be sent to THE CARPENTER, Carpenters' Building, 101 Constitution Ave., N.W., Washington, D. C. 20001

Published monthly at 810 Rhode Island Ave., N.E., Washington, D. C. 20018, by the United Brotherhood of Carpenters and Joiners of America. Second class postage paid at Washington, D. C. Subscription price: United States and Canada \$2 per year, single copies 20¢ in advance.



Printed in U. S. A.

Carpenters Labor-Management Pension Fund Established

*New plans offer greater protection of
benefits, reduce administrative costs*

By **WILLIAM SIDELL** First General Vice President



■ A pioneering pension program of international scope was launched last month by the United Brotherhood of Carpenters and Joiners of America.

On October 11 General President M. A. Hutcheson announced the establishment of the Carpenters Labor-Management Pension Fund, which is available to members in the United States and Canada whether they work in an industrial plant or in the construction industry.

A trust agreement was signed in Washington in late September to establish the program. The first contributing employer is Sterling Homex Corp. Agreements will be signed with other major employers in the near future.

Present for the signing was U.S. Senator John Sparkman of Alabama, chairman of the Senate Committee on Banking, Housing, and Urban Affairs, who called the agreement "a forging together of two great forces—the future financial security of members of the building trades and the growing strength and vitality of industrialized housing—in a major effort to increase the prosperity of the entire nation.

"The new pension concept . . . constitutes a powerful weapon to overcome America's tragic housing shortage," he added.

The new pension fund comes in response to the long-felt needs of members in local unions and district councils where circumstances have made it impossible to negotiate pension coverage. It will provide a pension vehicle for future collective bargaining agreements.

Continued on page 34

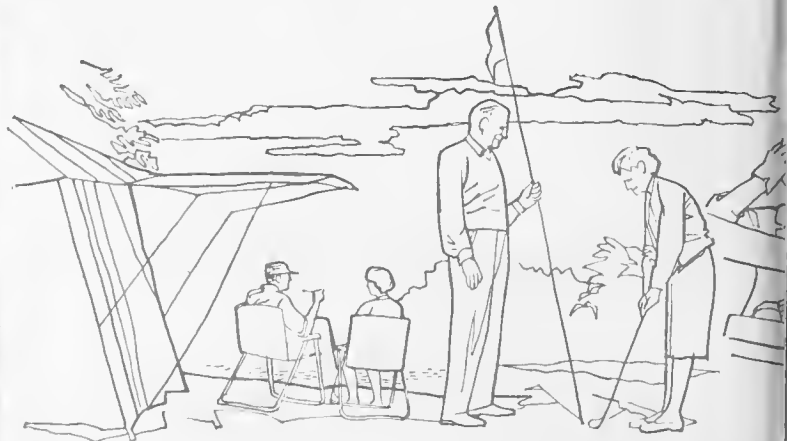



Shown signing the Carpenters Labor-Management Pension Fund agreement are General President Maurice Hutcheson left, and David Stirling, Jr., for employers. Witnesses, standing left to right, are Vincent O'Hara of the Martin Segal Company; Sen. John Sparkman (D-Ala.); M. C. Plumley of the M. A. Cornell Co., insurance plan managers; First General Vice Pres. William Sidell; John Van Steenwyk of the Martin Segal Co., consultants, and Theodore Kheel, labor arbitrator and attorney.

Carpenter Pro-Rata Agreements Permit Existing Pension Plans to Provide Continuity of Coverage

Covered members will be able to change jobs among participating employers, carrying pension "service credits" with them

■ A major instrument for implementing lifelong continuity of pension coverage is the Pro-Rata Pension Agreement—a basic document which permits members covered by various pension plans to draw pro-rata benefits from *participating plans* upon retirement.

The Pro-Rata Pension Agreement offers, in effect, an advantage long sought by workers in the building and construction trades: "portability," the ability to change jobs and maintain pension benefits at the same time. In other words, a member covered by a pension plan under the new Carpenters Labor-Movement Fund who moves to another job covered by the *pro-rata agreement* can achieve continuity of pension coverage as provided in the agreement.

Many local, district, and area pension plans have already signed Pro-Rata Pension Agreements, bringing them under the master international reciprocal program. Many more area plans are expected to join the international program before the end of the year. Pension plan trustees are now examining details of the Pro-Rata Agreement.

Note to Members: You are not automatically covered by the Carpenters Labor-Management Pension Fund, nor do you achieve pro-rata pension protection merely by being a member in good standing of the Brotherhood. Your local union or district council has to negotiate a pension plan with employers, if it has not already done

Continued on page 34



Apprentice CHAMPS tour America

1971 contest
winners promote
craft and industry
as guests of
National Forest
Products Association

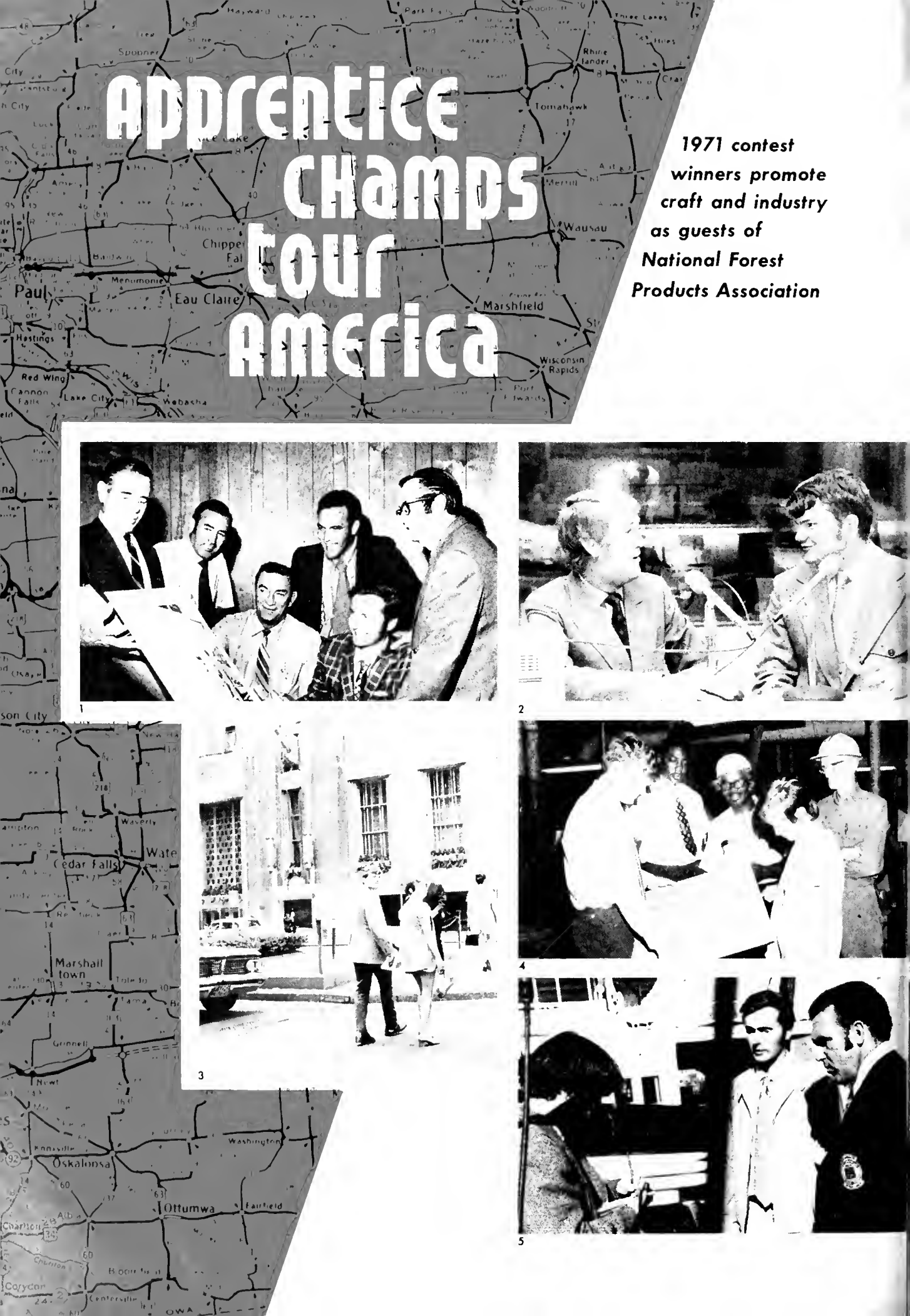

■ Winners of the International Carpenters Apprenticeship Contest for the first time this year were awarded all-expense tours of forest products industry facilities across North America. Christopher Cottier, first place carpenter, and James Wright, first place millwright, toured West Coast tree farms, mills, and other industry sites. John Trimble, first place mill-cabinetman, toured the South and East Coast.

The winners were guests of the National Forest Products Assn. and forest industry companies and associations. In Memphis, Tenn., for

example the Trimbles were guests of the Southern Hardwood Lumber Manufacturers Assn. In the Northern California area, Cottier and Wright were guests of five forest industry companies and associations, as they toured redwood and fir forests and mill operations.

The tours gave the apprenticeship champions an opportunity to see the forest products industry from the planting of the seedling at the nursery, through the harvesting of the trees, the manufacture of the lumber and other products, and, finally, the use of the materials in construction.

The tours came only a few weeks after the 1971 Carpenters International Apprenticeship Contest in Detroit, Mich., August 14, 15, and 16, where industry sponsorship also came from the American Plywood Assn. and Boise Cascade Corp., both of which supplied construction materials for the contest.

As the accompanying pictures indicate, the 1971 tours also included exciting sidetrips to San Francisco and Hollywood for two of the contestants and a tour of New Orleans and Manhattan for the other. ■



1. Two winners visit Los Angeles District Council leaders while in California. From left: Ass't. Sec. Russel Auten, Business Representatives James Flores and Patrick McDonald, Winners Wright and Cottier, and Business Representative Terry Slawson.

2. Jim Lowe of NBC Monitor News tapes an interview in New York City studios with Mill-Cabinet Winner John Trimble.

3. Judy and John Trimble outside the Waldorf Astoria in New York, where they stayed as guests of U.S. Plywood-Champion Papers, Inc.

4. A laminated hardwood counter top is admired by John and Judy Trimble during a tour of the E. L. Bruce Co. Division of Cook Industries, Inc., Memphis, Tenn. With them are Int'l. Rep. James Wallace and Adell K. Register and Cullen M. Quick, president and vice president of Local 2523.

5. Winners Cottier and Wright are interviewed by a San Francisco Chronicle reporter.

6. Two of the champs visit the "office" of TV celebrity Marcus Welby, MD, at Universal Studios in Hollywood.

7. Dick Taylor, carpenter at Universal Studios, prepares a door on a motion picture set with assistance from two apprentice champions.

8. Cottier and Wright inspect one of thousands of trees planted by Los Angeles school children in cooperation with city and county schools, the country forester, the American Forest Institute, and Universal Studios.

9. Wright and Cottier in the cockpit of a mockup 747 at Universal Studios in Hollywood.



Editor's Note: In the September CARPENTER the Brotherhood extended thanks to many organizations for their support and assistance during the 1971 International Carpenters Apprenticeship Contest. We inadvertently omitted the Boise Cascade Corp., which supplied lumber for the carpenter and mill-cabinet contestants. We take this opportunity to offer our belated thanks to this contributor.

Apprentice Champs Tour America

Continued from preceding page



Cottier views Snoqualmie Falls, Wash., Weyerhaeuser Plant from company helicopter during West Coast tour.



Cottier and Wright watch wood chip production with Weyerhaeuser officials, Bob Hamerly and Bob Clingman.



Viewing a 65-year-old stand of Douglas fir with Weyerhaeuser forester and tour guide, Howard Millan.



With Bob Clingman, Weyerhaeuser public affairs representative, in the plywood mill at Snoqualmie Falls.

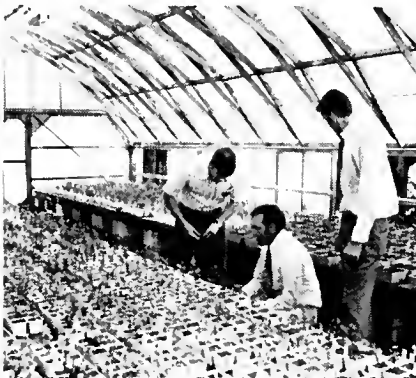

Rod Wright with the apprentice champs at a Weyerhaeuser seed orchard near Mima, Washington.



Collier and Wright with officials of Boise Cascade Union Lumher Operations at Fort Bragg, Calif.



David and Judy Trimble in Meridian, Miss., with Mr. and Mrs. H. E. Sanders, their hosts in Meridian. Sanders is president of the National Forest Products Association, which sponsored the tours for the winners of the International Carpenter Apprenticeship Contest in cooperation with forest products industry companies.



The manager of an industrial tree farm near Meridian, Miss., shows the Trimbles the growth of a pine on his farm during the past year.



Rediscovering American Labor

BY PENN KEMBLE

Reprinted from COMMENTARY by permission, Copyright 1971 by the American Jewish Committee.

■ It has been almost two decades since the labor movement went out of fashion among liberal and radical intellectuals. Today it is apparent that something of a change is taking place. George Wald, the Harvard scientist who has become a spokesman for academic radicalism, recently brought labor leaders and intellectuals together for a dialogue. According to a statement issued by Wald and his colleagues, cooperation between academics and labor “. . . would give the academic community what it now most lacks: a base in the outside community.”

Political cynicism holds that respect is usually paid to the successful and the powerful. This appears to apply for liberal and radical intellectuals as well as for those who make fewer claims to elevated motives. In all likelihood, labor was courted in the 1930's not simply, as the reminiscing radicals would have it, because labor was then a pure flame of social righteousness. It was rather because the power of the labor movement in politics or on the picket line was so dramatically apparent, while the world of business and the upper classes seemed so unsteady. A good deal of today's revival of interest in labor probably has a similar basis. The political vogues of the 1950's and 1960's have lost their glamor, while the unions, for long the targets of so much snobbish disdain, have shown

remarkable durability and vigor.

One could sense a shift in the anti-labor winds back in 1968. First, the United Federation of Teachers won its bitter strike against the Lindsay administration. Not only had most intellectuals opposed the union: special honors were awarded to union-busters and strike breakers. (Soon after, through the reporting of Martin Mayer and the repudiation by the black community itself of so-called community leaders who had opposed the union, some liberals quietly recognized that the union was not only powerful, it had been right.)

Political Muscle

The unions then demonstrated enormous political muscle in the 1968 Presidential elections. Despite widespread liberal indifference and the strong backlash campaign of George Wallace, the labor movement by itself almost carried Hubert Humphrey into the White House. From then until now the unions have had a string of successes: the organization of farm and hospital workers and white-collar employees, the collective-bargaining victories at General Electric and General Motors, the legislative defeats of Haynsworth and Carswell, and the impressive showing in last year's elections, when labor's organization and labor's issues were unquestionably the deciding factors in the revival of the Democratic party.

And all this despite a hostile administration and a faltering economy.

In face of these successes, and the equally impressive record of disappointments that has been built up by the protest movements of the disaffected intelligentsia—the New Left and the New Politics—it is not surprising that some formerly hostile intellectuals are preparing themselves again to accept an alliance with organized labor. It is unlikely, however, that they will be able to do so without reappraising some of the theories and attitudes which have fed the indifference and hostility toward labor within the intellectual community in the past twenty years.

The anti-labor posture has often been justified with the argument that labor lost its claim to support in the intellectual world by turning conservative in the 1950's. A fairer assessment is that many intellectuals became more conservative, and abandoned labor. During the 1930's intellectuals were often obliged to look at the world from the standpoint of the working man. Many of them took ordinary jobs or worked in the labor movement itself. Government was Left-leaning in the New Deal days, and many writers and artists were employed on government public-works projects. But in the relative affluence of the postwar years many of these same intellectuals moved into secure and well-paying positions in the universities and in publishing. Some even gained admit-

tance to the fringes of the business world, as writers and as consultants to the great foundations. Sources of government support shifted from the WPA to the Department of Defense, the poverty-education complex—and other less visible agencies.

In short, the intellectual community was raised to an unprecedented status and affluence, based on relationships with institutions which depended for their support on the large corporations, the upper classes, and the more conservative branches of a now more conservative government.

1950 Conservatism

The conservatism of the 1950's did not spare even the radical intellectuals, although, to be sure, its impact on them often took a distinctive form. Their radicalism now assumed a patrician cast—they were the lonely bearers of high social and cultural standards in a mass society being inundated by "kitsch." Same radicals saw the awesome rise of totalitarianism as an expression of an unexpected "working-class authoritarianism." Others blamed the people themselves, and not the conservative institutions which had regained dominance in the society, for the failure of radical hopes. Much of the disillusionment of the 50's with the working class can be summed up in two statements, which later served as the basis for the "radicalism" of the 1960's:

(1) The general public is hypnotized by affluence and commercialism and has been reduced to a mass of private consumers.

(2) In the atmosphere this creates, people are easily manipulated and the leaders of various interest groups tend to congeal into a uniformly venal though clever elite.

These two axioms were most clearly argued in the work of a radical sociologist who achieved great influence in the 1950's and early 1960's—the late C. Wright Mills. Paradoxically, those who held these views took over arguments that earlier had been the property of conservatives of an aristocratic bent. The contention that material affluence is destructive of the common man's character was also the view of the Russian landowner who worried that his serfs would lose their souls in a more modern social order, and of the Southern planter who was protecting his happy-go-lucky slaves from Yankee liberalism and commercialism.

It is not surprising that the trade-union movement came to be a prime

target for the contempt of many intellectuals who were caught up in this peculiar mood. Through legislation and collective bargaining it does more than any other institution to bring some democratization to American affluence, thus spreading "corruption" to the lower orders. It is also the largest and strongest independent popular organization in this society. By electing leaders out of its own ranks, it has created a center of power and political expression which is free of both the business and intellectual elites. The forthright and down-to-earth manner of some of these leaders—George Meany, for example—is a special irritation to a certain breed of intellectual. And, one should add, to quite a few businessmen as well.

If the preceding explains why the intellectuals for their own reasons were being drawn away from labor, what has been the state of the labor movement itself during the past two decades? All things considered, it seems fair to say that labor is somewhat to the Left of where it was in the 1930's. At least, it has moved to the Left in most important substantive matters, if not in such things as rhetoric and strike tactics.

While there may be fewer union leaders today who make flamboyant speeches against the bosses, the mainstream of the labor movement is more involved with social issues of broad public concern, with political action, with race relations, with experimental forms of collective bargaining, with organizing new sectors of the work force, and with labor education than it has ever been before.

Some new social commitment is remarkably wide-ranging. In 1968-69, for example, the AFL-CIO made financial contributions to such causes as the Smithsonian Institution's Folk Life Program, and the Clergy Economic Education Foundation. It has been estimated that labor raises one-third of all United Fund and Community Chest collections, that union members who are reached through union-sponsored programs make about one-third of all Red Cross blood donations. But, of course, the core of labor's activity outside the industrial-relations sphere is in the field of politics and legislation.

The importance of the labor movement in winning liberal legislation is badly underestimated. It is very unlikely according to Clarence Mitchell, the NAACP's Washington representative, that any recent federal civil-rights legislation would have passed

without the support of labor's lobbyists. The same can fairly be said for almost all the important liberal legislation of the 1950's and 1960's. The defeat of Nixon's Southern nominees to the Supreme Court by the Senate—defeats which were largely due to the efforts of labor lobbyists—is further evidence of labor's legislative potency. Labor does not now simply wait for legislation to appear, and then announce its support or opposition. It takes the initiative in raising issues. The legislative struggle over National Health Insurance, which may well become the crucial issue for the 92nd Congress, will be largely a result of legislative organizing done by the AFL-CIO and the UAW. The unions maintain the largest more-or-less united, experienced staff of legislative representatives which can be rallied behind a liberal bill. And in recent years at least three-quarters of the issues that have occupied labor's legislative energies have had no special benefit for unions or union members: they are simply general social-welfare issues.

Raw Social Chunk

So long as there is no pro-labor current in American intellectual life, the unions will be hard pressed to meet the complex problems that await them, and to hold their members to liberal politics. The labor constituency is not like the membership of a liberal club: it is a huge raw chunk of American society with more—far more—than its share of decency, but with backward, parochial, and conservative qualities as well. It cannot simply be managed by its staff and officials. It is profoundly affected, for good or ill, by trends in the wider public.

On the other side, unless the intellectuals can establish the right kind of close relationship with the labor movement, they will in all likelihood continue to be torn between the temptations of the affluent status quo and feverish and sterile discontents. But the right kind of relationship will entail more than adding a few "bread and butter planks" to the New Politics program, inviting some labor leaders in for drinks, or securing a few signatures on an ad or manifesto, all in deference to the recognition that labor still has power. Only if there is also a far-reaching rediscovery of the unique qualities and traditions that make the unions important sources for democratic change will the current revival of interest in labor among intellectuals escape the fate of other recent political fads. ■

WASHINGTON



ROUNDUP

CENSUS PROBE—The action of the Nixon Administration in directing the Bureau of the Census to make a special public opinion survey on reaction to the President's wage-price freeze including a question on union membership is facing a Congressional investigation.

Rep. Charles H. Wilson, California Democrat, who is chairman of the House Subcommittee on the Census, has expressed deep concern that the Nixon Administration is using the Census Bureau for purposes of its own. He has written Secretary of Commerce Maurice Stans, under whose jurisdiction the Bureau falls, asking for a full explanation of the purpose of the poll, who is to use it and why the questionnaire includes a question on union membership.

SEE PRICE LISTS—The Cost of Living Council has decided that each place of sale must maintain lists of ceiling prices for all goods or services. The records must be made available to a customer who "specifically" requests to see them. Customers not satisfied with the ceiling price provided by the seller should file a complaint with the local office of the Internal Revenue Service.

REVERSE LIB—A case of sex discrimination in reverse intrigues union leaders in the nation's capital. Verne Wilson, a male nurse and 60-year-old grandfather filed a lawsuit against Sibley Hospital complaining that the hospital (and most others) discriminated against males by refusing to let them tend female patients. Also charging that his civil rights are violated by such discrimination, Wilson also filed complaints with the federal Equal Employment Opportunity Commission.

PHASE OUT—Phase I of President Nixon's New Economic Program will pass into history on November 13 and Phase II then will get underway.

After studying Phase II, following the President's disclosure of how it will work, one trade union official here observed: "I'm looking for Phase Out!"

MINERS' HARD HATS—The Department of Interior has issued a ruling making hard hats and hard-toe shoes mandatory garb for miners. The safety dress is standard gear but would be required now under the Coal Mine Safety Act. It also cancelled a proposed ruling that would have required seat belts on some mine vehicles.

VIRTUE REWARDED—Commissioner of Labor Statistics Geoffrey H. Moore took four pages in insisting that the new Nixon reorganization plan for Government statistics gathering was completely clear of political bias and was designed to "improve" the services.

A spokesman for the AFL-CIO put the whole thing more succinctly. "All we know is that the guys who told the truth are getting the axe."

JOURNEYMAN ECONOMIST—Carl Rowan, the syndicated columnist who was once a high government official, is far from sold on the government economist. He recently wrote:

"What we ordinary slobs had better do is take all this expertise with a few grains of doubt. The truth is, there never was an economist who could count faster than a plumber, which says a lot in favor of following the lead of that journeyman economist, George Meany."

WOMEN'S RIGHTS—President Nixon was pressured by women's lib organizations to appoint a woman to one of the two Supreme Court vacancies. A labor lawyer, however, recalled a little-known fact of Supreme Court tradition that would reduce the lady justice to the Court's most menial task. Tradition has ordained that the Court's newest appointee—when the Court is in closed session—must get up and answer the door to accept messages.

An Adventure in Wood ...

The New Western Forestry Center

Members of Portland District Council
build new center to replace
famous "Gallery of Trees."

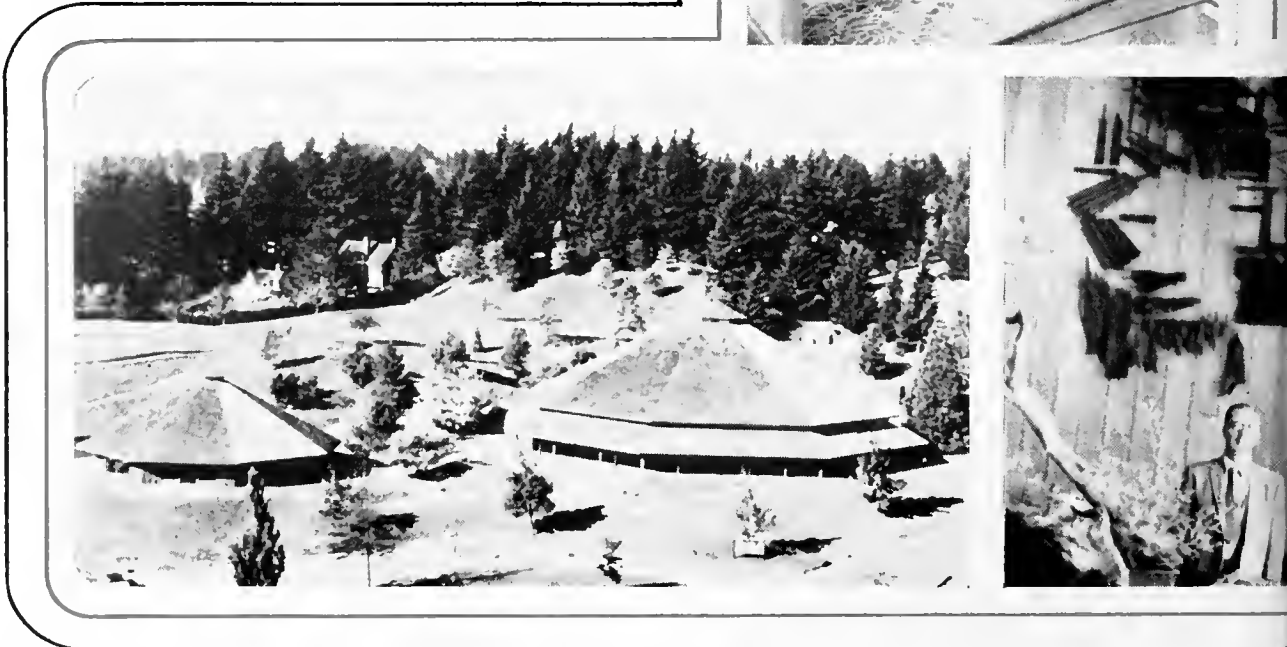
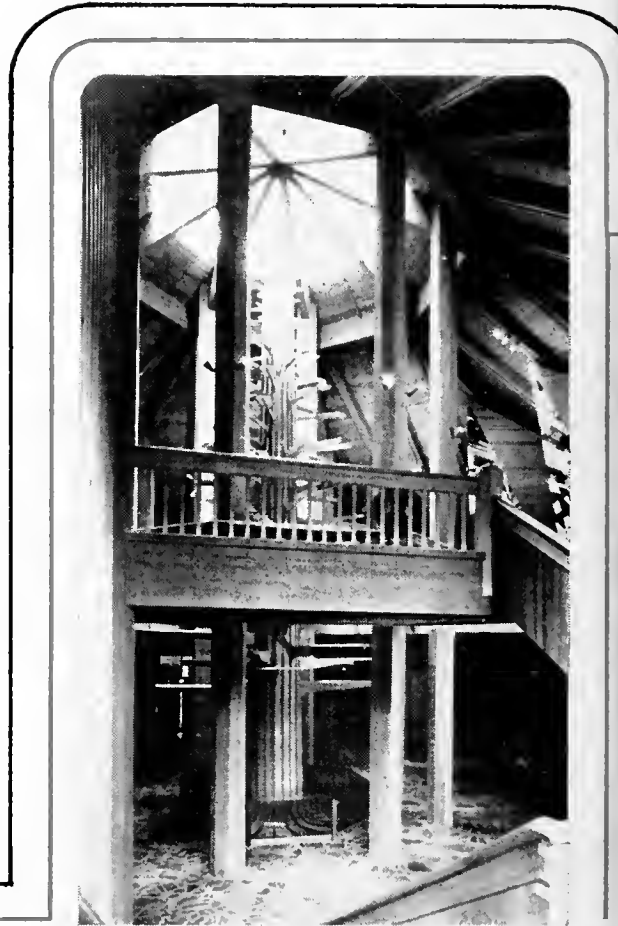

The Western Forestry Center in Portland, Oregon, serves as a focal point for forestry education, information and activities concerning recreation opportunities and use of the forests.

Swan Nelson, Sec.-Treas., Portland District Council, stands before wood-sculpture of old fashioned saw mill.

Right: The 1905 Lewis & Clark Exposition Oregon Myrtlewood prize-winning table, which was donated by the Portland District of Carpenters, is featured in the Colonial Room. It was restored by Willie Grawe, Local 1120.

Left: The 70-foot "talking tree" at the Western Forestry Center in Portland, Oregon, is a spectacular symbol and host of the Center.

Below: Visitors to the Western Forestry Center observe first-hand the many end uses of the nation's trees.

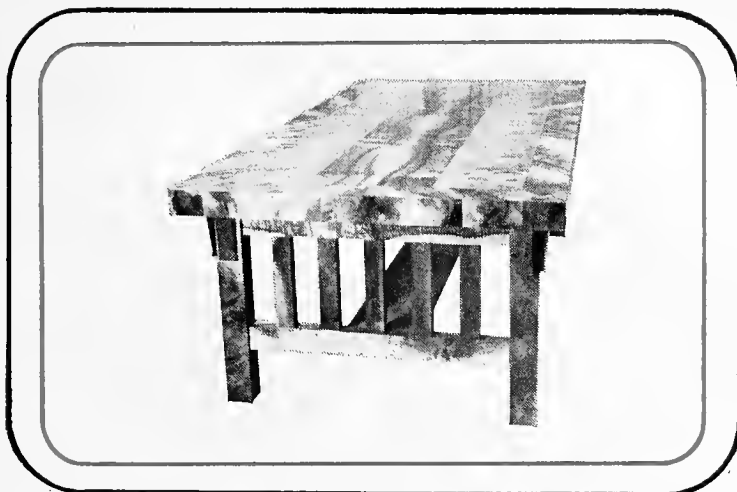

■ The children of Oregon residents, plus those of tourists from throughout the United States, now have access to a truly remarkable adventure in wood—the Western Forestry Center in Portland, Oregon.

It has been open since June 6, constructed with 100 percent union labor, including members of the 12-local Portland District Council of Carpenters.

Carpenters worked a total of 24,000 man hours on the job.

A total of 700,000 board feet of lumber, shakes and plywood went into the Center's two buildings—a large exhibit hall and a comparatively smaller theater building, which includes a kitchen.

"The Western Forestry Center represents the forest industry on the Pacific Coast and is well worth anyone's time and effort to make it a point when in Portland to go through the buildings," says Swan Nelson, secretary-treasurer of the Portland District Council of Carpenters.

The location of the Forestry Center is ideal, for it is next to another children's educational delight, the Oregon Museum of Science and Industry (OMSI), and only yards away from the Portland Zoo, with its special train which winds through the Forest Park timber land.

Construction of the Forestry Center ended a public drive stemming from 1964. That year fire destroyed Portland's landmark Forestry Building, a giant log cabin, which had stood since the Lewis & Clark Exposition in 1905.

The present Western Forestry Center, constructed by the Henry M. Ma-

son Co. of Portland, utilizes wood from Alaska, Idaho, Montana, Washington, California, Oregon and tropical conifer railings from Indo-China.

The \$1.5 million to erect the center, plus \$1 million more to furnish it, were raised from private donations.

The Western Forestry Center is a non-profit organization. The cost of maintaining it comes from \$1 adult and 50-cent children's admissions, plus revenue from a wood products store, and contributions from private groups and individuals.

Among the features of the main exhibit building is a 54-foot "talking tree" which is electronically rigged with 25 miles of concealed wire. The talking tree re-enacts the growth cycle of plants in nature.

The Portland District Council of Carpenters is especially proud of the Colonial Room, which can be viewed from outside the exhibit building through windows.

The room features a beautiful Oregon myrtlewood table which won a 1905 Lewis & Clark Exposition prize. It was donated to the Western Forestry Center by the District Council.

Willie Grawe, Portland, a member of Millmen's Local 1120, restored the table.

The rotunda of the main exhibit building is eight-sided, surrounding the talking tree. The rotunda stretches 70 feet to a sky-lit dome and features eight pillars.

Functional, large models of a plywood plant, a paper mill and a sawmill are housed in 10-foot-tall A-frames on the balcony floor. Moveable machinery, odors, sounds and a narrator's voice are all synchronized.

Continued on page 31

Robert Hogg, Local 226 and a foreman for Henry M. Mason Co., works on the "talking tree."



"We Congratulate..."

... those members of our Brotherhood who, in recent weeks, have been named or elected to public offices, have won awards, or who have, in other ways, "stood out from the crowd." This month, our editorial hat is off to the following:

SCHOLARSHIP—Local 261 in Scranton, Penna., and the Scranton Builders Exchange, an organization of about 40 contractors and subcontractors, have recently announced the selection of Miss Ann Clark, a music major at Marywood College, as the first recipient of their co-sponsored \$1,000-a-year college scholarship, the first such grant made by a local union in the Scranton area. According to representatives of Local 261 and of the Exchange, it is planned that from now on at least one scholarship per year will be granted to a student studying in the Scranton area. Each grant will consist of \$1,000 per year, for a period of four years.

Funds for the scholarships are provided through the Carpenters' Educational Fund, founded by retired Local 261 business representative Joseph Bartell. Initially begun as an internal fund to finance advanced study and training for apprentices, the Carpenters' Educational Fund is maintained by the contributions of the members of Local 261 and by those of the Scranton Builders Exchange. At present, the fund is jointly administered by Charles Pamela, Local 261 business representative, and by Michael Cestone, secretary of the Exchange.

Although the fund is still being used for its original purpose, a proposal was made two years ago that it be extended to help defray the cost of attending college for the children of Local 261 members. Thus, the scholarships are now available to the sons and daughters of union members. Recipients have the option of applying the grant to Marywood College, the University of Scranton, Keystone Junior College, or the Dunmore branch of the Pennsylvania State University.

Mr. Pamela explained that the four schools were selected by the union to participate in the program because of their contribution to the economic development of the area encompassed by Local 261. Selection of the scholarship recipient is made, on the basis of academic merit, by a panel of administrative representatives from each of the participating colleges. The scholarship winners are now attending classes.



OUR ERROR—We published the picture above in the July, 1971, issue of *The Carpenter*, identifying the man standing in front of Baker Hall as Gen'l Rep. J. E. Sheppard. Actually, it's Paul Baker, business representative of Local 1725, Daytona Beach, Fla., for whom the building is named. Baker Hall is a new structure on the campus of Daytona Beach Junior College, named for Brother Baker in recognition of his 12 years of service on the advisory board of the college and his work in area construction. Gen'l Rep. Sheppard was official International representative at dedication of the building but is not in the picture.

PROJECT IN JAMAICA—Alex Beverly, former head of the carpentry shop at George Brown College and a retired "life member" of Local 27 in Toronto, Canada, has recently departed for Jamaica, where he will assist in building a nursery school and model playground. Beverly, 73, and six students from Cen-

tennial College are participating in the Knox International Work Camp, a joint project organized by Centennial and Operation Beaver, which has been responsible for initiating many community-aid work camps throughout Canada and abroad. Beverly will be working on the project with Canadian, American, and West Indian students.

MUSEUM AID—Approximately 20 members of Local 533, Jeffersonville, Ind., recently volunteered their services to replace the fire-damaged roof of the Howard Steamboat Museum in Jeffersonville. The cost of repairing the old mansion was initially estimated to be in the thousands of dollars, but the carpenters completed the job in two weekends at a cost of approximately \$450. Lumber for the project was provided by the Russ Lumber Company at cost. In appreciation for their volunteer efforts, the members were presented with a certificate of commendation by the museum's board of directors.

BRONZE STAR—Army Private First Class Kenneth J. Kellerman, a member of Local 1175, Kingston, N.Y., was recently awarded the Bronze Star for heroism on the field of battle in Vietnam. Private Kellerman received the award while assigned as an assistant gunner with Company C of the 7th Cavalry, First Cavalry Division.

The citation accompanying the award notes that on April 14, 1971, Private Kellerman's unit, stationed near Bien Hoa, became engaged with "a determined enemy force." As described by the citation: "With complete disregard for his own safety, Private Kellerman exposed himself to the intense hostile fire as he moved forward to the point of heaviest contact and began placing heavy volumes of suppressive fire upon the insurgent forces. His actions were an inspiration to the other members of his unit and were instrumental in the successful completion of the mission."

Upon his induction into the service in December, 1970, Private Kellerman was a third-year apprentice with Local 1175.

SCHOLARSHIP—Vicki Lynn Wojcik, 17, daughter of Henry J. Wojcik, a member of Carpenters Local 141 Chicago, is recipient of a \$500 college scholarship. She is a graduate of Barrington Consolidated High School, Barrington, Ill., and will attend the University of Illinois, Champaign - Urbana Campus.



Miss Wojcik

The grant, named for the late John Fitzpatrick, onetime president of the Chicago Federation of Labor, is donated annually by the Chicago Federation of Labor and Industrial Union Council.

C. J. Haggerty Dies, Led Building Trades



C. J. Haggerty

Cornelius J. (Neil) Haggerty, who headed the California State Federation of Labor and later the AFL-CIO Building and Construction Trades Dept. in a 43-year career of trade union leadership, died at his home near Los Angeles, Calif., recently after a long illness. He was 77.

AFL-CIO Pres. George Meany and Sec.-Treas. Lane Kirkland called the late Building Trades leader "a true friend, a fine gentleman and one of the most dedicated and devoted trade unionists of our time."

Haggerty was a vigorous and influential head of the building trades department from 1960 until May 6, 1971, when he retired after 56 years of labor activity in Boston, Los Angeles and Washington., D.C.

Born in Boston into a family of 17 children, Haggerty was 21 when he got a job in the construction industry and joined Lathers Local 72. Six years later he moved to California and transferred to Lathers Local 42, Los Angeles.

His talent for leadership and persuasion led him up the ladder of union responsibility. He was elected business manager of Local 42 in 1928, vice president of the Lathers international union a year later, secretary of the Los Angeles Building & Construction Trades Council in 1933, a vice president of the California AFL in 1936, then successively president of the State AFL, secretary-treasurer of the same body, first vice president of the Lathers, secretary-treasurer of the merged State AFL-CIO, and finally president of the AFL-CIO Building & Construction Trades.

When the department's executive

Continued on page 39

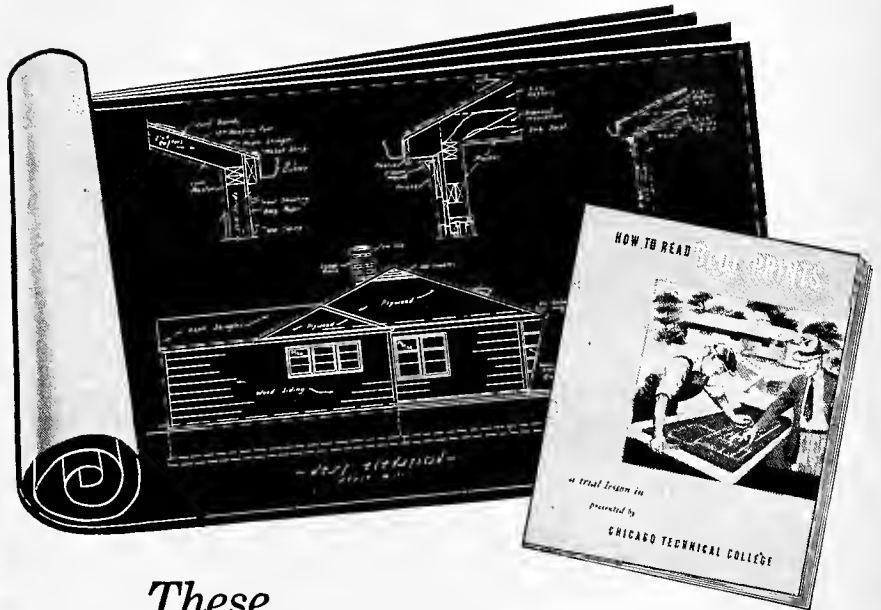

These **FREE BLUE PRINTS** *have started thousands toward* **BETTER PAY AND PROMOTION**

That's right! In all fifty states, men who sent for these free blue prints are today enjoying big success as foremen, superintendents and building contractors. They've landed these higher-paying jobs because they learned to read blue prints and mastered the practical details of construction. Now CTC home-study training in building offers you the same money-making opportunity.

LEARN IN YOUR SPARE TIME

As you know, the ability to read blue prints completely and accurately determines to a great extent how far you can go in building. What's more, you can learn plan reading simply and easily with the Chicago Tech system of spare-time training in your own home. You also learn all phases of building, prepare yourself to run the job from start to finish.

CASH IN ON YOUR EXPERIENCE

For over 67 years, building tradesmen and beginners alike have won higher pay with the knowledge gained from Chicago Tech's program in blue print reading, estimating, foremanship and contracting. Through step-by-step instruction, using actual blue prints and real specifications of modern, up-to-date buildings, you get a practical working knowledge of every building detail—a thorough understanding of every craft. And as a carpenter or apprentice, you already have valuable experience that may let you move up to foreman even before you complete your training.

Don't waste a single day. Start preparing right now to take over a better job, increase your paycheck and command greater respect as the "boss" on the job. Find out about Chicago Tech's get-ahead training in building. Send for your free blue prints and trial lesson—today! Approved for Veterans.

CHICAGO TECHNICAL COLLEGE

P-143 TECH BLDG., 2000 S. MICHIGAN AVE., CHICAGO, ILL. 60616

FREE BLUE PRINTS AND TRIAL LESSON

Send for your free trial lesson now. You'll agree that this training is simple yet practical—your surest way to promotion and increased income in building.

MAIL COUPON TODAY

Chicago Technical College
P-143 Tech Bldg., 2000 S. Michigan
Chicago, Illinois 60616

New G.I. Bill!
Vets check here

Please mail me Free Trial Lesson, Blueprints and Catalog.

Name _____ Age _____

Address _____

City _____ State _____ Zip _____

Occupation _____

Accredited Member National Home Study Council

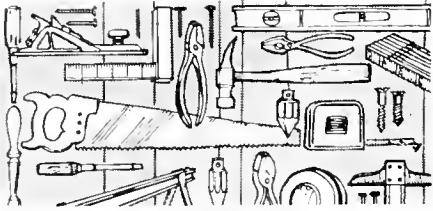

LOCAL UNION NEWS

Local 1765 Members Prime Movers for Osceola Children's Home

Osceola County, Fla., was faced with a great need for a parental home for juveniles. A group of women in the Orlando area formed an organization called CHACO (Children's Home Action Committee) to meet the need, and they called on union labor for support. Members of Carpenters Local 1765, led by Business Agent Bill Wilson, rose to the challenge. They enlisted other building trades and obtained donations of building materials and erected a spacious, comfortable building. The local union even donated more than \$12,000 worth of building materials itself.

The new home for children is now occupied by more than two dozen happy children, thanks to Brotherhood members and their fellow trade unionists.



A view of the Osceola Children's Home as seen from the entrance. The home is located in Orlando, Fla., and was built by union labor.



Some of the Osceola county children cared for in the home soon after its official opening. The pony and burro are permanent residents also.

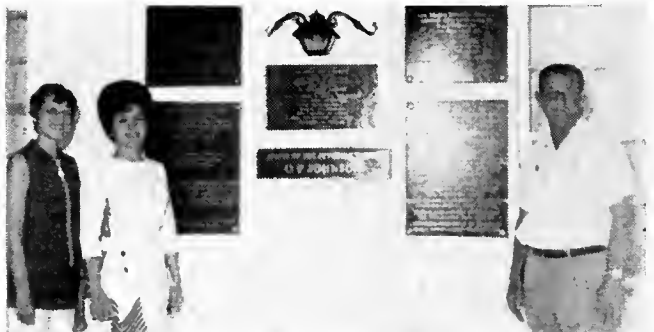

Mrs. Ernie Tolman and Mrs. Bobbie Gant, members of the board of directors of the home, with Bill Wilson at the entrance to the new facility.

First 'Out-State' Offices for St. Louis District Council



Dedication ceremonies for the first out-state headquarters of the Carpenters' District Council of Greater St. Louis, were recently held in Union, Mo. Council delegates and members and officers of Carpenters' District Locals 2571 and 1839, who will use the new facility attended the ceremonies. The District Council moved its regular meeting to Union, Mo., in honor of the event.

Fleetwood Organizing



Kenneth L. Wade, business agent of Local 340, Hagerstown, Md., with Tom Johnson and Int'l. Rep. Herbert Thomas during an organizing drive at a Fleetwood Homes plant near Rocky Mount, Va.



Int'l. Rep. Thomas with assistant managers of the plant. (Since the pictures above were taken, the Union has been recognized as bargaining agent, and negotiations are now under way.)

Service To The Brotherhood



At a special meeting held on June 21, 1971, 20 members of Local 2190, Harlingen, Tex., were honored for their 25 years of service. Seated here, from left, are Paul Allen, R. A. Rodriguez, Joseph Nesetril, and H. E. Dunn. Standing, from left, are E. T. West, Fidel Marino, A. V. Martiniz, and P. V. Martiniz. Not pictured, but also receiving service pins, were C. J. Duncan, David Noser, L. W. Danz, F. E. Lee, Ruban Flores, H. E. Means, E. M. Allbee, A. A. Free, Ross W. Neal, Corda Harvey, R. L. Parker, Ambrosio Peralez, and Tomas Rodriques.

PERFECT GIFTS FOR TRUE CRAFTSMEN



Estwing

**SUPREME
HAMMER**
E3-16
16 oz.
only
\$7.30

**WORLD'S FINEST
NAIL HAMMER**

• Forged One Piece Solid Steel • Strongest Construction Known • Unsurpassed Estwing Temper, Balance and Finish • PLUS . . . Exclusive Nylon-Vinyl Deep Cushion Safe-T-Grip . . . Molded on Permanently . . . Can't Loosen, Come Off or Wear Out.

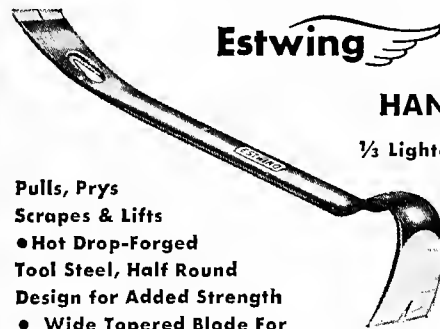

Estwing

HANDY-BAR

1/3 Lighter—But Stronger

Weight - 18 Oz.
Length - 15"
No. HB-15
\$2.98
List

Pulls, Prys
Scrapes & Lifts
• Hot Drop-Forged
Tool Steel, Half Round
Design for Added Strength
• Wide Tapered Blade For
Mar Proof Prying and Easy Nail Pulling

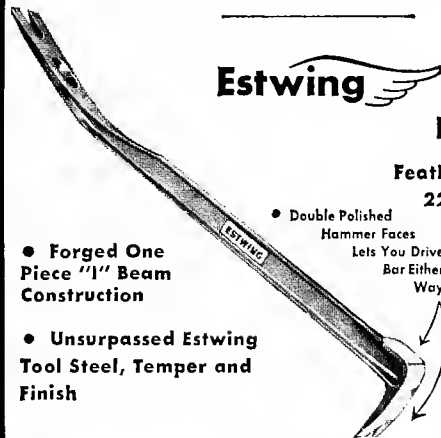

Estwing

PRY-BAR

Featherweight - only
22 Oz. Length 18"

No. PB18
\$4.40
List

• Forged One
Piece "1" Beam
Construction

• Unsurpassed Estwing
Tool Steel, Temper and
Finish

• Double Polished
Hammer Faces
Lets You Drive
Bar Either
Way

**FOR ALL
PRYING AND
PULLING**

FOR SAFETY SAKE—

Always wear Estwing Safety Goggles when using hand tools—protect your eyes from flying splinters, chips, fragments, dust, etc.

If Your Dealer Can't Supply You with Estwing Tools—Order Direct. Send Check or Money Order for Prepaid Shipment.

Estwing

MFG. CO. DEPT. C-11

2647 8th STREET

ROCKFORD, ILLINOIS 61101

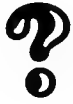

What Am I?

NO ONE has a good word for me, but I am tolerated everywhere. I am found in the palaces of the rich and in the hovels of the poor. I am thoroughly evil, but I have adherents even among the righteous. I cause hunger and want and open the way for pestilence and famine. I benefit no one, and injure all with whom I come in contact. I thrive on the indifference, ignorance and apathy of the people.

BECAUSE OF ME notions topple and fall. I am the partner and associate of political corruption and decay. In time of war I undermine defense and cause battles to be lost. I sap the life blood of the nation and leave her open to despoilers. Though I handicap and hinder the valiant defenders of the nation, there is no uprising against me. I am a traitor and saboteur, but I am found in every department of government.

I TAKE MUCH and give nothing of value in return. I consume and destroy the fruits of the industrious and de-grade the poor. I lower the standard of living, for I reduce production. I cause contempt for the law because of my prevalence in government. I weaken and injure mankind, but strangely, it does not vigorously and increasingly fight me.

NOW I should and could be destroyed, but I thrive as never before. I am an enemy of civilization.

I AM WASTE

- ✓ WASTE of MONEY
- ✓ WASTE of MANPOWER
- ✓ WASTE of SUBSTANCE
- ✓ WASTE of LIFE
- ✓ WASTE of TIME
- ✓ WASTE of NATURAL RESOURCES.

Reprinted by permission of the Florida Taxpayers Assn. Inc.

Alfred Eaton Honored, Local 111



Local 111 of Lawrence, Mass., recently paid tribute to the years of faithful service rendered by its recording secretary, Alfred Eaton, a 50-year member of the Brotherhood, for the last 47 years has served as the recording secretary. A resolution and an appropriate plaque were presented to Brother Eaton, as shown above. Left to right are Alphage Picard, president; Alfred Eaton, and Richard Croteau, business agent.

Two Catches For Apprentice Fuchs



Steve picks a wife and the wife picks the fish. Apprentice Steven Fuchs of Local 1426, Elyria, O., went south with his bride Cathie for their honeymoon. A 276-pound hammerhead shark, nine feet four inches long, wouldn't fit into most honeymoon plans, but it did for Steve and Cathie. Cathie fought the shark for an hour after hooking it while trolling between Miami and Fort Lauderdale May 25.

SHEATHING BROCHURE

"Plywood Sheathing for Floors, Walls and Roofs," is described in a new 20-page brochure from the American Plywood Association.

In the plywood for roof decking section, building code requirements, installation instructions plus steel framing connecting details are featured.

The booklet also includes species and grade guide tables which have been updated plus a guide chart and an identification index for engineered grades of plywood.

In addition to diaphragm construction and preframed panels for roof decking, the brochure includes charts, illustrations and information on plywood for wall sheathing and shear walls.

Current information on plywood floor systems, fire resistant plywood construction and a special section on glued floors with two new span tables are included in the contents of the brochure.

Also added to the text is material on wheel loading and wind uplift tests.

A free copy of "Plywood Sheathing for Floors, Walls and Roofs" can be obtained by writing the American Plywood Association, 1119 A Street, Tacoma, Washington 98401. Please request Form S71-30.

CONCRETE-FORM BROCHURE

"Plywood Concrete Forms" brochure has been updated and expanded by the American Plywood Association.

A new grade use guide has been added to the 4-page brochure which includes charts on suggested design pressures for vibrated concrete and a set of load span curves which provide span thickness recommendations.

Described in detail in the pamphlet is Plyform, an Exterior type plywood manufactured specifically for use in concrete framework and available in two grades—Class I and Class II.

Though Plyform Classes I and II vary in strength and stiffness to meet with requirements of both simple and complex concrete forms, both come in lightweight, easy to work and handle panels which are edge-sealed and face-oiled for moisture protection.

Properly handled, Plyform panels which produce fin free concrete surfaces, can be reused as many as ten times.

For all this information plus instructions for the care and handling of plywood forms, send your request for a free copy of "Plywood Concrete Forms" to the American Plywood Association, 1119 A Street, Tacoma, Washington 98401. Please specify Form S71-90.

Substitool.

The new Skil Tradesman's Program: if one of your Skil tools breaks down, you can use one of ours free.

From now on, when you buy a Skil Tradesman's tool and it goes down, you get another like it to use while yours is being fixed at your nearest Skil Service Center.

Usually, they can do the job while you wait. But if they can't, you get a service replacement tool to keep you going until yours is ready.

A Registration Card now comes with all the tools in the program. Just fill it out and send it in. Once you're registered, you're covered. And all the Skil tools you use the most and the hardest are included.

As a member of the Tradesman's Program, you get a special Tradesman's identification card. And a free personalized label for your Skil tool.

Also, you're eligible to apply for credit so you can even charge service. So that's it—get Skil and you've always got tools. Is it a deal?

Please send me details of the Substitool™ Program and a free Tradesman's catalog.

Name _____

Address _____

City _____ State _____ Zip _____

Mail to: Skil Corporation,
Dept. CA11, 5033 Elston Ave., Chicago, Ill. 60630.

SKIL®

Nobody was ever sorry he bought the best there is.



1



2



3

St. Louis 'Consumercare' Bus Reaches Carpenter Consumers

■ As a unique public service, the Carpenters' District Council of Greater St. Louis, Missouri, recently sponsored a special project of the Better Business Bureau's Consumercare Bus.

The bus, which is the Better Business Bureau's portable branch office, visited six suburban shopping centers to meet with union members, their families and the general public.

Also, the bus visited a Carpenters' steward meeting and a regular Council delegate meeting. At both meetings, a BBB representative presented a film and answered questions regarding the activities of the Bureau and the various swindles perpetrated on innocent victims.

The BBB bus is equipped with films, slides, booklets and a two-way telephone for contacting the BBB's main office. It is staffed by BBB experts who are able to answer consumer questions on the spot and inform the public on how to avoid gyps in their everyday purchases.

"We are pleased to sponsor this bus in the interest of informing the public about problems they face every day, problems ranging from door-to-door salesmen, home buying and remodeling, auto buying and repairs, credit, and a hundred other items," Ollie W. Langhorst, executive secretary-treasurer says.

He added that "it only takes a minute to sign your name on a contract, but it may take years to pay for just one mistake. We hope this can help someone avoid that mistake." ■

1

DISCUSSING SWINDLES that many people fall prey to is Gene Phelps, assistant to the president of the St. Louis Better Business Bureau, at left. He is talking to shop-steward members of the Carpenters' District Council of Greater St. Louis. Continuing around from left to right: Joe Heutel, Local 1739; Gerald West, Local 73; Gus Utolf, Local 1739; Lee Pender and Ed Fischer, Local 1596; H. V. Saladin, Local 602; Ben Holthaus, Martin Kirn and Virgil Smith, Local 73; Ancil McCarter, Local 417; Aaron Turnbull and Norman Barth, Local 1596 (partially hidden) and CDC Business Representative Mike Heilig. The group is inside the BBB's Consumercare Bus, its portable "office on wheels."

2

CAUTIONING CARPENTERS to read a contract before they sign it is Gene Phelps, assistant to the president of the St. Louis Better Business Bureau, talking to more than 100 shop stewards at a meeting of the Carpenters' District Council. At left, Council Executive Secretary-Treasurer Ollie Langhorst and Council President Norman Barth, center.

3

HEARING ABOUT THE CONSUMERCARE PROGRAM of the Better Business Bureau and its work in exposing hoaxes such as those in the wig business are these members of Carpenters Ladies Auxiliary No. 23. From left: Mrs. Dorothy Mitchell, Mrs. Ollie Langhorst, BBB's Membership Representative Bill Habn, Mrs. Michael Heilig and Mrs. Pleasant Jenkins.



1



2

SERVICE TO THE BROTHERHOOD



A gallery of pictures showing some of the senior members of the Brotherhood who recently received 25-year or 50-year service pins.

(1) PHOENIX, ARIZ.—Local 1089 recently awarded 25-year membership pins and one 50-year pin. Among those honored were (first row, from left) Fayburn Johnson; Ralph Ellison, business representative; John Duer, Clifton Boyer, Ben Futrell, Cecil Fry, C. E. Cook; Gus Wolfe, who received the 50-year membership pin; Gilbert Fluhrer, L. B. Heffing, J. L. Enloe, and Walter Johnson. Pictured in the second row, from left, are Robert Eager, Robert Hiskey, F. C. Bailey, Edgar

Judd, E. C. Kramer, Joseph Hough, Milton Clauer; O. F. Koons, apprentice coordinator; Virgil Haag, H. L. Baldwin, Seth Hughes, John Goldsbury, Woodrow Humphrey, Jess Duran, and Leroy Burris. Seen in the third row, from left, are John T. King, G. C. Hester, H. A. Crum, W. R. Ganis, Frank Hayes, L. C. Hawkins, P. B. Hernandez, L. D. Kirkpatrick, F. B. Geminhardt, C. C. Brown, Bernard W. Estep, Earl J. Kurtzman, Bryan Fitts, William C. Christian, H. A. Johnson.

(2) Due to the great number of 25-year pin recipients, Local 1089 held two separate ceremonies. Also being honored for their 25 years of service were (front row, from left) Earl L. Morrow, L. C. McAdoo; Roy Longshore, trustee; Leslie Millsap, E. M. Parker, Reda Price, Harry Walker, C. S. Scotten, L. O. Leatherwood, and W. L. Robinson. Standing in the second row, from left, are Mark Minor, J. P. Westbrook, Alva Long, D. K. Porter, Henry C. Stieglitz, G. W. Hawkins, J. B. Porter, W. E. Parker, Ellis Tacke, H. N. Simons, Delbert Whitmer; James McGee, vice-president; Harry Mallory, recording secretary, and Al M. Sutton. Pictured in the third row, from left, are James F. McLaughlin, Rex L. McCarty, H. W. Martin, J. M. McKinney, C. E. Hall, Archie Wester, D. K. Terry, Raymond R. Powell, Nathan Yarbrong; L. R. Petty, former apprentice instructor for 20 years; W. O. Thompson, and John A. Slaughter.



3

(3) MADISON, WIS.—A 50-year pin was presented to William F. Wagner at a meeting of Carpenters Local 314 on April 28, 1971, by Kenneth Fischer, president of the local union.

SERVICE TO THE BROTHERHOOD



A gallery of pictures showing some of the senior members of the Brotherhood who recently received 25-year or 50-year service pins.



1

(1) CINCINNATI, OHIO—On May 14, 1971, Local 739 paid tribute to its members with 25 or more years of devoted service. Those present to receive service pins were, seated from left, John Bergen (29 years); Russell Waters (27 years), treasurer of Local 739; Dennis Schare (25 years); Casper Kramer (29 years); Milton Jamison (26 years); Arthur Saverwein (26 years); and Harold Freytag (26 years). Standing, from left, are Joseph Beck (25 years); Owen Snell (25 years); Earl Zimmer (25 years); Elder Wiesman (26 years); Harold Seim (25 years); Robert Rittmeier (26 years); Floyd Carleton (25 years); and John Wagner (26 years), warden of Local 739.



2

(2) Local 739 also honored many members who had compiled over 30, 40, 50, and even 60 years of service. Seen here, seated from left, are Harry Dastillung (55 years); Fred Mueller (36 years); Charles Whited (37 years); Theo Klett (61 years); Joseph Kramer (55 years); Daniel Kammer (48 years); Walter Gabel (34 years); and Fred Fritz (48 years), financial secretary. Standing, from left, are Elbert Aston (54 years), president; William Dempster (54 years); John Rinckel (48 years), trustee; Melvin Yorgin (35 years); Oliver Huy, Sr. (36 years); Arthur Schwierking (44 years), trustee; Theo Lutterbei (48 years); Robert Vogel (47 years); Stanley Geiser (41 years); Fred Finke (57 years); and Nelson Urban (32 years), vice-president. Among those also receiving service pins, but who were unable to attend, were Jacob Bernhardt (50 years); Charles Boys (29 years); Harold Harris (45 years); Vess House (49 years); Wilbur Jasper (25 years); Louis Kramer (49 years); William Squires (35 years); Russell Van Pelt (35 years); John Pfaltz (49 years); and Joseph Wiesman (53 years). Brother Bob Sauer was to have acted as master of ceremonies at the awards presentation banquet but, due to the passing away of Mrs. Sauer, was unable to attend.

(3) Theo Klett is presented with a service pin in honor of his 61 years of loyal service as a member of Local 739.



3

(4) MIAMI, FLA.—On March 5, 1971, Local 1509 had a 25-year pin presentation. John E. Sheppard, international representative, was on hand to make the presentations. Among those present for the awards ceremonies were (front row, from left) C. Blackmer, R. Hilliard, F. Baxley, Jr., F. Laino, D. Sweat, and L. Kahara. Standing in the second row, from left, are William White, president of Local 1509; Paul McKenna, Robert Bedenbough, Alfee Bouchard, R. Gregory, and Int'l. Rep. Sheppard.

4





CANADIAN REPORT

Layoffs by Multinational Corporations Affect Current Unemployment Situation

Unemployment seems to be heading toward a chronic condition in the Canadian economy. So are price increases.

The situation where both unemployment and prices are both rising is such an unusual one that some wags have come up with a new name for it—"stagflation".

The blame for this economic disease has been attributed to many factors, depending on the viewpoint of the analyst, but three of them are current: First, the mistaken policies of the federal government which worried too much about inflation and not enough about joblessness. Second, the effect of multinational corporations in plant shutdowns. Third, the latest phenomenon, Nixonomics, policies to correct domestic ills which are having worldwide repercussions.

The federal policies have been criticized before in these columns. Trade union leaders in Canada have said about all that can be said in public on the subject.

But some groups in Canada are inclined to put even more of the onus for unemployment on multinational corporations which play a dominant role in many areas of the Canadian economy—mining, autos, rubber, chemicals, oil—to name the most important ones.

Some, but not enough, research has been done to prove conclusively that these corporations rather than government policies are most to blame for the high rates of joblessness in many parts of the country. It could well be a combination of both.

In late September General Motors of Canada laid off about 2,000 employees in Ontario and Quebec to add to the problems. Was this the result of a selfish decision by a multi-

national corporation or of an economic situation including the importation of foreign made cars?

The Toronto Telegram had no trouble assessing the blame. This paper, one of Canada's largest dailies (which incidentally is going out of business) blamed the unions who have demanded and won the same wage scales at GM in Canada which employees get in the United States, thus making Canadian-made cars less competitive.

The fact that GM is today making three cars for every two they used to make with the same number of workers is a fact of no importance to the Tely and other conservative spokesmen.

To try to arrive at some constructive answers to the question, the federal government itself set out to study one area in particular which has had heavy unemployment for the last decade.

This area is Cornwall, Ontario, which experienced a boom during the construction of the St. Lawrence Seaway. The small city expected it would continue to grow with the opening of the seaway, but it didn't. 20 percent unemployment this year is proof enough.

Eight research and management experts studied this city of 47,000 and discovered that 13 of 18 companies had non-resident ownership.

Then most of the land around Cornwall suitable for industrial development was owned by people in Montreal, Ottawa, Hamilton, New York, Los Angeles and so on.

These owners had little interest in the welfare of the community. Their only interest was land speculation.

Incidentally the building trades in the city have been particularly hard

hit. Their membership increased substantially with the seaway construction, but nothing has happened since to maintain the work force. Land speculators don't help.

Another problem for Cornwall is the high trucking rates to its main market, Montreal. It costs far less to ship to and from Toronto, 264 miles away, than to and from Montreal, 79 miles away.

Then the surcharge on exports to the U.S. A lacrosse stick factory in the city closed down. Management said that with the new 10 percent export cost, its wooden sticks could not compete with the plastic sticks made in the U.S.A.

Now that the study has been made, what happens? Both the federal and provincial governments have incentive programs, but obviously neither of these has helped Cornwall. Nor a dozen other areas like Cornwall.

Said Ontario's Premier Davis: "The economy is troubled. Let's not kid each other."

Who's kidding who?

Labor Alert To Wage And Price Restraints

Canadian trade unions, like organized labor in the United States, were stunned by the recent actions taken by U.S. President Nixon, and both reacted in much the same way, if not altogether for the same reasons.

Heavy unemployment in both countries is a serious concern and trade union leaders on both sides of the border have had to make some fast decisions on Nixon policies which have far-reaching, worldwide ramifications and which may be long-enduring.

Canadian unionists have been on the alert for some time. The federal government over a year ago tried to effect voluntary wage and price restraints which Canadian labor saw as irrational policies to control a grossly-exaggerated inflationary situation.

As time went by, the position taken by Canadian labor was proved correct. The wage-price restraint policy didn't work in any positive way, but it did have the effect of increasing unemployment substantially.

Just as this tragic result was having its full impact on public opinion and the government was being forced to realize that its cure was worse than the disease, that real unemployment is worse than the imagined inflationary crisis, the Nixon policies were announced.

Continued on Page 22

As some pundits said, it is a new ballgame.

On the issue of wage and price controls, there seems to be little difference between the views of trade union spokesmen in Washington and those in Ottawa.

But the Nixon policy of 10 percent surcharge on imports is of course a major concern in this country.

Canada and the U.S. are among the world's leading trading partners. Canada is heavily dependent on exports and about two-thirds of our exports are to the United States.

Fortunately many of our exports are being excluded from the surcharge. But the exclusions are for the most part natural resources like petroleum and minerals while more labor-intensive industries like manufacturing will be hit by the surcharge.

How badly hit only time will tell, but in the meantime the federal government is putting up \$80 million to use as a buffer in those industries which will be hurt first and most.

Most economists here think that the Nixon measures are tolerable in the short run, and might even be helpful if they achieve their objectives in relatively short order.

But an expert economic analyst like Alan Beckett who writes a *Monthly Business Analysis* sounds a little pessimistic.

"The 90-day wage and price freeze," he says, "will at best delay September price increases to December. The pages of economic history are strewn with the wreckage of income policies and voluntary price controls that failed . . ."

And, he adds, if the import tax is maintained very long, it will generate a substantial reduction in world trade. If this happens, none will benefit.

Trudeau Statement On 'Employes'

The United Church Observer has quoted Prime Minister Trudeau as saying that a) a healthy young man should not receive welfare from society as long as jobs are available and he is capable of work; b) if society cannot provide a man with a job, "we should take care of him, because society is responsible for its social organization, and if it can't find the wherewithal for men to be gainfully employed, then it should pay the penalty and give them welfare."

This is an important statement from

the head of state, and probably the philosophy both behind the controversial Opportunity for Youth program which the federal government funded this past summer, and its expansion of the unemployment insurance principle.

But it does not explain the Prime Minister's refusal thus far to support the guaranteed income idea.

Nor does it explain the lack of a firm policy on full employment by the Trudeau government.

It is even harder to explain a popular view, held by most municipal officials especially, that men should work for relief.

The latest study done on unemployed men called "Men on Relief" by the Canadian Council on Social Development, showed once again that most men defined as "employable" by public welfare departments, lack education, skills, savings, and are seldom entitled to unemployment insurance.

The study was done in Edmonton, Winnipeg and Ottawa, and covered 440 unemployed men between the ages of 30 and 45.

The Council says that the new unemployment insurance regulations will help some of these men, and more counselling and training would help others.

But even if these things were done, "such a service is unlikely to achieve lasting benefits in the absence of nationwide policies of high employment, and if need be, the creation of job opportunities that go beyond the traditional labor market."

Master Agreement Signed in Manitoba

Six building trades unions in Manitoba signed a multi-trade agreement which will provide uniform pay increases and working conditions to its members.

The unions include the carpenters, painters, insulators, plasterers, laborers and sheet metal workers.

According to the statement from Winnipeg, this was the first time that a master contract has been negotiated with the Builders Exchange.

The contract, which ended a three-week strike, covers about 3,500 union members and 133 construction employees.

The settlement is for a \$1.10 an hour increase over 18 months. It covers construction within 30 miles of downtown Winnipeg and major rural projects.

1,200 Jobs Lost In Toronto Shutdown

The closing down of *The Toronto Telegram*, one of Canada's largest dailies, will affect more than the 1,200 employees who worked for the paper.

The majority of the employees were members of the Newspaper Guild or the printing trades unions, which were in process of bargaining with Tely boss John Bassett when he announced the closedown.

Also affected will be workers in the paper mills which supplied the Tely with over three million dollars worth of newsprint a year, *Week-end Magazine* which supplied a Saturday insert for the paper, hundreds of newshoys and others.

The Guild had a good severance pay clause—one week's pay for every five to six months' employment—and many of the newspaper's employees will get at least three months' severance pay. But the shutdown came as a shock to many longtime, devoted staff people who are accepting the fact as a bad dream rather than a harsh reality.

Winter Forecast: More Unemployment

Everyone agrees that unemployment will be worse again this winter.

The NDP minister of labor in Manitoba, Russ Paulley, is asking the federal government to support an eight-point program to stimulate the economy.

The proposals include a massive public housing and urban renewal program; expanded anti-pollution programs; more construction of public facilities; tax relief for lower income groups; more funds for aid for children and elderly and public health measures; aid to public transit systems; and more help for farmers.

Record Collection Of Taxes This Year

In the first six months of this year, Canadian governments at all levels collected a record \$21.4 billion in taxation, and it is expected that, if no serious, unexpected setback occurs, the total will reach \$42.5 billion for all of 1971.

This would be 46 percent of the country's total production of goods and services.

Avoid Blood Poisoning From Rusty-Nail Wounds

BY DR. W. SCHWEISHEIMER

WANTED

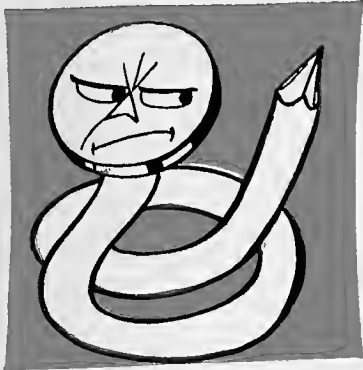

For causing bodily injury on the Job

A very dangerous cuss. Sneaky and always ready to stab you in the back.

HANDLE WITH CARE

■ "Look out!", shouted the foreman. But it was too late; the carpenter had stepped on a board with nails in it. One of the nails punctured his shoe, as well as his foot. There was a little blood, but the pain disappeared after a few minutes. He forgot all about the wound.

The nail was rusty and, with the rust, a number of germs had invaded the wound. Those germs may get into the blood vessels from an infected wound. In the blood they are carried to other areas of the body.

A few days later the lymph glands in the carpenter's groin were swollen and sensitive to the touch. Pinkish red lines could be seen along the path of an inflamed lymphatic vessel on his leg and thigh. He had some fever and pain at the point of injury, though the little wound seemed to be closed.

It was high time that he stopped running around. The doctor told him to lie down and keep quiet. Foot and leg were resting in a somewhat elevated position. The use of wet dressings to the wounded foot and along the course of the inflamed lymph vessels helped to localize the infection and brought quick relief.

This carpenter was lucky. After a few days the fever, the red spots, the streaks and all other signs had disappeared. It was not even necessary to reopen the slightly infected puncture wound.

Septic Injuries

Not every industrial worker is as lucky as that. Every year thousands of industrial injuries become "septic," producing a serious condition. Your body is able to destroy most of the germs which invade it, and wall off the infection in such a fashion that it becomes harmless. When, as a result of a dirty wound or other kind of infection, bacteria or their poisons, or

both, are circulating in the blood and give rise to fever and other symptoms, the condition is popularly called blood poisoning. The fever may be moderate or it may be very high, up to 105° F.

What is the best local treatment for a puncture wound of the sole of the foot by a rusty nail to avoid complications?

Step-By-Step Action

Let us suppose, the nail entered to a depth of a quarter of an inch and no complications have set in. Dr. Bowen, a surgeon, recently has recommended the following treatment.

1) The foot is to be soaked for 15 to 30 minutes in hot water to which tincture of soft soap is added—or ordinary toilet soap if you don't have tincture of soap at hand.

2) It is dried carefully, and an area about 2 to 3 inches in diameter around the wound is painted with an antiseptic such as tincture of iodine.

3) The top layer of the skin is cut away around the wound. In this way you will see any foreign matter (usually sand, rarely particles of sock, leather, rubber or concrete) which can be removed easily.

4) A dry dressing is applied.

5) If the wound is caused by a nail larger than a ten-penny nail, the patient should not walk for at least one or two days. If, however, a nail of lesser diameter has caused the wound, he may walk at once.

An open wound presents an easy entrance for an invasion of germs or bacteria. There are two main groups of wounds—infection bacteria. There are first germs that grow in the presence of air, the usual pus-producing bacteria, most of them either staphylococci or streptococci. There is a second group of bacteria that will not grow in the presence of air. In this second class are the lockjaw or tetanus bacillus and the bacillus of gas gangrene.

Bacteria of the second group are much less common than the pus-producing germs. In many cases it may be indicated to use an injection of tetanus antitoxin after an injury by

The author has spent many years writing on the subject of industrial safety and hygiene, including publication of approximately 40 books on the subject. Dr. Schweisheimer studied in Munich, Vienna, Berlin and New York and was, for 15 years, science editor and medical columnist for a large publishing house in southern Germany.

a rusty nail in order to surely prevent tetanus.

Chills and fever are signs of severe blood poisoning. Frequently the presence of bacteria in the blood can be shown in the microscope. The bacteria-poisons may invade the heart and other vital organs. Fortunately, modern medicine is well prepared to cope with such infections, severe as they may be. Penicillin, aureomycin and other antibiotics are successful in such cases. Sulfa preparations are also helpful in combatting the infection.

Degrees of Infection

There are several degrees of infection from a wound. There is first the cellulitis—an inflammation of the tissues around the wound that shows a tendency to spread. There is second the lymphangitis—which is an acute inflammation of the superficial or the deeper-located lymphatic channels. Here we see the irregular pink, tender, linear streaks extending up the leg or the arm toward the lymph nodes (glands) in groin or armpit. The lymph nodes themselves may be inflamed as well. The blood poisoning proper—the presence of bacteria in the circulating blood—is called bacteremia or sepsis.

Thanks to the great advances in modern medicine and surgery, many industrial workers who have received wounds and injuries while working are alive today while they hardly would have survived a blood poisoning from such injuries in former times.

The same is true for infected war wounds. In World War II, the death rate among wounded soldiers in the American Army was 4.4 percent, while this figure was 8.3 percent in World War I and more than 14 percent in the Civil War. This success was mostly due to the possibility of preventing blood poisoning from infected wounds.

How can we succeed in reducing the number of dangerous blood poisoning in everyday life?

The main factors are improved medical organization in factories and work places as well as rapid transportation of the wounded worker to the hospital. Also useful have been the development and widespread use of new drugs and efficient medical and surgical techniques. Besides the use of antibiotics previously mentioned, the use of blood plasma for transfusions is a remarkable progress in the treatment of dangerous wound infections. And never touch the wound or the part of the dressing

which covers the wound, in giving first aid!

Many thousands of industrial wounds were surveyed recently. The most common germs found were staphylococci. This kind of infection of industrial wounds is common because staphylococci germs are usually present on the worker's skin at the time of the injury.

How often is a rusty nail the cause of an infected wound, and how easily could it be avoided! Boards with nails in them never should be left lying around. They can be handled in three preventive ways. First, you can turn the board nail-down. This, of course, is helpful and good as long as it lasts—but there will always be the danger that the board will be turned up again.

Second, you can put the board away, where others will not step on the nail. However, the nail still will be a potential menace.

Third, the natural thing, the necessary thing, to do is to pull the nail out of the board. This may mean a minute or two of extra work, but it will help avoid a good many cases of infected wounds and the dangerous complication of blood poisoning.

For Sparetime or Full Time Income, There's Good Money In Sharpening



Here's a proven practical way to earn extra dollars in spare time — to develop a money-making repair business of your own. Investment is small. There's no overhead, no stock of goods to carry. No experience needed, no canvassing. You do it with the famous Foley Saw Filer that automatically sharpens all kinds of saws — and the Modern Lawn Mower Sharpener that precision sharpens all types of mowers.

EARN \$3 to \$6 An Hour Sparetime

Hundreds of people like yourself are making cash like this — \$20 to \$30 a week — right now in spare time. "My spare time saw filing business has made me \$952 these first ten months" — says R. T. Chapman. Many have built a complete sharpening service with such year-around profits. You can too, simply by following the sure, easy Foley Plan.



MANUFACTURING CO.
MINNEAPOLIS, MINN.

**GET FREE BOOK NOW
"MONEY MAKING FACTS"**
This valuable book shows you how to start, how to get business from home owners, factories, carpenters, etc., and how to make profits fast. Mail coupon today. No salesman will call.

FOLEY MFG. CO. 1118-1 Foley Bldg., Minneapolis, Minn. 55418

Saw Filer information. Lawn Mower Sharpener information. Money Making Facts booklet.

NAME _____

ADDRESS _____

CITY _____ STATE _____

SERVICE TO THE BROTHERHOOD



A gallery of pictures showing some of the senior members of the Brotherhood who recently received 25-year or 50-year service pins.



1

(1) VINELAND, N.J.—Local 121 recently held a dinner honoring Bertrum Breeden who has served over 40 years as

an officer and member. Over 250 members and friends attended the affair at which Breeden was presented with a gold watch in recognition of his outstanding loyalty and service to the Brotherhood. Presenting the watch to Brother Breeden, left, is Faustino Wulduk, president of Local 121.

(2) At its annual banquet, Local 121 also presented 25-year service pins to deserving members. Seen here in the front row, from left, are Frank Scavelli, Robert Money, Allison Ross, William Bateman, Ralph Quick, and Jack Fowler. Standing in the second row, from left, are Herman Smith, Arthur Ogren, William Mushett, Harry Smith, Joe Speziale, George Nestler, William Barbaecia, and V. Howard Swenlin.

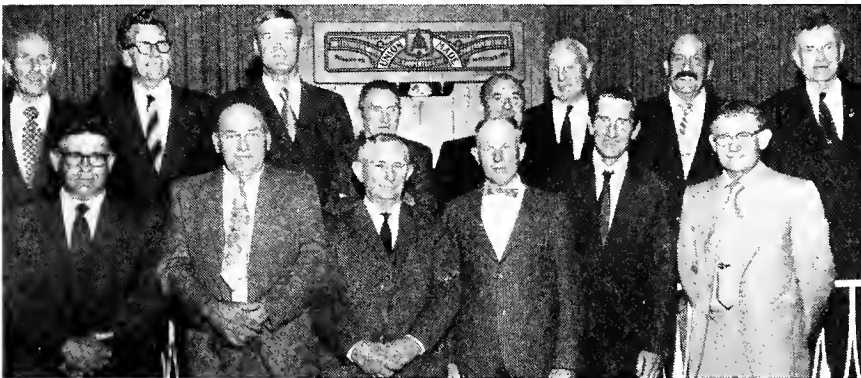

2



3

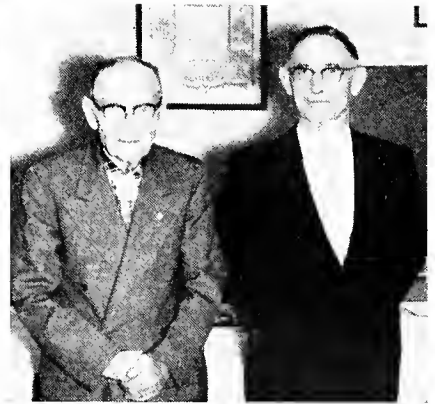

4



5



6

(3) MANTECA, CALIF.—At their June 1 meeting, Local 1869 presented 25-year pins to nine members. Pictured here, seated from left, are Vernard Erdman, president; Lester Hamlow, and Clarence Lutz. Standing, from left, are Charles E. Nichols, General Treasurer, who presented the service pins; Thomas Ables, Bill Durossette, Harry Ernst, E. L. Harp, Bob Malone, and Haywood Wynn. Also receiving 25-year pins, but not present for the photograph, were William Burrows, John Griggs, Herbert Hudgins, Hulcie Mallory, Charles Peterman, and Ora Yancy.

(4) LONGVIEW, WASH.—Plywood Workers Local 2498 recently honored Phillip Reiter, left, and George A. Yule for their 35 years of service. Both were awarded 35-year service pins on May 8, 1971.

(5) Also honored by Local 2498 and presented with service pins were, from left, Don Karney (25 years), L. B. Pearson (20 years), George Cope (25 years), and George Gadshaw (25 years).

(6) Twenty-year pins were awarded to Local 2498 members, from left, Raino Kaunisto, Arline Wyscaver, and Herbert Janieks.

PLANE GOSSIP

SEND YOUR FAVORITES TO:
PLANE GOSSIP, 101 CONSTITUTION
AVE. NW, WASH., D.C. 20001.
SORRY, BUT NO PAYMENT MADE
AND POETRY NOT ACCEPTED.

Girded for Their Faith

Our grandmothers believed there was a destiny which shaped their ends. But modern girls prefer to put their faith in girdles.

MAKE YOUR \$\$\$ CLICK—GIVE TO CLIC

Not Exactly Nuptial

"My boy-friend proposed last night," confided the first secretary, "and I'm not speaking to him anymore!"

"That's a foolish attitude," replied the second steno.

"Oh yeah?" oh-yeahed the first. "You shoudda heard what he proposed!"

R U REGISTERED 2 VOTE?



That's No Bull-oney!

A lion killed and ate a bull. He enjoyed his meal so much, he roared with delight. A hunter, hearing his roar, found and shot the lion. The moral of this story is: when you're full of bull, you'd better keep your mouth shut!—Mrs. Leo Poirier, Fort Francis, Ont., Can.



Only Meat and Just

The neighborhood butcher burst into the lawyer's office and asked: "If a dog steals meat from me, is the owner liable?"

"Of course he is," replied the lawyer.

"Ah-ha, I have you!" cried the butcher. "It was your dog and he ran off with a \$2 steak!"

"That's too bad," said the lawyer. "Now if you'll just give me \$3 more, it will cover the cost of my professional advice."

UNIONS DUES—TOMORROW'S SECURITY

A Holy Baseball Game

This is an account of the first baseball game as discovered in the Bible.

Eve stole first, then Adam stole second. Rebekah walked with the pitcher, after which Gideon rattled the pitchers. Goliath was put out by David and The Prodigal Son stole home.—Ellen Girone, Jersey City, N.J.

B SURE 2 VOTE!

Ingeborg's Smorgasbord

A carpenter went into a "greasy spoon" for lunch. "What do you have?" he asked the waitress.

"Everything's on the menu," she snapped.

"I know that," he said. "How about getting me a clean one?"—Ingeborg Stachowski, Toronto.

This Month's Limerick

There was an old man of Blackheath
Who sat on his set of false teeth.

Said he, with a start,

"Oh Lord, bless my heart!

I've bitten myself underneath!"

—Peter George, L.U. 15, New Jersey

Willie Will, Won't He?

"Willie, did your father promise you anything if you raked the lawn?"

"No, but he promised me something if I didn't!"—Robert D'Entremont, Medford, Mass.

REGISTER AND VOTE

He Saw the Light

A Mexican named Jose lived near the U.S. border. One day he crossed over to see a baseball game. On his return, he told his friend: "They are fine people, the Americanos. They even sang a song for me before the game started. They sang, 'Jose, can you see. . . ?'."—Kevin Johnson, Buffalo, N.Y.

LOOK FOR THE UNION LABEL



Flaing Fleing Flies

A customer in a diner called the waiter over and said: "I want you to get every single fly out of here!"

"Okay," replied the waiter. "You just point out the married ones and I'll chase the rest!"—Ingeborg Stachowski, Toronto, Can.

WORK SAFELY—ACCIDENTS HURT

Bully New Daffynition

A bulldozer is a sleeping male cow.—Jim McDonagh, San Francisco.

ALWAYS C D UNION LABEL

Far, Far From The Truth!

The Washington official was not convinced of the justice in the Women's Liberation movement. "I know how you can gain his support," suggested a political opponent. "Offer his wife a foreign service appointment!"

R U GOIN 2 D UNION MEETING?

Or Get Shellacked?

Old cabinetmakers never die . . . they just bite the dust.—Kenneth R. Welsh, Local 721, Los Angeles.



1

SERVICE TO THE BROTHERHOOD

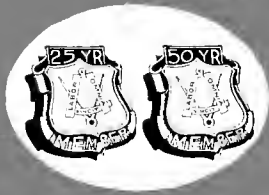

A gallery of pictures showing some of the senior members of the Brotherhood who recently received 25-year or 50-year service pins.

(1) NEW YORK, N.Y.—At its recent banquet honoring members with 25 to 50 years of service, Local 787 awarded eight 50-year pins and 118 25-year pins. Two of the 50-year honorees were able to attend the ceremonies, while 59 of the 25-year award recipients were present. Seen here with the 25-year pin recipients are (front row, from left) Halvor Jensen, financial secretary and treasurer of Local 787; Ralph Mattson, president; Erick Johnson and Gus Wallin, 50-year members; William Mahoney, vice-president of the New York City District Council; Edward Andreassen, business representative; and Jack Gellman, vice-president of New York City District Council.

(2) PORTLAND, ORE.—On May 13, 1971, at a special meeting called in order to nominate union officers, 47 members

of Furniture Workers Local 3182 were honored as the recipients of 25-year service pins. Presenting the awards was Roy W. Parent, executive secretary of the Wash.-Ore. District Council of Furniture Workers. Those present included, seated from left, Arnold B. Johnson, Walter Koenig, Emmett Leahy, Ada Hanson, Ruby Smith, Ruth Kreis, Leonard Jerome, Herman E. Hilken, Walter Scott, and Roy W. Parent. Seen standing, from left, are George Walker, R. L. Bishop, Thomas Schaefer, John Werth, John Johnson, John A. Dannehl, Walter J. Bischof, Joe Enright, Louis B. Koncelik, Carl Hammer, John Lee, James Drake, Edwin E. Klingman, and Fred H. Klingman, business representative. On May 31, 1971, Fred H. Klingman retired after having served in an outstanding fashion as business representative-financial secretary of Local 3182 since March 19, 1950.

2



APPRENTICESHIP & TRAINING



San Diego Pre-Apprentice Program: A Step Towards A Brighter Future

■ "It's the greatest thing that ever happened to me."

That is how one enthusiastic student summarizes his experience with the pre-apprenticeship training program of the San Diego, Calif., District Council of Carpenters. The three-year-old program, funded by the federal Manpower Development and Training Act, endeavors to train disadvantaged and minority youths in the building trades. Thus far, more than 140 students have completed the eight-week course, a combination of academic and on-the-job training. The current group of 23 student-carpenters represents the seventh class which the union has trained since the program got underway.

The students range in age from 18 to 29, and are paid approximately \$55 to \$65 a week. "The program is almost like the Head Start program," says Bob Harris, instructor/supervisor for the students' on-the-job training. "When the students get to future jobs, they know how to work better and they have a better chance of holding the jobs than have others without this preparation."

The students' pre-apprenticeship training begins with the study of simple mathematics, geometry, basic carpentry techniques, and tools and their uses. "We also try to stress the importance of promptness to work and interest in the job," says Harris, who drops recruits after four unexcused absences. He emphasized that the program's directors "hend over backwards" in their effort to keep the students in the program. "I don't drop anyone," says Harris. "They drop themselves."

Recently, most of the on-the-job

training has involved doing construction work for non-profit organizations which normally could not afford to fund a project. The organizations provide the material, and the work is done free of charge. Thus far, the students have done remodeling or construction work for the Red Cross, Salvation Army, various teen centers, and a Little League group.

The program's directors emphasize that the biggest problem which they have encountered so far is that of persuading the students to be prompt and to continue in the program. A 25% dropout rate is average for each pre-apprenticeship session. Nevertheless, the enthusiasm of those who have finished the program is very encouraging. As one student expressed it: "It's a step, something concrete, and it gives me a definite goal."

Conversely, the program has not been entirely free from outside criti-

cism. One leader in the minority community, for example, feels that the low pay in the program puts a burden on the young students to deplete their savings in order to survive on \$55 a week. Others feel that not enough has been done to counter the prejudice which the minority worker encounters when he has graduated from the program and is looking for a job.

Union leaders contend, however, that strong efforts have been made to overcome these and similar problems. They point with pride to the 72% of the graduates of the pre-apprenticeship program who have continued in the construction trade—a national high for this type of program. As Leslie Parker, secretary-treasurer of the San Diego District Council of Carpenters, expresses it: "If the students don't stay employed when we're through with them, then what have we got. Where is our effort?" ■

Members Attend Wisconsin Meeting

Brotherhood leaders recently took a special course in "Establishing Work Standards" at the Industrial Engineering Institute, University of Wisconsin at Madison. Participants included, from left: William Harper, time-study steward, Local 824, Muskegon, Mich.; and Int'l. Reps. Gene Tedrick, J. Dolan, Ronald Angell, and Adrien McKinney.



Industry Representative Tour Floorman's Training Center



OFFICERS OF CARPET, LINOLEUM, HARDWOOD AND TILE LAYERS LOCAL 1310 were hosts recently at their new office building and training school, 6330 Knox Industrial Ct., to a group of industry leaders who were in St. Louis for a conference of the Wood and Synthetic Flooring Institute. At front left table, clockwise from center foreground: Floor-ing industry representatives John Jackson, L. T. Smith, William R. Morgan, Jr., Joe Bauer, Tony DiNatale, James E. Bertasso, Joseph M. Flynn, Jr., Calvin Kimbrough and Jack Dempsey. At rear left table, clockwise from right: Ollie W. Laughorst, executive secretary-treasurer, Carpenters District Council; Ed Finkelstein, Communications Corporation; Joseph L. Pijut, Local 1310; Gus Uthoff, Carpenters apprentice instructor; Sandra Hoelscher, office staff; Edward Tuholske, coordinator, Floor Layers Training School; Fred Kleisly, Carpenters instructor; Raymond Sacks, St. Louis Board of Education, and Local 1310 President Gilbert Clark. At microphone, Local 1310 Business Manager Perry Joseph. At table right rear, clockwise from left foreground: industry representatives Gus Elfer, Jr., T. H. O'Donnell, Howard Kercher, James H. Stoehr, John E. Wordsworth, Walter Verseman, James Carr, Bob Whitman, Bob Hays and Benjamin L. Beck. At table right front, from left: industry representatives Robert Fritch and William M. Heyn and Mrs. Joseph.

Employer Pushes Pre-Apprenticeship In Los Angeles

John Konwiser, housing construction executive of Los Angeles, California, is a concerned individual. In 1969 his concern was particularly directed towards the high school students of Los Angeles and towards his own apparent inability to interest these young boys in the construction trade.

"We tried going into schools and giving talks," he states. "But the boys weren't responding."

It soon occurred to him that perhaps what these students needed was some practical experience in the field of construction, **with pay**. Konwiser proceeded to locate an old dilapidated house, suitable for the boys to renovate. Under the supervision and instructions of journeymen, the boys worked eight hours each Saturday and converted the 70-year-old house into a showplace.

The initial effort involved about two dozen boys from Jefferson High School, in a Black working class district just north of Watts. Sponsored by the Young Homebuilders Council, a 500-member group of middle-management homebuilding executives in the Greater Los Angeles area, the project proved to be a tremendous success. Konwiser, a council officer, and his fellow executives are now working to expand the project on a national scale. Four such projects are already underway, two in Los Angeles and others in Oakland and Santa Ana. Projects are also being planned in other areas of California, in Illinois, and in Texas.

The Jefferson High project was an outstanding example of united com-

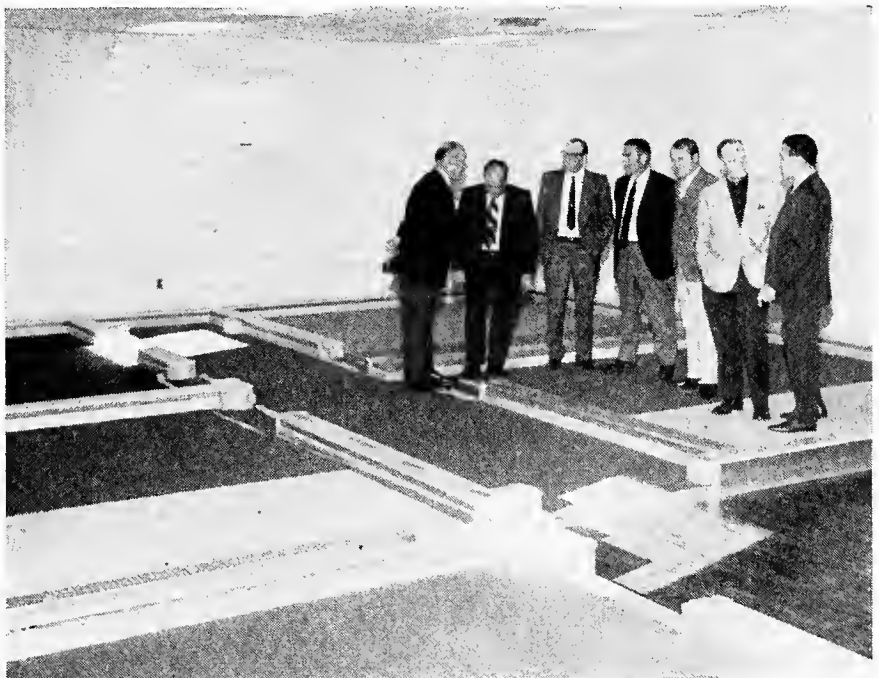

FLOORING INDUSTRY REPRESENTATIVES are shown a mock-up of flooring in a typical five-room home which is used at the school in training of apprentices by Local 1310. At left are Edward Tuholske, coordinator Floor Layers Training School, and Local 1310 President Gilbert Clark. At right is Perry Joseph Local 1310 Business manager.

munity action. A local savings-and-loan company donated the profits from the sale of the renovated building in order to provide the boys with wages and to begin a financial base for future projects. Many of the journeymen participating in the project volunteered their time and services, and all materials used were donated by local building suppliers.

In the boys, the result of this community concern is apparent. Harold

Campbell, the students' vocational instructor and job foreman, points out that of the eight seniors participating in the pilot project, one is in a carpentry apprentice program, three are in technical school studying carpentry or drafting, and a fifth stands a good chance of entering a carpentry apprentice program soon. Many others, still in high school, have expressed interest in entering the building trades after graduation.

APPROVED VETERANS

These 3 BIG DRAFTING KITS GIVEN TO YOU!

when you train at home with NASD for a **HIGH PAY JOB IN DRAFTING!**

Take your pick of 1000s big salary jobs open to Draftsmen. U.S. Labor Dept. reports "42% more Draftsmen needed in next 10 years—not enough applicants to fill jobs available now." Easy home-study plan has helped 100s beginners toward \$\$\$\$\$, security, prestige as Draftsmen—many with only grade school training. Others report good earnings drafting part time while still learning. Why not you?

RUSH COUPON FOR FREE KIT!

Mail coupon for FREE "DRAFTING CAREER KIT," Sample Lesson, Drafting Aptitude Test including new 5-Way Drafting Instrument & 20-Page Book, "Your Future in Drafting"—ALL FREE. No salesman will call. G.I. Bill approved. Write today.



NORTH AMERICAN SCHOOL OF DRAFTING, Dept. 1146B
4500 Campus Drive, Newport, California 92660

Rush "DRAFTING CAREER KIT," including Book, Sample Lesson, Aptitude Test & Drafting Instrument—ALL FREE!

NAME _____ AGE _____
ADDRESS _____
CITY _____ STATE _____ ZIP _____

STAIRWAY CONSTRUCTION MADE EASY

WITH THIS NEWEST BOOK

In plain language and with over 50 illustrations and photos, you are shown the methods that years of experience have proven the easiest, fastest, most practical and efficient.

Even with no previous experience you will be able to build a good stair the first time. It gives complete, detailed, easy-to-follow instructions on how to lay out, cut and build a more perfect stair. It shows the basic construction methods of all types, including winder and circular stairs.

This is the most complete book on stair construction published in the past 30 years. Increase your skill and self-confidence now. It saves its cost on the first stair built.

Satisfaction Guaranteed

\$3.50 Postpaid. Washington State residents add 18c tax. For air mail shipment add 55c extra.

Send \$3.50 money order or check to:

DOUGLAS FUGITT

11347 N.E. 124th St., Kirkland, Wash. 98033

ORDER TODAY

Name
Address
City
State Zip Code

New Mexico Pre-Apprentice Classes



As instructor-coordinator Clinton Abel well knows, a group of 18 pre-apprentices can certainly keep a man on his toes. Abel is presently conducting his third class of pre-apprentices in Albuquerque, N.M. Each of two previous classes had 15 students, 20 of whom are still working as apprentices in New Mexico. Most of those who participated in Abel's first class are now in their fourth six-month period.

The classes, funded by the Federal Manpower Development and Training Administration, are supervised by the New Mexico Carpenters' Apprenticeship and Journey-men Training Fund.

Local 413 Honors New Journeymen



Local 413 of South Bend, Ind., congratulates its 1970-71 class of apprentice graduates. Seated here, left to right, are members of the Joint Apprenticeship Committee George Elrod, Richard Beachey, Russell Miller, Roy Klein, and Don Hickey. Standing in the center row, left to right, are graduate apprentices Grant Baugher, James Sparks, Michael Scott, Floyd Elrod, Jerry Miller, and John Cole. Pictured in the back row, left to right, are graduate apprentices Ronald Conley, Billie Jones, David Bayken, Raymond Wachowiak, Gary Weldy, and Galen Richert. Richert was the first place winner of the 1970 Indiana Carpenter Contest. Also graduated, but not pictured here, were Jerry Cole and Gail L. Whitaker.

WORK BENCH CATALOG

A new steel work bench catalog is available from Equipto, Aurora, Illinois 60507. The 16 page catalog, Number 353, describes in detail a complete line

of benches that includes open style, closed style, cabinet benches and a new line created for office and mailrooms in addition to a new semi-portable bench. Easy to read charts provide complete specifications, dimensions and prices.

THE CARPENTER

Top Apprentices in Rhode Island

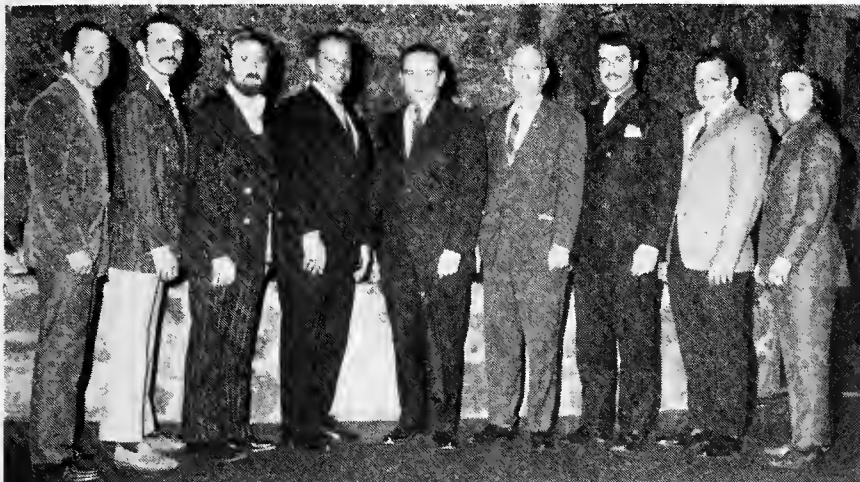

Though statewide apprenticeship competition is just getting underway this year in Rhode Island, the state joint apprenticeship training committee announces that two young men were chosen state champs for 1971. They are Richard Cournoyer, carpenter, and Anthony Maile, mill-cabinetman. The state JAC awarded bonds to top apprentices in eight classes. A total enrollment this year was 78.

Graduates are shown above, from left: Richard Cournoyer, Ernest Tessier, Russell Barry, JAC Members Herbert Holmes, Robert Hayes, and Jerome Kearney, Edward DePardo, Denis Cesana, and Carl Capracotta. Missing from the picture are Raymond DiOrio, Anthony San Giovanni, and Anthony Maile.

New Forestry Center

Continued from page 11

"It's a terrific educational tour for children," says the Portland District Council's Swan Nelson.

Other areas explained and shown via exhibits are forest land use; tree farming; reforestation; harvesting; renewability; manufacturing operations; environmental protection, and wood products.

Eye-catching exhibits include 486 myrtlewood plates made over a 25-year period as a hobby by James P. Langdon, retired deputy supervisor of Gifford Pinchot National Forest.

Another feature is a deer horn imbedded in a tree.

An overhead display reveals the many uses of wood products—ranging from a kayak to a modernistic paper dress.

Displays of how logs are mentally viewed by a sawyer and how he must see that they are cut to fully utilize the log also are shown.

Smaller scale animated displays show such logging operations as a boom and stacker loader, complete with narration, in action.

The sloping roofs of the two buildings of the Western Forestry Center are nine inches thick, starting with hand-split, thick red cedar shakes from Washington.

Overhangs of the roof are supported by carved posts from California

redwood. Outer walls of the center are rough-sawn cedar board, and rafters are of Idaho white pine boards, laminated for extra strength. Four-inch double doors are of Douglas Fir.

The exhibit building and the theater building are connected by a curved walkway in which are benches of Alaskan yellow cedar. They were carved in British Columbia.

The 700,000 board feet of lumber, shakes and plywood was chosen from 36,000 pieces of lumber.

"I tried to capture the glory of the living Northwest forest and the warmth and friendliness of wood in construction," said John Storrs, the architect for the center.

"The center will be a living activity complex reaching out to its members with exciting programs, information and news about our great forests," the Forestry Center explained in appealing for charter member contributors.

"While telling the modern day story of forests and wood products, the center hasn't overlooked time-tested terminology such as "gyppo," "hoot owl" and "skidroad."

The words are inscribed on redwood posts supporting overhangs of the exhibit building.

The exhibits, and history of the giant log cabin of 1905 lost in the 1964 fire carry on in even greater brilliance. ■

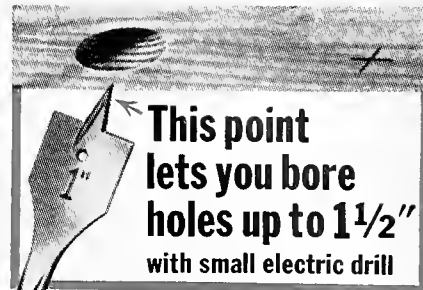

This point lets you bore holes up to 1 1/2" with small electric drill

IT'S HOLLOW GROUND to bore cleaner, faster at any angle

Now step-up the boring range of your small electric drill or drill press to 1 1/2" with Irwin Speedbor "88" wood bits. 1/4" shank chucks perfectly. No wobble. No run-out. Sharp cutting edges on exclusive hollow ground point start holes faster, let spade type cutters bore up to 5 times faster. You get clean, accurate holes in any wood at any cutting angle.

Each Irwin Speedbor "88" forged from single bar of finest tool steel. Each machine-sharpened and heat tempered full length for long life. 17 sizes, 1/4" to 1 1/2", and sets. See your Irwin hardware or building supply dealer soon.



IRWIN SPEEDBOR "88" WOOD BITS
at Wilmington, Ohio, Since 1885

AUDEL CARPENTERS & BUILDERS LIBRARY

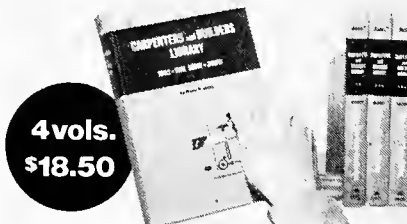

4 vols.
\$18.50

THESE "PAPER TOOLS" can boost your income!

Their 1,488 pages of practical information and how-to guidance are invaluable "tools" for all in the building trades... a complete course for the apprentice, a ready reference for master workers.

Thousands of photos, diagrams and charts tell and show short cuts, new methods, solutions and money-saving ideas... how to use every tool and building aid... how to build everything from furniture to houses... how to frame, roof, excavate, do carpenter arithmetic, estimate costs, trim, insulate, care for tools, etc. They can help you earn more, fast.

MONEY BACK GUARANTEE—You must be completely satisfied with the Audel Guides you order, or you may return them within 10 days and get your money back.

SEND COUPON TODAY

Theodore Audel & Co., 4300 West 62nd St. C-111
Indianapolis, Indiana 46268

Please mail me Carpenters and Builders Library, 4 vols. I agree to mail \$3 in 10 days and to mail 1/2 the total purchase price 30 days later, with the balance plus shipping costs to be mailed within another 30 days. If I am not completely satisfied I may return the books for refund.

Name _____

Address _____

City _____ State _____ Zip _____

Save shipping costs. Enclose \$18.50 (plus sales tax, if any) and we pay postage.

YOU GET **MORE**
OUT OF THEM
'CAUSE
VAUGHAN
PUTS MORE
INTO THEM!

... AND HAS FOR
MORE THAN
100 YEARS



999

A 20 oz.
heavy duty
beauty. Large
striking face.
13" or 16"
top grade
hickory
handles.
Plain or
milled face.



FIBERGLASS

Exclusive hollow core
design adds greatest
strength, better
balance, absorbs
more shock.
13 to 20 oz.
sizes, nail
and rig.

**RIG
BUILDER'S
HATCHET**

Polished 22 oz.
striking head with
flat milled face.
Special 17"
hand
comfort
handle.



SUPER BAR

15" all
purpose pry bar.
A must for every
tool box.

Request catalog illustrating
complete line of striking
tools and pry bars.



**VAUGHAN & BUSHNELL
MFG. CO.**

11414 MAPLE AVE., HEBRON, ILL. 60034

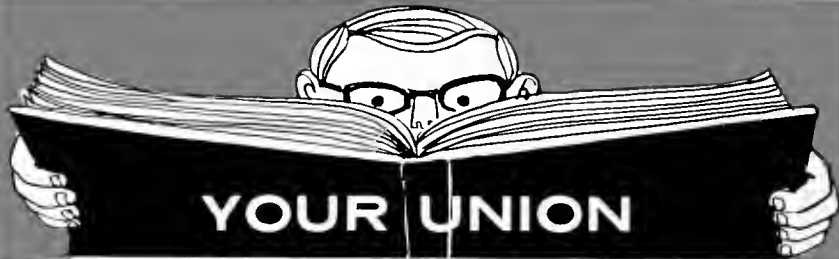

DICTIONARY

This is the 7th of a new feature series planned to keep you better informed on the meaning of terms related to collective bargaining, union contracts, and union business. Follow it closely, and your union membership will become more meaningful, and your ability to participate in decisions which affect your future and security will be strengthened. It was compiled by the International Labor Press Assn, and is used with permission.

E

economic strike: One over money issues and working conditions rather than unfair labor practices. Not "protected" under law, and employer may hire and retain replacements unless strike settlement says they must go.

eligibility date: After NLRB sets a date for a union recognition election, it rules on who is eligible to vote. Usually the last payroll period is the yardstick.

emergency dispute: A strike or the threat of a strike which would affect the national health and safety. See fact-finding.

employer interference: An unfair labor practice, it includes barring distribution of union literature or solicitation during non-working time; speeches to employees on company time and property before a representation election unless the union gets equal chance to reply; questioning of employees about union activity; closing or moving the plant, or threatening to do so; circulation of an anti-union petition and requiring employees to sign; unilateral increases in wages; removal of privileges; spying, encouraging or discouraging union membership; firing for union activity.

employer's final offer: The last terms offered by an employer in an attempt to settle a contract dispute. In the case of national emergency disputes, Taft-Hartley requires the NLRB to conduct a secret-ballot vote on this offer among the employees. Rejection has been virtually universal when a like decision has been reached by ordinary union procedures.

equal job opportunity: The elimination of discrimination in employment, by law or by union contract.

equal pay for equal work: The concept, frequently written into contract language, that like work shall command like pay, regardless of sex, race or other individual characteristics. This usually refers to sex differentials, now covered by federal law.

escalator clause: An adjustment of wages in accordance with such factors as cost of living, productivity or material costs.

escape clause: In a maintenance-of-membership agreement, a provision setting a period of time during which union members may withdraw as members, without effect on their employment.

experience rating: Adjustment, according to employer's unemployment or accident record, of the rate employer pays for unemployment insurance or workmen's compensation insurance.



REPORT

Recent Membership Contributions to the Carpenters Legislative Improvement Committee

The state council conventions continue to aid the program of the Carpenter Legislation Improvement Committee. Here are recent additions:

Oklahoma State Council Convention, \$553.00.

Iowa State Council Convention, \$95.00.

"CLIC" REPORT (as of 10-18-71)

Local	State	Amount	Local	State	Amount
AKANSAS					
71	Fort Smith	10.00*	448	Waukegan	10.00*
1683	El Dorado	10.00*	461	Highwood	30.00*
CALIFORNIA					
162	San Mateo	28.00	568	Lincoln	10.00*
483	San Francisco	175.00	633	Madison	10.00*
1140	San Pedro	46.00	644	Pekin	20.00*
1400	Santa Monica	40.00	695	Sterling	10.00*
1408	Redwood City	12.00	725	Litchfield	20.00*
1453	Huntington Beach	13.00	742	Decatur	10.00*
1752	Pomona	6.00	748	Taylorville	10.00*
2172	Santa Ana	10.00*	792	Rockford	30.00*
COLORADO					
362	Pueblo	20.00	812	Cairo	10.00*
CONNECTICUT					
196	Greenwich	75.00	839	Des Plaines	239.00*
FLORIDA					
1379	N. Miami	40.00	841	Carbondale	10.00*
1509	Miami	40.00	904	Jacksonville	20.00*
2024	Miami	10.00	916	Aurora	10.00*
2340	Bradenton	15.00	999	Mt. Vernon	10.00*
ILLINOIS					
10	Chicago	10.00*	1092	Marseilles	30.00*
13	Chicago	57.00	1128	LaGrange	30.00*
16	Springfield	30.00*	1185	Chicago	74.50*
44	Champaign Urba	50.00*	1196	Arlington Heights	10.00*
58	Chicago	30.00*	1248	Geneva	10.00*
63	Bloomington	20.00*	1265	Monmouth	10.00*
141	Chicago	40.00*	1361	Chester	10.00*
154	Kewanee	20.00*	1367	Chicago	50.00*
166	Rock Island	20.00*	1527	Wheaton	20.00*
169	E. St. Louis	30.00*	1883	Macomb	10.00*
181	Chicago	100.00*	1889	Downers Grove	40.00*
183	Peoria	40.00*	1996	Libertyville	20.00*
189	Quincy	10.00*	2004	Itasca	10.00*
199	Chicago	30.00*	2010	Anna	10.00*
241	Moline	30.00*	2063	Lacon	30.00*
242	Chicago	10.00*	2087	Crystal Lake	10.00*
269	Danville	20.00*	2094	Chicago	10.00*
295	Collinsville	20.00*	2122	Vandalia	10.00*
347	Mattoon	30.00*	2158	Rock Island	51.00*
360	Galesburg	20.00*	3273	Olney	10.00*
363	Elgin	20.00*	INDIANA		
367	Centralia	10.00*	436	New Albany	40.00
377	Alton	10.00*	1355	Crawfordsville	4.00
433	Belleville	30.00*	3000	Crown Point	10.00*
434	Chicago	20.00*	IOWA		
KANSAS					
KENTUCKY					
MASSACHUSETTS					
MINNESOTA					
MISSISSIPPI					
MISSOURI					
NEW HAMPSHIRE					
NEW JERSEY					
NEW YORK					
OHIO					
OKLAHOMA					
OREGON					
PENNSYLVANIA					
RHODE ISLAND					

Local	State	Amount
MASSACHUSETTS		
111	Lawrence	100.00
218	Boston	294.00
878	Beverly	8.00
1035	Taunton	60.00
MINNESOTA		
851	Anoka	12.00
MISSISSIPPI		
1471	Jackson	30.00
MISSOURI		
602	St. Louis	40.00
1739	Kirkwood	57.00
NEW HAMPSHIRE		
921	Portsmouth	79.00
1616	Nashua	54.00
NEW JERSEY		
455	Somerville	60.00
620	Madison	200.00
NEW YORK		
20	New York	200.00
77	Port Chester	21.00
117	Albany	4.00
246	New York	598.00
323	Beacon	80.00
357	Islip	30.00
412	Sayville	60.00
608	New York	200.00
747	Oswego	80.00
964	Rockland Co.	111.00
1075	Hudson	20.00
1292	Huntington	80.00
1397	N. Hempstead	120.00
1483	Patchogue	1.00
2241	Brooklyn	20.00
3211	Herkimer	42.00
OHIO		
650	Pomeroy	30.00
716	Zanesville	18.00
1359	Toledo	20.00
1935	Barberton	47.00
OKLAHOMA		
285	Altus	10.00*
329	Oklahoma City	60.00*
653	Chickasha	10.00*
763	Enid	10.00*
943	Tulsa	80.00*
986	McAlester	10.00*
1028	Ardmore	10.00*
1072	Muskogee	20.00*
1399	Okmulgee	20.00*
1585	Lawton	10.00*
1659	Bartlesville	10.00*
1686	Stillwater	20.00*
1894	Woodward	10.00*
2008	Ponca City	10.00*
2013	Ada	10.00*
OREGON		
849	Manitowoc	20.00
2636	Valsetz	20.00
2701	Lakeview	9.00
PENNSYLVANIA		
122	Philadelphia	51.00
321	Connellsville	16.00
401	Pittston	20.00
465	Ardmore	20.00
1856	Philadelphia	60.00
1906	Philadelphia	100.00
2264	Pittsburgh	80.00
RHODE ISLAND		
1695	Providence	20.00

(Continued on page 39)

New Pension Fund

Continued from page 2

It comes months ahead of a one-year target date for such a pension program set by the 31st General Convention at San Francisco, last year. The Brotherhood's new General Executive Board, which was installed last April, was instructed by convention resolution to investigate the advisability of such a program. Implementation was then left to the General Officers.

Actually, the new fund consists of two separate pension plans, each tailored to the special needs of members which the plans would cover. There is to be an Industrial Pension Plan and a Construction Industry Pension Plan.

The two plans, centrally operated on an international basis, will make it simpler for local unions and district councils to negotiate pension coverage. All technical, legal, actuarial and administrative details can now be arranged in advance. Negotiators can, thus, concentrate on the amount of contributions to be made to the plans.

Centralization of Brotherhood pension plans will offer greater financial stability and assure greater benefits to their participants. General President Hutcheson pointed out in his October 11 announcement. Through efficient, central data processing, administrative costs will be held to a minimum.

A major instrument for implementation of the portable pension concept is the Pro-Rata Agreement (discussed in more detail on Page 3).

Many local, district, and regional pension plans already in existence began signing Pro-Rata Pension Agreements, earlier this year, bringing them under the umbrella of the National Pro-Rata Agreement. Many more such area plans are expected to join the international program before the end of the year, once their trustees have an opportunity to review details of the agreement and its benefits to members.

"We look forward to the day when all our members will have continuous pension coverage no matter where they work," says General President M. A. Hutcheson. "All local unions and councils now have the opportunity to take action which will help to assure their members of that kind of pension coverage."

At the conference in Washington establishing the Labor-Management Pension Fund, the Brotherhood named First General Vice President William Sidell as its trustee, and management

named David Stirling, Jr., board chairman of the Stirling Homex Corporation, as a management trustee.

Stirling is a pioneer in union-made modular housing. His firm signed a precedent-setting modular construction agreement with the Brotherhood in June, 1969. Stirling-Homex has produced more than 15,000 housing modules to date.

He said of the new pension program: "Its international scope, its provisions for early vesting and portability, and other special features will enable employers to attract the best workers available and to provide greater security for present employees. This will facilitate expansion of construction and manufactured housing and enable us better to meet the housing needs of this country."

There are six advantages of the Carpenters Labor-Management Pension Plan which should be noted:

1. The Industrial Plan is especially designed for the needs of industrial members with benefits directly related to individual contributions. Include earlier vesting than is usually available under any local plan.

2. Employees can maintain their standing in the plan while moving from one participating employer to another in any part of the country.

3. Any local plan is only as secure as the economy of the local area of the individual employer; the plan operating on an International scope gives greater security and protection against economic risks through geographic diversification.

4. Lower expenses as the volume and number covered in the plan increases.

5. Simplifies collective bargaining because the basic pattern of benefits and standards is already determined; also avoids possibility of abuses which occasionally exist in smaller plans.

6. The National plan could provide an opportunity to negotiate for coverage for the first time for thousands of members of the United Brotherhood who have heretofore not had such an opportunity. ■

Pro-Rata Agreement

Continued from page 3

so. Then the trustees of your plan have to enter into reciprocal pro-rata agreement with other plans. This is done by signing the International Pro-Rata Agreement.

General President Hutcheson indicated the general intent of the two aspects of the International program:

"With the Carpenters Labor-Management Pension Fund we are trying to make it easier to negotiate pension plans for our members who are not yet covered and to provide better benefits for those who feel that this new plan would be more beneficial to them. With the Pro-Rata Agreement we are opening to our members an increasingly broad area of employment opportunity . . ."

Each pension fund which signs the Pro-Rata Agreement recognizes each other signatory pension fund as a "related plan" and it agrees to recognize for eligibility purposes the "service credits" accumulated and maintained by an employee under all related plans.

The total of an employee's service credits under all related plans comprise the employee's "combined service credit." Not more than one year of "combined service credit" shall be counted in any calendar year.

General President Hutcheson, in a letter to all local unions and councils, earlier this year, urged the signing of pro-rata agreements:

"In recent years there has been increasing concern over the lack of reciprocity among negotiated pension plans. This is a serious problem in the construction trades, where workers move about considerably in pursuing work opportunities.

"Because of lack of reciprocity between pension programs, members can lose their rights to collectively bargained pensions. Other members do not get full pension benefits because they worked under more than one plan and these plans did not have reciprocity.

"The answer to this pressing problem, of course, is one national pension fund or reciprocal agreements among pension funds. The 31st General Convention addressed itself to this problem in considering a number of resolutions dealing with the matter.

"The Convention instructed the General Executive Board to study the matter of reciprocal agreements for pension funds and to make recommendations for action to Local Unions and Councils.

"After a good deal of study, the General Executive Board has worked out a program under which widespread reciprocity can be achieved with a minimum of disruption.

"We strongly recommend that the labor-management boards of trustees of Carpenters pension funds be urged to adopt the uniform provisions for pro-rata pension. . . ." ■



Outdoor Meanderings

Readers may write to
 Fred Goetz
 2833 S. E. 33rd Place,
 Portland, Oregon 97202

To the Far- Flung Depths for Fish

■ One of the greatest of bounties Mother Earth has to offer is the almost countless variety of fish which fin in far-flung depths. Do you know any other planet in the unlimited universe which can offer more? Members of the Brotherhood of Carpenters and Joiners of America and their families are among these who dearly love and appreciate this great gift and this column recalls a few.

■ Off Acapulco

Robert Sherbondy, a member of Local 1577 at Buffalo, New York, travelled far south in quest of big game fish and so did his fishing partner Daniel L. Collins. They struck it rich in the Blue Pacific Briny off the coast of Acapulco, southern Mexico. In a picture at right is graphic proof of the feat: Brother Sherbondy with two of the four finned beauties they caught. The largest measured 10-ft., 6-in. from bill to tail and weighed 140 pounds.

■ The Maine Coast

Whereas Brother Sherbondy travelled south for the big gamesters, Raymond L. Canfield of Salem, New Hampshire, a member of Local 878, Beverly, Massachusetts, travelled north to the cold Atlantic depths, eight miles off York Beach, Maine. And like Sherbondy, Brother Canfield also hit the finny target: A Bluefin Tuna, a monster which tipped the scales at 745 pounds and took 3 hours and 43 minutes to bring boatside. He duped it with a single mackerel bait, using 120-lb. test Dacron line and a 14/0 Penn Deep-Sea Reel. The action took place last September, off the good ship "El Sam," out of Perkins Cove, Ogunquit, Maine.

■ The Gulf of Mexico

Another one of this earth's bountiful briny waters is the Gulf of Mexico, and no one knows it any more than Charles Evans of Rochester, Florida, a member of Local 72. He fishes it quite frequently. Here's a look-in on Brother Evans with a nice catch of Sheepshead he made from Gulf waters. The largest he's holding tip-

ped the scales at 10 pounds which, he claims is four pounds short of the record for that species in these waters. Evans adds: "In addition to being scrappy game fish on light tackle, they are also delicious."

■ In Florida Waters

One of the reasons that William M. Ike moved south—from Terre Haute, Indiana, where he was a member of Local 133, to Lake Worth Florida, where he is a member of Local 1308—was to have more opportunity to enjoy his favorite pastime—fishing.

He's depicted in the following photograph, standing at the stern near the boat's fish locker which contains a day's catch of Kingfish, six of which he caught, all of which weighed over 12 pounds.

■ California Catch

Another great gamefish which the briny deep offers is the striped bass but it must be noted that this is a species which is anadromous. Normally, it spends the better part of its time in salt water and enters the brackish stretches of freshwater streams to spawn. It is also a specie which can be, and has, adapted to a complete freshwater environment. Both Joseph A. Jacob Sr., a member of Local 1047, San Francisco, and his wife Frances enjoy fishing for stripers from the Napa River, and last we heard were both catching some 20-inch specimens, and looking forward to the coming of the lunkers.

■ Off Redondo Beach

Granted, there are more than a few species of saltwater finsters which could not win a beauty contest, but this has nothing to do with their worth in a buttered frying pan. An example of what I'm talking about is demonstrated by the following photograph of Fred and Keith Ramp with "cow cod" they eased from the Pacific briny off Redondo Beach. Both Fred and his father, Keith, are members of Local 1506, Los Angeles.

(Continued on page 36)



Evans (The Gulf of Mexico).



Sherbondy (Off Acapulco).



Ike (In Florida Waters).



Ramps (Off Redondo Beach).

THE THIRD HAND OF A PANELING MAN

Take all the guesswork out of aligning and marking corner panels with our kit of rugged aluminum off-set jigs and marking gauges.

Increase your speed and accuracy as you scribe perfect panels marked for a "pressed-in" fit. Panel-by-panel instructions included for inside and outside corners and for the location of cut-outs. Designed for plywood panels of 3/4" or less.

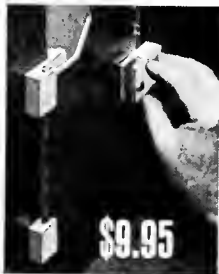

Patented U.S.A.

OFFSET JIGS FOR ROUTERS

A Cut-In-Place method of fitting inside corner panels. The router takes the place of the marking gauge or scriber and precisely cuts over 90% of an 8 ft. panel. Any router can be adapted to these jigs. Cut-In-Place kits are designed for plywood panels of 1/2" or less.

- Offset jigs and marking gauges. \$9.95 Postpaid.
- Cut-In-Place jigs for your router. \$6.95 Postpaid.

C.O.D. orders: you pay postage and charges. Satisfaction guaranteed or money refunded.

For rush orders please add 50c

PANELING SPECIALTIES CO.
Three Lakes, Wisconsin 54562

LAYOUT LEVEL

- ACCURATE TO 1/32"
- REACHES 100 FT.
- ONE-MAN OPERATION

Save Time, Money, do a Better Job
With This Modern Water Level

In just a few minutes you accurately set batters for slabs and footings, lay out inside floors, ceilings, forms, fixtures, and check foundations for remodeling.

HYDROLEVEL is the old reliable water level with modern features. Toolbox size. Durable 7" container with exclusive reservoir, keeps level filled and ready. 50 ft. clear tough 3/10" tube gives you 100 ft. of leveling in each set-up, with 1/32" accuracy and fast one-man operation—outside, inside, around corners, over obstructions. Anywhere you can climb or crawl!

Why waste money on delicate instruments, or lose time and accuracy on makeshift leveling? Since 1950 thousands of carpenters, builders, inside trades, etc. have found that HYDROLEVEL pays for itself quickly.

Clip this ad to your business stationery and mail today. We will rush you a Hydro-level with complete instructions and bill you for only \$7.95 plus postage. Or send check or money order and we pay the postage. Satisfaction guaranteed or money back.

Ask your tool dealer to order it for you. We allow the usual dealer discount on 1/4 Doz. lots and give return-mail service.

HYDROLEVEL

925 DeSoto, Ocean Springs, Miss. 39564

FIRST IN WATER LEVEL DESIGN SINCE 1950

Outdoor Meanderings

Continued from page 35

■ Oregon Report

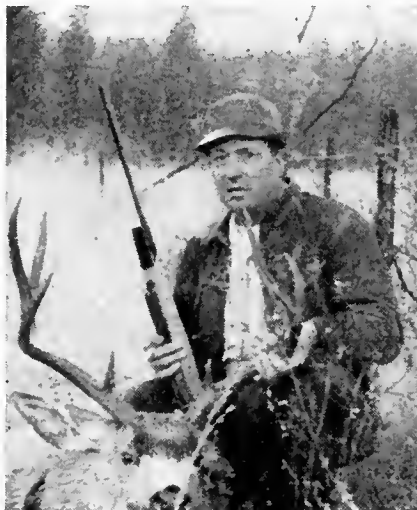

Hendren's prize mulie

One of the best mule deer bucks we've heard tell about this past hunt season can be credited to Carl S. Hendren, a member of Portland, Oregon, Carpenter Local 1021. Hendren is currently serving as Center Coordinator at Timber Lake Job Corps Carpenter Program at Estacada, Oregon. Here's a look-see at Carl with his prize mulie which was estimated to weigh close to 325 pounds and was taken from a remote draw near the town of Joseph in the northeastern section of the Beaver State.

■ Nimrod's Jackpot



Bobby Scott measures rack

Tom Stout of Cottonwood, Calif.—in north Tehama County and in the northern part of the state—a member of Piledrivers Local 34, San Francisco, really hit the nimrod's jackpot on the first day of the hunting season out of Thompson Falls, Montana—a deer, a bear and a monstrous-racked elk. The following photograph of Mr. and Mrs. Stout's grandson, Bobby Scott, proves that Montana, the "Big Sky" country, also has some mighty big elk to offer the hunter. Bob can barely stretch his arms wide enough to demonstrate the spread of granddad's trophy rack. (Photo by Colin Davies of the Red Bluff Daily News.)

■ Gold in the Waters



Boswell and busy bass

Cloyd Boswell of Oroville, California, a member of Local 1240, found "glittering reward" from an old gold mine, abandoned after gold dredging operations ceased in the Oroville area many years ago. He's pictured here with a 3-lb., 9-oz. bass from a water-filled borrow pit which earned him "third prize" in a local bass derby thereabouts. He fooled the old cavern mouth on a "Rooster Tail" lure.

■ A Reminder

This writer concedes that all the wildlife of the land is not "just a target for the hunter's gun." Only a portion of certain species which can be sustained in healthy numbers should be harvested, as any crop—be it fish, fowl or fur bearers—should be harvested. If any given section of land becomes over-populated, particularly in the big-game department, it could prove disastrous and result in an over-browsed range and countless deaths to deer, especially in the food-scarce winter months.

■ Secluded Carp

Shades of last year's "Good Old Summertime." Here's a flashback on the action which depicts

Mrs. E. Robinson, wife of Edward Robinson, a member of Local 712, Cincinnati, Ohio, with the largest carp ever caught from what she describes as a "secluded valley lake near Covington, Kentucky." The monster tipped the scales at 22 pounds and what is most noteworthy is that Mrs. Robinson was using ultra-light gear topped off with six-pound test line.



Mrs. Robinson



IN MEMORIAM

**L.U. NO. 2
CINCINNATI, OHIO**
Lindenmeyer, C. A.

**L.U. NO. 4
DAVENPORT, IOWA**
Long, Ellsworth

**L.U. NO. 15
HACKENSACK, N.J.**
Kelly, Patrick J.
Taylor, Henry

**L.U. NO. 23
DOVER, N.J.**
Bertsch, William A.
Dester, Hermen
Pierce, Bill
Smith, Joel

**L.U. NO. 36
OAKLAND, CALIF.**
Drabiska, Stephen
Linna, Oscar
Lucero, Ivan D.
Moore, Walter N.
Munson, Charles B.

**L.U. NO. 50
KNOXVILLE, TENN.**
Hodge, Dudley

**L.U. NO. 54
CHICAGO, ILL.**
Weiher, William G.

**L.U. NO. 60
INDIANAPOLIS, IND.**
Beard, William O.

**L.U. NO. 61
KANSAS CITY, MO.**
Bennett, Herbert M. Sr.
Burton, Vernie O.
Cowan, Albert Z.
DeShazer, E. F.
Elliott, Warren O.
Henstreet, Claude L.
Ramsey, C. E.
Pierson, Alfred
Rich, I. A.
Stroer, Tom
Trowbridge, H. T.
Urquhart, T. A.
Walton, R. M.

**L.U. NO. 62
CHICAGO, ILL.**
Benson, Eric
Boehmer, William
Gregus, John
Hedenschoug, Leroy
Holmquist, Elmer
Johnson, Linder
Jones, Ralph
Kocsis, Joseph
McGary, Charles
Sabockis, William
Swanson, John B.

**L.U. NO. 65
PERTH AMBOY, N.J.**
Miller, Nels

**L.U. NO. 88
ANACONDA, MONT.**
Lathrope, Harold
Sovereign, Gene

**L.U. NO. 101
BALTIMORE, MD.**
Ballard, Harold L.

**L.U. NO. 109
SHEFFIELD, ALA.**
George, Fred L.

**L.U. NO. 121
VINELAND, N.J.**
Archetto, Joseph

**L.U. NO. 129
HAZELTON, PENN.**
Schumack, William

**L.U. NO. 132
WASHINGTON, D.C.**
Glover, Joseph E.
Goins, William J.
Johnson, Ray W.
Long, B. J.
Merz, Christian

**L.U. NO. 133
TERRE HAUTE, IND.**
Davis, Joe S.
Spencer, Walter W.

**L.U. NO. 144
MACON, GA.**
Henry, William

**L.U. NO. 155
PLAINFIELD, N.J.**
Abel, William
Jaruszewski, Stanley
Slater, Alexander
Stem, Raymond

**L.U. NO. 180
VALLEJO, CALIF.**
Blanchard, C. E.
Fancher, L. E.
Hunter, Edgar
Jones, Ralph
Williams, Carl

**L.U. NO. 181
CHICAGO, ILL.**
Sparesus, Edward Sr.

**L.U. NO. 184
SALT LAKE CITY,
UTAH**
Blackham, Sheril
Blanke, A. E.
Cluff, Charles
Dunn, Earl
Johnson, Barney
LeCheminant, Lionel
Mitchell, A. L.
Mumford, James C.
Ockey, Horace
Olson, Leslie
Peterson, Andrew
Rigler, Joe
Sperry, H. Melvin
Svard, Axel
Vanderlinden, W. A.

**L.U. NO. 188
YONKERS, N.Y.**
MacKay, Hugh

**L.U. NO. 198
DALLAS, TEX.**
Abercrombie, B. A.
Miller, Carl Sr.

Nichols, Loyd C.
Richardson, John R., Jr.
Staggs, Roy

**L.U. NO. 213
HOUSTON, TEX.**
Elwell, W. A.
Williams, Homer

**L.U. NO. 246
NEW YORK, N.Y.**
Nigro, Michele

**L.U. NO. 253
OMAHA, NEB.**
Baumgartner, Frank G.
Fisher, Walter
Kalkowski, Robert P.
Oga, Albert J.

**L.U. NO. 283
AUGUSTA, GA.**
Kneece, Johnny

**L.U. NO. 301
NEWBURGH, N.Y.**
Cassel, Michael W.

**L.U. NO. 302
HUNTINGTON, W. VA.**
Esque, Edward
Lyons, Bill
Marshall, Leo
Price, Tib W.

**L.U. NO. 322
NIAGARA FALLS, N.Y.**
Matusak, John
Sullivan, David
Winchester, Joseph

**L.U. NO. 345
MEMPHIS, TENN.**
Coxson, Clarence E.
Ellis, Cecil S.
Ferrell, W. W.
Gentry, Todd R.
Golden, James T.
Hester, Clarence
Lewis, Herschel
McManus, T. C.
Moore, John A.
Saliba, Phillip N.
Shelton, J. C.
Tabor, R. G.
White, Doyle R.
Wooten, W. D.
Young, Thad

**L.U. NO. 362
PUEBLO, COLO.**
Asher, Thomas A.

**L.U. NO. 470
TACOMA, WASH.**
Bradshaw, C. W.
Clark, W. E.
Clausen, Glen
Fisk, Axel
Holm, Fred
Irvine, Thomas
Miller, Glenn W.
Olson, N. H.
Pavlovich, Steve
Swanberg, Frank

**L.U. NO. 488
NEW YORK, NY.**
Dutt, John

Stankiewisz, Karol
Vanhanen, David

**L.U. NO. 562
EVERETT, WASH.**
Thompson, James H.
Watson, Robert J.
Zelmer, Alvin

**L.U. NO. 620
MADISON, N.J.**
Blanchard, David
Gillis, Angus
Jacobsen, Kurt
Korkes, Joseph
Lovett, Albert
Maioran, Pasquale
Pandulo, Ralph
Parsil, Walter
Zankowski, Stanley

**L.U. NO. 668
PALO ALTO, CALIF.**
Given, Wilbur G.
Mederos, Joseph E.
O'Connor, Thomas E.

**L.U. NO. 674
MT. CLEMENS, MICH.**
English, Lester

**L.U. NO. 710
LONG BEACH, CALIF.**
Coffelt, Eurist
Gasper, Ed P.
Newsom, Henry E.
Nylung, Ernest
Perriguy, H. O.

**L.U. NO. 715
ELIZABETH, N.J.**
Buza, Joseph
Gargano, Frank
Messler, Henry
Wilson, Wallace

**L.U. NO. 750
JUNCTION CITY, KANS.**
Lehmkuhl, Fred
Ratts, R. P.

**L.U. NO. 770
YAKIMA, WASH.**
Pfief, Henry

**L.U. NO. 787
NEW YORK, N.Y.**
Russel, John

**L.U. NO. 791
NEW YORK, N.Y.**
Clark, Frank
DiAmbrosia, Vincient
Heaman, Axel
Kirpredes, Nikitas
Kutch, Rubin
Salvesen, Segurd

**L.U. NO. 906
GLENDALE, ARIZ.**
Arduza, Charles
McDannald, Loren O.
Whitlock, Thomas J.

**L.U. NO. 977
WICHITA FALLS, TEX.**
Hiebert, Harry E.
Osborn, J. B.

**L.U. NO. 982
DETROIT, MICH.**
McMillan, Sam
Neil, William
Stengel, Nickolas

**L.U. NO. 1006
NEW BRUNSWICK, N.J.**
Johnson, Raymond
Robertson, John

**L.U. NO. 1055
LINCOLN, NEB.**
Polson, Allen E.

**L.U. NO. 1093
GLEN COVE, N.Y.**
Doran, George

**L.U. NO. 1172
BILLINGS, MONT.**
Friesz, Emil

**L.U. NO. 1194
PENSACOLA, FLA.**
Huelsbeck, Harry H.
Kintz, Michael R.
Yates, Prentice T.

**L.U. NO. 1305
FALL RIVER, MASS.**

Audette, Alban
Cote, Joseph G.
Curry, John
Hannafin, Thomas F.
Maia, Peter E.
Martin, Hormidas
Messier, Andre E.
Morel, Armand
Morin, Lucien
Nascimento, Frank
Oliveira, Joaquim

**L.U. NO. 1323
MONTEREY, CALIF.**
Beaver, Charlie
Groff, A. G.
Layton, Ollie

**L.U. NO. 1478
REDONDO, CALIF.**
Breed, Walter M.
Carter, Jack J.
Darms, Charles H.
Dykstra, Peter H.
Ferm, Reuben B.
May, Melvin H.
Williams, Henry J.

**L.U. NO. 1497
E. LOS ANGELES,
CALIF.**

Agrusa, Joseph
Anderson, Clifford
Burdick, Robert C.
Byard, Charles
Edwards, Charles
Green, Charles F.
Johns, Richard
McCullough, George C.
Martinez, Gabriel
Patten, Kenneth
Werth, Nicholas
White, Harvey L.
White, Jasper

**Continued on
next page**

**MAKE \$20 to \$30 EXTRA
on each
STAIRCASE**



Saves its cost in ONE day—does a better job in half time. Each end of Eliason Stair Gauge slides, pivots and locks at exact length and angle for perfect fit on stair treads, risers, for perfect fit on stair treads, risers, closet shelves, etc. Lasts a lifetime.

Postpaid if payment sent with order, or C.O.D. plus postage Only **\$19.95**



**ELIASON STAIR
GAUGE CO.**
6005 Arbour Lane
Minneapolis, Minn. 55436

Planer · Molder · Saw!

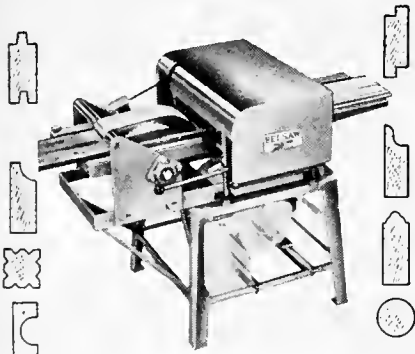

Now you can use this ONE power feed shop to turn rough lumber into high-value moldings, trim, flooring, furniture ... ALL popular patterns.

RIP... PLANE... MOLD... separately or all at once by power feed ... with a one horsepower motor. Use 3 to 5 HP for high speed commercial output.

LOW COST... You can own this MONEY MAKING POWER TOOL for only ... **\$30.00** down.
Send coupon today

BELSAW POWER TOOLS
942V Field Bldg., Kansas City, Mo. 64111
Send me complete facts on the MULTI-DUTY Power Tool. No obligation.

Name _____
Address _____
City _____ State _____ Zip _____



Lakeland News

Items of interest from the Brotherhood's retirement home at Lakeland, Florida

Nicholas Van Setten of Local 781, Princeton, N. J., arrived at the Home August 3, 1971.

Birger Larsson of Local 1974, Ellensburg, Wash., arrived at the Home August 11, 1971.

Claude F. Herring of Local 1725, Daytona Beach, Fla., arrived at the Home August 11, 1971.

C. M. Earley, of Local 103, Birmingham, Ala., arrived at the Home August 27, 1971.

Wm. R. Bennett, of Local 211, Pittsburgh, Pa., died August 5, 1971. Burial was in Confluence, Pa.

Wm. J. Shields, of Local 1, Chicago, Ill., died August 6, 1971. Burial was in Tampa, Florida.

Elmer Vunnila of Local 1433, Detroit, Michigan, died August 6, 1971. Burial was in the Home Cemetery.

Alois J. Wende, of Local 242, Chicago, Ill., died August 28, 1971. Burial was in the Home Cemetery.

Rudolph A. Janca, of Local 1128, Brookfield, Ill., was dismissed from the

Home for just cause on August 23, 1971.

Joseph L. Enzian, of Local 211, Pittsburgh, Pa., arrived at the Home Sept. 1, 1971.

Michael M. Karnila, of Local 563, Glandale, Calif., arrived at the Home Sept. 2, 1971.

Golden S. Bitts, of Local 844, Canoga Park, Calif., arrived at the Home Sept. 20, 1971.

Logan S. Kay, of Local 1486, Auburn, Calif., arrived at the Home Sept. 29, 1971.

Daniel V. Gillis, of Local 933, Miami, Florida, died Sept. 1, 1971. He was buried in the Home Cemetery.

Emil T. Quick, of Local 696, Tampa, Florida, died Sept 1, 1971. He was buried in the Home Cemetery.

Andrew Dougherty, of Local 73, St. Louis, Mo., died Sept. 8, 1971. Burial was in St. Louis.

Roldan Harris, of Local 1445, Topeka, Kans., died Sept. 11, 1971. Burial was in Topeka.

Richard Huizing, of Local 490, Passaic, N.J., withdrew from the Home Sept. 29, 1971.

IN MEMORIAM, Continued from page 37

L.U. NO. 1513
DETROIT, MICH.

McKinstry, George
Vernagus, Joseph

L.U. NO. 1849
PASCO, WASH.
Golden, Murl

Agee, George
Gustafson, Martin J.
Kittner, Ben

L.U. NO. 1683
EL DORADO, ARK.
Kelly, Thomas J.

L.U. NO. 2274
PITTSBURGH, PENN.
Sechler, Lynn

LEGACY OF LONG SERVICE

Local 787 of New York City, recently lost a veteran member, John Russel, who was initiated into the Brotherhood on August 2, 1920. Brother Russel died August 28, 1971. He was the oldest member of Local 787.

Made to put in a hard day's work

Designed by Carpenters
Especially for Carpenters

There's plenty of comfort, convenience and work-saving features in these overalls. Made just like you want 'em... because they're designed by workers like yourself. Guaranteed to be the best you've ever worn or we'll take 'em back. No questions asked.

Lee® UNION MADE
M.R. CARPENTERS'
OVERALLS

H. O. LEE COMPANY, INC.
SHAWNEE MISSION, KANSAS 66201
"World's largest manufacturer of union-made work clothes."



TOOL TALK by B. Jones



"Who's your big mouth friend?"

INDEX OF ADVERTISERS

Audel, Theodore	31
Belsaw Power Tools	38
Belsaw Sharp-All Co.	39
Chicago Technical College	13
Eliason Stair Gauge Co.	38
Estwing Manufacturing	15
Foley Manufacturing	24
Fugitt, Douglas	30
Hydrolevel	36
Irwin Auger Bit Co.	31
Lee Overalls	39
Locksmithing Institute	39
No. American School of Drafting	30
Paneling Specialties	36
Skil Corporation	17
Stanley Tools	Back cover
Vaughan & Bushnell	32

C. J. Haggerty

Continued from page 13

council announced his retirement six months ago, it accepted his decision "with reluctance" and memorialized his term in office as one of "excellence and distinction."

As chief executive officer of the California AFL-CIO, Haggerty was credited with helping cement the unity of the merged labor movement.

During four presidential administrations, Haggerty was chief spokesman for the nation's construction workers, who are represented by 17 international unions.

Brotherhood Service



Wayne Bradford, honored for his 50 years of devoted service to Local 1280, is shown here with Mrs. Bradford. Also shown is Clarence Briggs, General Representative, who participated in the ceremonies.

CLIC Report

(Continued from page 33)

TENNESSEE		
50	Knoxville	20.00
TEXAS		
665	Amarillo	10.00*
753	Beaumont	10.00*
977	Wichita Falls	20.00
1276	Dallas	10.00*
VIRGINIA		
388	Richmond	10.00
WASHINGTON		
770	Yakima	38.00
WISCONSIN		
849	Manitowoc	20.00
1181	Milwaukee	20.00
1801	Hawkins	15.00
2334	Baraboo	7.00
WYOMING		
469	Cheyenne	20.00

* Includes contributions from delegates representing their local unions at the State Council Conventions. In some instances, these convention contributions were the only monies received from the local unions.

START A MONEY-MAKING BUSINESS FOR LESS THAN \$50!

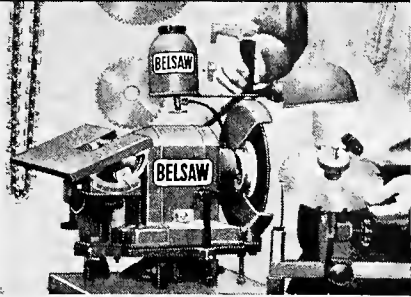

You can have your own lifetime business right at home...work in spare time... and make up to \$200 a month CASH! My FREE PLAN gives you all the facts: How to start, how to grow. You don't need previous experience. You don't have to sell. I'll even finance you. People bring you the work and pay cash. Over 90¢ of every dollar you collect is clear cash profit. And you work when you want to. Let me prove you can't find a more certain, lower cost, higher paying business of your own.

Just Mail Coupon—No Salesman Will Call

BELSAW SHARP-ALL CO.
Stan Field, President
732V Field Bldg., Kansas City, Mo. 64111



Name _____
Address _____
City _____ State _____ Zip _____

You'll Like Being a SKILLED LOCKSMITH

You'll EARN MORE, LIVE BETTER than Ever Before in Your Life

You'll enjoy your work as a Locksmith because it is more fascinating than a hobby—and highly paid besides! You'll go on enjoying the fascinating work, year after year, in good times or bad because you'll be the man in demand in an evergrowing field offering big pay jobs, big profits as your own boss. What more could you ask!

Train at Home—Earn Extra \$\$\$\$ Right Away!
All this can be yours FAST regardless of age, education, minor physical handicaps. Job enjoyment and earnings begin AT ONCE as you quickly, easily learn to CASTLE on all kinds of locksmithing jobs. All keys, locks, parts, picks, special tools and equipment come with the course at no extra charge. Licensed experts guide you to success.

Illustrated Book, Sample Lesson Pages FREE
Locksmithing Institute graduates now earning, enjoying life more everywhere. You can, too. Coupon brings exciting facts from only school of its kind. Lic. by N. J. State Dept. of Ed., Accredited Member, Natl. Home Study Council. Approved for Veteran Training.
LOCKSMITHING INSTITUTE
Div. of Technical Home Study Schools
Dept. 1118-111 Little Falls, N. J. 07424



Earned \$150 During Training
I realized with LOCKSMITHING I'd be able to double my income. During my training period I made \$150.
Paul Funes
New York, N. Y.



LOCKSMITHING INSTITUTE, Dept. 1118-111 Little Falls, New Jersey 07424 Est. 1948

Please send FREE illustrated Book—"Your Big Opportunities in Locksmithing," complete Equipment folder and sample lesson pages—FREE of all obligation—(no salesman will call).

Name _____ (Please Print)
Address _____
City _____ State _____ Zip _____
 Check here if Eligible for Veteran Training



In Conclusion

M. A. Hutcheson, *General President*



New Brotherhood Pension Plans Eliminate the Negative

■ Elsewhere in this issue are two stories outlining new arrangements which have been established by the General Office to do two things: one, to make it easier for local unions without a pension plan to negotiate one with their employers; and, two, to provide a vehicle for increasing the portability of existing pension plans.

These programs carry out the dictates of the 31st General Convention in this regard. I urge all members to read the stories carefully.

Over the past several months, a subcommittee of the U.S. Senate has been holding hearings on the whole pension question. Much of the testimony presented was of a shocking nature. Many pension programs, particularly those provided unilaterally by employers, failed to provide proper funding, with the result that the money was not available to pay pensions when substantial numbers of employees reached retirement age. Even in some plans negotiated by unions, too rigid vesting qualifications eliminated many employees. Lack of portability cut many others out of benefits.

It is difficult to estimate the percentage of our members who are not covered by a pension agreement. However, I am sure the number is very substantial.

We have a great many local unions with less than a hundred members. It is virtually impossible to set up a meaningful and worthwhile pension program for groups this small. The base simply is not broad enough to provide decent coverage at a reasonable cost.

To remedy this situation, a national pension program has been established. It is known as the Carpenters Labor-Management Pension Fund. The Carpenters Labor-Management Pension Fund will make available to our members in both the United States and Canada in both the industrial and construction ends of our industry a plan in which local unions can participate in direct proportion to their ability to negotiate employer contributions.

The Labor-Management Fund operates two sepa-

rate pension plans; one for industrial members and the other for construction members. Each plan is tailored to meet the special problems and needs of the members it covers.

I scarcely need to point out the advantages that accrue from a national pension plan. First, local unions too small to negotiate plans of their own can become participants in the national plan. Second, employees can maintain their standing in the plan while moving from one participating employer to another. Third, a national plan gives greater security and protection against economic risks which may fall heaviest on one section of the country.

The national plan also simplifies the collective bargaining process for pensions because the basic standards are set forth in the national agreement and declaration of trust.

I sincerely hope that all local unions which do not presently have negotiated pension plans will give consideration to becoming part of the national plan.

A second plan established by the General Office is known as the Pro Rata Pension Plan. As the name implies, it provides a vehicle for creating more widespread portability of benefits among the many existing negotiated pension plans.

The plan is very simple. Local Union Pension Plans A, B, C, and D notify the General Office that they want to participate in the Pro Rata Pension Plan. The General Office notifies each of the plans that the other plans are signed up for the Pro Rata Pension Plan.

This means that a man working under Plan B can move to work within the jurisdiction of Plan A without losing the benefits he built up in Plan B. When the time comes for him to draw a pension, he will get a proportional pension from each of the programs he worked under.

These plans do not solve all the problems surrounding our pension plans at this time, but they will help eliminate some of the worst shortcomings. ■

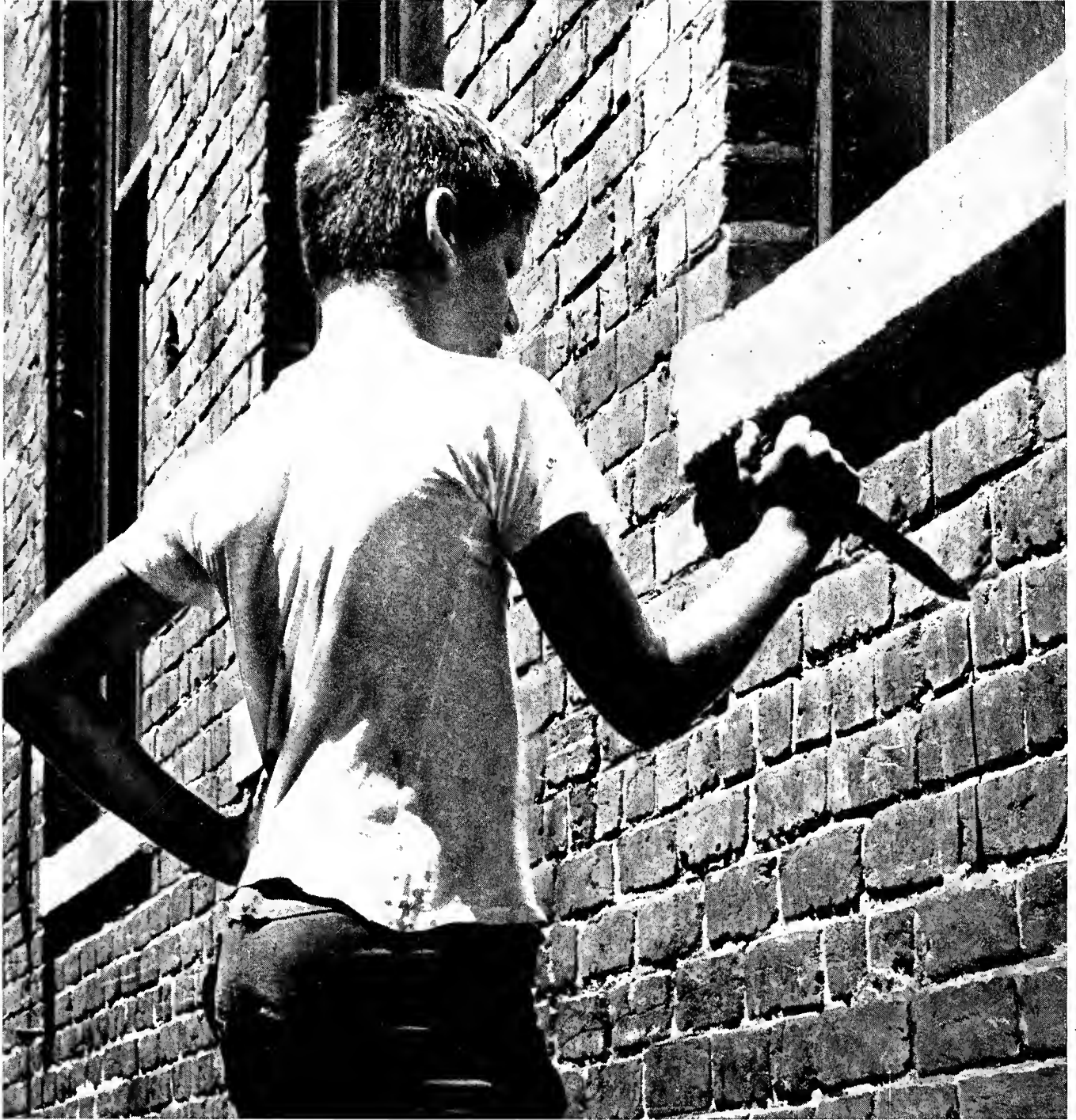

He has time to kill

Caught up in an aimless existence which offers few chances for fun, many boys turn to a life of crime. Your United Way gift can help steer them right by providing counseling service, recreational opportunities and a sense of purpose. Please give them time to grow instead of to kill.

Your fair share gift works many wonders ✓ THE UNITED WAY



28.4 million families benefit from child care, family service, youth guidance, health programs, disaster relief and services for the Armed Forces through 31,500 United Way agencies



What makes the Stanley Workmaster™ your kind of level?

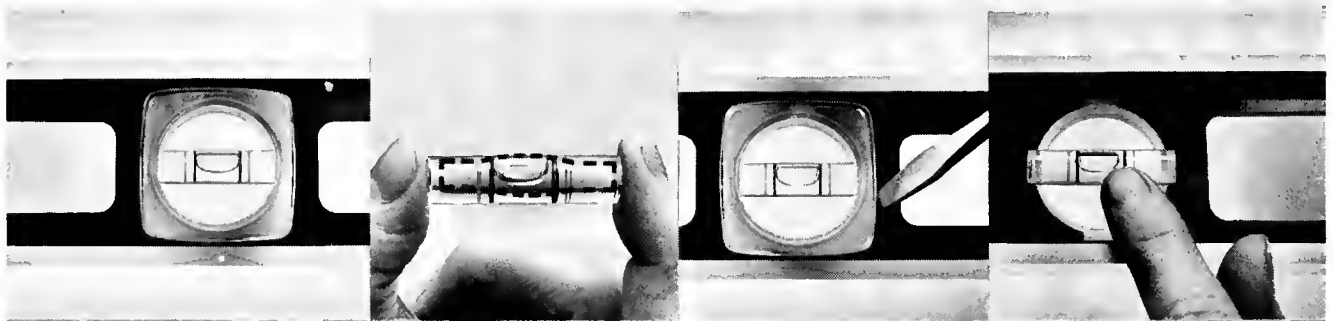

Here's the most advanced level ever developed. A complete concept, with new "360 vials". King size, the tough acrylic vials are 20% larger for maximum visibility and accuracy.

One vial works better than two bent glass vials. Fact: Stanley engineering has put one barrel shaped vial inside another vial, providing 360° surface readings from any angle.

Simply put a screwdriver under cover plate and twist. Cover plate snaps out. Now just take out the broken vial. It's that simple.

Snap the new vial into place, snap on cover plate and you've replaced the vial in seconds.

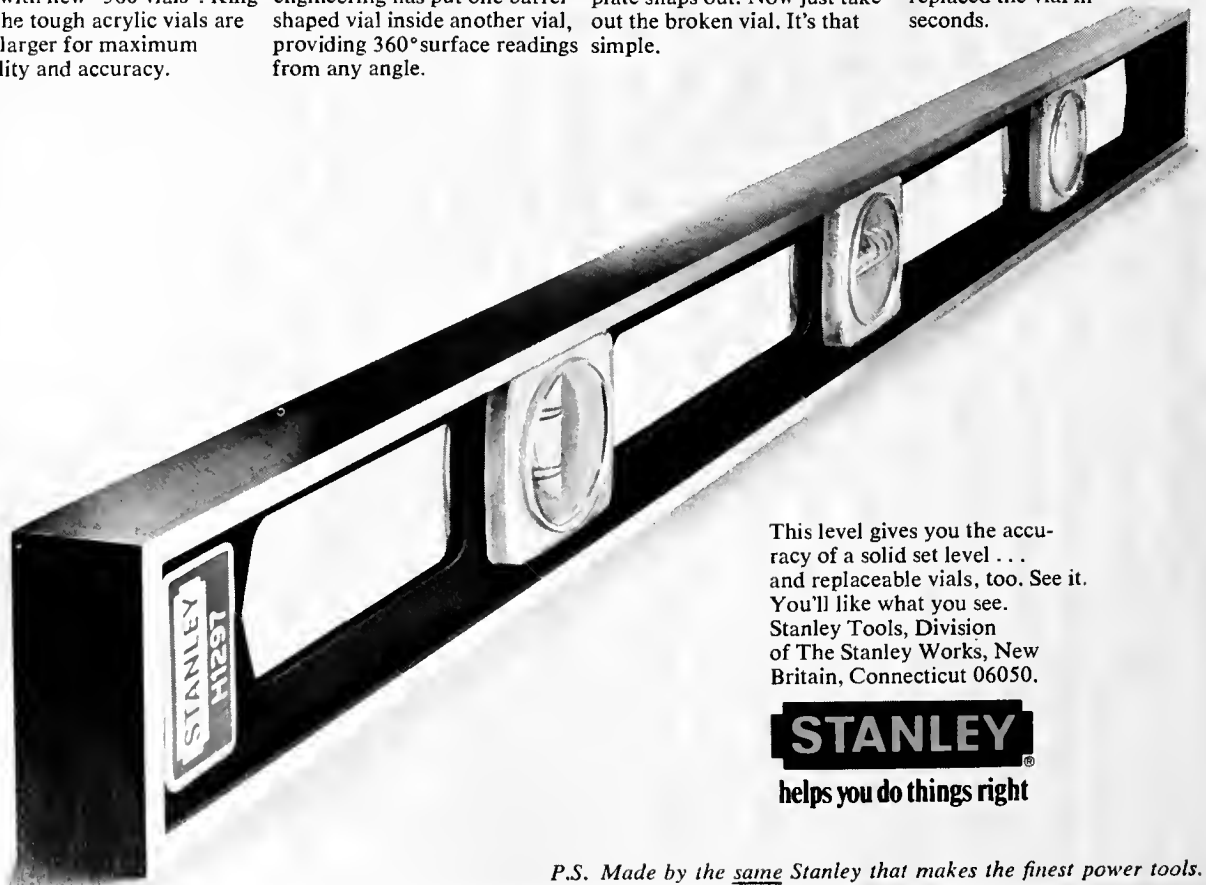

This level gives you the accuracy of a solid set level . . . and replaceable vials, too. See it. You'll like what you see. Stanley Tools, Division of The Stanley Works, New Britain, Connecticut 06050.

STANLEY®

helps you do things right

P.S. Made by the same Stanley that makes the finest power tools.

The

DECEMBER 1971

CARPENTER

Official Publication of the UNITED BROTHERHOOD OF CARPENTERS AND JOINERS OF AMERICA • FOUNDED 1861



Season's Greetings

OFFICIAL INFORMATION



GENERAL OFFICERS OF THE UNITED BROTHERHOOD of CARPENTERS & JOINERS of AMERICA

GENERAL OFFICE:
101 Constitution Ave., N.W.,
Washington, D. C. 20001

GENERAL PRESIDENT

M. A. HUTCHESON
101 Constitution Ave., N.W.,
Washington, D. C. 20001

FIRST GENERAL VICE PRESIDENT

WILLIAM SIDELL
101 Constitution Ave., N.W.,
Washington, D. C. 20001

SECOND GENERAL VICE PRESIDENT

HERBERT C. SKINNER
101 Constitution Ave., N.W.,
Washington, D. C. 20001

GENERAL SECRETARY

R. E. LIVINGSTON
101 Constitution Ave., N.W.,
Washington, D. C. 20001

GENERAL TREASURER

CHARLES E. NICHOLS
101 Constitution Ave., N.W.,
Washington, D. C. 20001

DISTRICT BOARD MEMBERS

First District, **PATRICK J. CAMPBELL**
130 North Main Street
New City, Rockland Co., New York
10956

Second District, **RALEIGH RAJOPPI**
130 Mountain Avenue
Springfield, New Jersey 07081

Third District, **WILLIAM KONYHA**
2830 Copley Rd., Box 8175
Akron, Ohio 44320

Fourth District, **HAROLD E. LEWIS**
101 Marietta St., Suite 913
Atlanta, Georgia 30345

Fifth District, **LEON W. GREENE**
2800 Selkirk Drive
Burnsville, Minn. 55378

Sixth District, **FREDERICK N. BULL**
6323 N.W., Grand Blvd.
Oklahoma City, Oklahoma 73118

Seventh District, **LYLE J. HILLER**
Room 722, Oregon Nat'l Bldg.
610 S.W. Alder Street
Portland, Oregon 97205

Eighth District, **M. B. BRYANT**
Forum Building, 9th and K Streets
Sacramento, California 95814

Ninth District, **WILLIAM STEFANOVITCH**
2418 Central Avenue
Windsor, Ontario, Canada

Tenth District, **ELDON T. STALEY**
4706 W. Saanich Rd.
RR #3, Victoria, B. C.

M. A. HUTCHESON, *Chairman*

R. E. LIVINGSTON, *Secretary*

Correspondence for the General Executive Board
should be sent to the General Secretary.



Secretaries, Please Note

If your local union wishes to list deceased members in the "In Memoriam" page of *The Carpenter*, it is necessary that a specific request be directed to the editor.

In processing complaints, the only names which the financial secretary needs to send in are the names of members who are NOT receiving the magazine. In sending in the names of members who are not getting the magazine, the new address forms mailed out with each monthly bill should be used. Please see that the Zip Code of the member is included. When a member clears out of one Local Union into another, his name is automatically dropped from the mail list of the Local Union he cleared out of. Therefore, the secretary of the Union into which he cleared should forward his name to the General Secretary for inclusion on the mail list. Do not forget the Zip Code number. Members who die or are suspended are automatically dropped from the mailing list of *The Carpenter*.

PLEASE KEEP THE CARPENTER ADVISED OF YOUR CHANGE OF ADDRESS

PLEASE NOTE: Filling out this coupon and mailing it to the CARPENTER only corrects your mailing address for the magazine. It does not advise your own local union of your address change. You must notify your local union by some other method.

This coupon should be mailed to **THE CARPENTER**,
101 Constitution Ave., N.W., Washington, D. C. 20001

NAME _____ Local No. _____

Number of your Local Union must be given. Otherwise, no action can be taken on your change of address.

NEW ADDRESS _____

City

State

ZIP Code

THE CARPENTER

VOLUME XCI

No. 12

DECEMBER, 1971

UNITED BROTHERHOOD OF CARPENTERS AND JOINERS OF AMERICA

Peter Terzick, Editor



IN THIS ISSUE

NEWS AND FEATURES

Phase Two Becomes Maze Two	2
Full Employment, Secure Contracts are Labor's Demands	4
Building Trades Protest Pay Board Action	7
Minority Workers Make Heavy Gains in Construction	9
Speakers at Building Trades Convention	10
Construction to Show Continued Growth in '72	11
Peter Terzick Honored	14
The New Disneyworld, Union Made	16
Planning for the Postwar World	Max Shulman 18
The Canadian Union Industries Show	22

DEPARTMENTS

Washington Roundup	13
Service to the Brotherhood	17, 24, 33, 35
Plane Gossip	21
CLIC Report	25
Canadian Report	Morden Lazarus 28
Your Union Dictionary	30
Apprenticeship and Training	32
Outdoor Meanderings	Fred Goetz 36
In Memoriam	37
Lakeland News	39
In Conclusion	M. A. Hutcheson 40

THE COVER

Christmas is a festival of lights. In every village, town and city across the nation . . . in all the Christian world . . . everyone makes a Christmas light as best he can. The single candle burning in a lonely snowbound farmhouse and the thousand-bulb flashing electric display atop a metropolitan skyscraper have one factor in common: a desire to give light and substance to the holiday season.

No one knows for certain where the "lights tradition" comes from. Perhaps it is not a tradition so much as an instinct. From the earliest scrawls on the walls of cave men, it is clear that bright fires and lights have always accompanied feasts, holidays and festivals. And it was a bright light in the sky which led the Three Wise Men to the manger in Bethlehem.

The ribbon is symbolic of the millions of Christmas packages which will be exchanged this season. The holly has a most unusual Christmas history. Superstitious Romans were planting holly to protect their property from lightning in Christ's time.

The holly tree is so closely associated with the Christmas tradition that many believe it was originally "holy tree." While there may be a division of opinion on that point, it is clear to all that the gifted photographer for our front cover has managed to fully convey the spirit of "A Merry Christmas to All."

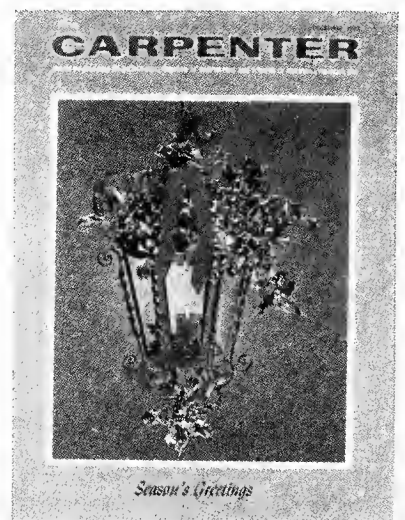

POSTMASTERS, ATTENTION: Change of address cards on Form 3579 should be sent to THE CARPENTER, Carpenters' Building, 101 Constitution Ave., N.W., Washington, D. C. 20001

Published monthly at 810 Rhode Island Ave., N.E., Washington, D. C. 20018, by the United Brotherhood of Carpenters and Joiners of America. Second class postage paid at Washington, D. C. Subscription price: United States and Canada \$2 per year, single copies 20¢ in advance.



Printed in U. S. A.

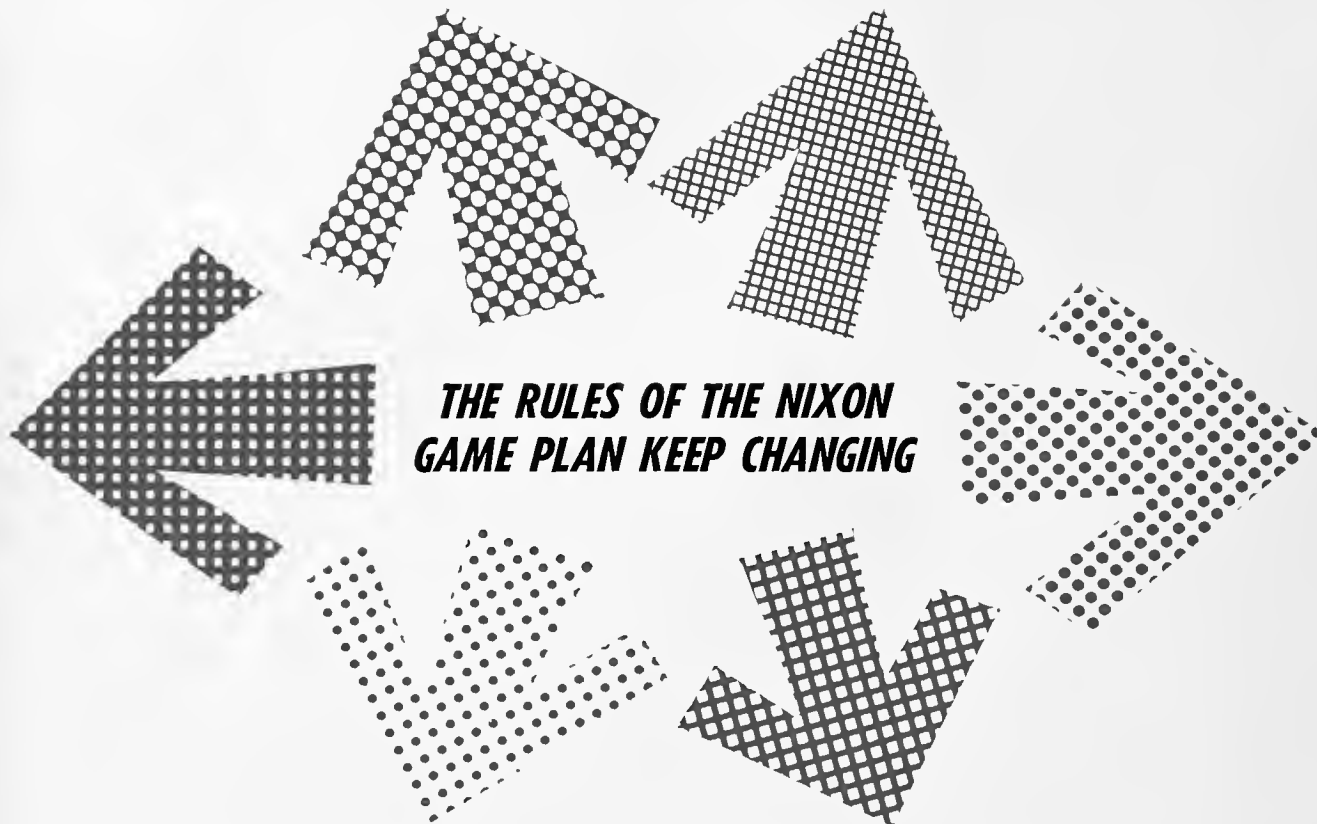

THE RULES OF THE NIXON GAME PLAN KEEP CHANGING

Phase Two Becomes Maze Two

■ Phase 2 of President Nixon's stabilization game plan went into effect November 13. By now it is evident that Phase 2 could more appropriately be called Maze 2, since it confounds the confusion already created by Phase 1.

The rules and regulations seem to change hour by hour rather than day by day. The latest order issued by the Pay Board on November 16 purportedly sets forth the newest rules governing wage increases. By the time this issue goes to press, there may be a whole new set of regulations.

However, for what they are worth, here are the November 16 regulations, as spelled out in question and answer form:

Q: What pay adjustments are affected by the new 5.5% general wage and salary standard?

A: The initial 5.5% general wage and salary standard applies to labor agreements entered into, on and after November 14, 1971. It also applies to other pay adjustment decisions made after that date whether or not reflected in a formal agreement.

Q: What about wage increases under existing contracts and pay practices?

A: Pay adjustments under contracts and pay practices existing prior to November 14, 1971 are allowed to go

into effect. If they affect more than 1,000 employees, they must be reported to the Pay Board in accordance with regulations to be issued by the Pay Board. However, they are subject to review by the Pay Board, if challenged, to determine whether any increase is unreasonably inconsistent with criteria established by the Board. The employer may continue to pay the increased wage or salary until such time as a determination of the challenge is made by the Pay Board.

Pay adjustments in the building and construction trades, regardless of the number of employees affected and regardless of when agreed upon, must be prenotified to and approved by the Construction Industry Stabilization Committee under criteria established by the Board.

Q: Can retroactive wage increases be paid? unit?

A: Pay Board approval is required for any retroactive increases covering services performed during the freeze period. This approval is not automatic.

Q: What is the definition of wages and salaries?

A: Wages and salaries is broadly defined to include cash payments, fringe benefits and all forms of direct and indirect remuneration. The definition does not include items which are not reasonably subject to valuation nor payments made under public plans such as Social Security.

Q: Are any employees excluded?

A: Federal employees whose pay is governed by federal law and employees paid at less than the federal minimum wage standards, currently \$1.60 per hour, are excluded from the application of the wage and salary standards.

Q: Does the 5.5% standard apply to each individual?

A: No. It will apply to the average increase granted in an appropriate employee unit.

Q: What is meant by appropriate employee unit?

A: The appropriate employee unit for the measurement of changes in wage and salary levels is a group composed of employees in a bargaining unit or recognized employee categories in a plant or other establishment, or in a department thereof, or in a company, or in an industry, as best adapted to preserve contractual or historical relationships.

Q: Are longevity increases counted as part of the 5.5% standard?

A: Longevity increases and automatic progression within a rate range are allowed to go into effect after November 13, 1971 according to the terms of plans, agreements, or established practices in existence prior to November 14, 1971, without regard to the 5.5% general wage standard.

Q: Are smaller employers required to get Pay Board approval before putting wage and salary increases into effect?

A: Pay adjustments involving less than 1,000 employees do not require prenotification or reporting of a wage or salary increase. However, the employer must adhere to the 5.5% general wage and salary standard in granting increases.

Pay adjustments in the building and construction trades, regardless of the number of employees affected, must be prenotified to and approved by the Construction Industry Stabilization Committee.



1972 Will Be Year Of Political Tumult

BY ALEXANDER UHL
Press Associates, Inc.

■ "Unquestionably we are in for one of the most tumultuous periods in American labor history."

That statement by AFL-CIO President George Meany made during the Federation's ninth convention in Florida, this year, must serve as a keynote to any forecast of what American workers and their unions can expect as the year 1972 approaches.

Rarely have the rights of property in the form of profits and the rights of men in the form of jobs and wages been so dramatically arrayed against each other as by the actions of the Nixon Administration during the current year.

With the utter collapse of the original Nixon economic program that produced an unsuccessful war on inflation with an only too successful surge in unemployment, the Nixon Administration embarked on a new economic program that even more unfairly placed the burden of a faltering economy on the backs of workers.

For 90 days there was a freeze on wages and prices that was far more oppressive for workers than businessmen whose price policies had added to the daily increase in the cost of living. Phase II under a Pay Board "loaded" with business and Administration representatives gave little relief for the hundreds of millions of dollars in lost wage gains that were suffered by workers but remained in the pockets of their employers.

The determination of the Administration to "crack-down" on labor and make it the scapegoat was further marked by an economic policy based on the "trickle-down theory" that liberal and labor economists have long excoriated.

While the Secretary of Labor was rejoicing in the success of the Administration in holding down wage gains, the Secretary of Commerce was calling for higher profits as the way to national prosperity.

This polarization of interests—verging on the class struggle itself—has made the election year 1972, both on the legislative and political levels, a year of extraordinary importance to the American worker, both union and non-union.

Every election year—and notably every Presidential election year—is bound to arouse the deepest hopes and fears of the American electorate. Control of the White House and control of the Congress are not superficial election victories for men or parties. They involve the deepest interests of powerful and conflicting bodies within the electorate.

This election year of 1972, as President Meany has said, will be a year of "tumult" more crucial than in many years before.

Labor has doubled and redoubled its registration and turn-out-the-vote campaigns. It has directed particular attention to the new wave of voters between the ages of 18 and 21. A huge bloc in themselves, these young voters may well hold the key to what happens in November of 1972.

Every election year, of course, is a year of "tumult." Presidential ones are apt to be particularly "tumultuous" ones. But it would be hard to find a Presidential election year in the history of the United States that is more deserving of the characterization than is the upcoming one. ■

Full Employment, Secure Contracts Are Labor's Convention Demands

AFL-CIO ASKS EQUAL TREATMENT UNDER PAY-PRICE FREEZE



Left: The Brotherhood delegation at the AFL-CIO Convention, which included: General President M. A. Hutcheson, First Gen. Vice Pres. William Sidell, Second Gen. Vice Pres. Herbert Skinner, Gen. Sec. R. E. Livingston, Gen. Treas. Charles Nichols, Gen. Treas. Emeritus and Editor Peter Terzick, and General Exec. Bd. Members Patrick J. Campbell, Raleigh Rajoppi, Harold E. Lewis, Leon W. Greene, Frederick N. Bull, Lyle J. Hiller, and M. B. Bryant, and Delegates Conrad F. Olsen, George Vest, Jr., and G. A. McCulloch.

Right: General President Hutcheson confers with First General Vice President Sidell during a break in the convention.



Left: Four delegates consider the actions taken during the session just ended. From left, Delegates Bull, Nichols, Greene, and Lewis.



■ In three days of hard work, the 9th Constitutional Convention of the AFL-CIO hammered out a program capable of moving the nation off dead center where it has been marking time for the past three years.

Basic to the program is the determination of the labor movement to protect the sanctity of contracts signed in good faith by employers and employees.

Under the Nixon stabilization policies, the provisions of collective bargaining agreements have been superseded by presidential edict.

The delegates were unanimous in their determination that the sanctity of contracts must be re-established and re-affirmed. Therefore, the AFL-CIO will cooperate with the Nixon stabilization program only so long as there is reasonable hope that collective bargaining agreements shall mean what they say.

Beyond the determination of the labor movement to keep collective bargaining what it has been—a meeting of minds voluntarily arrived at by management and labor—the convention addressed itself to the most urgent needs of the country.

Primarily, the AFL-CIO insists that a top priority objective of the national economic policy must be the

establishment of a full employment policy. Too much of the effort to control inflation has been wrapped up in increasing the number of unemployed. This is a policy that places the bulk of the burden on working people.

Furthermore, it constitutes a very dangerous gambit, because once unemployment escalates, it is difficult to check.

Inherent in most of the problems facing the nation is the fact that unemployment creates tax problems for the government; welfare problems for the states and municipalities; and financing problems for primary, secondary and even college education. Until such time as full employment is attained, most of the other problems cannot be successfully solved.

Consumer Action

Among the other actions taken by the 891 delegates to the 9th Constitutional Convention was a broad program for providing greater protection for the nation's consumers.

Resolutions urging laws to compel more understandable labeling were favorably acted upon. The program called for consumer class legislation to enable bilked consumers to more

readily sue. The convention asked for a more adequate funding of the Occupational Safety and Health Act, so that the full intent of the Act can be carried out so as to protect the lives and limbs of working people.

High on the AFL-CIO's list of priorities was the establishment of national health security. The concept contained in the Kennedy-Griffith bill for comprehensive medical care received the unanimous support of the convention.

The national health security plan backed by the Convention insisted that there should be (1) universal coverage, whether employed or unemployed; (2) comprehensive benefits without exclusions or waiting periods, and, particularly, no limitations on physical examinations and other services; (3) free choice of physicians; (4) financing through Social Security with matching contributions from federal revenues; (5) effective cost controls.

The convention also demanded that a long range national policy be developed to better protect our dwindling natural resources.

The convention pledged that it would work unceasingly for the establishment of a minimum wage of at least \$2.50 an hour, and equal

President Nixon turns toward AFL-CIO President George Meany to make a point during his address to the AFL-CIO Convention at Bal Harbour, Fla., last month. Meany later suggested that the point of President Nixon's visit was "to contrive a situation under which he could claim that he had been unfairly treated." Despite their strong disagreement with his policies, delegates listened to the President with respectful attention and occasional applause. (For a commentary on the President's speech, see "In Conclusion" on Page 40.)



protection under the law for farm workers, and the same protection for workers in Puerto Rico as on the mainland.

Education also received the attention of the delegates. The decline in appropriations for vocational education alarmed the delegates, and there was unanimous support for measures to strengthen the funding of education from the kindergarten through college.

Some Tax Resolutions

The convention called for:

- Immediate enactment of an excess profits tax. "Such a tax should remain in effect during any period in which the wages of workers are subject to freezes, controls or restraints."

- Top priority to closing the capital gains tax loophole. "We believe that there cannot be tax justice so long as unearned income is half-taxed while earned income is taxed in full."

- Complete abolition of the special tax privileges of the oil, gas and other mineral industries.

- Ending tax exemption of interest from bonds issued by state and local governments. As an alternative, the resolution suggested, the federal government should guarantee the bonds and subsidize a part of the interest rates so that states and cities wouldn't be hurt by the change.

- Raising the minimum tax provisions which apply to income from "tax-sheltered sources" and which enable many wealthy people to pay a lower tax rate than workers whose earnings are taxed in full. At the same time, the convention said, the ceiling on taxation of the income of high-paid corporation executives should be eliminated.

- Enactment of new tax measures "to halt the export of U.S. jobs, remove the incentive to establish production and assembly facilities abroad, and create tax disincentives to curb expanded production abroad."

- Elimination of tax provisions "which contribute to the alarming trend of corporate mergers . . . and spur the growth of huge multinational corporations."

- A major overhaul of federal

estate and gift taxes as "a prerequisite to the achievement of tax justice."

Cooperation among AFL-CIO unions is essential to organizing success, convention delegates stressed in a major resolution.

Ways to Boost Economy

Here are 10 specific recommendations made by the AFL-CIO Executive Council to boost America's economy:

1. The Federal Government should re-establish full employment as the top-priority objective of national economic policy.

2. The President must immediately release the billions of dollars of Congressionally-appropriated funds he has sequestered and Congress must provide full funding for public investment programs such as education and housing.

3. Congress should establish interest rate ceilings and channel credit where it would best benefit the economy.

4. "Attainment of justice in the Federal tax structure is essential." The Council urged elimination of tax loopholes for the wealthy and modernization of state and local government tax structures.

5. "The stagnation of the real wages of American workers during most of the past six years must be ended. Increases in the buying power of workers' wages and salaries are a basic prerequisite for economic growth."

6. Government action "to curtail the high rate of business mergers and conglomerate takeovers" and a Congressional study "of the structure of the American economy."

7. "Development of practical, sensible measures to dampen" soaring pressures on the cost of living from physicians' fees, hospital charges, housing costs and auto insurance.

8. Overall stabilization measures on all costs and all incomes.

9. Federal inventory of national needs for housing, community facilities and public services.

10. A Federal technological clearing house to gather information on a continuing basis on technological change and its effects on the welfare of the American people.

The resolution was based on an Executive Council report that organizing gains in the private sector of the economy have been slowed by a tough anti-union campaign by employers, coupled with a National Labor Relations Board that is being transformed through Pres. Nixon's appointments to reflect "an anti-union, pro-employer interpretation and administration of the labor act."

Against this backdrop, the convention said, "the skill of the individual organizer must be of a higher order and the emphasis placed by unions on their organizing mission of greater intensity."

It called on affiliates "to assure that their organizing program receives the necessary money, material and trained manpower."

It is "crucial" to eliminate organizational conflict between unions, the convention said.

But beyond elimination of needless rivalry, the resolution urged the importance of active cooperation in organizing campaigns.

Organizing Assistance

There are times in organizing campaigns "when it is important to call on other unions for cooperation." And when such a call is made, the convention urged, the cooperation should be quickly forthcoming. "This is the rationale of federation."

The convention resolution called on affiliates "to take part in cooperative organizing programs initiated by the AFL-CIO, whether on a territorial, industrial, company or work location basis."

And the resolution included a reminder of the deeper purpose behind labor's organizing effort—to enable workers to use the machinery of collective bargaining "to provide answers to their problems on the job, to give expression to their hopes and protection from their fears."

It reaffirmed also labor's conviction that "the American concept of trade unionism still offers working men and women the most effective procedures for attaining economic stability for themselves and their families, while contributing to the social progress and general welfare of the community." ■

The Pay Board Has Taken Money Which Is Legally and Rightfully Due Workers and Put it into the Hands Of Employers, Say Building Trades

■ America's building tradesmen prepared to meet the challenges of the nation's inflated economy and the inequities of President Nixon's wage-price freeze in a three-day convention, last month, in Bal Harbour, Florida.

A total of 258 delegates, representing 17 international and national labor unions—nearly 3.5 million construction workers in all—assembled at the Americana Hotel to prepare for the uncertainties of Phase II of the wage freeze.

A telegram to the convention from AFL-CIO President George Meany assured the building tradesmen that labor will not stand still "and see our contracts abrogated, our work standards destroyed, our earnings drastically diminished while all around us other sectors of the

economy are doing business as usual."

In response, the building trades unions expressed support of Mr. Meany's stand at the Wage Board meetings in Washington.

Their leaders stated: "No economic program can succeed unless it is based on the single fundamental principle of equality. Labor is perfectly willing to sacrifice, but sacrifice must be equal and across-the-board.

"In setting a 5.5 per cent maximum increase in new contracts, including wage and fringe benefits and denying retroactivity for the freeze period, except under the most unusual circumstances the Pay Board has taken money which is legally and rightfully due workers and put it into the hands of employers."

The convention heard assurances

from two U. S. Labor Department spokesmen that its views would be carefully considered in White House wage-price planning. Assistant Labor Secretary William J. Usery and Under Secretary Lawrence Silberman addressed the delegates.

The convention heard encouraging reports of progress in minority hirings and apprenticeship training from Donald Slaiman, director of the AFL-CIO Civil Rights Department, and from Norman Hall, associate director of the A. Philip Randolph Institute. Robert McGlotten, director of the Human Resources Development Institute, emphasized that the Building Trades must not lower their acceptance and training standards for minorities, that minority journeymen must remain proud of their position in their crafts. ■



Building Trades Make Sweeping Changes in Council Operations

■ The biennial convention of the AFL-CIO Building and Construction Trades Department empowered the department's top officers to make sweeping changes in the operation of its 531 state, local and provincial councils.

The constitutional change authorizes the department's executive council or the president, acting on its behalf, to "merge or to amalgamate local . . . councils or to modify or to alter their jurisdiction when it deems such action necessary in the interests of the department."

A spokesman for the department said the measure could result in the elimination of as many as 200 of the local councils and would be particularly effective in preventing problems caused by overlapping jurisdictions.

In presenting the resolution to the convention, Sec. Frank Hanley of the laws committee, said its purpose is "to improve the efficiency of the councils in order to meet our current problems, including the growth of non-union construction, by vesting the necessary power in the executive

council."

"Action can be taken to meet many of the problems which have confronted the councils, such as inadequate financing and partial participation by local unions," Hanley said.

The measure also empowers the executive council to issue rules governing "the conduct, activities, affairs, finances and property" of the local councils, plus disciplinary procedures and guidelines for retirement benefits for full-time officers where feasible. ■

Non-Union Construction Is Making Inroads, Bonadio Reports

■ The problems of non-union construction were discussed by Building Trades President Frank Bonadio at the recent Building Trades Convention.

"Although there are no authoritative figures on this subject, we have every reason to believe that non-union construction work has been growing considerably," he told convention delegates. "It is our task to keep this work within appropriate limits if the standard of living of the union worker is not to be destroyed in this country.

"We must, of course, organize despite all the difficulties which have been created by unfair federal legislation. And despite the dim prospects of success in the legislative field, we must endeavor to secure a Congress which will recognize the justice of our position and relieve us of the onerous provisions of the Taft-Hartley and Landrum-Griffin Acts.

"At the same time, we must tighten our own operations and increase productivity so that the union contractor will have a better chance to compete in the marketplace with the non-union contractor. A most important step in this direction is the NCA-Building and Construction Trades Department Jurisdictional Agreement. It was worked out after many sessions between a committee of General Presidents and a committee of members of the National Constructors Association.

"I am sure you are all familiar with its provisions. Thus far, the Agreement has proved to be quite successful in terms of eliminating work stoppages on projects subject to the Agreement. Indeed, work stoppages for jurisdictional purposes on all jobs covered by the National Joint Board have also shown a marked decline. A reduction in these stoppages, which are not necessary for the amicable set-

tlement of jurisdictional disputes, can only serve to improve the position of our employers in competing with non-union contractors."

Bonadio expressed confidence that the NCA-Building and Construction Trades Rules Agreement will be a success.

"In looking back over the events of the last few years, it is evident to me that any success which the plans and procedures developed by the Executive Council and the General Presidents has had, has been due to the cooperation which you have extended. This is an essential ingredient in the operations of the Building and Construction Trades Department. Let us remember that, when the outside pressures increase, it becomes all the more necessary that there be a fuller degree of cooperation inside the building and construction trades in order to accomplish our important objectives in the interests of the membership." ■



The Brotherhood's General President, M. A. Hutcheson, served as chairman of the Committee on the Executive Council Report, during the recent Building and Construction Trades Convention. At left, President Hutcheson discusses the committee work with delegates.



DONALD SLAIMAN
Director, Civil Rights
Department, AFL-CIO

Three Building Trades Convention Speakers Indicate:

Minority Workers Make Heavy Gains In Construction Unions



NORMAN HILL
Associate Director,
A. Philip Randolph
Institute

■ The sharp upturn in the number of minority group members entering the building trades apprenticeship programs was spotlighted at the 56th convention of the AFL-CIO Building and Construction Trades Department.

Donald Slaiman, director of Civil Rights for the AFL-CIO, told delegates that "in the whole American labor market there isn't an area dealing with skilled and higher paid jobs which has seen more progress for minority youth and minority workers than the area of building trades apprenticeship."

He offered some comparisons, noting that in the early 1960's the National Association for the Advancement of Colored People reported that "less than 2½ percent of the federally-registered apprentices throughout the country were members of minority groups."

Slaiman said that the Secretary of Labor reported this had risen to six percent in 1967, eight percent in 1968, 10 percent in 1969 and to 12 percent in 1970. He said that 13.4 percent today is accurate.

The latest report of the Labor Department on apprentices in the Operation Outreach program, recruited by the building trades, the Urban League and the Workers Defense League, Slaiman said, now passes 12,000.

Norman Hill, associate director for the A. Philip Randolph Institute, spoke to the convention in place of

Bayard Rustin, who was recovering from a heart attack. He lashed out at Nixon Administration programs.

"If Nixon succeeds in separating the labor movement from the black community," he said, "the burden will fall on the workers. I can think of no better illustration than Nixon's attempt to set blacks and building trades at one another's throats by making them compete for a few jobs during a time of recession and increasing unemployment.

"I think it is time we understood clearly that when this Administration concocted its Philadelphia Plan, it was motivated by political considerations rather than an idealistic desire to assist black workers."

Another black speaker at the convention was Robert McGlotten, of the AFL-CIO Human Resources Development Institute. He told the delegates, "You have made some progress in the whole question of minority participation in the building trades," adding:

"I think we have to go beyond that because we have to recognize that there are people out there who would like to tear down the building trades structure, tear down your hiring halls, tear down your apprenticeship structure."

His advice to delegates: "Don't lower any standards for any black, red or brown kids. Keep your standards high so they can hold their heads high." (PAI) ■

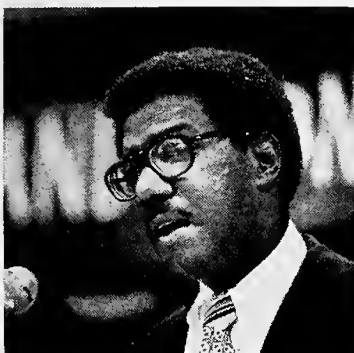

ROBERT MCGLOTTEN
Director, Human
Resources Development
Institute

Convention Speakers

DR. JOHN T. DUNLOP, chairman of the Construction Industry Stabilization Committee, told Building Tradesmen at Bal Harbour, last month, that "it is likely" his committee will continue to enjoy what he described as "administrative independence" from the Pay Board during Phase 2, issuing its own rulings on wage increases in the construction industry.

"This industry should continue at a craft board level and at a stabilization committee level, so that individual case-by-case problems are handled by persons familiar with the industry's 'special characteristics and peculiarities,'" he commented.

His board's independence will have to conform to certain broad policy guidelines, which it will have to discuss with the Pay Board, he added.

"I have some doubts whether the generalized rules which they develop and announce will be directly applicable to the special conditions in this industry. And we may need some special arrangement to apply rules which do not make sense here."

WILLIAM J. COUR, chairman of the National Joint Board for the Settlement of Jurisdictional Disputes in the Construction Industry, told Building Tradesmen that their unions have "got a lot of mileage" out of the National Joint Board.

"How much more you are going to get from this, or any other similar industry plan is going to depend on you. Frankly, if some steps aren't taken to improve the existing plan and to make it work, you might not even get an opportunity to set up another plan. There are those who believe you aren't capable of settling your own jurisdictional disputes, and who frankly feel that legislation is the only answer to jurisdictional disputes in this industry.

"Some legislation to that effect has already been introduced, and some more will undoubtedly follow.

"I believe that this is the time for all those who are asking what is wrong with the Joint Board plan to sit down and do a little soul searching. Many of those who are asking the question are either unfamiliar with the operations of the Joint Board, or have lost the sight of the original intent and purpose somewhere along the line, and, gentlemen, when this happens, I think it's time to take another look at fundamentals."

JOHN E. HEALY, II, President of the Associated General Contractors of America, spoke briefly on the problems of productivity. He said this:

"When I talk about productivity, I want you to understand that I fully recognize management's responsibility in the productivity picture, management's responsibility to run projects so that productivity can be achieved. We must run our projects on schedule; we must man our projects with the proper number of people; we must order our materials and equipment to be there in time to be used to allow for productivity, and I might say there is an awful lot of room for improvement on our part in this respect.

"It is incredible in this industry, for instance, that we have not developed performance standards in construction as has been done in the manufacturing industries. We have not indulged the principles of industrial engineering in any significant degree. We have not studied crew sizes and the productivity which should be expected. We have not studied the crafts and arrived at legitimate craft differentials based on possible annual hours, skills required, amount of training involved, amount of continuing education required to stay current with technological progress."





Construction to Show Continued Growth in 1972

F. W. Dodge Forecasts Major Gains in Industrial Commercial, Transportation, Environmental Areas

■ Increased nonresidential construction next year, plus housing close to this year's level, will lift construction contract value four per cent, to \$82.6 billion, in 1972. This compares with an expected total of \$79.8 billion in construction contracts for 1971, based on eight months' figures already in, it was reported by McGraw-Hill Information Systems Company, producers of Dodge Reports and Sweet's Catalogs, in its annual forecast of construction markets.

In 1972, the seasonally-adjusted Dodge Index (1967=100) is expected to advance to 150 from 1971's 145, according to George A. Christie, the Company's vice president and chief economist.

Big Gain in 1971

He pointed out that 1972's four per cent increase in construction contracts will be following "an exploding 1971 construction market" that is expected to post a 17 per cent gain over the previous year. "This means that 1971's very strong expansion isn't just a temporary surge, it is a future base on which additional growth will be built."

The economist believes the greatest gains in 1972 will be in industrial building, stores and other commercial buildings, transportation, and environmental work such as sewer and water facilities.

These points were made by Christie in an address on the 1972 *F. W. Dodge Construction Outlook* delivered last month at the Building Products Executives Conference sponsored by McGraw-Hill Information Systems Company. The meeting at Washington's Statler Hilton, included addresses by HUD Secretary George Romney, Senator Edmund S. Muskie, Mayor Kenneth Gibson of Newark, and was attended by some 600 leaders from the construction and building products industry.

The *F. W. Dodge Construction Outlook*, based on construction data compiled by the Company's F. W. Dodge Division, also included an analysis of construction markets in the Northeast, Midwest, South and West.

Throughout the nation, both nonbuilding and nonresidential construction are expected to post comparable gains in 1972. A nine per cent increase in contracts totaling \$21.6 billion is forecast for nonbuilding contracts. In this category, construction of sewer and water facilities is expected to show the largest increase, 15 per cent, followed by highway contracting, up 10 per cent. A seven per cent increase is foreseen for nonresidential construction, with contracts reaching \$27.2 billion. In the latter category, manufacturing construction alone should rise 25 per cent. Residential building, which ac-

counted for most of 1971's impressive gain, is expected to be down two per cent, to \$33.9 billion.

Greatest overall construction gains should occur in the Midwest, with an estimated rise of seven per cent, followed by the Northeast, with a five per cent increase, and the South, up two per cent. Construction in the West, however, will show a one per cent decline.

Economic Environment

The 1972 Gross National Product, now estimated at \$1,150 billion, will benefit from President Nixon's economic plans to control inflation, believes Christie. "The Administration's new program not only improves the chances that next year will really achieve this total; it should also make next year's growth more meaningful," he said. He sees the impact, however, more on the quality than the quantity of next year's economic activity.

With the wage-price freeze and Phase Two now assuming most of the burden of anti-inflationary restraint, monetary policymakers can now give top priority to holding down interest rates and insuring an adequate supply of funds to meet expanding business and personal credit needs in 1972, according to Christie.

"This kind of monetary climate eliminates one major problem area

from the 1972 construction outlook," he pointed out. "The free and easy days are over, but there's no need to expect a new credit crunch, no serious threat of another round of disintermediation, no reason why privately financed construction should be curtailed by a shortage of funds in the year ahead."

Business Facilities

Although indications point to a further improvement in profitability as a result of the NEP, there is bound to be a lag before the anticipated rise in production and earnings sets up a "surge of industrial building," Christie observed. By mid-1972, however, he anticipates a strong pickup in the rate of contracting for new industrial building needed for 1973 operations. He said that 1972 industrial construction is expected to be 25 per cent over 1971's depressed level.

Office building construction, reflecting a rising volume of smaller office buildings rather than skyscrapers, is expected to show a slight advance in 1972, to \$4.8 billion, but substantially below the record of \$5.4 billion in the peak year of 1969.

Store building, which has been little affected by the recession, will be responding to 1971's housing surge in 1972. Gains of between 15 and 20 per cent are foreseen. Utility construction, geared to meeting industry's goal of adding some 40 per cent more capacity by 1975, is expected to rise just a shade above 1971's "very strong" \$5.3 billion.

Institutional Buildings

In 1971, for the first time, college construction equaled elementary school construction. A six per cent increase in educational construction is forecast for next year, with the shift continuing: less building at the lower grades; steady in the middle; expansion at the top, but with severe budget restraint holding the growth of colleges below their potential.

There's no evidence of any slowdown in the strong upward trend of hospital construction that began in the Sixties. Contracting for hospital and health facilities in 1972 is headed for a 10 per cent gain, according to Christie.

Housing

1971 was the biggest year in history for the production of shelter, with the number of units around the two-million mark and "finally in touch with HUD's much-heralded goals," said Christie. Housing has now become a growth industry, he believes, because of two factors: the increased role of the Federal government in generating a sustained volume of low- and middle-income housing through several subsidy programs; government efforts to stabilize the mortgage market and offset the severe swings in the flow of housing funds that originate in other sectors of the economy.

Christie believes that homebuilding in 1972 will settle at a level of 1.95 million site-built and modular units, plus about 400,000 mobile homes, Housing, despite the slight decline from 1971's peak, will have another very strong year.

Public Facilities

The Administration's release in September of previously withheld highway money and additional tax revenues produced a rapid acceleration of contracting in the late months of 1971. This is expected to carry over into most of 1972. Next year's highway contracting could show a gain of as much as 10 per cent, well above the average growth rate of the past several years. According to Christie, the impact on construction of new airport plans is a year or more away, since only planning and development money is available now.

The Dodge economist said that states and municipalities will be borrowing heavily in the bond market again in 1972, since there is little prospect of an increase in Federal help next year. One exception will be Federal money for the construction of water supply and sewage disposal systems, which should show a 15 per cent increase in 1972. ■

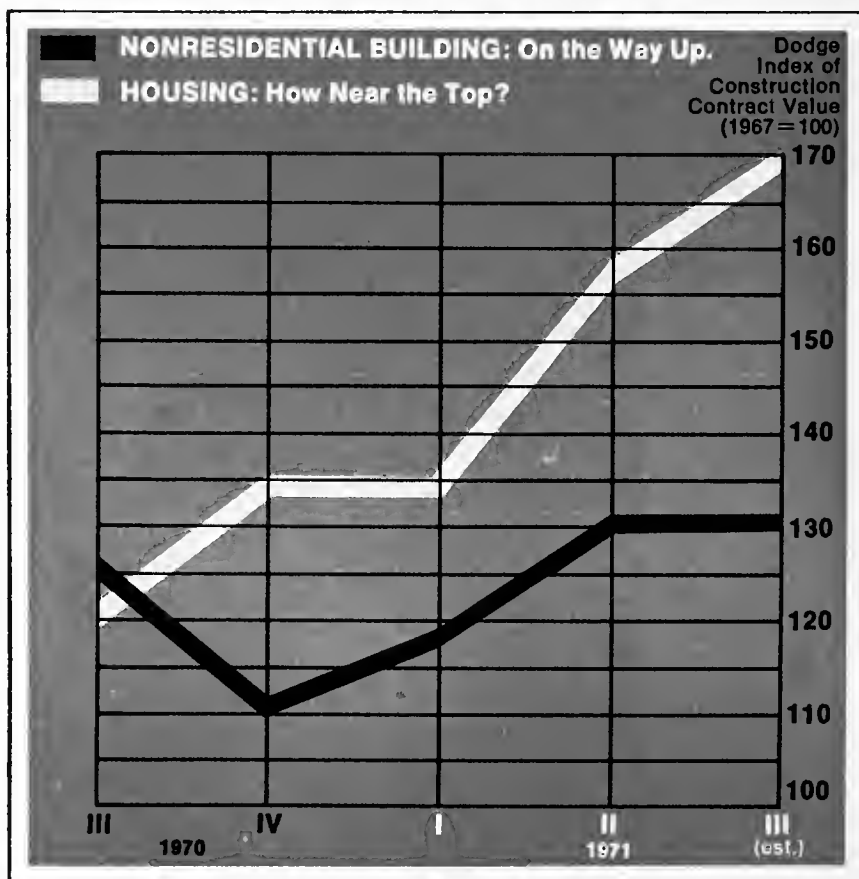



ASBESTOS STANDARDS--The AFL-CIO has called on the Secretary of Labor to issue emergency standards on the industrial use of asbestos, saying the health and lives of "five million workers" exposed to airborne asbestos dust on their jobs are at stake.

George Taylor, executive secretary of the AFL-CIO Occupational Safety and Health Committee, asked Labor Secretary James D. Hodgson to use emergency powers given him under the 1970 Occupational Health and Safety Act. He also called on him to notify the administrator of the Environmental Protection Agency to take action under the imminent danger provisions of the Clean Air Act to protect communities against asbestos pollution.

HEALTH MANPOWER BILLS--The Congress has sent two medical manpower bills to the President which the labor movement calls "the best we've ever had" but there's no indication yet as to whether Nixon will sign the measures.

The bills call for the spending of some \$3.7 billion over three years to train more health personnel—doctors, dentists, nurses, veterinarians as well as sub-professional training for physicians' assistants and dental therapists. Congress has actually appropriated \$660 million for similar training programs over the last three physical years.

COST CONTROLS--Congress should apply the lessons learned in the operation of the five-year-old Medicare health insurance program for the elderly in setting up a Federal health care program for all Americans, Nelson H. Cruikshank, president of the 3,000,000-member National Council of Senior Citizens, has told the House Ways and Means Committee.

MORE EXAMINERS--The National Labor Relations Board has appointed six new trial examiners in an effort to cope with its "growing caseload". The six include Eugene G. Goslee who has been serving as NLRB solicitor since November 1970. The six bring to 99 the total number of trial examiners.

A NEW MUSICAL REVIEW on ecology, "Mother Earth", stunned a number of Richard Nixon's millionaire supporters in the audience with this line, "If you want to know what God thinks of money, just look at the people he gives it to."

A DEADLY IMPENETRABLE SILENCE settled down over the U.S. House of Representatives after Rep. John Y. McCollister (R-Nebr.) finished his speech. Rep. McCollister suggested that because millions of Americans are making sacrifices as a result of the wage freeze, members of Congress ought to cut their own salaries by 10%, from \$42,500 to \$38,250. The Nebraska Congressman contended that the 42% salary increase which Congress voted for itself a couple of years ago contributed toward inflation.

AFL-CIO OPPOSES MERGER--Legislation that would legalize the acquisition of Pacific Northwest Pipeline Company by El Paso Natural Gas Company—rejected four times by the U.S. Supreme Court—is being strongly opposed by the AFL-CIO.

In a letter to Senator Warren G. Magnuson, chairman of the Senate Committee on Commerce, AFL-CIO Legislative Director Andrew J. Biemiller charged that the bill is not only a "perversion of the anti-trust law and policy", but that "if it is enacted, one huge corporation after another will use it as a precedent to ask Congress for legislative relief from adverse court decisions."

'WATCHDOG' GROUPS--The AFL-CIO has told President Nixon's newly-appointed Price Commission that labor watchdog committees are reporting illegal price increases on everything from "candy bars to gasoline."

PETER TERZICK HONORED

IN ONE OF WASHINGTON'S LARGEST TESTIMONIAL DINNERS

More than 1200 friends and associates recently paid tribute to the long and exemplary service of Peter E. Terzick, retired General Treasurer of the Brotherhood. They assembled in the International Ballroom of the Washington Hilton in the nation's capital, October 29, in

one of the largest testimonial gatherings ever held in the nation's capital.

Among the guests were AFL-CIO President George Meany, AFL-CIO Secretary-Treasurer Lane Kirkland, and many Congressmen, Senators, and industry officials with whom



A beaming Peter Terzick holds the honorary gold card making him a member for life in the United Brotherhood of Carpenters and Joiners of America.



Second Gen'l. VP Herbert Skinner presents gifts from the General Executive Board to Mrs. Terzick.



General President M. A. Hutcheson adds his best wishes to those of the audience.



Peter Terzick; daughter, Jane; wife, Hazel; and son-in-law, Ron Varner.



The honoree admires a string of pearls presented to Mrs. Terzick by his fellow officers.



A relaxed conversation with AFL-CIO Secretary-Treasurer Lane Kirkland before the dinner.



First Gen'l. VP William Sidell presents the big gift of the night — keys to a new automobile.



Connie Olsen, secretary of the New York District Council, presents a gift from his organization.

Terzick has worked during his 34 years of service to the Brotherhood.

Terzick acknowledged the tributes in a brief, warm speech.

The retiree has served the Brotherhood in many capacities, and he will continue to serve as editor of *The Carpenter*. He tendered his resignation as General Treasurer to the July meeting of the General Executive Board.



Meany's Address at Testimonial Dinner Reverberates Through Nation's Capital

■ AFL-CIO President George Meany spoke at the retirement dinner for Peter Terzick, calling the honoree "an old fashioned trade unionist dedicated to the welfare and interest of his membership and dedicated to the improvement of the society of which we are a part."

He told the audience that he had once worked in the Carpenters' jurisdiction: "I worked as a dock builder for about three weeks. They were short of dock builders over in Port Newark in the early months of 1918. . . . I think Morris (Gen'l. Pres. Hutcheson) was working over there, too. And they just said, 'Well, any member of the building trades with a paid-up card can work. We need some people who can work as dock builders, constructing this facility which the government needs badly.' And there was no question of paying dues. You just went to work, and when you went to work, they said, 'Well, let's see your card.' And if it was Plumbers' card, an Electricians' card, you went to work. That is the way we worked in those days. . . . But after about three weeks, I discovered that plumbing was much better than dock building."

Much of the AFL-CIO, president's address was devoted to a timely discussion of the troubles labor faces in what he called "the age of deceit" and "1971 realism."

He made one of the strongest attacks yet on President Nixon's policies, including his present attitude toward Communist China. He said the President was once the No. 1 anti-Communist "I know, because I was No. 2. . . . Well, now he is a realist . . . someone who accepts things as they are." Meany deplored our new way of dealing with Chinese and Russian communism and with the military dictatorship of Greece.

He also criticized the Administration's "Madison Avenue techniques."

Mr. Nixon puts on his grease paint and makes a speech, and the stock market goes up. . . . Then the business tycoons ask, 'What the h— did he say?' He didn't say anything. So then the market goes down."

"Now the game is labor," he commented. "Labor is to blame for everything."

He warned that working people faced serious days ahead, but that we must keep our principles and deal in simple truths.



Congressman Lloyd Meeds and Mrs. Meeds from the State of Washington join the festivities in Washington.

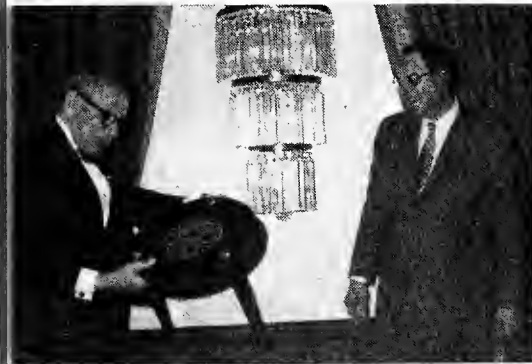

Congressman Bob Gaimo of Connecticut presents a gift from Speaker of the House Carl Albert to the honoree.



A resolution of commendation and best wishes from the General Executive Board, presented by Sec. R. E. Livingston.

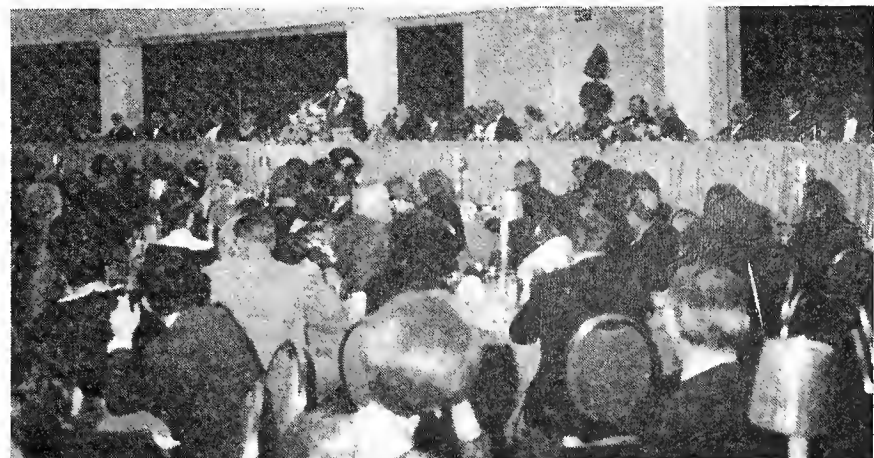

A view across the ballroom, as President Meany addresses the testimonial gathering.



The New Disneyworld

*...all union made
and proud of it*

High praise for its union workers and a testimony to their skills and their ability to work under pressure were given recently by the president of Walt Disney Productions.

The fantasy world of Disney produced one of the biggest construction jobs of 1971. It was an all-union operation employing more than 7,000 skilled craftsmen including thousands of members of the Brotherhood.

The statement by the president of Walt Disney Productions appears at left.

It is timely and appropriate for the Disney organization publicly to acknowledge organized labor's significant contribution to the construction of our new 'Vacation Kingdom.'

Seventeen International and National Unions and their local Florida affiliates have provided skilled workmen who are their members to facilitate the construction.

The unions, members of the Building and Construction Trades Department, AFL-CIO, and the International Brotherhood of Teamsters negotiated an agreement with Disney in 1968 which is truly unique in the history of the construction industry.

Organized labor recognized the unique technical and creative problems in the vast recreational project and, together with representatives of Disney management, they met this challenge in an historic collective bargaining agreement.

The contract was designed to provide labor peace and to permit the company to utilize the most advanced techniques of construction and freely enlist the services of technicians and skilled artists from all parts of the country.

At the height of construction, approximately 7,000 building trades people were employed on the job site. It is a remarkable achievement for the building trades unions that, with so many different skills represented on the job site, the project was virtually free of strikes.

The experience gained at Walt Disney World through the application of many of these new construction techniques is sure to benefit all mankind in the years to come.

-DONN B. TATUM
President, Walt Disney Productions



1

SERVICE TO THE BROTHERHOOD

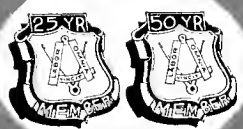

A gallery of pictures showing some of the senior members of the Brotherhood who recently received 25-year or 50-year service pins.

(1) MOUNTAIN VIEW, CALIF.—On April 24, 1971, Local 1280 held its 12th annual 25-year pin presentation party. Twenty-seven members received 25-year pins, and one member received a 50-year pin. Approximately 400 members and guests were on hand as Clarence Briggs, general representative of Local 1280, made the pin presentations. Pictured in the front row, from left, are Primo Bonilla, Lawrence Johnson, Lawrence Rhett, Wayne Bradford (50-year pin), Walter Zerkas, Archie T. Hughes, Gus Bordi, and Lawrence Domich. In the middle row, from left, are James Conway, Fred J. Simpson, Irwin Fortin, William Gipson, Tony Dominick, Erwin H. Collins, Earl Steelman, David L. Heck, and John Tuttle. Pictured in the last row, from left, are George Johnson, John Switzer, George Friis, Earl Chapman, E. R. Oswald, Joe McCain, Walter Elrod, Francis Burkett, Albert Wilson, and Dewey King. Denver Conour, not in the photograph, also received a 25-year pin.

(2) Members and guests attending Local 1280's pin presentation ceremonies were also treated to a buffet dinner prepared



2

by Ladies Auxiliary 554. Pictured here are, back row, from left: Hope Marquez, trustee; Vera Alvord, trustee; Leone Keeline, secretary; and Vista Kimmel, president. Seen in the front row, from left, are Norma Allen, treasurer; Averil Dicks, conductor; and Alvine Hopkins, vice-president.

(3) PITTSBURGH, PA.—Millwrights Local 2235 honored its 25-year members at its annual picnic, last August. Honored

were: STANDING, left to right, E. Weddle, F. Irvin, J. Craig, J. Kelley, T. Tobin, F. Finney, W. Grimm (International Representative), R. Mitchell (President, L.U. 2235); KNEELING, left to right, J. Senge (Secretary-Treasurer of the Carpenters District Council of Western Pennsylvania), E. VanRyn, J. Hess, M. Stange, R. Whitehead, A. Bosiljevac; MISSING FROM THE PICTURE—T. Danzey, J. Herbenak, H. Huggler, J. Krilowicz, G. Sweeley, H. Thompson.

3



Planning for the Postwar World

*... as described by Max Schulman
25 years ago ... two wars ago ...
many, many economic upheavals ago ...
has it changed so little?*

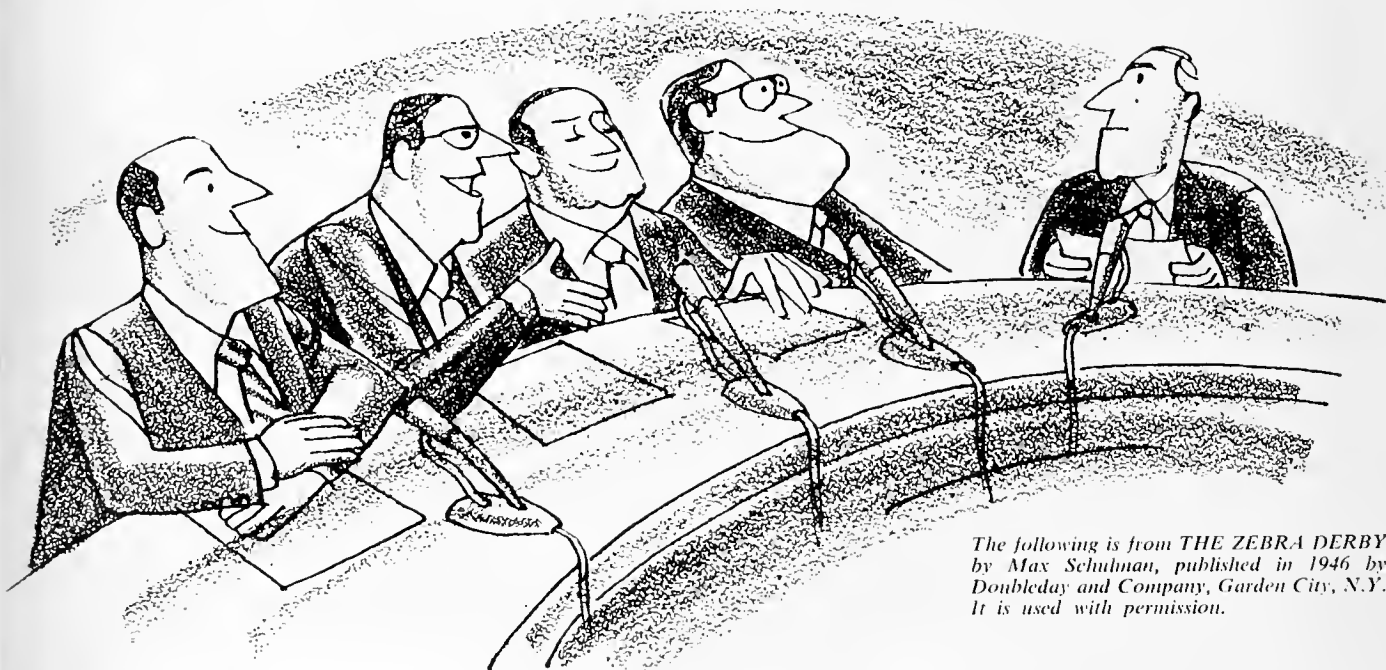

*The following is from THE ZEBRA DERBY
by Max Schulman, published in 1946 by
Doubleday and Company, Garden City, N.Y.
It is used with permission.*

■ There was no anxiety in my beating heart as I stood on the station platform waiting for the old Cannonball to take me to Minneapolis, but there was curiosity. I knew that whatever I found would be good, but I could not help wondering what I would find. What had the planners planned for me? What delights were in store for me? What visions, born of the finest minds of the land and perfected through the long years of the war would I realize?

For postwar planning in these United States was no Johnny-come-lately. Our people had not waited for the last shot of the war to be fired before they began to plan for peace. No siree. Not our people. Why,

some of our more foresighted industrialist had thought of peace even as they tooled for war. Yes siree. No peace was going to catch old Uncle Sam with his gaiters down, by gum.

I remember, for instance, a night in 1943, a few weeks after I had been inducted. My buddies and I were all sitting around the barracks. There was a war movie on at the post theater, so we were all sitting around the barracks. Someone turned on the radio and (this was 1943, mind you) we heard a round-table discussion of the National Association of Rich Millionaires. Their topic (in 1943 yet) was "Planning for the Postwar World."

What a galaxy of tycoons was assembled before the microphone that night! There was Max Ballanfont (oil) and Max Pilfering (steel) and Max Clodde (textiles) and Max Hawing (railroads) and Max Onus (tools) and Max Nipthung (abrasives). Without ado they plunged into the problem at hand.

"Gentlemen," said the moderator, "our topic tonight is 'Planning for the Postwar World.' Who would like to open the discussion?"

HAWING (railroads): I would like to tell a little anecdote that I think illustrates very well the importance of planning. When my little son Money was five years old I said to him, "Money, you're old enough to learn a few things now. I'm going to teach you the value of thrift and foresight. From now on you are going to receive a weekly allowance. You must plan your expenses according to your allowance, because if you run out of money before the end of the week, Mummy and Daddy won't give you any more."

Well, sir, at first it didn't work out at all. Little Money would go out on Monday morning with all his allowance and buy every foolish thing he set his eyes on, and by Tuesday he was broke. He would come crying to me for more money, but I would say, "No, Money, no money. You'll have to learn to plan your expenses. You'll have to stop frittering away all your allowance on foolishness. Money, why don't you pick something you really want, something big and lasting, and save up for that instead of buying all this nonsense?"

Well, sir, after that several weeks went by and Money didn't ask me for a cent. I knew he was saving up for something. Finally he came home with a large package and unwrapped it and took out a fine hunting gun. "There, Money," I said, "you see what comes of being thrifty and planning for the future? Wasn't Daddy right?"

"All right, you * * *," said Money. "get your mits in the air. Now tell me the combination of the wall safe."

And through careful planning that little tyke made off with eight million dollars.

NIPHTHUNG (abrasives): Your little story certainly does illustrate the value of planning, Mr. Hawing. You're absolutely right. We must plan right now. How can we be sure the war is going to last until 1944? It may be over in six months; it may be over tomorrow. That's why we must plan now.

MODERATOR: We are agreed, then, that the time to plan is now. Next let us take up the question of who is to do the planning. By latest count there are 435,804 government and private agencies planning for the postwar. Don't you think that such a situation might result in chaos? Wouldn't it be better to have one master plan?

BALLANFONT (oil): No! A master plan necessitates a master. That is totalitarianism. That is not the American way. I say you cannot take away the right of the people to plan. This nation was built on individual planning and private enterprise. American boys gave their lives at Bunker Hill and Shiloh and the Marne and Tarawa to preserve free capitalism. I say that this nation, under God and free private enterprise, shall never bow beneath a tyrant's yoke. I say that if individual planning means chaos—and, mark you, I don't believe it does—but if it does, I say, better chaotic democracy than efficient totalitarianism.

CLODDE (textiles): I would like to say that I agree one thousand per cent with what Mr. Ballanfont said and that Mrs. Clodde and I would be honored to have him and Mrs. Ballanfont to dinner next Friday evening if they don't mind simple food.

BALLANFONT (oil): Indeed we don't, Mr. Clodde, indeed we don't. Simple food and homely virtues, we always say.

CLODDE (textiles): Mrs. Clodde and I always say, I'd rather be solvent than president.

PILFERING (steel): Mrs. Pilfering and I always say, it takes a heap o' heapin' to make a heap a heap.

MODERATOR: Mrs. Moderator and I always say, stuff a cold and starve a fever. But to get back to postwar planning, what do you gentlemen think about government regulation after the war?

HAWING (railroads): First of all, taxes that throttle initiative and stem the healthful flow of commerce must be reduced at once.

ALL (oil, steel, textiles, tools, and abrasives): Yes!

ONUS (tools): And there must be a high tariff to protect our infant industry.

NIPHTHUNG (abrasives): All government regulation must cease the minute the war is over. In war we accepted government regulation cheerfully. Why, my associates and I were actually laughing and singing when the troops carried us out of our plant. But when this emergency is ended, then government regulation must cease without delay.

BALLANFONT (oil): Absolutely. Government regulation is the way to totalitarianism. It is not the American way. It is not the way that made this nation the mightiest on the face of the earth. The silent graves at Valley Forge and Chickamauga and Château-Thierry and Guadalcanal are monuments to the system of free private enterprise. Shall we desecrate those graves? Shall we profane those monuments? I say that if the end of government regulation means chaos—and mark you, I don't believe it does—but if it does, I say, better chaotic democracy than efficient totalitarianism.

CLODDE (textiles): I agree two thousand per cent with what Mr. Ballanfont says and I would like to inform him that we will have a bottle of domestic wine with dinner next Friday evening.

PILFERING (steel): And I agree too. The first requisite of a prosperous postwar America is the immediate end of government regulation.

Concluded on Page 20

PERFECT GIFTS FOR TRUE CRAFTSMEN



**WORLD'S FINEST
NAIL HAMMER**

**SUPREME
HAMMER**

E3-16
16 oz.
only
\$7.30

• Forged One Piece Solid Steel • Strongest Construction Known • Unsurpassed Estwing Temper, Balance and Finish • PLUS . . . Exclusive Nylon-Vinyl Deep Cushion Safe-T-Grip . . . Molded on Permanently . . . Can't Loosen, Come Off or Wear Out.

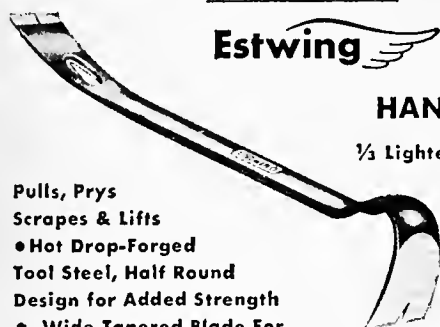

Estwing

HANDY-BAR

1/2 Lighter—But Stronger

Weight - 18 Oz.

Length - 15"

No. H8-15

\$2.98

List

Pulls, Prys

Scrapes & Lifts

• Hot Drop-Forged

Tool Steel, Half Round

Design for Added Strength

• Wide Tapered Blade For

Mar Proof Prying and Easy Nail Pulling



Estwing

PRY-BAR

Featherweight - only

22 Oz. Length 18"

No. PB18

\$4.40

List

• Forged One Piece "I" Beam Construction

• Double Polished Hammer Faces Lets You Drive Bar Either Way

• Unsurpassed Estwing Tool Steel, Temper and Finish

**FOR ALL
PRYING AND
PULLING**

FOR SAFETY SAKE—

Always wear Estwing Safety Goggles when using hand tools—protect your eyes from flying splinters, chips, fragments, dust, etc.

If Your Dealer Can't Supply You with Estwing Tools—Order Direct. Send Check or Money Order for Prepaid Shipment.

Estwing

MFG. CO. DEPT. C-12

2647 8th STREET

ROCKFORD, ILLINOIS 61101

Planning For The Postwar World

Continued from Page 19

HAWING (railroads): My feelings exactly.

NIPTHUNG (abrasives): Me, too.

MODERATOR: Fine. Then we are all agreed that the government should keep its hands off business. Now let us take up the question of labor.

NIPTHUNG (abrasives): The government has got to step in and regulate unions. We simply cannot have this intolerable labor situation. I speak as a lifelong friend of labor; why, at my plant the company police carry truncheons made of *soft* rubber. (There was an article about it in **Fortune** last month.) But I feel that the time has come when the government must put a stop to the abuses of labor. If unions would come to their senses, they would realize that they are only cutting their own throats by their present conduct. They are upsetting our whole economy and they will suffer for it. They are kindling a fire of public indignation that will someday destroy them. I hate to see it happen. If labor were wiser, it would ask for government regulation. As one who loves labor and wants to see it survive, I say that there must be government regulation of labor.

ONUS (tools): Me, too, and I'm mad about labor.

CLODDE (textiles): And I, who long have felt a searing passion for labor.

HAWING (railroads): I agree, even as a father agrees to discipline a wayward son he loves.

PILFERING (steel): Yes, and I love labor more than Mrs. Pilfering.

BALLANFONT (oil): Me, too, and I eat in the employees' cafeteria.

MODERATOR: We are unanimous, then. Now, gentlemen, our time is getting short. Would you like to tell our listeners what plans your own companies have made for the postwar?

ONUS (tools): My company uses a lot of abrasives. In a small way we are already making our own abrasives, and we think that after the war we'll expand our abrasive facilities and really go out and compete in the abrasive market.

NIPTHUNG (abrasives): Oh, is that so, you big fat octopus trust? Well, it may interest you to know that we are going to open a tool division, and if we can't drive you out of business, you big blob of phlegm, my name ain't Max Nipthung.

PILFERING (steel): We are planning to build our own railroad from the ore pits to our steel mills.

HAWING (railroads): Oh, are you? Well, let me tell you, you double-dealing * * * that we happen to be planning to forge our own rails.

BALLANFONT (oil): Our chemists have discovered a way to make fabrics out of oil, and we're going to add a side line of textiles.

CLODDE (textiles): Yeah? Well, if you and that bag you married show your ugly faces around my house on Friday night, I'll bash your mealy mouths in. And my company is going to dig oil wells.

And the organist played "Rock of Ages" from the motion picture *Going My Way* and the forum was over.

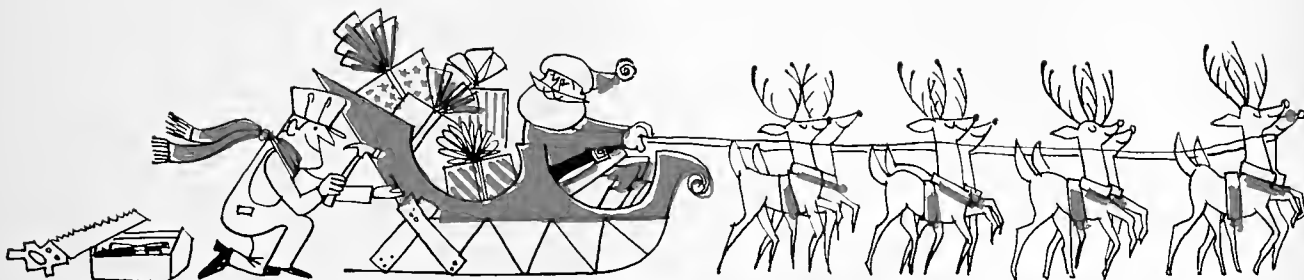

PLANE GOSSIP

SEND IN YOUR FAVORITES! MAIL TO: PLANE GOSSIP, 101 CONST. AVE. N.W., WASH., D.C. 20001. (SORRY, NO PAYMENT)

Plum Undelicious

The newly-married wife hadn't been cooking long, but bravely decided to cook up a Christmas dinner, complete with plum pudding. The new hubby sampled it, but pushed it away.

"Oh dear!" she exclaimed, "I must have left something out!"

"No, honey," he replied. "To make it taste like that, it had to be something you put in!"

MAKE YOUR SSS CLICK—GIVE TO CLIC

Dead Right!

The worried patient said to the M.D. attending him: "Doc, the other doctors seem to disagree with your diagnosis of my problem!"

"I know," said the medico. "But the post-mortem will prove I am right!"

BE UNION—BUY LABEL

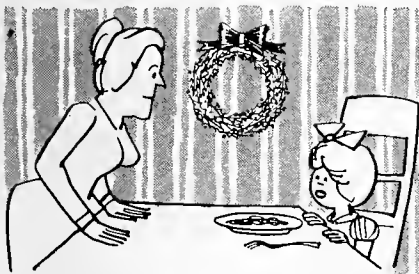

A Fowl Statement

The little girl was visiting her grandmother the day after Christmas and Grandma served up turkey hash for lunch, which the youngster pushed away. "Goodness," said Granny, "I thought you liked turkey!"

"I do," replied the tyke, "but only when it's new!"

ALWAYS BOOST YOUR UNION

Any Screws Loose?

Our highway death problem would be largely solved if Nader could

figure a way to have the automakers recall some of the defective nuts that hold the steering wheel.

R U REGISTERED 2 VOTE?

A Phoney Greeting

He had been to a Christmas party and returned home about 2 a.m. 'Good ol' Bill," he muttered. "Think I'll call 'im up and wish him a Merry Christmas."

When a sleepy voice answered the 'phone, the drunk said: "Hi, Bill! Hope I didn't disturb ya!"

"No," wearily replied Bill. "I hadda get up to answer the 'phone anyhow!"

BUY ONLY UNION-MADE TOOLS

One for The Book

A likely nominee for the dumbest broad in the world is the one who, to prove to her mother she had been a good girl, took home, from a weekend trip, a Gideon Bible.

1 4 ALL—ALL 4 1

Hairline Decision

The would-be hippy son finally had his long hair cut. He was asked, "How much weight did you lose in that operation?"

"About 135 pounds," replied the shorn scion. "It got my mother off my back!"

UNION DUES BUY RAISES

Practice What You Preach

Two brothers, who looked quite alike, were a minister and a doctor. On the day after Christmas, a neighbor stopped one and said: "I just want to compliment you on your Christmas sermon."

"Sorry," replied the complimentee, "I'm not the doctor who preaches; I'm the one who practices!"

Fur Goodness' Sake!

The husband presented his wife with a mink coat. "Oh, darling" she gushed, "is it really genuine?"

"You bet it is!" he replied. "If it isn't I'm out 25 bucks!"—Mrs. Leo Poirier, Fort Frances, Ont.

STRIKE A LICK—GIVE TO CLIC

A Testy Professor

Just before the Christmas holidays, the professor gave an examination. One question was, "Where did life originate?"

One of the students wrote: "God knows, I don't. Merry Christmas!"

On the returned paper, the prof had written: "God gets 100. You get zero. Happy New Year!"

R U GOIN 2 D UNION MEETING?



A Police Case, Maybe?

The New Year's Eve reveller protested loudly as he was shoved into the police station. "Thish ish an outrage! Why wash I brought here?"

"Sir," politely replied the sergeant, "you were brought here for drinking."

"Oh, thash diffrunt," responded the celebrant. "Lesh get started!"



Canadians Promote the Union Label in '71 Show



A visitor to the Brotherhood exhibit was Canadian Minister of Labor Bryce Mackasey, shown here with GEB Member Wm. Stefanovitch and First Gen'l. Vice Pres. Sidell.



Among those who made the exhibit a success were, from left: Hostesses Doris Hilborn and Maureen Cox; John Pirie, Western Ontario DC; Mike Biro, Local 1946; Derrick Manson, sec.-treas., Ontario Provincial Council; GEB Member Stefanovich; Nelson Hilborn, Grand River Valley DC; Arnold Marsman, Local 1946; and Dave Noble, pres., Western Ontario DC.



The chain saw in the picture above was one of several items given as prizes to show visitors. General Officers Stefanovitch and Sidell talk with Louis Dulacka, Northern Ontario District Council.



Above: Hostess Mae Kenwell greets a visitor. Also shown are Dave Noble, Derrick Manson, Wm. Sidell, Nelson Hilborn, and Int'l. Dep. Tom Harkness.

Below: A view of the Brotherhood display.



**Second annual exhibition
doubles last year's attendance,
as Brotherhood joins
promotional efforts with
'Stump to Finished Product' theme**



Canadian Labor Minister Bryce Mackasey cuts the ribbon opening the 1971 show. At left is CLC Union Label Department Director and Show manager Henry Rhodes. On the right is CLC Vice President Jean Beaudry.



A view of the crowd of show visitors who visited the Brotherhood display. Some of the exhibit attendants can be seen at right.

■ More than 90,000 visitors crowded the aisles of the five-day Canadian Union Industries Show, October 2-6 in London, Ontario—doubling the total attendance of the first such show, last year.

The 1971 exhibition was held in the Progress Building at the Western Fair Grounds in London. It was sponsored by the Union Label Trades Department of the Canadian Labor Congress, which expects to hold its third annual show in Edmonton, Alberta, in 1972.

The 60-foot display of the United Brotherhood was colorfully accented with a backdrop of vinyl-covered sheetrock panels. Expressing the theme "From the Stump to the Finished Product," the exhibit was designed to display the skills of our members and some of the products we manufacture in lumber and saw-mills, drywall and acoustics, resilient floors, and the craft skills of our carpenters, mill-cabinet men and millwrights.

The Brotherhood exhibit was coordinated by the Ontario Provincial Council, with assistance from the Western Ontario District Council and London Local 1946. Each of these organizations provided personnel to staff the show.

More than a dozen companies contributed material to construct the booth and the products displayed. Each day there were special prizes given away, which were donated by the Northern Ontario District Council (Lumber and Sawmill), Locals 3054 and 2679, COSF Products, and Trend Millwork.

A replica of the Eiffel Tower made from matchsticks was loaned by the Eddy Match Co. Drywall came from Canadian Gypsum, a millwright display from Canadian Mechanical Handling Systems, Windsor; pre-assembled electrical circuits on wood panels were displayed by Centennial Cabinets Ltd., London. Trend millwork donated a prize coffee table.

The Brotherhood exhibit was one of the largest in the 1971 show. It attracted a host of show visitors, including the Canadian Minister of Labor, Bryce Mackasey, and other dignitaries. ■



1

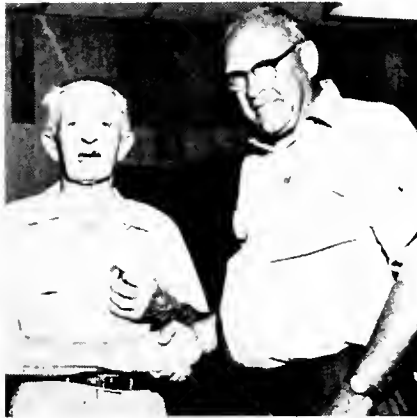

2



3



4

SERVICE TO THE BROTHERHOOD

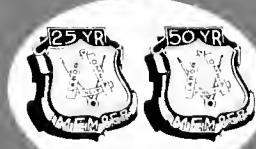

A gallery of pictures showing some of the senior members of the Brotherhood who recently received 25-year or 50-year service pins.

(1) GALESBURG, ILL.—At a special meeting held on July 6, 1971, Local 360 honored its 25-year members. Those to whom service pins were presented included, standing from left, Clarence Rockhold, financial secretary; Ed Beghtol; Cleo Olsen; Charles Baughman; James Sloan, Frank Swanson; Robert Smith; Roland Oswald; Richard Hallberg; and Milo Kovar, president. Also honored at the pin presentation ceremonies were 30-year members, seated from left, Ernest Stickle, Marvin McQuaid, Carl Nelson, Thomas Roberson, C. H. Mallin, Homer Dawson, Sam Freitieg, Jeff Davis, and Courtney Swanson.

(2) Oscar Anderson, left, is congratulated for his 30 years of service to Local 360 by Clarence Rockhold, financial secretary.

(3) Also honored at the pin presentation ceremonies was Ben Sandberg, a member who has devotedly served Local 360 for 50 years. Sandberg, center, is seen here with President of Local 360 Milo Kovar, left, and Clarence Rockhold, financial secretary.

(4) Forty-year member Harry Stickle, left, is presented with a pin honoring his devoted service to Local 360 by Milo Kovar, president.



5

(5) HOT SPRINGS, ARK.—Local 891 recently honored five 25-year members. Seated, from left, are Simpson Pennington, Richard Robison, and Dempsey Pennington. Standing are J. A. Wright, left, and Clarence Kemp.

EDITOR'S NOTE: When sending in photographs for publication in The Carpenter, please identify all persons with names and titles, left to right, beginning with the front row and going to the back row.



REPORT

Recent Membership Contributions to the Carpenters Legislative Improvement Committee

Unions Urged To Put Forward Delegates

"We have been urging our state leaders to get their members to run for election as delegates to the Democratic National Convention and the Republican National Convention in every state on every slate they can get on," states Joseph Rourke, deputy director of the AFL-CIO Committee on Political Education.

"Time is important. As an example, in the State of Illinois on January 12, just a couple of months from now, this is the day that you must file if you want to be a candidate to the Democratic Convention in Miami Beach, or to the Republican Convention in San Diego.

"If we want our friends to be delegates to this convention, they have to file on that date.

"Seven days later, the filing date closes. No one else can run after that, and on March 21, 1972, the state will elect 170 Delegates to the Democratic National Convention, and they are going to have a lot to say about who the next nominee for the President of the United States is on the Democratic ticket.

"Now, at the 1968 Democratic National Convention, only about 200 of all delegates, some pretty near 5,000, were union men.

"1972, we are shooting for 600 union delegates at that convention out of a grand total of 3,000.

"There will be the Presidential primaries in 23 states, and under the new rules for selecting delegates for the Democratic National Convention, only a very few delegates will be appointed, as they have been in the past.

"In nine out of ten cases, anyone who wants to be a delegate to the Democratic National Convention has to run in a State Senatorial District Primary, or in a Congressional District Primary.

"Example—in 1968, 43 percent of all the delegates to the Democratic National Convention were elected by

the primary method, where they went to an election. In 1972, this is going to be 63 percent."

"CLIC" CONTRIBUTIONS (as of 11-15-71)

Local	City	Amount
ARKANSAS		
71	Fort Smith	\$10.00*
1683	El Dorado	10.00*
CALIFORNIA		
1140	San Pedro	2.00
1976	Los Angeles	31.00
2172	Santa Ana	10.00*
CONNECTICUT		
825	Willimantic	40.00
FLORIDA		
819	W. Palm Beach	25.00
993	Miami	41.00
1394	Fort Lauderdale	60.00
3206	Pompano Beach	20.00
ILLINOIS		
44	Champaign-Urbana	49.00
199	Chicago	26.00
419	Chicago	40.00
839	Des Plaines	79.00
1889	Downers Grove	85.00
2014	Barrington	34.00
2158	Rock Island	11.00*
INDIANA		
133	Terre Haute	30.00
533	Jeffersonville	16.00
694	Boonville	24.00
IOWA		
4	Davenport	4.00*
106	Des Moines	6.00*
308	Cedar Rapids	16.00*
364	Council Bluffs	2.00*
373	Fort Madison	4.00*
534	Burlington	6.00*
678	Dubuque	8.00*
948	Sioux City	10.00*
1039	Cedar Rapids	4.00*
1069	Muscatine	2.00*
1260	Iowa City	4.00*
1313	Mason City	2.00*
1835	Waterloo	2.00*
1948	Ames	8.00*
KANSAS		
499	Leavenworth	20.00
714	Olathe	10.00*
LOUISIANA		
1897	Lafayette	21.00

Local	City	Amount
MASSACHUSETTS		
32	Springfield	12.00
40	Boston	304.00
67	Boston	110.00
82	Haverhill	33.00
595	Lynn	54.50
MICHIGAN		
998	Royal Oak	65.00
MISSOURI		
47	St. Louis	62.00
1839	Washington	12.00
NEW HAMPSHIRE		
921	Portsmouth	10.00
NEW JERSEY		
715	Elizabeth	78.00
1493	Pompton Lakes	20.00
NEW YORK		
188	Yonkers	42.00
246	New York	373.00
257	New York	50.00
284	New York	100.00
516	Lindenhurst	20.00
1015	Saratoga Springs	12.00
1162	College Point	60.00
1397	N. Hempstead	456.00
1921	Hempstead	180.00
2710	New York	10.00
OHIO		
182	Cleveland	58.00
1180	Cleveland	14.00
1602	Cincinnati	70.00
OKLAHOMA		
285	Altus	10.00*
329	Oklahoma City	60.00*
653	Chickasha	10.00*
763	Enid	10.00*
943	Tulsa	80.00*
986	McAlester	10.00*
1028	Ardmore	10.00*
1060	Norman	16.00
1072	Muskogee	20.00*
1399	Oklmulgee	20.00*
1585	Lawton	10.00*
1659	Bartlesville	10.00*
1686	Stillwater	20.00*
1894	Woodward	10.00*
2008	Ponca City	10.00*
2013	Ada	10.00*
OREGON		
1746	Portland	4.00
PENNSYLVANIA		
59	Lancaster	40.00
122	Philadelphia	50.00
230	Pittsburgh	26.00
492	Reading	43.00
556	Meadville	4.00
TENNESSEE		
259	Jackson	30.00
TEXAS		
753	Beaumont	30.00*
1276	Dallas	10.00*
1565	Abilene	20.00
1971	Temple	27.00
UTAH		
450	Ogden	3.00
WASHINGTON		
338	Seattle	36.00
870	Spokane	20.00
2519	Seattle	7.00
	Total	\$3,643.50

**When we couldn't get the
kind of wood we needed for
Lufkin rules, we grew our
own trees.**



That's because in our business you can't take chances on quality or accuracy. We even weave our own cloth tapes for the same reason.

And, knowing the beating a long tape has to take out in the field under many different conditions, we created our famous chrome tapes. They last at least four times as long as the regular white tapes. (Incidentally, we make a white tape that's also long-lasting because it's coated with epoxy.)

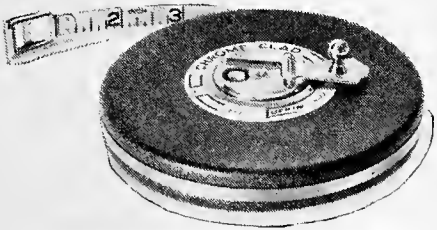

The almost indestructible Chrome Clad® long tape

We've been in this measuring business for over 100 years and we're still proud of our newest developments. The Lufkin power tape which we call the Mezurlok® has a special lock that prevents the tape from creeping. And we built in a patented rubber bumper so the end-hook won't snap off when you return the tape into the case.

We're always working on something new or trying to solve a special problem. That's why we can safely say that whatever your measuring requirement might be, Lufkin has the perfect solution.

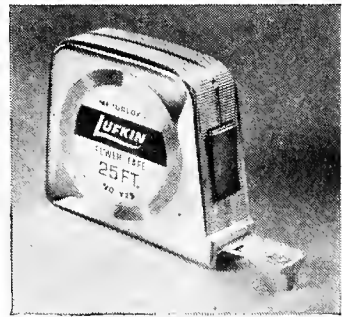

Our Mezurlok® beats the creeps

The Cooper Group

CRESCENT • KEN-TOOL • LUFKIN • WELLER





CANADIAN REPORT

Carpenters May Obtain Certification Without Examination under 'Grandfather Clause'?

Revised regulations covering the trade of general carpenter have been passed by the Ontario government. The amendments allow persons employed in this trade to apply for a certificate of qualification without examination.

A two-year "grandfather clause" allows applications without written test. After two years, applicants must take an examination.

Three of the main qualifications are that an applicant must (1) show satisfactory work experience of twice the length of the apprenticeship period; (2) have completed an apprenticeship program outside Ontario for a period equal to the apprenticeship period (3) have a valid Ontario apprenticeship certificate.

The Carpenters' Brotherhood in Ontario according to its Toronto District Council is hoping that the amendments will be of benefit to the trades and increase the number of apprentices.

The union has been trying to get improvements in the legislation for the past seven years.

When the Apprenticeship and Tradesmen's Qualification Act was passed in 1964 it gave compulsory certification to certain mechanical trades—electrical, sheet metal, plumbing and refrigeration.

All other trades were given the opportunity, first to achieve voluntary certification, then to seek compulsory certification. The difference is that, in the former case, a person may apply for a certificate or he may not, to work in a trade; in the latter case, a person must have a certificate, renewable annually, or be serving an apprenticeship.

For three years, the Carpenters' Advisory Committee set up under the legislation sought compulsory certification.

After a necessary change in committee membership, agreement was reached on voluntary certification until a majority of tradesmen had certificates.

When that state is reached, a majority with certificates does not necessarily provide for compulsory certification. It does give the trade concerned a better argument in favor of compulsory procedure.

However, the Industrial Training Branch of the Ontario Department of Labor tried to throw a roadblock into this plan by proposing seven different classifications within the trade.

The attempt to introduce classifications was not successful, however. The term "general carpenter" is the only basis on which a certificate will be granted.

"We are trying to convince our members of the value of investing \$10 once and applying for a certificate to perform work which many have been doing for years without this requirement," according to Business Representative C. H. MacClelland.

If the union can achieve this objective, the new regulations will benefit the trade and increase apprenticeship.

Housing Starts May Double 1961 Figure

If housing starts reach 250,000 in Canada this year, it will be just double the number built 10 years ago—1961.

It now appears certain that housing starts will hit 225,000, up from about 180,000 last year.

Costs, especially of land and money, have gone up so high that the low-income group and many of the middle-income have been entirely excluded from the market. But this year the

federal housing agency, Central Mortgage and Housing, allocated almost one billion dollars to mortgage loans and the subsidization of low-income housing.

Housing demand is expected to continue, especially from the 25 to 44 old age group, which will be the fastest growing sector of the population between 1975 and 1980.

This could bring about a return to the construction of single family, semi-detached and duplex houses. There could be less emphasis on high-rise apartments which have been coming in for considerable criticism, but condominiums, a form of co-operative ownership, may become more popular.

Office, Hotel Projects In Metro Toronto

The volume of office space construction under way and being proposed in the Metro Toronto area continues to amaze.

In 1971, 7.7 million square feet will be completed, and next year a 24% increase of available space is expected.

On top of this, a boom in hotel construction in the Metro area will add 6,000 rooms in the next year or so, increasing hotel capacity 50% in this short time.

Building Trades Set Up Office in Ottawa

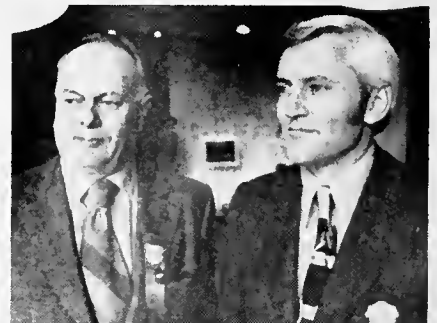

The AFL-CIO Building and Construction Trades Department has established a fulltime Canadian office in Ottawa, and on November 7 it appointed James A. McCambry of Operating Engineers Local 955, Edmonton, Alberta (right, above) as its executive secretary. McCambry is shown here with General Executive Board Member Eldon Staley during the AFL-CIO Building Trades Convention in Florida.

The new Ottawa office will coordinate many of the activities of provincial and local building and construction trades councils in Canada and protect the interests of affiliates in dealing with Federal agencies.



FOREMAN



SUPERINTENDENT



ESTIMATOR



CONTRACTOR

These well-paid positions need you now!

The best-paying jobs in building are being filled by former carpenters and apprentices.

The "population explosion" is in full bloom. Men like yourself are being counted on to supervise the construction work on millions of new houses, apartments, factories, office buildings and institutions. The question is: Do you have the all-around construction know-how needed to step up to these better paying positions? . . . If not, Chicago Tech can show you how to prepare to take advantage of these job opportunities.

All facts sent FREE . . .

it won't cost you a penny

With your permission, Chicago Tech will send you the latest book on Builder's Training and

CHICAGO TECHNICAL COLLEGE

ESTABLISHED 1904 TECH BLDG., 2000 SOUTH MICHIGAN AVE., CHICAGO, ILL. 60616

Trial lesson in blueprint reading • Builder's training manual • Set of actual blueprints

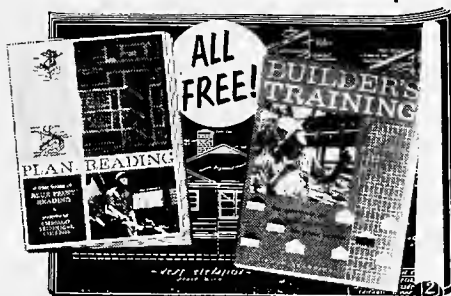

Opportunities—Plus a Free Trial Lesson with complete set of Blueprints.

Chicago Tech Builder's Training is practical, down-to-earth and is specially prepared for study at home in your spare time. The Free Trial Lesson will show you how easy it is to learn the Chicago Tech way. No special schooling is required and it will not interfere with your present work. You learn while you earn merely by devoting a few hours each week to study.

As a building tradesman you are in a choice spot to cash in on this tremendous growth of the building industry. Your reward can be higher pay, more secure employment, plus the added prestige of a top job in building. So act now—get the facts—mail the coupon today!

Builder's Training—by builders for builders

Chicago Technical College
5-143 Tech Bldg.,
2000 S. Michigan Ave.
Chicago, Illinois 60616

New G.I. Bill!
Vets check here

Please mail me Free Trial Lesson, Blueprints and Catalog.

Name _____ Age _____

Address _____

City _____ State _____ Zip _____

Occupation _____

Accredited Member National Home Study Council

Employment Hopes High in Construction

An assurance that expansion in construction will continue in Canada is that the federal government is pinning some of its hopes on the industry to pick up employment.

The recovery in employment conditions which the government expected did not materialize. In fact unemployment went over the 7% mark as a national average and over 10% in some areas.

So the government introduced a mixture of tax cuts and increases in government spending to stimulate employment.

A billion dollars will go toward means of putting the unemployed back to work, and a good part of that money will be channelled through the provinces and the municipalities for winter building.

In addition, \$113 million will be provided for public and low-income housing a year ahead of schedule.

An interesting feature of the accelerated housing program is that the

federal agency, CMHC, will direct "assisted home-ownership loans" for housing that can be purchased by families earning less than \$7,000 a year.

The interest rate will be fixed for a five-year period, reduced on a sliding scale for incomes below the \$7,000 maximum. The rate will vary from a top of 8.75% to 7.5%.

This is still not low interest, but in the past year, rates have started at 9%.

Other new features are included in the legislation, too numerous to be dealt with here.

A Second Look At Highrise Living

Highrise apartment living is meeting more and more public resistance. High land costs have, in part, forced high-rise construction, but now some architects are convinced that higher densities on expensive land can be obtained satisfactorily by better planning horizontally rather than vertically.

In some areas this has already been proved, but this year, as last year, the

number of dwellings in apartment blocks will likely outnumber those in single, double, row or town housing.

A well-informed Metro Toronto builder says that downtown rents in this area are going as high as those in Manhattan—\$400 to \$500 a month for a one-bedroom apartment.

A more encouraging note was sounded by another big developer who, last month, announced that, as a result of taking advantage of lower interest rates available from the federal housing authority for limited dividend housing, his firm is able to reduce rents by \$30 to \$50 a month per unit.

To get this special interest rate, the developer must rent to people in the lower- middle-income group and agree to limit his profit take.

Lower interest rates are the key to lower housing costs. Rents in the limited dividend development will run from \$140 to \$170 a month.

But only 226 units are being built by this developer at these prices. Not much when a few hundred thousand families need housing at these prices or less, across Canada.

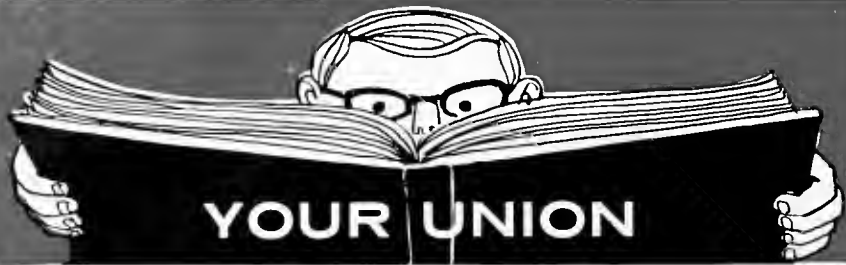

YOUR UNION DICTIONARY

This is the 8th of a new feature series planned to keep you better informed on the meaning of terms related to collective bargaining, union contracts, and union business. Follow it closely, and your union membership will become more meaningful, and your ability to participate in decisions which affect your future and security will be strengthened. It was compiled by the International Labor Press Assn, and is used with permission.

F

fact-finding: Investigation of a labor-management dispute by a board, usually named by a government official (sometimes private individuals chosen by mutual consent), which issues a report describing the points at issue, and sometimes makes recommendations for a solution. Under the Taft-Hartley Act the President must name a Board of Inquiry to investigate a dispute that threatens the nation's health or safety. The Board is required to report its findings to the President. Several states have laws providing for fact-finding in industrial disputes.

featherbedding: Pay for work not done or for unnecessary work. Often stretched by management to cover any union limitations on employer practices.

Federal Mediation and Conciliation Service: An independent government agency functioning under the Labor Management Relations Act of 1947, offering machinery for settlement of labor disputes which threaten to involve a substantial work stoppage.

Federation of Organized Trades and Labor Unions: Direct predecessor of the AFL, founded in 1881.

field examiner: An employe of the National Labor Relations Board whose primary duties are to pass on union petitions for an election, conduct certification elections and make preliminary investigation of unfair labor practice charges.

filing requirements: Submission of financial and other information by unions in order to qualify for service under Taft-Hartley Act.

full employment act: The Employment Act of 1946, establishing the federal government's responsibility to promote maximum employment, production and purchasing power. The act created the President's Council of Economic Advisers, and obligated the President to submit an annual report to Congress recommending steps to carry out the act's objectives.

G

garnishment: A court order to an employer to withhold part of wages to satisfy a financial claim against the worker. Default on an installment payment is most common claim.

geographical differential: Variation in wage rates between areas or regions of the country for identical work.

GNP: Gross National Product. Total of all production and services in calendar year, expressed in dollars.



The quick-action depth-of-cut control on the new Rockwell Delta 6" jointer permits easy adjustment of a large 6 1/8" by 35 1/2" table. An easy-to-operate indicator on the calibrated scale provides quick, accurate depth selection.

NEW 6" JOINTER

A new, economically-priced jointer, combining 6" jointing capacity with 3/8" by 6" rabbet capacity, has been introduced by Rockwell Manufacturing Company.

The new jointer (Model 37-600) features a large 6 1/8" by 35 1/2" table that is easily adjusted by a quick-action depth-of-cut control. An easy-to-locate pointer on the calibrated depth-of-cut scale permits quick, accurate depth selection.

The lubricated-for-life ball bearing cutterhead has high-speed steel knives to assure long cutting life. The cutterhead is completely guarded, at all times, providing increased safety for the operator. When equipped with the recommended 1725 rpm motor, the unit delivers 12,600 cuts a minute.

The jointer's 4 1/4" x 27 1/2" center-mounted fence tilts 45 degrees left and right and has an adjustable positive stop at 90 degrees.

Complete information on the new 6" jointer and other Rockwell power tools may be obtained from Rockwell Manufacturing Company, Power Tool Division, 400 North Lexington Avenue, Pittsburgh, Pennsylvania 15208.



When equipped with the recommended 1725 rpm motor, the new Rockwell Delta 6" jointer delivers 12,600 cuts per minute. And the lubricated-for-life ball bearing cutterhead has high speed steel knives to assure long cutting life.

Union Industries Display in Indianapolis



Trade unionists of Indianapolis, Ind., staged their own Union Industries Show recently. They set up displays in a local exhibition hall and told Indianians of the virtues of union goods and services.

The organizing committee of the Central and Western Indiana District Council of Carpenters, working with the Central Labor Council, set up the display shown above. It proclaimed: "The United Brotherhood of Carpenters is proud to be a part of Indiana's growth." Two lovely young ladies passed out tote bags which had imprinted: "Carpenters say, Live Better, Work Union."

Walter Borchers Honored in Cincinnati



Walter Borchers, left, above, has been a mainstay of the Brotherhood in Cincinnati, O., for decades. He was initiated into the union in June 1906 and has served Local 868 and the Ohio Valley District Council in just about every way since. He retired this year, at age 85, and his friends and fellow members wished him well in ceremonies shown above. The handshake comes from General Executive Board Member William Konyha. Also shown are DC Secretary Russell Austin and DC President Art Galea. Si Cornell, columnist for the Cincinnati Post-Times Star, called Borchers "solid as an oak" in a lengthy report on his retirement. Borchers retired from active union work last July.

Planer · Molder · Saw!

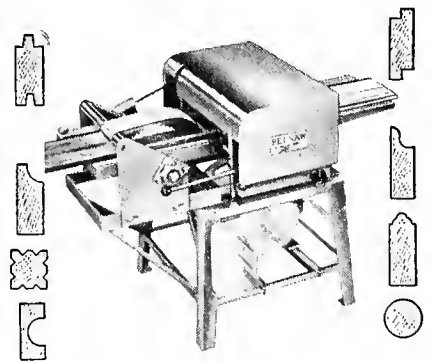

Now you can use this ONE power feed shop to turn rough lumber into high-value moldings, trim, flooring, furniture ... ALL popular patterns.

RIP ... PLANE ... MOLD ... separately or all at once by power feed ... with a one horse-power motor. Use 3 to 5 HP for high speed commercial output.

LOW COST ... You can own this MONEY MAKING POWER TOOL for only ... \$30.00 down.

Send coupon today

BELSAW POWER TOOLS
 9422 Field Bldg., Kansas City, Mo. 64111
 Send me complete facts on the MULTI-DUTY Power Tool. No obligation.

Name _____
 Address _____
 City _____ State _____ Zip _____

MAKE \$20 to \$30 EXTRA
 on each
STAIRCASE



Saves its cost in ONE day—does a better job in half time. Each end of Eliason Stair Gauge slides, pivots and locks at exact length and angle for perfect fit on stair treads, risers, closet shelves, etc. Lasts a lifetime.

Postpaid if payment sent with order, or C.O.D. plus postage Only **\$19.95**

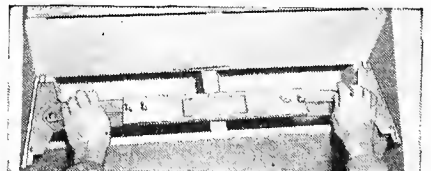

ELIASON STAIR GAUGE CO.

6005 Arbour Lane
 Minneapolis, Minn. 55436

APPRENTICESHIP & TRAINING

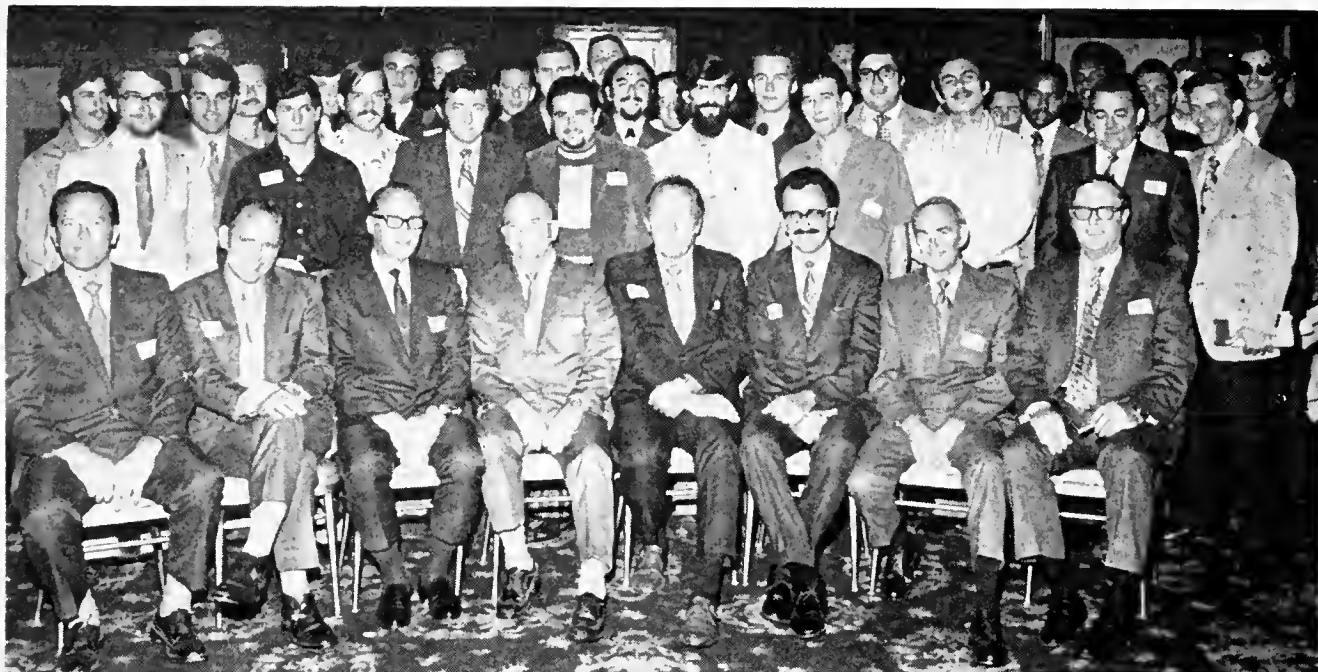

Members of the Los Angeles Drywall Joint Committee with the new journeymen: Front row, from left, Don Gravenmeir, Williams & Kelly; Richard Freeman, business representative, Local 1506; Lloyd Buchanon, business representative, Local 1506; Dale Morgan, business representative Local 1506; Christ V. Jensen, business representative, Local 1506; Alex Okoury, drywall training coordinator; Stu Penman, California Division of Apprenticeship; and Ken Sitterley, Anning/Johnson.

49 Californians Complete Drywall Training

Graduation ceremonies for 49 young men were held recently by Local 1506, Los Angeles, Calif., to mark the completion of their training in drywall construction.

Following a reception and dinner, training leaders of the union awarded State of California trade certificates, which signify that each graduate is now a qualified journeyman. Local 1506 also presented a watch to each graduate.

Featured speakers for the ceremonies were Robert Gulick, executive secretary of the California Drywall Contractors Assn., and Christ V. Jensen, president and business representative for the local union.

The graduates included: Frank Adams, Richard Adams, Armondo Alvarez, Milton Andreasen, Harold Asbra, Juan Barrios, Will Bell, Robert Berkemer, Glen Brown, Wayne Bunce, Dennis Butler,

Frank Cincotto, Randolph Cox, Jack Critchfield, Charles Crouch, Michael Cuomo, Paul Dashner, Christopher Edie, John Frisch, Hector Garcia, Charles Gilbert, Bernard Gorlero, Bruce Ingram, Darryl Jensen, Jesse Lane, Harry Linn, Anthony Marino, Doug McCarron, Jack McNurlin, John O'Connell, Yolando

Quiocho, Victor Ramierz, Richard Reyes, Robert Ridenour, Joe Casados, Fred Roxbury, Clyde Salyer, Melvin Siegrist, Avilio Silva, Dennis Skinner, George Schrody, Patrick Swyers, Alvin Taylor, Gary Taylor, William Tollett, Joe Wagner, James Walent, Larry Watson, and Jan Wilson.

Apprenticeship Information Centers

The AFL-CIO Building and Construction Trades Department and local Building and Construction Trades Councils are cooperating with the U.S. Bureau of Apprenticeship and Training in their development and operation of Apprenticeship Information Centers. To date 36 centers have been established in as many cities throughout the country. In fiscal year 1971, these centers accounted for 1,239 minorities being indentured into

apprentice programs in the construction trades.

Of some 56,000 persons contacting the Apprentice Information Centers, over 8,000 minority youths showed interest in construction and were serviced by these centers. Although many of these were not qualified for apprenticeship training every effort was made to provide counselling and service as well as other direction wherever possible to each applicant.

SERVICE TO THE BROTHERHOOD

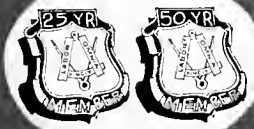

A gallery of pictures showing some of the senior members of the Brotherhood who recently received 25-year or 50-year service pins.



1



2

(1) RENO, NEV.—Early this year, Local 971 honored its members who had compiled 25 or more years of devoted service. Seen here with General Exec. Bd. Mbr. M. B. Bryant (second from left) are 50-year member Karl Isakson, 50-year member Andy Weir, and Primo J. Bertoldi.

(2) Honored for their 45 years of service to Local 971 were, from left, Jim Byars, Silvo Ferrari, and Oscar Swanson. Andy Swalley, not in the photograph, was also presented with a service pin honoring his 45 years of service.

Presented with 35-year pins were Harrison Marshall; William Kurtis; K. P. Williams; Dale Hanna; Carl Nyberg; Fred Stephenson; Joseph Donatelli; Law-

rence Quadrio; Dan Lund; L. F. Jacaway; Bert Wise; Joe Krupa; Alfred Forson, Sr.; and John Giossi.

Honored for 30 years of service were Ernest Giossi; Ray Keller; Bernard Mertha; William Webb; Otto Ommen; A. B. Christensen; Pedar Simonsen; William Loeb; Alfons Assfal; Fred Pefley; S. Z. Dondero; Dan Rogers; Fred O'Connor; Melvin Webb; William Havlik; Carl Belz; Jack Landers; Donald Masters; Ralph Hanshaw; Raymond Carlton; Byrul Sheen; Lloyd Jones; Al Odle; Ray Sheen; Paul Tremblay; John Perra; Arthur F. Gobde; Henry Knier; Kenneth Rogers; W. C. Wheatley; Gustave Carlson; H. Pellizzari; L. T. Oglesby; Rayburn Brown; John W. Brown; G. L. Morini; Stanley Stone; Calvin Day; Howard C. Hughes; Jeff Clark; Eugene Raiche; Marvin Alexander; Alfred Forson, Jr.; H. B. Brewer; Robert Hadlock; John O. Moran; Harold Stichter; John Hibel; Ralph Miller; Jess Stichter; Frank Sowerwine; Jack Webb; James Parks; George Rogers; Stanley Coffin; Guy Thompson; Gerald Cameron; Sylvester Loiacano; Lawrence Willbanks; George Usher; C. W. Hedger; Herbert Smith; Floyd Southard; Ben Savage; Ted McGowan; Robert Allen; Roy Weatherman; Earl Hancock; Ross Stoltz; Benedict Barnard; J. K. Anderson; Marion Rice; George Yuill; Harry Waud; and Russell Juhler.

Twenty-five-year pins were presented to Otto Depping; Verl Theobald; Elvin Olds; Robert Ambrose; C. C. Cundiff, Jr.; Clarence Belli; John Frank, Sr.; Leonard Lund; Vincent Lynch; Willis Moose; Lawrence Ingram; Nathan Bradley; Ellis Bradley; E. A. Stiles; Delmar Scott; Marco McCauley; Marion A. Hanson; P. M. Pederson; Harry Gilbert; Harry Sells; Clem Cuddy; Matt Shevlin; Robert Hickman; George Walby; William Kimsey; Arthur Barton; Jack Poncia; Marco Boscovich; Lawrence Mottle; William Spargo; Claude Cooper; Drew Brown; Raymond Brown; Jacob Morgan; Nick Russo; P. C. McKinnon; Delbert Gurr; C. D. Lair; J. E. Rials; Hastings Pancho; Carl Harris; William Donaldson; Roy Johnston; Francis Nelson; Harold Scollard; Albert Holly; N. B. Gallagher; Leland Harback; Edward Kirchen; William Motl; Vic Wilbur; John Stalder; Dewey Hunter; J. L. Robicheau; George Johnson; Fred Duras; Arvid Wiik; A. B. McPherson, Sr.; Jesse Malone; Bart Jurick; William Rucker; H. F. Byars; Charles Marsh; Dean Goddard; T. W. Geister; Bill Dwyer; Verne Stocke; Earl Stocke; Tom Sloan; Kenneth Knauus; William M. Duncan; Jesse E. Brown; Paul Wright; Martin Weisser; Martin Muhar; James Taylor; N. A. Kauffman; Nate Curtis; Michael McDonald; Clarence Bennett; Robert Browne; Harry Campbell; Ronald Caskey; Daniel Conners; Joe Davidson; Donald Dawson; John E. Frank, Jr.; Richard Gibson; Charles Gothrup; Thomas Hadlock; Carl Herriman; Ben E. Jones; George Meier; Louis Paley; Hilman Tobey; and Ralph Whytal.

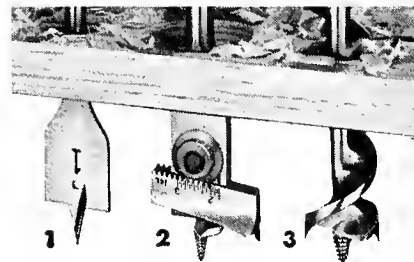

3 easy ways to bore holes faster

1. Irwin Speedbor "88" for all electric drills. Bores faster in any wood at any angle. Sizes 1/4" to 3/8", \$.90 each. 5/8" to 1", \$1.00 each. 1 1/8" to 1 1/2", \$1.50 each.

2. Irwin No. 22 Micro-Dial expansive bit. Fits all hand braces. Bores 35 standard holes, 7/8" to 3". Only \$5.70. No. 21 small size bores 19 standard holes, 5/8" to 1 3/4". Only \$5.00.

3. Irwin 62T Solid Center hand brace type. Gives double-cutter boring action. Only 16 turns to bore 1" holes through 1" wood. Sizes 1/4" to 1 1/2". As low as \$1.60 each.

EVERY IRWIN BIT made of high analysis steel, heat tempered, machine-sharpened and highly polished, too. Buy from your independent hardware, building supply or lumber dealer.

Strait-Line Chalk Line Reel Box only \$1.35 for 50 ft. size

New and improved Irwin self-chalking design. Precision made of aluminum alloy. Practically damage-proof. Fits the pocket, fits the hand. 50 ft. and 100 ft. sizes. Get Strait-Line Micro-Fine chalk refills and Tite-Snap replacement lines, too. Get a perfect chalk line every time.



IRWIN Wilmington, Ohio 45177

every bit as good as the name

LEARN SURVEYING AT HOME!

APPROVED VETERANS TRAINING CENTER

PUT YOURSELF ON THIS HIGH PAY SURVEYING TEAM

Prepare now at home for a rewarding Career in Surveying. Excitement! Fun! Prestige! Imagine yourself as part of a Surveying Team — in on planning of highways, bridges, dams, airfields, subdivisions, etc. Wonderful Outdoor Career... ideal for men who like to work with their hands.

We'll Give You This Famous 2X SURVEYOR'S TRANSIT when you train with us for a HIGH PAY CAREER IN SURVEYING!

... Lets you make Surveying measurements the way professionals do! PLUS 3 Big Surveying Kits you use during training... you keep throughout your Surveying Career. You need no previous experience, no technical ability. North American has trained 1000s to step into good pay positions in every State. Many students report good earnings part time while still learning. Thousands who are Surveyors today get their training through home-study. You can too!

Rush Coupon for FREE 'Surveying Career Kit'

... including 20-Page Book, Sample Lesson and Self-Scoring Aptitude Quiz. No cost or obligation. Rush coupon today.

NORTH AMERICAN SCHOOL OF SURVEYING Dept. 1146C
4500 Campus Drive • Newport, Calif. 92660

Rush "SURVEYING CAREER KIT" including Book, Sample Lesson & Aptitude Test — ALL FREE!

Name _____ Age _____
Address _____
City _____ State _____ Zip _____





Graduates Honored at 17th Philadelphia Commencement

One hundred fifteen young men were awarded certificates of completion at the apprentice graduation sponsored by the Carpenters' Joint Apprentice Committee of Philadelphia, Pa., recently. The ceremony, honoring the largest graduating class since its beginning in 1945, was dedicated to three apprentice trainees who passed away during the year.

Graduation ceremonies were highlighted with special award presentations to top apprentices in the categories of carpenters, cabinet workers, millwrights and wharf and dock builders.

Highest award of \$500 was presented in carpentry to Anthony J. Martinelli, 6700 Marshall Road, Upper Darby, Penna., employed by Curtis Company. Second prize in the same category, \$300, to Leonard Zappolo, 1700 S. New Kirk Street, Philadelphia, Penna., employed by Somers Construction Co. Third prize, \$200, to Albert Hopkins, 4932 Mulberry Street, Philadelphia, Penna., employed by Keefer & Kessler Associates. Fourth prize, \$100, to Ronald Whelan, 3059 Collins Street, Philadelphia, Penna., employed by Virginia Metal Products.

For cabinet makers, top award of \$200 went to Anthony Mac ciocca, 1601-B Patricia Drive, Yeadon, Penna., employed by Wynwood Manufacturing Co. Second prize, \$100 went to Robert Develin, 155 Godfrey Avenue, Philadelphia, Penna., employed by McCloskey-Grant Corp.

For the millwrights an award of \$200 went to John Fretchel, 103 Olympia Drive, Claymont, Delaware, employed by Henkels & McCoy. Second prize, \$100 went to Edward Coyle, 67 Church Road, Cherry Hill, N.J., employed by Olson Conveyor Company.

For wharf and dock builders an award of \$200 went to Joseph Gorman, 1228 Longshore Ave., Philadelphia, Penna., employed by J. E. Brenneman Company.

As an expression of gratitude, a representative from each apprentice group presented a map of the Philadelphia five-county area constructed of wood to General Building Contractors Association, Wharf and Dock Builders Association, Quaker City Lumber Product Association and Metropolitan District Council.

Co-chairmen of the Joint Apprentice Committee, Harold E. Irwin, president of Harold E. Irwin, Inc. and John P. Rahm, representative of the Metropolitan District Council of Carpen-

ters, were cited by the U. S. Department of Labor-Bureau of Apprenticeship and Training for their outstanding service to the national apprenticeship program. In Irwin's absence, Charles W. Fleming, president of Fleming Company, president of General Building Contractors Association, Inc., accepted his certificate of meritorious service.

Monsignor Martin J. McDonough, Lady of Mt. Carmel Church, Doylestown, gave the invocation. Other guest speakers were Eugene DiSabatino, vice-president, Ernest DiSabatino & Sons, Inc., management chairman, National Carpenters Craft Dispute Board; the late Robert Ohlweiler, general representative, United Brotherhood of Carpenters; Samuel T. Hudson, voted engineer of the year, president and chairman of the board, J. E. Brenneman Company.



NEW, TOUGH AND DESIGNED

- ROLLED EDGES FOR MAXIMUM STRENGTH AND SAFETY**
- HEAVY-DUTY LID SUPPORTS WORK WITH ONE HAND**
- SLIDING TRAY WITH MOVEABLE PARTITIONS**
- OVERLAPPING EDGES AND RAIN GUTTER**
- FULL LENGTH HIDDEN PIANO HINGES**
- END COMPARTMENT FOR SMALL ITEMS**

WEATHERGUARD CROSS BOXES
Four sizes—9 cu. ft. to 18 cu. ft.—answer every need for on-truck storage and protection of tools, equipment and material.

MODELS UP TO 18 CU. FT. OF STORAGE

\$125.00—\$160.00

weather guard®

WEATHERGUARD SIDE BOXES
Big capacity, tough design. Use alone or in combination with cross boxes. Two models.

WRITE FOR FREE 1971 WEATHERGUARD CATALOG
Wholesale inquiries invited. Prices above are F.O.B.

KNAACK® MANUFACTURING COMPANY
420 E. Terra Cotta Ave., Crystal Lake, Ill. 60014
815/459-6020

OVERHEAD RACK • Transportation of ladders and extra-long material is an easy assignment with the Weatherguard overhead rack.

Pair
\$175.00—\$205.00

\$145.00



1

SERVICE TO THE BROTHERHOOD

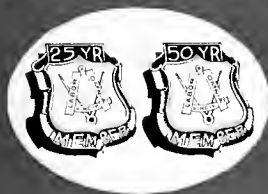

A gallery of pictures showing some of the senior members of the Brotherhood who recently received 25-year or 50-year service pins.

July 19, 1971, Local 819 held a special meeting to honor 86 25-year members and two 50-year members. Pictured here is retiring president J. A. Markham, far left, congratulating 50-year members Ray Carter and Martin A. Ingram. In addition to receiving his 50-year pin, Brother Carter had the rare distinction of being able to congratulate his son W. Lee Carter, who was presented with a 25-year pin at the Local 819 ceremonies.

(3) Incoming president of Local 819 Edward M. Long, far left, presents award to retiring President J. A. Markham, in recognition of his faithful service. Also pictured are J. E. Sheppard of the general office, holding the plaque which was also presented to the retiring president, and gold card member Judge Russell McIntosh.

2

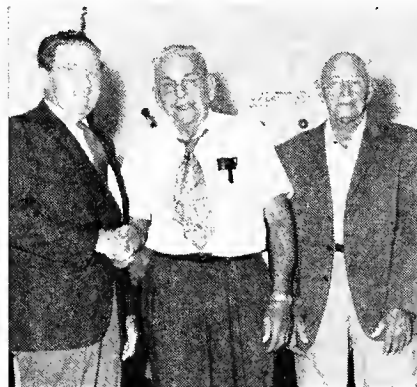

(1) ANNISTON, ALA.—At a special meeting called on June 25, 1971, Local 1749 paid tribute to its members with 25 years of service. Presented with 25-year service pins were, from left, back row: James C. Shaddix; D. V. Watts; Rex Patterson; Fourth District Board Member Harold E. Lewis, who presented the pins; B. C. Gamel; Ennis Johnson; and John R. Chaney. Pictured in the front row, from left, are Wiley Oliver; Hubert Taylor; Ernest Blanton; Woodie L. Farrell, Jr.; Vernon Glenn; and H. W. Jones.

(2) WEST PALM BEACH, FLA.—On

3



MY SPARE TIME HOBBY MAKES ME \$500 an hour CASH PROFIT

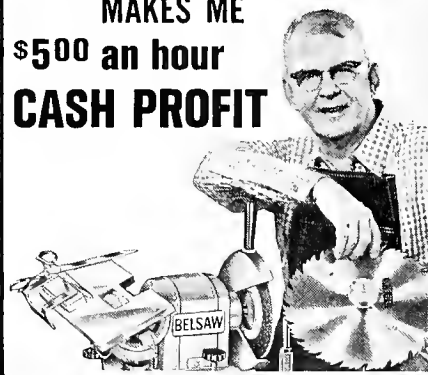

START YOUR OWN SPARE TIME BUSINESS. You can turn your spare time into Big Cash Profits with your own **COMPLETE SHARPENING SHOP**... Grind saws, knives, scissors, skates, lawn mower blades... all cutting edges. Your Own Cash Business with no inventory... right at home... no experience needed.

FREE BOOK tells how you can start your own spare time business while you are still working at your regular job. Low Cost — time payments. 30-Day Free Trial.

Just Mail Coupon—No Salesman Will Call

BELSAW SHARP-ALL CO.

732Z Field Bldg. Kansas City, Mo. 64111

Send details of **FREE TRIAL OFFER** and Free Book "Lifetime Security." No obligation.

Name _____
Address _____
City _____
State _____ Zip _____

LAYOUT LEVEL

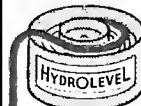

- ACCURATE TO 1/32"
- REACHES 100 FT.
- ONE-MAN OPERATION

Save Time, Money, do a Better Job With This Modern Water Level

In just a few minutes you accurately set batters for slabs and footings, lay out inside floors, ceilings, forms, fixtures, and check foundations for remodeling.

HYDROLEVEL is the old reliable water level with modern features. Toolbox size. Durable 7" container with exclusive reservoir, keeps level filled and ready. 50 ft. clear tough 3/10" tube gives you 100 ft. of leveling in each set-up, with 1/32" accuracy and fast one-man operation—outside, inside, around corners, over obstructions. Anywhere you can climb or crawl!

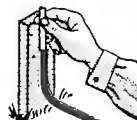

Why waste money on delicate instruments, or lose time and accuracy on makeshift leveling? Since 1950 thousands of carpenters, builders, inside trades, etc. have found that HYDROLEVEL pays for itself quickly.

Clip this ad to your business stationery and mail today. We will rush you a Hydro-level with complete instructions and bill you for only \$7.95 plus postage. Or send check or money order and we pay the postage. Satisfaction guaranteed or money back.

Ask your tool dealer to order it for you. We allow the usual dealer discount on 1/4 Doz. lots and give return-mail service.

HYDROLEVEL

925 DeSoto, Ocean Springs, Miss. 39564

FIRST IN WATER LEVEL DESIGN SINCE 1950



Outdoor Meanderings

Readers may write to
 Fred Goetz
 2833 S. E. 33rd Place,
 Portland, Oregon 97202



Salton Sea catch.

■ Jack Salmon

In the last year or so I have received an increased number of letters from readers asking: "What is a jack salmon?" Previously the question was exclusively from Northwest anglers, but since the Pacific salmon—both the Coho and Chinook—have been successfully transplanted to Great Lakes waters, and have thrived therein, I get the same questions from Midwest members.

Be it therefore known that the "jack" is but the runt of the species, a precocious male which returns to spawn before reaching full physical stature, perhaps a year or more before its normal-sized brothers.

It is, however, capable of functioning in the spawning act but is usually viciously driven away from the "ready" female by the larger buck. It must be noted that it has a definite place in Mother Nature's broad scheme, as it can take over and fertilize the eggs of the female if no large male is available on the spawning beds.

In Oregon, my home state, the regulations say that any of these salmon under 20 inches can be considered a "jack" and a more liberal bag limit is allowed for them. The following photograph depicts your columnist with a recent catch of a "jack Coho," taken from the lower Nehalem River, one of the northwest's short coastal streams.



The author and Jack Coho.



Turkey for the holidays.

■ Alabama Turkeys

One hunter who doesn't have to run down to the supermarket to get the main item on his Thanksgiving or Christmas dinner is Howard J. Carney Sr. of Mobile, Alabama, a member of Local 89. He just has to walk a few steps to the freezer where the rewards of a past successful turkey hunt are stored. He's shown here with the second gobbler he's taken this season, a chunky bird which tipped the scales at 19¾ pounds and sported a 10¾ inch beard. Previous "turk" weighed in at 17¾ pounds, and both were down in Choctaw County, Alabama, near Toxey. From this photograph, hunters will gather that Brother Carney places great value on camouflage hunt suits.

■ Salton Sea Catch

One of the most fantastic bodies of water in the land is the Salton Sea in southern California. Because of its saline content it can successfully accommodate saltwater species of fish, largest of which is the corvina, introduced to these waters many years ago.

One who really appreciates these fish-lush waters is Raymond D. Lum of Los Angeles, California, a member of Local 25. He writes:

"Dear Fred:
 "Thought my fellow members would

like to see the enclosed photograph of 'yours truly' and John H. Edwards, a retired Carpenter, displaying a nice catch of corvina we made from the Salton Sea. We limited out on hula skirts and jigs. Scene of the catch was 12 miles out from Bombay Marina to the target-area, fishing grounds. The largest we caught that day was a 23 pounder, just six pounds short of the existing record. We fished this past May 15th and the smallest we caught tipped the scales at 9 pounds."

■ Colorado Elk

Joe H. Estes of Des Plaines, a member of Local 1407, Evanston, Illinois, left his home with high hopes and great expectations, heading west for the high country near Gunnison, Colorado, home of the big elk. It took him 1½ days of hard tracking in the snow to nail his prey, a monster of a bull elk which featured seven points on a rocker-sized rack.

■ Nova Scotia Buck

Canadian member Arthur R. Keddy of Nova Scotia lauds Halifax County as having a well-balanced deer herd, a conservative percentage of which are harvested each year by the hunter. One in particular who has been successful in the area is his wife, and he sends in the accompanying photograph of her with a nice buck she downed, one of about 20 in her hunting lifetime.



Mrs. Keddy and buck.



IN MEMORIAM

**L.U. NO. 15
HACKENSACK, N.J.**
Hazekamp, Simon, Sr.
Webb, James W.

**L.U. NO. 18
HAMILTON, ONT.**
Goldrich, Richard

**L.U. NO. 25
LOS ANGELES, CALIF.**
Cimino, Nick
Mintz, Sam
Weiss, Charles J.

**L.U. NO. 53
WHITE PLAINS, N.Y.**
O'Leary, Humphrey
Yarrow, Albert

**L.U. NO. 61
KANSAS CITY, MO.**
Breashers, Riley
Huff, Gilbert O.
Lumary, Bert
Trotter, Edward J.

**L.U. NO. 80
CHICAGO, ILL.**
Anderson, John F.
Freund, Charles A.
Grenfell, Percy
Hoyem, Odin
Jensen, Lars
Karlson, Karl
McCaughy, William
Olson, Lars P.
Peterson, Walfred
Reich, William E.
Schulz, Paul A.
Thode, Herman
Thompson, Tolly
Wiese, John F.

**L.U. NO. 101
BALTIMORE, MD.**
Thurmond, Albert C.
Welzel, Frederick L.

**L.U. NO. 103
BIRMINGHAM, ALA.**
Davis, Barney E.
Duggar, Luther
Elsberry, J. W.
Ezell, W. L.
Mullins, A. L.

**L.U. NO. 129
HAZLETON, PA.**
Bachman, Philip

**L.U. NO. 131
SEATTLE, WASH.**
Anderson, Alex J.
Anderson, Andrew F.
Anderson, Carl E.
Arntson, Melvin J.
Boge, B. N.
Catching, Ward E.
DeBoo, Carman S.
Eddy, William F.
Elliott, Barton E.
Gerber, William L.
Grothe, Andrews O.
Holmberg, Gustav
Humphrey, E. R.
Jones, Roy S.
Kitchen, Glenn E.

Lawson, Rex S.
Merry, Edward J.
Mundt, Robert
Murphy, Earl L.
Nagel, Ernest W.
Nelson, Carl E.
Pearson, Erik J.
Roming, Frank E.
Royle, Alexander E.
Steele, Henry C.
Stoor, Isaac
Wanser, Harold

**L.U. NO. 132
WASHINGTON, D.C.**
Painter, Leighton E.
Parham, J. H.

**L.U. NO. 169
E. ST. LOUIS, ILL.**
Barnwell, Caleb
Briner, Ora
Broomfield, Elmer
Conley, Roy
Deatherage, Hubert
Dyroff, William
Emrich, Edgar
Geaschel, Walter, Sr.
Goehl, Edward
Gonzales, Luis
Guetterman, Walter
Hassard, Dan
Huber, William
Huntsinger, Ralph
Lamkin, James
Stanley, Paul
Taylor, Ray
Williams, Homer

**L.U. NO. 182
CLEVELAND, OHIO**
Barrett, Thomas
Lenner, Frank
Lorbach, Peter
May, Otto

**L.U. NO. 183
PEORIA, ILL.**
Barth, Fred J.
Bridges, Les E.
Buckner, Oren G.
Cates, George E.
Fagot, Frank P.
Genzel, Obed
Gibson, Lockett M.
Johnson, Billy C.
Kranz, Fred
Mammen, Charles
Mendenhall, Alfred
Moeller, William J.
Nelson, Howard
Prill, Edward A.
Rogers, Earl L.
Schrader, Theodore J.

**L.U. NO. 186
STEUBENVILLE, OHIO**
Goll, William E.

**L.U. NO. 198
DALLAS, TEXAS**
Allen, M. O. Sr.
Barker, R. A.
Brandt, Grady E.
Johnson, L. J.
Pearson, J. W.

**L.U. NO. 200
COLUMBUS, OHIO**
Cobb, Floyd
Costello, John P.
Hague, Preston

**L.U. NO. 218
BOSTON, MASS.**
Goodwin, Archibald
Malleson, Phillip
Marshall, William

**L.U. NO. 225
ATLANTA, GA.**
Bishop, Clyde A.
Brown, Harry L.
Gazaway, William K.
Mays, W. L.
McCulley, W. L.
Teate, Claude
Wells, William R.
Yarbrough, Fred V.

**L.U. NO. 226
PORTLAND, ORE.**
Davis, Nick
Gardner, R. W.
Grady, R. C.
Lambert, William R.
Rice, Frank A.
Walters, Edward S.

**L.U. NO. 246
NEW YORK, N.Y.**
Holod, John

**L.U. NO. 253
OMAHA, NEB.**
Nielsen, Antone M.

**L.U. NO. 257
NEW YORK, N.Y.**
DiBello, John
Hanson, Albert
Hogemier, Fred

**L.U. NO. 304
DENISON, TEX.**
Glass, Grady, Sr.

**L.U. NO. 314
MADISON, WIS.**
Limmex, Stephen T.
Ruhland, LaVerne
Staven, William D.

**L.U. NO. 331
NORFOLK, VA.**
Beloate, James L.
Cameron, D. E.
Matson, M. A.
Quesinberry, W. M.

**L.U. NO. 361
DULUTH, MINN.**
Loff, Carl
Olson, Aron
Ronding, Andrew
Tanner, John

**L.U. NO. 366
NEW YORK, N.Y.**
Anderson, George
Erickson, John

**L.U. NO. 372
LIMA, OHIO**
Nichols, Louis
Protsman, Scott

**L.U. NO. 411
SAN ANGELO, TEX.**
McCrohan, D. E.

**L.U. NO. 414
NANTICOKE, PA.**
Hish, Walter

**L.U. NO. 434
CHICAGO, ILL.**
Penn, Nicholas

**L.U. NO. 563
GLENDALE, CALIF.**
Boggs, Hugh L.
Kington, Orval A.
Maechler, Louis
Salvesen, Howard
Schneider, Walter W.
Shoemaker, Earl
Thompson, Clarence T.
Turnquist, John W.
Wegman, George F.

**L.U. NO. 583
PORTLAND, ORE.**
Christofferson, H. E.
McDonnell, V. L.

**L.U. NO. 606
VIRGINIA, MINN.**
Norman, Laurie

**L.U. NO. 608
NEW YORK, N.Y.**
Ahearn, Peter
McGovern, Patrick
Reddington, Thomas
Walsh, Harold

**L.U. NO. 627
JACKSONVILLE, FLA.**
George, Alfred M.
Gagin, James D.
Hook, L. A.
Reifsnider, Jack K.

**L.U. NO. 665
AMARILLO, TEX.**
Gross, Henry
Hicks, Van
Hobson, J. M.
Locke, Charles
Pace, Bill
Sisk, R. O.

**L.U. NO. 668
PALO ALTO, CALIF.**
McCulloch, Sam
McMassey, Lloyd

**L.U. NO. 674
MT. CLEMENS, MICH.**
Westfall, Leland

**L.U. NO. 678
DUBUQUE, IOWA**
Seegler, Rome A.
Snodgrass, Roland

**L.U. NO. 742
DECATUR, ILL.**
Baird, James E.

**L.U. NO. 745
HONOLULU, HAWAII**
Imai, Tatsumi
Napalalalai, Ernest K.
Oshiro, Robert S.

**L.U. NO. 787
NEW YORK, N.Y.**
Gundersen, Alfred O.

**L.U. NO. 848
SAN BRUNO, CALIF.**
Garrett, Jesse
Taylor, Edward

**L.U. NO. 849
MANITOWOC, WIS.**
Pekarek, John

**L.U. NO. 916
AURORA, ILL.**
Bumpus, Miller
Huhn, Fred
Wessman, Harry

**L.U. NO. 937
DUBUQUE, IOWA**
Denlinger, Wayne

**L.U. NO. 948
SIOUX CITY, IOWA**
Moberg, Carl E.

**L.U. NO. 950
NEW YORK, N.Y.**
Tase, John
Tews, Otto

**L.U. NO. 982
DETROIT, MICH.**
Hager, Herschel
Skinger, Edward
Smith, Harry

**L.U. NO. 1035
TAUNTON, MASS.**
Higgins, Augustine G.

**L.U. NO. 1065
SALEM, ORE.**
Mann, N. A.

**L.U. NO. 1075
HUDSON, N.Y.**
Bell, LaFrance
Jornov, Anthony
Nytransky, John

**L.U. NO. 1138
TOLEDO, OHIO**
Brecklin, William
Clair, Coutchure
Dickerson, Alonzo
Nichol, Alfred
Stieb, Carl

**L.U. NO. 1149
SAN FRANCISCO,
CALIF.**
Hamilton, O. R.
Jones, Floyd
McManus, John
Nichols, George
Norton, Frank
Sheppard, George

Continued, next page

IN MEMORIAM

Continued from Page 37

**L.U. NO. 1204
NEW YORK, N.Y.**

Bessowitz, Leon
Fassman, Phillip
Glass, Sidney
Guerrizio, Michael
Meizs, Zanis
Millner, David

**L.U. NO. 1235
MODESTO, CALIF.**

Baker, Lawrence
Sliger, Henry F.
Watkins, I. D.

**L.U. NO. 1323
MONTEREY, CALIF.**

Comer, T. E.

**L.U. NO. 1397
N. HEMSTEAD, N.Y.**

Barnes, Charles G.

**L.U. NO. 1445
TOPEKA, KAN.**

Johnson, Emmett B.
Purdy, James F.
Robertson, John F.
Walrafen, Frank
Woodford, C. A.

**L.U. NO. 1541
VANCOUVER, B.C.**

Van Denzel, Ken

**L.U. NO. 1565
ABILENE, TEX.**

Cramer, George A.
Davis, Charles D.
Koen, Ben
Self, C. A.

**L.U. NO. 1599
REDDING, CALIF.**

Whiting, Charles H.

**L.U. NO. 1772
HICKSVILLE, N.Y.**

Elliott, Robert
Latva, Matti
Modrich, John
Soukup, Stein

**L.U. NO. 1784
CHICAGO, ILL.**

Novak, Joseph

**L.U. NO. 1805
SASKATOON, SASK.**

Bender, Elmer
Jewitt, William
Johnson, Wesley
Pacholka, Walter

**L.U. NO. 1837
BABYLON, N.Y.**

Elefante, James
Spitzig, Gus

LEGACIES OF LONG SERVICE

Local 343, Winnipeg, Manitoba, recently lost two senior members, who had devoted much of their adult lives to service to their local union and the Brotherhood. The local union mourns the deaths of Frank Chambers, who was initiated into the Brotherhood on August 16, 1906, and J. B. Graham, who was initiated on April 11, 1919.

Local 53, White Plains, N.Y., reports the loss of Humphrey O'Leary, a 55-year member who passed away a few weeks ago.

Local 434, Chicago, Ill., mourns the passing of Nicholas Penn, a 68-year member. Brother Penn was initiated in 1902 at the age of 23. He died early this year at the age of 91.

Local 131, Seattle, Wash., pays tribute to T. O. Berg, its oldest member, who died several months ago at the age of 99. He was born April 28, 1871, and was initiated into the Brotherhood in 1902.

**L.U. NO. 1963
TORONTO, ONT.**

Brown, Maxwell A.
Noseworthy, Victor
Seguin, Roland

**L.U. NO. 2006
LOS GATOS, CALIF.**

Schultz, William F.
Smalley, Forrest G.

**L.U. NO. 2114
NAPA, CALIF.**

Mundkowski, Hans

**L.U. NO. 2292
OCALA, FLA.**

Mulvanity, Charles

**L.U. NO. 2311
WASHINGTON, D.C.**

Stine, Wade, Sr.

**L.U. NO. 2582
MUSKEGON, MICH.**

Moen, Carl
Sangster, Walter
Sutherland, Timothy
Wilson, Elvis

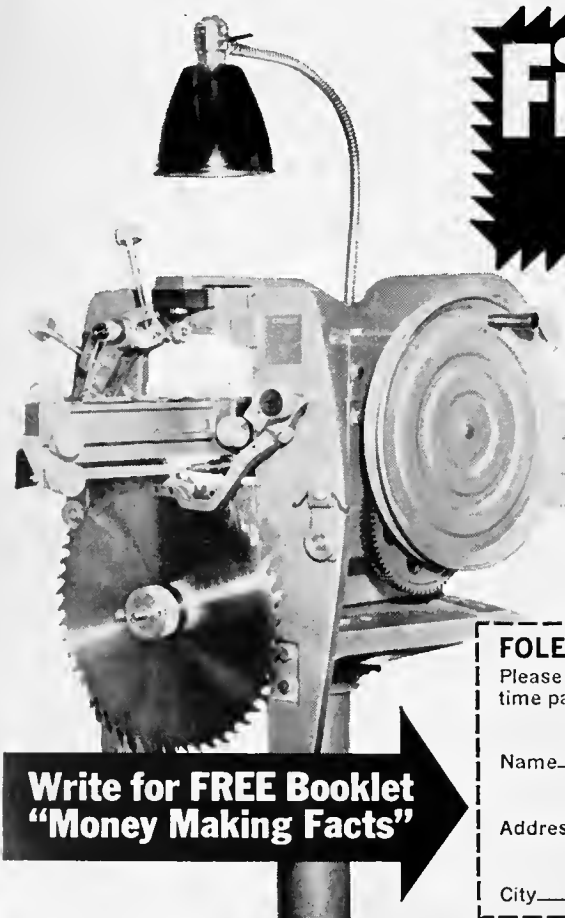

File Saws Easily AUTOMATICALLY

You don't need special training or previous experience to get perfect, sharp blades with the Foley Automatic Saw Filer. Operation is simple—you just follow easy step by step instructions. "The first saw I sharpened with my Foley Filer came out 100%," writes Clarence E. Parsons. This model is the first and only machine that precision files hand, band and both "combination" and cross-cut circular saws. It's so mechanically accurate it's used by saw manufacturers! Takes minimum space in corner of shop.

Set up in Basement or Garage

Foley can show you how to establish your own saw filing service in your basement or garage. A small cash payment puts a new Foley Saw Filer in your hands. The profits you make easily handle the low monthly payments. Operating expense is low—only 7¢ for files and electricity to turn out a complete saw filing job. Mail coupon now for money-making facts and business-building ideas. No salesman will call.

**Write for FREE Booklet
"Money Making Facts"**

FOLEY MFG. CO., 1218-1 Foley Bldg. • Minneapolis, Minnesota 55418

Please rush free book, "Money Making Facts" and details on easy time payment plan.

Name _____

Address _____

City _____ State _____ Zip _____



Lakeland News

Items of interest from the Brotherhood's retirement home at Lakeland, Florida

Lakeland Leave Ends in Marriage

W. Pearl Davidson, a member of Local 2217, Lakeland, Fla., entered the Carpenters Home in August, 1970. Because he wore a heart pacer and was unable to get around without assistance, he was assigned to the hospital area, where he remained until May, 1971, when he asked for and was granted leave to visit family and friends in Oklahoma and Arkansas.

A month later he wrote the Home, advising that he was married on June 8, and he requested withdrawal from the Home.

Soon after 83-year-old Davidson arrived in Arkansas, he visited Beulah Chase Vernon, a childhood sweetheart. Both had lost their first mates, each has two children and several grandchildren. Later, their mutual friends and former schoolmates, Mr. and Mrs. Archie Griffith of Siloam Springs, were celebrating their wedding anniversary and invited Davidson and Mrs. Vernon to go with them on a sightseeing trip in the area.

Before the jaunt was over, the reunited twosome decided to get married themselves. They were driven to Tahlequah, where blood tests can be taken and a wedding performed on the same day. When they reached the county courthouse to obtain a marriage license, the bureau had closed for lunch.

They had to have proof of birth, and Beulah had none, so she went across the street from the courthouse and pur-

chased a fishing license, and this was accepted as proof of birth.

A Baptist minister performed the ceremony, and the Davidsons were driven home in wedded bliss.

Daniel E. Leiteman, of Local 627, Jacksonville, Fla., arrived at the Home October 1, 1971.

William Henry Schalow, of Local 1665, Alexandria, Va., arrived at the Home October 4, 1971.

Foster C. Betts, of Local 1275, Clearwater, Florida, arrived at the Home October 4, 1971.

Frank K. Ingham, of Local 200, Columbus, Ohio, arrived at the Home October 6, 1971.

Charles F. Lohengren, of Local 203, Poughkeepsie, N. Y., arrived at the Home October 6, 1971.

Albert B. Moore, of Local 26, East Detroit, Michigan, arrived at the Home October 7, 1971.

Louis Kruppner, of Local 182, Cleveland, Ohio, arrived at the Home October 11, 1971.

Otho Weidenheimer, of Local 55, Denver, Colorado, arrived at the Home October 11, 1971.

Herbert E. Harrald, of Local 80, Chicago, Illinois, arrived at the Home October 14, 1971.

Perry J. Evans, of Local 69, Canton, Ohio, arrived at the Home October 19, 1971.

Bert Walton, of Local 483, San Francisco, California, died October 9, 1971. He was buried in the Home Cemetery.

Golden Bitts, of Local 844, Canoga Park, California, died October 12, 1971. Burial was in San Jose, California.

Otho Weidenheimer, of Local 55, Denver, Colorado, died October 16, 1971. Burial was in Denver.

INDEX OF ADVERTISERS

Audel, Theodore	39
Belsaw Power Tools	31
Belsaw Sharp-All Co.	35
Chicago Technical College	29
Cooper Group	26
Eliason Stair Gauge Co.	31
Estwing Manufacturing	20
Foley Manufacturing	39
Hydrolevel	35
Irwin Auger Bit Co.	33
Knaack Manufacturing	34
Locksmithing Institute	39
North American School of Surveying	33
Stanley Power Tools ... Back Cover	

AUDEL CARPENTERS & BUILDERS LIBRARY

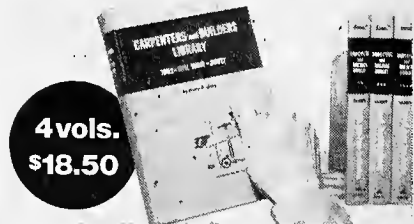

THESE "PAPER TOOLS" can boost your income!

Their 1,488 pages of practical information and how-to guidance are invaluable "tools" for all in the building trades... a complete course for the apprentice, a ready reference for master workers.

Thousands of photos, diagrams and charts tell and show short cuts, new methods, solutions and money-saving ideas... how to use every tool and building aid... how to build everything from furniture to houses... how to frame, roof, excavate, do carpenter arithmetic, estimate costs, trim, insulate, care for tools, etc. They can help you earn more, fast.

MONEY BACK GUARANTEE—You must be completely satisfied with the Audel Guides you order, or you may return them within 10 days and get your money back.

SEND COUPON TODAY

Theodore Audel & Co., 4300 West 62nd St. C-121
Indianapolis, Indiana 46268

Please mail me Carpenters and Builders Library, 4 vols. I agree to mail \$3 in 10 days and to mail 1/2 the total purchase price 30 days later, with the balance plus shipping costs to be mailed within another 30 days. If I am not completely satisfied I may return the books for refund.

Name _____
Address _____
City _____ State _____ Zip _____
Save shipping costs. Enclose \$18.50 (plus sales tax, if any) and we pay postage.

You'll Like Being a
SKILLED LOCKSMITH

You'll EARN MORE, LIVE BETTER than Ever Before in Your Life

Earn \$150 During Training
I realized with LOCKSMITHING I'd be able to double my income. During my training period I made \$150.
Paul Funes
New York, N.Y.

306 Pieces of equipment
LOCKS, PICKS and TOOLS supplied for use with course

Illustrated Book, Sample Lesson Pages FREE
Locksmithing Institute graduates now earning, enjoying life more everywhere. You can, too. Coupon brings exciting facts from only school of its kind Lic. by N. J. State Dept. of Ed., Accredited Member, Natl. Home Study Council, Approved for Veteran Training.

LOCKSMITHING INSTITUTE
Div. of Technical Home Study Schools
Dept. 1118-121, Little Falls, N. J. 07424

LOCKSMITHING INSTITUTE, Dept. 1118-121
Little Falls, New Jersey 07424 Est. 1948

Please send FREE illustrated Book—"Your Big Opportunities in Locksmithing," complete Equipment folder and sample lesson pages—FREE of all obligation—(no salesman will call).

Name _____ (Please Print)
Address _____
City _____ State _____ Zip _____
 Check here if Eligible for Veteran Training



In Conclusion

M. A. Hutcheson, General President



Please Address Yourself To The Problems, Mr. President

■ No convention of the AFL-CIO has created a greater furor in the news media than the 9th Constitutional Convention, which wound up in Miami Beach, late last month.

Charges and countercharges of rudeness and disrespect are still being tossed about by those who back President Nixon and those whose sympathies lie with George Meany.

It seems to me that in all this sound and fury the main points at issue are being totally ignored.

If there was any disrespect shown to the President by the convention, it escaped my attention. There was some laughter when President Nixon said that his economic policies were licking inflation and that the delegates should ask their wives if they doubted this statement. To my way of thinking, that was a humor-

ous statement, because exaggeration is one of the fundamentals of humor, and certainly that statement falls in that category. Either President Nixon does not do very much shopping, or else his arithmetic is sort of faulty.

I remember about six months ago that the President said that everything was going along swimmingly and that, if he had any money, he would buy common stocks. If he had bought common stocks at that time, I'm afraid that he would have lost his shirt, because the market dropped some 100 points from the time he made that statement

Looking at it objectively, I would say that this precipitous decline in stock prices indicates that the money managers and financial experts of the country do not share Mr. Nixon's enthusiasm for the current economic climate. In fact, I think one can safely say that the President stands pretty much alone in his rosy assessment of existing conditions.

In his appearance at the convention he had a wonderful opportunity to address himself to the problems which really plague the nation—persistently high unemployment which refuses to drop below five million; the growing trade deficit, as foreign-made goods flood our markets, while our own goods become less appealing abroad; tax inequities which continue to hit hardest at those least able to pay; the need for the establishment of a medical care system capable of delivering decent medical care to all people.

The President ignored all these vital questions which bear so heavily on the lives of our citizens. Instead, he gave a Madison Avenue performance with all the overtones of a soap opera, telling about his own early struggles, his father's famous grocery store, and his own efforts to achieve a place in society.

Certainly the President of the United States is entitled to the respect of everyone. He holds the most difficult job in the entire world. However, it is a thick-skinned job, and no thin-skinned man can handle it adequately.

There is little to be gained from rehashing what transpired at Miami Beach. Rather, what is needed is a vigorous and concerted attack on the problems which loom very large in the lives of the American people. ■

"Next Time Send Ahead MY Reception Committee, MY Band, MY Television Cameras, And MY White House Guards In Full Uniform, Saluting Me"



Fight emphysema, tuberculosis, air pollution.



CHRISTMAS 1971



GREETINGS 1971



CHRISTMAS 1971



GREETINGS 1971

There's more to do...
Give more to Christmas Seals.

It's a matter of life and breath.





SUPER SWITCH
SPEED CONTROL AND
REVERSIBLE

Stanley now has longer trigger stroke

(over 30% longer for better control of speeds)

Our new "Super-Switch" puts precise control right at your fingertip. Gives you over 30% longer trigger stroke for more control over your speed range (0-1000 RPM) than with conventional speed control drills. And it will outlast the others because it's a switch designed for use in heavy duty applications.

But that's only the beginning. This 3/8" pistol grip reversible speed control workhorse has an oversized fan and cooling system. And a 4 amp rating (none higher in the industry). Four ball bearings deliver the power to the working end of the tool. 3 stages of heat treated precision gearing (most others have two), provide all the torque you need when the drilling gets rough.

Price? \$69.00 – lower than most others charge for single speed heavy duty drills without reverse.

Still looking for reasons to buy our drill? Consider the welded (not soldered) leads to protect against burnout. The removable 3-position auxiliary handle for complete torque control. And new strain relief collar for maximum protection against cord pullout. See your distributor today

or write: Stanley Power Tools,
Division of The Stanley Works,
New Bern, North Carolina 28560.

P.S. Made by the same Stanley that makes the finest hand tools

Model 91061
\$69.00

STANLEY[®]

helps you do things right

