

UC-NRLF



5B 26 318

# THE CAR WHEEL

---

YC 13093

This book is the property of

*A. S. Rosset*

and is sent with the personal compliments of

*Chas. J. Schenck*

*Copy*

GIFT OF  
*H. J. Cory.*

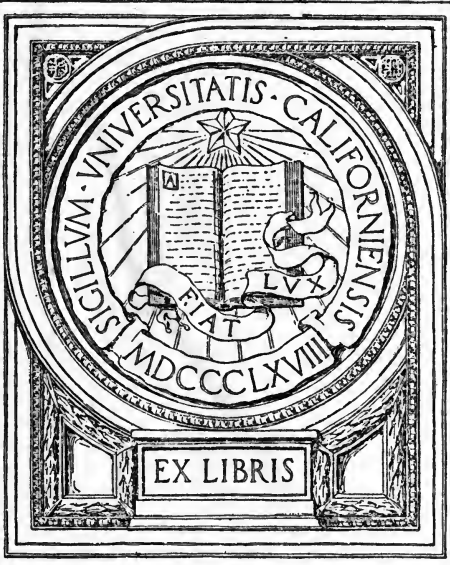

EX LIBRIS

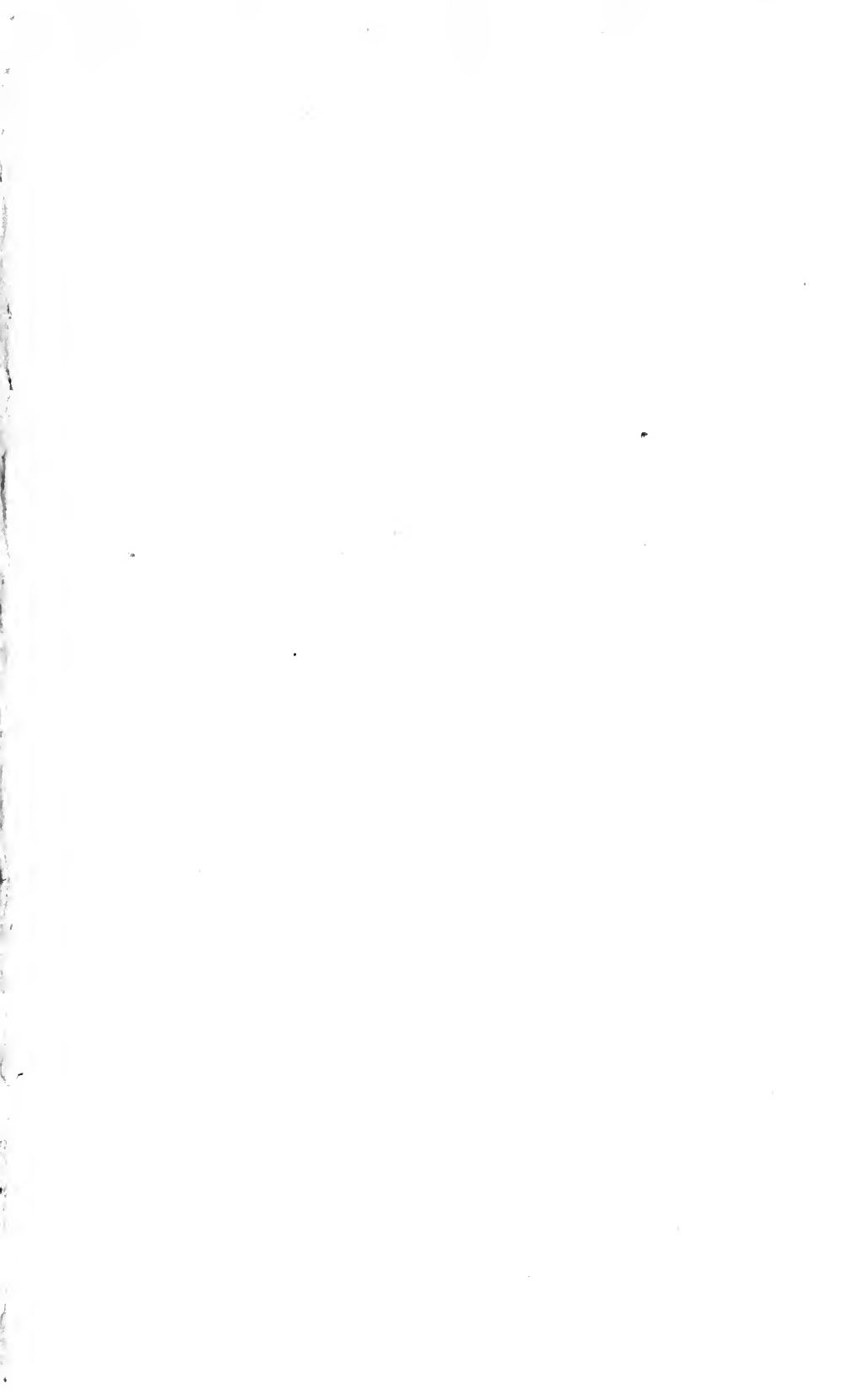

THE  
CAR WHEEL

GIVING THE RESULTS OF A  
SERIES OF INVESTIGATIONS

BY

GEO. L. FOWLER, M. E.



**RICHARD B. GARR,**  
Manager of Sales,  
Crocker Building,  
San Francisco - Cal.

PUBLISHED BY THE SCHOEN  
STEEL WHEEL COMPANY  
PITTSBURGH, PA., 1907

UNIV. OF  
CALIFORNIA

5/4/21

T F 3 2 2  
1 2

Copyright, 1907, by  
THE SCHOEN STEEL WHEEL COMPANY

1 1 1 1

The Fleming Press, New York  
10726

TO THE  
SCHOEN STEEL WHEEL COMPANY

LIBRARY OF  
CONGRESS

435963

TO THE  
ABORIGINAL



Chas. J. Schowen





## FOREWORD

The solid forged and rolled steel wheel, referred to in the following pages of this book, was developed and first manufactured by Mr. Charles T. Schoen, the pioneer builder of high capacity steel freight cars, and former president of the Pressed Steel Car Co.

In the exploitation of large capacity cars Mr. Schoen was confronted with the problem of getting wheels to meet the requirements. The cast iron wheels put under these 100,000-lbs. capacity cars failed repeatedly and the situation became serious. For instance, one railroad, which had in service several thousand of these cars, at one time considered the expedient of marking all of them down to 80,000-lbs. capacity in order to reduce the load on the wheels.

The majority of wheel failures occur on mountain roads with steep grades and sharp curves where long and heavy brake applications are necessary, and the wheel flanges are subjected to severe shocks.

Steel-tired wheels had given satisfactory service under passenger cars running over these mountain roads; but they were out of the question for freight equipment because of their prohibitive cost. The economical value of the high capacity car to the railroads having been demonstrated, the problem was to produce a wheel equal to or better than the steel-tired wheel in strength and at a cost for mileage less than that of the cast iron wheel.

Mr. Schoen began his experiments in 1898, and early in 1901 the first machinery for making these

wheels was designed. The Schoen Steel Wheel Co. was organized on May 11, 1903, and the business of making solid forged and rolled steel wheels established for the first time on a commercial basis.

The enterprise has been a success from the start, fully justifying the large expenditure of money required in development work, and for the installation of the necessary machinery. At the present time the company has a plant in operation, located at Pittsburgh, Pa., capable of producing 250,000 wheels a year, and in connection with it open hearth furnaces with an annual capacity of 100,000 tons of steel for making the blooms from which the wheels are forged and rolled. The entire process from raw material to finished wheels is under the direct control and supervision of the company.

The Schoen solid forged and rolled steel wheel has proven such a pronounced success in America that it has attracted the favorable consideration of foreign railways. To supply this European and Colonial demand, The Schoen Steel Wheel Co., Limited, of Great Britain, was organized. The works are situated in Leeds, Yorkshire, and have an annual capacity of 100,000 wheels.

## Schoen Steel Wheel Co.

Pittsburgh, Pa.  
November, 1907

## PREFACE

When this investigation of wheels and tires was first undertaken its ultimate scope had not been decided upon, and it was the expectation that it would end when the first few comparative results had been obtained. It was made solely for the purpose of securing information regarding the standards of quality of metal and workmanship that must be met in the development of a new industry, the success of which depended on the production of a wheel that would at least meet the present requirements of railroad traffic. There was no intention of publishing the results, and this accounts for the apparently unfinished condition of much of the work. As soon as sufficient data had been obtained in one line of investigation to serve as a working basis, attention was turned to another branch of the subject. Results obtained in the various tests referred to, therefore, must not be accepted as complete, but the records of the work so far done are made public with the thought that if they serve no other purpose the attention of railroad officers will be attracted to the field of railroad dynamics, as yet unexplored.

In the presentation of the results obtained no attempt has been made to harmonize them with previous theoretical deductions, nor has any attempt been made to build a theory upon them as a basis. Only elementary mathematical calculations have been introduced in order to show about what can probably be expected from a continuance of investigations along the same lines.

Such a piece of work as this could not, of

necessity, be carried on without material assistance from the railroads, wherever track and rolling stock was required, or defective and worn-out material was to be obtained. Such assistance has been generously and cheerfully given whenever it has been asked for. Acknowledgments are due to Messrs. A. W. Gibbs, D. F. Crawford, Wm. McIntosh, G. W. Wildin, J. F. Deems, and Prof. Wm. Campbell, for materials furnished for examination and for assistance, and to Messrs. E. G. Ericson of the Pennsylvania Lines West, J. E. Childs, E. Canfield and G. W. West of the New York, Ontario & Western, and J. F. Deems of the New York Central, for the use of track and rolling stock.

GEO. L. FOWLER.

New York  
November, 1907

## DESIGN OF THE SOLID FORGED AND ROLLED STEEL CAR WHEEL.

WITH a wheel made of one solid piece of steel having the requisite physical properties, it follows that a design can be used differing radically from a wheel having the center and the tire separate. The tire of a steel-tired wheel must be of such a thickness that it will admit of a reasonable amount of wear and at the same time leave enough metal in that part of the tire which is scrapped to insure strength against breakage during the last days of the life of the wheel. With the solid forged and rolled steel wheel, having the rim integral with and stiffened by the web, more wear can be safely allowed than where the stretching or breakage of the tire under the rolling and pounding action of service must be provided against. The solid forged and rolled steel wheel resembles somewhat the cast iron wheel in section, the difference being in the web, where there is a single plate instead of double plates and no brackets as in the standard cast iron wheel.

The details of the dimensions of car wheels vary with the requirements of the railroads using them. There is a wide difference of opinion as to the best proportions for the thickness of the rim, while the dish and length of hub are determined to a great extent by the details of truck construction. This is especially so in electric railway work, where the wheel must be made to fit in between the motor on the inside and the journal boxes on the outside. Ordinarily the dish of the wheel is determined by the

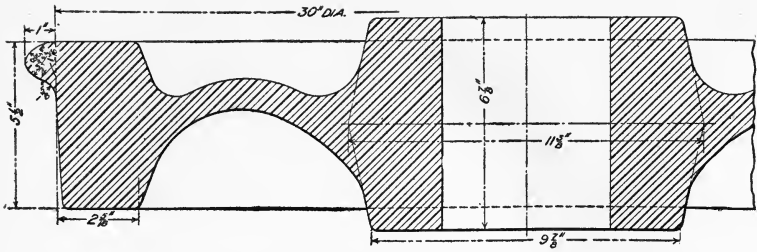

SOLID FORGED AND ROLLED STEEL WHEEL FOR ENGINE TRUCK.

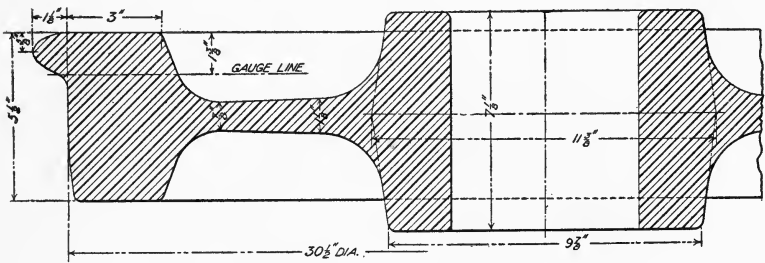

SOLID FORGED AND ROLLED STEEL WHEEL FOR ENGINE TRUCK.

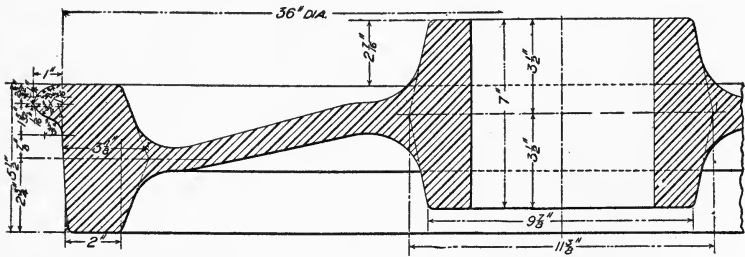

SOLID FORGED AND ROLLED STEEL WHEEL FOR PENNSYLVANIA R.R.

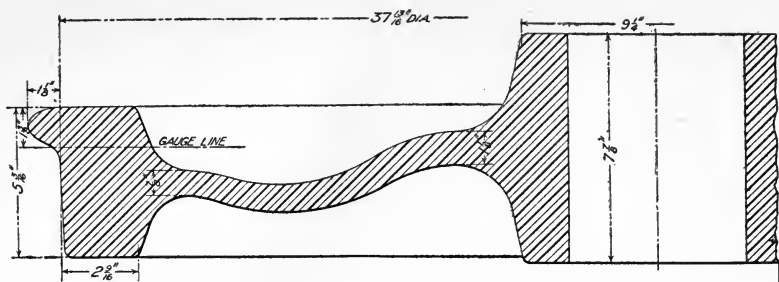

SOLID FORGED AND ROLLED STEEL WHEEL FOR AMERICAN CAR AND FOUNDRY CO.

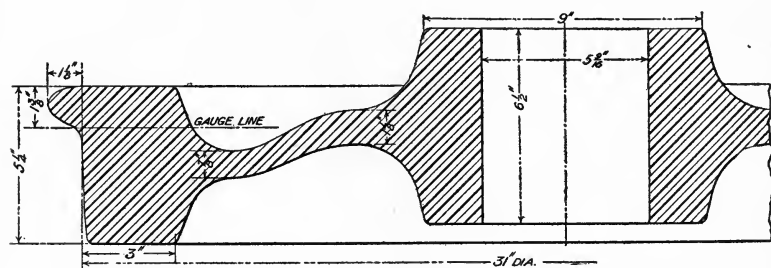

SOLID FORGED AND ROLLED STEEL WHEEL FOR TRAILER TRUCK INTERBOROUGH RAPID TRANSIT CO.

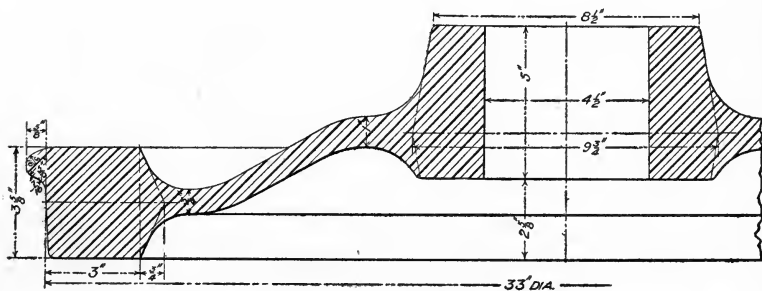

SOLID FORGED AND ROLLED STEEL WHEEL FOR ELECTRIC STREET CARS.

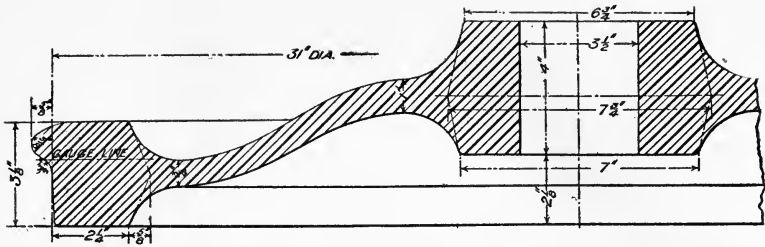

SOLID FORGED AND ROLLED STEEL WHEEL FOR ELECTRIC STREET CARS.

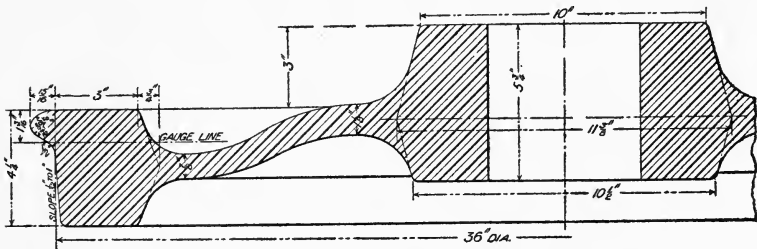

SOLID FORGED AND ROLLED STEEL WHEEL FOR CLEVELAND AND SOUTH-WESTERN TRACTION CO.

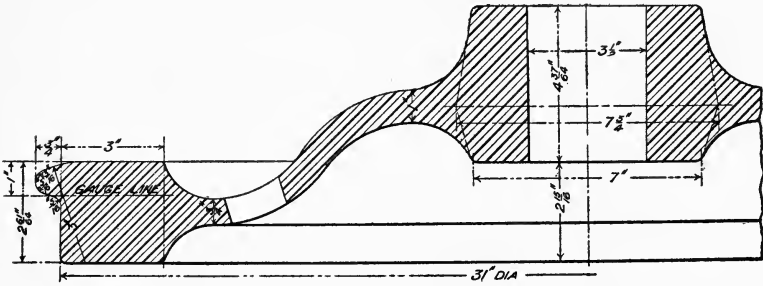

SOLID FORGED AND ROLLED STEEL WHEEL FOR PHILADELPHIA RAPID TRANSIT R.R.



size of the journal box and its location relatively to the tread; but the form given to the web dishing, the thickness of the rim and the size of and shape of the flange and tread are matters for individual consideration in each case.

In wheels intended for steam railroad service the treads and flanges are uniform, corresponding to the M. C. B. standard. The variations in design are found in the webs and hubs, the thickness of rims, and occasionally a variation in the height of the flanges is allowed if the wheels are intended for engine trucks.

Examples of these variations are shown in the accompanying diagrams. Thus, of two engine truck wheels illustrated one has a dished web, by which some yield is secured to compensate for the variations in the diameter of the rim due to temperature changes, while on the other hand the wheel with a straight web is preferred by some motive power departments for exactly the same service.

The wheel for the Pennsylvania Railroad has a rim 2 inches thick at the outer face of the tread, and the web is straight in section from the bend at the hub to the bend under the rim. The wheel for the American Car & Foundry Co. is thicker in the rim, and the web has a curved contour designed to compensate for expansion and contraction of the rim. Again, in the wheel designed for the Interborough Rapid Transit Co. the thickness of the rim has been increased to 3 inches although the diameter is but 31 inches. This wheel also has the curved contour web.

In electric service will be found the widest variations of practice. Street railways keep the floor of the

car as close to the rails as possible, so as to facilitate the entrance and exit of passengers. At the same time it is necessary to maintain a minimum diameter of wheel in order to provide sufficient clearance between the street pavement and the lowest point of the motors. The thickness of the rim is therefore determined by adding to the minimum allowable radius of the wheel a sufficient thickness of metal to raise the car to the maximum height deemed advisable, and this dimension represents the amount of metal to be worn away.

The wheel designed for the interurban cars of the Cleveland & Southwestern Traction Co. is an interesting example of a compromise between the M. C. B. standard wheel for steam roads and the lighter wheel ordinarily used in street railway work. The cars are heavy and the speed is moderately high, necessitating a web and hub of considerable strength and a flange high enough to hold the car to the rails at the speeds attained in the open country and yet low enough to permit the wheels to pass over the rails and special work in the city.

# C O M P A R A T I V E P H Y S I C A L A N D C H E M I C A L T E S T S O F S O L I D F O R G E D A N D R O L L E D S T E E L W H E E L S , S T E E L T I R E S A N D C A S T I R O N W H E E L S .

ALL the tires and wheels referred to in this work were bought in the open market, chosen at random, and tested under identical conditions in comparison with each other. They represent the principal brands in use giving satisfactory service, and the results stand on the basis of each sample representing the average of its class and brand. They will be designated as Tires A, B, C and D, Wheels E and F and Schoen Wheel.

Tests were made of the tensile strength, including the limit of elasticity, per cent. of elongation, and the reduction of area at the point of fracture. The steels were tested for hardness by a drop of the Martel scale. Abrasion tests were made in order to find the resistance of the several materials to grinding at various points below the tread. Specimens were also cut for the determination of the specific gravity of the metals at different points below the tread. Chemical analyses were made from samples of each tire and wheel taken from a point below the center of the tread. Finally, a series of microphotographs were taken of etched specimens of the metals in order to show their structure and the relation of that structure to the physical and chemical properties previously determined independently.

The chemical analyses for carbon were all made by the combustion process and the tensile tests were

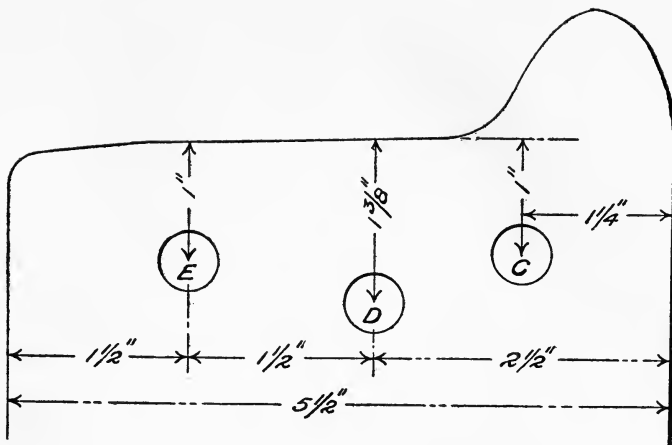

LOCATION OF TENSILE TEST SPECIMENS.

made in the usual manner, using test pieces 2 inches long between marks. The reason for choosing this length was that the curvature of the treads of the wheels and tires made it impossible to cut longer ones. These specimens were cut from the points C, D, and E, as indicated on the diagram showing the location of tensile test specimens. These test pieces were cut on a chord of the tire and gave an available length of 2 inches on the reduced area  $\frac{1}{2}$  inch in diameter, the center of which was carefully located at the point indicated on the drawing. The tensile tests were made in an Olsen testing machine of 100,000 lbs. capacity, and the results obtained are given in detail in the following table marked "Comparative Tests of Steel Wheels and Tires."

The averages of these are collected and presented in a condensed form in the table marked

COMPARATIVE TESTS OF STEEL WHEELS AND TIRES.

Test Piece.	Tire or Wheel.	Per cent. of Elongation in 2 inches.	Per cent. of Reduction of Area.	Maximum Load per square inch. Lbs.	Breaking Load per square inch of Section. Lbs.	Approximate Limit of Elasticity per square inch of Section. Lbs.	Per cent. of Elasticity to Total Load.	Hardness on the Martel Scale.
C	C Tire . . .	14.00	16.31	115,825	112,672	73,758	63.68	787
D	" " . . .	14.00	15.39	116,639	112,264	76,286	65.40	787
E	" " . . .	12.45	15.97	117,818	115,120	81,388	69.08	880
C	A " . . .	9.85	8.50	124,013	123,682	94,258	76.00	851
D	" " . . .	11.75	13.48	125,542	122,511	91,673	73.02	778
E	" " . . .	12.50	12.37	122,488	117,859	89,018	72.67	823
C	D " . . .	20.75	26.79	115,439	103,381	94,143	81.55	786
D	" " . . .	20.75	32.00	116,533	106,000	99,232	85.15	750
E	" " . . .	21.50	34.80	115,977	102,905	91,648	79.02	812
C	B " . . .	15.40	18.89	115,784	108,690	94,710	81.79	839
D	" " . . .	16.00	19.53	112,660	106,573	96,883	85.99	787
E	" " . . .	14.85	19.32	115,113	108,703	94,104	81.75	773
C	E Wheel . .	10.50	10.50	115,290	108,132	83,764	72.65	901
D	" " . . .	4.00	3.04	107,967	107,967	84,270	78.05	795
E	" " . . .	7.75	7.08	117,572	117,453	79,130	67.19	921
C	F " . . .	15.75	19.68	114,616	110,320	94,051	82.05	907
D	" " . . .	15.75	17.11	115,266	111,424	94,825	82.26	867
E	" " . . .	13.25	14.54	113,548	110,828	97,864	86.19	851
C	Schoen Wheel	7.00	8.52	127,678	126,354	103,252	81.25	1003
D	" " . . .	8.00	12.41	121,950	119,875	108,977	89.36	1223
E	" " . . .	11.00	20.80	124,129	118,340	110,143	88.73	1149

AVERAGE OF COMPARATIVE TESTS OF STEEL WHEELS  
AND TIRES.

Tire or Wheel.	Per cent. of Elongation in 2 inches.	Per cent. of Reduction of Area.	Maximum Load per square inch. Lbs.	Breaking Load per square inch of Section. Lbs.	Approximate Limit of Elasticity per square inch of Section. Lbs.	Per cent. of Limit of Elasticity to Total Load.	Hardness on the Martel Scale.
C Tire	13.50	15.89	116,761	113,352	77,133	66.06	818
A "	11.35	11.45	124,018	121,951	91,646	73.89	817
D "	20.90	29.50	115,963	104,095	95,008	81.92	783
B "	15.40	19.33	114,519	107,989	95,232	83.18	799
E Wheel	7.40	6.87	113,610	111,184	82,388	72.63	872
F "	14.90	17.13	114,477	110,857	95,580	83.50	875
Schoen Wheel	8.66	12.32	124,386	121,523	104,124	86.45	1125

“Average of Comparative Tests of Steel Wheels and Tires.”

From this table it will be seen that in the wheels and tires examined the average maximum tensile strength varied from 113,610 lbs. to 124,386 lbs. per sq. in. of section; that the elongation in 2 inches varied from 7.40 per cent. to 20.90 per cent.; the limit of elasticity from 66.06 per cent. to 86.45 per cent. of the maximum tensile strength; and the hardness from 783 to 1125 points on the Martel Scale.

In reviewing these results it is necessary to consider the relative influence of the chemical composition on them. This is given in the table marked “Chemical Composition of Steel Wheels and Tires.”

As would be expected the low carbon content of the D tire is accompanied by comparatively low tensile strength, high ductility and low hardness.

At the same time it is evident that the work put

CHEMICAL COMPOSITION OF STEEL WHEELS  
AND TIRES.

Wheel.	Carbon.	Phosphorus.	Sulphur.	Manganese.	Silicon.
C Tire . . . . .	0.616	0.048	0.011	0.698	0.305
A " . . . . .	0.716	0.095	0.023	0.753	0.263
D " . . . . .	0.573	0.075	0.038	0.763	0.509
B " . . . . .	0.676	0.061	0.035	0.833	0.254
E Wheel . . . . .	0.646	0.071	0.029	0.978	0.249
F " . . . . .	0.631	0.081	0.042	0.775	0.241
Schoen Wheel . . . . .	0.690	0.012	0.000	0.870	0.094

on the wheel is an influential factor in all of these results and there is a variation of tensile strength and ductility that is not fully accounted for by the variation of carbon content. Take as an extreme example the E wheel and the Schoen wheel. There is a variation of but .044 per cent. in carbon, and yet the maximum tensile strength of this E wheel was but 113,610 lbs. per sq. in. while that of the Schoen wheel was 124,386 lbs. with a corresponding elongation in 2 inches of 7.40 per cent. and 8.66 per cent. respectively, while the limit of elasticity was 72.63 per cent. and 86.45 per cent. of the tensile strength respectively. The actual variation in limit of elasticity was much greater, because of the higher base of comparison with the Schoen wheel; the limit of elasticity of the E wheel being but 79.12 per cent. of that of the Schoen wheel. In making these tensile tests great care was exercised not only in the preparation of the specimens, but in making the tests themselves. The machine was run slowly after a stress of 50,000 lbs. had been reached, so that the limit of elasticity could be very accurately determined.

**COMPARATIVE RESULTS OF PHYSICAL TESTS OF  
SCHOEN STEEL WHEELS WITH OTHER  
WHEELS AND TIRES.**

Tire or Wheel.	Maximum Load per square inch. Lbs.	Per cent. of Elongation in 2 inches.	Per cent. of Reduction of Area.	Breaking Load per square inch of Section. Lbs.	Approximate Limit of Elasticity per square inch of Section. Lbs.	Per cent. of limit of Elasticity to Total Load.	Hardness on the Martel Scale.
Schoen Wheel . . .	100.00	100.00	100.00	100.00	100.00	100.00	100.00
A Tire . . . . .	99.70	131.06	92.94	100.35	88.02	85.47	72.62
C " . . . . .	93.87	155.89	128.98	93.28	74.08	76.41	72.71
D " . . . . .	93.23	241.34	239.45	85.66	91.25	94.76	69.60
B " . . . . .	92.07	177.84	156.90	88.86	91.47	96.22	71.02
F Wheel . . . . .	92.03	172.05	139.04	91.22	91.79	96.59	77.78
E " . . . . .	91.34	85.45	55.76	91.49	79.12	84.01	77.51

A comparison of the results obtained with all wheels and tires with those obtained with the Schoen steel wheel are given in the table marked "Comparative Results of Physical Tests of Schoen Steel Wheels with Other Wheels and Tires" in which the results obtained with the Schoen wheel are taken as a base, and the results obtained with the other wheels and tires are given in percentages of that base. From this table it appears that the Schoen wheel leads all of the others in the items of tensile strength, limit of elasticity, per cent. of limit of elasticity to ultimate strength and in hardness.

The tests for hardness were made with a drop arranged with a pyramidal punch. The principle on which this work was done was to measure the force of a blow delivered by the punch on the smooth face of the metal to be tested, as well as the amount



of metal displaced by the blow. This method of testing was devised by Col. J. T. Rodman of the United States Army. It was afterwards developed and formulated by Lieut. Col. Martel of the French army and was then adopted as a standard test by the French government. The results obtained are known as the degrees of hardness by the Martel scale. By his investigations Col. Martel showed that the amount of metal displaced by the punch varied inversely as the hardness and directly as the weight of the drop and the height of the fall.

In this investigation the Rodman pyramidal punch was used. It was fastened to a drop weighing, together with the punch, 2.2616 kilograms, and the height of fall was 600 millimeters. The punch was of hardened tool steel, carefully ground to form, and it withstood the work without deformation.

The specimens for the test were cut from the tires and wheels at the same points as the tensile test pieces as indicated at C, D, and E, and the results obtained are given with the other physical properties in the several tables.

These tests show the Schoen wheel to have been the hardest of the seven specimens tested, and that the D tire was the softest. This was to be expected judging from the carbon content; but we note that while the A tire has a higher percentage of carbon than the Schoen wheel, for some reason the latter is the harder of the two.

For the abrasion tests a cylinder  $\frac{1}{2}$  inch in diameter was cut from a point near the center of the tread of each wheel, extending vertically down into the body of the metal. This was placed in a frame, with the

end that was at the tread resting on an emery wheel. A load of 2 lbs. 11½ oz. was put on the upper end of the cylinder to hold it down on the wheel. This weight was selected after some preliminary trials made to ascertain the pressure that could be used without heating the material or grinding it away too rapidly so as to make the count smaller than would be convenient for making comparisons. To this weight must be added the weight of the cylinders themselves, which varied about 0.54 oz., a variation which was duly considered and the proper allowance made therefor, although it is practically a negligible quantity.

The wheel used was made by the Carborundum Co., and was  $10\frac{9}{16}$  inches in diameter and  $\frac{3}{4}$  inch thick when new. At the conclusion of the tests the wheel was worn to a diameter of  $10\frac{5}{16}$  inches. It was known on the maker's schedule as Grit 120; Grade H., Bond G 9. It was run at a speed of about 2,500 revolutions per minute.

While grinding, a constant and uniform stream of water was kept running on the wheel and specimen, and at the conclusion of the test the specimens were invariably cool and showed no signs of heating whatever.

The counting of the revolutions was done by means of a special counter coupled to the shaft and having a worm meshing with a gear of 25 teeth mounted on a shaft to which a revolution counter was attached. The reading of the counter was, therefore, multiplied by 25 to obtain the number of revolutions of the wheel.

In addition to the regular tests, a cylinder was cut from the same position in a chilled cast iron wheel, and the results of its abrasion test, as well as

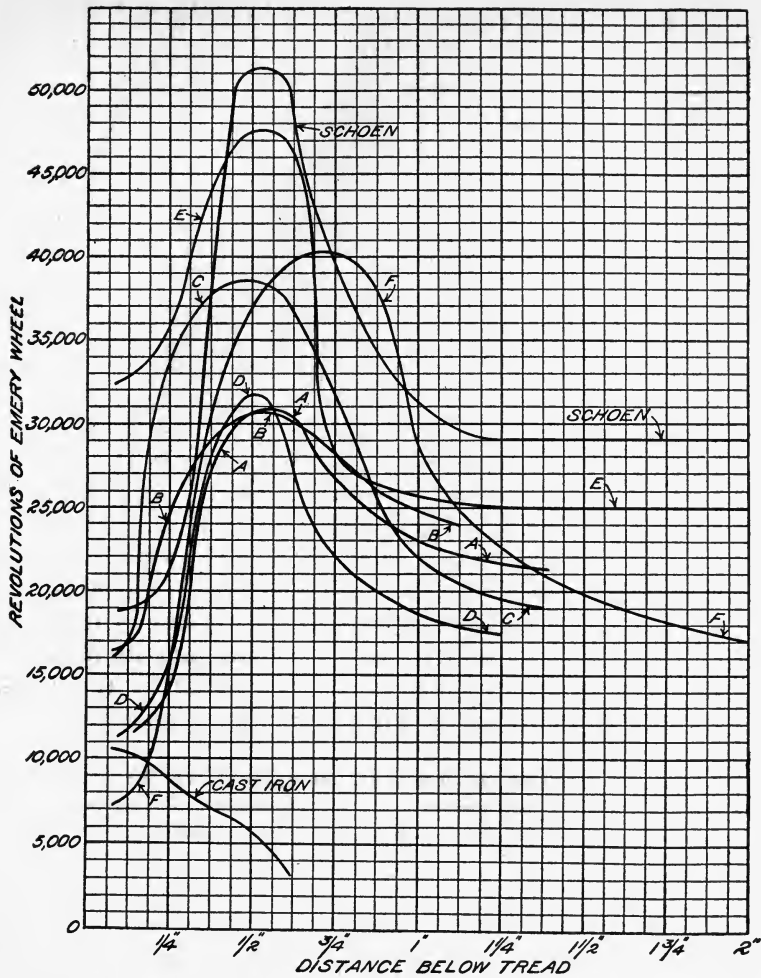

DIAGRAM OF ABRASION TESTS OF STEEL TIRES AND WHEELS, SHOWING RELATION OF RATIO OF WEAR AT VARIOUS DEPTHS BELOW TREAD TO REVOLUTIONS OF EMERY WHEEL.

those of the wheels and tires, have been plotted and shown in the illustration, "Diagram of Abrasion Tests of Steel Tires and Wheels." The abscissas indicate the location of the metal below the tread, and the ordinates the number of revolutions of the wheel required to grind off  $\frac{1}{8}$  inch from a cylinder  $\frac{1}{2}$  inch in diameter.

It will be noted that in every test there is a rise in the number of revolutions at a point about  $\frac{1}{2}$  inch below the surface of the tread, or for the space between  $\frac{1}{4}$  inch and  $\frac{3}{4}$  inch. Had the work been done in rotation this peculiarity might have been attributed to a change in the texture of the wheel, glazing, heating the material, or a similar cause. The tests were started, however, before all of the cylinders had been finished, and those from the A, B, C and D tires were well along when a start was made with the cylinder cut from the Schoen wheel. This was worked down in rotation with those from the tires, when that from the E wheel was introduced, and this was followed in the same way by that of the F wheel, so that the wheel structure itself is responsible for the diagram. By reducing these diagrams to an average the results are as follows:

AVERAGE ABRASION PER  $\frac{1}{8}$  IN. OF TIRES AND WHEELS.

Tire or Wheel.	Revolutions.	Linear Feet.
Schoen Wheel . . . . .	32,635	86,483
E Wheel . . . . .	30,660	81,249
C Tire . . . . .	28,205	74,743
B " . . . . .	26,320	69,748
F Wheel . . . . .	25,540	67,681
A Tire . . . . .	23,270	61,666
D " . . . . .	21,445	56,729
Cast Iron Wheel . . . . .	5,485	14,535

Reducing these to percentages on the basis of the Schoen Wheel we have:

Tire or Wheel	Per Cent.
Schoen Wheel . . . . .	100.00
E Wheel . . . . .	93.95
C Tire . . . . .	86.42
B " . . . . .	80.65
E Wheel. . . . .	78.26
A Tire . . . . .	71.30
D " . . . . .	65.71
Cast Iron Wheel . . . . .	16.81

From this it appears that the resistance of the Schoen wheel to abrasion was greater than that of any of the other wheels and tires with which it was compared. The cast iron wheel gave the lowest resistance of any cylinder tested. The wheel was of good material, with a depth of chill of about  $\frac{5}{8}$  inch.

An explanation of the peculiar rise in the number of revolutions required to grind these tires between  $\frac{1}{4}$  inch and  $\frac{3}{4}$  inch will be brought out in the discussion of the microphotographs. The examination made of the specific gravities of the metal of the tires and wheels at different points below the surface of the tread also tends to show a reason for the peculiar rise in the rate of abrasion by the emery wheel. From this examination it appears that with slight local aberrations the density of the material increases from the tread down to a depth of about 1 inch and then decreases down to 2 inches. A few observations made below these depths show that there is again a tendency to increase in density as the inner edge of the tire is approached. There was,

however, a variation of this condition found in the rim of the Schoen wheel. Although there was a tendency to follow the general behavior of the other specimens it was along a wavy line corresponding, but not in exact location, with the variation in the texture of the grain which will be brought out in the microphotographs to be discussed later.

Another peculiarity that was developed is the relation of hardness, resistance to abrasion and tensile strength to the specific gravity of the material.

It will be noted that the rate of wear of the cast iron wheel, as shown on the diagram, was much greater than that of any of the steel tires or wheels. The rapid fall in the number of revolutions per  $\frac{1}{8}$  inch of metal removed as the chill was worn away is easily accounted for, but it was not expected that the variations from the results obtained with the steel tires would be so great as they were. In the laboratory the metal and wheel were kept cool, so that at no time did the temperature rise, even on the face of the specimen, above that of the hand. As these abrasive tests have been checked in other ways, as will be shown later, it appears that the avoidance of heat is the explanation of the great difference.

It must be borne in mind that the primary object of these investigations was to ascertain to what extent the metal entering into the construction of the Schoen wheel fulfilled the requirements of actual service as determined by comparison with other wheels already upon the market and doing satisfactory work.

The conclusions to be drawn from a general review of the results obtained in this investigation are as follows:

From the physical tests of the metal of the Schoen solid forged and rolled steel wheel, it appears that it is the strongest of any of the tires and wheels examined. This strength appears in the maximum stress to which the metal was subjected, the point at which rupture took place and the limit of elasticity, all of which were higher than in any other wheel or tire, with the single exception of that of the A tire. This tire had a breaking load exceeding that of the Schoen wheel by but 428 lbs. per sq. inch of section, an amount that is unimportant.

The limit of elasticity, as expressed both in actual figures and in the percentage of the total load, was far higher in the Schoen wheel than in any of the others.

The ductility of the metal of the Schoen wheel, as indicated by the elongation of the tensile test pieces, is less than that of any of the other specimens with the exception of the E wheel. Here there is a difference of nearly 15 per cent. in favor of the Schoen wheel, despite the fact that the E wheel contains nearly .05 per cent. less carbon. This is probably due to the difference in the amount of work put on the two wheels.

In hardness the Schoen wheel stands the highest on the scale. This is shown in another way by the abrasion tests, which show the Schoen wheel to be the slowest of any to grind away.

In specific gravity the Schoen wheel is the highest.

The chemical composition is of course a matter that is regulated by specifications and a review of these since the introduction of steel-tired wheels has shown a steady advance in the carbon content.

The makers of the Schoen wheel have placed their wheel next to the highest in carbon content. This explains, in part, the high ultimate tensile strength, although it cannot account for it altogether because the Schoen wheel leads the A tire, which has a higher carbon content, in elasticity and maximum load, and in ductility is above the E wheel having a lower carbon content. In this analysis special attention is directed to the sulphur, not a trace of which could be found in the Schoen wheel specimens under examination.



# MICROGRAPHIC RECORDS SHOWING THE PENETRATION OF WORK AND CHARACTER OF HEAT TREATMENT.

THE physical properties of the steel in these wheels and tires having been determined, an examination with the microscope was made of samples from each. In the preparation of the specimens for this work strips were cut from each wheel and tire in accordance with the lines shown on the diagram. The numbers 1, 2, 3 and 4 are for the identification of the strips and are used in connection with the photographs, all of which were made with a magnification of 88 diameters.

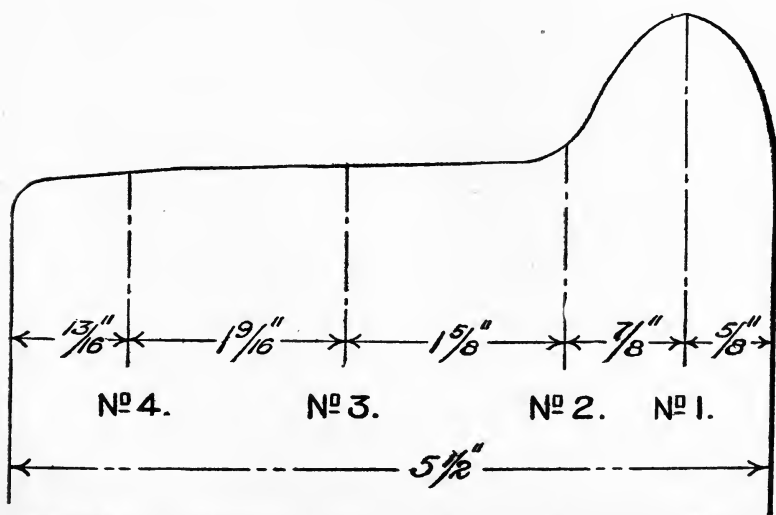

SECTION OF TIRE SHOWING LINES OF LOCATION OF MICROPHOTOGRAPHS

Referring first to the microphotographs of the D tire, Nos. 1 to 6, Nos. 1 to 5 were taken in strip No. 4, at the tread and at  $\frac{1}{8}$  inch,  $\frac{1}{2}$  inch, and 1 inch below the tread respectively, and No. 6 at 1 inch below the tread in strip No. 3. These photographs show an exceedingly fine granular structure, indicating careful heat treatment, a low average percentage of carbon and an abundance of ferrite. The structure becomes somewhat coarser as the metal is penetrated and the normal structure is reached at a depth of about 1 in. It will also be seen that there is a slight difference between the structures of the metal as illustrated by the two photographs Nos. 5 and 6 which were taken at a depth of 1 in. below the tread in strips 4 and 3 respectively. No. 5 is the finer, showing that the metal received more work at that point than it did deeper in on strip No. 3. This D tire had the finest grain and the most uniform structure of the samples examined. On the other hand, the photographs corroborate the chemical analysis of low carbon content, possibly down to 0.50 per cent., as indicated by the proportion of ferrite (white) and pearlite (black).

Next in order of fineness of grain comes the C, B and A tires respectively. Here again the relative amounts of ferrite and pearlite give an approximate indication of the amount of contained carbon, from which it would appear that the B and C tires would not run over 0.60 to 0.65 per cent. while the A may rise to 0.70 per cent.

The material of the B tire shows a practically uniform texture of grain throughout its whole depth,

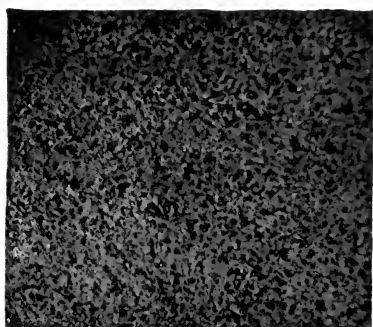

NO. 1. AT EDGE OF TREAD.

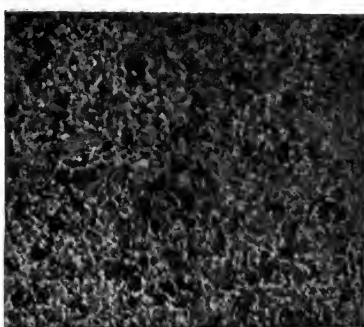

NO. 2.  $\frac{1}{8}$  IN. BELOW TREAD.



NO. 3.  $\frac{1}{4}$  IN. BELOW TREAD.



NO. 4.  $\frac{1}{2}$  IN. BELOW TREAD.

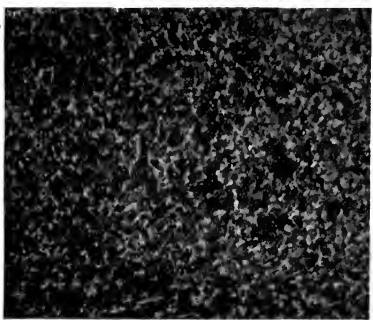

NO. 5. 1 IN. BELOW TREAD.

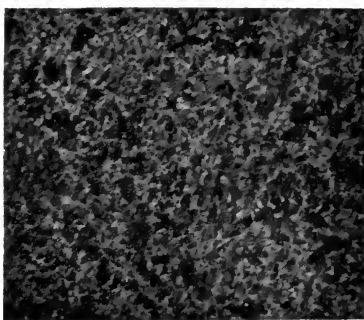

NO. 6. 1 IN. BELOW TREAD.

MICROPHOTOGRAPHS OF TIRE D. 88 DIAMETERS.



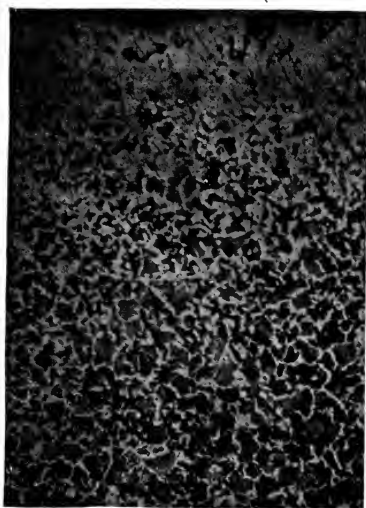

NO. 7. AT EDGE OF TREAD.

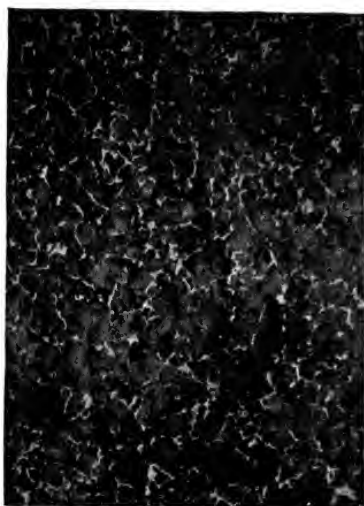

NO. 8.  $\frac{1}{8}$  IN. BELOW TREAD.



NO. 9.  $\frac{1}{2}$  IN. BELOW TREAD.

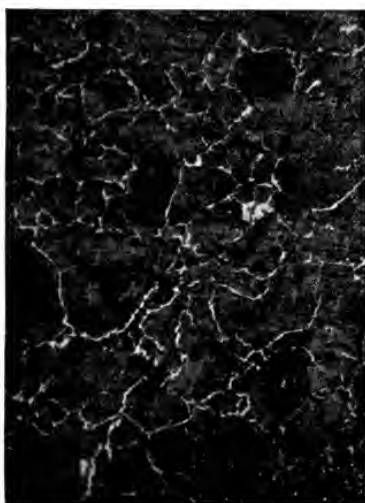

NO. 10. 1 IN. BELOW TREAD.

MICROPHOTOGRAPHS OF TIRE C. 88 DIAMETERS.



with no decarbonization at the tread due to heat treatment, although this is undoubtedly due to the tire having been turned before being examined.

In the C tire, which was new, it will be seen that the outer layer of the material next to the tread, as indicated by the photograph No. 7, was decarbonized by the action of the heat treatment to which it was subjected. The presence of ferrite is very marked all the way across the tread, but below the surface, as indicated by the photographs Nos. 8, 9 and 10, which were taken at depths of  $\frac{1}{8}$  in.,  $\frac{1}{2}$  in., and 1 in. below the tread respectively, the grain assumes the normal condition for the steel at its finishing temperature, although it is somewhat finer at the edge strips Nos. 1 and 4 than in the center strips Nos. 2 and 3, indicating failure of the work to penetrate the center.

The A tire has such a high carbon content that the absence of excess ferrite causes the grain to become obscure; it was possible to bring the formation out in part only by oblique illumination. When viewed under the microscope with the light adjusted to the best advantage a decided coarsening of the grain is noted at successive points below the tread. For example, at the surface the grains are apparently about the same size as those immediately below the decarbonized shell of the tread in the C tire, but the grain coarsens rapidly, and at a depth of 1 in. it is somewhat coarser than that of the C tire. The structure is interpreted from the microphotographs in the accompanying diagram made at the same magnification.

The E wheel has an exceedingly coarse structure with traces throughout of inequality of carbon content

and disappearance of the grain. This is especially noticeable in photographs Nos. 19 and 20 and appears in the others to a greater or less extent, showing an unevenness of structure that is suggestive of cast steel. This is discussed elsewhere in connection with a shelled-out wheel of the same make. The penetration of work was apparently very slight as is shown by the large size of the grains in No. 17, taken at the surface of the tread, and the increasing size of structure as shown in Nos. 18, 19 and 20 taken at depths of  $\frac{1}{4}$  in.,  $\frac{1}{2}$  in., and 1 in. respectively.

The F wheel has a coarser grain than the A, B or C tire and is slightly coarser than that of the D tire. The carbon content appears to be about the same as that of the C tire, or somewhat above 0.60, and this is checked by the chemical analysis. The surface decarbonization which is so marked in the case of the C tire appears in this one also, as indicated by the increase of the amount of ferrite accompanied by softening of the surface. The large size of the grain in this wheel, as illustrated by photographs Nos. 21 to 26, is caused by the heat treatment to which this wheel was subjected. There has evidently been no work put upon it after the final heating. This also explains why there is comparatively little enlargement of the grain going down from the surface of the tread. The photograph No. 21 was taken at the surface of the tread and the others followed at depths of  $\frac{1}{8}$  in.,  $\frac{1}{2}$  in., 1 in.,  $2\frac{1}{8}$  in., and  $2\frac{3}{8}$  in. respectively.

The B tire is typical of the others and needs only a word of explanation of the microphotographs Nos. 27 to 30, which were taken at the surface of the



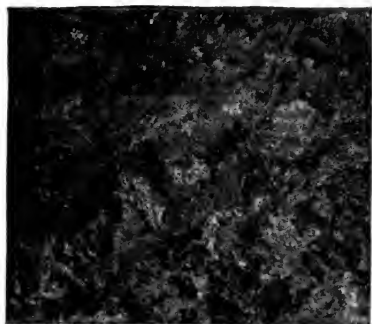

NO. 11. AT EDGE OF TREAD.



NO. 12. AT EDGE OF TREAD.



NO. 13.  $\frac{1}{8}$  IN. BELOW TREAD.

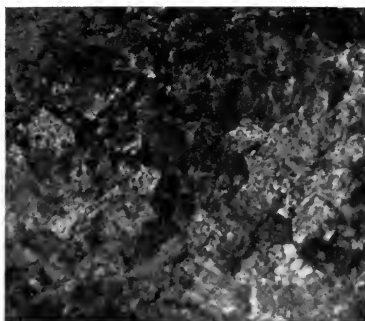

NO. 14.  $\frac{1}{4}$  IN. BELOW TREAD.

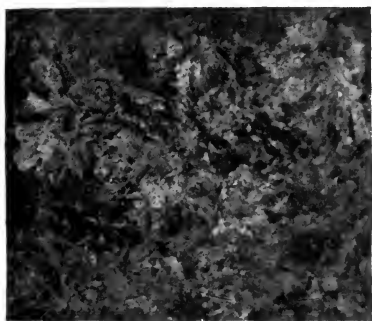

NO. 15.  $\frac{1}{2}$  IN. BELOW TREAD.

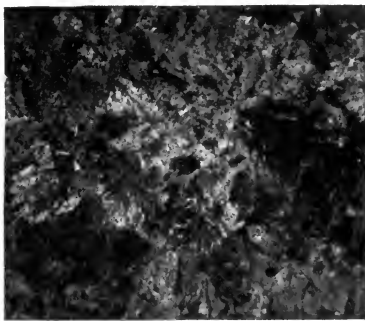

NO. 16. 1 IN. BELOW TREAD.

MICROPHOTOGRAPHS OF TIRE A. 88 DIAMETERS.



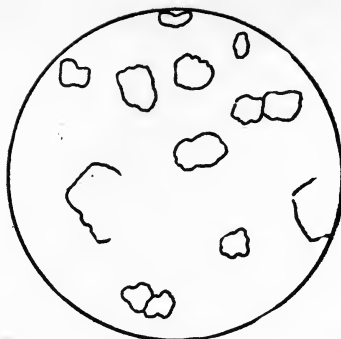

AT EDGE

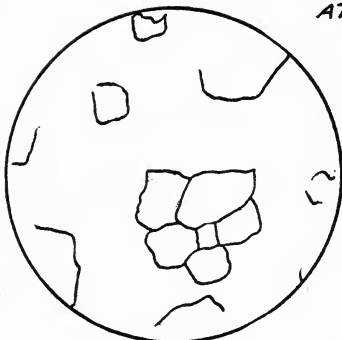

$\frac{1}{8}$  IN.

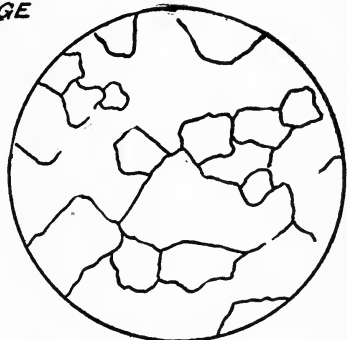

$\frac{1}{4}$  IN.

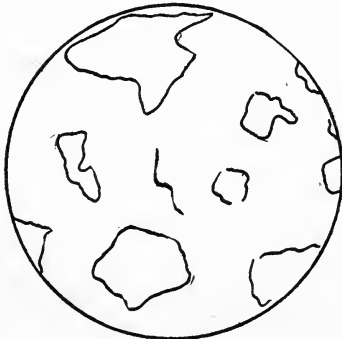

$\frac{1}{2}$  IN.

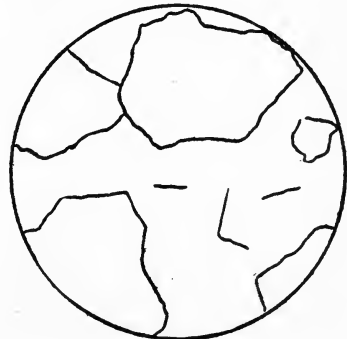

1 IN.

INTERPRETATION OF GRAIN STRUCTURE IN TIRE A AT VARYING DISTANCES BELOW SURFACE OF TREAD.

tread and at depths of  $\frac{1}{8}$  in.,  $\frac{1}{4}$  in., and  $\frac{1}{2}$  in. respectively. From these the gradually increasing size of the grain is apparent, though from its large dimensions, even at the tread, it would appear that this particular tire was finished at a high temperature.

The microphotographs of the Schoen wheel show that for the first  $\frac{1}{8}$  in. of depth it has the finest structure of any of the wheels and tires examined, but below this depth its grain increases in size in a comparatively uniform manner, though with a variation to be noted later. The steel contains but a trace of ferrite, indicating that the carbon content is about the same as that in the A tire. Here again, owing to the absence of sufficient ferrite to outline the grain clearly, it was necessary to photograph by oblique illumination, and it was under this light that the accompanying sketches to show the grain's size were made. The microphotographs closely check the abrasion tests and the determinations of specific gravity.

There are two well-defined zones in the rim of the Schoen wheel that are evidently due to the rolling. One is at a depth of  $\frac{1}{8}$  in. and the other  $\frac{3}{8}$  in. below the surface of the tread. This is best illustrated by the accompanying diagram of the microstructure in the Schoen wheel, in which the four strips and the location of the microphotographs are roughly indicated.

Strip No. 1 shows a very fine grain at the surface with carbon well below 0.50 per cent. This structure runs down for about  $\frac{1}{2}\frac{1}{4}$  in., where there begins a gradual increase of the grain size until the normal dimensions are reached at about  $\frac{1}{1}\frac{1}{2}$  in. below the top



NO. 17. AT EDGE OF TREAD.



NO. 18.  $\frac{1}{4}$  IN. BELOW TREAD.

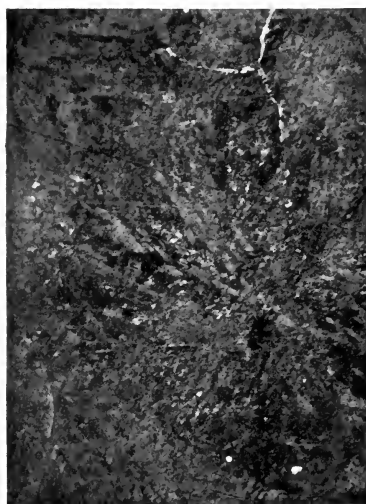

NO. 19.  $\frac{1}{2}$  IN. BELOW TREAD.

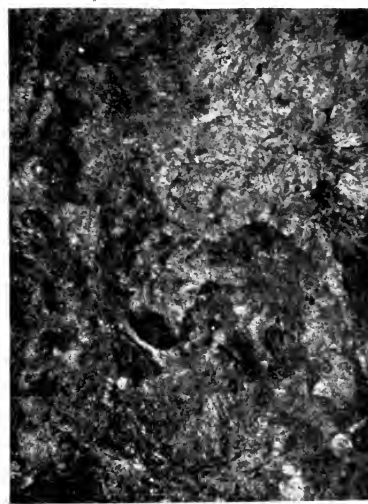

NO. 20. 1 IN. BELOW TREAD.

MICROPHOTOGRAPHS OF WHEEL E. 88 DIAMETERS.



of the flange. The first  $\frac{1}{24}$  in. is formed of a very fine mixture of about equal proportions of ferrite and pearlite, and below this the ferrite gradually disappears and the grains increase in size. At a depth of  $\frac{1}{12}$  in. the ferrite appears as a discontinuous band or envelope around the grains of pearlite, indicating that the carbon content is about 0.70 per cent. This increase in the size of the grains continues downward until they reach their maximum at a depth of about 1 in.

In strip No. 2 there is the same fine-grained surface structure (*a*) corresponding to that of No. 1. The depth of this decreases from one side of the strip to the other and is about  $\frac{1}{80}$  in. thick at the corner. This structure is shown in the photograph No. 31. On the right hand side two zones will be seen, one of which, starting at *f*1, is of very fine pearlite. The point of maximum coarseness is at *c*1. This is not really a coarse grain in itself, for it is fine even when compared with that of the D tire. Below *c*1 there is an abrupt change to extreme fineness again at *f*2. This is followed by a gradual increase in the size of the grain down to *c*2, where the normal structure is found at a depth of about 1 in.

In strip No. 3 there is the same fine grain at the surface, as shown in the photograph No. 32, which extends down to a depth of about  $\frac{1}{50}$  in. The extreme outside shows almost entire absence of carbon, or nearly pure ferrite. This is followed by a gradual increase in the amount of carbon until, at a depth of about  $\frac{1}{50}$  in., a fine grain structure almost wholly of pearlite is indicated at *f*1. Next comes a

uniform increase in the size of the grains until they reach their maximum at the point marked  $c_1$ , where there is an abrupt change to a structure of great fineness which in turn increases in size to a maximum at  $c_2$ , when there is a second abrupt change to extreme fineness at  $f_3$ . Below this there is a gradual increase in the grain size until the normal structure is reached at about 1 in.

In strip No. 4 there is the same decarbonized outer layer ( $a$ ) which is about  $\frac{1}{30}$  in. thick at the center, thickening towards the right in the direction of the edge of the wheel rim. This structure differs in appearance from the corresponding area in No. 3, due to the distortion of the grain by mechanical treatment of the metal after ferrite or pure iron became excessive as the result of burning out the carbon on the surface of the steel. The size of the grain increases from fine at  $f_1$ , to a maximum coarseness at  $c_1$ ,  $\frac{1}{8}$  in. below the surface where there is the same abrupt change as before to a fine structure at  $f_2$ . This will be seen by a reference to photograph No. 38. The grain again increases to a maximum coarseness at  $c_2$ , with another change to extreme fineness at  $f_3$ , at a depth of about  $\frac{1}{2}$  in. Beyond this point the grain increases uniformly until the normal size is reached at a depth of 1 in., as indicated by photograph No. 36, and the diagram of grain sizes.

These changes in grain size are accounted for by the successive heat and mechanical treatments to which the Schoen wheel was subjected.

The conclusions drawn from this work with the microscope are practically the same as those reached



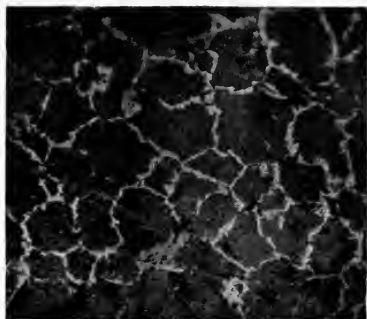

NO. 21. AT EDGE OF TREAD.



NO. 22.  $\frac{1}{8}$  IN. BELOW TREAD.

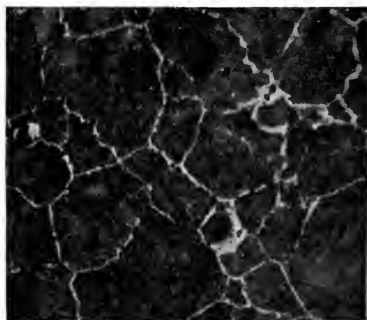

NO. 23.  $\frac{1}{2}$  IN. BELOW TREAD.

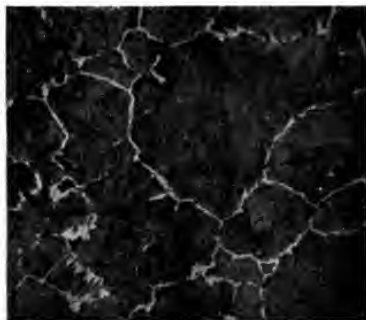

NO. 24. 1 IN. BELOW TREAD.

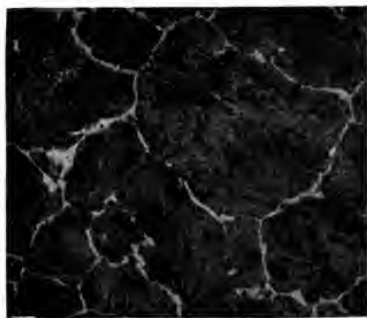

NO. 25.  $2\frac{1}{8}$  IN. BELOW TREAD.

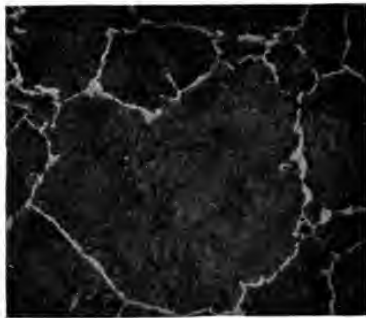

NO. 26.  $2\frac{3}{8}$  IN. BELOW TREAD.

MICROPHOTOGRAPHS OF WHEEL F. 88 DIAMETERS.



by a study of the physical and chemical tests. It is apparent that the Schoen wheel is quite equal to the best tires, as regards depth of finish and the fineness of the grain in the steel.

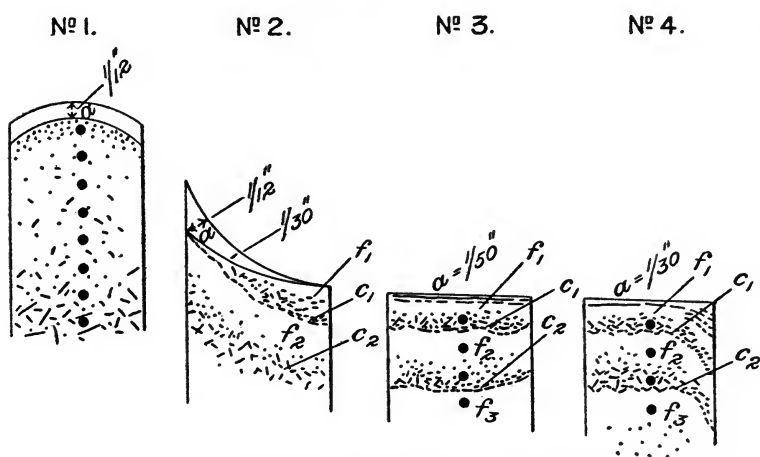
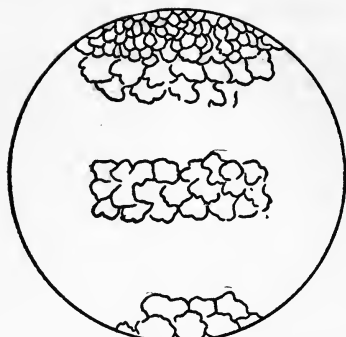
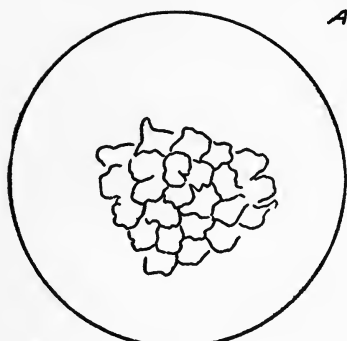

DIAGRAM ILLUSTRATING GRAIN STRUCTURE OF SCHOEN STEEL WHEEL.



AT EDGE



$\frac{1}{8}$  IN.



$\frac{1}{4}$  IN.



$\frac{1}{2}$  IN.

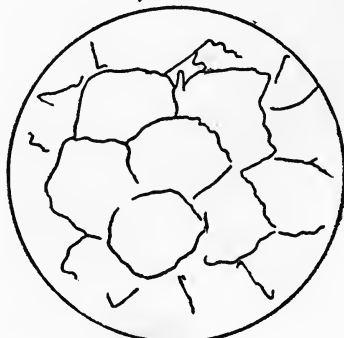

1 IN.

INTERPRETATION OF GRAIN STRUCTURE IN SCHOEN WHEEL AT VARYING DISTANCES BELOW SURFACE OF TREAD.

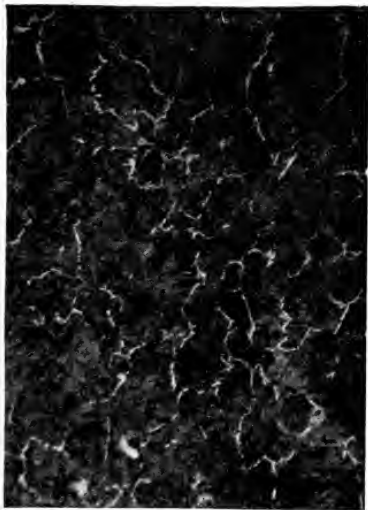

NO. 27. AT EDGE OF TREAD.

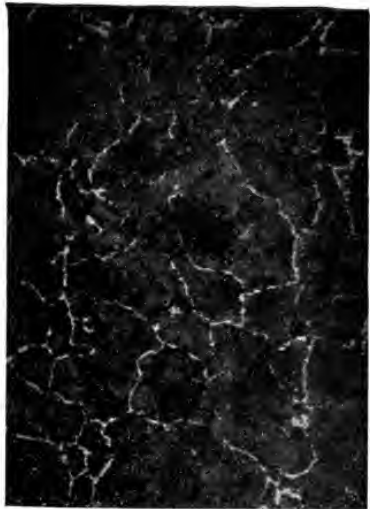

NO. 28.  $\frac{1}{8}$  IN. BELOW TREAD.

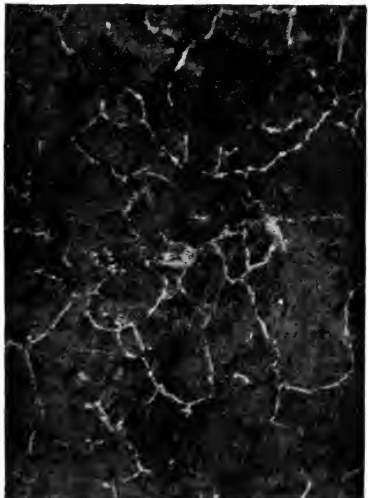

NO. 29.  $\frac{1}{4}$  IN. BELOW TREAD.



NO. 30.  $\frac{1}{2}$  IN. BELOW TREAD.

MICROPHOTOGRAPHS OF TIRE B. 88 DIAMETERS.





NO. 31. AT EDGE OF TREAD.

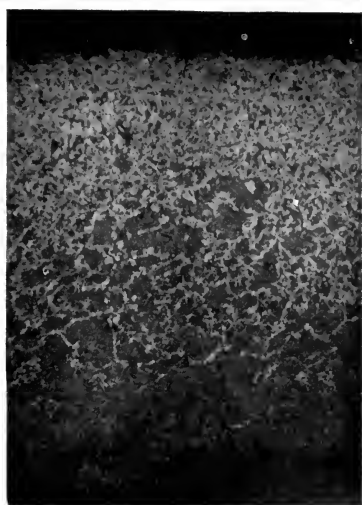

NO. 32. AT EDGE OF TREAD.

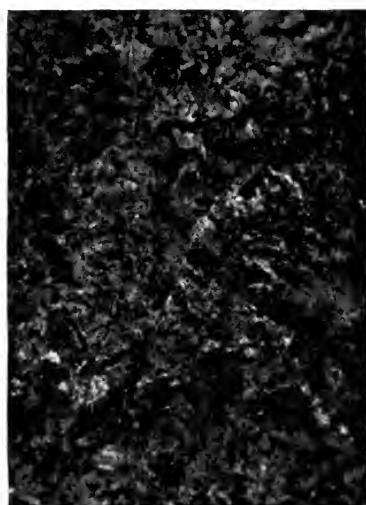

NO. 33.  $\frac{1}{8}$  IN. BELOW TREAD.

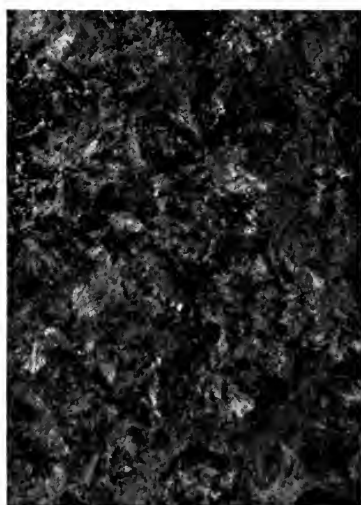

NO. 34.  $\frac{1}{4}$  IN. BELOW TREAD.

MICROPHOTOGRAPHS OF SCHOEN STEEL WHEEL. 88 DIAMETERS.







NO. 35.  $\frac{1}{2}$  IN. BELOW TREAD.

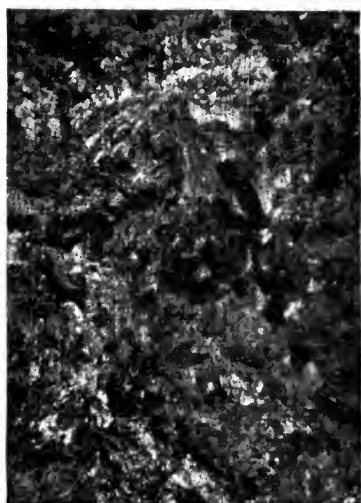

NO. 36. 1 IN. BELOW TREAD.

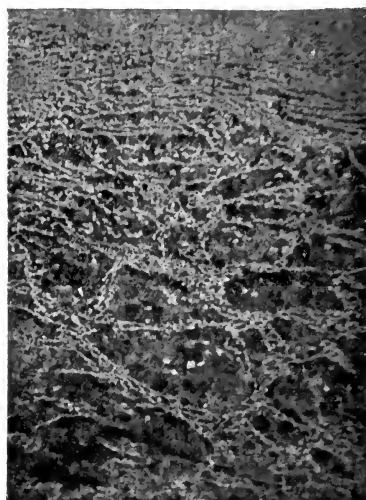

NO. 37. AT OUTER EDGE OF TREAD.

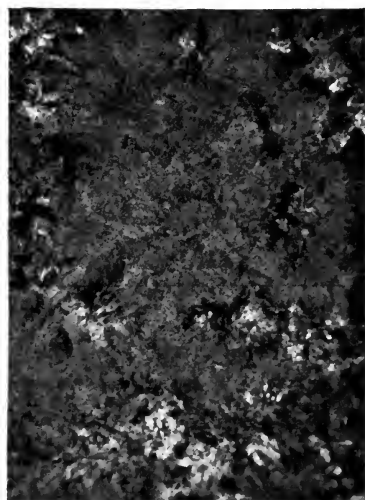

NO. 38.  $\frac{1}{4}$  IN. BELOW OUTER EDGE OF TREAD.

MICROPHOTOGRAPHS OF SCHOEN STEEL WHEEL, 88 DIAMETERS



## THE SHELLED-OUT WHEEL. A POSSIBLE EXPLANATION OF THE CAUSES OF WHEEL AND TIRE FAILURES.

THE service that can be expected from any wheel depends on the soundness and homogeneity of the metal of which it is composed. Irregularity of texture must necessarily result in irregular wear, while local defects are apt to result in an immediate failure. Of such failures one that is the cause of much annoyance and trouble is that known as shelling out. It was for the purpose of ascertaining, if possible, the causes of this shelling out of wheels and tires that an examination with the microscope of a number of defective tires that had failed in service was undertaken.

The Rules of Interchange of the Master Car Builders' Association define a shelled-out wheel as one "with a defective tread on account of pieces shelling out." This is a poor definition; it may be supplemented by saying that the common understanding of a shelled-out wheel is one in which pieces from the tread have flaked off, due to inherent defects in the metal, such as the laminations so frequently found in wrought iron boiler-plates. It will be seen later that the analogy in the case of steel wheels is very close. The cause of shelling out of cast iron wheels is outside of this investigation and will not be considered.

The samples of defective material investigated include one of each brand of wheel and tire previously referred to in these pages, and were obtained

from several railroad companies. Each of these wheels and tires had one or more shelled-out spots on the tread, and there were also places on each where no signs of shelling out could be detected. The general appearance of two samples is shown in the accompanying photographs, and these may be considered as characteristic of all.

A section was taken at the spot where the worst shelling was found and another through a place on the tread where the metal showed no external signs of deterioration. These sections were then cut into strips whose centers lay along the lines 1, 2, 3, and 4 respectively. (See page 29.) The strips were then polished, etched and photographed. The photographs were taken at the tread, and at intervals approximately  $\frac{1}{8}$  in.,  $\frac{1}{4}$  in.,  $\frac{3}{8}$  in., and  $\frac{1}{2}$  in. below. This was not strictly followed in all cases, since the examination was governed, to a certain extent, by the structure of the material examined, as it appeared under the microscope.

Nos. 39 to 42 show the structure of the C tire at the point where the worst shelling out occurred. In strip No. 1, which ran down into the wheel from the flange, the metal shows a fairly good fine-grained structure at the edge and well down into the rim. In No. 39, which was taken at  $\frac{1}{4}$  in. below the edge, spots of manganese sulphide are visible. The metal shows a good structure in all of the strips down to  $\frac{1}{2}$  in. in depth, wherever the photographs avoid the serious defects. In No. 40, however, which was taken from strip No. 3, there is a distinct flaw due to the presence of slag. The same kind of flaw appears, very pronounced, in the photographs Nos.

41 and 42, which were taken from strips Nos. 2 and 3 respectively, and through which a continuous line of slag extends. At other points adjacent to these defective places normal conditions and structure of metal were found.

Photographs Nos. 43 and 44 were taken from points on strip No. 3, at depths of  $\frac{1}{8}$  in. and  $\frac{1}{4}$  in., cut from an apparently solid piece of metal, and yet they show the presence of pronounced slag flaws. These flaws had not developed into shelled-out spots, but it is reasonable to suppose that it was only a matter of time when they would have done so.

Comparing this defective C tire with the sound new tire, the absence of a decarbonized surface on the defective tire is to be noticed, while it was very apparent in the new tire and can be clearly seen in photograph No. 7 (page 33). This is accounted for by the fact that the defective tire was in service and this soft outer shell had been worn away.

The balance of the material of the defective C tire is normal in structure, except that the manganese sulphide globules are large. Its failure is readily accounted for by the slag flaws found scattered through the whole body of the material as shown in Nos. 40 to 44.

The B tire failed from the same cause as the C tire. The structure of the metal is normal through a large part of the sections, but contains occasional slag cracks, and the characteristic markings of manganese sulphide, as shown in No. 45. In the other parts of the tire precisely the same conditions exist as in the C tire, namely, slag cracks, as shown in Nos. 46, 47, and 48, which were taken at various depths,

and where no indication of shelling out had appeared at the time that the tire was removed from service. The presence of such large slag veins as those shown in Nos. 46 and 47 leaves no room for doubt as to the cause of failure. The presence of manganese sulphide was also indicated in the new B tire, but no slag veins are revealed.

Nos. 49 and 50 were taken from the defective A tire. If the metal of this tire is compared with that of the sound new tire, it will be seen that there is no variation in the normal structure of the material to indicate a difference in the wearing quality, so that the failure of the shelled-out tire is undoubtedly due to the slag flaws clearly shown in the photographs.

In the shelled-out D tire normal structure was found but interspersed with slag cracks as in the other defective tires. These are shown in Nos. 51 to 54, some of which were taken close to the edge of the tread. In some places there were spots of manganese sulphide near the edges, but the cause for failure is the presence of the slag flaws that form planes of extreme weakness. In photograph No. 51 such a flaw is shown, which eventually must have caused shelling out. Another example of the same sort is shown in No. 51.

In the E wheel the slag flaws can be seen in Nos. 55 and 56, which were taken from the shelled-out portion. In No. 55 there is a distortion of the slag defects due to the forging, and in No. 57 there can be seen a slag crack which existed in the metal with no visible defect on the surface.

The material in this particular wheel is bad in every particular. The carbon content is low, apparently

-ranging from 0.35 to 0.40 per cent. The effect of both the work and heat treatment is practically *nil* and the structure looks like that of untreated cast steel or a metal that has been overheated. The surface shows the effect of cold rolling in the mixture of ferrite and slag, the whole having a schistose appearance. The presence of so much slag, as shown in Nos. 55, 56 and 57, renders the wheel totally unfit for service. The grain is coarse, as is seen in photos Nos. 58 and 59, and resembles that in the new wheel of the same brand that was examined. The carbon content of the new wheel, however, was apparently much higher.

In the shelled-out portion of the F wheel the slag flaws also appear well down in the metal. (See Nos. 61 and 62.) What was said of the defective E wheel applies to the F wheel. The carbon content seems to be low, while the presence of large quantities of slag, photograph No. 62, caused the many lines of weakness along which rupture occurred.

At the time this examination was being made three specimens of the Schoen solid forged and rolled steel wheel were obtained, two from shelled-out wheels and one from a section of a wheel that had been purposely burned in heating during manufacture. An examination of the photographs of the two defective wheels, Nos. 67 to 70, shows that there are defects in the interior of the metal that were undoubtedly the cause of the shelling out, but there is no evidence of slag. The same characteristics are to be noted in Nos. 65 and 66 of the specimen that had been purposely burned. The three specimens are examples of burned steel in which there is no evidence of slag.

From these photographs it is evident that the cause of the failure of all of the wheels and tires, except the Schoen wheels, was due to the presence of slag flaws occurring near the surface of the tread.

It appears, therefore, that there are at least two causes for the shelling out of steel tires and wheels, namely, slag flaws and overheating.





SHELLED-OUT STEEL TIRE AND WHEEL,



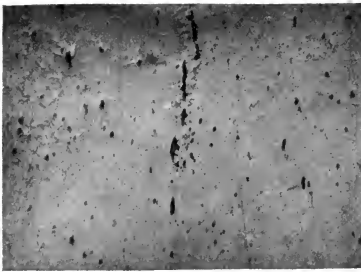

NO. 39. AT  $\frac{1}{4}$  IN. BELOW SHELLED SPOT.



NO. 40. AT EDGE OF SHELLED SPOT.



NO. 41. SHOWING SLAG CRACKS.

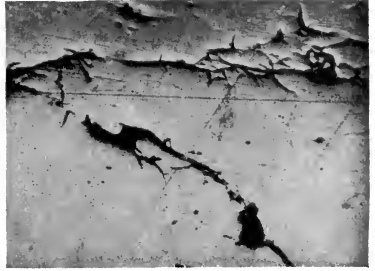

NO. 42. SHOWING SLAG CRACKS.

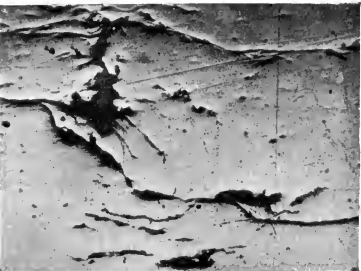

NO. 43.  $\frac{1}{8}$  IN. BELOW TREAD OF SOLID METAL.

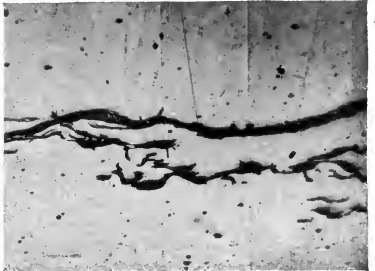

NO. 44.  $\frac{1}{4}$  IN. BELOW TREAD OF SOLID METAL.

MICROPHOTOGRAPHS OF SHELLED-OUT TIRE C. 50 DIAMETERS.



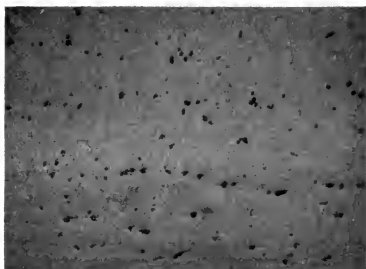

No. 45. AT  $\frac{1}{4}$  IN. BELOW SHELLED-OUT SPOT.



No. 46. SLAG CRACK IN SOLID SECTION OF TIRE.

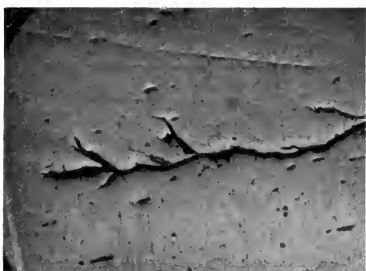

No. 47. SLAG CRACK IN SOLID PART OF TIRE.

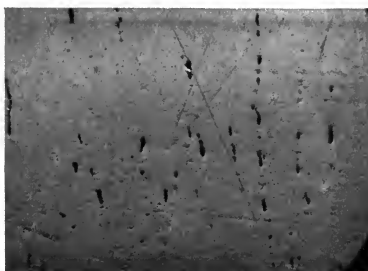

No. 48. MANGANESE BISULPHIDE SPOTS.

MICROPHOTOGRAPHS OF SHELLED-OUT TIRE B.

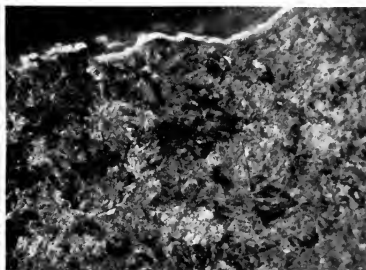

No. 49. AT EDGE OF SHELLED-OUT SPOT.



No. 50. SLAG FLAW NEAR EDGE OF SOLID METAL.

MICROPHOTOGRAPHS OF SHELLED-OUT TIRE A.





NO. 51. SLAG CRACK NEAR EDGE OF  
SHELLED-OUT SPOT.

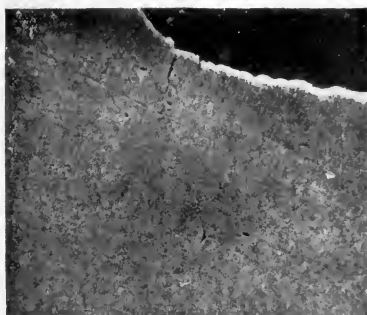

NO. 52. AT EDGE OF SHELLED-OUT SPOT.



NO. 53. SLAG CRACK NEAR EDGE IN  
SOLID METAL.



NO. 54. SLAG  $\frac{1}{4}$  IN. BELOW TREAD IN  
SOLID METAL.

MICROPHOTOGRAPHS OF SHELLED-OUT TIRE D. 50 DIAMETERS.





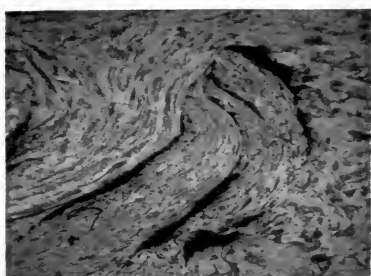

NO. 55. AT EDGE OF SHELLED-OUT SECTION.

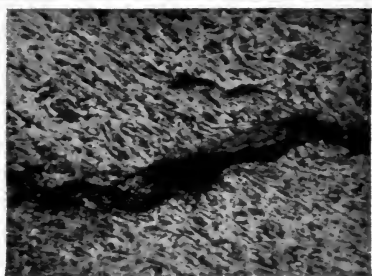

NO. 56.  $\frac{1}{16}$  IN. BELOW TREAD OF SHELLED-OUT SECTION.

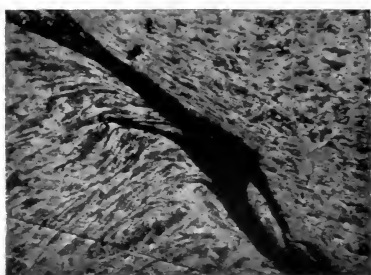

NO. 57. SLAG AT EDGE OF SOLID METAL.

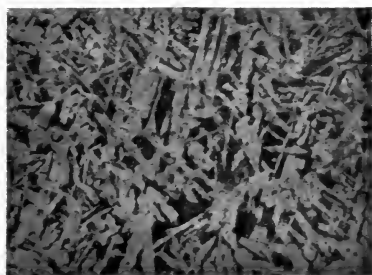

NO. 58. STRUCTURE  $\frac{1}{2}$  IN. BELOW TREAD.

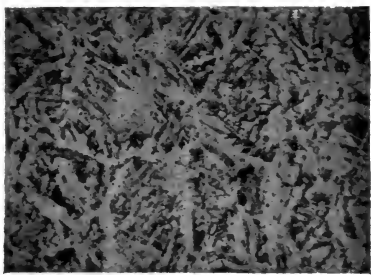

NO. 59. STRUCTURE AT EDGE OF TREAD.



NO. 60. SLAG AT CENTER OF TREAD.

MICROPHOTOGRAPHS OF SHELLED-OUT WHEEL E. 50 DIAMETERS.



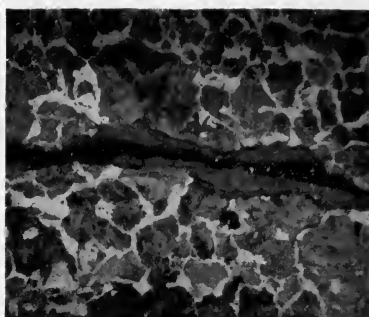

NO. 61. SLAG  $\frac{3}{8}$  IN. BELOW SHELLLED-OUT SPOT

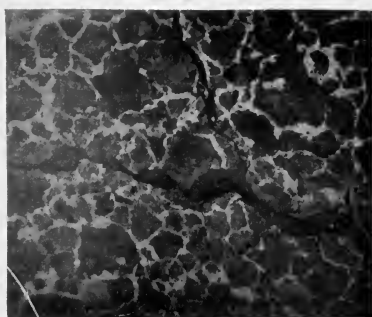

NO. 62. SLAG  $\frac{1}{4}$  IN. BELOW SHELLLED OUT SPOT

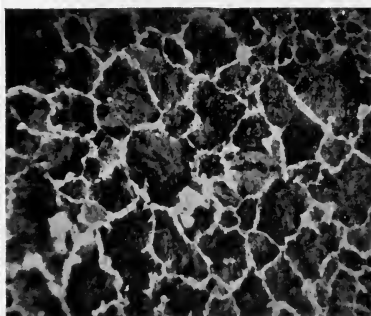

NO. 63. STRUCTURE  $\frac{1}{8}$  IN. BELOW TREAD.

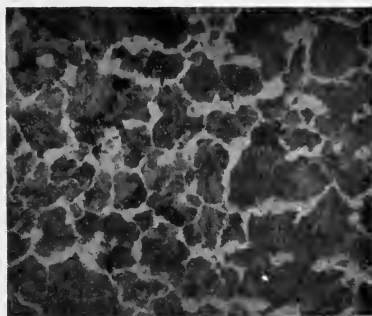

NO. 64. STRUCTURE  $\frac{1}{2}$  IN. BELOW TREAD.

MICROPHOTOGRAPHS OF SHELLLED-OUT WHEEL F. 50 DIAMETERS.



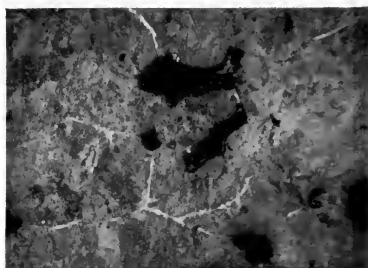

No. 65.

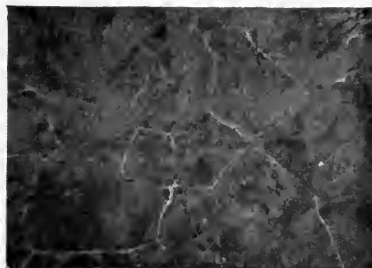

No. 66.

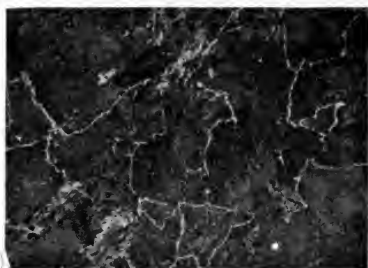

No. 67.

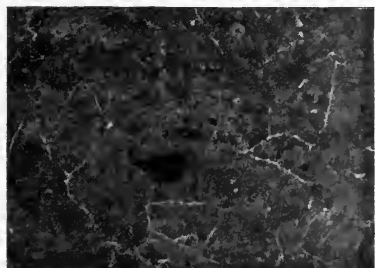

No. 68.

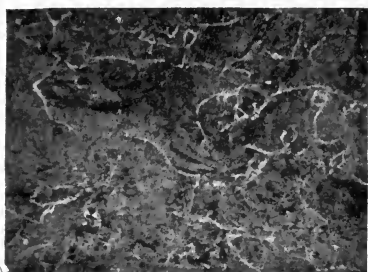

No. 69.



No. 70.

MICROPHOTOGRAPHS OF BURNED METAL OF SCHOEN STEEL WHEEL.  
50 DIAMETERS.





BURNED METAL OF SCHOEN STEEL WHEEL





## SOME AREAS OF CONTACT BETWEEN WHEELS OF VARIOUS DIAMETERS UNDER LOADS AND THE RAIL.

THE mutual compression between the wheel and the rail when under a load has an important bearing on the durability of both and also on the adhesion of the wheels when used as drivers. The investigation was made with various types of cars and locomotives to determine: the area of contact between the wheel and the rail; the average pressure exerted per square inch over this area; the accumulated pressure at the center of this area; the yield of the metal in both the rail and the wheel under the imposed load; the relative action of the wheel and the rail under load; the comparative action of wheels of different diameters, and the comparative action of steel and cast iron wheels.

Through the courtesy of Mr. J. F. Deems, General S. M. P. of the New York Central Lines, the preliminary work involving the use of cars and locomotives was done at the West Albany yards of the New York Central & Hudson River R.R. A concrete pier was built under one of the rails of a level piece of track to secure a firm foundation. A section about 10 in. long was cut out of the rail and a short piece with perfect contour was inserted on top of the pier. The car or locomotive under which a wheel was to be examined was run over this short section of rail and one wheel allowed to rest upon it. The wheel was then raised with its mate so that the section could be

removed and the top smeared with a thin coating of red lead. The piece of rail was then replaced and the wheel lowered upon it with its whole load. This made a spot on the red lead the size of the area of contact of the wheel and the rail. The wheel was again raised, the section of the rail removed, and the area of contact, as indicated by the spot on the red lead, transferred to tracing cloth. The rail was again smeared and replaced, and the wheel was turned through one quarter of a revolution and the work repeated.

In the supplementary work in the laboratory a section of a 78-in. tire, a section of a steel wheel and a section of a cast iron wheel were used. One of these sections was fastened to the plunger of the testing machine and was raised and lowered on the heads of short sections of rails resting on the platen of the same. The size and shape of the contact area was obtained by the interposition between the tire and rail section of a piece of white tissue paper resting on a sheet of carbon paper which made the imprint on the white paper.

The tests at West Albany were made with three cars and two locomotives. In all 32 contacts were obtained, and plaster of Paris casts were taken of the treads of the wheels at all points at which the contact areas were obtained. Some of the wheels were new, while others were partly worn, a condition that evidently had much to do with the shape and size of the spot.

These areas were carefully measured with a planimeter and gave the following average results:

Wheels Used Under.	Total Weight on Wheels in Lbs.	Average of Area Contact.	Average Weight per Sq. In. of Area in Lbs.
Café Car (35 in.) . . . .	6,075	.2325	28,700
Gondola (33 in.) . . . .	14,575	.3775	40,100
Consolidation Driver (63 in.)	17,325	.3350	52,080
Atlantic Driver (78 in.) . . .	19,995	.6325	31,820
Atlantic Trailer (48 $\frac{5}{16}$ in.) . .	19,210	.4725	44,400
Dining Car (34 $\frac{1}{2}$ in.) . . . .	9,415	.2600	37,870

In these tests the influence of weight and diameter is partially illustrated. The two wheels of the Atlantic engine, for example, carry about the same weight. The areas of contact are nearly in an inverse ratio to the diameters. Comparing the wheels of the café and dining cars, the wheel with the heavier load has much the greater weight per sq. in. of area, showing that the metal does not yield in direct proportion to the weight, at least within the limits of the loads here imposed.

In the laboratory the first series of tests made was to apply pressures, increasing by small increments, to the tread of a 36-in. steel wheel resting on an 80-lb. rail. The lowest load applied was 500 lbs. This was increased by increments of 500 lbs. up to



CONTACTS OF 35-IN. STEEL-TIRED WHEEL UNDER CAFÉ CAR.  
WEIGHT ON WHEEL, 6,075 LBS.



CONTACTS OF 33-INCH WORN CAST IRON WHEEL UNDER GONDOLA CAR.  
WEIGHT ON WHEEL, 14,575 LBS.



CONTACTS OF 78-IN. STEEL-TIRED DRIVING WHEEL, ATLANTIC  
LOCOMOTIVE. WEIGHT ON WHEEL, 19,995 LBS.

20,000 lbs.; then by increments of 1,000 lbs. up to 30,000 lbs.

The second series was made with the same wheel resting on a 100-lb. rail, starting at a load of 500 lbs. and increasing by increments of 500 lbs. up to 2,000 lbs; then by increments of 1,000 lbs. up to 10,000 lbs.; then by increments of 2,000 lbs. up to 30,000 lbs.

The third series was made with a 78-in. tire on an 80-lb. rail, starting at 500 lbs. and then increasing by increments of 500 lbs. to 2,000 lbs.; then by



CONTACTS OF  $48\frac{5}{16}$ -IN. STEEL-TIRED TRAILER TRUCK WHEEL, ATLANTIC LOCOMOTIVE. WEIGHT ON WHEEL, 19,210 LBS.

increments of 1,000 lbs. to 8,000 lbs.; then by 2,000 lbs. to 30,000 lbs. and from that point by increments of 2,500 lbs. to 40,000 lbs.

The fourth series was made with the 78-in. tire on a 100-lb. rail, starting at 500 lbs. and increasing by increments of 500 lbs. to 2,000 lbs.; then by 1,000 lbs. to 8,000 lbs.; then by 2,000 lbs. to 30,000 lbs., and finally by 2,500 lbs. to 35,000 lbs.

The fifth series was made with the section of a cast iron wheel 33 ins. in diameter. This was tested on a 100-lb. rail only, starting at 500 lbs.; increasing by 500 lbs. increments to 20,000 lbs.; then by 1,000 lbs. to 30,000 lbs.; then by 2,500 lbs. to 40,000 lbs.; then by 5,000 lbs. to 150,000 lbs.

The sixth series was made with a 36-in. steel wheel on a 100-lb. rail, and started at a load of 50,000 lbs. which was increased by increments of 10,000 lbs. to 150,000 lbs.

The results obtained from these tests have been plotted on the accompanying diagram and average lines drawn which show the accumulated pressure per sq. in. of area under the actual loads imposed, the lines being an average of the results obtained. It will be seen, on comparing the lines of the 36-in. steel wheel and of the 33-in. cast iron wheel, that there is comparatively little difference up to a load



500 Lbs.  
Av. Pressure per  
Sq. In. 7 143 Lbs.  
Area .07 Sq. In.



5,000 Lbs.  
Av. Pressure per  
Sq. In. 62,500 Lbs.  
Area .08 Sq. In.



10,000 Lbs.  
Av. Pressure per  
Sq. In. 100,000 Lbs.  
Area .10 Sq. In.



15,000 Lbs.  
Av. Pressure per  
Sq. In. 100,000 Lbs.  
Area .15 Sq. In.



20,000 Lbs.  
Av. Pressure per  
Sq. In. 86,956 Lbs.  
Area .23 Sq. In.



25,000 Lbs.  
Av. Pressure per  
Sq. In. 92,555 Lbs.  
Area .27 Sq. In.



30,000 Lbs.  
Av. Pressure per  
Sq. In. 96,774 Lbs.  
Area .31 Sq. In.

CONTACTS BETWEEN 36-IN. STEEL-TIRED WHEEL AND 80-LB. RAIL.



500 Lbs.  
Av. Pressure per  
Sq. In. 16,666 Lbs.  
Area .03 Sq. In.



5,000 Lbs.  
Av. Pressure per  
Sq. In. 62,500 Lbs.  
Area .08 Sq. In.

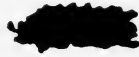

10,000 Lbs.  
Av. Pressure per  
Sq. In. 71,428 Lbs.  
Area .14 Sq. In.

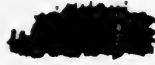

16,000 Lbs.  
Av. Pressure per  
Sq. In. 94,117 Lbs.  
Area .17 Sq. In.



20,000 Lbs.  
Av. Pressure per  
Sq. In. 105,263 Lbs.  
Area .19 Sq. In.



26,000 Lbs.  
Av. Pressure per  
Sq. In. 108,333 Lbs.  
Area .24 Sq. In.



30,000 Lbs.  
Av. Pressure per  
Sq. In. 115,384 Lbs.  
Area .26 Sq. In.

CONTACTS BETWEEN 36-IN. STEEL-TIRED WHEEL AND 100-LB. RAIL.

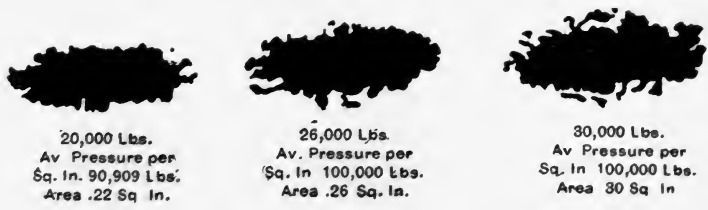
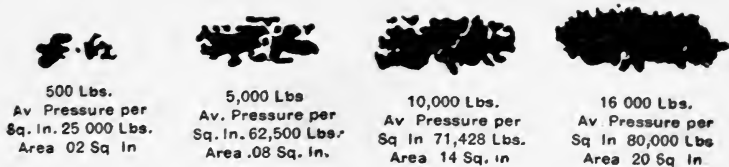

CONTACTS BETWEEN 78-IN. STEEL-TIRED WHEEL AND 80-LB. RAIL.

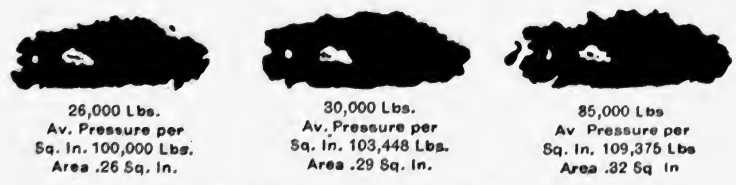
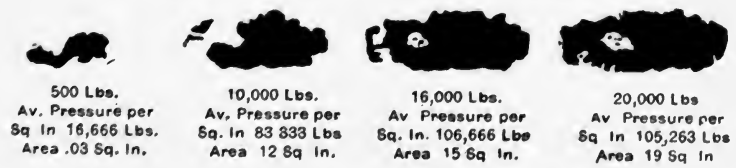

CONTACTS BETWEEN 78-IN. STEEL-TIRED WHEEL AND 100-LB. RAIL.



50,000 Lbs.  
Av. Pressure per  
Sq. In. 131,578 Lbs.  
Area .38 Sq. In.



60,000 Lbs.  
Av. Pressure per  
Sq. In. 127,659 Lbs.  
Area .47 Sq. In.



70,000 Lbs.  
Av. Pressure per  
Sq. In. 129,629 Lbs.  
Area .54 Sq. In.



80,000 Lbs.  
Av. Pressure per  
Sq. In. 137,288 Lbs.  
Area .59 Sq. In.



90,000 Lbs.  
Av. Pressure per  
Sq. In. 135,757 Lbs.  
Area .66 Sq. In.



100,000 Lbs.  
Av. Pressure per  
Sq. In. 138,888 Lbs.  
Area .72 Sq. In.



110,000 Lbs.  
Av. Pressure per  
Sq. In. 137,500 Lbs.  
Area .80 Sq. In.



120,000 Lbs.  
Av. Pressure per  
Sq. In. 141,176 Lbs.  
Area .85 Sq. In.

CONTACTS BETWEEN 36-IN. STEEL WHEEL AND 100-LB. RAIL.

of 22,500 lbs., after which the load per sq. in. increases more rapidly with the cast iron wheel than with the steel wheel. At a load of 37,500 lbs. there is a marked breaking down of the metal in the cast iron





130,000 Lbs.  
Av. Pressure per  
Sq. In. 141,304 Lbs  
Area .92 Sq. In.



140,000 Lbs.  
Av. Pressure per  
Sq. In. 137,254 Lbs.  
Area 1.02 Sq. In.



150,000 Lbs.  
Av. Pressure per  
Sq. In. 144,230 Lbs.  
Area 1.04 Sq. In.

CONTACTS BETWEEN 36-IN. STEEL WHEEL AND 100-LB. RAIL.

wheel showing that the crushing strength has been exceeded.

A tentative explanation of this phenomenon is that the hard chilled cast iron wheel is practically unyielding and that, when the load is imposed, the whole of the compression takes place in the rail. The area of contact is small and the average pressure per sq. in. of area is high. The yield in the rail holds, for a time, against the increasing load, thus cutting down the size of the area between 22,500 lbs. and 40,000 lbs. The wheel itself then takes a permanent set, increasing the area of contact very rapidly and lowering the average. In the case of the steel wheel, yielding takes place in both the wheel and the rail,

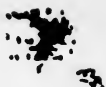

500 Lbs.  
Av. Pressure per  
Sq. In. 9,090 Lbs.  
Area .055 Sq. In.



1,000 Lbs.  
Av. Pressure per  
Sq. In. 14,285 Lbs.  
Area .07 Sq. In.



2,500 Lbs.  
Av. Pressure per  
Sq. In. 33,333 Lbs.  
Area .075 Sq. In.



3,500 Lbs.  
Av. Pressure per  
Sq. In. 43,750 Lbs.  
Area .08 Sq. In.



4,500 Lbs.  
Av. Pressure per  
Sq. In. 50,000 Lbs.  
Area .09 Sq. In.



6,000 Lbs.  
Av. Pressure per  
Sq. In. 54,545 Lbs.  
Area .11 Sq. In.



10,000 Lbs.  
Av. Pressure per  
Sq. In. 83,333 Lbs.  
Area .12 Sq. In.



11,500 Lbs.  
Av. Pressure per  
Sq. In. 88,461 Lbs.  
Area .13 Sq. In.



13,500 Lbs.  
Av. Pressure per  
Sq. In. 96,428 Lbs.  
Area .14 Sq. In.



14,500 Lbs.  
Av. Pressure per  
Sq. In. 96,666 Lbs.  
Area .15 Sq. In.



15,000 Lbs.  
Av. Pressure per  
Sq. In. 93,750 Lbs.  
Area .16 Sq. In.



16,500 Lbs.  
Av. Pressure per  
Sq. In. 97,058 Lbs.  
Area .17 Sq. In.



17,500 Lbs.  
Av. Pressure per  
Sq. In. 94,444 Lbs.  
Area .18 Sq. In.



19,000 Lbs.  
Av. Pressure per  
Sq. In. 100,000 Lbs.  
Area .19 Sq. In.



25,000 Lbs.  
Av. Pressure per  
Sq. In. 125,000 Lbs.  
Area .20 Sq. In.



27,000 Lbs.  
Av. Pressure per  
Sq. In. 128,571 Lbs.  
Area .21 Sq. In.



28,000 Lbs.  
Av. Pressure per  
Sq. In. 127,272 Lbs.  
Area .22 Sq. In.



30,000 Lbs.  
Av. Pressure per  
Sq. In. 130,434 Lbs.  
Area .23 Sq. In.



32,500 Lbs.  
Av. Pressure per  
Sq. In. 130,000 Lbs.  
Area .25 Sq. In.



35,000 Lbs.  
Av. Pressure per  
Sq. In. 134,615 Lbs.  
Area .26 Sq. In.

CONTACTS BETWEEN 33-IN. CAST IRON WHEEL AND 100-LB. RAIL.

with the result that an equilibrium is established on a smaller area and the actual breaking down of the metal occurs under a higher pressure.

In the case of the cast iron wheel it will be noted that the curve of average pressure shows a break and yield of the material at a load of 27,000 lbs., though it rises again and makes a second complete break at 37,500 lbs., from which there is no recovery. In the case of the steel wheel the breakdown does not occur until a load of 50,000 lbs. is reached, and even then there is a gradual and practically uniform advance to 150,000 lbs.

In the tests of both the cast iron wheel and the steel wheel, the permanent set was all in the rail. Both wheels were carefully examined with a microscope after the load of 150,000 lbs. had been imposed and the tests were completed, and no appearance of yielding or cracking of either could be detected. The rail, on the other hand, showed signs of a permanent set under a load of 20,000 lbs., and this set increased with the increasing loads. The rail was examined immediately after applying loads of 12,000, 15,000, 25,000, 30,000, 35,000, and 40,000 lbs. The spot or depression left by the wheel could be seen after the 20,000 lbs. load had been imposed, but not before.

The difference between the areas of contact of the wheels under cars and locomotives and the wheels tested in the laboratory, in which the area was larger, is probably due to the fact that the wheels under the cars and locomotives were worn somewhat hollow and so fitted the rail head to a greater extent. In service, however, the swinging of the wheels from



37,500 Lbs.  
Av. Pressure per  
Sq. In. 138,888 Lbs.  
Area .27 Sq. In.



40,000 Lbs.  
Av. Pressure per  
Sq. In. 137,777 Lbs.  
Area .29 Sq. In.



45,000 Lbs.  
Av. Pressure per  
Sq. In. 136,363 Lbs.  
Area .33 Sq. In.



50,000 Lbs.  
Av. Pressure per  
Sq. In. 121,951 Lbs.  
Area .41 Sq. In.



55,000 Lbs.  
Av. Pressure per  
Sq. In. 119,565 Lbs.  
Area .46 Sq. In.



59,000 Lbs.  
Av. Pressure per  
Sq. In. 118,000 Lbs.  
Area .50 Sq. In.



65,000 Lbs.  
Av. Pressure per  
Sq. In. 118,181 Lbs.  
Area .55 Sq. In.



70,000 Lbs.  
Av. Pressure per  
Sq. In. 118,644 Lbs.  
Area .59 Sq. In.



75,000 Lbs.  
Av. Pressure per  
Sq. In. 122,950 Lbs.  
Area .61 Sq. In.

CONTACTS BETWEEN 33-IN. CAST IRON WHEEL AND 100-LB. RAIL.



80,000 Lbs.  
Av. Pressure per  
Sq. In. 126,983 Lbs.  
Area .63 Sq. In.



85,000 Lbs.  
Av. Pressure per  
Sq. In. 116,666 Lbs.  
Area .72 Sq. In.



90,000 Lbs.  
Av. Pressure per  
Sq. In. 121,621 Lbs.  
Area .74 Sq. In.



95,000 Lbs.  
Av. Pressure per  
Sq. In. 121,794 Lbs.  
Area .78 Sq. In.



100,000 Lbs.  
Av. Pressure per  
Sq. In. 120,481 Lbs.  
Area .83 Sq. In.



105,000 Lbs.  
Av. Pressure per  
Sq. In. 117,977 Lbs.  
Area .89 Sq. In.



110,000 Lbs.  
Av. Pressure per  
Sq. In. 118,279 Lbs.  
Area .93 Sq. In.



115,000 Lbs.  
Av. Pressure per  
Sq. In. 116,161 Lbs.  
Area .99 Sq. In.



120,000 Lbs.  
Av. Pressure per  
Sq. In. 115,384 Lbs.  
Area 1.04 Sq. In.

CONTACTS BETWEEN 33-IN. CAST IRON WHEEL AND 100-LB. RAIL.



125,000 Lbs.  
Av. Pressure per  
Sq. In. 119,047 Lbs.  
Area 1.05 Sq. In.



130,000 Lbs.  
Av. Pressure per  
Sq. In. 117,117 Lbs.  
Area 1.11 Sq. In.



135,000 Lbs.  
Av. Pressure per  
Sq. In. 119,469 Lbs.  
Area 1.13 Sq. In.



140,000 Lbs.  
Av. Pressure per  
Sq. In. 130,434 Lbs.  
Area 1.15 Sq. In.

CONTACTS BETWEEN 33-IN. CAST IRON WHEEL AND 100-LB. RAIL.

one side of the track to the other brings the projections on the outer edge of the rim against the rail, undoubtedly causing a much higher load to be put on a smaller area of contact than was applied in the laboratory.

The permanent set taken by the rail at so low a load as 20,000 lbs. raised the question of the

maximum pressure imposed at the center of the area of contact. It was assumed that when the wheel first touched the rail the area of contact would be a mathematical point if both surfaces were perfectly smooth and true. As the load is increased the metal in both the wheel and rail yields and the area of contact increases. This increase is from the center out to the edge, and the pressure per unit of area is evidently at a maximum at the center and decreases to nothing at the edge. In order to estimate approximately the maximum pressure it was assumed that the metal in the area on which a load had once been imposed always sustained it, and by building up from the center by increments the final load was attained. Take the case of the 36-in. steel-tired wheel on the 100-lb. rail. An area of .03 sq. in. sustained the initial load of 500 lbs., with an average pressure of 16,666 lbs. per sq. in. By increasing this load to 5,000 lbs. the area is increased to .08 sq. in. If this extra 4,500 lbs. which was applied be considered as loaded uniformly over the whole area, there would be an average increase of pressure of 56,250 lbs. per sq. in. or  $56,250 + 16,666 = 72,916$  lbs. per sq. in. on the original .03 sq. in. which carried the initial load of 500 lbs. This assumption runs the load up to an exceedingly high limit, possibly too high, as it gives a pressure of more than 170,000 lbs. per sq. in. at the center of the area of contact, with a load of 20,000 lbs.

In considering the results obtained in this investigation, it must be borne in mind that the areas of contact were all obtained under static loads. Running conditions must necessarily be more severe and impose higher stresses. In an investigation



145,000 Lbs.  
Av. Pressure per  
Sq. In. 123,931 Lbs.  
Area 1.17 Sq. In.



150,000 Lbs.  
Av. Pressure per  
Sq. In. 124,049 Lbs.  
Area 1.21 Sq. In.

CONTACTS BETWEEN 33-IN. CAST IRON WHEEL AND 100-LB. RAIL.

conducted several years ago it was found that the stresses in truck and body bolsters, while a car is in motion, are from 20 to 50 per cent. more than the stresses due to static loads alone. If this is true for parts located above the springs, there must certainly be an equal or greater increase at the point of contact between the wheel and the rail. Then, too, the blows received from passing over low joints or worn frogs, will raise the pressure between the wheel and the rail to a point which the tests under static loads have shown to be excessive. For example, the wheels, under a car of 100,000 lbs. capacity with a 10 per cent. overload, carry an approximate static load of 18,750 lbs. each. A drop of  $\frac{1}{16}$  in. is equivalent to a blow of about 97 foot lbs. If the drop is checked by a yield in the rail of three-eighths of the amount of the drop ( $\frac{3}{128}$  in.) the pressure on the rail will amount to 50,000 lbs. This is certainly excessive.

Comparing the steel and cast iron wheels, it appears that no damage was done to either wheel under



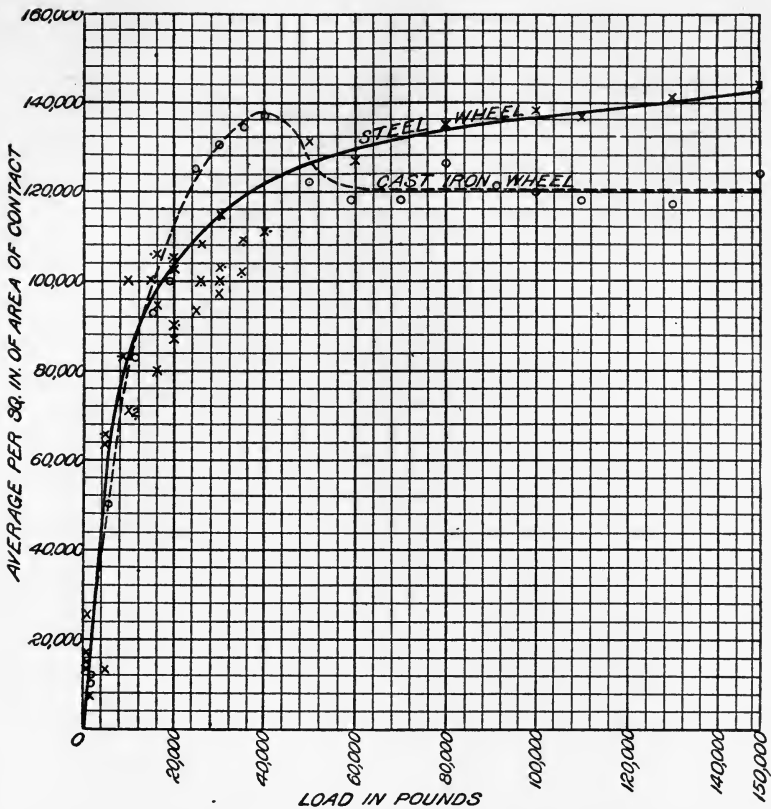

DIAGRAM SHOWING THE RELATION BETWEEN WEIGHTS ON WHEELS, AND THAT ON THE AREA OF CONTACT BETWEEN THE WHEEL AND THE RAIL.

a static load of 150,000 lbs. If the two wheels are subjected to the pounding action of service, however, the result cannot fail to be the earlier disintegration of the harder, more unyielding and more brittle material. Exact comparative data along this line are not yet available.

The conclusions to be drawn from this part of the work may be summed up as follows:

The average pressure imposed on the metal of the wheel and rail is within safe limits at low loads, but when a load of 20,000 lbs. is reached the elastic limit of the metal is passed and a permanent set appears in the rail.

The accumulated pressure at the center of the area of contact is excessive at comparatively small loads, and is only prevented from doing injury by the support of the surrounding metal. How far this compression extends into the body of the two pieces of metal in contact is not known, but presumably it extends down to the base of the rail and into the hub of the wheel.

Under a static load the rail yields first, owing, probably, to the fact that the metal of the surface of the head of the rail is not as well supported by the metal below as in the case of the wheel.

The effect of difference of diameter in wheels carrying the same load is insignificant and is only appreciable when the difference is great. Hence it is immaterial so far as stresses on the wheel or rail are concerned, whether small or large wheels, within the limits of practice, are used.

A hard, unyielding cast iron wheel inflicts more damage on the rail than a steel wheel, and the wear of the rail will be greater with the cast iron wheels than with the steel wheels.

It is probable that the reason why the damage that would be expected from heavy wheel loads in service does not immediately appear, is that the rail, by bending under the passing wheel, increases the area of contact and thus relieves the surface stresses.

## Coefficients of Friction Between Wheels and Rails. Tractive Values. Skidding and Slipping.

THE resistance of a wheel to slipping on the rail depends upon two causes frequently confused, but which are to be considered separately. These are friction and abrasion.

Frictional resistance is due to the roughnesses of the two surfaces in contact, and may be compared to the lifting of the weight to be moved over the successive inequalities of the surface on which it rests. Abrasion, on the other hand, involves the removal or cutting away of the particles of the masses in contact. The slipping of a wheel, such as would produce a flat spot, involves both frictional resistance and abrasion. If there was no slipping of the wheel on the rail there would be no wear, provided the rolling action did not produce sufficient pressure on any one point to crush the metal or cause it to flow. But there is always more or less slip even on a straight line.

There are two kinds of slipping to which car wheels may be subjected. One is the skidding action due to the locking of the wheels by the brake-shoes. The other form occurs when the driving wheels of electric motor cars, for instance, are turned faster than the corresponding rate of motion of the car and the whole periphery of the wheel slides over the rail. In order to determine whether the resistances to these two kinds of slipping were the same certain experiments were made.

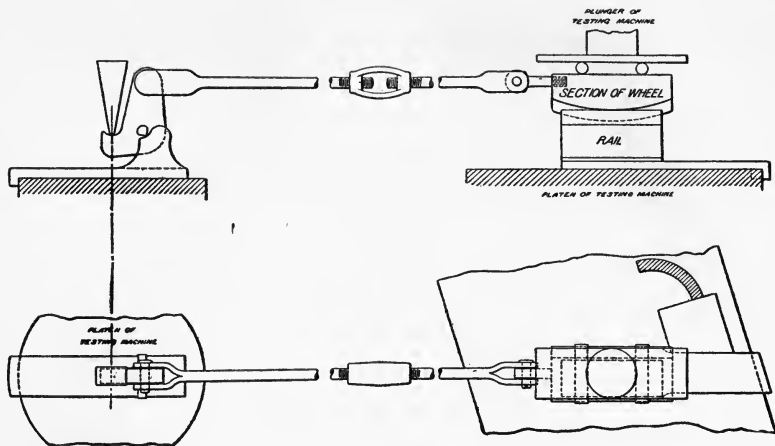

ARRANGEMENT OF APPARATUS TO TEST THE FRICTIONAL RESISTANCE OF CAR WHEELS TO SKIDDING.

The apparatus was designed to produce, as nearly as possible, the actual conditions of track work.

Two pieces of steel rails of 75 lbs. section, one of which had been worn smooth in service, the other a piece of new rail, together with a section of a steel wheel and a section of a cast iron wheel, with the treads of both smooth and free from imperfections, were used for the tests. The testing machines were made by Tinius Olsen & Co., one with a capacity of 100,000 lbs. and the other a capacity of 50,000 lbs.

The apparatus is shown in the accompanying illustrations for the skidding movement. The wheel section was set on the rail and loaded by the 100,000 lbs. capacity machine. It was then slipped over the rail by a pull on the connection rod reaching to the other machine which measured the amount of the pull required to slip the wheel on the rail.

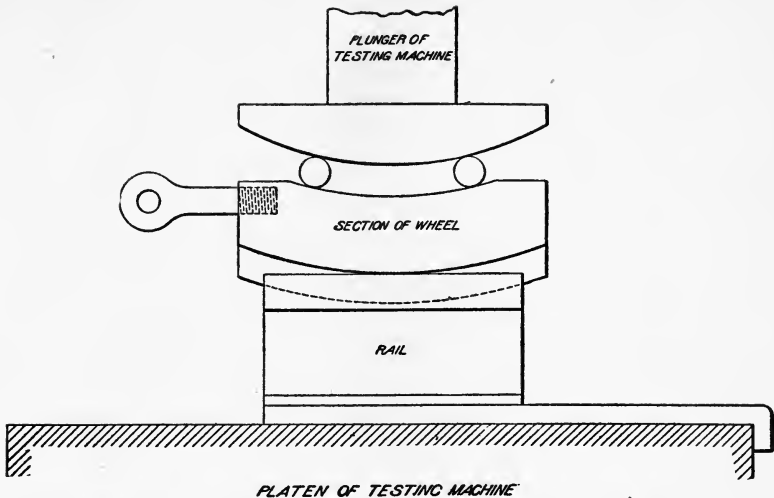

ARRANGEMENT OF APPARATUS FOR TESTING THE FRICTIONAL RESISTANCE OF CAR WHEELS TO SPINNING.

In loading the wheel, the pressure was applied through a plate resting on two rollers. In this way the friction, except that between the wheel and the rail, was reduced to practically nothing.

For the spinning motion, the bearing plate above the rollers was made convex and the bottom plate resting on the top of the wheel was made concave, both surfaces being concentric with the tread of the wheel. A pull on the wheel, therefore, caused it to roll under the bearing plate as though it were revolving on its own center. The arrangement of this is clearly shown in the diagram.

The force required to move the wheel on the rail was weighed by a bell crank with a knife-edge bearing, resting on a heavy casting attached to the bed

plate of the small testing machine. The vertical arm was attached to the pull rod and the end of the horizontal arm had a bearing on a wedge or knife edge that was forced down by the platen of the machine.

The wheel section was placed in position on the rail and weighted with a predetermined load. Pressure was then applied to the wedge on the small machine. This pressure was transferred through the bell crank as a pull on the connecting rod. When slipping occurred, the event was marked instantly by the drop of the beam of the small machine. The movement of the wheel over the rail usually amounted to about  $\frac{1}{32}$  in. As the object of the investigation was to determine the friction at rest no attempt was made to measure the pull after the first slip occurred. This was markedly less than that required to start the movement from a state of rest.

Separate tests were made with steel and cast iron wheels on the old and new rails, for both the skidding and spinning motions. In loading the wheels, the weights were increased by regular increments of 2,000 lbs. up to 30,000 lbs. Three tests were made with each loading and for each condition of wheel movement. The average of the three tests in each case is given in the accompanying table.

There was so little difference in the pull required to slip the wheels on the old and new rails that an average of the results obtained is given as the resistance to spinning and skidding of the two wheels on a steel rail.

The table shows that the resistance to spinning of the steel wheel is somewhat greater than that of the

COEFFICIENTS OF FRICTION BETWEEN WHEELS  
AND RAILS.

Load on Wheel in Lbs.	Kind of Motion			
	Spinning		Skidding	
	Steel Wheel.	Cast Iron Wheel.	Steel Wheel.	Cast Iron Wheel.
2,000	.259	.243	.285	.287
4,000	.240	.215	.254	.259
6,000	.234	.208	.245	.254
8,000	.228	.206	.246	.242
10,000	.215	.204	.238	.233
12,000	.212	.205	.237	.223
14,000	.207	.199	.233	.226
16,000	.204	.196	.232	.219
18,000	.204	.198	.231	.219
20,000	.201	.194	.236	.220
22,000	.205	.191	.238	.223
24,000	.204	.192	.235	.224
26,000	.205	.189	.232	.223
28,000	.203	.186	.236	.217
30,000	.203	.183	.234	.214

cast iron wheel, a fact which is brought out more forcibly in the table of coefficients of friction, in which the coefficient of the steel wheel is invariably higher than that of the cast iron.

It also appears from this table that the coefficient of friction of the steel wheel decreases as the load is increased, up to a pressure of about 15,000 lbs., after which it is practically constant. The coefficient of friction of the cast iron wheel decreases rather rapidly, like that of the steel wheel, up to a load of 15,000 lbs., after which it falls away slowly, though a tendency to decrease with the increase of load is manifest.

As regards skidding, the values of the coefficients of the two wheels bear the same relation to each other

as they do for spinning. The coefficient of resistance is greater for the steel wheel than for the cast iron wheel, and there is the same falling off in the value of the coefficient as the load is increased up to about 15,000 lbs., after which that of the steel wheel is nearly constant, while that of the cast iron wheel continues to fall away slowly. It would be difficult to explain these phenomena without the data obtained in the investigations previously described, made to determine the area of contact between the wheel and the rail, and the relative rate of abrasion of the steel and cast iron wheels on the emery wheel. The results of those investigations also serve to explain why the coefficient for a skidding wheel is higher than the coefficient for a wheel that is spinning.

In the case of the cast iron wheel, it was shown in the preceding chapter that the imposition of a heavy load caused a breaking down of the metal in the rail at a certain point, while no such failure occurred with the steel wheel under the same load. The cast iron wheel being rigid, inelastic and incompressible on the tread, was forced down into the metal of the rail, causing the rail to do all of the yielding needed to produce the area of contact obtained, with the result that it was soon compressed beyond its elastic limit and given a permanent set. The steel wheel yielded as well as the rail, thus relieving the rail of a part of its compression and increasing the area of contact. This behavior of the two wheels explains in part the results obtained in these tests. In addition, it must be remembered that the normal coefficient of friction is greater between steel and steel than it is between cast iron and steel.



When the cast iron wheel is loaded on the rail it indents the rail, in proportion to the pressure applied, without being distorted itself. If, then, it is turned, as by a motor, it simply revolves in the concave depression in the rail, without undergoing any deformation itself and with no resistance other than that of overcoming the friction between the surfaces of the wheel and rail. The steel wheel, on the other hand, is itself compressed as well as the rail, so that when it is turned a continuous progressive compression of the tread is set up, equal to the amount of the original compression. Hence, the resistance to turning will be equal to the frictional resistance plus that set up by this compression.

It was shown that the cast iron wheel was cut away much more rapidly under the emery wheel than were the steel tires and wheels. In the tests for skidding, the loads were successively applied without readjusting the wheel on the rail, with the result that the steel wheel was skidded about  $1\frac{1}{4}$  in. and the cast iron wheel about 1 in. This was done under loads increasing from 2,000 lbs. up to 30,000 lbs. Under this treatment the steel wheel developed a slid-flat spot about  $\frac{9}{16}$  in. long, and the cast iron wheel a spot about  $\frac{7}{8}$  in. long. In both cases the rail was spotted and the metal was rolled up in folds, indicating the direction of the motion of the wheel. The piece of rail used with the steel wheel was spotted for a distance of about  $1\frac{3}{4}$  in., while the piece used with the cast iron wheel was spotted for a length of about  $1\frac{1}{2}$  in. This abrasion of the cast iron wheel probably accounts for the lower resistance to skidding as compared with

UNIV. OF  
CALIFORNIA

the steel wheel. For the same weight and for the same distance of skidding, the amount of metal abraded from the cast iron wheel was in almost exactly the same ratio to that removed from the steel wheel, as is shown in the diagram of abrasion tests.

It will be remembered that, for the lower wheel loads, the investigation of contact areas showed that there was comparatively little difference between the areas obtained with cast iron wheels and with steel wheels, and that it was inferred that the total compression of the metal was approximately the same in both cases. Under these circumstances it would be expected that, if the power required to distort the metal of a steel rail and tire were the same, the resistance to skidding of the steel wheel and the cast iron wheel would also be the same. But, owing to the more rapid abrasion of the cast iron wheel, as soon as it begins to skid it wears, and by thus increasing the area of contact it lessens the depression of the rail, decreases the amount of metal to be distorted, lowers the resistance to the motion, and makes the coefficient of friction of skidding less on the cast iron wheel than on the steel wheel.

This depression of the rail due to the imposition of the wheel load accounts for the higher coefficient of friction obtained with a skidding wheel than with a spinning wheel. With a wheel spinning there is no continuous deformation of the metal of the rail to be effected. In skidding there is a depression of the rail to be carried forward like a wave, which naturally raises the resistance and makes the coefficient greater than where slipping over one spot alone takes place.

TO THE  
LIBRARY OF THE  
BOSTON PUBLIC LIBRARY

While it is not safe to draw rigid conclusions from the limited amount of data obtained, it does appear that inasmuch as the steel wheel offers greater resistance to spinning it is better adapted for use as the driving wheel of an electric car than the cast iron wheel; and further, its higher coefficient of friction renders it less liable to skidding.

This matter of wheels skidding, with the consequent development of flat spots on the tread, was considered of enough importance to warrant further investigation.

It has been noted by many other investigators that steel wheels do not flatten as readily as cast iron wheels. By some this is attributed to the fact that small flat spots once formed on the tread of a steel wheel may be rolled out, whereas they have a tendency to grow larger on cast iron wheels. The abrasion and skidding tests which have been made seem to show, however, that it is the lower resistance to grinding of the cast iron wheel that accounts for the more rapid development of these flat spots.

To briefly recapitulate, these tests showed that the rate of grinding of the first  $\frac{1}{8}$  in. below the tread was about 4.64 times as fast in the cast iron wheel as in the Schoen steel wheel. For the second  $\frac{1}{8}$  in. the ratio became 6.37 and for the third  $\frac{1}{8}$  in. 15.93, showing the rapid decrease of wearing resistance of the cast iron wheel below the surface. In the skidding tests in the laboratory the effects were confined to the metal close to the surface, and it was found that, with the same amount of skidding, the amount of metal removed was about 5.12 times as great on the cast iron wheel as on the steel wheel.

A further check on these figures was afterwards obtained by taking the time required to remove approximately the same amount of material from the treads of cast iron and steel wheels in a wheel grinding machine. It was found that it took from four to five times as long to grind down the steel wheels as it did to grind the cast iron wheels. In all of the foregoing investigations the metal of the wheel under test was kept cool, either by a stream of water or by doing the work so slowly that natural radiation counteracted the tendency to heat, and the temperature of the metal was not raised above 100 deg. Fahr.

For the purpose of ascertaining whether the results of these investigations were comparable with the results obtained in actual railroad service, when the wheels were locked and skidded under a car, series of tests were made by skidding the wheels under a loaded car.

Through the courtesy of the New York, Ontario & Western Railroad a piece of track and a suitable box car were supplied for the tests. One pair of wheels and axle were removed from under the car, and replaced by an axle on which a Schoen steel wheel and a new cast iron wheel had been pressed. These wheels were  $33\frac{1}{4}$  in. and 33 in. in diameter, respectively. This pair of wheels was placed at the end of the car, and was fitted with two brake-beams, so that twice the usual brake-shoe pressure could be applied on the wheels. By this means the wheels could be held in a fixed position throughout a run. But it was more difficult to hold the wheels at low speed than at high speed.

The car was loaded until the weight on the pair of wheels to be tested was exactly 24,000 lbs. The car was then hauled back and forth over a piece of track 1,850 ft. long. The brake was set and the wheels skidded for the whole distance. The car was hauled at two speeds, namely, three and twelve miles an hour.

When the car was hauled at a speed of three miles an hour, flat spots were made on the steel wheel about .30 sq. in. in area, while the spots formed on the cast iron wheel were .80 sq. in. in area. These areas correspond to diameters of about  $\frac{5}{8}$  in. and 1 in. respectively, though the spots on the cast iron wheel were elongated to about  $1\frac{1}{8}$  in., which indicated somewhat more metal removed. The volume of metal abraded from the cast iron wheel was about  $5\frac{3}{4}$  times greater than that from the steel wheel.

While the movement was slow the wheels remained cool. But when the speed was increased to twelve miles an hour heating took place and the cutting was more rapid on the steel wheel.

For the first 1,850 ft. run the areas of the flat spots produced at a speed of 12 miles an hour averaged 8.125 sq. ins. on the steel wheel and 4.445 sq. ins. on the cast iron wheel. The estimated amount of metal worn away was 4.63 times as much with the steel wheel as with the cast iron wheel.

When the skidding was continued the rate of wear increased very rapidly with the cast iron wheel, while there was little increase with the steel wheel. At the end of the run of 3,700 ft. the area of the flat spot on the steel wheel was 8.43 sq. ins., an increase of .305 sq. in., while the area of the spot on the cast iron wheel was 5.72 sq. ins., an increase of 1.275 sq. in.

From this it appears that the cast iron wheel wore away more rapidly than the steel wheel after the hard surface metal had been broken through.

The indications are that in skidding a short distance at low speed a cast iron wheel is more apt to develop a flat spot than is a steel wheel. On the other hand, if the skidding continues for some distance at a high speed, the wheel becomes heated and then the steel wheel is the first to yield, unless the surface chill of the cast iron wheel has already been worn through.

# LATERAL THRUST OF WHEELS AGAINST THE RAILS. BREAK- ING STRESSES OF WHEEL FLANGES.

It is generally admitted that cast iron wheels under high capacity cars are giving unsatisfactory service and, because of their inherent lack of strength, are a source of danger. Prior to 1905 little was known of the strength of these wheels except that they had a shorter life and gave far more trouble from flange breakage under the high capacity cars than they had under cars with a capacity of only 60,000 lbs. In that year Professor Goss made some tests in the laboratory of Purdue University to ascertain the strength of the flanges of cast iron wheels.

Six new wheels and one wheel which had broken in service were tested. The wheel to be tested was

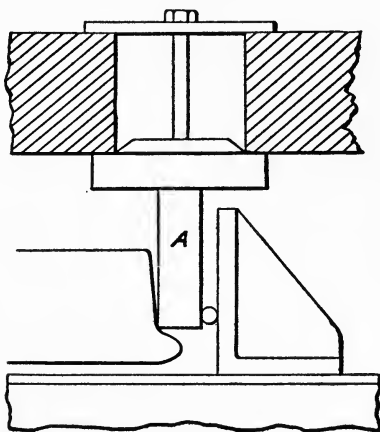

APPARATUS FOR TESTING STRENGTH OF WHEEL FLANGES.

TABLE OF BREAKING STRESSES OF WHEEL FLANGES.

No. of Test	Breaking Load. Lbs.	No. of Wheel.	Point of Application of Load.	Remarks.
1	52,850	M. C. B. 19413	Between brackets	
2	47,750	"	Opposite "	
3	49,350	"	Between "	
4	53,400	"	Opposite "	
5	62,850	M. C. B. 19410	Between "	
6	48,700	"	Opposite "	
7	58,250	"	Between "	
8	58,000	"	Opposite "	
9	74,850	M. C. B. 19254	Between "	
10	72,200	"	Opposite "	
11	87,000	"	Between "	
12	68,550	"	Opposite "	
13	99,300	(e) 650 lbs.	Between "	
14	100,000	"	Opposite "	
15	105,900	"	Between "	
16	68,200	"	Opposite "	
17	79,350	"	" "	Wheel broke through rim.
18	52,300	19558	Between "	
19	111,600	(f) 700 lbs. Tape 1	Opposite "	
	87,000	"	Between "	
20	109,900	"	Opposite "	
21	98,900	(g) { 1904 M. C. B. }	" "	
22		{ 700 lbs. Tape 2 }	" "	
23	98,900	"	" "	

mounted on a strong mandrel secured to the base of the testing machine in such a manner that it could not slip, and a punch was forced down against the flange in the same way that the rail presses against it in service. Pressure was applied until the flange broke. The general arrangement of the apparatus is shown in the illustration on page 107. The punch A was bolted to the head of the machine. It was prevented from springing away from the work by a roller bearing against a bracket which was bolted to the platen of the machine.



AVERAGES OF BREAKING STRESSES OF WHEEL  
FLANGES.

Average Breaking Load. Lbs.	No. of Wheel.	Remarks.
50,837	19,413	Taken from service
56,950	19,410	" " "
75,650	19,254	" " "
52,300	19,558	Broken wheel taken from service.

Three of the wheels tested, Nos. 19,413, 19,410 and 19,254, were new wheels of M. C. B. dimensions. The fourth, No. 19,558, was a piece of a wheel which had broken in service. In addition to these specimens three new wheels were tested which were especially designed to give increased flange strength. These were marked

(e) 650 lbs.

(f) 700 lbs. Tape 1

(g) 700 lbs. " 2

Wheels (e) and (f) were of a reinforced flange design and wheel (g) was the then proposed Standard of the M. C. B. Association with reinforced flange.

Four tests were made with each of the M. C. B. standard wheels, and from two to four tests with each of the others. The results are given in detail in the Table of Breaking Stresses of Wheel Flanges.

Three of the tests made on the (e) wheel showed a flange strength of approximately 100,000 lbs., while the fourth test (16) gave only 68,200 lbs. In view of this wide difference an attempt was made to get a fifth test from this wheel by applying pressure to the flange midway between two of the breaks

previously made, with the result that the wheel broke through the rim at 79,350 lbs.

Test No. 18 was made on a piece of a wheel which had broken in service and the holding device which had been employed for new wheels had to be supplemented by additional clamping for the test. For this reason it is not known whether the results obtained from the fragments are entirely comparable with those obtained from the whole wheels.

It will be seen from these tests that not only were there wide variations in the strength of flanges of wheels of similar design but in different parts of the flange of the same wheel. Reinforcing the flange added to the strength, but even in individual wheels thus reinforced there is a variation from 68,200 lbs. to 105,900 lbs. in the breaking strength.

These tests cover practically all that is known of the strength of the cast iron wheel to resist the thrust on the rail. In order to ascertain approximately the relative strength of the steel wheel under similar conditions a Schoen wheel was tested in the same way. The work was done under a powerful hydraulic press and the flange broke off under a load of 526,612 lbs. This was more than 4.7 times the load required to break the strongest part of the reinforced flange and more than 11 times the load required to break the weakest of the standard flanges.

The ratio of 4.7 to 1 corresponds fairly closely with the ratio of the tensile strength of the two metals. It has been seen that the tensile strength of the steel of the Schoen wheel is about 124,000 lbs. In some tests of cast iron that have been made it was found that samples of gray iron made from



TRACK APPARATUS FOR ASCERTAINING WHEEL AND RAIL PRESSURES.



first-class wheel mixtures broke at from 16,000 lbs. to 17,000 lbs, while test specimens, carefully ground from the white chilled iron of a car wheel, broke under loads as high as 36,000 lbs.

The lack of any data on the stresses to which wheels are subjected in service, other than that based on theoretical calculations, necessitated the carrying out of a series of investigations which would throw some light on the subject from a practical standpoint. The object was to determine the lateral thrust to which the wheels under high capacity freight cars may be subjected when moving over curves at different speeds, and, if possible, to develop the law in accordance with which the thrust increases as the speed of the car is increased.

As an investigation of this kind had never before been undertaken, it was necessary to design and build a special piece of apparatus.

The device as a whole may be divided into two parts: the track apparatus and the recording instrument.

The track apparatus consisted of a section of rail 3 ft. long held in position in the track and free to move outward by an amount sufficient to exert a pressure on a hydraulic cylinder in proportion to the lateral thrust against it.

The recording instrument was set on a small table placed about 7 ft. from the track and was connected with the cylinder of the track apparatus by a  $\frac{1}{4}$ -in. brass pipe. It consisted of an ordinary pressure gauge, having a maximum registration of 200 lbs. per sq. in., a recording pressure gauge and a pressure pump by which an initial pressure could be put on the whole system of piping. The ordinary pressure gauge was

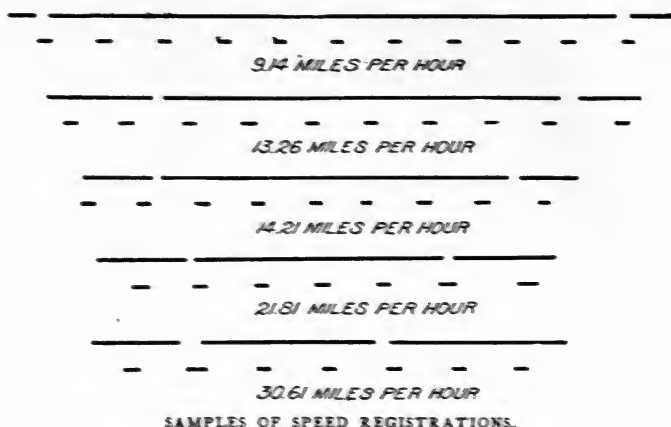

one made by the Utica Steam Gauge Co. and was fitted with a diaphragm spring. It was carefully tested and the dial calibrated before being put in service.

The recording pressure gauge was a modification of the Metropolitan recording gauge made by Schaeffer & Budenberg. The clockwork in it was removed and the paper drum driven by hand, so that a record of indefinite length could be obtained. The fact that this paper was driven by hand explains the irregularity of the intervals elapsing between the passage of the several wheels of the cars. This gauge also had a maximum registration of 200 lbs. per sq. in. with a pen travel of 4 ins., the width of the paper. A Bourdon tube was used as the spring for this gauge. It was calibrated for each set of tests by the Utica gauge and its indications marked on the paper on which the record was taken.

The piping and all spaces filled with liquid were so arranged that air pockets were entirely eliminated

and before work was commenced it was definitely ascertained that the whole space was completely filled with liquid free from bubbles of air.

The speed of the experimental car as it passed the instrument was registered by means of two trips placed alongside the track and arranged to be struck by one of the journal boxes of the car as it passed. The trips closed an electric circuit passing through one of the coils of a double registering Morse telegraph instrument. When the trip was struck by the journal box, the circuit was temporarily broken and the pen lifted, leaving an opening in the line drawn on the strip of paper traveling through the instrument. The time was indicated by a clock making and breaking an electric circuit at half-second intervals. This circuit passed through the other coil of the register. The two records were made side by side and the intervals between the breaks, on the otherwise continuous line, showed the time elapsing between the striking of the two trips. These trips were spaced 66 ft. apart, so that the speed of the passing car could be readily calculated. Specimens of these records are shown in the accompanying diagram where the car was moving at 9.14, 13.26, 14.21, 21.81, and 30.61 miles per hour, respectively.

Through the courtesy of the Pittsburgh, Cincinnati, Chicago & St. Louis Ry., facilities were supplied for making this investigation of wheel stresses. The instrument was placed in the outer rail near the end of a curve of 1,307 ft. radius or about  $4^{\circ} 25'$ . The elevation of the outer rail was  $3\frac{7}{8}$  ins., which is correct for a speed of 36.66 miles per hour. At the point where the records were taken the car was well in

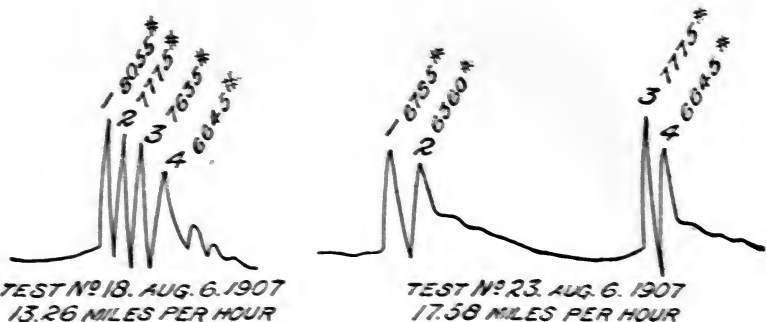

EXAMPLES OF LATERAL THRUST DIAGRAMS OF LOADED COAL CAR.  
TOTAL WEIGHT, 142,000 LBS., OR 4° 25' CURVE.



EXAMPLES OF LATERAL THRUST REGISTRATIONS OF LOADED COAL TRAINS,  
WITH CARS OF 100,000 LBS. CAPACITY.

on the curve, with the trucks set in the normal position, and all the elements of entering the curve were removed. It may be added that the curve was a simple one, with no easement at either end.

On the approach of a train, or the experimental car, an initial pressure was put on the piping system, in order that the movement of the registering pen might be reduced to a minimum and with it the effect of the inertia of the parts. This initial



pressure was varied according to the speed. In operation the actual movement of the floating rail was imperceptible. The levers divided the actual movement by five at the diaphragm, which yielded only enough to take the expansion of the Bourdon tube and the diaphragm of the pressure gauge, when delivering from a cylinder 6 in. in diameter.

Records were taken of a number of passing trains, and also a special series of measurements was made with a loaded coal car run at different speeds over the apparatus. Some of the records are shown in the accompanying diagrams.

In the records of the loaded coal trains, taken as they passed, no memorandum of the weights of the cars was obtained. The weights were, however, approximately the same, and yet there were wide variations in the lateral thrusts of the wheel against the rail. For example: In the train moving at 9.35 miles per hour these thrusts varied from 2,260 lbs. to 7,210 lbs., with an average of 4,835 lbs. On another train, moving at 12.05 miles per hour, the thrust varied from 7,070 lbs. to 10,605 lbs., with an average of 8,205 lbs.; while on another, moving at 4.04 miles per hour, the average was 5,543 lbs., with a range from 4,450 to 6,635 lbs. In one case a car registered a thrust of 16,175 lbs. when moving at 14.35 miles per hour. This wide variation in the lateral thrust of different cars in the same train at the instant of passing the apparatus was still more strikingly shown in the series of tests made with a single car.

The tests with a single car consisted of 33 runs over the apparatus, at speeds varying from 4.57 to 31.25 miles per hour. The car used was a hopper-bottom

coal car of 100,000 lbs. capacity and weighing, when empty, 39,500 lbs. It was designated as of the G1 class of the Pennsylvania Lines West. The total weight of the loaded car was 142,300 lbs.

This car, after being started some distance from the apparatus, was cut loose from the engine and allowed to drift over the track instrument.

The following table gives the records that were made:

Test No.	Speed. M. p. H.	Wheel No.	Lateral Thrust. Lbs.
1	4.57	1	2,470
"	"	2	1,415
"	"	3	1,695
"	"	4	1,415
2	7.63	1	1,695
"	"	2	—
"	"	3	1,415
"	"	4	—
3	10.43	1	2,545
"	"	2	1,770
"	"	3	1,695
"	"	4	1,695
4	7.39	1	2,400
"	"	2	1,415
"	"	3	1,415
"	"	4	1,415
5	8.57	1	2,120
"	"	2	1,270
"	"	3	1,415
"	"	4	1,415
6	8.20	1	1,840
"	"	2	1,415
"	"	3	1,415
"	"	4	1,415

Test No.	Speed. M. p. H.	Wheel No.	Lateral Thrust. Lbs.
7	9.60	1	1,695
"	"	2	1,415
"	"	3	1,270
"	"	4	—
8	10.21	1	3,250
"	"	2	3,110
"	"	3	4,240
"	"	4	3,250
9	9.60	1	3,535
"	"	2	3,535
"	"	3	4,240
"	"	4	3,195
10	9.60	1	3,535
"	"	2	3,250
"	"	3	4,380
"	"	4	3,250
11	15.62	1	3,110
"	"	2	2,970
"	"	3	2,970
"	"	4	2,400
12	11.00	1	4,950
"	"	2	4,240
"	"	3	3,960
"	"	4	3,815
13	16.55	1	4,525
"	"	2	3,535
"	"	3	4,525
"	"	4	3,395
14	14.18	1	3,815
"	"	2	3,535
"	"	3	5,935
"	"	4	4,665
15	12.63	1	3,393
"	"	2	3,250
"	"	3	4,857
"	"	4	3,250

Test No.	Speed. M. p. H.	Wheel No.	Lateral Thrust. Lbs.
16	13.33	1	4,810
"	"	2	4,810
"	"	3	7,350
"	"	4	5,800
TEST OF AUGUST 6TH, 1907.			
17	9.14	1	6,645
"	"	2	5,655
"	"	3	4,950
"	"	4	4,240
18	13.26	1	8,055
"	"	2	7,775
"	"	3	7,635
"	"	4	6,645
19	13.66	1	10,460
"	"	2	7,490
"	"	3	—
"	"	4	—
20	13.27	1	7,210
"	"	2	6,645
"	"	3	6,500
"	"	4	—
21	16.21	1	4,665
"	"	2	—
"	"	3	6,220
"	"	4	—
22	18.00	1	7,210
"	"	2	6,645
"	"	3	—
"	"	4	—
23	17.58	1	6,785
"	"	2	6,360
"	"	3	7,775
"	"	4	6,645
24	14.21	1	9,895
"	"	2	9,470
"	"	3	10,320
"	"	4	8,480

Test No.	Speed. M. p. H.	Wheel No.	Lateral Thrust. Lbs.
25	10.91	1	2,825
"	"	2	—
"	"	3	3,110
"	"	4	—
26	18.46	1	10,320
"	"	2	9,190
"	"	3	10,605
"	"	4	10,320
27	21.81	1	4,950
"	"	2	—
"	"	3	7,490
"	"	4	5,230
28	19.03	1	16,785
"	"	2	—
"	"	3	7,350
"	"	4	5,090
29	25.10	1	5,655
"	"	2	5,655
"	"	3	5,655
"	"	4	3,675
30	25.10	1	10,745
"	"	2	9,330
"	"	3	10,180
"	"	4	9,615
31	27.91	1	10,605
"	"	2	9,895
"	"	3	9,615
"	"	4	—
32	31.25	1	10,035
"	"	2	8,200
"	"	3	11,025
"	"	4	7,775
33	30.61	1	12,445
"	"	2	11,310
"	"	3	12,865
"	"	4	9,190

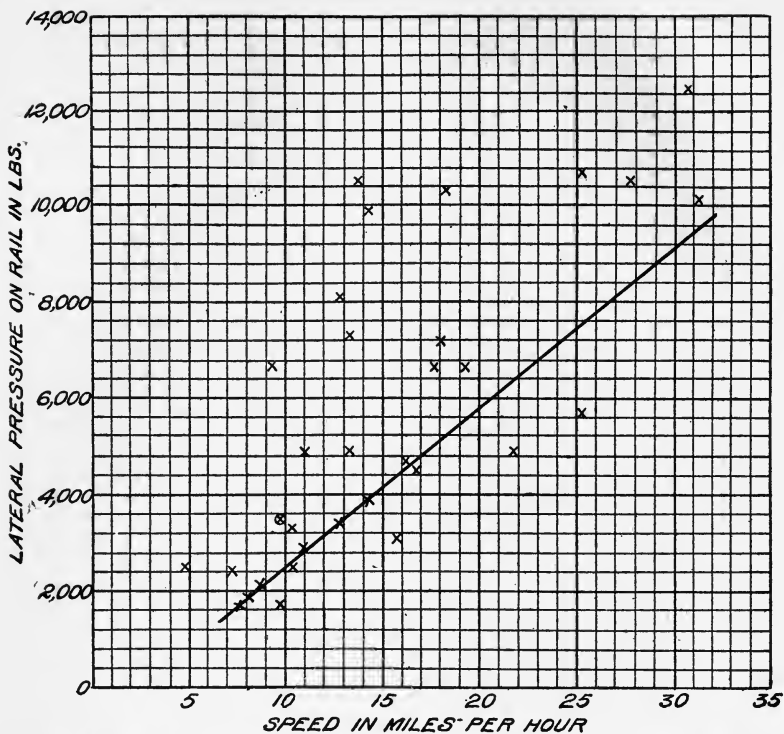

DIAGRAM OF LATERAL THRUST OF LEADING WHEEL OF FORWARD TRUCK OF LOADED COAL CAR. TOTAL WEIGHT, 142,300 LBS., ON 4° 25' CURVE.

The column headed "Wheel No." indicates the order in which the wheels passed over the apparatus. Thus: 1 indicates the front wheel of the forward truck; 2, the second wheel; 3, the front wheel of the rear truck, and 4 the rear wheel. The blank spaces in the column of lateral thrust indicate no record obtained, because of the fact that the initial pressure put on the apparatus was greater than the wheel

thrust, so that the thrust produced no movement of the pen. Throughout the whole series of tests the weather was fine and the rail dry.

For convenience of reference and comparison the lateral thrusts of the front wheel of the forward truck have been plotted on the accompanying diagram. This diagram shows graphically the wide variations in the lateral thrust of the wheel. From it it is impossible to deduce any positive ratio between the speed and the thrust, but it shows that there is a relationship and that the higher the speed the greater the thrust. There are a number of records for the first wheel, extending from about 7.63 miles an hour to 16.55 miles an hour that lie in a straight line drawn from just below the record of 31.25 miles an hour of 10,035 lbs. The line drawn through these points is represented by the equation:

$$T = 333V - 800$$

in which

V = Lateral thrust of wheel in lbs.

T = Speed in miles per hour.

This must be regarded as a tentative formula only and one which evidently will not hold for very low speed. But from the records that have been obtained it gives the lowest values and therefore it cannot be criticized as being too high.

Attention is also called to the fact that the pressure seems to increase directly as the speed and not as the square of the speed which is the rate of increase of the centrifugal force. The probable reason for this is that none of the speeds recorded were equal to or exceeded the speed corresponding to the superelevation of the outside rail. Therefore,

centrifugal action has no effect. In running around a curve the car must be deflected from the tangent at a certain rate, and this requires a certain definite amount of power. If, then, this power is exerted in a short period of time, a higher pressure will be put against the rail than if the time was longer, and, therefore, the pressure will vary inversely as the time. So that if the car passes around the curve in half a minute the pressure will be twice what it would be if a minute was required. Hence the pressure at thirty miles an hour would be twice that at fifteen miles an hour.

When the speed exceeds that for which the superelevation is calculated centrifugal action will then begin to manifest itself, and there will then be a more rapid rise of pressure than would be found from the equation given on page 123. This additional increase would be in the ratio of the square of the speed. For example: At a speed of 36.66 miles per hour the centrifugal effect is balanced by the superelevation of the outer rail on the curve on which these investigations were made. At 40 miles per hour the centrifugal force is 1.19 times as great, and this 19 per cent. additional manifests itself as additional lateral thrust above that called for by the formula.

Taking the car under consideration, weighing 142,300 lbs., the centrifugal action would be 9,648 lbs. at 36.66 miles per hour, 11,481 lbs. at 40 miles per hour, and 14,568 lbs. at 45 miles per hour. The excess centrifugal force to be distributed among the four wheels of the car at 40 and 45 miles an hour would be, therefore,



1,833 lbs. and 4,920 lbs. respectively. If 25 per cent. of this is taken by the front wheel, which is a low estimate of what would actually be imposed, there would be an extra load of 458 lbs. and 1,230 lbs. added to the stress given by the formula for that imposed on the front wheel. This then becomes

11,408 lbs. at 36.66 miles per hour

12,978 lbs. at 40 miles per hour

15,415 lbs. at 45 miles per hour

It must be remembered that these are minimum values, and that blows due to soft spots in the track, kinks in the curve, bent rails, low joints and cramped side bearings will greatly increase this thrust. Sufficient data, however, has not yet been obtained to warrant any estimate of how much this increase would be. The diagram shows that stresses far above those found from this tentative formula are imposed on the wheels.

The extreme case occurred in test No. 19, where the thrust was 6,711 lbs. in excess of that found from the formula. If the blow or cramping which caused this excessive thrust at 13.66 miles per hour was to occur at a speed of 45 miles per hour, the thrust that might be expected would be 22,126 lbs., and if it were to be increased in proportion to the speed it would become more than 36,000 lbs. This may be an extreme and exceptional case, but the results obtained seem to indicate that at least as great a stress as this should be provided for.

Referring again to the tests of flange strength made in 1905 by Professor Goss, in the 23 tests that were

made, the pressures required to break the flange ranged from 47,750 lbs. to 109,900 lbs., with an average of 75,874 lbs. This gives a possible factor of safety of a little more than 2.5 when the maximum stress is taken at 30,000 lbs., but it drops to a little more than 1.5 when the strength of the weakest wheel is taken as the basis of comparison. This is for new wheels. When they have become somewhat worn the strength of the flange is less and the factor of safety is decreased still more. If this loss of strength in the old wheel is taken at 10 per cent., because of metal worn away, the strength of the weakest wheel used in the tests referred to would be 42,975 lbs., and this would allow a factor of safety above a maximum load of 30,000 lbs. of about 1.4.

In this comparison it has been assumed that a car of 100,000 lbs. capacity will deliver the maximum thrust to the wheel on a  $4\frac{1}{2}$  degree curve at 45 miles per hour. This assumption was made because the data was obtained from such a curve. It is evident that greater stresses would be imposed on curves of sharper radius. The outer thrust, where centrifugal action is eliminated, would probably vary inversely as the radius of curvature. There is no data, as yet, to support this position, but it appears probable. If on further investigation this relation is found to hold, then, instead of a thrust of 12,520 lbs. being put on the wheel, as in the case of a car moving over the  $4^{\circ} 25'$  curve at 40 miles an hour, there will be a thrust of nearly 22,800 lbs. when the same speed is maintained over a curve of  $8^{\circ}$ . To this must be added the extra stresses that may be set up by blows, cramping of the wheels between the rails, the binding

of side bearings and other causes which may result in an increase of the normal stress.

But one weight of car and one arrangement of wheel base has been here considered. There is, as yet, no data to give any idea as to the effect of weight, its distribution on the wheels or the height of the center of gravity, all of which are undoubtedly important.

On the other hand, in this discussion, the whole lateral thrust is considered as resisted by the flange. Under ordinary running conditions this is not the case, for the frictional resistance of the tread of the wheel on the rail must be subtracted from the total thrust. In the car under consideration the weight on the front wheel was 17,900 lbs. If the coefficient of friction is taken at 0.25 then 4,475 lbs. should be subtracted from the pressure given. This would reduce the maximum pressure, as it has been calculated for a speed of 45 miles per hour, to 31,525 lbs. and the probable minimum to 10,930 lbs. It must be remembered, however, that the frictional resistance is apt to fail suddenly and that at all speeds, even where the frictional resistance of the tread on the rail is greater than the lateral thrust, there must be a pressure on the flange in order to effect the deflection of the car on the curve.

In this comparison the front wheel of the leading truck only has been considered, because it is on this wheel that the heaviest lateral thrust is imposed. The table shows that, in general, the maximum lateral thrust is on the first wheel; the thrust on the second is less; on the third it falls between the first and the second, and on the fourth it is the lowest.

In considering the advisability of using cast iron wheels under high capacity cars, it should be borne in mind that the cast iron wheel averages approximately one-half the life under the cars of 100,000 lbs. capacity that it does under cars of 60,000 lbs. capacity. The use of the heavy braking pressure on long grades has been the cause of many failures, because of the additional strains set up due to the heating by the brake shoe. There is a consequent expansion of the rim, and the actual resisting strength of the flange is lowered below that shown in the laboratory tests, which were made with the wheel cold and the metal at its maximum strength. Roads having long, steep grades usually have numerous sharp curves also, and the wheels are likely to be subjected to the most severe stresses when they are least able to resist them. If the lateral thrust on the flanges of wheels, under a loaded car of 100,000 lbs. capacity, runs up as high as 30,000 lbs., and the actual breaking strength of the flanges of cast iron wheels varies from 45,000 lbs. to 105,000 lbs. under the most favorable conditions, the question seems pertinent, is it safe to use such wheels under high capacity cars, in view of the fact that cast iron wheels deteriorate rapidly with wear and successive brake-shoe heating?

The answer depends upon what the user deems a proper factor of safety for such service or the risks he can afford to run.

PRESENTATION OF THE ADVANTAGES CLAIMED FOR THE SCHOEN SOLID FORGED AND ROLLED STEEL WHEEL AS BASED UPON THE RESULT OF THE INVESTIGATIONS SET FORTH IN THE FOREGOING CHAPTERS, TOGETHER WITH THE DEMONSTRATION OF SERVICE TESTS.

BY THE SCHOEN STEEL WHEEL CO.

THE investigations of the physical and chemical properties of car wheels outlined in the preceding chapters show what is being done in the manufacture of car wheels and steel tires and the requirements which must be met in service. Acting upon the accepted theory that steel must have a maximum amount of work put upon it to insure its integrity and efficiency, consideration of cast steel wheels has been ignored. It has been shown that the metal in the Schoen solid forged and rolled steel wheel is in all respects equal to if not better than the metal in standard brands of steel tires and wheels as regards physical properties. It would naturally be expected then that these wheels should compare favorably in wearing qualities and strength in actual service. This expectation has been completely fulfilled by the wheels which have been running under tenders, freight and passenger cars, and street and interurban electric cars. The Schoen solid forged and rolled steel wheel has been found to give materially greater mileage for the same limit of wear than steel-tired wheels under exactly the same conditions.

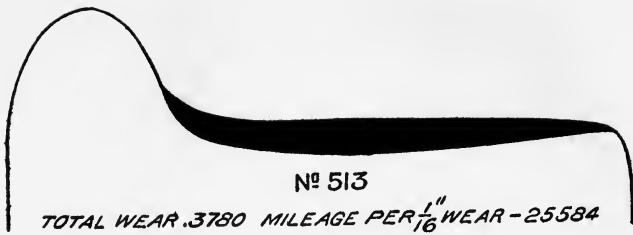

WEAR OF SCHOEN STEEL WHEELS UNDER POSTAL CARS.

MILEAGE OF { 513 AND 547 = 154,732.  
 503 AND 522 = 184,539.

As a fair example of what has been done with these wheels in heavy passenger car service the following record is given of a test made on wheels placed under postal car No. 6545, running on the Pennsylvania Railroad between New York and St. Louis: The car weighed 154,000 lbs., carried on two six-wheel trucks, giving a weight per wheel of 12,833 lbs. The wheels under this car ran 184,539 miles with a wear ranging from .348 in. to .378 in., or an average of .365 in. The mileage per  $\frac{1}{16}$  in. of wear was 25,618. The tread was maintained at all times in smooth condition and the wear on all of the wheels was remarkably uniform and even.

Twelve pairs of wheels from the same lot were placed under one truck each of four postal cars on various runs. The average mileage of these wheels up to the time of first turning was 109,018, with a minimum of 87,375 miles and a maximum of 141,170 miles. The pair of wheels giving this maximum mileage were worn .3185 in. and .2785 in. respectively. An average wear of .2597 in. in 109,018 miles was obtained from all 12 pairs, which is at the rate of 419,703 miles per inch or 26,231 miles per  $\frac{1}{16}$  in. of wear. If the amount of metal removed by turning is added to the actual wear these figures are reduced to 234,202 miles per inch and 14,638 miles per  $\frac{1}{16}$  in. of wear. The causes of removal of these wheels were 3 pairs for worn treads, 3 pairs for cut journals, 1 pair for a loose wheel, 1 pair for a thin flange and 3 pairs for hollow and built-out flanges. At the time this record was taken the remaining pair of wheels had not been removed.

In electric traction work, where the service is much more severe than on steam roads, because of the greater number of stops and the bad condition of the rails, and because of the fact that the majority of the wheels are motor driven, the mileage is less, but is still sufficiently high to show a decided advantage for the solid forged and rolled steel wheel over the cast iron wheel. The records of the Brooklyn Rapid Transit Co. show that from these wheels there was obtained a mileage per  $\frac{1}{16}$  in. of wear of 6,500 miles under electric freight cars running on the surface lines, and from 8,520 miles to 9,750 miles under motor passenger cars. This is at the rate of about .0961 in. and .0641 in. respectively per 10,000 miles run, with the wheels still remaining in such good condition that turning was unnecessary. Still better results were obtained with these wheels under elevated motor cars of the same company. The records show wear at the rate of  $\frac{1}{16}$  in. per 10,850 miles run, or a reduction of .0575 in. per 10,000 miles. The flange and tread were still in good condition after having been worn down  $\frac{3}{8}$  in. and more. The accompanying tables and diagrams illustrate in a striking manner the remarkable service obtained by these wheels on this road and substantiate all of the claims made for them for electric railway work.

From the data here presented it will be a simple matter to compare the value of the solid forged and rolled steel wheel with the value of the cast iron wheel in similar service. Dividing the life of the steel wheel by the life of the cast iron wheel gives the number of cast iron wheels required for an



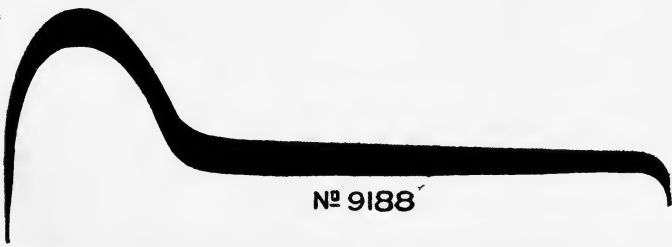
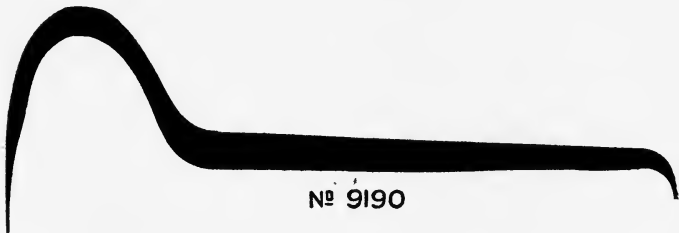
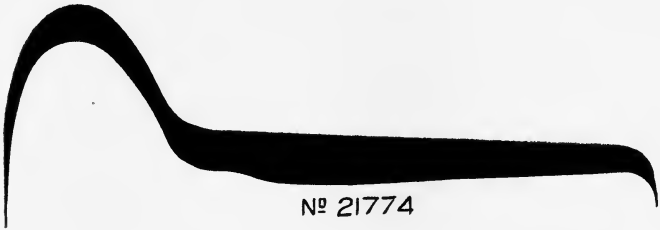
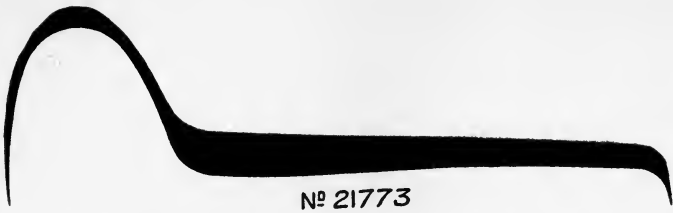

WEAR OF SCHOEN STEEL WHEELS ON BROOKLYN RAPID TRANSIT R.R.

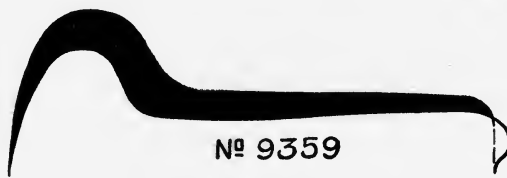
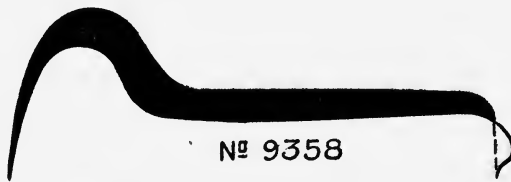
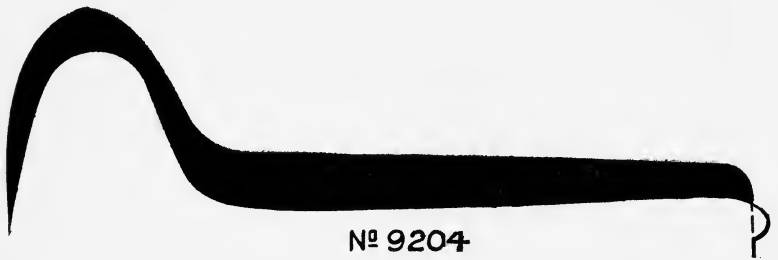

WEAR OF SCHOEN STEEL WHEELS ON BROOKLYN RAPID TRANSIT R.R.

WEAR OF TREAD — SCHOEN ROLLED STEEL WHEELS.

Type of Truck.	Wheel No.	Kind of Shoe.	Weight on each Wheel.		Diam. when Installed.	Diam. when Removed.	Mileage.	Number of Turnings.	Reduction in Diameter per 10,000 miles.		Estimated Number of Stops.
			Lbs.	In.					In.	In.	
Freight Truck . . .	9358	Flanged	4,394	31	30 <sup>5</sup> / <sub>8</sub>	19,500	None	.1923	<sup>3</sup> / <sub>8</sub>	58,500	
“ “ . . .	9359	“	4,394	31	30 <sup>7</sup> / <sub>8</sub>	19,500	“	.1923	<sup>3</sup> / <sub>8</sub>	58,500	
Motor Truck . . .	9199	“	10,825	33	32 <sup>1</sup> / <sub>4</sub>	58,500	“	.1282	<sup>3</sup> / <sub>4</sub>	204,100	
“ “ . . .	9204	“	10,825	33	32 <sup>1</sup> / <sub>4</sub>	58,500	“	.1282	<sup>3</sup> / <sub>4</sub>	204,100	
“ “ . . .	9188	“	7,482	33	32 <sup>3</sup> / <sub>8</sub>	42,600	“	.1466	<sup>5</sup> / <sub>8</sub>	85,400	
“ “ . . .	9190	“	7,482	33	32 <sup>3</sup> / <sub>8</sub>	42,600	“	.1466	<sup>5</sup> / <sub>8</sub>	85,400	
ElevatedRailway Coach . . .	21773	Flangeless	4,262	30	29 <sup>9</sup> / <sub>16</sub>	70,650	“	.115	1 <sup>9</sup> / <sub>16</sub>	10,811	
ElevatedRailway Coach . . .	21774	“	4,262	30	29 <sup>1</sup> / <sub>4</sub>	70,650	“	.1061	<sup>3</sup> / <sub>4</sub>	10,811	

equivalent mileage. The cost of renewals of the cast iron wheels must be added to the first cost and credit allowed for the scrap value of the old wheels removed.

There are other items of cost, however, which, although difficult to accurately estimate are, nevertheless, important. It must be remembered that each car has an earning capacity which is lost whenever the car is in the shop for renewals or repairs, and this should be credited to the steel wheel which involves no such loss. Again, if the number of shop-pings for wheel defects can be materially reduced the same volume of traffic can be handled with fewer cars, thus saving investment in rolling stock and, what is almost as important in large cities, saving in expensive storage space. These advantages, tangible and intangible, have been so thoroughly demonstrated to street railway officers by the experience of a few

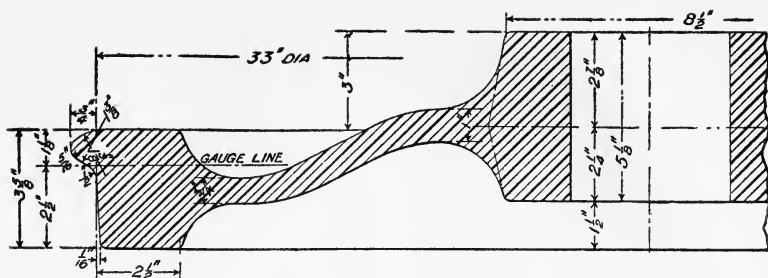

33-IN. STREET-CAR WHEEL.

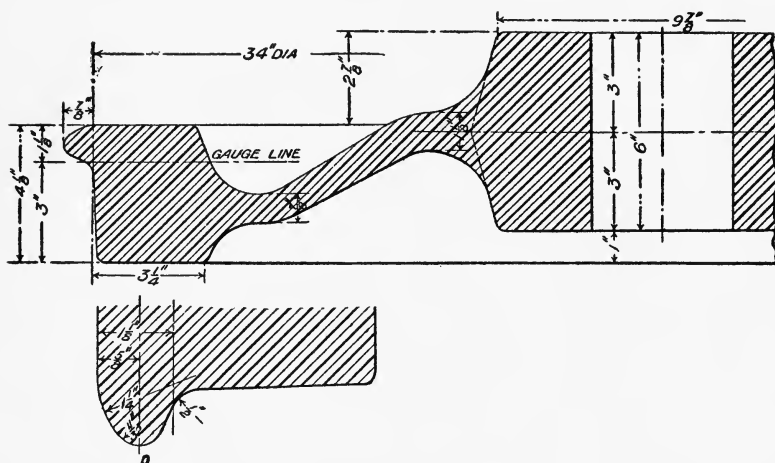

34-IN. STREET-CAR WHEEL.

roads which early began to use solid steel wheels, that there is a large and growing demand for them in every class of electric service. For inter-urban roads especially, where the speeds are frequently as high as those obtained on steam railroads, solid steel wheels have been generally adopted for reasons of safety. The solid steel

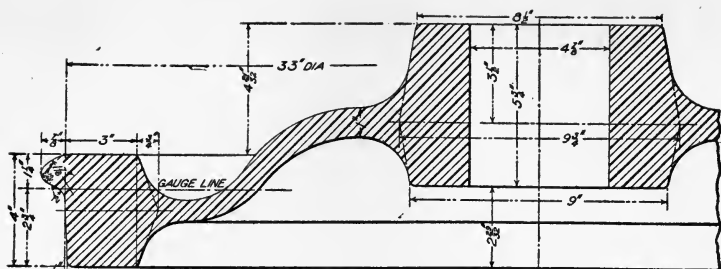

33-IN. WHEEL FOR THE UNITED ELECTRIC RAILWAYS AND ELECTRIC CO. OF BALTIMORE, MD.

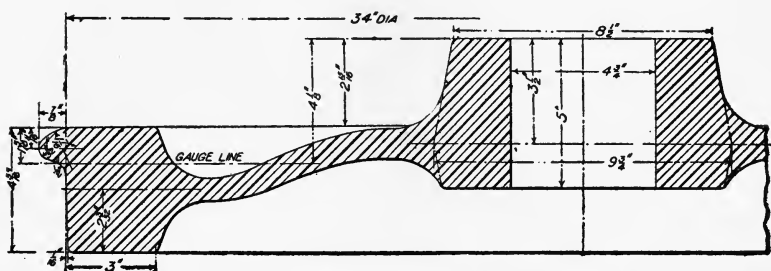

34-IN. WHEEL FOR CITY AND INTERURBAN SERVICE, DESIGNED FOR SANDERSON & PORTER, CONTRACTORS AND ENGINEERS.

wheel offers all of the advantages of wear claimed for the steel-tired wheel at a much smaller cost, and in addition greater safety, because of the impossibility of parts coming loose. When compared with steel-tired or built-up wheels, in which the parts are shrunk on or bolted in place, and therefore liable to become slipped under the combined effect of expansion due to brake-shoe heating and the torque of the motor, the advantages of a solid steel wheel for traction purposes become immediately apparent.

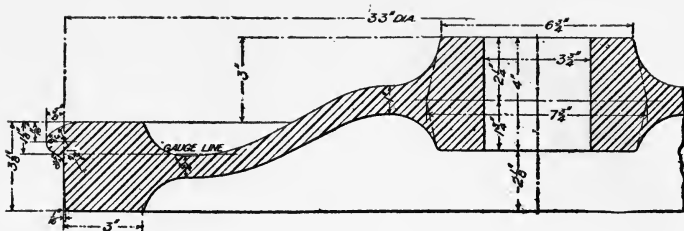

83-IN. STREET-CAR WHEEL FOR NEW YORK CITY RAILWAY CO.

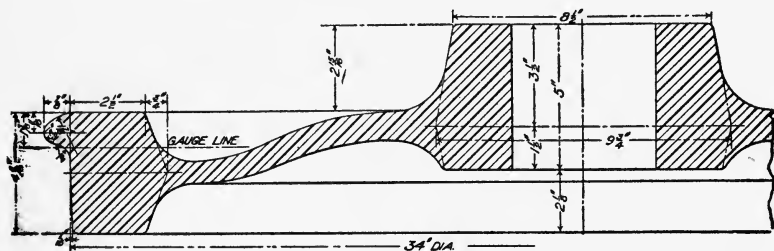

84-IN. STREET-CAR WHEEL FOR PENNSYLVANIA AND MAHONING VALLEY TRACTION CO.

The solid forged and rolled steel wheel was originally developed to meet the severe requirements of service under high capacity freight cars and it is in this field that it has the widest possibilities of application. That there is a demand for these wheels is shown by the fact that more than 150,000 are now in use, 55,000 of them in service under 100,000 lbs. capacity cars, and the number is steadily increasing.

It is difficult to make an estimate of the mileage cost of freight car wheels because of the incomplete records usually kept. From the best statistics available, however, it appears that the mileage obtained from cast iron wheels under 100,000 lbs. capacity cars is between 25,000 miles and 30,000 miles.

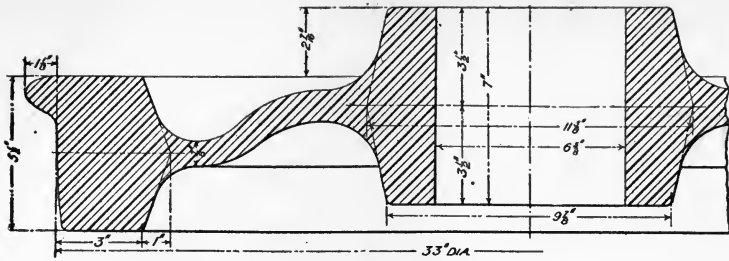

33-IN. STEEL WHEEL.

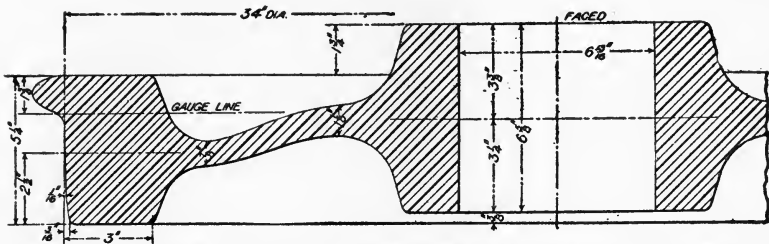

34-IN. SUBWAY MOTOR-TRUCK WHEEL FOR THE INTERBOROUGH RAPID TRANSIT CO., NEW YORK.

From the tests made of Schoen solid forged and rolled steel wheels under postal cars on the Pennsylvania Railroad it was found that there was obtained an average mileage of 14,638 per  $\frac{1}{16}$  in., including wear and turning. Under heavy tenders, the mileage averaged 7,000 per  $\frac{1}{16}$  in. of wear and turning. The average of these two figures, 10,800 miles per  $\frac{1}{16}$  in. of wear and turning, may be taken as the probable average service which can be obtained from these wheels under high capacity freight cars. The wheels furnished to the Pennsylvania Railroad for freight cars have a rim 2 in. thick with limit groove for wear cut  $\frac{3}{4}$  in. in from the inner edge. This gives

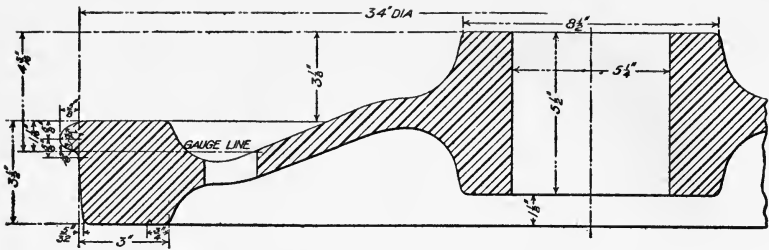

34-IN. STREET-CAR WHEEL FOR CHICAGO CITY RAILWAY CO.

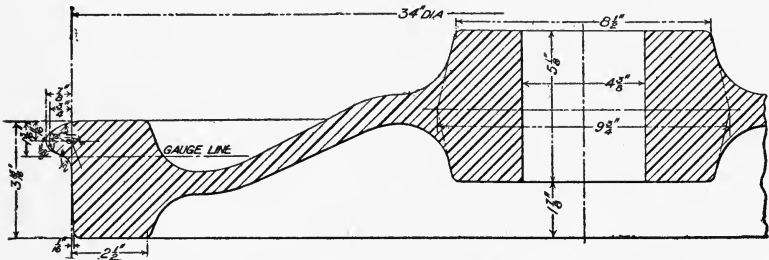

34-IN. STREET-CAR WHEEL FOR CONSOLIDATED RAILWAY CO.,  
NEW HAVEN, CONN.

a wearing thickness of  $1\frac{1}{4}$  ins. available for service. At 10,800 miles per  $\frac{1}{16}$  in. of wear, the total mileage which can be obtained from these wheels is  $20 \times 10,800 = 216,000$  miles as against 30,000 miles for cast iron wheels, or a little more than seven times the life.

If the first cost of a cast iron wheel is taken at \$10 and its scrap value at \$5, then the cost of cast iron wheels to give a life equivalent to the life of one Schoen solid forged and rolled steel wheel would be:

7 cast iron wheels at \$10 each	\$70
7 scrap wheels (credit) at \$5 each	\$35
	<hr/>
Actual cost of cast iron wheels	\$35







The original cost of the solid forged and rolled steel wheel may be taken at \$20 and its scrap value at the end of its life at \$5. Its total cost, therefore, would be \$15 as against \$35 for the equivalent number of cast iron wheels required to give the same mileage. It is assumed that the cost of turning the solid steel wheel the required number of times during its life would equal the cost of removing and replacing the cast iron wheels on the axle.

The accompanying diagram shows graphically the comparative mileage, cost and strength of the ordinary cast iron wheel and the Schoen

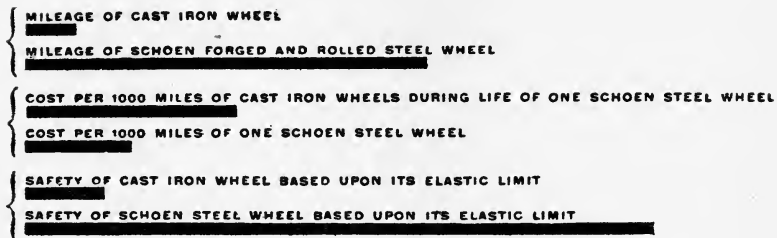

CHART OF COMPARATIVE VALUES OF THE SCHOEN FORGED AND ROLLED STEEL WHEEL, AND THE CAST IRON WHEEL FOR LARGE CAPACITY FREIGHT CARS AND COACHES.

solid forged and rolled steel wheel. The first two lines show the comparative mileage, the next two show the comparative cost per 1,000 miles run, and the last two lines show the comparative safety of the two wheels based on the elastic limits of the metal of which they are made. The mileage is as 7 to 1 in favor of the steel wheel and the cost per 1,000 miles is as 2 to 1 in its favor. The elastic limit of cast iron as shown on the chart is

that given by Unwin: 10,500 lbs. in tension and 21,500 lbs. in compression with a mean of 16,000 lbs. The elastic limit of the steel wheel is taken at 107,457 lbs., a ratio of 6.7 to 1 in favor of the steel wheel. If the actual breaking strength of the flanges had been used in proportioning the relative lengths of these lines their ratio would have been as 8.6 to 1 in favor of the steel wheel as against the old M. C. B. standard cast iron wheel and 5.3 to 1 in favor of the steel wheel as against the new reinforced flange cast iron wheel. It is evident, therefore, that the ratio of 6.7 to 1, as given on the chart, is conservative.

Cast iron wheels under high capacity cars are a known source of danger, and on most mountain roads a careful inspection of every wheel is made when a freight train stops at the foot of a long grade. This costs time and money, and even then the inspection is not always successful in detecting incipient failures which develop later with disastrous results. The loss of earning capacity of cars standing idle awaiting shopping for wheel defects is important in times of congestion of traffic. It is a fact that many roads are prevented from realizing the full benefit of large overload carrying capacity simply because the cast iron wheels are not considered safe to carry such loads.

In the foregoing pages many and important advantages of the Schoen solid forged and rolled steel wheel have been demonstrated. Careful examinations of the metal of which the wheel is made have shown it to possess better physical properties than the best steel tires and wheels on the market. Experience in service, with wheels under freight and

passenger cars, locomotive tenders and electric cars, proves that the wearing quality is superior to the best of its competitors. The investigation of the lateral thrust of the wheel against the rail gives conclusive evidence that the cast iron wheel, even when made of the best material and with the flange reinforced as in the latest designs, is not safe under high capacity cars at any but the lowest speeds. Finally, it has been shown that the solid forged and rolled steel wheel can be applied under freight cars in place of cast iron wheels with an actual saving of \$7 per 100,000 miles run, or \$56 per 100,000 car miles. In considering the question of car wheels for any service, therefore, from the standpoint of safety, mileage or cost, the solid forged and rolled steel wheel stands in front of all others.



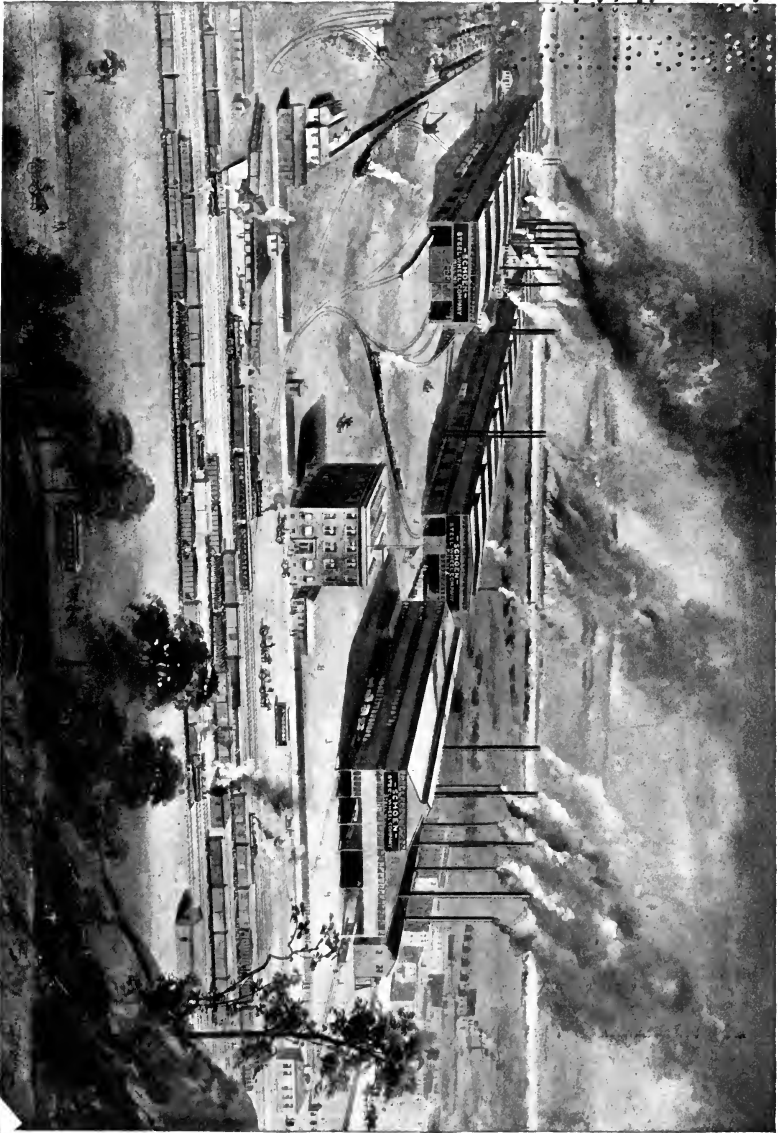

The Schoen Steel Wheel  
Company's works at  
McKees Rocks, Pa.

TO THE  
MEMBERS OF THE  
LEGISLATIVE ASSEMBLY



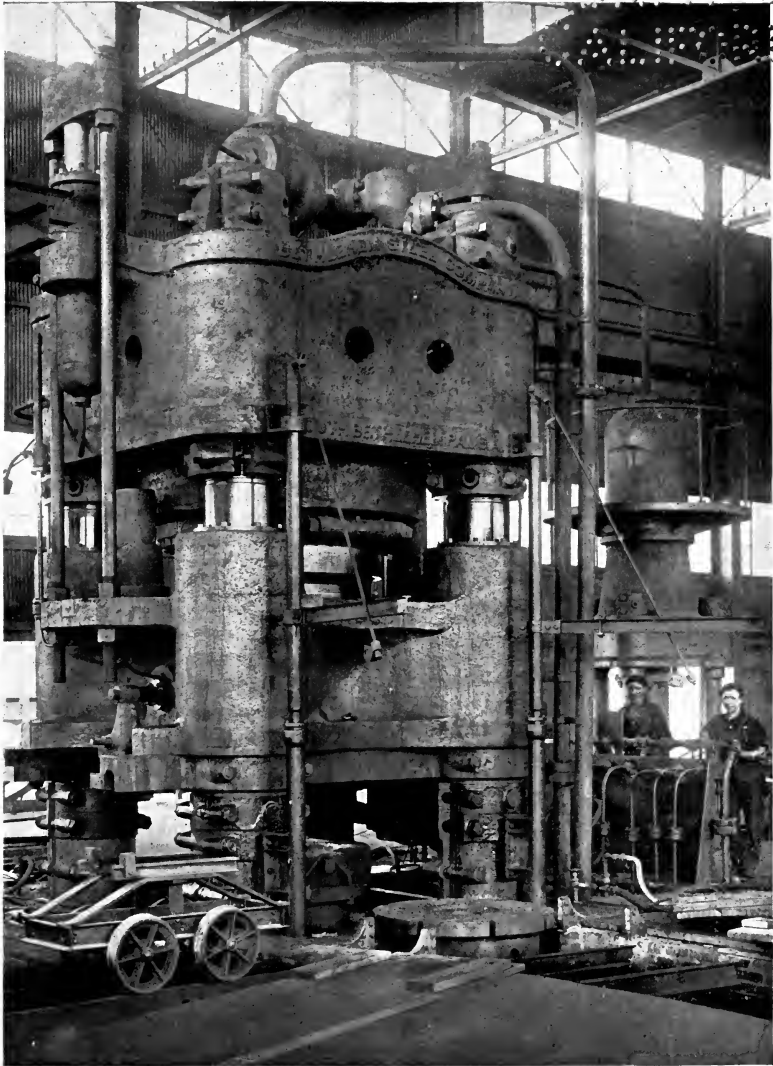

Hydraulic presses, each with a capacity of eighteen million pounds, are used to forge the Schoen Solid Steel Car Wheel.

TO THE  
MEMBERS



The most ingenious mechanism is required to roll and finish a Schoen Solid Steel Car Wheel.

NO. 1000  
ABSTRACT

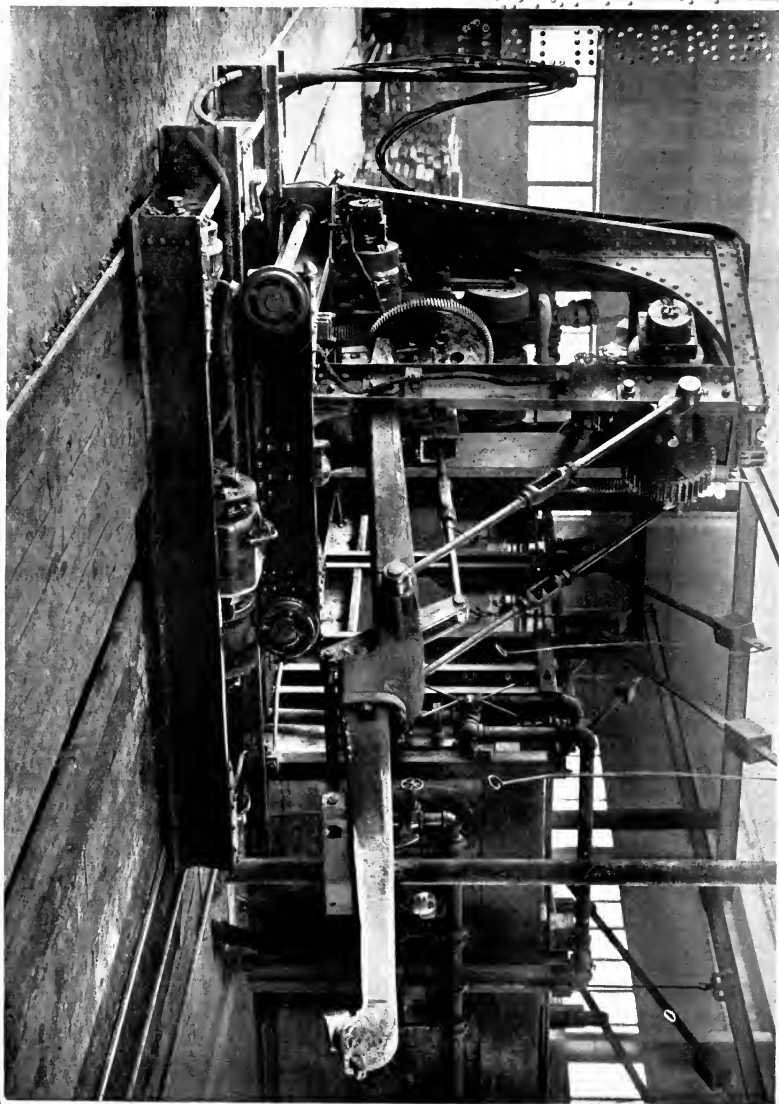

One of the electric manipulators used for handling the steel blooms in the manufacture of Schoen Solid Steel Car Wheels.

TO THE  
LIBRARY OF CONGRESS

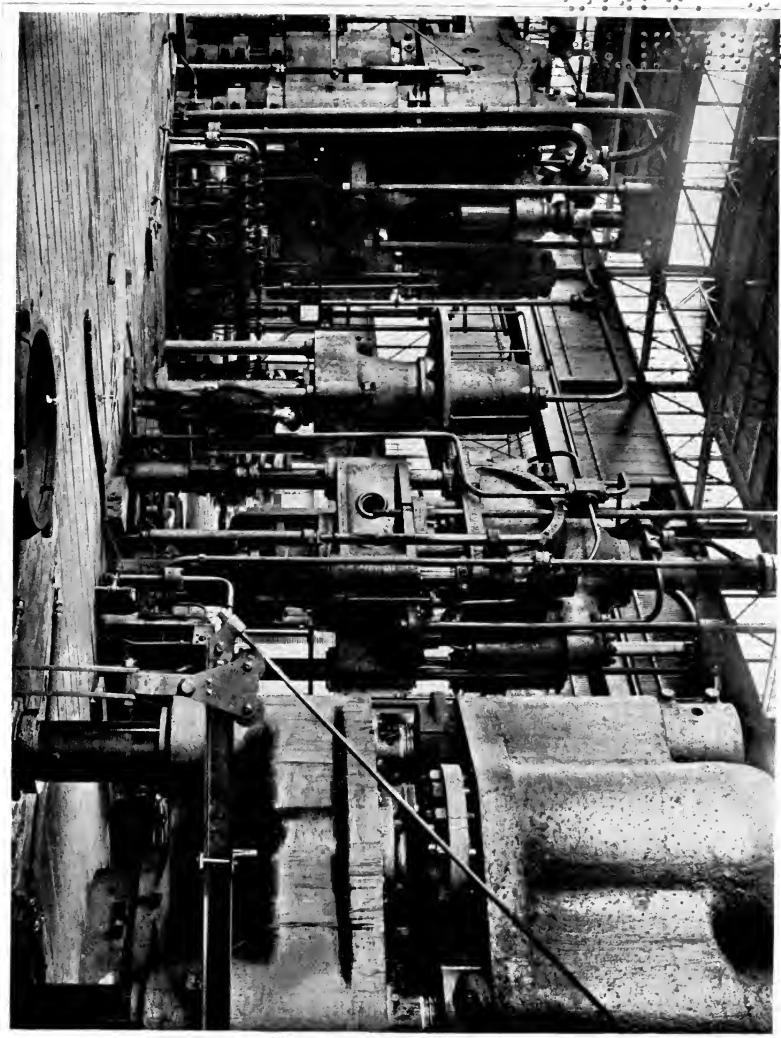

Various types of hydraulic presses are used in forging Schoen Solid Steel Car Wheels.

NO. 1111  
APRIL 1940



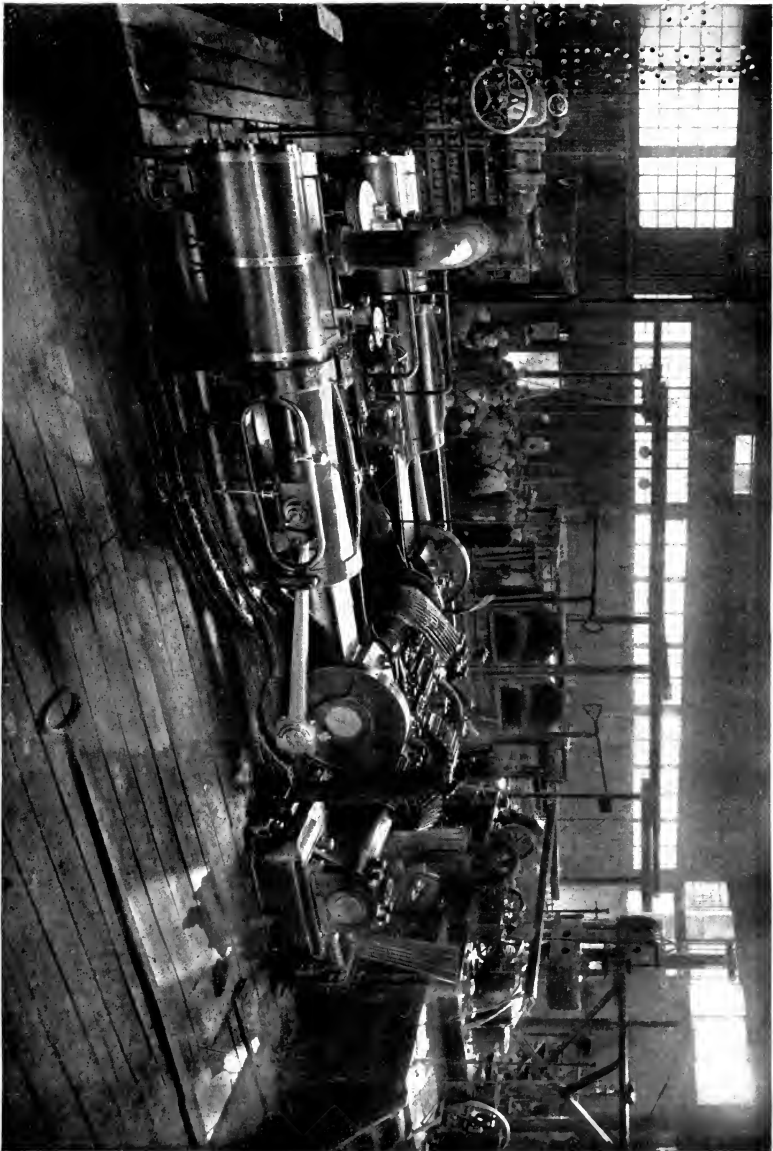

Twelve hundred horse-  
power engines are coupled  
each rolling mill used in the  
manufacture of Schoen  
Solid Steel Car Wheels.

70 VMD  
ABACILLAO

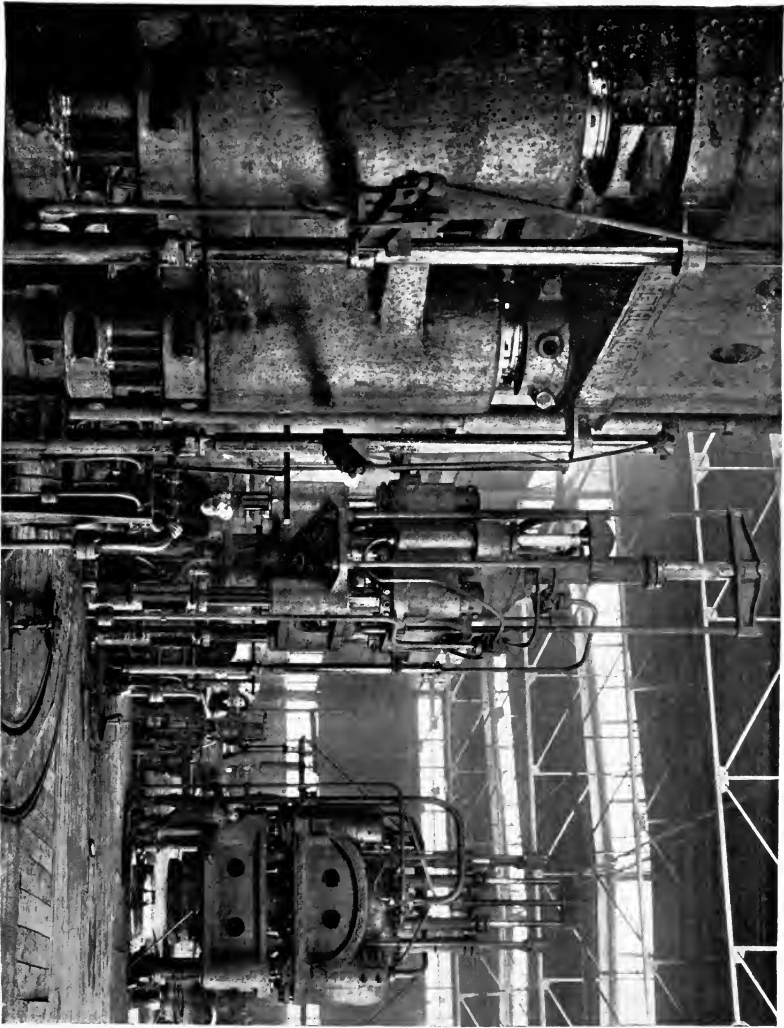

These hydraulic presses were all especially designed to forge Schoen Solid Steel Car Wheels.



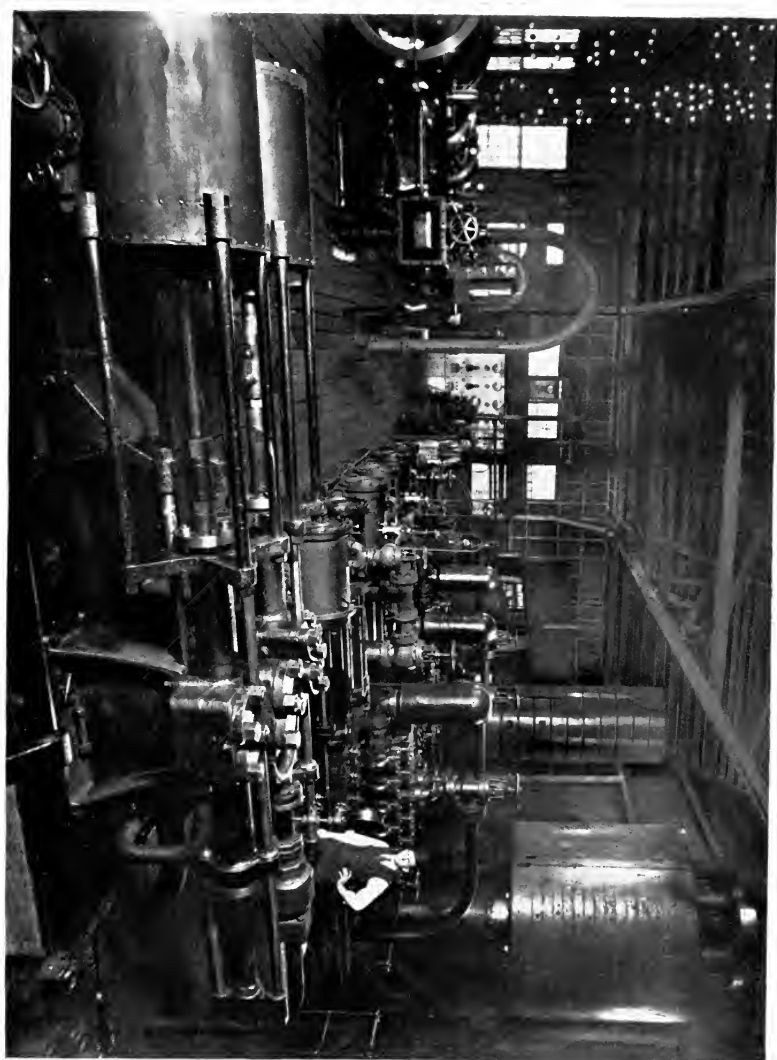

View in one of the power  
houses of The Schoen Steel  
Wheel Company's plant  
at McKees Rocks, Pa.

THE  
MUSEUM









UNIVERSITY OF CALIFORNIA LIBRARY,  
BERKELEY

**THIS BOOK IS DUE ON THE LAST DATE  
STAMPED BELOW**

Books not returned on time are subject to a fine of 50c per volume after the third day overdue, increasing to \$1.00 per volume after the sixth day. Books not in demand may be renewed if application is made before expiration of loan period.

**JAN 18 1922**

20m-11,'20

TF 373 435963

F8

UNIVERSITY OF CALIFORNIA LIBRARY

