



This is a digital copy of a book that was preserved for generations on library shelves before it was carefully scanned by Google as part of a project to make the world's books discoverable online.

It has survived long enough for the copyright to expire and the book to enter the public domain. A public domain book is one that was never subject to copyright or whose legal copyright term has expired. Whether a book is in the public domain may vary country to country. Public domain books are our gateways to the past, representing a wealth of history, culture and knowledge that's often difficult to discover.

Marks, notations and other marginalia present in the original volume will appear in this file - a reminder of this book's long journey from the publisher to a library and finally to you.

### **Usage guidelines**

Google is proud to partner with libraries to digitize public domain materials and make them widely accessible. Public domain books belong to the public and we are merely their custodians. Nevertheless, this work is expensive, so in order to keep providing this resource, we have taken steps to prevent abuse by commercial parties, including placing technical restrictions on automated querying.

We also ask that you:

- + *Make non-commercial use of the files* We designed Google Book Search for use by individuals, and we request that you use these files for personal, non-commercial purposes.
- + *Refrain from automated querying* Do not send automated queries of any sort to Google's system: If you are conducting research on machine translation, optical character recognition or other areas where access to a large amount of text is helpful, please contact us. We encourage the use of public domain materials for these purposes and may be able to help.
- + *Maintain attribution* The Google "watermark" you see on each file is essential for informing people about this project and helping them find additional materials through Google Book Search. Please do not remove it.
- + *Keep it legal* Whatever your use, remember that you are responsible for ensuring that what you are doing is legal. Do not assume that just because we believe a book is in the public domain for users in the United States, that the work is also in the public domain for users in other countries. Whether a book is still in copyright varies from country to country, and we can't offer guidance on whether any specific use of any specific book is allowed. Please do not assume that a book's appearance in Google Book Search means it can be used in any manner anywhere in the world. Copyright infringement liability can be quite severe.

### **About Google Book Search**

Google's mission is to organize the world's information and to make it universally accessible and useful. Google Book Search helps readers discover the world's books while helping authors and publishers reach new audiences. You can search through the full text of this book on the web at <http://books.google.com/>

HN 5191 D

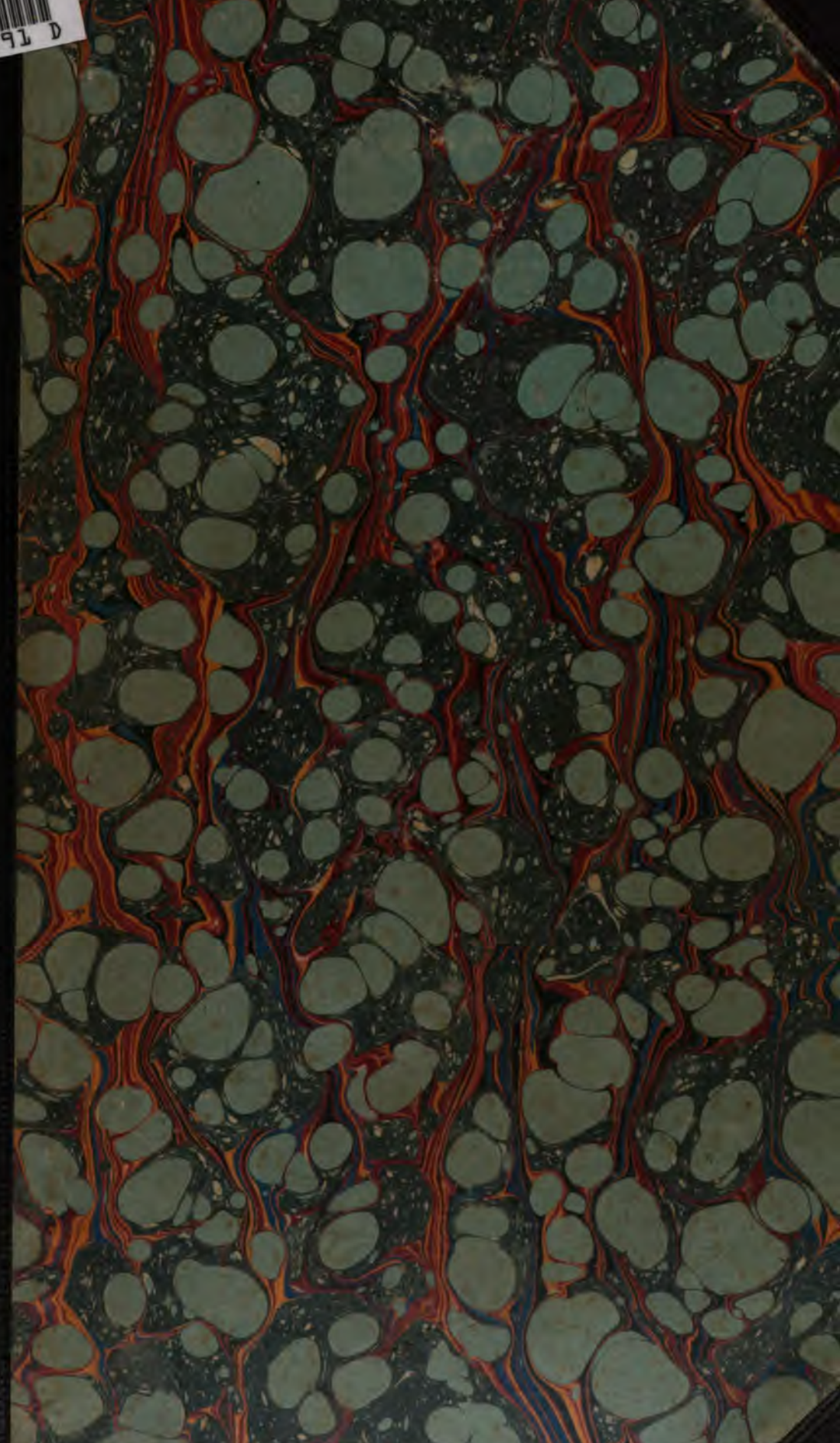

KH177

HARVARD COLLEGE  
LIBRARY



FROM THE LIBRARY OF  
MRS. ELLEN HAVEN ROSS  
OF BOSTON

RECEIVED JUNE 28, 1936

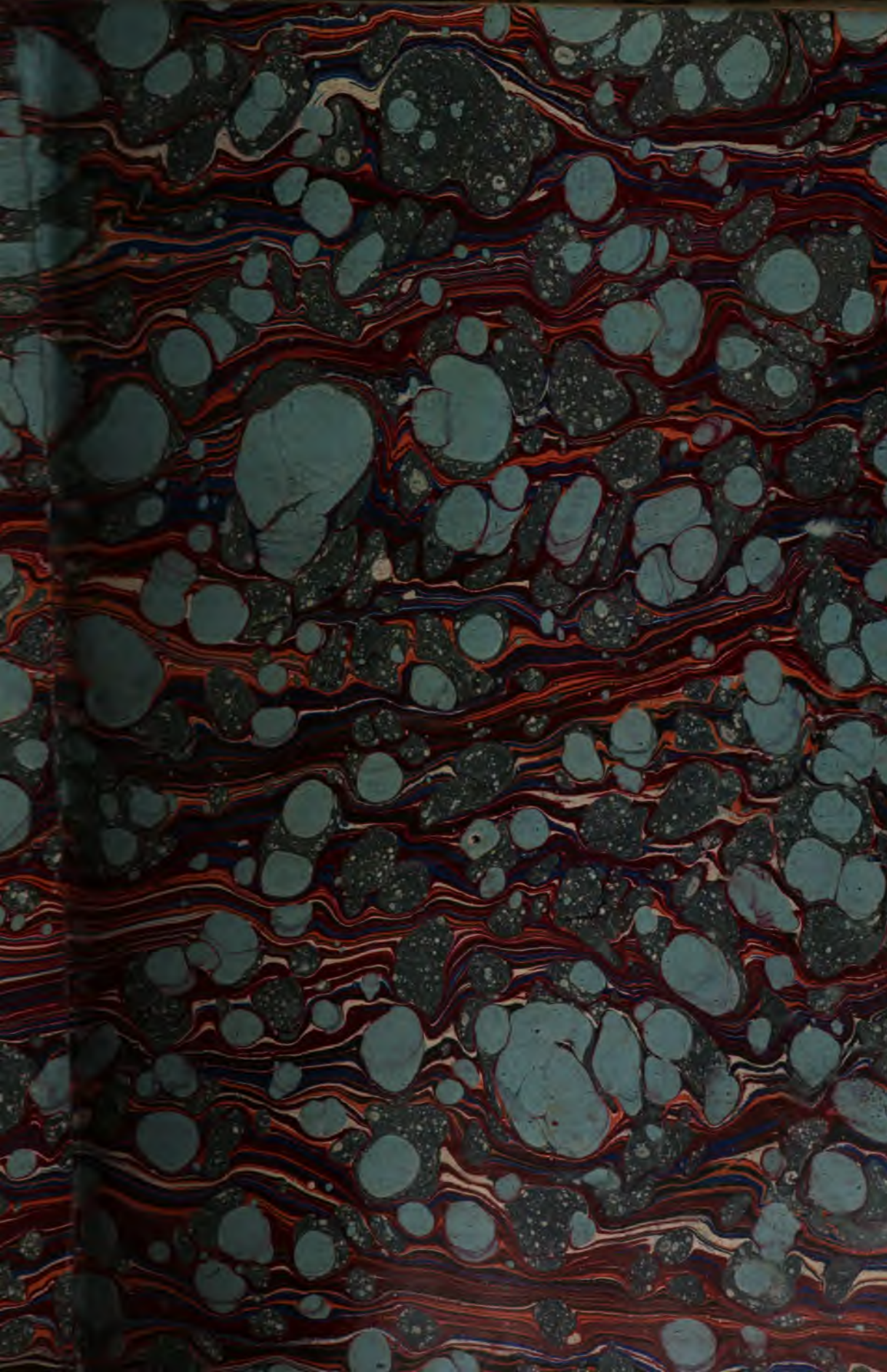

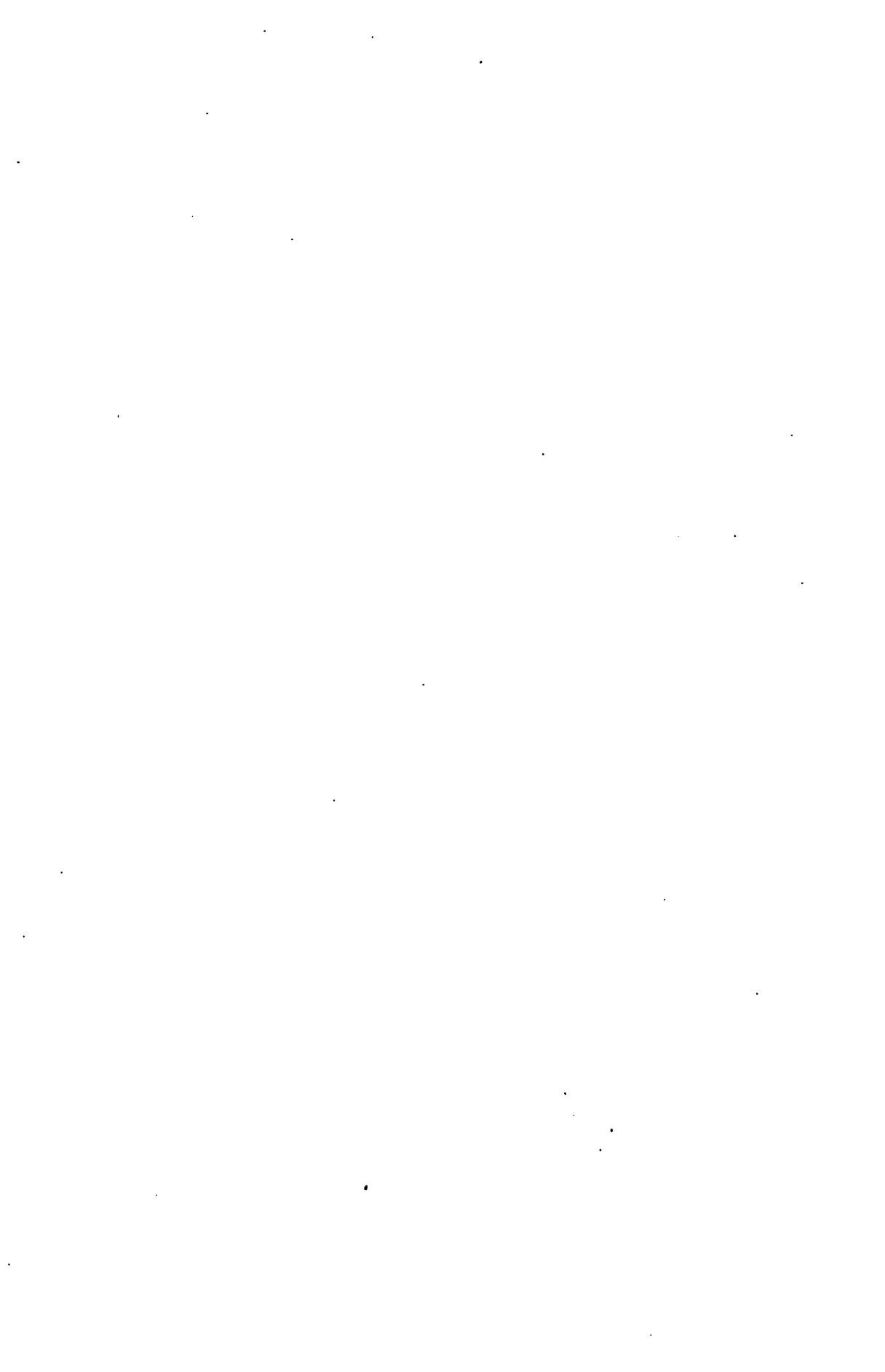

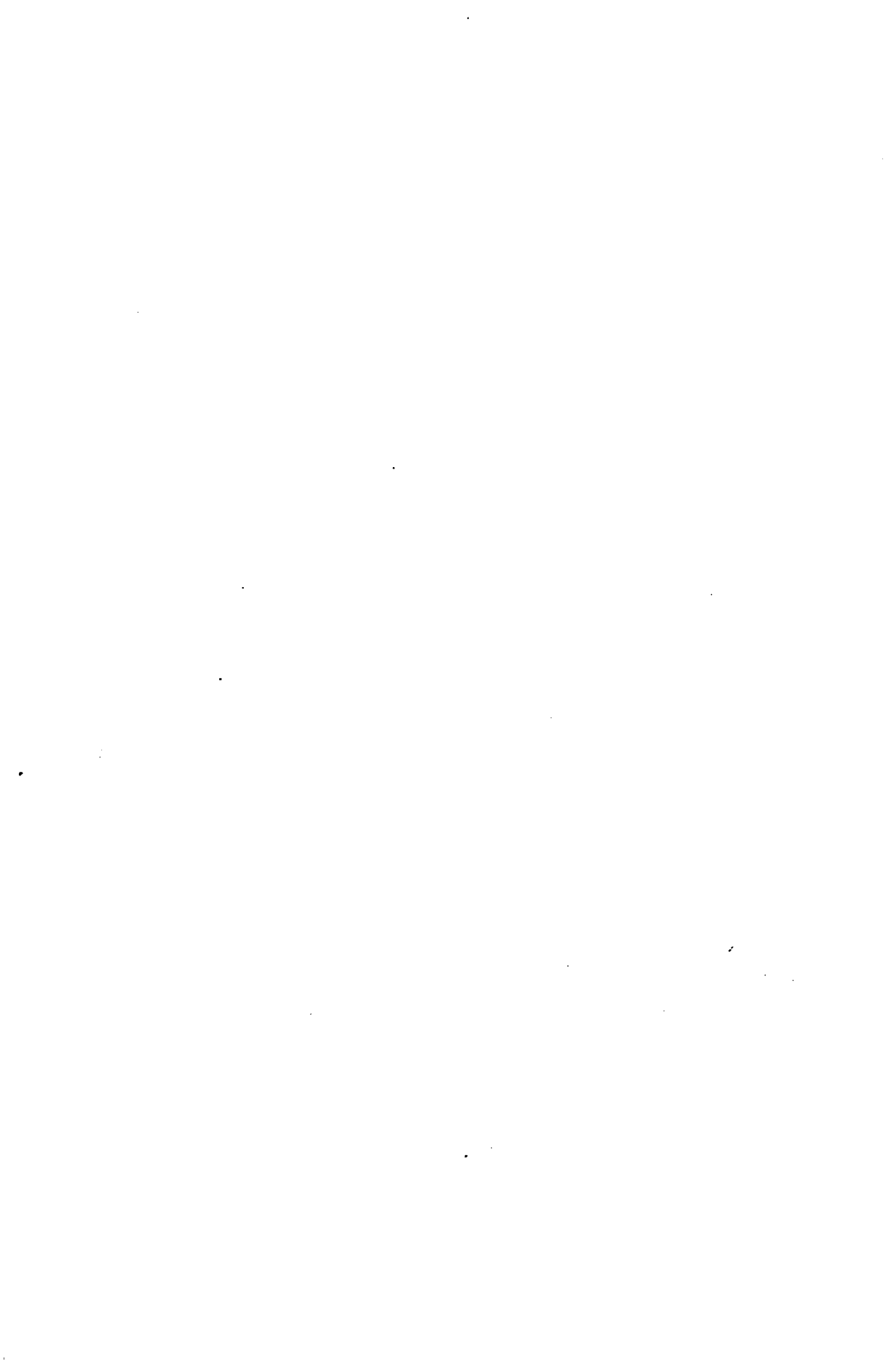



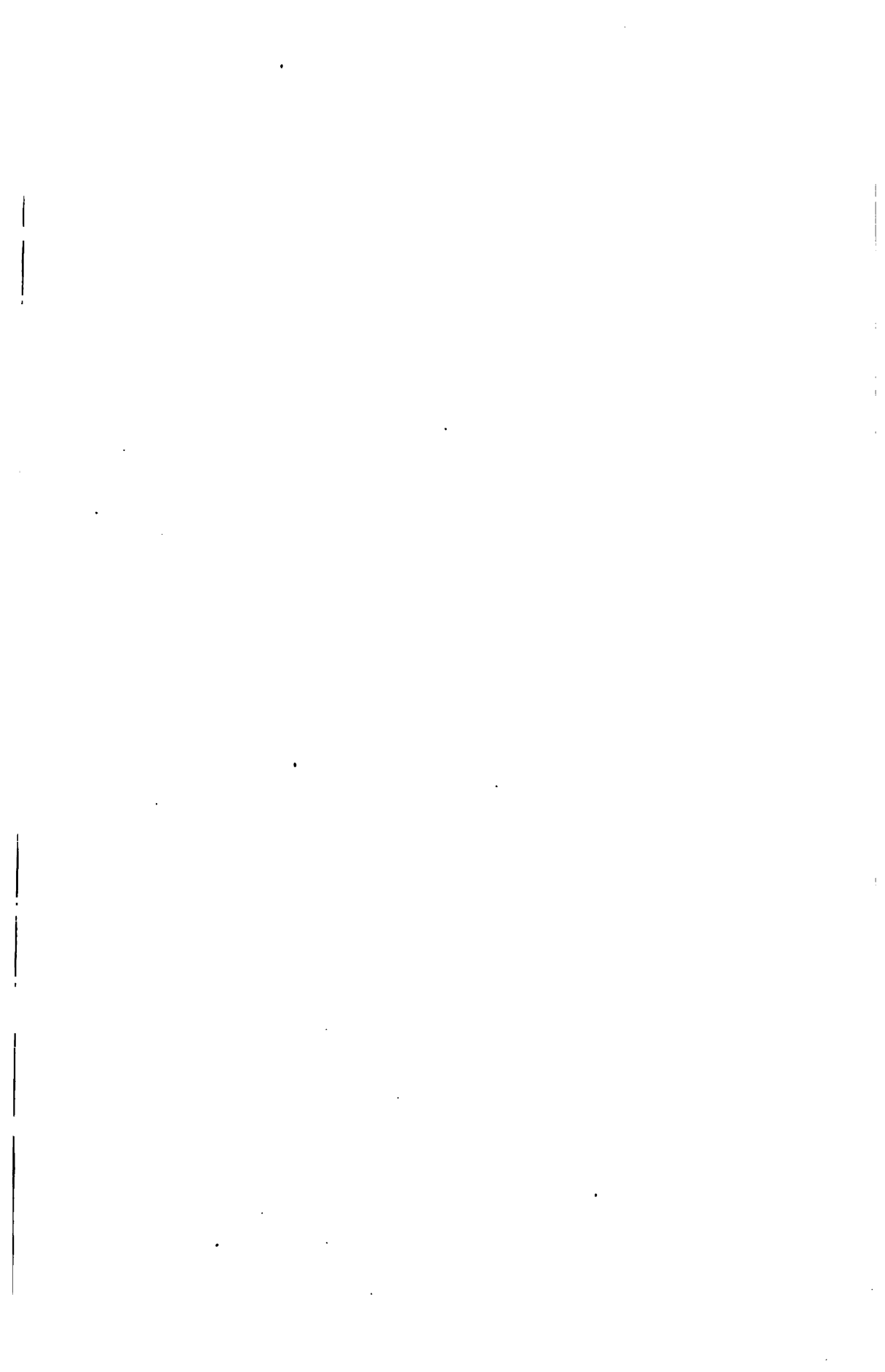





CHAMBERS'S  
ENCYCLOPÆDIA







CHAMBERS'S  
ENCYCLOPÆDIA

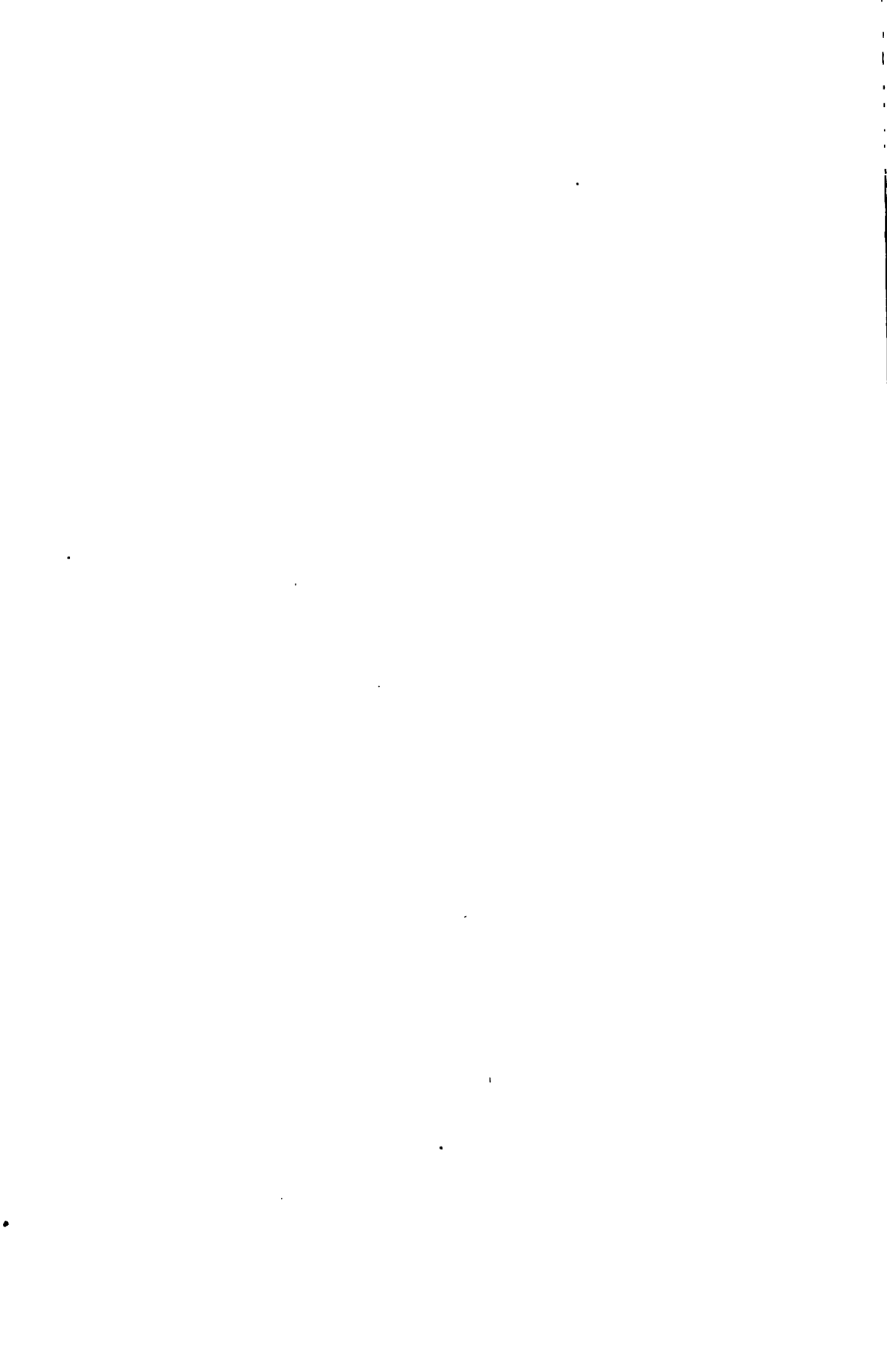

CHAMBERS'S  
ENCYCLOPÆDIA:

A DICTIONARY

OF UNIVERSAL KNOWLEDGE FOR THE PEOPLE,

ILLUSTRATED.

VOL. VII.

PHILADELPHIA:  
J. B. LIPPINCOTT & CO.  
EDINBURGH: W. & R. CHAMBERS.  
1870.



Harvard College Library  
From the Library of  
Mrs. Ellen Haven Ross  
June 26, 1938

---

Entered, according to Act of Congress, in the year 1865, by  
J. B. LIPPINCOTT & CO.,

In the Clerk's Office of the District Court of the United States for the Eastern District of Pennsylvania.

---



## UNIVERSAL KNOWLEDGE FOR THE PEOPLE

### NUMISMATICS.

**NUMISMA'TICS** (Lat. *nummus* and *numisma*, money; Gr. *nomisma*, from *nomos*, law, a medium of exchange established by law), the science which treats of coins and medals. A coin is a piece of metal of a fixed weight stamped by authority of government, and employed as a circulating medium. A medal is a piece struck to commemorate an event. The study of numismatics has an important bearing on history. Coins have been the means of ascertaining the names of forgotten countries and cities, their position, their chronology, the succession of their kings, their usages civil, military, and religious, and the style of their art. On their respective coins we can look on undoubtedly accurate representations of Mithridates, Julius Cæsar, Augustus, Nero, Caracalla, and read their character and features.

The metals which have generally been used for coinage are gold, silver, and copper. In each class is comprised the alloy occasionally substituted for it, as *electrum* (an alloy of gold and silver) for gold, *billon* for silver, bronze for copper, and *potin* (an alloy softer than billon) for silver and copper. The side of a coin which bears the most important device or inscription is called the *obverse*, the other side the *reverse*. The words or letters on a coin are called its *inscription*; an inscription surrounding the border is called the *legend*. When the lower part of the reverse is distinctly separated from the main device, it is called the *exergue* (Gr. *ex ergou*, without the work), and often bears a secondary inscription, with the date or place of mintage. The field is the space on the surface of the coin unoccupied by the principal device or inscription.

The use of coined money cannot be traced further back than the 9th c. B. C. Money, however, as a medium of exchange, existed much earlier, and when of metal it passed by weight, no piece being adjusted to any precise weight, and all money being weighed when exchanged. Early metallic money was in the form of bars, spikes, and rings; the ring

money could be opened, closed, and linked in a chain for convenience of carriage.

The Lydians are supposed to have been the first people who used coined money, about 700 or 800 years before the Christian era; and their example was soon after followed by the different states of Greece, the earliest Greek coins being those of Ægina. In its early stages the process of coining consisted in placing a lump of metal of a fixed weight, and approaching to a globular form, over a die, on which was engraved the religious or national symbol to be impressed. A wedge or punch placed at the back of the metal was held steadily with one hand, and struck by a hammer with the other, till the metal was sufficiently fixed in the die to receive a good impression. The impression was a guarantee of the weight of the piece. From the nature of the process, the earliest coins had a lumpish appearance, and on their reverse was a rough, irregular, hollow square, corresponding to a similar square on the punch, devised for the purpose of keeping the coin steady when struck by the coining hammer. The original coins of Asia Minor were of gold, those of Greece of silver. The earliest coins bear emblems of a sacred character, often embodying some legend regarding the foundation of the state, as the *phoca* or seal on the coins of the Phocians, which alludes to the shoal of seals said to have followed the fleet:

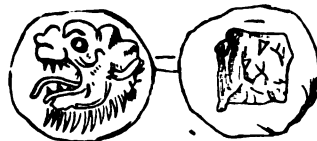

Fig. 1.

during the emigration of the people. Fig. 1. represents a very early double stater of Miletus, in Ionia, of which the type is the lion's head, derived

## NUMISMATICS.

from Persia and Assyria, and associated with the worship of Cybele, a symbol which is continued in the later coinage of Miletus. Types of this kind were succeeded by portraits of protecting deities. The earliest coins of Athens have the owl, as type of the goddess Athene; at a later period, the head of the goddess herself takes its place, the owl afterwards re-appearing on the reverse. The punch-mark, at first a rudely-roughed square, soon assumed the more slightly form of deep, wedge-like indents, which in later specimens become more regular, till they form themselves into a tolerably symmetrical square. In the next stage, the indents become shallower, and consist of four squares forming one large one.

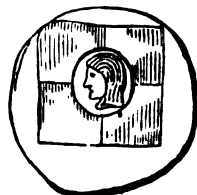

Fig. 2.

The surrounding of the punch-mark with a band bearing a name, and the introduction of a head in its centre, as in the annexed figure (fig. 2), gradually led to the perfect reverse. There is a remarkable series of so-called 'encased' coins struck in Magna Græcia, of which the reverse is an exact repetition in concave of the relief of the obverse. These coins are thin, flat, sharp in

relief, and beautifully executed.

The leading coin of Greece and the Greek colonies was the stater, so called because founded on a standard of weight generally received before the introduction of coined money. There were double staters, and half, third, and quarter staters, and the stater was equivalent in value to six of the silver pieces called drachmæ. The obolus was one-sixth of the drachma, at first struck in silver, in later times in copper.

The inscriptions on the earliest Greek coins consist of a single letter, the initial of the city where they were struck. The remaining letters, or a portion of them, were afterwards added, the name, when in full, being in the genitive case. Monograms sometimes occur in addition to the name, or part name, of the place. The first coin bearing the name of a king is the tetradrachm (or piece of four drachmæ) of Alexander I. of Macedon.

Among the early coins of Asia, one of the most celebrated is the stater Darius or Daric, named from Darius Hystaspes. It had for symbol an archer kneeling on one knee, and seems to have been coined for the Greek colonies of Asia by their Persian conquerors. In the reign of Philip of Macedon, the coinage of Greece had attained its full development, having a perfect reverse. One of the earliest specimens of the complete coin is a beautiful medal struck at Syracuse, with the head of



Fig. 3.

Proserpine accompanied by dolphins, and for reverse a victor in the Olympic games in a chariot receiving a wreath from Victory—a type which is also found

on the reverse of the staters of Philip of Macedon, known as Philips, and largely imitated by other states. Coins of Alexander the Great are abundant, many having been struck after his conquests in the Greek towns of Asia. A rose distinguishes those struck at Rhodes, a bee those struck at Ephesus, &c.; these are all types generally accompanying the figure of Zeus on the reverse; on the obverse is the head of Hercules, which has sometimes been supposed to be that of Alexander himself. It would rather seem, however, that the conqueror's immediate successors were the first who placed their portrait on the coins, and that under a shallow pretence of deification, Lyfimachus as a descendant of Bacchus, and Seleucus of Apollo, clothed in the attributes of these deities. Two most beautiful and important series of Greek coins are those of the Seleucidæ, in Asia, of silver, and of the Lagidæ or Ptolemies, in Egypt, of gold.

In Palestine there is an interesting series of coins founded on the religious history of the Jewish nation, and assigned to Simon Maccabæus. They are shekels and half-shekels, equivalent to two Attic drachmæ and one drachma respectively. The shekels bear on the obverse the pot of manna, with the inscription 'Schekel Israel' (the Shekel of Israel); on the reverse is Aaron's rod with three flowers, and the legend 'Ierouschalim kedoschah' (Jerusalem the Holy). The inscriptions are in the Samaritan character. The successors of Simon assumed the title of king, and placed their portraits on the coins, with inscriptions in Greek as well as in Hebrew.

Roman coins belong to three different series, known as the Republican, the Family, and the Imperial.

The so-called Republican, the earliest coinage, began at an early period of Roman history, and subsisted till about 80 B. C. Its standard metal was copper, or rather *æs* or bronze, an alloy of

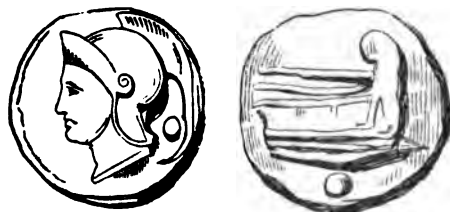

Fig. 4.

copper. The standard unit was the poundweight divided into twelve ounces. The *æs*, or *as*, or pound of bronze, is said to have received a state impress as early as the reign of Servius Tullius, 578 B. C. This gigantic piece was oblong like a brick, and stamped with the representation of an ox or sheep, whence the word *pecunia*, from *pecus*, cattle. The full pound of the *as* was gradually reduced, always retaining the twelve (nominally) uncial subdivisions, till its actual weight came to be no more than a quarter of an ounce. About the time when the *as* had diminished to nine ounces, the square form was exchanged for the circular. This large copper coin, called the '*as grave*,' was not struck with the punch, but cast, and exhibited on the obverse the Janus bifrons; and on the reverse, the prow of a ship, with the numeral I. Of the fractions of the *as*, the sextans, or sixth part, generally bears the head of Mercury, and the uncia, or ounce piece (fig. 4), that of Minerva; these pieces being further

## NUMISMATICS.

distinguished by dots or knobs, one for each ounce. There were circular pieces as high as the decussis, or piece of twelve asses, presenting a head of Roma (or Minerva), but none are known to have been coined till the weight of the as had diminished to four ounces. The Roman uncial coinage extended to the other states of Italy, where a variety of types were introduced, including mythological heads and animals. In the reign of Augustus, the as was virtually superseded by the sestertius, called by numismatists the first bronze, about the size of our penny, which was at first of the value of 2½, afterwards of 4 asses. The sestertius derived its value from the silver denarius, of which it was the fourth. The half of the sestertius was the dupondius (known as the second bronze), and the half of the dupondius was called the assarium, an old name of the as. The assarium is known to numismatists as the third bronze.

Silver was first coined at Rome about 281 B. C., the standard being founded on the Greek drachma, then equivalent in value to ten asses; the new coin was therefore called a denarius, or piece of ten asses. The earliest silver coined at Rome has on the obverse the head of Roma (differing from Minerva by having wings attached to the helmet); on the reverse is a quadriga or biga, or the Dioscuri. Among various other types which occur in the silver of the Italian towns subject to Rome are the horse's head, and galloping horse, both very beautiful. During the social war, the revolted states coined money independently of Rome, and used various devices to distinguish it as Italian and not Roman money.

The earliest gold coins seem to have been issued about 90 B. C., and consisted of the scrupulum, equivalent to 20 sestertii, and the double and treble scrupulum. These pieces bear the head of Mars on the obverse, and on the reverse an eagle standing on a thunderbolt, with the inscription 'Roma' on the exergue. The large early republican coins were cast, not struck.

The Family Coins begin about 170 B. C., and about 80 B. C. they entirely supersede the coins first described. Those families who successively held offices connected with the public mint acquired the right first to inscribe their names on the money, afterwards to introduce symbols of events in their own family history. These types gradually superseded the natural ones; the portrait of an ancestor followed; and then the portrait of a living citizen, Julius Cæsar.

Under the empire, the copper sestertius, which had displaced the as, continued the monetary standard. A magnificent series exists of the first bronzes of the emperors from Augustus to Gallienus. While it was the privilege of the emperors to coin gold and silver, copper could only be coined *ex aenatuconsulto*, which from the time of Augustus was expressed on the coins by the letters S.C., or KX S.C. The obverse of the imperial coins bears the portraits of the successive emperors, sometimes of the empress or other members of the imperial family; and the reverse represents some event, military or social, of the emperor's reign, sometimes allegorised. The emperor's name and title are inscribed on the obverse, and sometimes partly continued on the reverse; the inscription on the reverse generally relates to the subject delineated; and towards the close of the 3d c., the exergue of the reverse is occupied by the name of the town where the coin is struck. The coins of Augustus and those of Livia, Antonia, and Agrippina the Elder have much artistic merit. The workmanship of Nero's sestertii is very beautiful. The coins of Vespasian and Titus commemorate the conquest of

Judæa. The Colosseum appears on a sestertius of Vespasian. The coins of Trajan are noted for their architectural types. Hadrian's coins commemorate his journeys. The coins and medals of Antonine, Marcus Aurelius, and the two Faustinae are well executed; as are also those of Commodus, of whom a remarkable medallion relates to the conquest of Britain. There is a rapid falling off in design after the time of Commodus, and base silver comes extensively into use in the reign of Caracalla. Gallienus introduced the practice of coining money of copper washed with silver.

The colonial and provincial money of this period was very inferior to that coined in Rome. In the coins of the provinces which had been formed out of the Greek empire, the obverse bears the emperor's head, and the reverse generally the chief temple of the gods in the city of coinage; the inscriptions are in Greek. In the imperial coins of Alexandria appear such characteristic devices as the heads of Jupiter Ammon, Isis, and Canopus, the sphinx, the serpent, the lotus, and the wheat-ear. Colonial coins were at first distinguished by a team of oxen, afterwards by banners, the number of which indicated the number of legions from which the colony had been drawn.

After the time of Gallienus, the colonial money and the Greek imperial money, except that of Alexandria, ceased, and much of the Roman coinage was executed in the provinces, the name of the town of issue appearing on the exergue. Diocletian introduced a new piece of money, called the follis, which became the chief coin of the lower empire. The first bronze has disappeared after Gallienus, and the second disappears after Diocletian, the third bronze diminishing to ¼th of an ounce. With the establishment of Christianity under Constantine, a few Christian types are introduced. The third bronze of that emperor has the *Labarum* (q. v.), with the monogram IHS. Large medallions, called *contorniatii*, encircled with a deep groove, belong to this period, and seem to have been prizes for distribution at the public games. Pagan types recur on the coins of Julian; and after his time the third bronze disappears.

The money of the Byzantine empire forms a link between the subject of ancient and that of modern coins. The portrait of the emperor on the obverse is after the 10th c. supported by some protecting saint. The reverse has at first such types as Victory with a cross, afterwards a representation of the Saviour or the Virgin; in some instances, the Virgin supporting the walls of Constantinople. Latin is gradually superseded by Greek in the inscriptions, and wholly disappears by the time of Alexius I. The chief gold piece was the *solidus* or *nomisma*, which was long famed in commerce for its purity, and circulated largely in the west as well as the east of Europe.

Of the coins of the middle ages, the most important is the silver denier or penny, derived from the Latin denarius. Its half was the obole, first of silver, afterwards of billon. Coins of this description were issued in the German empire, France, England, and the Scandinavian states, and in many cases by ecclesiastical princes and feudal lords as well as sovereigns. The obverse of the regal coin of the early middle ages is generally the bust of the sovereign, and the reverse a Greek cross, accompanied by the royal name or title, and the place of mintage or the monever (see MINT). The arms of the country were introduced in the 12th c., in conjunction with the cross, and afterwards superseded it. In the 13th and 14th centuries, coins began to be issued by free imperial cities or corporations of towns; and there prevailed extensively throughout

Germany and other parts of Europe a thin piece called a bracteate, in relief on one side, and hollow on the other, often not bearing a single letter, and rarely a full inscription. Down to the 14th c., the relief of the medieval coins is very inconsiderable, the pieces thin, and the art poor.

Britain received the Roman money on its subjugation. Constantine seems to have had a mint in London, and the Roman currency continued to circulate for a time after the departure of the conquerors. The first independent coinage, however, shews hardly a trace of the influence of Rome; it consists of two small coins, called the *skeatta* and *styca*, the former of silver, the latter of copper. Both seem to belong solely to the Saxon kingdom of Northumbria; they are without inscriptions; a bird, a rude profile, and several unintelligible symbols appear on them, and their art is of the most debased kind. In the other kingdoms of the heptarchy silver pennies were coined, first intended to be  $\frac{1}{12}$ th of a pound weight; on the disappearance of *skeattas* and *stycas*, they form, with the occasional addition of halfpennies, the sole currency of England down to the reign of Edward III. The pennies of the heptarchy bear the name of the king or of the moneyer; a cross sometimes appears after the introduction of Christianity, and in later times a rude head of the king or queen. The pennies of the Saxon and Danish sole monarchs of England, have a somewhat similar character. Alfred's earlier coins have a grotesque-looking portrait, and on the reverse



Fig. 5.

a monogram of London; in his later coins the head disappears, and a cross and circle take its place. A cross, variously ornamented with three pellets in each angle, continues to be the usual reverse of the Saxon, Norman, and Plantagenet coins. The coins of Edward III are a great artistic advance on those that preceded them. The silver coinage of that king consisted not only of pennies, halfpennies, and farthings, but also of groats and half-groats. The obverse of the groat bears a conventional crowned head within a flowered circle of nine arches, the words '*Dei Gratia*' and the title '*Rex Franciæ*' appearing for the first time in the legend. The reverse has the motto '*Posui Deum adiutorem meum*,' which continued on the coinage till the time of Edward V. But the great numismatic feature of Edward III's reign is the issue of gold nobles, worth six shillings and eightpence. The obverse of those beautiful coins represent the king in a ship, a sword in his right hand, in his left a shield with the quartered arms of France and England. The reverse is a rich cross flory within a circle of eight arches, and a lion under a crown in each angle of the cross, the legend being '*Ihesus autem transiens per medium illorum ibat*.' Half and quarter nobles were also coined. The noble having increased in value, a coin called an angel, of the former value of a noble, was issued by Henry VI. and Edward IV. The obverse represented St Michael transfixing a dragon; the reverse a ship, with a cross for the mast.

As we approach the period of the Reformation, the coinage gradually becomes more ornate. The nobles coined by Edward IV., after the value

of that coin had been fixed at ten shillings, were called *rials* (a name derived from a French coin), and the double rial or sovereign was first coined by Henry VII. The obverse has the king on his throne with sceptre and orb, and on the reverse, in the centre of a heraldic full-blown rose, is a shield with the arms of France and England. The testoon, or shilling, valued at twelve pence, also first appeared in this reign, with the royal profile crowned on the obverse, and the royal arms quartered by the cross on the reverse. A great debasement of the coinage took place in the reign of Henry VIII. The reverse of the farthings of that monarch bears a portcullis, that of the shillings a rose surmounted by a crown, and of the sovereigns, the royal arms supported by a lion and dragon. A noble was coined with St George and the dragon on the obverse, and on the reverse a ship with three crosses for masts, and a rose on the centre mast. On the coins of Henry VIII the title '*Hiberniæ Rex*' first appeared, former kings having only styled themselves '*Dominus Hiberniæ*,' Ireland not being accounted a kingdom. Under Edward VI., the silver coins called crowns and half-crowns appear, having for device the king crowned on horseback in the armour of the period. They derived their name from coins circulating on the continent, which had for device a crown. The royal arms in an oval shield without the cross are introduced as the reverse of the shilling. From this period there is a very obvious decline in the artistic feeling of the English coins. On some of the shillings of Mary, her bust and that of Philip face each other, the insignia of Spain and England impaled occupying the reverse; afterwards the king's head occupies one side of the coin, and the queen's the other. Half-sovereigns, or rials, and angels were coined of the old type of Edward IV. The great event in the coinage of Elizabeth's reign was the temporary introduction of the mill and screw, instead of the hammer and punch, producing coins of a more regular and workmanlike appearance. The profile bust of James I., crowned and in armour, appears on his shillings and smaller pieces; on his crowns and half-crowns he is represented on horseback; on the reverse are the quartered arms of the three kingdoms (the harp of Ireland appearing for the first time on the coinage), with the motto '*Que Deus conjunxit nemo separat*.' Copper farthings, with crown, sceptre, and sword on the obverse, and a harp on the reverse, were coined for England as well as Ireland, the first copper money issued in England since the *styca*. Private tokens of copper, issued by tradesmen and others, had, however, been in circulation before, and came again into use to a large extent at a later period. Charles I. coined ten and twenty shilling pieces of silver, the former a very noble coin, with a representation of the king on horseback. A crown, struck at Oxford, bears on the obverse the king on horseback, with a representation of the town, and on the reverse the heads of the Oxford declaration. The guinea, first coined in this reign, was so called from the metal being procured from the coast of Guinea; its original value was but twenty shillings.

The coins of the Commonwealth exhibit a shield with the cross of St George surrounded by a palm and olive branch, and have for legend '*The Commonwealth of England*.' On the reverse are two shields accollée, with the cross of St George and the harp of Ireland, and the motto '*God with us*.' Coins far superior in character were executed by Cromwell, with his laureated bust and title as Protector, and on the reverse a crowned shield quartering the cross of St George, of St Andrew and the harp, with the Protector's paternal arms in surtout; but few of these were issued. In the early

coins of Charles II., that monarch is crowned, and in the dress of the time; in his later money he is in conventionalised Roman drapery, with the head turned to the left, and from that time it has been the practice to turn every king's head the reverse way from that of his predecessor. The four shields on the reverse are disposed in the form of a cross (an arrangement which continued till the reign of George II.), and on the edge of the crowns and half-crowns is the legend 'Decus et tutamen.' Charles II. issued a copper coinage of halfpennies and farthings; on the former appears the device of Britannia, taken from the Roman coins relating to Britain. Pennies were not coined till George III.'s reign. The coins of William and Mary have the profiles of the king and queen one over the other, and the shields of the three kingdoms in the form of a cross on the reverse, with Nassau in the centre. The coinage of William alone, after the death of Mary, is of somewhat improved design, Sir Isaac Newton being then Master of the Mint. Little change in the general design of the coin occurs in the reigns of Anne and George I. On the accession of the House of Hanover, the Hanoverian arms are placed in the fourth shield, and George IV. substituted a quartered shield with Nassau en surtout for the four shields on the reverse of his gold coins. During the greater part of George III.'s reign the coinage was utterly neglected, and the silver pieces in circulation were worn perfectly smooth. When coins were at last issued, the Roman conventionalism of the previous reigns gave way to a now fashionable Greek conventionalism. The quartered shield supplanted the four shields, and on the reverse of the crown appeared a Grecianised St George and the dragon. George IV.'s bust is taken from Chantrey's statue; the rose, thistle, and shamrock, united under a crown, appear on the reverse of his shilling. Silver groats were issued in the reign of William IV. The ensigns of Hanover disappeared at the beginning of the present reign; the reverse of the shilling is even poorer than that of George IV., the words 'One shilling' occupy the field, surrounded by an oak branch and a laurel branch; silver pieces of three-pence have been introduced. But the principal monetary event is the issue of the silver florin, in value equivalent to two shillings, looked on as a step towards the institution of a decimal coinage. It represents the head of the Queen crowned, with the legend in old English character, and for reverse the four shields are once more placed in the form of a cross.

No native Scottish coinage existed earlier than the 11th century. Coins are extant of Somerled, prince of the Isles of that century, and of Alexander I. of the century following. The silver pennies of William the Lion, and Alexander II. and III., are like contemporary English money, but ruder, and bear the names of the moneymen and place of mintage, generally Edinburgh, Perth, or Berwick. The profiles on the coins of John Baliol, Robert Bruce, and David II. are attempts at portraiture. A remarkable gold piece, first coined by Robert II., is the St Andrew, with the arms of Scotland on the obverse, and St Andrew on his cross on the reverse. In the four succeeding reigns the weight of the silver coins rapidly decreased, and coins of billon, or base metal, were issued, nominally pennies, but three and a half of which eventually passed for a silver penny. The evil increased, and baser and baser alloy was used. Groats of billon, known as placks and half-placks, were coined by James III. James IV.'s coins have a characteristic portrait, and a good deal of artistic feeling. James III. and IV. issued well-executed gold pieces, called unicorns and riders, the type of

the one being the unicorn, of the other the king on horseback. A still more beautiful coin was the gold bonnet piece of James V., so called from the cap in the king's portrait. Of Mary, there are a great variety of interesting pieces. The portrait is sometimes crowned, sometimes uncrowned, and on the coin issued soon after Francis's death, has a widow's cap and high-frilled dress. The types in James VI.'s reign are also very various. On his accession to the English throne, the relative value of English and Scottish coins was declared to be as 12 to 1. The coins afterwards issued from the Scottish mint differed from the English, chiefly in having Scotland in the first quarter in the royal shield. The last Scottish gold coinage consisted of pistoles and half-pistoles of Darien gold, about the size of a guinea and half-guinea, struck by William III.; the pistole distinguished by a rising sun under the bust of the king.

The coinage of Ireland is scanty and uninteresting compared with that of Scotland. The coins of English monarchs struck in Dublin resemble much those current in England. Henry VIII. first placed a harp on the Irish coins.

In France, the earliest coins are those of the Merovingian kings, rude imitations of the late Roman and early Byzantine money, and mostly of gold. Under the Carlovingian dynasty, deniers and oboles are the prevailing coinage, remarkably rude in fabric, without portrait, and bearing the name of the king and place of mintage. Some coins of Charlemagne, struck at Rome, are of better workmanship. They contain one letter of 'Roma' at each extremity of the cross, with the legend 'Carolus IP.' The coinage improved under the Capetian kings; the fleur-de-lis appears in addition to the cross. In the 13th c. gold pieces were issued, and in the time of Philip VI. both the design and the execution of the coins are beautiful. The coins of Louis XII. are the first that bear the royal portrait. The modern coinage may be said to begin under Henry II., whose portrait is good. The seigniorial coins of France in the middle ages are of considerable importance, and the medals of Louis XIV. and Napoleon I. are much more interesting than the modern coins.

The medieval coinage of Italy is of great interest. The money of the Lombard kings of Italy and Dukes of Benevento, is little inferior to that of the Greek emperors. There is a beautiful series of gold and silver pieces belonging to Venice, bearing the names of the doges, and having generally for type the doge receiving the gonfalon, or standard of St Mark. The gold florins of Florence, with the lily for device, are no less celebrated, and were imitated by other states. Florence had also a remarkable series of medals, with admirable portraits of persons of note. The coins of the popes, from Hadrian I. down to the 14th c., bear the name of the pope and emperor of the west; those of later date are beautiful in execution, and have seated portraits of the pontiffs, with the cross-keys and mitre for reverse. A remarkable series of medals commemorates the chief events of each reign, one of which, struck after the massacre of St Bartholomew, has for type an angel slaying the Huguenots, and the inscription 'Ugonotterum strages.' The coins of the Norman princes of Naples struck in Sicily, have the legends partly or wholly in Arabic. Malta has a series, with the arms and effigies of the grand-masters.

The medieval money of Germany comprises coins of the emperors, the electors, the smaller princes, the religious houses, and the towns. The imperial series is extensive and very interesting, though, till near the close of the middle ages, it is rather backward in its art. About the Reformation period,

however, there are vigorous portraits both on its current coins and on the medals, and those double dollars which are virtually medals. The coins of the Dukes of Saxony, with their portraits, are equally remarkable. The coins of the archbishops of Cologne, Mainz, and Treves form a very interesting series, the first more especially, with a representation of the cathedral.

The coins of the Low Countries resemble those of France and Germany. The Dutch medals are of interest, more especially those struck in commemoration of events in the war with Spain.

The coins of the Swiss cantons and towns during the early period of Swiss independence bore the heraldic shield of each, drawn with vigorous grotesqueness. There are also pieces struck by ecclesiastical lords, and by different families who had a right of coinage.

The coins of Spain begin with those of the Gothic princes, which are chiefly of gold, and on the model of the trientes and semisses of the lower empire. Some of the early pieces have a rude head of the monarch on one side, and of the emperor on the other. Afterwards, the obverse bears the profile of the monarch, and the reverse a cross of some description, with the name of the place of mintage, and the word 'Pius' for legend. In later times, there are two interesting series of coins belonging to the kingdom of Aragon and to the kingdom of Castile and Leon.

The coinages of Norway and Sweden at first resembled the British, and afterwards the German type. From the 10th to the 14th c., bracteates were issued by the ecclesiastics. The coinage of Hungary begins in the 11th c., and has the portraits of the monarchs. The Russian coinage is Byzantine in character, and rude in its art. The earliest pieces are the silver darga of the 14th c., of an oblong shape, with representations of the prince on horseback, and various legendary subjects. Peter the Great introduced the usual European type. There is an important series of bronze coins of the Crusaders, beginning with Tancred, and coming down to the end of the 15th c., including money of the kings of Cyprus and Jerusalem, and other princes established in the east.

In India, the succession of the kings of Bactria, the remotest of the dynasties founded on the ruins of Alexander's empire, has only become known through their recently-discovered coins. There are early rude Hindu coins of the Gupta line, with figures of the Brahminical divinities of a type still in use.

Of the coins of the Mohammedan princes, the oldest gold pieces are the bilingual coins of cities of Syria and Palestine, of the middle of the 7th c. (A. H. 78), barbarous imitations of the latest Byzantine money of Alexandria. Most of the Mohammedan coins are covered exclusively by inscriptions expressive of the elementary principles of the Mohammedan faith. For some centuries, no sovereign except the calif was allowed to inscribe his name on the coin. Large gold coins of great purity were issued by the Moslem kings of Granada in Spain.

The high prices given for ancient coins have led to numerous forgeries from the 15th c. downwards. Against such imitations, collectors require to be on their guard.

Among the best works on numismatics are Eckhel, *Doctrina Numorum Veterum* (Vienna, 1792—1798); Hennis, *Manuel de Numismatique Ancienne* (Paris, 1830); Grasset, *Handbuch der alten Numismatik* (Leipzig, 1852—1853); Leake, *Numismata Hellenica* (London, 1854); Ruding's *Annals of*

*the Coinage of Great Britain* (London, 1840); Lindsay's *View of the Coinage of Scotland* (Cork, 1845); Leblanc, *Traité Historique des Monnoies de France* (Paris, 1690); Cappe, *Die Münzen der Deutschen Kaiser und Könige des Mittelalters* (Dresden, 1848—1850); Marsden, *Numismata Orientalia Illustrata* (London, 1823—1825).

**NUMMULITE LIMESTONE**, an important member of the Middle Eocene period, consisting of a limestone composed of nummulites held together by a matrix formed of the comminuted particles of their shells, and of smaller foraminifera. It forms immense masses of the strata which are raised up on the sides of the Alps and Himalayas, and may be traced as a broad band often 1800 miles in breadth, and frequently of enormous thickness, from the Atlantic shores of Europe and Africa, through Western Asia, to Northern India and China. It is known also to cover vast areas in North America.

**NUMMULITES**, or **NUMMULINA** (Gr. money-fossil), a genus of fossil foraminifera, the shells of which form immense masses of rock of Eocene age. See **NUMMULITE LIMESTONE**. Upwards of 50 species have been described. They are circular bodies of a lenticular shape, varying in magnitude from the merest point to the size of a crown-piece. The shell is composed of a series of small chambers arranged in a concentric manner. The growth of the shell does not take place only around the circumference, but each whorl invests all the preceding whorls, so as to form a new layer over the entire surface of the disk, thus adding to the thickness as well as the breadth, and giving the fossil its lenticular form. A thin intervening space separates each layer from the one which it covers, and this space at the margin swells out to form the chamber. All the internal cavities, however, seem to have been occupied with the living sarcode, and an intimate connection was maintained between them by means of innumerable parallel tubuli, which everywhere pass from one surface to another, and which permitted the passage of the sarcode as freely as do the minute pores or foramina of the living foraminifera.

The name is given to them from their resemblance to coins. In Egypt, where the whole of the Mokkadam Mountains, from the stone of which the pyramids were built, is formed of them, they are called by the natives 'Pharaoh's Pence.'

**NUN**, a member of a religious order of women. The etymology of this name is a subject of some controversy, but there seems every reason to believe that it is from a Coptic or Egyptian root, which signifies 'virgin.' It is found in use as a Latin word as early as the time of St Jerome (*Ep. to Eustachius*, p. 22, c. 6). The general characteristics of the religious orders will be found under the head **MONACHISM** (q. v.), and under those of the several orders. It is only necessary here to specify a few particulars peculiar to the religious orders of females. Of these the most striking perhaps is the strictness in the regularly authorised orders of nuns of the 'cloister,' or enclosure, which no extern is ever permitted to enter, and beyond which the nuns are never permitted to pass, without express leave of the bishop. The superiors of convents of nuns are called by the names Abbess, Prioress, and, in general, Mother Superior. They are, ordinarily speaking, elected by chapters of their own body, with the approval of the bishop, unless the convent be one of the class called exempt houses, which are immediately subject to the authority of the Holy See. The ceremony of the solemn blessing or inauguration of the abbess is reserved to the bishop, or

to a priest delegated by the bishop. The authority of the abbess over her nuns is very comprehensive, but a precise line is drawn between her powers and those of the priestly office, from which she is strictly debarred. The name of nun is given in general to the sisters of all religious congregations of females who live in retirement and are bound by rule; but it is primitively and properly applicable only to sisters of the religious orders strictly so called. See MONACHISM.

**NUNC DIMITTIS**, the name given to the canticle of Simeon (Luke ii. 29—32), which forms part of the compline office of the Roman Breviary, and is retained in the evening service of the Anglican Church when it follows the second lesson. On the great festivals in Lent, the music of this canticle is especially grand and imposing.

**NU'NCIO** (Ital. *nunzio*, Lat. *nunci*, a messenger), the name given to the superior grade of the ambassadors sent by the pope to foreign courts, who are all called by the general name of **LEGATE** (q. v.). A nuncio is an ambassador to the court of an emperor or king. The ambassador to a republic, or to the court of a minor sovereign, is called **INTER-NUNCIO**.

**NUNCUPATIVE WILL** is a will made by word of mouth. As a general rule, no will is valid unless it is in writing and signed by the testator; but in cases of soldiers and sailors, a verbal or nuncupative will is held to be good, on the ground that there is often no time to draw up a formal will in writing.

**NUNEATON**, a small market-town of England, in the county of Warwick, and 18 miles north-east of the town of that name. It contains a small parish church in Gothic, and its Free Grammar School, founded by Edward VI. in 1553, has an annual income from endowment of about £300. Manufactures of ribbons and cotton goods are carried on. Pop. (1861) 4645.

**NU'NQAM INDEBITATUS**, in English Law, means a plea or defence to an action for a debt that the defendant never was indebted; in other words, that no debt is due.

**NURAGHE**, the name of certain structures, of conical shape, in the island of Sardinia, rising 30 or 40 feet above the ground, with two or three stories of domed chambers connected by a spiral staircase.



View of the Nuraghe of Goni, in Sardinia.

Some are raised on basements of masonry, or platforms of earth. They are made of granite limestone, basalt, porphyry, sandstone, and schist. Their entrances are small and low, and when they have

chambers of two stories, the upper chamber is reached by the spiral staircase which has loopholes to admit the light. The tops are supposed to have had a terrace. Although 3000 of them exist, none are perfect. Their masonry is irregular, but not polygonal, and resembles the style of work called

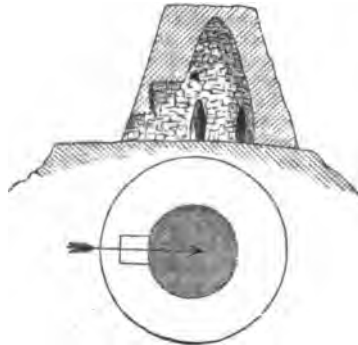

Plan and Elevation of the Nuraghe of Goni, in Sardinia.

Asiatic. Like the round towers of Ireland, and other uninscribed monuments, their object and antiquity are enveloped in much doubt. They have been supposed to be the work of the Pelasgi, the Phœnicians, or Carthaginians, and to have been ancient sepulchres, *Thols* or *Daedalia*, constructed in heroic times. Skeletons, and other funeral paraphernalia, have been found in them. They have many points of resemblance to the 'Burghs' or 'Duns' on the northern shores of Scotland, of which the Burgh of Mousa, in Shetland, is perhaps the best example.—De la Marmor, *Voyage en Sardaigne*, tom. ii.; Petit Radel, *Nuraghes* (Paris, 1826—1828); Micali, *Ant. Pop. Ital.* ii. p. 43; Dennis, *Cities and Cem. of Etruria*, ii. p. 161.

**NÜ'RNBERG** (*Norimberga*, *Norica*), a fortified city of the Bavarian province of Middle Franconia, situated in 49° 28' N. lat., and 11° 5' E. long. Population, at the close of 1861, 62,797. N. is one of the most remarkable and interesting cities of Germany, on account of the numerous remains of mediæval architecture which it presents in its picturesque streets, with their gabled houses, stone balconies, and quaint carvings. No city retains a stronger impress of the characteristics which distinguished the wealthy burgher-classes in the middle ages, while its double lines of fortified walls, separated from each other by public walks and gardens, and guarded by 70 towers, together with the numerous bridges which span the Pegnitz, on whose banks the city is built, give it distinctive features of its own. Among the most remarkable of its numerous public buildings are the old palace or castle, commanding, from its high position, a glorious view of the surrounding country, and interesting for its antiquity, and for its gallery of paintings, rich in gems of early German art; the town-hall, which ranks amongst the noblest of its kind in Germany, and is adorned with works of Albert Dürer, and Gabriel Weyher; the noble Gothic fountain opposite the cathedral by Schonhofer, with its numerous groups of figures, beautifully restored in modern times; and many other fountains deserving notice. Of the numerous churches of N., the following are the most remarkable: St Lawrence, built between 1270—1478, with its beautiful painted-glass windows, its noble towers and doorway, and the celebrated stone pyx, completed in 1500, by Adam Kraft, after five years' assiduous labour; and the



exquisite wood-carvings of Veit Stoss; St Sebald's, with its numerous fine glass-paintings and frescoes by Peter Visscher and other German masters; the cathedral, or Our Lady's, built in 1631, similarly enriched. N. is well provided with educational establishments, and besides a good gymnasium and polytechnic institution, has good schools of art, normal and other training colleges, a public library of 50,000 vols., galleries of art collections, museums, &c.; while the numerous institutions of benevolence are liberally endowed and well maintained. Although the glory of the foreign commerce of N. may be said to have been long extinct, its home trade, which is still of considerable importance, includes the specialities of metal, wood and bone carvings, and children's toys and dolls, which find a ready sale in every part of Europe, and are largely exported to America and the East. In addition to its own industrial commerce, is the seat of a large transfer and exchange business, which owes much of its importance to the facilities of intercommunication afforded by the net-work of railway lines with which the city is connected.

N. was raised to the rank of a free imperial city by the Emperor Henry V., in 1219, previous to which time, Henry IV. had ennobled 38 of the principal burgher families, who forthwith arrogated to themselves supreme power over the N. territory. In the 13th c., we find it under the title of a burgraviate in the hands of the Hohenzollern family, who, in 1417, ceded for a sum of money all their territorial and manorial rights to the magistracy of the city. This measure put a stop to the feuds which had hitherto raged between the burgraves and the municipality, and for a time N. continued to grow rich with the fruits of the great internal trade, which it had long maintained between the traders of the East and the other European marts of commerce. The discovery of the passage by the Cape of Good Hope, by opening new channels of communication between Asia and Europe, deprived N. of its ancient monopoly. The Thirty Years' War completed the decay of the city, which suffered severely from both parties in turn. The ancient reputation of N. as a wealthy and loyal city of Germany secured to it, however, special consideration; and in 1806, when the imperial commissioners reorganised some of the dismembered parts of the old empire, it was allowed to retain its independence, with a territory of 483 square miles, containing 40,000 inhabitants, and drawing a revenue of 800,000 gulden; but in consequence of the disputes in which the free city became involved with the king of Prussia, who had some hereditary claim on the ancient burgraviate, N., alarmed at the prospect of still greater embarrassments, entered into the Rhenish Confederation, and as the result of this alliance, was transferred, in 1806, with the surrender of its entire domain and all rights of sovereignty, to the king of Bavaria.

**NURSE, MILITARY.** In continental armies, the 'sisters of charity' usually carry their mission of mercy into the military hospitals. Protestant England having no such organisation to fall back upon, the soldiers have been dependent on the regular male hospital attendants for their care during sickness, or when suffering from wounds. The Crimean campaign, however, disclosed so melancholy a picture of the want of women's co-operation, that a band of self-sacrificing ladies, headed by Miss Nightingale (q. v.), proceeded to Turkey, and were soon acknowledged as messengers of health and life by the unfortunate wounded. This experience has been turned to account, and a staff of female nurses has been organised, under the control of a lady styled the Superintendent General of Army

Nurses, who take care of the sick in their wards in Military Hospitals.

**NURSERY,** a garden or portion of a garden devoted to the raising of young plants, to be afterwards planted elsewhere. The ripening of garden-seeds for sale is generally also an important part of the trade of the public nurseryman. Many culinary vegetables are very commonly raised from seed in public nurseries, and sold as young plants; the trouble of raising them in small gardens being found too great, although, when there is no public nursery at hand, even the cottage-gardener may be compelled to undertake this trouble for himself, in order to procure a supply of young kale, cabbage, cauliflower, &c., in fresh and healthful condition. Many flowering plants, as wallflower, stock, sweet-william, &c., are also raised and sold by nurserymen. Another great use of the nursery is the rearing of fruit-trees. In the nursery, the stocks are raised from seed, the grafting is performed, and the training of the young tree, whether for standard, espalier, or wall tree, is begun. As, with regard to fruit-trees, the selection of grafts is of the utmost importance, the reputation of the nurseryman is particularly to be considered by the purchaser; nor is there any trade in which this is more generally necessary, months, or sometimes years elapsing before the quality of the goods purchased can be experimentally ascertained. The principal, and many of the smaller towns of Britain are well supplied with public nurseries, which is the case also in many countries of continental Europe and in North America. Some of these nurseries are on a very great scale, as those of Messrs Loddige of London, Lawson of Edinburgh, and Booth of Hamburg. The largest nurseries, however, are very much devoted to the rearing of ornamental shrubs and trees, and of forest-trees. Plantations of forest-trees, even when very extensive, are now generally, although not always, made with plants obtained from public nurseries. The exertions made by nurserymen to obtain new plants from foreign countries, have contributed much, not only to the advancement of gardening in its various departments, and of arboriculture, but also of botany.—Much benefit also results from the exchange of the produce of the nurseries of different countries. Thus, bulbous roots are brought to Britain from Holland, from what may be described as nurseries specially devoted to them; roses and orange-trees are imported from the nurseries of France, &c. It often happens that seeds imported from climates more thoroughly adapted to the plants, produce better crops than those raised in a colder climate or under a cloudier sky.

**NUT,** in popular language, is the name given to all those fruits which have the seed enclosed in a bony, woody, or leathery pericarp, not opening when ripe. Amongst the best known and most valuable nuts are the Hazel-nut, Brazil nut, Walnut, Chestnut, and Cocoa-nut, all of which are edible. Other nuts are used in medicine, and for purposes connected with the arts. Some of the edible nuts abound in a bland oil, which is used for various purposes.—In Botany, the term nut (*nux*) is used to designate a one-celled fruit, with a hardened pericarp, containing, when mature, only one seed. The *Achenium* (q. v.) was by the older botanists generally included in this term. Some of the fruits to which it is popularly applied scarcely receive it as their popular designation. The hazel-nut is an excellent example of the true nut of botanists.—The name nut, without distinctive prefix, is popularly given in Britain to the hazel-nut, but in many parts of Europe to the walnut.

## NUTATION—NUT-HATCH.

Many nuts have a considerable commercial value, from their being favourite articles of food: these are the Hazel-nut and its varieties, the Black Spanish, the Barcelona, the Smyrna, the Jerusalem filbert, and the common filbert; the Walnut, Chestnut, Hickory, and Pecan; the Souari, the Cocoa or Coker nuts, and the Brazil or Para nut.

The Barcelona and Black Spanish, as their names imply, are from Spain; the former is the commonest nut of our shops. About 120,000 bags, averaging 1½ bushel each, or 150,000 bushels, are annually imported into Great Britain. The import value is about 33s. per bag. They are always kiln-dried when we receive them. This is not the case with the black Spanish, of which only about 12,500 three-bushel bags, or about 37,000 bushels, are imported in the beginning of the season, when their value is about 14s. per bushel. From the Black Sea we receive annually about 68,000 bushels of hazel-nuts, worth 10s. per bushel, with from 500 to 1000 bags of the so-called Jerusalem and Mount Atlas filberts. Of chestnuts from Leghorn, Naples, Spain, France, and Portugal, we receive annually about 20,000 bushels. The trade in walnuts is very uncertain, and probably never exceeds 5000 bushels. Of the curious three-cornered or Brazil nut from Para and Maranh, the importation is also very irregular, varying from 300 to 1000 tons, or 1200 to 4000 bushels per annum. About two millions of cocoa-nuts are also imported. The other kinds of nuts are too irregular in their importations to supply any reliable statistics. The annual value of all the nuts imported for use as fruit is computed at about £153,000.

**NUTATION** is a slight oscillatory movement of the earth's axis, which disturbs the otherwise circular path described by the pole of the earth round that of the ecliptic, known as the 'precession of the equinoxes.' It is produced by the same causes, viz. the attraction of the sun, moon, and planets (the attraction of the last mentioned being so small as to be quite imperceptible) upon the bulging zone about the earth's equator, though in this case it is the moon alone that is the effective agent. It also, for reasons which need not be given here, depends, for the most part, not upon the position of the moon in her orbit, but of the moon's node. If there was no precession of the equinoxes, nutation would appear as a small elliptical motion of the earth's axis, performed in the same time as the moon's nodes take to complete a revolution, the axes of the ellipse being respectively 18"·5 and 13"·7, the longer axis being



directed towards the pole of the ecliptic. But this motion, when combined with the more rapid one of precession, causes the pole of the earth's axis to describe a wavy line round P, the pole of the ecliptic.

The effect of nutation, when referred to the equator and ecliptic, is to produce a periodical change in the obliquity of the ecliptic, and in the velocity of retrogradation of the equinoctial points. It thus gives rise to the distinction of 'apparent'

from 'mean' right ascension and declination, the former involving, and the latter being freed from the fluctuations arising from nutation. This motion is common to all the planets.

**NUT-CRACKER** (*Nucifraga* or *Caryocatactes*), a genus of birds of the family *Corvidæ*, with a straight conical bill, both mandibles terminating in an obtuse point, and tail nearly square at the end. The form and characters are nearly similar to those of crows, but the habits are rather those of jays, and in some respects indicate an approach to woodpeckers. One species (*N. caryocatactes*) or



Clark's Nut-cracker (*Nucifraga Clarkii*).

*C. nucifraga*) is occasionally seen in Britain, and is not uncommon in many parts of Europe and of Asia, particularly in mountainous regions covered with pines. It is about the size of a jackdaw, but has a longer tail. The plumage is light brown, speckled with white, except on the wings, rump, and tail, which are nearly black. The *N.* frequents the tops of high pines, and is a shy bird.

**NUT-HATCH** (*Sitta*), a genus of birds of the family *Certhiadae*, having a straight conical or pris-



European Nut-hatch (*Sitta Europaea*).

matic bill, short legs, the hind-toe very strong. They run up and down trees with great agility, moving with equal ease in either direction, and without hopping, so that the motion is rather like that of a mouse than of a bird. They feed on insects, in pursuit of which they examine the crevices, and remove the scales of the bark; also on seeds, as those of pines, and the kernels of nuts, to obtain which they fasten the nut firmly in some crevice

## NUTMEG—NUTRITION.

of bark or other such situation, and peck at it until the shell is broken, so placing themselves that they sway not merely the head, but the whole body, to give force to the stroke. The English name is said to have been originally *Nut-hack*. One species, the EUROPEAN N. (*S. Europæa*), is common in most parts of Europe, and is found in most of the wooded districts of England. Its whole length is about six inches. If taken young, it is easily tamed, and becomes very familiar and amusing; but an old bird caught and put into a cage, is apt to kill itself by violently pecking to force a way out. It soon destroys the wood of a cage.—Other species are found in the East and in North America, where the genus is particularly abundant. Birds nearly allied are found in Australia.

**NUTMEG.** This well-known and favourite spice is the kernel—mostly consisting of the albumen—of the fruit of several species of *Myristica*. This genus belongs to a natural order of exogens called *Myristicaceæ*, which contains about forty species, all tropical trees or shrubs, natives of Asia, Madagascar, and America. They generally have red juice, or a juice which becomes red on exposure to air. The order is allied to *Lauraceæ*. The leaves are alternate and without stipules. The flowers are unisexual, the perianth generally trifold, the filaments united into a column. The fruit is succulent, yet opens like a capsule by two valves. The seed is nut-like, covered with a lacinated fleshy aril, and has an albumen penetrated by its membranous covering. The species of this order are generally more or less aromatic in all their parts; their juice is styptic and somewhat acid; the albumen and aril contain both a fixed and an essential oil, and those of some species are used as spices. The genus *Myristica* has the anthers united in a cylindrical



Nutmeg (*Myristica moschata*):

A branch shewing fruit, and section of fruit, with nutmeg enclosed.

column, and the cotyledons folded. The species which furnishes the greater part of the nutmegs of commerce is *M. fragrans* or *moschata*; but the long N. (*M. fatua*), from the Banda Isles, is now not uncommon in our markets. The common N.-tree is about 25 feet in height, with oblong leaves, and axillary few-flowered racemes; the fruit is of the size and appearance of a roundish pear, golden yellow in colour when ripe. The fleshy part of the fruit is rather hard, and is of a peculiar consistence, resembling candied fruit; it is often

preserved and eaten as a sweetmeat. Within is the nut, enveloped in the curious yellowish-red aril, the *Mace* (q. v.), under which is a thin shining brown shell, slightly grooved by the pressure of the mace, and within is the kernel or nutmeg. Up to 1796, the Dutch being the possessors of the Banda Isles, jealously prevented the N. from being carried in a living state to any other place; but during the conquest and retention of the islands by the British, care was taken to spread the culture of this valuable spice, and plants were sent to Penang, India, and other places, where they are now successfully cultivated; indeed, they have now become established in the West India Islands, and both Jamaica and Trinidad produce excellent nutmegs. Brazil is also found favourable to their culture. The N. is very liable to the attack of a beetle, which is very destructive, and it is a common practice to give them a coating of lime before shipping them to Europe, in order to protect them from its ravages. The Dutch or Batavian nutmegs are nearly always limed, but those from Penang are not, and are consequently of a greater value. The N. yields, by expression, a peculiar yellow fat, called oil of mace, because, from its colour and flavour, it was generally supposed to be derived from mace; and by distillation is obtained an almost colourless essential oil, which has very fully the flavour of the nutmeg. Her own settlements now furnish Great Britain with the greater portion of this spice, but some lots of Batavian also come into the market. The quantity imported last year was nearly 300,000 pounds' weight, worth, in round numbers, £70,000.

Nutmegs are chiefly used as a spice; but medicinally they are stimulant and carminative. They possess narcotic properties, and in large doses produce stupefaction and delirium, so that they ought not to be used where affections of the brain exist or are apprehended.

Other species of *Myristica*, besides those already named, yield nutmegs sometimes used, but of very inferior quality.—The fruits of several species of *Lauraceæ* also resemble nutmegs in their aromatic and other properties; as the cotyledons of *Nectandra Puchury*, the Pichurim Beans of Commerce, and the fruit of *Acrodididium camara*, a tree of Guiana, the Camara or Ackawai nutmeg. The clove nutmegs of Madagascar are the fruit of *Agathophyllum aromaticum*, and the Brazilian nutmegs of *Cryptocarya moschata*. All these belong to the order *Lauraceæ*. The Calabash N. is the fruit of *Monodora myristica*, of the natural order *Anonaceæ*.

**NUTRIA.** See COYPU and RACOONDA.

**NUTRITION.** The blood which is carried by the capillaries to the several tissues of the body is the source from whence all the organs derive the materials of their growth and development; and it is found that there is direct proportion between the vascularity of any part and the activity of the nutrient operations which take place in it. Thus, in nervous tissue and muscle, in mucous membrane and in skin, a rapid decay and renovation of tissue are constantly going on, and these are parts in which the capillaries are the most abundant; while in cartilage and bone, tendon and ligament, the disintegration of tissue is comparatively slow, and the capillaries are much less abundant. Each elementary cell or particle of a tissue seems to have a sort of gland-like power not only of attracting materials from the blood, but of causing them to assume its structure, and participate in its properties. Thus, from the same common source, nerves form nervous tissue, muscles muscular substance, and even morbid growths, such as cancer, have an assimilating power.

## NUTRITION.

Before entering further into the subject of nutrition, it is necessary to understand how it differs from the allied processes of development and growth. All these processes are the results of the plastic or assimilative force by which living bodies are able to form themselves from dissimilar materials (as when an animal subsists on vegetables, or when a plant grows by appropriating the elements of water, carbonic acid, and ammonia); but they are the results of this force acting under different conditions.

Development is the process by which each tissue or organ of a living body is first formed, or by which one, being already incompletely formed, is so changed in shape and composition, as to be fitted for a function of a higher kind, or finally is advanced to the state in which it exists in the most perfect condition of the species.

Growth, which commonly concurs with development, and continues after it, is properly mere increase of a part by the insertion or superaddition of materials similar to those of which it already consists. In growth, properly so called, no change of form or composition occurs; parts only increase in weight, and usually in size; and if they acquire more power, it is only more power of the same kind as that which they before enjoyed.

Nutrition, on the other hand, is the process by which the various parts are maintained in the same general conditions of form, size, and composition, which they have already by development and growth attained. It is by this process that an adult person in health maintains for a considerable number of years the same general outline of features, and nearly the same size and weight, although during all this time the several tissues of his body are undergoing perpetual decay and renovation. In many parts, this removal and renewal of the particles is evident. In the glands—the Kidneys (q. v.), for example—the cells of which they are mainly composed are being constantly cast off; yet each gland maintains its form and proper composition, because for every cell that is thrown off, a new one is produced. In the epidermis of the skin, a similar process is perpetually going on before our eyes. In the muscles, a similar change may be readily traced, for, within certain limits, an increased amount of exercise is directly followed by an increased excretion of the ordinary products of the decomposition of the nitrogenous tissues—viz. urea, carbonic acid, and water. Again, after prolonged mental exertion, there is often a very marked increase in the amount of alkaline phosphates in the urine, which seems to show that in these cases there is an excessive oxidation of the phosphorus of the brain; and yet, in consequence of the activity of the reparative process, neither the muscles nor the brain diminish in size.

It may be regarded as an established fact in physiology, that every particle of the body is formed for a certain period of existence in the ordinary conditions of active life, at the end of which period, if not previously destroyed by excessive exercise, it is absorbed or dies, and is cast off. (The hair and deciduous or milk teeth afford good illustrations of this law.) The less a part is exercised, the longer its component particles appear to live. Thus, Mr Paget found that, if the general development of the tadpole be retarded by keeping it in a cold, dark place, and if hereby the functions of the blood corpuscles be slowly and imperfectly discharged, the animal will retain its embryonic state for several weeks longer than usual, and the development of the second set of corpuscles will be proportionally postponed, while the individual life of

the corpuscles of the first set will be, by the same time, prolonged.

For the due performance of the function of nutrition, certain conditions are necessary, of which the most important are—1, a right state and composition of the blood, from which the materials of nutrition are derived; 2, a regular and not far distant supply of such blood; 3, a certain influence of the nervous system; and 4, a natural state of the part to be nourished.

1. There must be a certain adaptation peculiar to each individual between the blood and the tissues. Such an adaptation is determined in its first formation, and is maintained in the concurrent development and increase of both blood and tissues. This maintenance of the sameness of the blood is well illustrated by the action of vaccine matter. By the insertion of the most minute portion of the virus into the system, the blood undergoes an alteration which, although it must be inconceivably slight, is maintained for several years; for even very long after a successful vaccination, a second insertion of the virus may have no effect, because the new blood formed after the vaccination continues to be made similar to the blood as altered by the vaccine matter. So, in all probability, are maintained the morbid states of the blood which exist in syphilis and many other chronic diseases; the blood once inoculated, retaining for years the taint which it once received. The power of assimilation which the blood exercises in these cases is exactly comparable with that of maintenance by nutrition in the tissues; and evidence of the adaptation between the blood and the tissues, and of the delicacy of the adjustment by which it is maintained, is afforded by the phenomena of symmetrical diseases (especially of the skin and bones), in which, in consequence of some morbid condition of the blood, a change of structure affects in an exactly similar way the precisely corresponding parts on the two sides of the body, and no other parts of even the same tissue. These phenomena (of which numerous examples are given in two papers by Dr W. Budd and Mr Paget in the 25th volume of the *Medico-chirurgical Transactions*) can only be explained on the assumption—1st, of the complete and peculiar identity in composition in corresponding parts of opposite sides of the body; and 2dly, of so precise and complete an adaptation between the blood and the several parts of each tissue, that a morbid material being present in the blood, may destroy its fitness for the nutrition of one or two portions of a tissue, without affecting its fitness for the maintenance of the other portions of the same tissue. If, then, the blood can be fit for the maintenance of one part, and unfit for the maintenance of another part of the same tissue (as the skin or bone), how precise must be that adaptation of the blood to the whole body, by which in health it is always capable of maintaining all the different parts of the numerous organs and tissues in a state of integrity.

2. The necessity of an adequate supply of appropriate blood in or near the part to be nourished, is shewn in the frequent examples of atrophy of parts to which too little blood is sent, of mortification when the supply of blood is entirely cut off, and of defective nutrition when the blood is stagnant in a part. The blood-vessels themselves take no share in the process, except as the carriers of the nutritive matter; and provided they come so near that the latter may pass by imbibition, it is comparatively unimportant whether they ramify within the substance of the tissue, or (as in the case of the non-vascular tissues, such as the epidermis, cornea, &c.) are distributed only over its surface or border.

3. Numerous cases of various kinds might be

readily adduced to prove that a certain influence of the nervous system is essential to healthy nutrition. Injuries of the spinal cord are not unfrequently followed by mortification of portions of the paralysed parts; and both experiments and clinical cases shew that the repair of injuries takes place less completely in parts paralysed by lesion of the spinal cord than in ordinary cases. Division of the trunk of the trifacial nerve has been followed by incomplete nutrition of the corresponding side of the face, and ulceration of the cornea is a frequent consequence of the operation.

4. The fourth condition is so obvious as to require no special illustration.

For further information on this most important department of physiology, the reader is referred to Mr Paget's *Surgical Pathology*, or to his original lectures on Nutrition, Hypertrophy, and Atrophy (published in volume 39 of *The Medical Gazette*), or to the chapter on 'Nutrition and Growth,' in Kirkes's *Handbook of Physiology*, which contains an excellent abstract of Mr Paget's views, and to which we are indebted for the greater part of this article.

**NUX VOMICA** is the pharmacopœial name of the seed of *Strychnos Nux Vomica*, or *Poison Nut*. The following are the characters of these seeds, which are imported from the East Indies: 'Nearly circular and flat, about an inch in diameter, umbilicated and slightly convex on one side, externally of an ash-gray colour, thickly covered with short satiny hairs, internally translucent, tough and horny, taste intensely bitter, inodorous.'—*The British Pharmacopœia*, p. 99.

For the genuine characters, see the article *Strychnos*.—The N. V. tree is a native of Ceylon, Ceylon, and other parts of the East Indies. It is a tree of moderate size, with roundish-oblong, stalked, smooth leaves, and terminal corymbs. The fruit is a globular berry, about as large as a small



**Nux Vomica:**  
Branchlet, Leaves, and Flowers.

orange, one-celled, with a brittle shell, and several seeds lodged in a white gelatinous pulp.—The bark is known as *False Angostura Bark*, having been confounded with *Angostura Bark*, in consequence of a commercial fraud, about the beginning of the present c.; but its properties are very different, as it is very poisonous.

The seeds contain (in addition to inert matters, such as gum, starch, woody fibre, &c.) three alkaloids closely related to each other, which act as powerful

poisons on the animal frame, and speedily occasion violent tetanic convulsions and death. These alkaloids or bases are named *Strychnia*, *Brucia*, and *Igasuria*, and exist in the seeds in combination with lactic and strychnic (or igasuric) acid. For a good method of obtaining pure strychnia, which is by far the most important of the three bases, the reader is referred to p. 328 of *The British Pharmacopœia*.

*Strychnia* ( $C_{15}H_{27}N_3O_4$ ) occurs 'in right square octohedrons or prisms, colourless and inodorous, scarcely soluble in water, but easily soluble in boiling rectified spirit, in ether, and in chloroform. Pure sulphuric acid forms with it a colourless solution, which, on the addition of bichromate of potash, acquires an intensely violet hue, speedily passing through red to yellow.'—*Op. cit.* In nitric acid, it ought, if pure, to form a colourless solution; if the solution is reddish, it is a sign that brucia is also present. Strychnia combines with numerous acids, and forms well-marked salts, which are amenable to the same tests as the base itself.

*Brucia* ( $C_{16}H_{28}N_2O_6 + 8 Aq$ ) is insoluble in ether, but more soluble in water and in strong alcohol than strychnia; and it is the most abundant of the three alkaloids in nux vomica. It acts on the animal economy similarly to, but much less actively than strychnia, from which it may be distinguished not only by its different solubility, but by the red colour which is imparted to it by nitric acid, and which changes to a fine violet on the addition of protochloride of tin. Like strychnia, it forms numerous salts.

*Igasuria* seems closely to resemble brucia in most respects. Little is known regarding *Igasuric Acid*.

Strychnia, brucia, and igasuria occur not only in nux vomica but in the seeds of *Strychnos Ignatii* (St Ignatius's beans), and in the seeds and other parts of several plants of the genus *Strychnos*. The amount of strychnia present in these substances varies from 0.5 to 1.5 per cent.

Nux vomica, according to the experiments of Marcet, acts on vegetables as a poison. His experiments were, however, confined to the haricot bean and the lilac. It is poisonous in a greater or lesser degree to most animals, though larger quantities are required to kill herbivorous than carnivorous animals. Thus, a few grains will kill a dog, but some ounces are required to destroy a horse. It is believed, however, that the bird called *Buceros Rhinoceros* eats the nuts with impunity; and a peculiar kind of *Acarus* lives and thrives in the extract of the nuts. Dr Pereira describes three degrees of the operation of this substance on man. 1. In very small doses, its effects are tonic and diuretic, and often slightly aperient. 2. In larger doses, there is a disordered state of the muscular system; the limbs tremble; a slight rigidity or stiffness is felt when an attempt is made to put the muscles in action; and the patient experiences a difficulty in keeping the erect posture. If the use of the medicine be continued, these effects increase in intensity, and the voluntary muscles are thrown into a convulsed state by very slight causes, as, for example, by inspiring more deeply than usual, or even by turning in bed. It is remarkable that in paralysis the effects are most marked in the paralysed parts. 3. In poisonous doses, the symptoms are tetanus and asphyxia, followed by death. After swallowing a large dose of strychnia (on which the poisonous effects of nux vomica essentially depend), the following phenomena occurred in a case recorded by Taylor in his *Medical Jurisprudence*: 'A young man, aged seventeen, swallowed forty grains of strychnia.' The symptoms came on in about a quarter of an hour; lock-jaw and

spasmodic contraction of all the muscles speedily set in, the whole body becoming as stiff as a board; the lower extremities were extended and stiff, and the soles of the feet concave. The skin became livid, the eyeballs prominent, and the pupils dilated and insensible; the patient lay for a few minutes without consciousness, and in a state of universal tetanus. A remission occurred, but the symptoms became aggravated, and the patient died asphyxiated from the spasm of the chest in about an hour and a half after taking the poison.' It is difficult to say what is the smallest dose that would prove fatal to an adult. Thirty grains of the powdered nuts, given by mistake to a patient, destroyed life. Three grains of the extract have proved fatal; and in a case quoted by Taylor (*op. cit.*), half a grain of sulphate of strychnia caused death in 14 minutes.

The preparations of nux vomica are the powdered nuts, the extracts, the tincture, and strychnia; the alkaloid being usually preferable, in consequence of its more constant strength. In various forms of paralysis, especially where there is no apparent lesion of structure, nux vomica is a most successful remedy; although there are cases in which it is positively injurious. It is also of service in various affections of the stomach, such as dyspepsia, gastrodynia, and pyrosis. The average dose of the powder is two or three grains, gradually increased; that of the tincture, 10 or 15 minims; and that of the extract half a grain, gradually increased to two or three grains. The dose of strychnia, when given in cases of paralysis, is at the commencement one-twentieth of a grain three times a day, the dose being gradually increased, till slight muscular twitchings are observed. For gastric disorders, a still smaller dose is usually sufficient, as, for example, one-fortieth of a grain.

N'YANZA, a great fresh-water lake in Central Africa, discovered by Captain Speke in 1858, and more fully explored by Speke and Grant in 1862. The native name N. signifies simply 'the water;' but Speke proposes to call it Victoria N'yanza. Its southern point is in lat. 2° 44' S., long. 33° E. Its northern shore runs nearly parallel to the equator, and is about 20 miles to the north of it. Speke supposes that formerly it covered a larger area; at present, it is estimated to be 220 miles in length, and fully as much in breadth. It is of no great depth; the surface is 3740 feet above sea-level. There are fleets of canoes on the lake, and yet there is no communication between the tribes on its opposite shores, who are quite unknown to each other. At its north-east extremity, Lake Baringo, described by the natives as a long narrow basin, is probably connected with the N'yanza. The countries on the west shores of the lake enjoy a mild and genial climate, equal to that of England in summer; and, contrary to expectation, the rain-fall is below that of many parts of Britain, being only 49 inches. The natives of Karagú and Uganda, on the western shores, are superior races, with a considerable degree of civilisation. The banana, coffee, and date-palm abound, and hundreds of white hornless cattle were seen browsing in the richest pasture-lands. The principal feeder of the N. on the west is the Kitangúlé, and from its northern side issue several streams, which unite to form the Nile (q. v.). The principal of these flows through Napoleon Channel, over the Ripon Falls. North-west from Lake N. lies the little Lúta N'Zigé Lake (see map accompanying art. NILE), which is described as a narrow reservoir about 230 miles long, through the northern end of which the Nile passes. It is quite shallow, and believed to be only a backwater of the Nile.

NYASSA, or NYANJA (apparently identical

with name N'yanza), another lake in the interior of Africa, which Dr Livingstone discovered in 1861 by ascending the river Shiré (q. v.). The southern end of the Nyassa, or Star Lake, is in lat. 14° 45' S., and it is supposed to extend northwards beyond the parallel of 10° S. It is 350 miles inland from the coast of Mozambique, and its surface is 1200 feet above the sea. Dr Livingstone explored 200 miles of the western shores. 'The lake has something of the boot-shape of Italy,' and appears to vary from 20 to 50 or 60 miles in width. Most of the land near the lake is low and marshy; on the east, at a distance of eight or ten miles there are ranges of high and well-wooded granite hills. Except near the shore, the lake is deep; the temperature of the water, which is sweet, was 72°. The lake abounds in fish; and the southern shores are closely beset with villages, whose inhabitants are hardy fishermen and industrious cultivators of the soil. Something had previously been known about this lake under the name of the Maravi; but the accounts were so vague, that latterly it was omitted from the maps of Africa.

NYĀYA (from the Sanscrit *ni*, into, and *āya* going, a derivative from *i*, to go; hence literally 'entering,' and figuratively, 'investigating analytically'), is the name of the second of the three great systems of ancient Hindu philosophy; and it is apparently so called because it treats analytically, as it were, of the objects of human knowledge, both material and spiritual, distributed by it under different heads or topics; unlike, therefore, the *Vedānta* (q. v.) and *Sāṅkhya* (q. v.), which follow a synthetic method of reasoning, the former of these systems being chiefly concerned in spiritual and divine matters, and the latter in subjects relating to the material world and man. The Nyāya consists, like the two other great systems of Hindu philosophy (see *Mīmāṃsā* and *Sāṅkhya*), of two divisions. The former is called NYĀYA (proper), and will be exclusively considered in this article; the other is known under the name of VAISĒSHIKA (q. v.). With the other systems of philosophy, it concurs in promising beatitude, that is, final deliverance of the soul from re-birth or transmigration, to those who acquire truth, which, in the case of the Nyāya, means a thorough knowledge of the principles taught by this particular system.

The topics treated of by the Nyāya are briefly the following: 1. The *pramāṇa*, or instruments of right notion. They are: *a.* Knowledge which has arisen from the contact of a sense with its object; *b.* Inference of three sorts (*à priori*, *à posteriori*, and from analogy); *c.* Comparison; and *d.* Knowledge, verbally communicated, which may be knowledge of 'that whereof the matter is seen,' and knowledge of 'that whereof the matter is unseen' (revelation). 2. The objects or matters about which the inquiry is concerned (*prameya*). They are: *a.* The *Soul* (*ātman*). It is the site of knowledge or sentiment, different for each individual coexistent person, infinite, eternal, &c. Souls are therefore numerous, but the supreme soul is one; it is demonstrated as the creator of all things. *b.* *Body* (*śarīra*). It is the site of action, of the organs of sensation, and of the sentiments of pain or pleasure. It is composed of parts, a framed substance, not inchoative, and not consisting of the three elements, earth, water, and fire, as some say, nor of four or all the five elements (viz. air and ether in addition to the former), as others maintain, but merely earthy. *c.* *Organs of sensation* (*indriya*); from the elements, earth, water, light, air, and ether, they are smell, taste, sight, touch, and hearing. *d.* *Their objects* (*artha*). They are the qualities of earth, &c.—viz. odour, savour, colour, tangibility, and sound. *e.* *Understanding* (*buddhi*),

or apprehension (*upalabdhi*), or conception (*śabdā*), terms which are used synonymously. It is not eternal, as the Sāṅkhya maintains, but transitory. *f. The organ of imagination and volition (manas)*. Its property is the not giving rise simultaneously to more notions than one. *g. Activity (pravṛtti)*, or that which originates the utterances of the voice, the cognitions of the understanding, and the gestures of the body. It is therefore oral, mental, or corporeal, and the reason of all worldly proceedings. *h. Faults or failings (doṣa)*, which cause activity—viz. affection, aversion, and bewilderment. *i. Transmigration (pretyabhāva*, literally, the becoming born after having died), or the regeneration of the soul, which commences with one's first birth, and ends only with final emancipation. It does not belong to the body, because the latter is different in successive births, but to the soul, because it is eternal. *k. Fruit or retribution (phala)*, or that which accrues from activity and failings. It is the consciousness of pleasure or of pain. *l. Pain (duḥkha)*, or that which has the characteristic mark of causing vexation. It is defined as 'the occurrence of birth,' or the originating of 'body,' since body is associated with various kinds of distress. Pleasure is not denied to exist, but, according to the Nyāya, it deserves little consideration, since it is ever closely connected with pain. *m. Absolute deliverance or emancipation (apavarga)*. It is annihilation of pain, or absolute cessation of one's troubles once for all.

After (1) 'instruments of right notion,' and (2) 'the objects of inquiry,' the Nyāya proceeds to the investigation of the following topics.

3. *Doubt (samśaya)*. It arises from unsteadiness in the recognition or non-recognition of some mark, which, if we were sure of its presence or absence, would determine the subject to be so or so, or not to be so or so; but it may also arise from conflicting testimony. 4. *Motive (prayojana)*, or that by which a person is moved to action. 5. *A familiar case (ārish'ānta)*, or that in regard to which a man of an ordinary and a man of a superior intellect entertain the same opinion. 6. *Tenet or dogma (siddhānta)*. It is either 'a tenet of all schools,' i. e. universally acknowledged, or 'a tenet peculiar to some school,' i. e. partially acknowledged; or 'a hypothetical dogma,' i. e. one which rests on the supposed truth of another dogma; or 'an implied dogma,' i. e. one the correctness of which is not expressly proved, but tacitly admitted by the Nyāya. 7. The different members (*avayava*) of a regular argument or syllogism (*nyāya*). 8. *Confutation* or reduction to absurdity (*tarka*). It consists in directing a person who does not apprehend the force of the argument as first presented to him, to look at it from an opposite point of view. 9. *Ascertainment (nirṇaya)*. It is the determination of a question by hearing both what is to be said for and against it, after having been in doubt. The three next topics relate to the topic of controversy, viz. 10. *Discussion (vāda)*, which is defined as consisting in the defending by proofs on the part of the one disputant, and the controverting it by objections on the part of the other, without discordance in respect of the principles on which the conclusion is to depend; it is, in short, an honest sort of discussion, such, for instance, as takes place between a preceptor and his pupil, and where the debate is conducted without ambition of victory. 11. *Wrangling (jalpa)*, consisting in the defence or attack of a proposition by means of tricks, futilities, and such like means; it is therefore a kind of discussion where the disputants are merely desirous of victory, instead of being desirous of truth. 12. *Cavilling*

(*vitan'dā*), when a man does not attempt to establish the opposite side of the question, but confines himself to carping disingenuously at the arguments of the other party. 13. *Fallacies*, or semblances of reasons (*hetubhāsa*), five sorts of which are distinguished, viz. the erratic, the contradictory, the equally available on both sides, that which, standing itself in the need of proof, does not differ from that which is to be proved, and that which is adduced when the time is not that when it might have availed. 14. *Tricks*, or unfairness in disputation (*chhala*), or the opposing of a proposition by means of assuming a different sense from that which the objector well knows the propounder intended to convey by his terms. It is distinguished as verbal misconstruing of what is ambiguous, as perverting, in a literal sense, what is said in a metaphorical one, and as generalising what is particular. 15. *Futile objections (jāti)*, of which twenty-four sorts are enumerated; and, 16. Failure in argument or reason of defeat (*nigraha-sthāna*), of which twenty-two distinctions are specified.

The great prominence given by the Nyāya to the *method*, by means of which truth might be ascertained, has sometimes misled European writers into the belief, that it is merely a system of formal logic, not engaged in metaphysical investigations. But though the foregoing enumeration of the topics treated by it could only touch upon the main points which form the subject-matter of the Nyāya, it will sufficiently shew that the Nyāya intended to be a complete system of philosophical investigation; and some questions, such as the nature of intellect, articulated sound, &c., or those of genus, variety, and individual, it has dealt with in a masterly manner, well deserving the notice of western speculation. That the atomistic theory has been devolved from it, will be seen under the article VAISĒSHIKA. On account of the prominent position, however, which the *method* of discussion holds in this system, and the frequent allusion made by European writers to a Hindu syllogism, it will be expedient to explain how the Nyāya defines the 'different members of a syllogism' under its seventh topic. A regular argument consists, according to it, of five members—viz. *a*. the proposition (*pratijñā*), or the declaration of what is to be established; *b*. the reason (*hetu*), or 'the means for the establishing of what is to be established'; *c*. the example (*udāharaṇa*), i. e. some familiar case illustrating the fact to be established, or inversely, some familiar case illustrating the impossibility of the contrary fact; *d*. the application (*upanaya*), or 're-statement of that in respect of which something is to be established'; and *e*. the conclusion (*nigamana*), or 'the re-stating of the proposition because of the mention of the reason.' An instance of such a syllogism would run accordingly thus: *a*. This hill is fiery, *b*. for it smokes, *c*. as a culinary hearth, or (inversely) not as a lake, from which vapour is seen arising, vapour not being smoke, because a lake is invariably devoid of fire; *d*. accordingly, the hill is smoking; *e*. therefore, it is fiery.

The founder of the Nyāya system is reputed under the name of *Gotama*, or, as it also occurs, *Gautama* (which would mean a descendant of Gotama). There is, however, nothing as yet known as to the history of this personage or the time when he lived, though it is probable that the work attributed to him is, in its present shape, later than the work of the great grammarian Pāṇini. It consists of five books or *Adhyāyas*, each divided into two 'days,' or diurnal lessons, which are again subdivided into sections or topics, each of which contains several aphorisms, or *Sūtra*. See SŪTRA. Like the text-books of other sciences among the

## NYCTAGINACEÆ—NYL-GHAU.

Hindus, it has been explained or annotated by a triple set of commentaries, which, in their turn, have become the source of more popular or elementary treatises.—The Sanscrit text of the Sūtras of Gotama, with a commentary by *Viśwanātha*, has been edited at Calcutta (1828); and the first four books, and part of the fifth, of the text, with an English version, an English commentary, and extracts from the Sanscrit commentary of *Viśwanātha*, by the late Dr J. R. Ballantyne (Allahabad, 1850—1854). This excellent English version and commentary, and the celebrated Essay on the Nyāya, by H. T. Colebrooke (*Transactions of the Royal Asiatic Society*, vol. i. London, 1827; and reprinted in the *Miscellaneous Essays*, vol. i. London, 1837), are the best guide for the European student who, without a knowledge of Sanscrit, would wish to familiarise himself with the Nyāya system.

**NYCTAGINACEÆ**, a natural order of exogenous plants, consisting partly of herbaceous plants, both annual and perennial, and partly of shrubs and trees. Lindley ranks them in his *Chenopodal Alliance*. The flowers are either clustered or solitary, and either the cluster or the flower often has an involucre, which is often gaily coloured. The perianth is tubular, plaited in bud, coloured; the limb entire or toothed, deciduous. The stamens are equal in number to the lobes of the perianth. The ovary is superior, with one ovule, and one style. The fruit is a thin *caryopsis*, enclosed within the enlarged and indurated base of the perianth.—There are about 100 known species, natives of warm countries. Some have flowers of considerable beauty, as those of the genus *Airabilis*, known in our gardens as *Marvel of Peru*, one of which, *M. Jalapa*, was at one time erroneously supposed to produce jalap. The roots of many are fleshy, purgative, and emetic. Those of *Boerhaavia paniculata* are used instead of ipecacuanha both in Guiana and in Java.

**NYCTERIBIA**, an extremely curious genus of insects, ranked in the order *Diptera*, although very different from most of that order, and having neither wings nor balancers. Its nearest alliance is with *Hippoboscida* (see FOREST FLY and SHEEP TICK), which it resembles particularly in parasitic habits, and in the retention of the eggs within the abdomen of the female, until they have not only been hatched, but have passed from the larva into the pupa state. The form, however, is so spider-like, that these insects were at first ranked among the *Arachnida*. The few species known are all parasitic on bats, on which they run about with great activity. The head is very small, curiously affixed to the back of the thorax, and when the creature sucks the blood of the bat, upon which it lives, it places itself in a reversed position.

**NY'KERK**, or **NIEUWKERK**, on the Veluwe, is a very flourishing and well-built town, near the Zuider Zee, in the province of Gelderland, Netherlands, 25 miles north-west of Arnheim. Pop. 8000. It has a good harbour, which is connected with the sea by a wide canal of 1½ miles in length. In the neighbourhood are fine rich meadow-pastures and lands suited for all kinds of grain, tobacco, potatoes, &c. Tobacco is extensively grown; many cattle are raised; and a brisk trade carried on both with the surrounding country and Amsterdam, the market to which the cattle, tobacco, dairy, and other agricultural produce, together with much firewood, are sent. N. has a handsome Reformed church, a Roman Catholic chapel, a synagogue, orphan-house, and good schools. There are several manufactures carried on, which also give employment to the people. In Netherlands church history, N. is famed as the place where a great religious move-

ment began at the middle of last century. The history of the movement, which spread throughout the land, contains all the marks of the later revivals in America, Scotland, and Ireland. See Ypey and Dermout's *Geschiedenis der Nederd. Herk.*, vol. iv.

**NY'KÖPING**, a seaport of Sweden, pleasantly situated on the Baltic, in lat. 58° 45' N., long. 17° E., about 60 miles south-west of Stockholm. It comprises among its manufacturing products cotton goods, stockings, tobacco, &c., and has good shipyards, mills, and manufactories for machinery, while in the vicinity of the town are extensive paper-mills. The ruined old castle of N., nearly destroyed by fire in 1665, and which ranked in point of strength next to those of Stockholm and Calmar, has experienced many eventful vicissitudes of fortune. King Valdemar of Sweden, after his dethronement in 1288, was imprisoned here till his death in 1302; but the most tragic incident connected with N. Castle was the horrible death within its walls of the Dukes Eric and Valdemar, who, after being entrapped by their pusillanimous brother, King Birger, in 1317, were left to perish of hunger in a dungeon, the keys of which the king threw into the sea before he left the castle. The horror of this deed roused the indignation of the people, who seized upon the castle, sacked it, and demolished its keep and donjons. In 1719, the town was taken and dismantled by the Russians; and since then it has ceased to be the scene of any events of historical interest. It is noted for the pure Swedish spoken by its inhabitants. Pop. 3956.

**NYL-GHAU** (*Antelope picta*, or *Portax tragocamelus*), a species of antelope, with somewhat ox-like head and body, but with long slender limbs, and of great activity and fleetness. It is one of the largest of antelopes, and is more than four feet high at the shoulder. The horns of the male are about as long as the ears, smooth, black, pointed, slightly curved forwards. The female has



Nyl-Ghau (*Antelope picta*).

no horns. The neck is deep and compressed, not rounded as in most of the antelopes. A slight mane runs along the neck and part of the back, and the breast is adorned with a long hanging tuft of hair. The back is almost elevated into a hump between the shoulders. The N. inhabits the dense forests of India and Persia, where it has long been regarded as one of the noblest kinds of game. It is often taken, like other large animals, by the enclosing of



## NYMPHÆACEÆ—NYSTADT.

a large space with nets, and by great numbers of people. It is a spirited animal, and dangerous to a rash assailant. It is capable of domestication, but is said to manifest an irritable and capricious temper.

**NYMPHÆA'CEÆ**, a natural order of exogenous plants, growing in lakes, ponds, ditches, and slow rivers, where their fleshy rootstocks are prostrate in the mud at the bottom; and their large, long-stalked, heart-shaped, or peltate leaves float on the surface of the water. Their flowers also either float, or are raised on their stalks a little above the water. The flowers are large, and often very beautiful and fragrant. There are usually four sepals, and numerous petals and stamens, often passing gradually into one another. The ovary is many-celled, with radiating stigmas, and very numerous ovules, and is more or less surrounded by a large fleshy disc. The seeds have a farinaceous albumen. More than fifty species are known, mostly natives of warm and temperate regions. The rootstocks of some of them are used as food, and the seeds of many.—See **WATER-LILY**, **LOTUS**, **VICTORIA**, and **EURYALE**.—Very nearly allied to *N. are* *Nelumbiaceæ*. See **NELUMBO**.

**NYMPHS**, in Classic Mythology, female divinities of inferior rank, inhabiting the sea, streams, groves, meadows and pastures, grottoes, fountains, hills, glens, trees, &c. Among the *N.*, different classes were distinguished, particularly the *Oceanides*,

daughters of Oceanus (*N.* of the great ocean which flows around the earth), the *Nereids*, daughters of Nereus (*N.* of the inner depths of the sea, or of the Inner Sea—the Mediterranean), *Potameides* (*River N.*), *Naiads* (*N.* of fountains, lakes, brooks, wells), *Oreades* (*Mountain N.*), *Dryads* or *Hamadryads* (*Forest N.*, who were believed to die with the trees in which they dwelt). They were the goddesses of fertilising moisture, and were represented as taking an interest in the nourishment and growth of infants, and as being addicted to the chase (companions of the divine huntress Diana), to female occupations, and to dancing. They are among the most beautiful conceptions of the plastic and reverent (if credulous) fancy of the ancient Greeks, who, in the various phenomena of nature—the rush of sea-waves, the bubble of brooks, the play of sunbeams, the rustle of leaves, and the silence of caves—felt, with a poetic vividness that our modern science will hardly permit us to realise, the presence of unseen joyous powers.

**NYSSA**. See **TUPELO TREE**.

**NYSTADT**, a town of Finland, on the eastern coast of the Gulf of Bothnia, 50 miles south of Biorneborg. Here, in 1721, a treaty was agreed to, between Russia and Sweden, by virtue of which all the conquests of Peter the Great along the coasts of the Gulf of Finland were annexed to Russia. Pop. 2610.



THE fifteenth letter in the English and in most western alphabets, is one of the five simple vowel-signs of the English language. As the language is at present pronounced, it stands for at least four distinct sounds, heard in the words *note*, *nōr*, (*nōt*), *move*, *son*. The primary and simple sound of O is that heard long in *nōr*, and short in *nōt*, *isp*. The sound given to it in such words as *note*, *go*, is really a diphthong—a long o terminating

in a slight u or oo sound (O<sup>u</sup>). The corresponding letter in the Hebrew and Phœnician Alphabet (q. v.) was called Ayn, i. e., 'eye;' and accordingly the primitive form of the Phœnician letter was a rough picture of an eye, which naturally became a circle with a dot in the centre—still to be seen in some ancient inscriptions—and then a simple circle.

O', a prefix in many Irish family names, serves to form a patronymic, like *Mac* in Gaelic names; as O'Brien, a descendant of Brien. By some, it is considered to be derived from *of*; but it is more likely from Ir. *ua*, Gael. *ogha*, a grandson. In the Lowland Scottish, the word *oe* is used for grandson, and in some localities for nephew.

OA'HU, one of the Sandwich Islands (q. v.).

OAJA'CO, OAXACA, or GUAXACA, a city of Mexico, capital of a state of the same name, stands on the river Rio Verde, 210 miles south-south-east of Mexico. It covers an area 2 miles in length by 1½ in breadth, is well built, with open streets, interspersed with plantations, on which the cochineal insect feeds, and has about 25,000 inhabitants. Silk, cotton, sugar, and chocolate are manufactured.

OAK (*Quercus*), a genus of trees and shrubs of the natural order *Cupuliferae*, having a three-celled ovary, and a round (not angular) nut—which is called an *acorn*—placed in a scaly truncated cup, the lower part of it invested by the cup. The species are very numerous, natives of temperate and tropical countries. A few species are found in Europe. North America produces many; and many are natives of mountainous regions in the torrid zone; some are found at low elevations in the valleys of the Himalaya, some even at the level of the sea in the Malay peninsula and Indian islands. But in the peninsula of India and in Ceylon, none are found; and none in tropical Africa, in Australia, or in South America. The oaks have alternate simple leaves; which are entire in some, but in the greater number variously lobed and sinuated or cut; evergreen in some, but more generally deciduous. Many of them are trees of great size, famous for the strength and durability of their timber, as well as for the majesty of their appearance, and their great longevity.—Throughout all parts of Europe, except the extreme north, two species are found, or varieties of one species, the COMMON OAK (*Q. robur*); one (*Q. pedunculata*) having the acorns on longish stalks,

the other (*Q. sessiliflora*) having them almost without stalks. Other differences have been pointed out; but they are regarded by some of the most eminent and careful botanists as merely accidental, and not coincident with these; while, as to the length of the fruit-stalks, every intermediate gradation occurs. Both varieties occur in Britain, the first being the most prevalent, as it is generally in the north of Europe; the second being more abundant in more southern countries. The short-stalked oak is sometimes called DURMAST OAK in England. It has been much disputed which is entitled to be considered the true British oak; and much alarm has occasionally been expressed lest new plantations should be made of the wrong kind; whilst the most contradictory statements have been made as to the comparative value and characters of the timber. The oak succeeds best in loamy soils, and especially in those that are somewhat calcareous. It cannot endure stagnant water. It succeeds well on soils too poor for ash or elm; but depends much on the depth of the soil, its roots penetrating more deeply than those of most other trees. Noble specimens of oak trees, and some of them historically celebrated, exist in almost all parts of Britain; but are much more frequent in England than in Scotland. The former existence of great oak forests is attested by the huge trunks often found in bogs. The oak attains a height of from 50 to 100 or even 150 or 180 feet; the trunk being four, six, or even eight feet in diameter. It sometimes grows tall and stately, but often rather exhibits great thickness of bole and magnitude of branches. It reaches its greatest magnitude in periods varying from 120 to 400 years, but lives to the age of 600, or even 1000. The timber is very solid, durable, peculiarly unsusceptible of the influence of moisture, and therefore eminently adapted for ship-building. It is also employed in carpentry, mill-work, &c.—The bark abounds in tannin; it also contains a peculiar bitter principle called *Quercine*, and is used in medicine, chiefly in gargles, &c., on account of its astringency, sometimes also as a tonic; it is used along with gall-nuts in the manufacture of ink; but most of all for tanning (see BARK), and on this account the oak is often planted as copse-wood (see CORSE) in situations where it cannot be expected to attain to great size as a tree. The timber of copse oak is excellent firewood. The oak is particularly fitted for copse-wood, by the readiness with which it springs again from the stools after it has been cut.—Acorns are very nourishing food for swine, and in times of scarcity have been often used for human food, as, indeed, they commonly are in some very poor countries, either alone or mixed with meal. The bitterness which makes them disagreeable is said to be in part removed by burying them for a time in the earth. The acorns of some trees are also much less bitter than others, and oaks of the common species occur which produce acorns as sweet as chestnuts. Other varieties of the common oak are assiduously propagated by nurserymen as

curious and ornamental, particularly one with pendulous branchlets (the *Weeping Oak*), and one with branches growing up close to the stem, as in some kinds of poplar. Among the Greeks and Romans, the oak was sacred to Zeus or Jupiter; and it has been connected with the religious observances of many nations, as of the ancient Celts and Germans.—The **TURKEY OAK** or **ADRIATIC OAK** (*Q. cerris*), now very frequently planted in Britain, is a large and valuable tree, very common in the south-east of Europe, and in some parts of Asia. The timber is imported in considerable quantity into Britain for ship-building and other purposes. The leaves differ from those of the common oak in their acute lobes, and the cups of the acorns are *mossy*, i. e., have long, loose, acute scales. Similar to this, in both these respects, are the **AUSTRIAN OAK** (*Q. Austriaca*), abundant near Vienna, and the **SPANISH OAK** (*Q. Hispanica*).—The **CORK OAK** or **CORK-TREE** (*Q. suber*) is noticed in the article **CORK**; the **HOLM OAK** or **EVERGREEN OAK** (*Q. ilex*), another of the species found in the south of Europe, in the article **ILEX**.—Of the North American oaks, some are very valuable as timber trees. Perhaps the most important is the **WHITE OAK** or **QUEBEC OAK** (*Q. alba*), a large tree, the leaves of which have a few rounded lobes. It is found from the Gulf of Mexico to Canada; and in some places forms the chief part of the forest. The timber is less compact than that of the British oak; that of young trees is very elastic.—The **OVERCUP OAK** (*Q. lyrata*), a majestic tree, highly esteemed for its timber, and having its acorns almost covered by their globular cup, grows chiefly in lands liable to inundation in the Southern States.—The **CHESTNUT-LEAVED WHITE OAK** (*Q. prinus*) is also a much-esteemed timber tree of the Southern States.—The **SWAMP WHITE OAK** (*Q. bicolor*), a closely allied species, extends further north.—The **LIVE OAK** (*Q. vivens*), an evergreen species, with entire leathery leaves, is regarded as a tree of the first importance in the United States, from the excellence of its timber and its value for ship-building, so that efforts have been made by the government to protect it and to promote the planting of its acorns. Yet it is not a very large tree, being seldom more than forty-five feet in height, with a trunk of two feet in diameter. It grows on the coasts of the Gulf of Mexico, and as far north as Virginia. It once abounded on the Sea Islands, now so celebrated for their cotton.—The **RED OAK** (*Q. rubra*), a large tree, with sinuated and lobed leaves, the lobes toothed and bristle-pointed, yields great part of the *Red Oak Staves* exported from Canada and the north of the United States to the West Indies; but *Red Oak Staves* are also produced in the Middle and Southern States by the **SCARLET OAK** (*Q. coccinea*), a very similar species, by the **BLACK OAK** or **QUERCITRON OAK** (*Q. tinctoria*), another species with the lobes of the leaves bristle-pointed, better known for the dye-stuff which its bark yields (see **QUERCITRON**), and by the **Willow Oak** (*Q. phellos*), a large tree with lanceolate leaves and a willow-like aspect. The timber of all these species is of very inferior quality. These are the American oaks of greatest economical and commercial importance, but there are numerous other species, some of them trees, some mere shrubs, of which some grow on poor soils, and cover them in compact masses; resembling in this a single European species (*Q. viminialis*), a native of the Vosges, 6–8 feet high, with slender tough branches, which makes excellent hedges.—The **BLACK JACK** (*Q. nigra*) is an American oak, chiefly notable for the abundance in which it grows on some of the poorest soils. It is a small tree, and its timber of little value. The bark is black.—Some of the Nepaulese oaks are large and

valuable trees, as are some of those of China and Japan, of Java, of Mexico, &c. The oaks of Java and the other Indian islands have generally the leaves quite entire.—The bark of most of the species of oak is capable of being used for tanning, and is used in different countries. The cups and acorns of the **VALONIA OAK** (*Q. Egilops*) are exported from the Morea and other parts of the Levant, in great quantities, for this purpose, under the name of *Valonia*. See **LEATHER**. The tree resembles the **Turkey Oak**, and has very large hemispherical mossy cups. The cups are said to contain more tannin than any other vegetable substance.—Galls (q. v.) or Gall-nuts are in great part obtained from the oak therefore called the **GALL-OAK** (*Q. insectoria*), a scrubby bush, a native of Asia Minor, with bluntly serrated, ovate-oblong leaves.—The **KERMES OAK** (*Q. coccifera*), on the leaves of which the **Kermes** (q. v.) insect is found, is a low bush, with evergreen spinous leaves, much resembling a holly, a native of the south-east of Europe.—Of oaks with sweet and edible acorns, may be mentioned the **BALLOTE OAK** (*Q. Ballota* or *Gramuntia*), an evergreen with round spiny-toothed leaves, a native of the north of Africa, the acorns of which are regularly brought to market in Algeria and in Spain, and are long and cylindrical; the **Italian Oak** (*Q. Euculus*), closely allied to the common oak; and the **DWARF CHESTNUT OAK** (*Q. chinquapin* or *prinoides*) of North America, a small shrubby species, which has been specially recommended to cultivation on this account. Other North American species, and some of the Himalayan species, also produce edible acorns. From the acorns of some species, oil is made in considerable quantity in different parts of the world, and is used in cookery.—The leaves of the **Manna Oak** (*Q. mannifera*)—a native of the mountains of Kurdistan, having oblong, blunt-lobed leaves—secrete in hot weather a kind of manna, a sweet mucilaginous substance, which is made into sweetmeats, and very highly esteemed.

The name **Oak** is sometimes popularly applied to timber trees of very different genera. Thus, **AFRICAN OAK** is another name of **African Teak**. See **TEAK**. Some of the species of *Casuarina* (q. v.) are called **Oak** in Australia. The **STONE OAK** (*Lithocarpus Javensis*) of Java, so named from the extreme hardness of its timber, is a tree of the same family with the true oaks.

**OAK BEAUTY** (*Biston prodromaria*), a moth of the family *Geometridæ*, a native of England, about an inch and a half or two inches in expanse of wings; the upper wings with two brown curved bands, and margined with black, the lower wings with one brown band. The caterpillar feeds on the oak.

**OAKHAM**, the county-town of Rutlandshire, England, in the vale of Catmos, 25 miles west-north-west of Peterborough. It is a station on the Syston and Peterborough branch of the Midland Railway. In former times, there was a castle here; it is now in ruins, with the exception of the portion used as the county-hall. The church, the interior of which was beautifully restored in 1853, is an edifice in the perpendicular style, and has a fine tower and spire. The Free Grammar-school, with an annual endowment of about £700 a year, was founded in 1581. Pop. 2948.

**OAKUM** a tangled mass of tarred hempen fibres, is made from old rope by untwisting the strands and rubbing the fibres free from each other. Its principal use is in Caulking (q. v.) the seams between planks, the space round rivets, bolts, &c., for the purpose of preventing water from penetrating.

OANNES, the name of a Babylonian god, who, in the first year of the foundation of Babylon, is said to have come out of the Persian Gulf, or the old Erythrean Sea, adjoining Babylon. He is described as having the head and body of a fish, to which were added a human head and feet under the fish's head and at the tail. He lived amongst men during the daytime, without, however, taking any



Oannes.

food, and retired at sunset to the sea, from which he had emerged. O. had a human voice, and instructed men in the use of letters, and in all the principal arts and sciences of civilisation, which he communicated to them. Such is the account of him preserved by Berosus and Apollodorus. Five such monsters are said to have come out of the Persian Gulf; one, called Anedotos or Idotion, in the reign of Amenon, the fourth king of Babylon; another in that of the fifth king; and the last, called Odacon (or Ho Dagon), apparently the Phœnician Dagon, under the sixth. Many figures of O., resembling that of a Triton, having the upper part of a man, and the lower of a fish, or as a man covered with a fish's body, have been found in the sculptures of Kouyunjik and Khorsabad, as well as on many cylinders and gems. O. is supposed to have symbolised the conquest of Babylonia by a more civilised nation coming in ships to the mouth of the Euphrates; but he is apparently a water-god, resembling in type and character the Phœnician Dagon, and the Greek Proteus and Triton.

Helladius, *Apud Phot. Cod.* 279, pp. 535, 34; Richter, *De Beroso*; Cory, *Anc. Fragm.* p. 30; 1 Sam. v. 4; Bunsen, *Egypt's Place*, vol. i. p. 706; Layard, *Nineveh*, p. 343.

OAR, a wooden instrument by which a person sitting in a boat propels it through the water. The form found in practice to combine greatest power with lightness, is that shewn in the figure. From *a* to *b* is the blade of the oar, thin and nearly flat, though occasionally somewhat curved, so as to present a concave surface to the water; from *b* to *d* is round or square, gradually thickening towards *d*, that the part *ce* may nearly balance the part *ac*. At *de* is the handle, which is grasped by one or both hands. The oar rests at *c* on the row-lock, and in many cases some device is resorted to, to retain the oar from slipping outwards. In the Thames, a leathern stop, called a button, is used; sometimes a pin in the gunwale of the boat passes through the oar (but this weakens the oar, and precludes feathering); at other times, the oar is fastened to the pin by a leathern thong. The action of an oar in moving a boat is that of a lever, the rower's hand being the power, the water the fulcrum, against which the oar presses, and the row-lock the point at which the opposition caused by the weight of the boat and its cargo is felt. Feathering an oar consists in turning it, immediately on leaving the water, so that the flat blade of the oar is horizontal, and in preserving this position until just before the fresh dip, when of course the

vertical position must be resumed. Feathering diminishes the resistance offered by air, wind, and small waves; it also adds greatly to the beauty and grace of rowing.

The best oars are of Norway fir, though some are made of ash and beech.

O'ASES, certain cultivated spots in the Libyan desert (called also *Auasis*, *Ouasis*, or *Hoasis*) which produce vegetation, owing to the presence of springs issuing from the ground. The principal oases are those lying to the west of Egypt, a few days' journey from the Nile, and known to the ancients by the name of the Greater and Lesser Oases, and that of Ammon. It is supposed that they were known to the Egyptians during the 12th dynasty under the name of *Suten-Khenn*, but no evidence of their occupation by the Egyptians earlier than Darius has been found *in situ*. By some of the ancients they were called the Islands of the Blessed, or compared to the spots on a panther's skin. Their name is supposed to be the Coptic *Quahé* (Inhabited Place). They are first mentioned by Herodotus in his account of the destruction of the army of Cambyses by the storm of sand, or simoom. Equally celebrated is the visit of Alexander the Great to the oasis, which he successfully accomplished after the conquest of Egypt, and passed through the desert a nine days' journey before he reached the Temple of Ammon, the priests of which declared him the son of that god, and the future conqueror of the entire world. Herodotus describes that of El Wah, or the Oasis Magna of the Romans, which contained the oracle of Ammon, and which lies seven days' journey west of Thebes. It appears to have been anciently frequented by caravans going to the Pillars of Hercules. Strabo mentions three oases: the first seven days' journey west of Abydos; the second, west of the Lake Mœris; the third, near the oracle of Ammon. Pliny mentions two oases; so, does Ptolemy, who calls them the Lesser and Greater. Under the Roman empire, they were used for temporary banishment of criminals of state, and the poet Juvenal was sent there. Olympiodorus, a native of the Thebaid, gives a glowing description of them in the days of Theodosius the Younger. Under the Byzantine emperors,

the emperors banished there the heads of the Catholic party, at the instigation of the Arians, in the 4th c., and Athanasius himself is supposed



Temple of Jupiter Ammon—Oasis of Siwah.  
(From Hoskin's *Visit to the Great Oasis*.)

the emperors banished there the heads of the Catholic party, at the instigation of the Arians, in the 4th c., and Athanasius himself is supposed

to have taken refuge in them. In the 5th c., Nestorius, the Bishop of Constantinople, was banished there. He was rescued by an excursion of the Blemyes, but expired soon after his arrival at the Nile. The oases were then a place of desolation and horror, occasionally plundered by Beduins. They fell, 943 A.D., into the power of the Arabs, after having been held by the Egyptian monarchs and their successors till that period; and they are described by Edrisi (1150 A.D.) as uninhabited; by Abulfeda (1240 A.D.) and by Leo Africanus (1513 A.D.), as inhabited and cultivated, and quite independent, having three fortresses. The first modern traveller who visited them is supposed to have been Poncet (1698 A.D.). Subsequently, in 1792, Browne discovered the oasis of Ammon at El Siwah; and it was visited in 1798 by Hornemann, and in 1819 by Cailliaud. It lies in 29° 12' 20" N. lat., and 26° 6' 9" E. long. Drovetti and Minutoli also visited the same spot.

These oases are now held by Muggrebi Arabs, a powerful race in the Desert, capable of raising 30,000 men, who supply camels and guides to travellers. The oases are four in number: 1. El Khargeh, or the Oasis Magna, the Greater Oasis of Ptolemy; 2. El Kaar, or Oasis Parva, the Lesser Oasis; 3. Siwah, or the Oasis of Ammon, the most northerly; 4. The Western Oasis, or Dakkel, mentioned by Olympiodorus, and visited by Sir Archibald Edmonstone in 1819. Of El Khargeh, full particulars have been given by M. Hoskins, who discovered it lying about 125 miles west of the Nile, having a stream of water rising near the village of Genah, on the north-west of the oasis, and lost in the sand. It is bounded on the east by Hagel-bel-Badah. North of El Gem lies the metropolis, El Khargeh, which consists of a series of covered streets and open bazaars. The temple lies two hours' journey from it, in a fine situation; the *sekos* has a vestibule of 500 feet, with pylons, or gateways, the first of which has a decree in Greek, dated in the reign of Galba (68 A.D.), against forcing persons to farm the revenue, preventing imprisonment for debt, preserving the dowries of women, and limiting the office of strategos for three years. The temple has other decrees preventing the officers of government from smuggling. It has an avenue of sphinxes and three pylons; on the third, Darius is represented offering to Amen Ra, Osiris, and Isis; while Nekht-her-hebi (Nectabes) continued the ornaments of the temple about 414—340 B.C. The *sekos* is 140 feet long, and represents Darius offering to Amen Ra, or Khnumis, the ram-headed god, and Osiris; while in the accompanying scenes are seen Anta, or Anaitis, Raspu, or Reseph. In the vicinity is a magnificent necropolis of 150 sepulchres, of a late period, with Doric and Corinthian capitals. There are several temples at other spots of the oases. 2. El Kaar, the Oasis Parva, lies four or five days' journey south-east of Siwah, called the Wah-el-Bahnasa, or Wah-el-Menesheh, contains no monuments older than the Roman, consisting of a triumphal arch, subterraneous and other aqueducts, several hot springs, a necropolis, and Christian church. This oasis was first conquered by the Arabs; and in its vicinity is another oasis called Wady Zerzoora, with others adjoining, of inferior interest. 3. Siwah, or the Oasis of Ammon—one of the first discovered, and repeatedly visited, has, unfortunately, not been seen by any one acquainted with hieroglyphics—lies west of the Natron Lakes. It would appear from Minutoli that the temple was built by Nekht-her-hebi, or Nectabes I., in honour of the god Khnum, Ammon Khnumis or Chnebis, who, as the deity of water, presided over the water from which the oasis

originated. The oasis is nine miles broad and two long, contains El Garah Gharny, and Mencliyeh, has a population of about 8000 inhabitants, possesses date and other trees, grows cereals, and has sulphurous springs, a salt lake at Arachieh, and many ruined temples, a necropolis, and other remains. The oracle of Ammon is supposed to have been at a place called Om-Beydah, or the temple of Nekht-her-hebi. From this, it would seem that the oasis did not fall into the power of Egypt till about the 5th c. B.C. The celebrated Fountain of the Sun is at Siwah Shargieh. It is 30 paces long, 20 broad, six fathoms deep, with bubbles constantly rising to the surface, steaming in the morning, and warmer at night. Close to it are the remains of the sanctuary of Ammon. 4. El Dakkel, or the Western Oasis, lies about 78 miles south-west of Siout. The principal ruin at Dar-el-Hadjar consists of a small temple, dedicated to Khnumis by the Roman emperors, Nero and Titus. At Ain Amoor, between this oasis and the Oasis Magna, is a temple built under the Roman empire.—Herodotus, iii. 26; Strabo, ii. p. 130, xvii. pp. 790, 791, 813; Ptolemy, iv. 5, 37; Minutoli, *Reise zum Tempel des Jupiter Ammon* (Berlin, 1824); Hoskins, *Visit to the Great Oasis* (8vo, Lond. 1837); Champollion, *L'Egypte*, p. 282.

OAT, or OATS (*Avena*), a genus of grasses, containing many species, among which are some valuable for the grain which they produce, and some useful for hay. The Linnæan genus *Avena*, less natural than most of the Linnæan genera, has been much broken up. The genus, as now restricted, has the spikelets in loose panicles, the glumes as long as the florets, and containing two or more florets; the paleæ firm, and almost cartilaginous, the outer palea of each floret, or of one or more of the florets, bearing on the back a knee-jointed awn, which is twisted at the base. The awn, however, tends to disappear, and often wholly disappears in cultivation. Those species which are cultivated as corn-plants have comparatively large spikelets and seeds, the spikelets—at least after flowering—pendulous. The native country of the cultivated oats is unknown, although most probably it is Central Asia. There is no reference, however, to the oat in the Old Testament; and although it was known to the Greeks, who called it *Bromos*, and to the Romans, it is probable that they derived their knowledge of it from the Celts, Germans, and other northern nations. It is a grain better suited to moist than to dry, and to cold than to warm climates, although it does not extend so far north as the coarse kinds of barley. The grain is either used in the form of Groats (q. v.) or made into meal. Oatmeal cakes and porridge form great part of the food of the peasantry of Scotland and of some other countries. No grain is so much esteemed for feeding horses. Besides a large quantity of starch—about 65 per cent.—and some sugar, gum, and oil, the grain of oats contains almost 20 per cent. of nitrogenous principles, or Proteins (q. v.) compounds, of which about 16 or 17 parts are *Avenine*, a substance very similar to *Caseine* (q. v.), and two or three parts gluten, the remainder albumen. The husk of oats is also nutritious, and is mixed with other food for horses, oxen, and sheep. From the starchy particles adhering to the husk or seeds after the separation of the grain, a light dish, called *sowans*, is made in Scotland by means of boiling water, was once very popular, and is very suitable for weak stomachs. The grain is sometimes mixed with barley for distillation. The Russian beverage called *quass* is made from oats. The straw of oats is very useful as fodder, bringing a higher price than any other kind of straw.—The varieties of oats in cultivation are very

numerous, and some highly esteemed varieties are of recent and well-known origin. It is doubtful if they really belong to more than one species; but the following are very generally distinguished as species: 1. COMMON OAT (*A. sativa*), having a very loose panicle, which spreads on all sides, and two or three fertile florets in each spikelet, the paleæ quite smooth, not more than one floret awned; 2. TARTARIAN OAT (*A. orientalis*), also called HUNGARIAN OAT and SIBERIAN OAT, distinguished chiefly by having the panicle much more contracted, and all turned to one side; 3. NAKED OAT (*A. nuda*), differing from the Tartarian Oat chiefly in having the paleæ very slightly adherent to the seeds, which, therefore, fall readily out of them, whilst in the other kinds they adhere closely; 4. CHINESE OAT (*A. chinensis*), which agrees with the last in the characters of the paleæ and seeds, but is more like the Common Oat in its panicle, and has more numerous florets, 4—8, in the spikelet; 5. SHORT OAT (*A. brevis*), which has a close panicle turned to one side, the spikelets containing only one or two florets, each floret awned, the grains short. Almost all the varieties of oat in cultivation belong to the first and second of these species. The Naked Oat is cultivated in Austria, but is not much esteemed. The Chinese Oat, said to have been brought by the Russians from the north of China, is prolific, but the grain is easily shaken out by winds. The Short Oat is cultivated as a grain-crop on poor soils at high elevations in the mountainous parts of France and Spain, ripening where other kinds do not; it is also cultivated in some parts of Europe as a forage plant.—Besides these, there is another kind of oat, the BRISTLE-POINTED OAT (*A. strigosa*), regarded by some botanists as belonging even to a distinct genus, *Danthonia*, because the lower palea is much prolonged, and instead of merely being bifid at the point, as in the other oats, is divided into two long teeth, extending into bristles. The panicle is inclined to one side, very little branched; the florets, 2 or 3 in a spikelet, all awned, the grain rather small. This plant is common in cornfields, is cultivated in many countries, but chiefly on poor soils, and was at one time much cultivated in Scotland,

Wild Oat (*Avena fatua*).

but is now scarcely to be seen as a crop.—Not unlike this, but with the panicle spreading equally on all sides, the outer palea merely bifid, and long hairs at the base of the glumes, is the WILD OAT (*A. fatua*), also frequent in cornfields, and a variety

of which is cultivated in some northern countries for meal, but which is more generally regarded by farmers as a weed to be extirpated, springing up so abundantly in some districts as to choke crops of better grain. Its awns have much of the hygro-metrical property which gains for *A. sterilis*, a species found in the south of Europe, the name of the ANIMAL OAT, because the seeds when ripe and fallen on the ground resemble insects, and move about in an extraordinary manner through the twisting and untwisting of the awns. The seed of the WILD OAT has been sometimes used instead of an artificial fly for catching trout.—Amongst the species of oat useful not for their grain but for fodder are the DOWNY OAT-GRASS (*A. pubescens*) and YELLOW OAT-GRASS (*A. flavescens*), both referred by some botanists to the genus *Trisetum*—the short awn being like a middle tooth in the bifid palea—and both natives of Britain, the former growing on light ground and dry hills, especially where the soil is calcareous, the latter on light meadow lands.—Other species are found in Britain, continental Europe, North America, Australia, &c. In some parts of the Sahara are bottoms of ravines richly productive of a species of oat-grass (*A. Forskalii*) much relished by camels.

Far more ground is occupied with oats in Scotland than with any other grain. In all the higher districts, it is almost the only kind of grain which is cultivated. Throughout Scotland, it is the crop that is chiefly sown after land has been in pasture for one or more years. The seed is generally sown broadcast over the ploughed land, which is afterwards well harrowed and pulverised. It is of the utmost importance to have the latter operations well done, as it prevents the attacks of insect larvæ. On soils that are infested with annual weeds, such as charlock, it is common to drill the seed, which permits the land to be hand-hoed and thoroughly cleaned. Oats thrive best upon deep and rich soils, and yield but poorly on thin sandy soils, where they suffer sooner from drought than barley, rye, or wheat. On good soils, it is common to dress oats with 2 to 3 cwt. of guano to the acre. The plant is not easily injured by large applications of heterogeneous manures. The Potato Oat is a variety generally cultivated in the best soils and climates. It is an early and productive variety. The Hopetoun Oat is also much sown in the earliest districts. The Sandy Oat is still more largely sown, more particularly when the climate is inferior and wet. It is not liable to be lodged with rains, and the straw is of fine quality for fodder. All these are varieties of the Common Oat. The White and Black Tartarian are much cultivated in some districts. They are very productive.—On the continent of Europe, this grain is seldom seen of quality equal to what is produced in Scotland; and even in most parts of England, the climate is less suitable to it, and it is less plump and rich.

OATES (*alias* AMBROSE), TITUS, was the son of a ribbon weaver, who, having first become an Anabaptist minister under Cromwell, took orders and a benefice in the English Church after the Restoration. Titus appears to have been born about 1620 in London. He was a pupil of Merchant Taylors' School, whence he passed to Trinity College, Cambridge, took orders, and received a small living from the Duke of Norfolk. This position, however, he forfeited, in consequence of a malicious prosecution, in which he narrowly escaped conviction for perjury; and having been afterwards appointed to the chaplaincy of one of the king's ships, he was expelled from it on a charge still more disgraceful. In this extremity, he conformed to the Roman Catholic Church, and was admitted as a scholar of

the Jesuits' College at Valladolid; but was expelled for misconduct, after a trial of a few months. He was again received by the Jesuits, on his earnest protestations of repentance, at St Omer, where he was no less unsuccessful, and was finally dismissed by them in the early part of 1678. He now, as a mere vagabond adventurer, set himself to live by his wits, in the evil exercise of which he devised, about this time, the atrocious scheme with which his name is identified in history. Just then, great excitement and alarm pervaded the Protestant party in England. It was well known that Charles was at heart a Roman Catholic; and his brother, the Duke of York, afterwards James II., was an active and avowed zealot on the same side. The growing confidence of the Roman Catholics was unconcealed; and with or without instant reason, the cry so often since heard arose, and was everywhere re-echoed, that the 'Protestant religion was in danger.' In this fevered state of general feeling, O. saw his opportunity, and dexterously and boldly availed himself of it. He communicated to the authorities the details of a pretended plot, the figment of his own brain, the main elements of which were a rising of the Catholic party, a general massacre of Protestants, the burning of the city of London, the assassination of the king, and the invasion of Ireland by a French army. In certain of its items, the fiction was devised with considerable ingenuity to catch the popular belief. By the strangest coincidence, moreover, there just then occurred in aid of it a series of events which seemed conclusively to attest its genuineness. A correspondence, the object of which was the propagation of the Roman Catholic religion, came to light between the secretary of the Duke of York and Pere La Chaise, the confessor and confidant of Louis XIV. Dauby, the prime minister, it also appeared, had been busy with intrigues in the same quarter. Finally, Godfrey, the zealous magistrate through whom publicity was first given to 'the plot,' was found mysteriously murdered. After this, could reasonable doubt exist? Was not the English St Bartholomew already begun? All London went wild with fear and rage; and it seemed at one time likely that a massacre of Roman Catholics would be substituted for the dreaded extermination of the Protestants. The parliament, which might have done something to allay the excitement, was itself swept headlong away by it. The king alone, whose life was threatened, but who, dissolute and indolent as he was, wanted neither courage nor shrewdness, much to his honour, scornfully insisted that the plot was merely some insane delusion, and tried, so far as he could, to control the excesses which followed. Too probably, his interference was of the characteristically easy, *insouciant* kind; in any case, it did not avail. The story of O. was universally believed; and he became the popular hero of the day. A pension of £900 a year was granted him; a suite of apartments in the palace at Whitehall was set apart as sacred to his use; and wherever he went, the Protestant public wildly cheered him as their saviour. With the aid of a set of suborned ruffians, only one degree less foul than himself, convictions of his victims were readily obtained,

judges and juries vying with each other in their unquestioning reception in evidence of the grossest and most manifest perjuries; and many innocent Roman Catholic gentlemen died the death of traitors at the block. Over the space of two years, the base success of O. was signalled by a series of judicial murders. Naturally, however, as reason resumed its sway, doubts began to be felt; and on the execution of a venerable and respected nobleman, Viscount Stafford, with a strong shock of pity and remorse, public suspicion awoke, and a violent reaction set in. It was only, however, on the accession of James II. in 1685 that retribution overtook the malefactor. Active steps against him were then taken. He was tried before the Court of King's Bench, convicted of perjury, and sentenced to be pilloried, whipped at the cart's tail, and afterwards

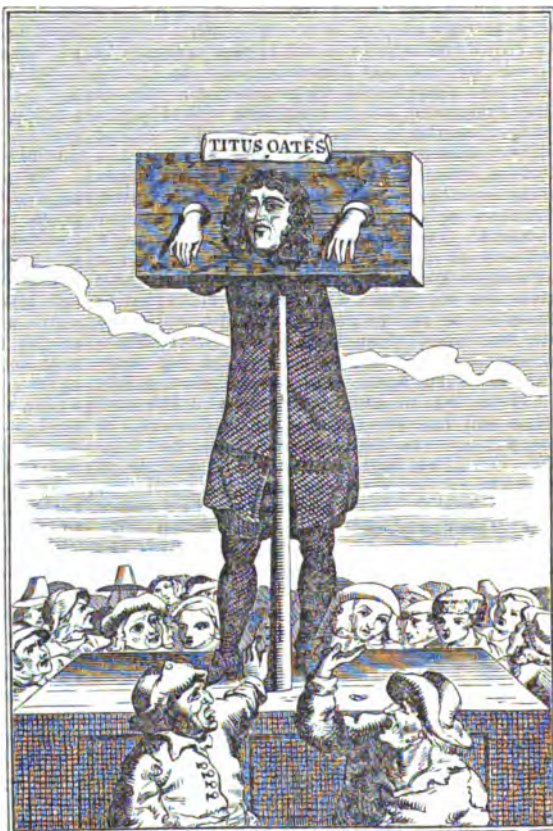

Oates in the Pillory.—From a Contemporary Print.

imprisoned for life. We might wonder a little at the leniency of the sentence, were it not thus to be explained: it was intended that the severity of the first two items of punishment should render the last one superfluous, and that the wretch should die under the lash of the executioner. But the hide of O. was beyond calculation tough; and horribly lacerated, yet living, his carcass was conveyed to the prison, from which it was meant never more to issue. Very strangely, however, the next turn of the political wheel brought back the monster to the light of day and to prosperity. When the revolution of 1688 placed William on the throne, the Protestant influence triumphed once

## OATH.

more. In the outburst of enthusiasm which ensued, what more natural than that O. should be glorified as a Protestant martyr? Parliament solemnly declared his trial an illegal one; he was pardoned, and obtained his liberty; and in order to his perfect enjoyment of it, a pension of £300 a year was granted him. He was, however, no more heard of; he passed his seventeen remaining years in obscurity, and died in 1705 at the good old age of eighty-six.

OATH (Ang.-Sax. *ath*, Ger. *eid*), in the religious use of the word, may be defined an expressed or implied calling upon the Almighty to witness the truth of an asseveration, or the good faith of a promise; with which is ordinarily conjoined an imprecation of his vengeance, or a renunciation of his favour, in case the asseveration should be false, or the promise should be broken. This practice has prevailed, in some form or other, in almost all the religions of the ancient, as well as of the modern world. It supposes, however, a belief of the existence of a provident Supreme Being, in order to its moral efficacy as a safeguard of truth. Among the Jews, we find instances in Gen. xiv. 22, xxi. 24, xlvii. 31, l. 5, confirmed even by the example of God himself, Numb. xiv. 28, Jerem. xlv. 26, Isai. lxii. 8. It was strictly forbidden to the Jews to swear by false gods (Amos viii. 14, Jerem. xii. 16). The form of oath was probably variable, either a direct adjuration, as 'The Lord liveth,' or an imprecation, 'The Lord do so to me;' but in all cases, the strongest denunciations are held out against the false swearer (Exod. xx. 7, Levit. xix. 12). Oaths were employed, both judicially and extrajudicially, by the ancient Egyptians, Assyrians, Medes, and Persians, as well as by the Greeks, and also by the Romans. The forms were very various—one of the most solemn consisting in the act of placing the hand on the altar of the deity who was invoked as witness. In the judicial proceedings of both the last-named nations, oaths were employed, but not universally; and in examples of their extrajudicial use, the literatures of both abound. In the Christian dispensation, the solemnity of an oath is enhanced by the elevated idea of the sanctity and perfection of the Deity.

The lawfulness and fitness of the practice, under circumstances of due solemnity, are commonly recognised by Christians. Some communions, of which the most remarkable are the Moravians and the Society of Friends, applying literally the words of Christ (Mat. v. 34), regard all oaths as unlawful. But other communions generally restrict this prohibition to ordinary and private discourse, and find in Rom. i. 9, 2 Cor. xi. 21, Gal. i. 20, Phil. i. 8, and 1 Thessal. ii. 5, full warrant for the lawfulness of oaths in judicial and other solemn use. From some passages of the Fathers, it might seem that they shared the difficulties of the Quakers and Moravians on the subject of the lawfulness of swearing; but these Fathers for the most part referred to the oaths required of Christians by the pagans, which generally involved a recognition of particular pagan divinities; and they condemned these pagan oaths, rather as involving or even directly containing a profession of the popular paganism, than as unlawful in themselves. The Christians of the later ages may perhaps be said to have multiplied in an opposite degree the occasions of oaths; especially of what were called 'purgatorial' oaths, in which a party charged with a crime justified himself by swearing his innocence. These oaths were commonly accompanied by some imprecatory form or ceremonial, and were often expected to be followed by immediate manifestations of

the divine vengeance upon the perjurer. The common instrument of attestation on oath was the Bible or some portion of it; but oaths were sometimes sworn on the relics of saints, or other sacred objects; sometimes simply by raising the hand to heaven, or by laying it upon the breast or the head. In canonical processes, the oath was often administered to the party kneeling. The forms varied very much; the most general being that which the English oath still retains (*Sic me Deus adjuvet*). Divines commonly require, in order to the lawfulness of an oath, three conditions (founded upon Jerem. iv. 2), viz., *truth, justice, and judgment*—that is to say (1), that the asseveration, if the oath be assertive, shall be *true*, and that the promise, if the oath be promissory, shall be made and shall be kept *in good faith*; (2), that the thing promised shall be objectively lawful and good; (3), that the oath shall not be sworn without due discretion and deliberation, and without satisfactory reasons founded on necessity, or at least on grave and manifest utility.

The Mohammedans do not employ oaths in their judicial proceedings; but they regard deliberate perjury, even when extrajudicially committed, as sinful, and deserving of God's vengeance. For this, however, they require that the oath should be an express adjuration of God himself by some one of his well-known holy names; that the jurant should be of full age and intelligence; and that the oath should be sworn deliberately, and with the intention of swearing.

OATH, in point of law, is that kind of solemn declaration which is necessary as a preliminary condition to the filling of some office more or less public, or of giving evidence in a court of justice, or in some judicial proceedings. Oaths have been usual in all civilised countries. Nearly all the great public offices of the state in this country can only be filled by persons who are willing to take an oath before acting in such office. The most important office of all—that of king or queen of Great Britain—requires a Coronation Oath (q. v.). Members of parliament also require to take the oaths of allegiance, supremacy, and abjuration, or rather the consolidated oath which is now substituted for these oaths. See ABJURATION. Quakers, Moravians, and Separatists make an affirmation, instead of an oath, to the same effect. Roman Catholics take the oath as enacted by 10 Geo. IV. c. 7, s. 2; and Jews may be allowed, on a resolution of either House of Parliament, to take the oath, omitting the words: 'And I make this declaration on the true faith of a Christian.' With respect to all the high offices of state, and all offices held under the crown, civil, naval, or military, except the inferior offices, the appointee is bound, under a penalty, to take within six months the oath of allegiance; but in order to indemnify those who have inadvertently omitted to do so, an annual act, called the Indemnity Act, is passed. A statute passed in the time of Will. IV., dispensing with the formality of an oath in most of the government offices, and substituting a declaration instead thereof.

The most important oaths affecting the general public are those which are required to enforce the truth from witnesses in courts of justice. It may be stated that jurymen, where they are called upon to exercise their functions, are also required to take an oath. The oath is read to the juror thus—'You shall well and truly try the issue between the parties, and a true verdict give, according to the evidence, so help you God;' and the juror kisses the New Testament. Witnesses who are called to give evidence must all be first sworn in a similar manner, the words being, 'The evidence you shall give shall be



the truth, the whole truth, and nothing but the truth, so help you God.' Hence, the person who is a witness must have sufficient understanding to know the nature and obligations of an oath; and on this ground, young children are incompetent to be witnesses. Another condition or qualification required in the party who takes an oath as a witness is, that he has a competent sense of religion, in other words, he must not only have some religious knowledge, but some religious belief. He must, in substance, believe in the existence of a God, and in the moral government of the world; and though he cannot be questioned minutely as to his particular religious opinions, yet, if it appear that he does not believe in a God and future state, he will not be allowed to give his evidence, for it is assumed, that without the religious sanction, his testimony cannot be relied upon. So long, however, as a witness appears to possess competent religious belief, the mere form of the oath is not material. The usual practice in England and Ireland is, for the witness, after hearing the oath repeated by the officer of court, to kiss the four gospels by way of assent; and in Scotland, the witness repeats similar words after the judge, standing and holding up his right hand, 'swearing by Almighty God, as he shall answer to God at the Great Day of Judgment,' but without kissing any book. Jews are sworn on the Pentateuch, keeping on their hats, and the oath ends with the words, 'so help you Jehovah.' A Mohammedan is sworn on the Koran; a Chinese witness has been sworn by kneeling and breaking a china saucer against the witness-box. Thus, the mere form of taking the oath is immaterial; the witness is allowed to take the oath in whatever form he considers most binding upon his own conscience—the essential thing being, however, that the witness acknowledge some binding effect derived from his belief in a God or a future state.

The policy of insisting upon the religious formalities attending the taking of an oath, has been much discussed of late years, and it has been disputed whether atheists, who avow an entire absence of all religious belief, should be entirely rejected as witnesses (as is sometimes the case), and justice be thereby frustrated. The objections of Quakers, Moravians, and Separatists to taking an oath have long been respected as not being fundamentally at variance with a due sense of religious feeling, and hence they have by statute been allowed to make an affirmation instead of taking the oath. In 1854, another concession was made to those who, not being Quakers, yet refuse to take the oath from sincere conscientious motives, and these are now also allowed to affirm instead of swear. But the law remains as before, that atheists and persons who admit that they have no religious belief whatever, are excluded from giving evidence in courts of justice.

When a witness, after being duly sworn, gives false evidence in a court of justice or in a judicial proceeding, and his evidence so falsely given is material, he commits the offence of *perjury*; but it is necessary, in England, not only that two witnesses shall be able to prove the falsity of such evidence, but also that the party should be proceeded against, in the first instance, before a justice of the peace, or by order of a judge, or the attorney-general, it being found that frivolous and unfounded indictments were often preferred against witnesses by disappointed or hostile parties. As a general rule, perjury cannot be committed except in some judicial proceeding, or rather the giving of false evidence cannot be punished except it has been given in some judicial proceeding. The practice formerly existed of persons

voluntarily taking oaths in various matters not connected with any judicial proceeding; and creditors often in this manner sought to add to other securities by insisting on a formal oath before a justice of the peace, in some isolated matter of fact. This practice was put an end to by the statute 5 and 6 Will. IV. c. 62, by which justices of the peace were prohibited from administering or receiving such oaths touching any matter or thing whereof such justice has not jurisdiction or cognizance by some statute. It is left to some extent to the discretion of the justice whether the particular matter is one as to which it is proper to administer an oath; but when it is considered proper, the declaration may be made in the form given by that statute; and if the party make a false declaration, he commits a misdemeanour. Unlawful oaths generally mean oaths taken by members of secret and illegal societies of a treasonable description; and statutes long ago passed to inflict penalties on all who took or administered such oaths.

**OATH OF CALUMNY**, in Scotch Law, means an oath taken by a party at the instance of his opponent, that the allegations were well founded. Oaths of verity and credulity are oaths that a debt or claim is well founded.

**OATHS, MILITARY.** The taking of the oath of fidelity to government and obedience to superior officers, was, among ancient armies, a very solemn affair. A whole corps took the oath together, sometimes an entire army. In modern times, when so many other checks are used for maintaining discipline, the oath has become little more than a form. In the United Kingdom, a recruit enlisting into the army or militia, or a volunteer enrolling himself, swears to be faithful to the sovereign, and obedient to all or any of his superior officers; also to divulge any facts coming to his knowledge which might affect the safety of his sovereign, or the stability of that sovereign's government. The members of a court-martial take an oath to try the cases brought before them justly, according to the evidence, to keep secret the finding until confirmed by the crown, and to keep secret always the opinions given by the members individually. The only other military oath is the common oath of a witness before a court-martial to tell the truth, the whole truth, and nothing but the truth.

**OB**, or **OBI**, the great river of Western Siberia, rises in two branches, the Bia and the Katune or Katunga, both of which have their origin in the Altai Mountains, within the frontier of the Chinese dominions, about lat. 49° N., and long. 90° E. These branches, flowing in a north-west direction, unite to form the Ob at the town of Biak in lat. 52° 30' N., long. 85° E. Pursuing a winding course, with a general north-west direction, the Ob reaches the meridian of 75° E., when it turns west, and maintains that direction to its confluence with the Irtysh, the greatest of its tributaries. It then flows north-west, north, and north-east, to its mouth in the Gulf of Ob, which it reaches after a course of 2000 miles. Its chief affluents on the right are the Tom—a swifter stream than the Ob, 400 miles in length, and navigable for the last 280 miles from the beginning of May till July—the Tchulim, and the Ket. The principal affluent on the left is the Irtysh, which, rising within the frontier of the Chinese territories, traverses the Altai Mountains, and after a course longer than that of the Ob itself, joins that river 250 miles below Tobolsk. The trade of the Irtysh, of which the centre is Tobolsk, is important. The principal towns on the banks of the Ob are Narim, Sargut, Berezow, and Obdorsk.—The Gulf of Ob is a long inlet of the Arctic Ocean,

## OBADIAH—OBELISK.

450 miles in length by about 100 miles in breadth. At present, only a few steamers ply on the great water-system of the Ob; but that system, communicating as it does between Siberia, the Chinese territories, and European Russia, is, without doubt, destined to become a great commercial thoroughfare. This river is one of the richest in fish, of all the rivers belonging to the Russian empire. Its waters are swelled in May by the melting of the snows of the plains, and again in June and July by the melting of the mountain snows. Below its junction with the Irtish, it divides itself into several parallel streams; and in the flood season it inundates great tracts of country, and presents the appearance of a waste of waters, its desolate uniformity broken only by the occasional tree-tops that rise above the surface. At Obdorsk, about 20 miles south of the southern border of the Gulf of Ob, the river freezes in the middle of October, and breaks up about the middle of May.

OBADIAH, one of the 'minor prophets' of the Old Testament, regarding whom absolutely nothing is known. His book or 'vision'—the shortest of the Jewish Scriptures—appears, from internal evidence, to have been composed after the destruction of Jerusalem by the Chaldeans, 588 B.C., and consists of two parts. The first is a prophecy of the downfall of Edom. The second foretells the future redemption and glory of the house of Jacob, in which Edom—for his unbrotherly conduct—shall not share, but, on the contrary, be burned up as 'stable.'

O'BAN, a parliamentary burgh and seaport, Argyleshire, Scotland, on a bay of the same name, 20 miles (in direct line) north-west of Inveraray. The bay is protected from every wind by the island of Kerrera on the west, and by the high shores of the mainland, and is overlooked on the north by the picturesque ruins of Dunolly Castle. It is from 12 to 24 fathoms deep, and although the girdle of hills that seems to surround it gives it the appearance of a lake, it is easily accessible, and could afford anchorage to 300 sail. O. is the great rendezvous for tourists in the West Highlands. Its importance dates chiefly from the beginning of the present century. The burgh now contains a number of churches, several hotels and inns, schools, banks, &c. Within three miles of O. is Dunstaffnage Castle, which is said to have been the seat of the Scottish monarchy previously to its transference to Scone. The Stone of Destiny, which now supports the coronation chair in Westminster Abbey, and was carried thither from Scone by Edward I., was obtained, in the first instance, according to tradition, from Dunstaffnage Castle. Pop. of parliamentary burgh (which is one of the Ayr (q. v.) group) was 1940 in 1861.

OBÉ, or OBI (etymology unknown), the name given to the magical arts or witchcraft practised by a class of persons among the negroes of the West Indies. The practiser is called an *Obeah-man* or *Obeah-woman*. It differs in no essential respect from the corresponding superstitions all the world over. See MAGIC, WITCHCRAFT.

OBEDIENCE, in Canon Law, means the duty by which the various gradations in ecclesiastical organisation are held subject, in all things consistent with the law of God or of the church, to the several superiors placed immediately above each, respectively, in the hierarchical scale. Thus priests and inferior clergy owe canonical obedience to the bishop, and priests are bound thereto by a solemn promise administered at ordination. The bishop primitively took a similar oath to the metropolitan; but by the modern law, the jurisdiction of the

metropolitan is confined to the occasions of his holding a visitation, or presiding in the provincial synod. Bishops, by the present law of the Roman Catholic Church, take an oath of obedience to the pope. This obedience, however, is strictly limited by the canons, and is only held to bind in things consistent with the divine and natural law. In ecclesiastical history the word Obedience has a special signification, and is applied to the several parties in the church, which, during the great Western Schism (q. v.), adhered to the rival popes. Thus we read of the 'Roman Obedience,' which included all who recognised the pope chosen at Rome, and the 'Avignon Obedience,' which meant the supporters of the Avignon popa. So, again, historians speak of 'the Obedience of Gregory XII,' and 'the Obedience of Benedict XIII,' &c. Applied to the monastic institute, obedience means the voluntary submission which all members of religious orders vow, at the religious profession, to their immediate superiors, of whatever grade in the order, as well as to the superior general, and still more to the rules and constitutions of the order. This forms, in all orders, one of the essential vows. It is, however, expressly confined to lawful things; and although it is held that a superior can command certain things under pain of sin, yet Roman Catholics repudiate the notion that the command of a superior can render lawful, much less good, a thing which is, of its own nature, or by the law of God, sinful or bad. The name Obedience is sometimes given to the written precept or other formal instrument by which a superior in a religious order communicates to one of his subjects any special precept or instruction—as, for example, to undertake a certain office, to proceed upon a particular mission, to relinquish a certain appointment, &c. The instruction, or the instrument containing it, is called an obedience, because it is held to bind in virtue of religious obedience.

O'BELISK, a word derived from the Greek *obelos* and *obeliskos*, signifying a spit, applied to prismatic monuments of stone and other materials, terminating with a pyramidal or pointed top. These monuments, called *tekhen*, were placed upon bases before gateways of the principal temples in Egypt, one on each side of the door. They served in Egyptian art for the same purposes as the stelæ of the Greeks and columns of the Romans, and appear to have been erected to record the honours or triumphs of the monarch. They have four faces, are cut out of one piece, and are broader at the base than at the top, at a short distance from which the sides form the base of a pyramidion in which the obelisk terminates. They were placed upon a cubical base of the same material, which slightly surpassed the breadth of their base. Each side of the obelisk at the base measures  $\frac{1}{10}$ th of the height of the shaft, from the base line to that where the cap, or pyramidion commences. The cap is also  $\frac{1}{10}$ th of the same height. Their sides are slightly concave, to increase their apparent height. Their height varies from upwards of 100 feet to a few inches, the tallest known being that of Karnak, which rises to 105 feet 7 inches. The sides are generally sculptured with hieroglyphs and representations, recording the names and titles of kings, generally in one line of deeply-cut hieroglyphs down each side. The pyramid of obelisks was sometimes decorated with subjects. The mode by which they were made appears to have been to hew them first in the rough out of a solid piece in the quarries, and one unfinished specimen thus prepared still remains in the quarries of Syene. They were transported down the Nile during the inundation, on

## OBELISK.

rafts to the spot where they were intended to be placed, and raised from their horizontal position by inclined planes, aided by machinery. Some obelisks, before their erection, had their pyramid capped with bronze gilded, or gold, the marks of such covering still being evident on their surfaces. Under the Roman empire, they were raised by pulleys and heavy tackle. The difficulty of erecting the fallen ones in the ages of the renaissance, as also the mechanical appliances for the lowering from its original site the obelisk of Luxor in 1831, and erecting it in the Place de la Concorde in 1833 by Le Bas, shew the difficulties experienced by the ancients. The use of obelisks is as old as the appearance of art itself in Egypt; these grand, simple, and geometric forms being used in the 4th dynasty, and continued till the time of the Romans. Their object is enveloped in great obscurity. At the time of the 18th dynasty, it appears that religious ceremonies and oblations were offered to the obelisks, which were treated as divinities. Their sepulchral use is evinced by their discovery in the tombs of the 4th dynasty, and the vignettes of early papyri. No large obelisk is older than that of Matarieh or Heliopolis, erected by Osortesen I. about 1900 B.C.; and that of Beggig or Crocodilopolis is, in reality, only a stele. Thothmes I. placed two of large size before the granite sanctuary of Karnak, and his daughter Hatasu, two others of above 90 feet high, before the second propylæon. Additional sculptures were made on these obelisks by Sethos I., who restored them. Thothmes III. appears to have erected many obelisks. The oldest is that of the Atmeilan or Hippodrome of Constantinople, erected to record his conquest of Naharania or Mesopotamia. Two others, which formerly stood at Heliopolis, were subsequently re-erected by Rameses II. at Alexandria. One of these still remains erect, and is popularly known as Cleopatra's Needle, the other lies prostrate. Both have greatly suffered from the effects of sea breezes. The highest of all obelisks, that of St John of the Lateran, appears to have been removed from Thebes, and set up by Thothmes IV. 35 years after the death of Thothmes III. A small obelisk of Amenophis II., said to have been found in the Thebaid, apparently from Elephantine, is in the collection of the Duke of Northumberland at Sion. Sethos I. commenced the Flaminian obelisk, subsequently completed by Rameses II., and placed at the temple of Heliopolis. It was removed to Rome by Constantius, and found 16 feet under the surface in the pontificate of Gregory XIII., and erected in that of Sextus V. by the architect Fontana. The other obelisks of Rameses II. are, the one at the Luxor quarter of Thebes, the companion of which was removed to the Place de la Concorde at Paris in 1833; the two obelisks of San or Tanis; that of the Boboli Gardens of Florence, transported from the circus of Flora at Rome; the obelisk of the Rotonda at Rome, erected by Clement XII., 1711 A.D.; and that of the Villa Mattei, which decorated the Ara Cæli of the Capitol. A fragment of another obelisk was in the Collegio Romano. No obelisks are known of other monarchs till the 26th dynasty. That of the Monte Citorio at Rome, erected by Psammetichus II. at Heliopolis, was transported by Augustus to the Campus Martius, having been exhumed 1748 A.D., and erected by the architect Antinori in that of Pius VI. Two other obelisks of small size, made of black basalt, dedicated by Nekhtherhebi or Nectanebes II. at Hermopolis, commonly known as the obelisks of Cairo, are in the British Museum. Ptolemy Philadelphus is said to have erected in the Arsinoeum at Alexandria a plain obelisk of 80 cubits, cut in the quarries by Nectabis. It was set

up by the architect Satyrus. Two obelisks, erected by Ptolemy Euergetes II. and his wife Cleopatra, stood before the temple of Philæe, one of which was removed to Corfe Castle by Mr Bankes. The so-called Pamphiliano obelisk at Rome, erected by E. Bernin in 1651, in the Piazza Navona, under the pontificate of Innocent X., was removed from the Circus of Maxentius, having, as their hieroglyphical legends testify, been originally erected by Domitian before the Serapeum at Rome. The last of the Roman obelisks was the Barberini, which was found in 1633 on the site of the Circus of Aurelian, and finally erected in 1822 on the Monte Pincio. It was placed by the Emperor Hadrian before the mausoleum or cenotaph either of himself or Antinous, between 132—138 A.D. Barbarous hieroglyphs, found on the Sallustian obelisk, are copied from the Flaminian obelisk. It is supposed to have been transported to Rome, unadorned with hieroglyphs, by Sallustius Crispus, prefect of Numidia, and to have been set up in the gardens of Sallust, in the reign of Vespasian. It was erected by Antinori, 1789, before the Church of Trinita del Monte. It has been seen how, on the renaissance of the arts, the obelisks were restored and applied to the embellishments of modern Rome, either as columns in the centres of piazzas or squares, or else as the ornaments of fountains; one obelisk being set up alone in the centre of the piazzas and places of Italy and France, while in antiquity they always stood in pairs before the Pylons.

Two small obelisks, and the apex of a third, have been found in Assyria, in shape of truncated prisms, the apices step-shaped. The most interesting is that of the north-west palace of Nimrud, of black marble, is 5 feet 9 inches high. Each side has five compartments of bas-reliefs, representing the tribute and offerings made to the Shalmanaser. It is covered with a cuneiform inscription, recording the annals of the king's reign, from his 1st to his 31st year. On it is represented



Obelisks in front of a Temple.

the tribute of Jehu, king of Israel. A second obelisk, of white marble, measures 8 feet 2 inches high, is covered with bas-reliefs, representing scenes of war and tributes, winding round it like those of a Roman triumphal column. On it is an inscription of Shamas-Pul. The broken apex of a third has a dedication from Ashur-izir-pul II. An obelisk of Semiramis at Babylon is mentioned by Diodorus, and another of Aricarus was interpreted by Democritus. Under the Roman empire, obelisks were

used as gnomons, placed in the public spaces, or erected in the *spina de circi*. The first removal of obelisks to Rome took place in the reign of Augustus, who placed one in the circus, said to have been originally erected in the reign of Semempertus, 85½ feet high; and another of 9 feet less, in the Campus Martius, and had it adjusted as a gnomon by the mathematician Facundus Novus; a third obelisk was erected in the Circus of Caligula and Nero in the Vatican, and originally dedicated to the sun by Nuncoreus, the son of Sesosis, on the recovery of his sight. Two other small obelisks, which decorated the mausoleum of Augustus, and were erected by Claudius or Vespasian and his sons, have been found. Other obelisks are known to have been removed by Constantius, 354 A. D. P. Victor, in his description of the quarters of ancient Rome, reckons 6 of the largest size and 42 others. The Romans added to them brazen spheres and other decorations. Some were removed to Constantinople by Theodosius the younger, and Valentinian, 390 A. D. The translation of the inscription of one of the Roman obelisks made by a Greek or Egyptian, named Hermapion, has been preserved by Ammanius Marcellinus.—Kircher, *Edipus Egyptianus* (tom. iii. Rom. 1652—1654); Zoega, *De Origine et Usu Obeliscorum* (fo. Rom. 1797); Cipriani, *Sui Dodici Obelisci di Roma* (fo. Rom. 1823); L'Hôte, *Notice Historique sur les Obélisques Egyptiens* (8vo, Paris, 1836); Birch, *Notes upon Obelisks, in the Museum of Classical Antiquities* (8vo, Lond. 1853), pp. 203—239; Layard, *Nineveh and its Remains*, vol. i. p. 346; Sir H. Rawlinson, *A Commentary on the Cuneiform Inscriptions* (12mo, Lond. 1850).

OBERLIN, JOHANN FRIEDRICH, distinguished for his active benevolence and usefulness, was born at Strasburg, 31st August 1740; and in 1766 became Protestant pastor of Waldbach, in the Ban de la Roche or Steintal, a wild mountainous district of Alsace. Here he spent the remainder of his life, combining an affectionate diligence in the ordinary duties of the pastorate, with wise and earnest endeavours to promote the education and general prosperity of the people. The district had suffered terribly in the Thirty Years' War, and the scanty population which remained was sunk in poverty and ignorance. O. introduced better methods of cultivating the soil, and various branches of manufacture. The population, which was scarcely 500 when he entered on his labours, had increased to 5000 at the close of the century. Yet, though animated in all his actions by the most pure and disinterested piety, it may be questioned if he did not carry his moral supervision too far when he kept a register of the moral character of his parishioners, and searched with the minuteness though not the motives of an inquisitor, into the most insignificant details of their private life. O. was ably assisted in his reformatory labours by his pious housekeeper, Luise Schepler, who survived her master eleven years. He died 1st June 1826. Notwithstanding the humble sphere in which his days were spent, his fame as a philanthropist has extended over the world, and his example has stimulated and guided many. See *Brief Memorials of Oberlin*, by the Rev. T. Sims, M.A. (Lond. 1830), and also *Memoirs of Oberlin, with a short notice of Louisa Schepler* (Lond. 1838 and 1852).

OBERON, the king of the Elves or Fairies, and the husband of Titania. The name is derived by a change of spelling from *Auberon*, more anciently *Alberon*, and that from the German *Alberich*, i. e., king of the Elves. O. is first mentioned as 'Roi du royaume de la féerie' in the old French poem *o. Huon de Bordeaux, pair de France*, which was

afterwards made the basis of a popular prose romance. From the French, O. was borrowed by the English poets, Chaucer, Spenser, and others, but he is most familiarly known from his appearance in Shakspeare's *Midsommer Night's Dream*. From old French sources, also, Wieland derived part of the materials of his poem of *Oberon*.

OBESITY, or CORPULENCE, may be defined to be 'an accumulation of fat under the integuments or in the abdomen, or in both situations, to such an amount as to embarrass the several voluntary functions.' A certain degree of fatness is not only quite compatible with health, but, as has been shewn in the article FATS, ANIMAL, the fatty tissue is of considerable use in the animal body, partly in consequence of its physical, and partly in consequence of its chemical properties; and it is only when the fatness begins to interfere with the discharge of any of the vital powers, that it can be regarded as a morbid condition. Obesity may occur at any period of life, but it is most commonly after the fortieth year that the tendency to an inordinate accumulation of fat begins to shew itself. After that time, in the case of men, the pleasures of the table are usually more attractive than in earlier life, and much less muscular exercise is taken; while in women, the cessation of the power of child-bearing induces changes which tend remarkably to the deposition of fat. The extent to which fat may accumulate in the human body is enormous. Daniel Lambert, who died at the age of forty years, weighed 739 lbs.; his exact height is not recorded, but, according to the investigations of the late Dr Hutchinson (the inventor of the spirometer), the normal weight of a man six feet high should not exceed 178 lbs. Dr Elliottson has recorded the case of a female child, a year old, who weighed 60 lbs.; and those who are interested in the subject will find a large collection of cases of obesity in Wadd's *Cursory Remarks on Corpulence*.

The predisposing causes of obesity are a peculiar habit of body, hereditarily transmitted; inactivity; sedentary occupations, &c.; while the more immediate or exciting causes are a rich diet, including fatty matters, and matters convertible in the body into fats, such as saccharine and starchy foods, and the partaking of such a diet to a greater extent than is necessary for balancing the daily waste of the tissues. 'Fat meats, butter, oily vegetable substances, milk, saccharine and farinaceous substances are the most fattening articles of food; whilst malt liquors, particularly rich and sweet ale are, of all beverages, the most conducive in promoting obesity. The fattening effect of figs and grapes, and of the sugar-cane, upon the natives of the countries where these are abundant, is well known. In various countries in Africa and the East, where obesity is much admired in females, warm baths, indolence, and living upon saccharine and farinaceous articles, upon dates, the nuts from which palm-oil is obtained, and upon various oily seeds, are the means usually employed to produce this effect.'—Copland's *Dictionary of Medicine*, article 'Obesity.' The knowledge of the means of inducing obesity affords us the best clue to the rational treatment of this affection. It is a popular belief that the administration of acids—vinegar, for example, or one of the mineral acids—will check the deposition of fat; but if the desired effect is produced, it is only at the cost of serious injury to the digestive, and often to the urinary organs. The employment of soap and alkalies, as advocated a century ago by Dr Fleming (*A Discourse on the Nature, Causes, and Cure of Corpulency*, 1760), is less objectionable than that of acids, but the prolonged use even of these is usually prejudicial. The

efficacy of one of our commonest sea-weeds, seawrack (*Fucus vesiculosus*), in this affection has lately been strongly advocated. It is prescribed in the form of an extract, and its value is probably dependent on the iodine contained in it.

A very interesting *Letter on Corpulence*, recently (1863) published by Mr Banting, in which he records the effect of diet in his own case after all medicinal treatment had failed, is well worthy of the attention of those who are suffering from the affection of which this article treats. The following are the leading points in his case. He is 66 years of age, about 5 feet 5 inches in stature (and therefore, according to Dr Hutchinson's calculations, ought to weigh about 142 lbs.), and in August 1862 weighed 202 lbs. 'Few men,' he observes, 'have led a more active life . . . so that my corpulence and subsequent obesity were not through neglect of necessary bodily activity, nor from excessive eating, drinking, or self-indulgence of any kind, except that I partook of the simple aliments of bread, milk, butter, beer, sugar, and potatoes, more freely than my aged nature required. . . . I could not stoop to tie my shoe, nor attend to the little offices humanity requires without considerable pain and difficulty; I have been compelled to go down stairs slowly backwards, to save the jar of increased weight upon the ankle and knee joints, and been obliged to puff and blow with every slight exertion' (pp. 10 and 14).

By the advice of a medical friend, he adopted the following plan of diet: 'For breakfast I take four or five ounces of beef, mutton, kidneys, broiled fish, bacon, or cold meat of any kind except pork; a large cup of tea (without milk or sugar), a little biscuit, or one ounce of dry toast. For dinner, five or six ounces of any fish except salmon, any meat except pork, any vegetable except potato, one ounce of dry toast, fruit out of a pudding, any kind of poultry or game, and two or three glasses of good claret, sherry, or Madeira: champagne, port, and beer forbidden. For tea, two or three ounces of fruit, a rusk or two, and a cup of tea without milk or sugar. For supper, three or four ounces of meat or fish, similar to dinner, with a glass or two of claret (p. 18). I breakfast between eight and nine o'clock, dine between one and two; take my slight tea meal between five and six; and sup at nine' (p. 40). Under this treatment he lost in little more than a year (between the 26th of August 1862 and the 12th of September 1863) 46 lbs. of his bodily weight, while his girth round the waist was reduced 12½ inches. He reports himself as restored to health, as able to walk up and down stairs like other men; to stoop with ease and freedom; and safely to leave off knee-bandages, which he had necessarily worn for twenty years past. He has made his own case widely known by the circulation of his pamphlet (which has now reached a third edition); and 'numerous reports sent with thanks by strangers as well as friends,' shew that (to use his own words) 'the system is a great success;' and that it is so we do not doubt, for it is based on sound physiological principles.

O'BIT (Lat. *obitus*, a 'going down,' 'death'), literally means the decease of an individual. But as a certain ecclesiastical service was fixed to be celebrated on the day of death (*in die obitus*), the name came to be applied to the service itself. Obit therefore signifies, in old church language, the service performed for the departed. It consisted, in the Roman Church, of those portions of the *Officium Defunctorum* which are called Matins and Lauds, followed by a Mass of the Dead, chanted, or occasionally read. Similar services are held on the day of the funeral, and on the 30th day, and the anni-

versary; and although the name obit was primitively applied only to the first, it has come to be used of them all indiscriminately.

OBJECT, in the language of Metaphysics, is that of which any thinking being or *Subject* can become cognizant. This subject itself, however, is capable of transmutation into an Object, for one may think about his thinking faculty. To constitute a metaphysical object, actual existence is not necessary; it is enough that it is conceived by the subject. Nevertheless, it is customary to employ the term objective as synonymous with real, so that a thing is said to be 'objectively' considered when regarded in itself, and according to its nature and properties, and to be 'subjectively' considered, when it is presented in its relation to us, or as it shapes itself in our apprehension. Scepticism denies the possibility of objective knowledge; i. e., it denies that we can ever become certain that our cognition of an object corresponds with the actual nature of that object. The verbal antithesis of objective and subjective representation is also largely employed in the fine arts, but even here, though the terms may be convenient, the difference expressed by them is only one of degree, and not of kind. When a poem or a novel, for example, obtrudes the peculiar genius of the author at the expense of a clear and distinct representation of the incident and character appropriate to itself, we say it is a subjective work; when, on the contrary, the personality of the author retires into the background, or disappears altogether, we call it objective. The poems of Shelley and Byron; the novels of Jean Paul Richter, Bulwer Lytton, and Victor Hugo; and the paintings of the Pre-Raphaelites belong essentially to the former class; the dramas of Shakspeare, the novels of Scott, and the poems of Goethe, to the latter.

OBJECT-GLASS, the glass in a Telescope (q. v.) or Microscope (q. v.), which is placed at the end of the tube nearest the object, and first receives the rays of light reflected from it.

O'BLATES (Lat. *oblatus, oblata*, 'offered up'), the name of a class of religious bodies in the Roman Catholic Church, which differ from the religious orders strictly so called, in not being bound by the solemn vows of the religious profession. The institute of oblates was one of the many reforms introduced in the diocese of Milan by St Charles Borromeo, towards the close of the 16th century. The members consisted of secular priests who lived in community, and were merely bound by a promise to the bishop to devote themselves to any service which he should consider desirable for the interest of religion. St Charles made use of their services chiefly in the wild and inaccessible Alpine districts of his diocese. This institute still exists, and has been recently introduced into England. Still more modern are the 'Oblates of the blessed Virgin Mary,' a body of French origin, which arose in the present century, and has been very widely extended; and whose chief object is to assist the parochial clergy, by holding missions for the religious instruction of the people in any district to which they may be invited. This body also has been established in England and in Ireland. Other similar institutes might be enumerated, but the constitution of all is nearly the same. There is also a female institute of oblates, which was established in Rome, about 1440, by St Francisca of Rome, and which consists of ladies associated for charitable and religious objects, and living in community, but bound only by promise, and not by vow.

OBLIGATION is a term used in Scotch Law to denote the binding effect of any legal contract, and

is often used synonymously with contract or promise. An obligation is said to be pure when it may be instantly demanded (called in England an absolute contract). An obligation is conditional when it depends, for its legal effect, on some event which may or may not happen. Obligations are also divided into verbal and written.

**OBLIGATO**, in Music. When a musical composition is constructed in more than one part, any part is said to be obligato which is not merely employed to strengthen the others, but is necessary to the melodic perfection of the whole. An accompaniment is said to be obligato which does not consist of mere chords, but has its own melody.

**OBOE**. See **HAUTOY**.

**O'BOLUS** (Gr. *obolos* or *obelos*, a spit), the smallest of the four common Greek coins and weights, was originally, as is generally supposed, a small piece of iron or copper, similar in form to the head of a spit, or spear head, whence its name. In this form it was used as a coin, and a handful of 'oboli' was equivalent to a Drachma (q. v.). It was subsequently coined of silver, and in the ordinary round form, but still retained its original name; its value, both as a coin and a weight, was now fixed as the  $\frac{1}{4}$ th part of a drachma, so that in the Attic system it was equivalent to  $1\frac{1}{4}$ d. and  $1\frac{1}{2}$  Troy grains respectively; while the Æginetan obolus was worth  $2\frac{1}{4}$ d. as a coin, and  $2\frac{1}{2}$  Troy grains as a weight. Multiples and submultiples of this coin were also used, and pieces of the value of 5, 4, 3, 2,  $1\frac{1}{4}$  oboli, and of  $\frac{1}{2}$ ,  $\frac{1}{3}$ , and  $\frac{1}{4}$  of an obolus respectively, are to be found in collections of coins.

**O'BRIEN, WILLIAM SMITH**, born in 1803, is the second son of the late Sir Edward O'Brien, Bart. of Dromoland, in the county of Clare, Ireland, and brother of the present Lord Inchiquin; that ancient barony having recently passed to the Dromoland O'Briens on the failure of the elder branch. W. S. O. was educated at Harrow School, whence he passed to Trinity College, Cambridge. He entered parliament for the borough of Ennis in 1826, and was a warm supporter of Catholic emancipation. In 1835, he was returned on advanced liberal principles for the county of Limerick, and for several years strongly advocated the claims of Ireland to a strictly equal justice with England, in legislative as well as executive measure. Professing his inability to effect this in the united legislature, and having embroiled himself with the Speaker by refusing to serve on committees (for which refusal he was committed to prison in the House by the Speaker's order), he withdrew from attendance in parliament in 1841, and joined actively with Daniel O'Connell (q. v.) in the agitation for a repeal of the legislative union between England and Ireland. In the progress of that agitation, a division having arisen on the question of moral as against physical force between O'Connell and the party known as 'Young Ireland,' O. sided with the latter; and when the political crisis of 1848 eventuated in a recourse to arms, he took part in an attempt at rebellion in the south of Ireland, which in a few days came to an almost ludicrous conclusion. He was in consequence arrested, and having been convicted, was sentenced to death. The sentence, however, was commuted to transportation for life; and after the restoration of tranquillity in the public mind in Ireland, he, in common with the other political exiles, was permitted to return to his native country. From that date (1856) he has spent much of his time in foreign travel; and although he has written more than once in terms of strong disapproval of the existing state of things, he has abstained from

all active share in the political proceedings of any party.

**OBSCENE PRINTS, BOOKS, or PICTURES**, exhibited in public render the person so doing liable to be indicted for a misdemeanour. Persons exposing them in streets, roads, or public places, are also liable to be punished as rogues and vagabonds with hard labour. An important change in the law was effected by Lord Campbell's Act (20 and 21 Vict. c. 83), which was passed to suppress the traffic in obscene books, pictures, prints, and other articles. Any two justices of the peace, or any police magistrate, upon complaint made before him on oath that such books, &c., are kept in any house, shop, room, or other place, for the purpose of sale, or distribution, or exhibition for gain or on hire, and that such things have been sold, &c., may authorise a constable to enter in the daytime, and, if necessary, use force by breaking open doors, or otherwise to search for and seize such books, &c., and carry them before the magistrate or justices, who may, after giving due notice to the occupier of the house, and being satisfied as to the nature and object of keeping the articles, cause them to be destroyed.

**OBSCURANTISTS**, the name given, originally in derision, to a party who are supposed to look with dislike and apprehension on the progress of knowledge, and to regard its general diffusion among men, taken as they are ordinarily found, as prejudicial to their religious welfare, and possibly injurious to their material interests. Of those who avow such a doctrine, and have written to explain and defend it, it is only just to say that they profess earnestly to desire the progress of all true knowledge as a thing good in itself; but they regard the attempt to diffuse it among men, indiscriminately, as perilous, and often hurtful, by producing presumption and discontent. They profess but to reduce to practice the motto—

A little learning is a dangerous thing.

It cannot be doubted, however, that there are fanatics of ignorance as well as fanatics of science.

**OBSERVANTISTS, or OBSERVANT FRANCISCANS**. Under the head FRANCISCANS (q. v.) has been detailed the earlier history of the controversies in that order on the interpretation of the original rule and practice established by St Francis for the brethren, and of the separate organisation of the two parties at the time of Leo X. The advocates of the primitive rigour were called *Observantes*, or *Strictioris Observantiz*, but both bodies were still reputed subject, although each free to practise its own rule in its own separate houses, to the general administrator of the order, who, as the rigorists were by far the more numerous, was a member of that school. By degrees, a second reform arose among a party in the order, whose zeal the rigour of the O. was insufficient to satisfy, and Clement VII. permitted two Spanish friars, Stephen Molena and Martin Guzman, to carry out in Spain these views in a distinct branch of the order, who take the name of *Reformati*, or Reformed. This body has in later times been incorporated with the O. under one head. Before the French Revolution, they are said to have numbered above 70,000, distributed over more than 3000 convents. Since that time, their number has, of course, been much diminished; but they still are a very numerous and widespread body, as well in Europe as in the New World, and in the missionary districts of the East. In Ireland and England, and for a considerable time in Scotland, they maintained themselves throughout all the rigour of the penal

## OBSERVATION AND EXPERIMENT—OBSERVATORY.

times. Several communities are still found in the two first-named kingdoms.

**OBSERVATION AND EXPERIMENT** are the leading features of modern science, as contrasted with the philosophy of the ancients. They are indispensable as the bases of all human knowledge, and no true philosophy has ever made progress without them, either consciously or unconsciously exercised. Thus, by Socrates, Plato, and Aristotle, no less than by Archimedes and the ancient astronomers, observation and experiment are extensively though not prominently or always obviously employed; and it was by losing this clue to the spirit of their masters' teaching, that the later disciples in these schools of philosophy missed the path of real progress in the advancement of knowledge. It was in the latter half of the 16th c. that the minds of philosophers were first *consciously* awakened to the importance of observation and experiment, as opposed to authority and abstract reasoning. This result was first occasioned by the discoveries and controversies of Galileo in Florence; and to the same end were contributed the simultaneous efforts of a number of philosophers whose minds were turned in the same direction—Tycho Brahe in Holland, Kepler in Germany, William Gilbert in England, who were shortly afterwards followed by a crowd of kindred spirits. The powerful mind of Francis Bacon lent itself to describe the newly-awakened spirit of scientific investigation, and though he ignored or affected to despise the results achieved by the great philosophers just mentioned, he learned from them enough to lay the foundation of a philosophy of inductive science, which, if we look at the course of scientific progress since his day, seems to have been almost prophetic. The difference between observation and experiment may be said to consist in this, that by observation we note and record the phenomena of nature as they are presented to us in her ordinary course; whereas by experiment we note phenomena presented under circumstances artificially arranged for the purpose. Experiment is thus the more powerful engine for discovery, since one judiciously conducted experiment may provide the data which could only result from a long course of observations.

**OBSERVATORY**, an institution supplied with instruments for accurately observing and recording the position of the heavenly bodies, and superintended by an astronomer, with usually one or more assistants. The objects to which the work of an observatory is directed are, 1st, The ascertainment of elements necessary to the science of theoretical and physical astronomy; 2d, The accurate measurement and publication of time. A third object, namely, the observation of meteorological phenomena, though not a necessary part of the work of an observatory, is often combined with the above. It often happens that the purpose for which a particular observatory is instituted has especial reference to *one* of the above objects, and in most observatories the character of the instruments possessed is more especially fitted for some classes of observations than for others. Since, therefore, almost every civilised country possesses one or more observatories of excellent character, the time of the observers in each is often better employed in carrying out those classes of observations for which they have special opportunities, than by attempting observations of more various kinds. Thus, almost every observatory has some distinctive feature of its own.

The ancients have made no mention of observatories, though we are told that Hipparchus made

his observations at Rhodes, and Ptolemy at Alexandria, the latter astronomer possessing the greatest collection of astronomical instruments then in use; so we are led to conclude, that among the ancients it was not the custom to erect houses exclusively adapted for astronomical observations. The case was very different with the Arabs, who erected observatories in all parts of their empire, the chief of which were those of Cairo, two in number; the Bagdad observatory; the celebrated one of Meraghah, superintended by Nazir-ed-din; and last, and greatest of all, that of Samarkand, erected by the celebrated Ulugh Beg (q. v.). Observatories are also found in various parts of China.

The principal instruments in general use in an observatory are the Transit Instrument (q. v.), the Mural Circle (see **CIRCLE, MURAL**), the Equatorial (q. v.), and the Sidereal Clock (q. v.). The altitude and azimuth instrument, or altazimuth (see **ALTITUDE**), is sometimes added, and the transit instrument and mural circle are sometimes combined in a single instrument called the transit circle. For meteorological observations, the principal instruments are the barometer, the thermometer, the rain-gauge, and the anemometer (q. v.), or instrument for measuring and registering the force and direction of the wind. We proceed to notice some of the principal existing observatories, more particularly those belonging to Britain.

The principal observatory in England is the Royal Observatory of Greenwich, under the direction of the Astronomer-Royal (now Mr Airy), with a staff at present of six assistants and six computers, with other supernumerary computers occasionally employed. The publications consist of a large volume yearly of observations in a reduced form, prepared under the superintendence of the astronomer-royal, the initials of the particular observer being given with each observation. The most important instrument in this observatory is the great transit circle, erected in the year 1850, and brought into use at the beginning of 1851. It was constructed by Messrs Ransomes and May as engineers, and Mr Simms as optician. The length of the telescope is nearly 12 feet, the clear aperture of the object-glass 8 inches, and the length of axis between the pivots 6 feet. For determining the error of collimation there are two horizontal telescopes, of about 5 feet focal length, and 4 inches aperture, one north, and the other south of the instrument. There is a chronographic apparatus, which registers the transits through a galvanic contact, made by the hand of the observer, on a paper stretched over a drum in connection with the sidereal clock. A massive altitude and azimuth instrument, erected in 1847, was constructed under the direction of the astronomer-royal, on peculiar principles of solidity and strength, for the purpose of making extra-meridional observations of the moon, which are effected by it with an accuracy equal to those made on the meridian. There are three telescopes in use, with equatorial mounting. The great equatorial was constructed by Messrs Ransomes and Sons as engineers, and Mr Simms as instrument-maker and optician. The object-glass by Messrs Merz and Son of Munich has a clear aperture of about 12½ inches, and a focal length of 16 feet 6 inches. The observatory at Greenwich was the first to employ galvanic signals on an extensive scale in the transmission of time. By this means, since the year 1852, a time-ball has been dropped on the dome of the Observatory, and also at the office of the Electric Telegraph Company in London, at precisely one o'clock. By means of the telegraph-wires, also, the longitude of the other principal observatories

throughout the kingdom has been accurately determined.

The observatory of Cambridge had its building completed in 1824, and its first director was Professor Woodhouse. It is now (1864) under the direction of Mr Adams, well known in connection with the discovery of the planet Neptune. The observatory was at first furnished only with a 10-foot transit instrument by Dollond. To this was added, in 1832, an 8-foot mural circle by Troughton and Simms, and a 5-foot equatorial by Jones. The Northumberland Telescope, so called from its donor the Duke of Northumberland, was erected under the direction of Mr Airy in 1838. This fine telescope, which is equatorially mounted, is of nearly 20 feet focal length, and has an object-glass with a clear aperture of 11½ inches. It has been actively employed in observations of the planets and planetoids. The observatory is about shortly to be furnished with a transit circle, on the principle of the Greenwich instrument (1854). It was while in the Cambridge Observatory that Mr Airy first introduced the principle which he has since actively followed up, and which has been extensively imitated, of thoroughly reducing every observation before its publication.

The Radcliffe Observatory at Oxford was erected about the year 1774. In July 1861 was purchased for this observatory Mr Carrington's transit circle, formerly used by him at Red Hill. It possesses a fine heliometer, erected in 1850 by the Messrs Repsold of Hamburg, the object-glass by Messrs Mers of Munich, of 10½ feet focal length, and 7½ inches aperture.

The Royal Observatory of Edinburgh is situated on the Calton Hill there. It had its origin in a private astronomical institution; but it has been transferred to the crown, on condition of the latter taking upon itself the sole charge of defraying the expenses of the establishment, and of providing for its adequate and perpetual maintenance. It has recently taken a distinguished place as a time-keeping observatory, and by means of its mean-time clock, fitted with a pendulum on the principle of Mr Jones's recent invention (see ELECTRIC CLOCK), time-guns are fired from Edinburgh Castle, at Newcastle, and in Glasgow precisely at one o'clock. The present astronomer is Mr Piazzi Smyth, who has taken an active part in the introduction of these useful measures.

Among the observatories in the British dominions, that at the Cape of Good Hope, founded in 1821, in pursuance of an order in council made in 1820 at the instigation of the then existing Board of Longitude, holds a distinguished place, both with regard to the excellence of its instruments and the importance of the observations which have been there made by several of its directors.

Among foreign observatories, those of most note are the observatory of Paris, commenced under the directorship of the celebrated Dominique Cassini; the observatory of Berlin, of recent date, but fitted with excellent instruments; the observatories of Göttingen and Königsberg; those of Dorpat and Pulkowa, in Russia; and those of Milan, Florence, &c., in Italy.

Of observatories especially devoted to particular and practical objects, the observatory of Liverpool, as conducted under its present able director, Mr Hartnup, deserves especial mention. This observatory was established in 1844 by the corporation of Liverpool, in order to obtain, with all practicable accuracy, the longitude of Liverpool, and then to obtain and preserve the Greenwich time for the benefit of the port of Liverpool, by rating and testing chronometers, and by giving the

necessary information to mariners, chronometer-makers, and professional raters of chronometers. On the 8th January 1858, the observatory was transferred by an act of parliament to the Mersey Docks and Harbour Board. The principal instruments possessed by the observatory for the carrying out of the main object—namely, that of obtaining and preserving correct time—are an excellent transit instrument of about four feet focal length, a sidereal clock, and a mean-time clock. Besides these means of obtaining accurate time, there is now in use an admirable arrangement for testing the rates of chronometers at various temperatures, in which branch of practical horology, as well as in the adaptation of electricity to the publication of time through the contrivance patented by Mr R. L. Jones of Chester, this observatory has taken the lead of all other establishments (see ELECTRIC CLOCK, HOROLOGY, WATCH). When it is remembered that each error of 4" in a chronometer corresponds to a geographical mile of longitude upon the equator, the importance of extreme accuracy in these rating observations cannot be overestimated. The Liverpool observatory is also provided with excellent meteorological instruments, especially a self-registering barometer on a new construction by Mr King of Liverpool, and an anemometer, which registers the force and direction of the wind. The record kept by all these instruments consists of tracings on a paper, by which the registered phenomena during any twenty-four hours are seen at a glance. The observatory also possesses a good equatorial, which has been extensively used for determining with accuracy the positions of the small members of the solar system revolving between Mars and Jupiter—a class of observations to which the instrument is peculiarly adapted, and which are important towards supplying data for increasing the accuracy of navigation.

Private observatories are perhaps most usefully directed to meteorological observations, or to observations with one good telescope equatorially mounted. An instrument of this kind has lately been very successfully employed by Professor Piazzi Smyth of Edinburgh, in the micrometrical measurement of double-stars, with reference to the determination of their proper motions. This instrument is a large equatorially-mounted refracting telescope, erected by J. W. Grant, Esq., of Elchies, in Morayshire. The clear aperture of the object-glass is 11 inches; and the great weight and massive construction of the larger parts is the cause of a peculiar freedom from tremors, which render the instrument peculiarly adapted for observations of the class above described. These observations are recorded in the *Transactions of the Royal Society of Edinburgh*, vol. xxiii. p. 371. This is the largest and best instrument of the kind in Scotland.

OBSIDIAN, a mineral accurately described by Pliny under the name which it still bears. It is a true kind of native glass, composed of silica (from 70 to 80 per cent.), alumina, lime, soda, potash, and oxide of iron. It is hard and brittle, with remarkably vitreous lustre, and perfectly conchoidal fracture, the edges of the fractures very sharp and cutting like glass. It varies from semitransparency to translucency only on the edges. It is often black, or very dark gray; sometimes green, red, brown, striped, or spotted; and sometimes *chatoyant* or *aventurine*. It occurs in volcanic situations, and often in close connection with pumice, in roundish compact pieces, in grains, and in fibres. It is capable of being polished, but is apt to break in the process. It is made into boxes, buttons, ear-drops, and other ornamental articles; and before



the uses of the metals were well known, it was employed, in different parts of the world, for making arrow and spear heads, knives, &c. It is found in Iceland, the Lipari Isles, Vesuvius, Sardinia, Hungary, Spain, Teneriffe, Mexico, South America, Madagascar, Siberia, &c. Black O. was used by the ancients for making mirrors, and for this purpose was brought to Rome from Ethiopia. It was used for the same purpose in Peru and Mexico. Mirrors of Black O. are indeed still employed by artists. Chatoyant or Avaturine O. is very beautiful when cut and polished, and ornaments made of it are sold at a comparatively high price.

O'BVERSE, or FACE, the side of a coin or medal which contains the principal device or inscription, the other side being in contradistinction called the Reverse. See NUMISMATICS.

OCCAM, WILLIAM OF, surnamed *Doctor Singularis et Invincibilis*, a famous schoolman, was born in England, at the village of Ockam, in the county of Surrey, about the year 1270. We do not possess any precise or satisfactory knowledge of his early life. He is said to have been educated at Merton College, Oxford, and to have held several benefices in his native country, but soon after resigned them on entering the Franciscan order. Early in the 14th c., it is supposed he proceeded to Paris, where he attended the lectures of Duns Scotus, of whose philosophy he was afterwards the most formidable opponent. Here he soon became prominent by the boldness of his ecclesiastical views. Philippe, *le Bel*, king of France, having forbidden Pope Boniface VIII. to levy contributions in his dominions, the latter, by way of retaliation, excommunicated him. O. rushed to the defence of the monarch, and in his *Disputatio inter Clericum et Militem, super Potestate Prelatis Ecclesia atque Principibus Terrarum Commissa*, denies that the popes have any authority in temporal affairs, and boldly declares that all who favoured such a doctrine ought to be expelled from the church as heretics. Meanwhile, from being a listener, he had become a lecturer in philosophy. The system which he advocated—for he was not properly its originator—is known by the name of *Nominalism* (q. v.), but it had never before received so rigorously logical and rational a treatment; hence his epithet of *Invincibilis*. The work in which his views are set forth is entitled *Expositio Aurea, et admodum utilis super totam Artem Veterem*. It contains a series of commentaries upon the *Isagoge* of Porphyry, and on the *Categories* and *Interpretation* of Aristotle, with a special treatise headed *Tractatus Communitatum Porphyrii*, and a theological opusculum on Predestination. It is intended as a demolition of the moderns—i. e., the scholastics—and shews that in their method they have completely departed from the principles and methods of the great Stagyrte, for whom, like every sound and solid thinker, he shews the deepest respect and admiration. About 1320 or 1321, he again plunged into ecclesiastical controversy. A certain Narbonese priest, having affirmed that Jesus Christ and his apostles held everything in common, and that every ecclesiastical possession is a modern abuse, was pounced upon by the inquisitors, and defended by a certain Berenger Talon, a Franciscan monk of Perpignan. But Berenger's defence of apostolical poverty was naturally enough very disagreeable to the pope, John XXII., who therefore condemned it. Berenger was, however, vigorously supported by his order, and among others by Michael de Cesena, the general-superior, Bonagratia of Bergamo, and William of Occam, who attacked the pope with great vehemence and trenchant logic. Shortly after

they were arrested as favourers of heresy, and imprisoned in Avignon. But while their trial was proceeding, Michael de Cesena and O., knowing what little mercy or justice they had to expect from their accusers and judges, made their escape to the Mediterranean, and were received at a little distance off shore on board a galley of Ludwig, king of Bavaria, the patron of the Franciscan anti-pope, Peter of Corbaras, and one of the most powerful sovereigns in Europe. The remainder of O.'s life was spent at Munich, where, safe from the machinations of his enemies, he continued to assail at once the errors of papistry in religion, and of realism in philosophy. He died 7th April 1347. It is impossible to praise O. too highly. He was the first logician, and the most rational philosopher among the whole body of schoolmen. We are often reminded by his clear and vigorous common sense and wholesome incredulity, that he was the countryman of Locke and Hobbes, and that he came of a people ever noted for the solidity of their understanding. Besides the works already mentioned, O.'s principal writings are—*Dialogus in tres Partes distinctus, quarum prima de Hæreticis, secunda de Erroribus Joannis XXII., tertia de Potestate Papæ, Conciliorum et Imperatoris; Opus Nonaginta Dierum contra Errores Joannis XXII.; Compendium Errorum Joannis Papæ XXII.; Decisiones Octo Questionum de Potestate summi Pontificis; Super Quatuor Libros Sententiarum Subtilissimas Questiones earumque Decisiones* (based on Peter the Lombard's famous *Sententia*, and containing nearly the entire theology of Occam. These *Decisiones* were long almost as renowned as the *Sententia*, which gave them birth); *Antiloquium Theologicum; Summa Logices ad Adamum*; and *Major Summa Logices*.—See Luke Wadding's *Scriptores Ordinis Minorum* (1650); Cousin's *Histoire de la Philosophie* (2d ed. 1840); and B. Hauréau's *De la Philosophie Scholastique* (1848).

OCCA'SIONALISM, or the doctrine of OCCASIONAL CAUSES (see CAUSE), is the name given to the philosophical system devised by Descartes and his school, for the purpose of explaining the action of mind upon matter, or, to speak more correctly, the combined, or at least the synchronous action of both. It is a palpable fact that certain actions or modifications of the body are accompanied by corresponding acts of mind, and *vice versa*. This fact, although it presents no difficulty to the popular conception, according to which each is supposed to act directly upon the other—body upon mind, and mind upon body—has long furnished to philosophers a subject of much speculation. But on the other hand, it is difficult to conceive the possibility of any direct mutual interaction of substances so dissimilar, or rather so disparate. And more than one system has been devised for the explanation of the problem, as to the relations which subsist between the mind and the body, in reference to those operations, which are clearly attributable to them both. According to Descartes and the Occasionalists, the action of the mind is not, and cannot be the cause of the corresponding action of the body. But they hold that whenever any action of the mind takes place, God directly produces, in connection with it, and by reason of it, a corresponding action of the body; and in like manner conversely, they explain the coincident or synchronous actions of the body and the mind. It was in opposition to this view that Leibnitz, believing the Cartesian system to be open to nearly equal difficulties with that of the direct action, devised his system of *Pre-established Harmony*. See LEIBNITZ. His real objection to the Occasionalist hypothesis is, that it supposed a

perpetual action of God upon creatures, and, in fact, is but a modification of the system of 'direct assistance.'

**OCCULTATIONS** (Lat. *occultatio*, a concealment) are neither more nor less than 'eclipses;' but the latter term is confined by usage to the obscuration of the sun by the moon, and of the moon by the earth's shadow, while the former is restricted to the eclipses of stars or planets by the moon. Occultations are phenomena of frequent occurrence; they are confined to a belt of the heavens about 10° 17' wide, situated parallel to, and on both sides of the equinoctial, and extending to equal distances north and south of it, being the belt within which the moon's orbit lies. These phenomena serve as data for the measurement of the moon's parallax; and they are also occasionally employed in the calculation of longitude. As the moon moves in her orbit from west to east, the occultation of a star is made at the moon's eastern limb, and the star emerges on the western limb. When a star is occulted by the dark limb of the moon (a phenomenon which can only occur between new moon and full moon), it appears to an observer as if it were suddenly extinguished, and this appearance is most deceptive when the moon is only a few days old. When an occultation occurs between full moon and new moon, the reappearance of the star at the outer edge of the dark limb produces an equally startling effect. 'It has often been remarked,' says Herschel, 'that when a star is being occulted by the moon, it appears to advance actually upon and within the edge of the disc before it disappears, and that sometimes to a considerable depth.' This phenomenon he considers to be an optical illusion, though he admits the possibility of its being caused by the existence of deep fissures in the moon's substance. Occultations of stars by planets and their satellites are of rarer occurrence than lunar occultations, and still more unfrequent are the occultations of one planet by another. Occultations are calculated in the same way as eclipses, but the calculation is simplified in the case of the fixed stars, on account of their having neither sensible motion, semi-diameter, nor parallax.

**OCEAN**, a term which, like SEA, in its general acceptance, denotes the body of salt water that separates continent from continent, and is the receptacle for the waters of rivers. The surface of the ocean is about three-fifths of the whole surface of the earth. Although no portion of it is completely detached from the rest, the intervening continents and islands mark it off into divisions, which geographers have distinguished by special names: the *Atlantic Ocean* (q. v.), between America and Europe and Africa; the *Pacific Ocean* (q. v.), between America and Asia; the *Indian Ocean* (q. v.), lying south of Asia, and limited on the east and west by Australasia and South Africa; the *Arctic Ocean* (q. v.), surrounding the north pole; and the *Antarctic Ocean* (q. v.), surrounding the south pole. The general features and characteristics of the ocean will be described under SEA.

**OCEANIA**, the name given to the fifth division of the globe, comprising all the islands which intervene between the south-eastern shores of the continent of Asia and the western shores of the American continent. It naturally divides itself into three great sections—Malay Archipelago (q. v.), Australasia (q. v.), or Melanesia and Polynesia (q. v.).

**OCELOT**, the name of several species of *Felidae*, allies of the leopard by flexibility of body, length of tail, and other characters, but of much smaller

size. They are usually included in the genus *Leopardus* by those who divide the *Felidae* into a number of genera. They are inhabitants of forests, and very expert in climbing trees. Their prey consists in great part of birds. They are beautifully marked and coloured. The best known species, or COMMON O. (*Felis pardalis*), a native of the warm parts of America, from Mexico to Brazil, is



Ocelot (*Felis pardalis*).

from two feet nine inches to four feet long, exclusive of the tail, which is from eleven to fifteen inches, and nearly of uniform thickness. The ears are thin, short, and pointed. The muzzle is rather elongated. The colours vary considerably, but the ground tint is always a rich red or tawny colour, blending finely with the dark brown on the margins of the open spots, of which there are chains along the sides; the head, neck, and legs being also variously spotted or barred with dark brown or black. The O. is easily tamed, and is very gentle and playful, but excessively mischievous. It may be fed on porridge and milk, or other such food, and is said to be then more gentle than if permitted to indulge in carnivorous appetites.—Very similar to the Common O. are several other American species, as the LINKED O. (*F. catenata*), the LONG-TAILED O. (*F. macrourus*), the CHATI (*F. mitis*), &c. The similarity extends to habits and disposition, as well as form.

**O'CHIL HILLS**, a hilly range in Scotland, occupying parts of the counties of Perth, Clackmannan, Stirling, Kinross, and Fife, and extending from the vicinity of Stirling north-east to the Firth of Tay. The range is 24 miles in length, and about 12 miles in breadth. The highest summit is Bencleugh, (2352 feet) near the south-west extremity. The hills, which are formed chiefly of greenstone and basalt, contain silver, copper, and iron ores, and afford excellent pasturage.

**OCHNACEÆ**, a natural order of exogenous plants, containing not quite 100 known species, natives of tropical and subtropical countries. Some of them are trees, most of them under-shrubs; all are remarkable for their smoothness in all parts. Bitter and tonic qualities prevail in this order, and some species are medicinally used in their native countries. The seeds of *Gomphia jabotapita* yield an oil, which is used in salads in the West Indies and South America.

**OCHRES**, the name usually applied to clays coloured with the oxides of iron in various proportions, giving to the clay a lighter or deeper colour. Strictly speaking, the term belongs only to a combination of peroxide of iron with water. From many mines large quantities of water charged with ferruginous mud are being continually pumped up, and from this water the coloured mud or ochre settles. In this way large quantities are procured from the tin mines of Cornwall, and the lead and copper mines of North Wales and the Isle of Man. Ochres occur also ready formed, in beds several feet

thick, in the various geological formations, and are occasionally worked, as at Shotover Hill, Oxford, in Holland, and many other places in Europe and America. Very remarkable beds are worked in Canada. The ochres so obtained are either calcined for use or not, according to the tint wanted. The operation adds much to the depth of colour, by increasing the degree of oxidation of the contained iron. The most remarkable varieties of ochre are the Siena Earth (*Terra di Siena*) from Italy; the so-called red chalk, with which sheep are marked; Dutch Ochre; Armenian Bole or Lemnian Earth; Italian Rouge, and Bitry Ochre. They vary in colour from an Isabelline yellow, through almost every shade of brown, up to a tolerably good red. The finest kinds are used by painters, the coarsest by carpenters for marking out their work, by farmers for marking cattle, &c.

**O'CHRO.** See **HIBISCUS**.

**OCKMUL'GEE**, a river in Georgia, U. S., which rises in the northern centre of the state by three branches, and after a course of 200 miles south-south-east, joins the Oconee, to form the Altamaha. It is navigable to Macon, 130 miles above its mouth.

**OCO'NEE**, a river of Georgia, U. S., rises in the north-east part of the state, and flows southerly 250 miles, where it unites with the Ockmulgee to form the Altamaha; it is navigable to Milledgeville, 100 miles.

**O'CONNELL, DANIEL**, eldest son of Mr Morgan O'Connell of Darrynane, near Cahirciveen, in the county of Kerry, Ireland, was born August 9, 1775. His family was ancient, but straitened in circumstances. O'C. received his first education from a hedge-schoolmaster, and after a further training under a Catholic priest in the county of Cork, was sent in 1790 to the English College at St Omer. His school reputation was very high; but he was driven home prematurely by the outbreak of the Revolution, and in 1794, entered as a law-student at Lincoln's Inn. In 1798, he was called to the bar; and it was the boast of his later career as an advocate of the Repeal of the Union with England, that his first public speech was delivered at a meeting in Dublin, convened for the purpose of protesting against that projected measure. He devoted himself assiduously, however, to the practice of his profession, in which he rose steadily. By degrees, the Roman Catholic party having begun to rally from the prostration into which they had been thrown through the rebellion of 1798 and its consequences, O'C. was drawn into public political life. In all the meetings of his co-religionists for the prosecution of their claims, he took a part, and his unquestioned ability soon made him a leader. He was an active member of all the successive associations which, under the various names of 'Catholic Board,' 'Catholic Committee,' 'Catholic Association,' &c., were organised for the purpose of procuring the repeal of the civil disabilities of the Catholic body. Of the Catholic Association he was himself the originator; and although his supremacy in its councils was occasionally challenged by some aspiring associates, he continued all but supreme down to its final dissolution. By means of this association, and the 'Catholic Rent' which it was enabled to raise, he created so formidable an organisation throughout Ireland, that it gradually became apparent that the desired measure of relief could not longer be safely withheld; and the crisis was precipitated by the bold expedient adopted by O'C., of procuring himself to be elected member of parliament for Clare in 1828, notwithstanding his well-known legal incapacity to serve in parliament, in consequence of his being obliged to refuse the

prescribed oaths of abjuration and supremacy, which then formed the ground of the exclusion of Roman Catholics from the legislature. This decisive step towards the settlement of the question, although it failed to procure for O'C. admission to parliament, led to discussions within the House, and to agitations outside, so formidable, that in the beginning of the year 1829, the Duke of Wellington and Sir Robert Peel found it expedient to give way; and, deserting their former party, they introduced and carried through, in the spring of that year, the well-known measure of Catholic Emancipation. O'C. was at once re-elected, and took his seat for Clare, and from that date until his death continued to sit in parliament. He was elected for his native county in 1830, for the city of Dublin in 1836, for the town of Kilkenny in 1836 (having been unseated for Dublin on petition), for Dublin again in 1837, and for the county of Cork in 1841. During all these years, having entirely relinquished his practice for the purpose of devoting himself to public affairs, he received, by means of an organised annual subsidy, a large yearly income from the voluntary contributions of the people, by whom he was idolised as their 'Liberator'; and who joined with him in all the successive agitations against the act of Union, against the Protestant Church establishment, and in favour of reform, in which he engaged. In the progress of more than one of these political agitations, his associations were suppressed by the government; and the agitation for a Repeal of the Union, recommenced in 1841, and carried on by 'monster meetings' throughout Ireland, at which O'C. himself was the chief speaker, assumed proportions so formidable, that he, in common with several others, was indicted for a seditious conspiracy, and after a long and memorable trial, was convicted, and sentenced to a year's imprisonment, with a fine of £2000. This judgment was reversed by the House of Lords; and O'C., on his discharge, resumed his career; but his health had suffered from confinement, and still more from dissensions and opposition in the councils of his party; and as, on the return of the Whigs to power in 1846, he consented to support their government, the malcontents of the Repeal Association openly separated from him, and a bitter feud between 'Young' and 'Old' Ireland ensued. In this quarrel, O'C. steadfastly maintained his favourite precept of 'moral force,' and was supported by the great body of the Catholic bishops and clergy; but his health gave way in the struggle. He was ordered to try a milder climate; and on his journey to Rome in the spring of 1847, he was suddenly seized with paralysis, and died at Genoa on the 15th May of that year. His eminence as a public speaker, and especially as a master of popular eloquence, is universally admitted. Into the controversies as to his public and political character, it is not our place to enter here. His speeches unfortunately were for the most part extempore, and exist but in the reports (uncorrected by himself) taken at the time. He published but a single volume, *A Memoir of Ireland, Native and Saxon*, and a few pamphlets; the most important of which, as illustrating his personal history and character, is *A Letter to the Earl of Shrewsbury*.—See *Life and Times of Daniel O'Connell*, by his son, John O'Connell; also *Recollections of Daniel O'Connell*, by John O'Neill Daniel; and Fagan's *Life of Daniel O'Connell*.

**O'CTAGON**, a plane closed figure of eight sides. When the sides are equal, and also the angles, the figure is called a 'regular octagon'; in this case, each angle is 135°, or equal to three half right angles. If the alternate corners of a regular octagon be joined, a square is constructed; and as the angle contained

## OCTAHEDRON—OD,

between the sides of the square and of the octagon is one-fourth of a right angle, the octagon may easily be constructed from the square as a basis.

**OCTAHEDRON** (Gr. *okto*, eight, *hedra*, base) is a solid figure bounded by eight triangles, and having twelve edges and six angles. A regular octahedron has its eight triangular faces all equilateral, and may, for convenience, be defined as a figure composed of two equal and similar square pyramids with equilateral triangles for their sides placed base to base. This solid is symmetrical round any angle, and is one of Plato's five regular solids. The octahedron appears in nature as one of the forms of crystals of sulphur.

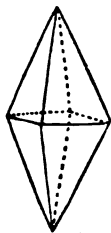

Octahedron.

**OCTAVE** (Lat. *octavus*, eighth), the interval between any musical note and its most perfect concord, which is double its pitch, and occupies the position of the eighth note from it on the diatonic scale. The name octave is often given to the eighth note itself as well as to the interval. There is between a note and its octave a far closer relation than between any other two notes; they go together almost as one musical sound. In combination, they are hardly distinguishable from one another, and their harmonics agree invariably, a coincidence which occurs in the case of no other interval.

**OCTA'VIA**, the sister of the Roman emperor Augustus, and wife of Mark Antony. She was distinguished for her beauty, her noble disposition, and womanly virtues. Her first husband was C. Marcellus, to whom she was married 50 B.C. He died 41 B.C., shortly after which she consented to marry Antony, to make secure the reconciliation between him and her brother. The event was hailed with joy by all classes. In a few years, Antony became tired of his gentle and virtuous spouse, and forsook her for Cleopatra. When the Parthian War broke out, O. wanted to accompany her husband, and actually went as far as Corcyra, whence Antony sent her home, that she might not interrupt his guilty intercourse with the Egyptian queen. In 35 B.C., O. made an effort to rescue him from a degradation that was indifferent even to the honour of the Roman arms, and sailed from Italy with reinforcements; but a message reached her at Athens ordering her to return home. She proudly obeyed, but, with a magnanimity that reminds us of the Roman character in earlier and better days, she forwarded the supports to her husband. Her brother, Octavian, was indignant at the treatment she received, and would have had her quit her husband's house, and come and live with him; but she refused. In 32 B.C., war, long inevitable, broke out between Antony and Octavian; and the former crowned his insults by sending O. a bill of divorcement. But no injury was too great to be forgiven by this 'patient Grizel' of the ancient world; and after her husband's death, she brought up with maternal care not only her own children, but also Cleopatra's bastards. Her death took place 11 B.C.

**OCTO'BER** (Lat. *octo*, eight) was the eighth month of the so-called 'year of Romulus,' but became the tenth when (according to tradition) Numa changed the commencement of the year to the first of January, though it retained its original name. It has since maintained its position as the tenth month of the year, and has 31 days. October preserved its ancient name notwithstanding the attempts made by the Roman senate, and the emperors Commodus and Domitian, who substituted for a time the terms Faustinus, Invictus,

Domitianus. Many Roman and Greek festivals fell to be celebrated in this month, the most remarkable of which was the sacrifice at Rome of a horse (which was called *October*) to the god Mars. The other festivals were chiefly bacchanalian. Among the Saxons, it was styled *Wyn moneth* or the wine month.

**OCTO'PODA** (Gr. eight-footed), a section of dibranchiate cephalopods (see CEPHALOPODA), having the body in general very short, the head very distinct; eight arms, not very unequal, furnished with simple suckers; with or without a shelly covering. To this section belong Argonauts, Poulps, &c. See these heads.

**OCTOSTYLE**, the name given in classic architecture to a portico composed of eight columns in front.

**OCTROI** (Lat. *auctoritas*, authority), a term which originally meant any ordinance authorised by the sovereign, and thence came to be restrictively applied to a toll or tax in kind levied from a very early period in France, and other countries of Northern Europe, on articles of food which passed the barrier or entrance of a town. The right to levy this toll was often delegated to subjects, and in order to increase its amount, a device was resorted to of raising the weight of the pound in which the octroi was taken. The large pound, an ounce heavier than that in ordinary use, was called the *livre d'octroi*, whence the expression *pound Troy*. The octroi came eventually to be levied in money, and was abolished in France at the Revolution. In 1798, it was re-established, under the pretext that it was required for purposes of charity, and called the *octroi de bienfaisance*, and it has been reorganised in 1816, 1842, and 1852. Of the octroi duty which is at present levied at the gates of the French towns, one-tenth goes to the imperial treasury, and the rest to local expenses. The octroi officers are entitled to search all carriages and individuals entering the gates of a town. From the octrois of Paris alone government derives a revenue of about 56 million francs. In 1860, the Belgian government acquired great popularity by abolishing the octroi.

The epithet *octroyé* is applied by continental politicians to a constitution granted by a prince, in contradistinction to one which is the result of a pacton between the sovereign and the representatives of the people. Any public company possessing an authorised monopoly like that held by the East India Company, is said to be *octroyé*.

**OD** (from the same root as Odin, and supposed to mean all-pervading), the name given by Baron Reichenbach (q. v.) to a peculiar physical force which he thought he had discovered. This force, according to him, pervades all nature, and manifests itself as a flickering flame or luminous appearance at the poles of magnets, at the poles of crystals, and wherever chemical action is going on. This would account for the luminous figures said to be sometimes seen over recent graves. The od force has positive and negative poles, like magnetism. The human body is od-positive on the left side, and od-negative on the right. Certain persons, called 'sensitive,' can see the odic radiation like a luminous vapour in the dark, and can feel it by the touch like a breath. As the meeting of like odic poles causes a disagreeable sensation, while the pairing of unlike poles causes a pleasant sensation, we have thus a sufficient cause for those likings and antipathies hitherto held unaccountable. Some sensitive persons cannot sleep on their left side (in the northern hemisphere), because the north pole of the earth, which is od-negative, affects unpleasantly the od-negative left side. All motion generates od;

why, then, may not a stream running underground affect a sensitive water-finder, so that the divining-rod in his or her hand shall move without, it may be, any conscious effort of will? All the phenomena of mesmerism are ascribed to the workings of this od-force. Reichenbach does not pretend to have had the evidence of his own senses for any of those manifestations of his assumed od-force; the whole theory rests on the revelations made to him by 'sensitives.' It may be added, that few if any really scientific men have any belief in the existence of such a force.—Those curious in such matters are referred for the details of the subject to Reichenbach's large work, translated into English by Dr Ashburner, under the title of *The Dynamics of Magnetism*, or to a briefer account in his *Ödiseh-Magnetische Briefe* (Stutt. 1852).

**O'DAL** or **UDAL RIGHT** (Celtic *od*, property), a tenure of land which was absolute, and not dependent on a superior, and prevailed throughout Northern Europe before the rise of feudalism. It was founded on the tie of blood which connected freeman with freeman, and not on the tie of service. It was the policy of the sovereign authority everywhere to make it advantageous for the freemen to exchange the odal tie for the tie of service—a change which paved the way for the feudal system. The odallers of Orkney were allowed to retain or resume their ancient privileges, on paying a large contribution to the erection of St Magnus's Cathedral at Kirkwall; and the Odal tenure prevails to this day to a large extent in the Orkney and Shetland Islands, the right to land being completed without writing by undisturbed possession proved by witnesses before an inquest.

**ODD-FELLOWS**, the name assumed by one of the most extensive self-governed provident associations in the world. The institution was originated in Manchester in 1812, although isolated 'lodges' had existed in various parts of the country for some time previously. These latter were generally secret fraternities, humble imitations of Freemasonry—adopting a similar system of initiatory rites, phraseology, and organisation—instituted for social and convivial purposes, and only occasionally extending charitable assistance to members. On its institution in Manchester, the main purpose of Odd-fellowship was declared by its laws to be, 'to render assistance to every brother who may apply through sickness, distress, or otherwise, if he be well attached to the Queen and government, and faithful to the order;' and this continues to be the basis of all its operations. It still, however, retains some of the characteristics of Freemasonry, in possessing pass-words and peculiar 'grips,' whereby members can recognise one another. The headquarters of the society is at Manchester, where reside the Grand Master and Board of Directors of the 'Manchester Unity of the Independent Order of Odd-fellows.' In January 1852, the total number of members was 224,441; in January 1864, the number was 358,556; and during 1863, 15,603 new members joined. The lodges number 3555, spread over 440 districts; the annual income being about £350,000, with an expenditure of nearly £300,000. Should any lodge fail to meet its legitimate obligations, the district becomes liable; failing the district, the responsibility falls upon the entire Unity. The order is widely spread over the whole of England and Scotland. It exists independently in America, Australia, New Zealand, and the West Indies; but there are 'lodges' in Philadelphia, New York, in all the British colonies, and one in Constantinople (originated in 1862), which are affiliated to and in connection with the Manchester

Board. These wide spread ramifications of this society enable emigrant members to be at once received into fellowship in those countries. In the American states, Odd-fellowship is said to exercise considerable political influence. A quarterly periodical, called the *Odd-fellows' Magazine*, devoted to its interests, is published in Manchester. In an early number of this publication, an Odd-fellow is described as 'like a fox for cunning, a dove for tameness, a lamb for innocence, a lion for boldness, a bee for industry, and a sheep for usefulness.'

**ODE** (Gr. a song) originally meant any lyrical piece adapted to be sung. In the modern use of the word, odes are distinguished from songs by not being necessarily in a form to be sung, and by embodying loftier conceptions and more intense and passionate emotions. The language of the ode is therefore abrupt, concise, and energetic; and the highest art of the poet is called into requisition in adapting the metres and cadences to the varying thoughts and emotions. Hence the changes of metre and versification that occur in many odes. The rapt state of inspiration that gives birth to the ode, leads the poet to conceive all nature as animated and conscious, and, instead of speaking about persons and objects, to address them as present.

Among the highest examples of the ode are the *Song of Moses* and several of the psalms. Dryden's *Alexander's Feast* is reckoned one of the first odes in the English language. We may mention, as additional specimens, Gray's *Bard*, Collins's *Ode to the Passions*, Burns's *Scots wha hae*, Coleridge's *Odes to Memory and Despondency*, Shelley's *Ode to the Skylark*, and Wordsworth's *Ode on the Recollections of Immortality in Childhood*.

**O'DENSEE** (anciently known as Odin's-Ey, or Odin's Oe (i. e., Odin's Island), the chief town of the Danish island of Funen, and the oldest city of the kingdom, is situated in the amt or district of the same name, in 55° 25' N. lat., and 10° 20' E. long. Pop. (1860) 14,255. O., which is the seat of the governor of the island and the see of a bishop, has a gymnasium, several literary societies, and is an active, thriving provincial town. A bishopric was founded here in 988, prior to which time O. bore the reputation of being the first city established by Odin and his followers. The cathedral, founded in 1086 by St Knud, whose remains, like those of several of the early Danish kings, were deposited here, is a fine specimen of the early simple Gothic style. The lay convent or college for ladies contains an extensive library, furnished with copies of all printed Danish works. At O., a diet was held in 1527, in which the Reformed or Lutheran doctrines were declared to be the established creed of Denmark, and equality of rights was granted to Protestants; while another diet held there in 1539 promulgated the laws regulating the affairs of the Reformed Church.

**O'DENWALD**. See HESSE-DARMSTADT.

**O'DER** (Lat. *Viadrus*, Slavon. *Vjodr*), one of the principal rivers of Germany, rises in the Leselberg on the table-land of Moravia, more than 1000 feet above the level of the sea, and enters Prussian Silesia at Odersberg, after a course of some 60 miles. After traversing Brandenburg in a north-west direction, it crosses Pomerania, and empties itself into the Stettiner Haff, from whence it passes into the Baltic by the triple arms of the Dievenow, Peene, and Swine, which enclose the islands of Wollin and Usedom. The O. has a course of more than 500 miles, and a river-basin of 50,000 square miles. The rapid flow of this river, induced by its very considerable fall, is accelerated by the affluence

of several important mountain-streams, and thus contributes, together with the silting at the embouchures of these streams, to render the navigation difficult; great expense and labour being, moreover, necessary to keep the embankments in order, and prevent the overflowing of the river. The O. has numerous secondary streams, the most important of which are the Oppa, Neisse, Ohlau, Klodnitz, Bartsch Warte, and the Ihna; and is connected with the Havel and thence with the Elbe by the Finow Canal, and with the Spree by the Friedrich-Wilhelms Canal. The chief trading port of the O. is Swinemunde, which constitutes an important centre for the transfer of colonial and other foreign goods to Northern Germany and Poland. At Raibor, 17 miles below Oderberg, the river becomes navigable, and is upwards of 100 feet in breadth; at Oppeln, in Prussian Silesia, it has a breadth of 238 feet. As a boundary river, it is of considerable importance in a military point of view, and is well defended by the fortresses of Kosel, Grossglogau, Küstrin, and Stettin.

ODESSA, an important seaport and commercial city of South Russia, in the government of Kherson, stands on an acclivity sloping to the shore, on the north-west coast of the Black Sea, 32 miles north-east of the mouth of the Dniester. Lat. 46° 29' N., long. 30° 44' E. The harbour is formed by two large moles defended by strong works, and is capable of containing 200 vessels. The bay is deep enough even close in shore to admit the approach of the largest men-of-war, and is frozen only in the severest winters, and then only for a short time. The promenade along the face of the cliff, descending to the shore by a broad stone stair of 204 steps, is the favourite walk of the inhabitants. Here also stands the monument of the Duc de Richelieu, to whom in great part the town is indebted for its prosperity. In the pedestal of the monument is preserved the ball by which he was shot during the bombardment of the town by the allied fleet in 1854. There is a high school of law, literature, and science, called Richelieu's Lyceum, in honour of its founder. The city contains many fine edifices, as the Cathedral of St Nicholas, the Admiralty, the Custom-house, &c. Owing to the intensity of the heat in summer (rising occasionally to 120°), and the dryness of the soil, vegetation in the vicinity of O. is very poor. In the neighbourhood are quarries of soft stone, which is used for building purposes in O. and in the surrounding towns. One of the great deficiencies of O. is its want of good water. At present (1864), a project is on foot of drawing water from the Dniester. O. is the seat of the 'Company for Steam-navigation and Commerce;' but its progress is much hindered by want of means of communication with the interior. During spring and autumn, the roads are almost impassable for mud, so that it is with the greatest difficulty that goods are conveyed from the warehouses to the place of lading. The Odessa-Parchiansky Railway, now (1864) in process of construction, will connect O. with the Dniester; and the Odessa-Kief Railway, already authorised by government, will have great influence on the commercial importance of this city. The principal exports of O. are wheat and other sorts of grain, linseed, tallow, leather, and wool, all of which articles abound in South Russia. In 1853, 18,002,400 bushels of wheat, valued at about £3,120,000, were exported from Odessa. The whole exports amount at present to £6,000,000. The whole imports amount to £2,100,000. Pop. 117,999, chiefly Jews, Greeks, and Italians.

In ancient times, O. (Gr. *Odessus*) was inhabited by a Greek colony, and later by Tartar tribes. In

the beginning of the 15th c., the Turks constructed a fortress here, which was taken by the Russians in 1789. In 1793, a Russian fortress was built here, and became the nucleus of a town and port, which two years after received the name of Odessa. The Duc de Richelieu, a French emigrant in the Russian service, was appointed governor here in 1803, and during the eleven years of his wise administration, the town prospered rapidly. Since 1823, the city has formed part of the general governorship of South Russia; is the seat of its administration, and is the residence of the governor-general and of an archbishop. The advantageous commercial position of the city, and the privileges granted to it by government, but chiefly the privileges of a free port from the year 1819, have developed this city from a mere Turkish fortress into the chief commercial town of the Black Sea, and the third in the Russian empire, after St Petersburg and Riga. On the outbreak of the Crimean War, April 1854, the British steamer *Furious* went to O. for the purpose of bringing away the British consul. While under a flag of truce, she was fired upon by the batteries of the city. On the failure of a written message from the admirals in command of the fleet to obtain explanations, twelve war-steamers invested O., 22d April, and in a few hours destroyed the fortifications, blew up the powder-magazines, and took a number of Russian vessels.

ODEYPOOR, a town of British India, capital of the small state of the same name, 320 miles west of Calcutta. The town is unimportant, and the state, which is within the jurisdiction of the political agent for the south-west frontier of Bengal, has an area of 2506 square miles, and a pop. of 133,000.

ODIN, the chief god of Northern Mythology. According to the sagas, O. and his brothers, Vile and Ve, the sons of *Boer*, or the first-born, slew Ymer or Chaos, and from his body created the world, converting his flesh into dry land; his blood, which at first occasioned a flood, into the sea; his bones into mountains; his skull into the vault of heaven; and his brows into the spot known as *Midgaard*, the middle part of the earth, intended for the habitation of the sons of men. O., as the highest of the gods, the *Alfader*, rules heaven and earth, and is omniscient. As ruler of heaven, his seat is Valaskjalf, from whence his two black ravens, Huginn (Thought) and Muninn (Memory), fly daily forth to gather tidings of all that is being done throughout the world. As god of war, he holds his court in Valhalla, whither come all brave warriors after death to revel in the tumultuous joys in which they took most pleasure while on earth. His greatest treasures are his eight-footed steed Sleipner, his spear Gungner, and his ring Draupner. As the concentration and source of all greatness, excellence, and activity, O. bears numerous different names. By drinking from Mimir's fountain, he became the wisest of gods and men, but he purchased the distinction at the cost of one eye. He is the greatest of sorcerers, and imparts a knowledge of his wondrous arts to his favourites. Frigga is his queen, and the mother of Baldur, the Scandinavian Apollo; but he has other wives and favourites, and a numerous progeny of sons and daughters. Although the worship of O. extended over all the Scandinavian lands, it found its most zealous followers in Denmark, where he still rides abroad as the wild huntsman, rushing over land and water in the storm-beaten skies of winter.

The historical interpretation of this myth, as given by Snorre Sturleson, the compiler of the *Heimskringla*, or Chronicles of the Kings of Norway prior to the introduction of Christianity, and

followed in recent times by the historian Suhm, is that O. was a chief of the *Esir*, a Scythian tribe, who, fleeing before the ruthless aggressions of the Romans, passed through Germany to Scandinavia, where, by their noble appearance, superior prowess, and higher intelligence, they easily vanquished the inferior races of those lands, and persuaded them that they were of godlike origin. According to one tradition, O. conquered the country of the Saxons on his way; and leaving one of his sons to rule there, and introduce a new religion, in which he, as the chief god *Wuotan*, received divine honours, advanced on his victorious course, and making himself master of Denmark, placed another son, *Skjold*, to reign over the land, from whom descended the royal dynasty of the *Skjoldingar*. He next entered Sweden, where the king, *Gylfi*, accepted his new religion, and with the whole nation worshipped him as a divinity, and received his son *Yugni* as their supreme lord and high-priest, from whom descended the royal race of the *Yuglingars*, who long reigned in Sweden. In like manner he founded, through his son *Sceming*, a new dynasty in Norway; and besides these, many sovereign families of Northern Germany, including our own Saxon princes, traced their descent to Odin. As it has been found impossible to refer to one individual all the mythical and historical elements which group themselves around the name of O., *Wodin*, or *Wuotan*, it has been suggested by Suhm and other historians, that there may have been two or three ancient northern heroes of the name; but notwithstanding the conjectures which have been advanced since the very dawn of the historical period in the north in regard to the origin and native country of the assumed O., or even the time at which he lived, all that relates to him is shrouded in complete obscurity. It is much more probable, however, that the myth of O. originated in nature-worship. See SCANDINAVIAN MYTHOLOGY.

**ODOA'CER** (also *ODOVACER*, *ODOBAGAR*, *ODOVACHAR*, *OTACHAR*, &c., and, according to St Martin, the same as *OTTOCHAR*, a name frequent in Germany during the middle ages), the ruler of Italy from the year 476 to 493, was the son of *Edecon*, a secretary of *Attila*, and one of his ambassadors to the court of Constantinople. This *Edecon* was also captain of the *Scyri*, who formed the bodyguard of the king of the Huns. After the death of *Attila*, he remained faithful to the family of his master, but perished about 463 in an unequal struggle with the *Ostrogoths*. He left two sons, *Onulf* and *Odoacer*, the former of whom went to seek his fortune in the East; while O., after leading for some time the life of a bandit chief among the *Noric Alps*, determined to proceed to Italy, whither barbarian adventurers were flocking from all Europe. According to a monkish legend, a pious hermit, *St Severinus*, whom he went to visit before his departure, prophesied his future greatness. O. entered the military service of the Western Roman Empire, and rapidly rose to eminence. He took part in the revolution by which *Orestes* (475) drove the Emperor *Julius Nepos* from the throne, and conferred on his son *Romulus* the title of *Augustus*, which the people scoffingly changed into *Augustulus*. He soon perceived the weakness of the new ruler, and resolved to profit by it. He had little difficulty in persuading the barbarian soldiery, who had effected the revolution, that Italy belonged to them, and in their name demanded of *Orestes* the third part of the land, as the reward of their help. This *Orestes* refused; and O., at the head of his *Herulians*, *Rugians*, *Turcilingians*, and *Scyri*, marched against *Pavia*, which *Orestes* had garrisoned, stormed the city, and put his opponent to death (476). *Romulus* abdicated, and withdrew into obscurity. What

became of him, is not known. Thus perished the Roman empire. O. shewed himself to be a wise, moderate, and politic ruler, quite unlike our general notion of a barbarian. In order not to offend the Byzantine emperor *Zeno*, he took the title of king only, and caused the senate to despatch to Constantinople a flattering letter, in which it declared one emperor to be enough for both East and West; renounced its right of appointing the emperors, expressed its confidence in the civil and military talents of O., and begged *Zeno* to confer upon him the administration of Italy. After some hesitation, the Byzantine emperor yielded to the entreaties of the senate, and O. received the title of *Patricius*. He fixed his residence at *Ravenna*. According to his promise, he divided among his companions the third part of the land of Italy—a measure far less unjust than at first sight may seem, for the peninsula was then almost depopulated, and many domains were lying waste and ownerless. This barbarian ruler did everything in his power to lift Italy out of the deplorable condition into which she had sunk, and to breathe fresh life into her municipal institutions—those venerable relics of nobler days! He even re-established the consulate, which was held by eleven of the most illustrious senators in succession, maintained peace throughout the peninsula, overawed the Gauls and Germans, and reconquered *Dalmatia* and *Noricum*. In religion, though an Arian himself, he acted with a kingly impartiality that more orthodox monarchs have rarely exhibited. *Gibbon* remarks, with his usual pointed sarcasm, that the silence of the Catholics attests the toleration which they enjoyed. The valour, wisdom, and success of O. appear to have excited the jealousy and alarm of *Zeno*, who encouraged *Theodoric*, king of the *Ostrogoths*, a still greater warrior and sovereign than O. himself, to undertake an expedition against Italy. The first battle was fought on the banks of the *Isontius* (mod. *Isonzo*), 28th August 489. O. was beaten, and retreated. During his retreat, he hazarded another battle at *Verona*, and was again beaten. He now hastened to *Rome*, to rouse the inhabitants, but the gates of the city were closed against him. Returning northwards to his capital, *Ravenna*, he reassembled the wrecks of his army, and in 490 once more marched against the *Ostrogoths*, whose advance-guard he defeated, and pursued to the walls of *Pavia*. Another great battle now took place on the banks of the *Adda*, when O. was vanquished for the third time. He now shut himself up in *Ravenna*, where *Theodoric* besieged him for three years. O. then capitulated, on condition that the kingdom of Italy should be shared between him and *Theodoric*. This agreement was solemnly sworn to by both parties, 27th February 493; but on the 5th of March, O. was assassinated at a feast, either by *Theodoric* himself, or by his command.

**ODOMETER** (Gr. *odos*, a road, *mētrōn*, a measure), also called *Perambulator*, or *surveying-wheel*, is an instrument attached to a carriage or other vehicle, for the purpose of registering the distance it has travelled. Such machines have been in use from an early period, and one is described by *Vitruvius* in that part of his work *De Architectura* which is devoted to machines. The instrument, as commonly employed, consists of a train of wheel-work, which communicates motion from the axle of the carriage wheel to an index which moves round the circumference of a dial fixed in one side of the carriage over the axle. The wheel-work is arranged so as to produce a great diminution of the velocity impressed by the axle of the vehicle, and the dial is so graduated that the index can shew the number of miles, furlongs, yards, &c., traversed. The instrument

is also constructed to work independently, being in this case provided with wheels and an axle of its own; when this is done, the wheel is made of such a size that its circumference is an aliquot part of a mile, an arrangement which greatly simplifies the calculation of the distance traversed. The complete odometer can then be drawn along by a man on foot, or attached behind a carriage.

O'DONNELL, LEOPOLD, Duke of Tetuan, Marshal of Spain, born in 1809, is descended from an ancient Irish family. He entered the Spanish army when young, and bravely espoused the cause of the infant Queen Isabella against her uncle, Don Carlos. When the Carlists were overthrown, he was created Count of Lucena, made General of Brigade, and Chief of the Staff to Espartero. He took the side of the Queen-mother in 1840; emigrated with her to France, at the time when her cause seemed desperate; and took up his residence at Orleans, where he planned many of the political risings and disturbances which took place under the rule of Espartero. He headed in person a revolt of the Navarrese against the minister, but on its failure returned to France. In 1843, his intrigues against Espartero (q. v.) were successful; and he was rewarded by the governor-generalship of Cuba, where he amassed a large fortune by favouring the iniquitous trade in slaves. When he returned to Spain (1845) he intrigued against Bravo Murillo and Narvaez; and when the latter was succeeded by Sartorius, O'D., proscribed by the government, headed a military insurrection. Defeated, and driven into Andalusia in 1854, he issued a liberal manifesto. The profligacy of the court, and the despotism of the government, favoured the appeal; and when Espartero gave in his adhesion, the Spaniards rose *en masse*, and replaced the ex-regent at the helm. Espartero reversed the confiscation against O'D., and made him a marshal and minister of war. O'D. again plotted against his old benefactor, and in July 1856, supplanted him by a *coup d'état*. Blood was shed in the streets of Madrid, but O'D. remained president of the council. He was in three months' time succeeded by Narvaez; but in 1859 he returned to power again; and in 1859, while still holding the position of prime minister, he assumed the command of the army sent to Morocco. The campaign continued for many months, without leading either to reverses or glory. The Moors displayed an entire absence of military qualities; and O'D., though successful in obscure skirmishes, occupied three months in the march from Ceuta to Tetuan. A battle took place, February 4, 1860; O'D. gained a complete victory, took the Moorish camp, and the city of Tetuan surrendered to the Spaniards. The Emperor of Morocco submitted to a loss of territory, and O'D. was raised to the first rank of the Spanish nobles as Duke of Tetuan. He still (1864) remains prime minister; and although his attempts to gain for Spain the rank of a first-class Power have as yet been unsuccessful, some progress is undoubtedly being made by the O'D. ministry towards a regeneration of the finances, army, and administration of Spain.

ŒCOLAMPADIUS, JOANNES—a name Latinised, according to the fashion of the age, from the German JOHANN HAUSSCHER—one of the most eminent of the coadjutors of Zwingli in the Swiss Reformation, born in 1482 at Weinsberg, in Swabia. His father destined him for the profession of the law, and he studied for it in Heidelberg and Bologna; but yielding to his own strong inclination, he relinquished this study for that of theology, which he prosecuted at Heidelberg. He then became tutor to the sons of the Elector Palatine, and subse-

quently preacher in Weinsberg. This office he resigned in order to study the Greek language under Reuchlin at Stuttgart. He also learned Hebrew from a Spanish physician, Matthew Adrian. Being appointed preacher at Basel, he formed the acquaintance of Erasmus, who highly appreciated his classical attainments, and employed his assistance in his edition of the New Testament. In 1516, he left Basel for Augsburg, where also he filled the office of preacher, and where he entered into a convent. But Luther's publications exercised so great an influence on him, that he left the convent, and became chaplain to Franz von Sickingen, after whose death he returned to Basel in 1522, and in the capacity of preacher and professor of theology, commenced his career as a reformer. He held disputations with supporters of the Church of Rome in Baden in 1526, and in Bern in 1528. In the controversy concerning the Lord's Supper, he gradually adopted more and more the views of Zwingli, and at last maintained them in 1525, in a treatise, to which the Swabian ministers replied in the *Syngramma Suevicum*. In 1529 he disputed with Luther in the conference at Marburg. He died at Basel, 23d November 1531, not long after the death of his friend Zwingli. He was remarkable for his gentleness of character. His treatise, *De Ritu Paschali*, and his *Epistola Canoniorum Indocorum ad Eccliam*, are the most noted of his works.—See Herzog, *Das Leben des Joh. Œcolampadius und die Reformation der Kirche zu Basel* (2 vols. Basel, 1843).

ŒCUMENICAL (Gr. *oikoumenike*, 'of, or belonging to, the *oikoumene*, 'the world'), the name given to councils of the entire church, and synonymous with the more ordinary name 'general.' See COUNCIL. The conditions necessary to constitute an œcumenical council are a subject of much controversy. As the subject is of less importance in Protestant divinity, it will be enough to explain here that a council is said by Roman Catholic divines to be œcumenical in three different ways: viz., in convocation, in celebration, and in acceptance. For the first, the summons of the pope, direct or indirect, is held to be necessary; this summons must be addressed to all the bishops of the entire church. To the second, it is necessary that bishops from all parts of the church should be present, and in sufficient numbers to constitute a really representative assembly: they must be presided over by the pope, or a delegate or delegates of the pope; and they must enjoy liberty of discussion and of speech. For the third, the decrees of the council must be accepted by the pope, and by the body of the bishops throughout the church, at least tacitly. The last of these conditions is absolutely required to entitle the decrees of a council to the character of œcumenical; and even the decrees of provincial or national councils so accepted, may acquire all the weight of infallible decisions, in the eyes of Roman Catholics.

ŒDEMA (Gr. *a swelling*) is the term applied in Medicine to the swelling occasioned by the effusion or infiltration of serum into cellular or areolar structures. The subcutaneous cellular tissue is the most common, but is not the only seat of this affection. It is occasionally observed in the submucous and subserous cellular tissue, and in the cellular tissue of the parenchymatous viscera; and in some of these cases, it gives rise to symptoms which admit of easy recognition during life. Thus œdema of the glottis (see LARYNX) and œdema of the lungs constitute well-marked and serious forms of disease; while œdema of the brain, though not easily recognised during life, is not uncommonly met with in the *post-mortem* examination of insane patients.



Œdema may be either passive or active, the former being by far the most common. *Passive Œdema* arises from impeded venous circulation (as from obstruction or obliteration of one or more veins; from varicose veins; from standing continuously for long periods, till the force of the circulation is partly overcome by the physical action of gravitation; from deficiency in the action of the adjacent muscles, which in health materially aids the venous circulation, &c.); from too weak action of the heart (as in dilatation or certain forms of valvular disease of that organ); or from a too watery or otherwise diseased state of the blood (as in chlorosis, scurvy, Bright's disease, &c.). By means of the knowledge derived from pathological anatomy, we can often infer the cause from the seat of the swelling; for example, œdema of the face, usually commencing with the eyelids, is commonly caused by obstruction to the circulation through the left side of the heart, or by the diseased state of the blood in Bright's disease; and œdema of the lower extremities most commonly arises from obstruction in the right side of the heart, unless it can be traced to the pressure of the gravid uterus, or of accumulated feces in the colon, or to some other local cause.

*Active Œdema* is associated with an inflammatory action of the cellular tissue, and is most marked in certain forms of erysipelas. It is firmer to the touch, and pressure with the finger produces less pitting than in the passive form.

From the preceding remarks, it will be seen that œdema is not a disease, but a symptom, and often a symptom indicating great danger to life. The means of removing it must be directed to the morbid condition or cause of which it is the symptom.

ŒDIPUS (Gr. *Oidipous*), the hero of a celebrated legend, which, though of the most revolting nature in itself, has supplied both Euripides and Sophocles with the subject-matter of some of their most celebrated tragedies. The story, as generally related, is as follows: O. was the son of Laius, king of Thebes, by Jocaste; but his father having consulted the oracle to ascertain whether he should have any issue, was informed that his wife would bring forth a son, by whom he (Laius) should ultimately be slain. Determined to avert so terrible an omen, Laius ordered the son which Jocaste bore him to have his feet pierced through, and to be exposed to perish on Mount Cithæron. In this helpless condition, Œ. was discovered by a herdsman, and conveyed to the court of Polybus, king of Corinth, who, in allusion to the swollen feet of the child, named him *Œdipus* (from *oileo*, to swell, and *pous*, the foot); and along with his wife, Merope, brought him up as his own son. Having come to man's estate, Œ. was one day taunted with the obscurity of his origin, and in consequence proceeded to Delphi, to consult the oracle. The response which he received was, that he would slay his father, and commit incest with his mother. To escape this fate, he avoided returning to Corinth, and proceeded to Thebes, on approaching which he encountered the chariot of his father; and the charioteer ordering him out of the way, a quarrel ensued, in which Œ. ignorantly slew Laius, and thus unconsciously fulfilled the first part of the oracle. The famous Sphinx (q. v.) now appeared near Thebes, and seating herself on a rock, propounded a riddle to every one who passed by, putting to death all who failed to solve it. The terror of the Thebans was extreme, and in despair they offered the kingdom, together with the hand of the queen, to the person who should be successful in delivering it from the monster. Œ. came

forward; the Sphinx asked him, 'What being has four feet, two feet, and three feet; only one voice; but whose feet vary, and when it has most, is weakest?' Œ. replied that it was 'Man;' whereupon the Sphinx threw itself headlong from the rock. Œ. now became king, and husband of his mother, Jocaste. From their incestuous union sprung Eteocles, Polynices, Antigone, and Ismene. A mysterious plague now devastated the country, and when the oracle declared that before it could be stayed, the murderer of Laius should be banished from the country, Œ. was told by the prophet Tiresias that he himself had both murdered his father and committed incest with his mother. In his horror he put out his own eyes, that he might no more look upon his fellow-creatures, while Jocaste hanged herself. Driven from his throne by his sons and his brother-in-law, Creon, Œ. wandered towards Attica, accompanied by Antigone, and took refuge in the grove of the Eumenides, who charitably removed him from earth; but the latter part of his life is differently told.

ŒHLENSCHLÄGER, ADAM GOTTLÖB, the greatest poet of Northern Europe, was born in 1779 at Copenhagen. His early years were spent at the palace of Fredericksborg, in the neighbourhood of the Danish capital, where his father was employed, first as organist, and afterwards as steward or bailiff. During the absence of the royal family in the winter, Œ. and his sister amused themselves in roaming over the palace, and examining the paintings and works of art which it contained, and in improvising private theatricals, for which he supplied original pieces. After an irregular and desultory course of education, Œ.'s love of the drama led him to offer his services to the manager of the Copenhagen theatre; but discovering soon that he had no chance of rising above the rank of a mere supernumerary, he entered the university of Copenhagen as a student of law. For a time, he seems to have pursued his studies with tolerable assiduity, under the direction of his friend, A. S. Oersted, who, together with his distinguished brother, H. C. Oersted (q. v.) had cemented a lifelong friendship with him. Œ.'s studies were interrupted in 1801, when, on the bombardment of Copenhagen by Nelson and Parker, he and his friends served in the student-corps of volunteers. After this event, which roused the dormant patriotism of the nation, Œ. found the study of law too irksome, and devoted all his energies to the cultivation of the history and mythology of his own country. In 1803, appeared his first collection of poems, including one longer dramatic piece, *St Hans Aften-Spil*, which attracted favourable notice for the lively fancy with which national habits and local characteristics were portrayed. The *Vaulunders Saga* in the *Poetiske Skrifter*, published in 1805, and his *Aladdin's forunderlige Lampe*, completed his success, and raised him to the rank of the first of living Danish poets; the former of these works having shewn a marvellous capacity for reflecting the dark and stern colouring of the old northern Sagas, while the latter gave evidence of a rich and genial poetic fancy. These early efforts were rewarded by the acquisition of a travelling pension, which enabled him to spend some years in visiting various parts of the continent, and becoming acquainted with the great literary celebrities of the day, such as the Weimar circle of whom Goethe was the head. Œ. was not idle with his pen during this period of comparative recreation, for in 1807 he wrote his *Hakon Jarl*, the first of his long series of northern tragedies, at Halle; and in 1809, he composed his *Correggio* at Rome. In 1810, Œ. returned to Denmark, where he was hailed with acclamation

as the greatest tragic poet Denmark had ever known; and having soon afterwards obtained the chair of æsthetics at the university, and received various substantial proofs of royal favour, he married, and settled in the capital, where his peace was, however, rudely disturbed by a literary feud with Baggesen, the Danish poet and critic, whose poetical supremacy had been superseded by that of Ehlerschläger. In 1819 appeared one of CE's most masterly productions, *Nordens Guder*, and this and the numerous dramatic compositions written about the same period, shew that the severe criticism to which his writings had been exposed during the celebrated Baggesen quarrel, had corrected some of the faults, and lessened the self-conceit which had characterised his earlier works. His reputation spread with his increasing years both abroad and at home; and after having repeatedly visited the more southern parts of Europe, he went in 1829 to Sweden, where his arrival was welcomed by a public ovation; and after having received repeated marks of friendship from various sovereigns, he was honoured in his own country by the celebration, in 1849, of a grand public festival held in the palace at Copenhagen. But this ovation was unfortunately followed in less than two months by his death, which took place in January 1850. His funeral was kept as a national solemnity, and he was followed to the grave by a civic procession, which included members of every class of society, from princes to artisans. The fame of CE. will rest principally on his tragedies, of which he wrote 24, 19 of the number being on northern subjects. These were all composed originally in Danish, and re-written by himself in German. Besides those already referred to, the best are *Knud den Store*, *Palnatoke*, *Axel og Walborg*, *Væringerne i Miklagord*. His poems are for the most part indifferent, and his numerous prose writings deserve little notice. His Danish and German works amount in all to 62 volumes, to which must be added 4 volumes of his *Erindringer*, or *Autobiographical Recollections*, published after his death.

**CEIL DE BŒUF**, a French term literally signifying ox's eye, applied in architecture to those small round or oval openings in the frieze or roof of large buildings, which serve to give light to spaces otherwise dark. The most famous is that in the anteroom (where the courtiers waited) of the royal chamber at Versailles, which gave name to the apartment. Hence the expression, *Les Fastes de l'Œil-de-Bœuf*—i.e., the history of the courtiers of the Grand Monarque, and by extension, of courtiers in general.

**CE'LAND**, a long and narrow island in the Baltic, lying off the eastern coast of Sweden, opposite to, and forming part of, the län of Kalmar, and at a distance of from 4 to 17 miles from the shore. It is 85 miles in length, and from 2 to 8 miles in breadth. The area is 588 square miles, and the pop. 35,000. The island, which is scarcely more than a lime cliff, is scantily covered with soil, but in some parts it is well wooded, and has good pasture-ground, which is turned to account by the islanders, who rear cattle, horses, and sheep. In favourable seasons, barley, oats, and flax yield good crops. The fishing is excellent all round the coasts. There are large alum-works on the island, and an extensive line of wind-mills along the range of the Alwar Hills, near which stands Borgholm (pop. 673), the only town on the island, the first foundations of which were laid in 1817. To the south of the island lies the steep but wooded island-cliff, the Jungfruen, or Blaakulla, which bears the mythical reputation of having been the scene of

various deeds of witchcraft, and the favourite resort of wizards and witches.

**OELS**, a small town of Prussian Silesia, stands on a plain on the Oelsa, or Oelse, 16 miles east-north-east of Breslau. Its castle, built in 1558, is surrounded by ramparts and ditches. It contains a gymnasium, several churches, and other public edifices. Pop. 6638, who carry on manufactures of linens and cloth goods.

**ŒNANTHYLIC ACID** ( $C_{14}H_{26}O_2$ , HO) is one of the volatile fatty acids of the general formula  $C_nH_{2n}O_2$ . It is a colourless oily fluid, with an aromatic odour, lighter than water, and insoluble in that fluid, but dissolving readily in alcohol and ether. According to Miller (*Organic Chemistry*, 2d ed. p. 355), it may be exposed to a cold of  $0^\circ$  without becoming solid; while it boils and may be distilled (with partial decomposition) at  $298^\circ$ . It is (like many of the allied fatty acids) one of the products of the oxidation of Oleic Acid (q. v.) by nitric acid, and is likewise yielded by the action of nitric acid on castor oil, wax, and various fats. Its most characteristic salt is the œnanthylate of copper, which crystallises in beautiful green needles.

**ŒNOTHERA**, a genus of plants of the natural order *Œnagræceæ* (q. v.), having four petals and eight stamens, the calyx-limb 4-cleft, the segments reflexed; the capsule 4-valved, with many naked seeds. The **EVENING PRIMROSE** (*Œ. biennis*), a native of Virginia, has been known in Europe since 1614, and is now naturalised in many parts of Europe



Evening Primrose (*Œnothera biennis*):

a, flower divested of calyx and corolla, to shew the parts of fructification; b, tuberous root.

and in some parts of Britain, on the banks of rivers, in thickets, on sandy grounds, &c. It is a biennial plant, and produces in the first year elliptic or obovate obtuse leaves, and in the second year a stem of 1½—4 feet high, which bears at its summit numerous yellow flowers in a leafy spike. The flowers are fragrant in the evening. The root somewhat resembles a carrot in shape, but is short; it is usually red, fleshy, and tender; it is eaten in salads or in soups, and as a boiled vegetable. The plant is often cultivated for the sake of its large yellow flowers. Several other species of *Œnothera*, natives of North America, are occasionally cultivated in our gardens, and have eatable and pleasant roots.

**OEREBRO**, an inland town of Sweden, capital of a län of the same name, is situated at the entrance of the Swart-Elf into the Heilmars Lake,

120 miles west of Stockholm. Pop. in 1861, 7742. The town still retains many memorials of its earlier prosperity, when it was frequently the residence of the Swedish rulers, who found its central position in the more fertile southern portion of the kingdom favourable both in regard to safety and pleasantness of site. The old castle was built by Berger Jarl in the 13th c., and was in after-times frequently chosen as the seat of the national diets. O. has manufactories of wax-cloth, carpets, woollen goods, stockings, guns, and mirrors; and these industrial products, together with the minerals obtained from the neighbouring silver, copper, and iron mines, are conveyed to Gothenborg and Stockholm by means of the extensive system of canals which connects the lakes of the interior with the maritime ports.

OERSTED, HANS CHRISTIAN, one of the most distinguished scientific discoverers and physicists of modern times, was born in 1777 at Rudkjøbing, on the Danish island of Langeland, where his father practised as an apothecary. In 1794, he entered the university of Copenhagen, where he took the degree of doctor of philosophy in 1799, and soon afterwards became assistant to the professor of medicine, in which capacity he gave lectures on chemistry and natural philosophy. In 1806, after having enjoyed a travelling scholarship for several years, and visited Holland, the greater part of Germany, and Paris, he was appointed extraordinary professor of natural philosophy in the university of Copenhagen. In 1812 he again visited Germany and France, after having published a manual under the title of *Videnskaben om Naturen's Almindelige Love*, and *Første Indledning til den Almindelige Naturlære* (1811). During his residence at Berlin, he wrote his famous essay on the identity of chemical and electrical forces, in which he first developed the ideas on which were based his great discovery of the intimate connection existing between magnetism and electricity and galvanism—a treatise which, during his residence in Paris, he translated into French, in conjunction with Marcel de Serres. In 1819, he made known these important truths in a Latin essay, entitled *Experimenta circa Efficaciam Conflictus Electrici in acum Magnetici*, which he addressed to all the scientific societies and the leading savans of Europe and America, and thus made good his claim to be regarded as the originator of the new science of electro-magnetism. This discovery, which formed one of the most important eras in the history of modern physical science, obtained for O. the Copley Medal from the Royal Society of England, and the principal mathematical prize in the gift of the Institute of Paris. The original and leading idea of this great discovery had been in his mind since 1800, when the discovery of the galvanic battery by Volta had first led him to enter upon a course of experiments on the production of galvanic electricity. The enunciation of his theory of electro-magnetism was followed by many important experiments in regard to the compression of water, and by numerous other chemical discoveries, among which we may instance his demonstration of the existence of the metal aluminium in alumina. The influence which O. exerted on the science of the day by his discoveries, was recognised by the learned in every country, and honours increased upon him with increasing years. He was corresponding member of the French Institute, perpetual secretary to the Royal Society of Sciences in Copenhagen, a knight of the Prussian Order of Merit, of the French Legion of Honour, and of the Danish Order of the Dannebrog, and a councillor of state. O.'s great object through life was to make science popular among all classes, in furtherance of which he wrote numerous

works, contributed scientific papers to the newspapers and magazines of his own country and Germany, and in addition to his regular prelections in the university, gave courses of popular scientific lectures to the public including ladies. Among the works specially written to promote the diffusion of scientific knowledge, those best known are *Aanden i Naturen* (Kop. 1845), and *Natur-lærens's Mechaniske Deel* (Kop. 1847), both of which have been translated into several other European languages. The majority of his more important physical and chemical papers are contained in Poggendorff's *Annalen*, and were written by him in German or French, both of which he wrote with the same facility as his own language. At the close of 1850, a national jubilee was held in honour of the 50th anniversary of his connection with the university of Copenhagen—a festival which he did not long survive, as his death occurred at Copenhagen 9th March 1851. A public funeral, attended by all persons distinguished by rank or learning in the Danish capital, bore testimony to the respect and esteem with which he was regarded by his fellow-citizens, among whom his memory is cherished, not merely as one of the greatest scientific benefactors of his times, but as a man who contributed largely, by his eloquent and earnest advocacy of liberal principles, to the attainment of the high degree of constitutional freedom which Denmark now enjoys.

ŒSOPHAGUS (Gr. *oio*, to convey, and *phagein*, to eat), or GULLET, a membranous canal, about nine inches in length, extending from the pharynx to the stomach, and thus forming a part of the alimentary canal. It commences at the lower border of the cricoid cartilage of the larynx, descends in a nearly vertical direction along the front of the spine, passes through an opening in the diaphragm, and thus enters the abdomen, and terminates in the cardiac orifice of the stomach, opposite the ninth dorsal vertebra. It has three coats—viz., an external or muscular coat (consisting of two strata of fibres of considerable thickness—an external, longitudinal, and an internal, circular); an internal or mucous coat, which is covered with a thick layer of squamous epithelium; and an intermediate cellular coat, uniting the muscular and mucous coats. In this tissue are a large number of œsophageal glands, which open upon the surface by a long excretory duct, and are most numerous round the cardiac orifice, where they form a complete ring.

The œsophagus is liable to a considerable number of morbid changes, none of which are, however, of very common occurrence.

The most prominent symptom of *Œsophagitis*, or *Inflammation of the Œsophagus*, is pain between the shoulders, or behind the trachea or sternum, augmented in deglutition, which is usually more or less difficult, and sometimes impossible. The affection is regarded as a very rare one, unless when it originates from the direct application of irritating or very hot substances, or from mechanical violence—as, for instance, from the unskilful application of the stomach-pump or probang. Dr Copland, however, is of opinion that it is not unfrequent in children, particularly during infancy, and observes that 'when the milk is thrown up unchanged, we should always suspect the existence of inflammation of the œsophagus.' The ordinary treatment employed in inflammatory diseases must be adopted; and if inability to swallow exists, nourishing liquids, such as strong beef-tea, must be injected into the lower bowel.

*Spasm of the Œsophagus*—a morbid muscular contraction of the tube, producing more or less difficulty of swallowing—is a much more common affection than inflammation. The spasm generally comes on

suddenly during a meal. Upon an attempt to swallow, the food is arrested, and is either immediately rejected with considerable force, or is retained for a time, and then brought up by regurgitation; the former happening when the contraction takes place in the upper part of the canal, and the latter when it is near the lower part. In some cases, solids can be swallowed, while liquids excite spasm; while in other cases the opposite is observed; but in general either solids or liquids suffice to excite the contraction, when a predisposition to it exists. The predisposition usually consists in an excitable state of the nervous system, such as exists in hysteria, hypochondriasis, and generally in a debilitated condition of the body. An attack may consist of a single paroxysm, lasting only a few hours, or it may be more or less persistent for months or even years. The treatment must be directed to the establishment of the general health, by the administration of tonics and anti-spasmodics, by attention to the bowels and the various secretions, by exercise in the open air, the shower-bath, a nutritious diet, &c.; and by the avoidance of the excessive use of strong tea, coffee, and tobacco. Care must also be taken not to swallow anything imperfectly masticated or too hot; and the occasional passage of a bougie is recommended. Brodie relates a case that ceased spontaneously on the removal of bleeding piles. Strychnia is deserving of a trial when other means fail; and if the affection assume a decidedly periodic form, quinia will usually prove an effectual remedy.

*Paralysis of the Œsophagus* is present in certain forms of organic disease of the brain or spinal cord, which are seldom amenable to treatment, and is often a very important part of the palsy that so frequently occurs in the most severe and chronic cases of insanity. In this affection there is inability to swallow, but no pain or other symptom of spasm; and a bougie may be passed without obstruction. The patient must be fed by the stomach-pump, and nutrient injections of strong beef-tea should be thrown into the lower bowel.

*Permanent or Organic Stricture of the Œsophagus* may arise from inflammatory thickening and induration of its coats, or from scirrhus and other formations, situated either in the walls of or external to the tube. The most common seat of this affection is at its upper part. The symptoms are persistent and gradually increasing difficulty of swallowing, occasionally aggravated by fits of spasm; and a bougie, when passed, always meets with resistance at the same spot. When the contraction is due to inflammatory thickening, it may arise from the abuse of alcoholic drinks, or from swallowing boiling or corrosive fluids; and it is said that it has been induced by violent retching in sea-sickness. If unrelieved, the disease must prove fatal, either by ulceration of the tube around the seat of the stricture, or by sheer starvation. When the affection originates in inflammation, some advantage may be derived from a mild course of mercury, occasional leeching, and narcotics; and especially from the occasional passage of a bougie, of a ball-probang (an ivory ball attached to a piece of whalebone), or of a piece of sponge moistened with a weak solution of nitrate of silver. If it is dependent upon malignant disease, and the tissues have become softened by the infiltration of the morbid deposit, the bougie must be directed with the greatest care through the stricture, as a false passage may be easily made into important adjacent cavities.

*Foreign bodies* not very infrequently pass into the œsophagus, and become impacted there, giving rise to a sense of choking and fits of suffocative cough, especially when they are seated in its

upper part. They may not only cause immediate death by exciting spasm of the glottis, but if allowed to remain, may excite ulceration of the parts, and thus cause death by exhaustion. If the body is small and sharp (a fish-bone, for example), it may often be got rid of by making the patient swallow a large mouthful of bread; if it is large and soft (such as too large a mouthful of meat), it may generally be pushed down into the stomach with the probang; while large hard bodies (such as pieces of bone) should be brought up either by the action of an emetic, or by long curved forceps. If the offending body can neither be brought up nor pushed down, it must be extracted by the operation of *Œsophagotomy*—an operation which can only be performed when the impacted body is not very low down, and which it is unnecessary to describe in these pages.

**ŒSTRIDÆ**, a family of dipterous insects, having a mere rudimentary proboscis or none, the palpi also sometimes wanting, and the mouth reduced to three tubercles; the antennæ short and enclosed in a cavity in the forepart of the head; the abdomen large. They are generally very hairy, the hair often coloured in rings. They resemble flesh-flies in their general appearance, and are nearly allied to *Muscidæ*. The perfect insect is very short-lived. The females deposit their eggs on different species of herbivorous mammalia, each insect being limited to a particular kind of quadruped, and selecting for its eggs a situation on the animal suitable to the habits of the larva, which are different in different species, although the larvæ of all the species are parasites of herbivorous quadrupeds. The characters and habits of some of the most notable species are described in the article *Bor*. Animals seem generally to have a strong instinctive dread of the *O.* which infest them.

**O'FFENBACH**, a manufacturing town of Hesse-Darmstadt, on the south bank of the river Main, within the domains of the Princes of Isenburg-Birstein, 4 miles south-east of Frankfurt. Pop. (1861) 16,685. *O.* is pleasantly situated in one of the richest parts of the valley of the Main, and is one of the most important manufacturing towns in the province. Among the industrial products, its carriages have acquired a pre-eminent character for excellence; and next to these, stand its book-bindings, articles of jewellery, gold and silver goods, carpets, and silk fabrics. It has also good manufactories of wax-cloth, papier-mâché snuff-boxes, tin-lackered wares, umbrellas and parasols, wax-candles, leather, hats, tobacco, sugar, and ginger-bread and spiced cakes. *O.* has several churches, and a Jewish synagogue. The palace is the winter residence of the Isenburg-Birstein family, to whom the old castle, now in ruins, also belongs. A pontoon-bridge across the river, and a railway to Frankfurt, facilitate intercommunication, and tend materially towards the maintenance of its active trade.

**OFFENCES AGAINST RELIGION, PUBLIC PEACE, &c.** See *RELIGION, PEACE, &c.*

**OFFER AND ACCEPTANCE** is one mode of entering into a contract of sale. At an auction, the highest offer is generally accepted as a matter of course; and when accepted, the contract is completed. An offer is often made by letter from one merchant to another to buy or sell goods. In such a case, the party offering is bound to wait until he gets an answer by return of post or messenger; for until then the offer is supposed to be continuously made. But if A offer to B personally to sell, and B ask time to consider for a day, or any given time, A is not bound to wait a single moment, according to

## OFFERING—OFFICIAL ASSIGNEE.

English law, and may withdraw at any time from the offer, because he had no legal consideration for waiting; whereas, in Scotland, in the same circumstances, A would be bound to wait the time agreed upon.

**OFFERING.** Under the head **FIRST-FRUIT** (q. v.) have been described the various offerings prescribed in the Jewish law. We shall have occasion to consider, under the head of **SACRIFICE** (q. v.), some further questions connected with the subject of offerings in public worship. In the Christian community there appears to have existed, from the earliest times, a practice of making voluntary offerings, for purposes not directly connected with public worship. See **OFFERTORY**.

**OFFERTORY** (Lat. *offertorium*, from *offero*, I offer) is the name given to that portion of the public liturgy of the Roman Catholic Church with which the eucharistic service, strictly so called, commences. In the Roman Liturgy it consists of one or two verses from some book of Scripture, generally from the Old Testament, but sometimes also from the Epistles. In the Ambrosian Liturgy it consists of a prayer, similar in form to the *collect* or *secret* of the mass; and in both, this recital is followed by the preparatory offering up of the bread and wine, accompanied by certain ceremonies and forms of prayer.

This offering of the bread and wine in the public service became, from a very early period, the occasion of a voluntary offering, on the part of the faithful; originally, it would seem, of the bread and wine designed for the eucharistic celebration and for the communion of the priest and the congregation, sometimes even including the absent members, and also for the *agape*, or common sacred feast, which accompanied it. That portion of the offerings which remained in excess of what was requisite for these purposes was applied to the relief of the poor, and to the support of the clergy. These offerings were ordinarily made by the faithful in person, and were laid upon the altar; and the Ambrosian rite still preserves this usage in a ceremonial which may be witnessed in the cathedral of Milan. By degrees, other gifts were superadded to those of bread and wine—as of corn, oil, wax, honey, eggs, butter, fruits, lambs, fowl, and other animals; and eventually of equivalents in money or other objects of value. The last-named class of offerings, however, was not so commonly made upon the altar and during the public liturgy, as in the form of free gifts presented on the occasion of other ministerial services, as of baptism, marriages, funerals, &c.; and from this has arisen the practice in the Roman Catholic Church of the mass-offering, or *honorarium*, which is given to a priest with the understanding that he shall offer the mass for the intention (whence the honorarium itself is often called an 'intention') of the offerent. In some places, however, and among them in some parts of Ireland, offerings 'in kind' are still in use, not indeed in the form of the ancient offertory, but in the shape of contributions of corn, hay, &c., at stated seasons, for the use of the parochial clergy. At weddings also, and in some places at funerals, offerings in money are made by the relations and friends of the newly married or of the deceased. In the Liturgy of the English Church allusion is made to the practice of oblations, and some of the recent controversies have turned upon the revival of the 'offertory,' which has found some advocates.

**OFFICE, THE DIVINE** (Lat. *officium*, duty), is the name popularly given to the **CANONICAL HOURS** (q. v.) prescribed to be read each day by bishops, priests, deacons, and sub-deacons in the Roman

Catholic Church. Under the head **BREVARY** will be found a general description of the contents and the arrangement of that great service-book. The special portions assigned for any particular day constitute what is called the divine office for that day; and each person who is bound in virtue of his order to recite the Breviary, is obliged, under pain of sin, to read, not merely with the eye, but with distinct, although it may be silent, articulation, each and all these portions. The adjustment of the portions of the office of each day, the combination of the 'ordinary' portions which are read every day in common, with the parts 'proper' for each particular day, is a matter of considerable difficulty, and is regulated by a complicated system of **RUBRICS** (q. v.).

**OFFICE, HOLY, CONGREGATION OF THE** In the article **INQUISITION** (q. v.) it has been explained that that tribunal is sometimes called by the name Holy Office. That title, however, properly belongs to the 'Congregation' at Rome, to which the direction of the Roman tribunal of the Inquisition is subject. This Congregation was established by Paul III. in 1542, and its organisation was completed by Sixtus V. It consists of twelve cardinals, a commissary, a number of 'theologians' and canonists who are styled 'consulters,' and of another class of officials called 'qualifiers,' whose duty it is to report on each case for the information of the cardinals. In the most solemn sessions of the Holy Office the pope himself presides in person. The action of the Holy Office, in addition to questions of heresy and crimes against faith, also extends to ecclesiastical offences, especially in connection with the administration of the sacraments.

**OFFICE COPY** is a copy made of a document by some officer of a court in whose custody the document is; and in general such copies are receivable in evidence, without further proof, in the same court, but not in other courts, except some statute makes them evidence.

**OFFICERS, MILITARY AND NAVAL.**—*Military Officers* are combatant and non-combatant, the latter term including paymasters, medical officers, commissariat, and other civil officers. The great divisions of rank are commissioned, warrant, and non-commissioned officers. Commissioned officers are those holding commissions from the crown, or a lord-lieutenant, and comprise all holding the rank of ensign, or corresponding or superior rank. Divided by duties, they are Staff Officers (see **STAFF**), or Regimental Officers (see **REGIMENT**); divided by rank, General Officers (q. v.), Field-Officers (q. v.), and troop or company officers. The last are captains, lieutenants, and cornets or ensigns, and, except in the cavalry, are unmounted. The different systems of promotion for officers, and especially the intricacies of the purchase system, will be explained under **PROMOTION, ARMY, and PURCHASE SYSTEM**. The only warrant officers in the army are Master-gunners (see **GUNNER**) and Schoolmasters. Non-commissioned officers are described under that heading.

*Officers, Naval*, are commissioned, warrant, and petty officers. Commissioned officers are admirals, captains, commanders, lieutenants, and sub-lieutenants, described under their respective titles. Warrant Officers (q. v.) are boatswains, carpenters, gunners, and one class of engineers. Petty officers will be described under that heading, and constitute a very important portion of the management in a ship-of-war.

**OFFICIAL ASSIGNEE**, in English Law, is an officer of the Bankruptcy Court, in whom a

OFFICIAL PLANTS—OGHAMS.

bankrupt's estate vests the moment an adjudication of bankruptcy is made. He is the manager of the property, and can sell the estate under the directions of the court in urgent cases, such as where the goods are perishable; but in general, he is assisted in the management by the creditors' assignees, who are selected from the body of creditors by the other creditors' votes. The official assignee is appointed by the Lord Chancellor, being selected from the body of merchants, brokers, or accountants. He is bound to find security to the extent of £6000. He is prohibited from carrying on trade on his own account. The salary is £1000.

**OFFICIAL PLANTS** (Lat. *officina*, a shop) are those medicinal plants which have a place in the pharmacopoeias of different countries, and which are therefore sold—or some of their products or preparations of them—by apothecaries and druggists. The medicinal plants cultivated to any considerable extent are all official, but many are also official which are not cultivated. See **MEDICINAL PLANTS**.



Offset.

**OFFSET**, or **SET-OFF**, the splay or sloping part of a wall, &c., joining parallel surfaces when the upper face recedes from the lower. This frequently occurs on buttresses (see fig.). The *O.* is usually protected with dressed stones, having a projection or drip on the lower edge to prevent the rain from running down the wall.

**OFFSETS**, a term used by gardeners to designate the young bulbs, which springing from the axils of the scales of a bulb (q. v.), grow beside it, exhausting its strength, but which serve for the propagation of the plant. A crop of shallots, or of potato onions, consists entirely of the offsets of the bulbs planted in spring; although the term is not commonly used except as to bulbous-rooted plants prized for the beauty of their flowers.

**OFFSETS**. Let AEF... B... D... C be a field with very irregular sides; take the points A, O, M, C at or as near the corners as convenient, the object being to enclose as much of the field as possible within the quadrilateral AOMC; and for this

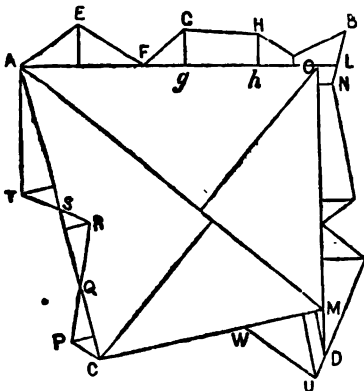

Fig. 1.

purpose it is sometimes necessary, as in the present case, to include a corner (as SRQ) which is outside the field. The area A OCD is found by means of the diagonal AM, and the perpendiculars on it from C and O. The area A EFG... BL is found

by dividing it into triangles and trapezoids by means of perpendiculars (to which the term *offsets* was originally applied, though it now denotes the irregular area before mentioned) from the corners E, G, H, &c. (see **TRIANGLE** and **TRAPEZOID**), and adding together the areas of the separate figures AEF, FGg, GHg<sup>h</sup>, &c. Similarly the areas of OLN... D and MDUW are found. To the sum of these must be added the areas of the triangles ATS, QPC, diminished by the area of SRQ, and the result is the whole area of the field. If the offset have no distinct corners, as (fig. 2) ABLMN... OK,

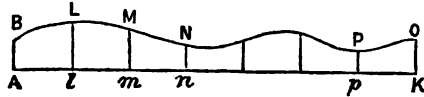

Fig. 2.

then the base AK is divided into equal parts by perpendiculars ABL, Mm, Nn, &c., and the area of the offset is found approximately as follows: the whole offset =  $ABLl + LmM + MmNn + \&c. + PpOK = Al \times \frac{1}{2} (AB + Ll) + lm \times \frac{1}{2} (Ll + Mm) + mn \times \frac{1}{2} (Mm + Nn) + \dots + pK \times \frac{1}{2} (pP + OK) =$  (since the divisions of the base are equal)  $Al \times \frac{1}{2} \{AB + 2Ll + 2Mm + 2Nn + \dots + 2pP + OK\} = Al \times \left\{ \frac{AB + OK}{2} + Ll + Mm + Nn + \dots + Pp \right\}$ ;

i. e., the area of an offset is found approximately by adding the intermediate perpendiculars to the semi-sum of the first and last, and multiplying the sum-total by the length of a division of the base, the divisions being equal; and the greater the number of perpendiculars, the nearer the result is to the true area.

**O'GDENSBURG**, a village and port of entry in New York, U. S., on the south bank of the river St Lawrence, at the mouth of the Oswegatchie, 210 miles north-west of Albany, and at the western terminus of the Northern Railway. It has a large lake and river trade, mills and factories, custom-house, town-hall, &c., and a steam-ferry to Prescott, Canada. Pop. in 1860, 7410.

**OGEE**, a moulding consisting of two curves, one concave and the other convex (a). It is called (in Classic Architecture) *Cymatium* or *Cyma Reversa* (see **MOULDING**). The ogee is also much used in Gothic architecture. An arch having each side formed with two contrasted curves is called an ogee arch (b). Figure a represents Hogarth's line of beauty.

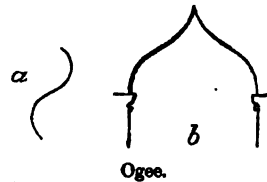

**O'GHAMS**, the name given to the letters or signs of a secret alphabet long in use among the Irish and some other Celtic nations. Neither the origin nor the meaning of the name has been satisfactorily explained.

The alphabet itself is called *Bethuisin*, or *Bethuis*, from its first two letters, 'b,' called 'beth' (birch), and 'l,' called 'luis' (quicken). Its characters are lines, or groups of lines, deriving their significance from their position on a single stem or chief line—over, under, or through which they are drawn either straight or oblique. In some cases, the edge of the stone or other substance on which the Oghams are incised, serves the purpose of the stem or chief line. About eighty different forms of

the alphabet are known. The following is the one most commonly used :

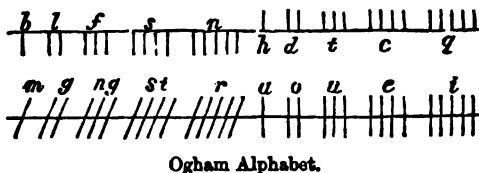

Ogham Alphabet.

These seem to have been all the letters of the first Ogham alphabet. Five characters were afterwards added to represent diphthongs :

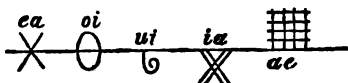

The sign for the diphthong 'ea' is said to be the only one which has been observed on ancient monuments. It is added that the sign for 'ui' sometimes stands for 'y,' that the sign for 'ia' sometimes stands for 'p,' and that the sign for 'ae' stands also for 'z,' for 'cc,' for 'ch,' for 'ach,' and for 'uch.'

Ogham inscriptions generally begin from the bottom, and are read upwards from left to right to the top, when they are carried over, and run down another side or angle. Most of those which have been read give merely a proper name with its patronymic, both in the genitive case. The stones on which Oghams are cut would seem, for the most part, to have been sepulchral. Oghams are of most frequent occurrence in Ireland, where they are found both written on books and inscribed on stones, metals, or bones. The Oghams on stones are most numerous in the counties of Kerry and Cork. A few Ogham inscriptions on stones have been discovered in Wales—as at St Dogmael's, in Pembrokeshire; near Margam, in Glamorganshire; and near Crickhowel, in Brecknockshire. There are a few in Scotland, as on the Newton Stone and the Logie Stone in Aberdeenshire, on the Golspie Stone in Sutherland, and on the Bressay Stone in Shetland. One has been found in England—at Fardel, in Devonshire. Oghams have been observed on an ancient MS. of Priscian, which belonged to the famous Swiss monastery founded in the 7th c. by the Irish missionary, St Gall (q. v.).

The difficulties of deciphering Ogham inscriptions cannot be said to have been as yet altogether overcome. It is confessed by the most learned and judicious of Ogham scholars, the Rev. Charles Graves, D.D., of Trinity College, Dublin, that the nature of the character is such that it does not at once appear which, of four different ways of reading, is the right one; that the words being written continuously, as in ancient MSS., there is great chance of error in dividing them; and that the Celtic names inscribed are generally Latinised in such a manner as not readily to be recognised.

The old school of Irish antiquaries contended that the Oghams were of Persian or Phœnician origin, and were in use in Ireland long before the introduction of Christianity. But this theory is now generally discarded, as not only unsupported, but as contradicted by facts. A comparison of the Ogham alphabet, with the alphabets of Persepolis and Carthage, shews that there is no likeness between them. The great majority of Ogham monuments, it has been observed, bear more or less distinct marks of Christian hands. Several are inscribed with crosses, as old, to all appearance, as the Oghams themselves. Many stand in Christian burying-

grounds, or beside Christian cells or oratories. Some still bear the names of primitive saints. At least one is inscribed with a Christian name; and some of the inscriptions betray an undeniable knowledge of Latin. At the same time, it has been argued by one of the most learned of Celtic philologists, Mr Whitley Stokes, that 'the circumstance that genuine Ogham inscriptions exist both in Ireland and in Wales which present grammatical forms agreeing with those of the Gaulish linguistic monuments, is enough to shew that some of the Celts of these islands wrote their language before the 5th c., the time at which Christianity is supposed to have been introduced into Ireland.' It has been observed by Dr Graves, on the other hand, that there are many points of resemblance between the Oghams of the Celts and the Runes of the Norsemen; and, indeed, one Irish MS. asserts that the Oghams came to Ireland from Scandinavia :

'Hither was brought, in the sword sheath of Lochlan's king,  
The Ogham across the sea. It was his own hand that cut it.'

The Ogham is said to have been in use so recently as the middle of the 17th c., when it was employed in the correspondence between King Charles I. and the Earl of Glamorgan.

The best account of Oghams is in Dr Graves's papers in the *Proceedings of the Royal Irish Academy*, vol. iv. pp. 70, 173, 183, 254; vol. v. pp. 234, 401; vol. vi. pp. 71, 209, 248; and the *Catalogue of the Museum of the Royal Irish Academy*, pp. 134—140; and in Mr Whitley Stokes's *Three Irish Glossaries*, pp. 55—57, compared with Thomas Innes's *Critical Essay on the Ancient Inhabitants of Scotland*, vol. ii. pp. 440—466. Dr Graves has had a work for some time in the press, the issue of which is looked for with considerable interest—*A Treatise on the Ogham or Occult Forms of Writing of the Ancient Irish, from a MS. in the Library of Trinity College, Dublin, with a Translation and Notes, and a Preliminary Dissertation*. It is to be printed for the Irish Archaeological and Celtic Society. Ogham inscriptions may be seen in the Museum of the Royal Irish Academy at Dublin, in the Museum of the Society of Antiquaries of Scotland at Edinburgh, and in the British Museum at London.

O'GIVES, the arches in pointed Gothic vaulting which cross the vault diagonally from one angle to another.

OGYGES, the earliest king of Attica and Bœotia named in Greek legend. In his time (according to Larcher, about 1759 B.C.) a great flood took place, called the Ogygian Flood, which desolated all the lower districts of both countries, and destroyed their inhabitants. The different legends lead to the supposition that under O. an Egyptian colony came to Bœotia, and thence to Attica. From him Bœotia took the name of Ogygia.

OGY'GIA, a genus of Trilobites peculiar to the Llandello flags of the Lower Silurian period. Six species have been described.

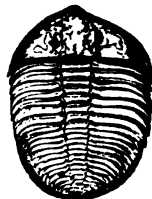

Ogygia Buchii.

OHIO, one of the United States of America, lies between lat. 38° 17'—41° 54' N., and long. 80° 34'—84° 40' W.; 225 miles in extent from east to west, and nearly 200 miles from north to south; containing 39,964 square miles, or 25,576,960 acres; bounded N. by Michigan and Lake Erie, E. by Pennsylvania and Virginia, from which it is separated by the Ohio River, which also

## OHIO—OIL PALM.

forms its southern boundary, separating it from Virginia and Kentucky, and W. by Indiana. The Ohio River forms its boundary for 436 miles, and its lake shore is 230 miles. The high table-lands hilly, and in parts mountainous regions of O., are drained by numerous rivers, among which are the Great and Little Miami, Sciota, and Muskingum, affluents of the Ohio; and the Maumee, Sandusky, Huron, Vermillion, Cuyahoga, and Ashtabula, which empty into Lake Erie. Drift formations prevail in the north, alluvium in the south, with extensive coal-measures, and limestone strata, shales, marls, and gypsum, giving the whole state a wonderful fertility. The coal-beds of Eastern Ohio cover 10,000 square miles, with abundant deposits of iron ore. In the north are valuable deposits of buhrstone, a fossiliferous flinty quartz, used for millstones. The salt wells of Pomeroy yield 1,000,000 bushels per annum, with a plentiful escape of gas. Oil wells have also been opened. The soil, rich everywhere, is so fertile in the river bottoms as to have borne heavy cereal crops fifty successive years without manuring; the climate is temperate, with a liability to a cold in winter reaching sometimes to 20° below zero. It is healthy, except lowlands liable to fever and ague. The forests, which still cover large portions of the state, are rich in oak, black walnut, maple, &c.; the chief agricultural productions are Indian corn, wheat, rye, oats, hay, sorghum, tobacco, hemp, peaches, apples, grapes, cattle, sheep, swine, the latter being one of its chief exports. The farms average 84 acres; there are 310,000 proprietors. The chief manufactures are iron, clothing, furniture, spirits, wines, cotton, and woollen. A large commerce is carried on by the Ohio River, the lakes, two canals which connect Lake Erie and the Ohio, and numerous railways. The state is organised in 88 counties. The chief towns are Cincinnati, Cleveland, Columbus the capital, Sandusky, Zanesville, &c. There is a state bank, with 36 branches; the state revenue is 4,000,000 dollars. Among the state institutions are 4 lunatic asylums, asylums for deaf and dumb, blind, idiots, penitentiary, reformatories, &c. In 1860, 933 convicts earned 295 dollars over their expenses. The number of paupers was 15,148. There are 5277 churches. Every 36th quarter mile section of land is appropriated to the support of free schools, and two townships of 69,120 acres for colleges. The expenditure for education is 2,760,000 dollars. There are 22 colleges, 11 theological institutions, 10 medical, 90 academies, and extensive state and school libraries. There are 261 periodical publications, of which 26 are daily.

O. was organised and admitted as a state in 1803. The population in 1800 was 45,365; 1820, 561,434; 1840, 1,519,467; 1860, 2,339,599, of whom 111,257 were Germans, 51,562 Irish, 36,000 English and Scotch.

OHIO, a river of the United States of America, called by the French explorers, after its Indian name, *la Belle Rivière*, next to the Missouri, the largest affluent of the Mississippi, is formed by the union of the Alleghany and Monongahela, at the western foot of the Alleghanies, at Pittsburgh, in Pennsylvania, and flows west-south-west 950 miles, with a breadth of 1200 to 4000 feet, draining, with its tributaries, an area of 202,400 square miles. In its course it separates the northern states of Ohio, Indiana, and Illinois from the southern states of Virginia and Kentucky. The principal towns upon its banks are Cincinnati, Louisville (where there are rapids of 22 feet in a mile, with a steam-boat canal), Wheeling, Maysville, and Pittsburgh and Cairo at its source and mouth. It is navigable from Wheeling, 100 miles below Pittsburg. The banks of the O. are

generally high and terraced. It is often shallow and scarcely navigable, sometimes frozen, and subject to floods of 50 or 60 feet above low-water. Bordered by a rich country, and great deposits of coal and iron, it is the channel of a vast commerce, which it shares with its chief branches, the Tennessee, Cumberland, Wabash, Green, &c.

OIL-CAKE, the cake which remains in the press, when seeds are crushed to express the oil which they contain. Oil-cake still retains a portion of the oil of the seed, along with almost all its other constituents, and is valuable either for feeding cattle or for manure. *Linseed-cake* is so much more largely used in Britain than any other kind, that the name oil-cake is in general exclusively appropriated to it, the other kinds being known as *Rape-cake*, *Poppy-cake*, *Hemp-cake*, *Cola-cake*, &c., according to the plant from the seed of which they are produced. The use of oil-cake for feeding cattle has very much increased of late years, and it is an article of commercial importance. Large quantities are imported into Britain from different parts of the continent of Europe, and from North America. But *English Linseed-cake*—cake made at oil-mills in England, mostly from imported seed—is preferred to any other, because heat not being so freely applied during the expression of the oil, more oil is left in the cake, and also because foreign cake often suffers from dampness both before and during the sea passage. Besides the oil which remains in it, linseed-cake contains from 24 to 33 per cent. of nitrogenous substances or protein compounds, which make it very valuable both for feeding cattle and for manure. The value of linseed-cake for feeding is greater than that of any kind of grain or pulse.—*Rape-cake* is, next to linseed-cake, the kind of oil-cake best known in Britain. It is much cheaper than linseed-cake, but is not relished by cattle, having a hot taste, and a tendency to become rancid. Sheep, however, eat it readily, and it is often employed for fattening them. It is often also ground to a coarse powder (*rape-dust*), and used as a manure. Its fertilising power is great, and it is used by the Flemish farmers as guano now is by those of Britain.—*Cotton Seed-cake* is much used as a manure in some parts of North America.—*Cocoa-nut-cake* is used in the south of India, both for feeding cattle and for manure.—Other kinds of cake are noticed, if sufficiently important, under the plants from which they are derived. Their properties are generally similar to those of linseed-cake, although the pungency of some, as *Mustard-cake*, renders them unsuitable for feeding cattle. See also OIL-PLANTS.

OILLETS, or CEILLETS, small openings, often circular, used in mediæval buildings for discharging arrows, &c., through.

OIL MILL. See OILS.

OIL PALM (*Elæis*), a genus of palms, of the same tribe with the cocoa-nut palm. The best known species, the O. P. of tropical Africa, sometimes attains a height of 60—80 feet. The stems are thickest in the middle, tapering chiefly upwards. The leaves are pinnate, their footstalks spiny. The flowers have a strong peculiar smell, like that of anise or chervil. The fruit forms an immense head, like a great pine-apple, consisting of a great number of bright orange-coloured drupes, having a thin skin, an oily pulp, and a hard stone. The pulp of the drupes, forming about three-fourths of their whole bulk, yields, by bruising and boiling, an oil, which when fresh has a pleasant odour of violets, and when removed into colder regions acquires the consistency of butter. This oil is now very largely imported from tropical Africa into Britain, and is



much used for many purposes, as for making candles, toilet soaps, &c., and for lubricating machinery and the wheels of railway carriages. When fresh, it is eaten like butter. See OILS. The nut was formerly rejected as useless after the oil had been obtained from the fruit; but from its kernel a fixed oil is now extracted, called PALM-NUT OIL; which is clear and limpid, and has become to some extent an article of commerce. The O. P. abounds in mangrove swamps, but is also a conspicuous feature



Oil Palm.

(Copied from Livingstone's *Travels in Central Africa*.)

of the landscape on sandy coasts in the tropical parts of Western Africa. It yields from its trunk abundance of a pleasant and harmless beverage, which, however, becomes intoxicating in a few hours; called *Malova* in Angola, and much used there as an alcoholic stimulant. The unripe nuts of the O. P. are used in some parts of Africa for making an excellent kind of soup. The O. P. has been introduced into some parts of America, and is now abundant in them.

**OIL-REFINING.** Several oils, from the mode of their extraction, are necessarily impure, and various means are taken for refining or purifying them: thus, the so-called *fish-oils*—that is, whale, seal, cod, &c.—are clarified either by mixing them with a chemical solution, or by passing steam through them and filtering through coarse charcoal. The chemical solutions employed are various. One method is, to use a strong solution of oak bark, the tannic acid in which combines with the albuminous matters present in the oil, and precipitates them; another plan is, to agitate bleaching-powder, formed into a milk with water, with the oil; and then, after subsidence of the chloride of lime and water, to wash the oil with water, or jets of steam passed through it. A more simple and very effective plan, invented by Mr Dunn, is to apply a steam heat not exceeding 200° F., and then pass a current of air of the same temperature through it continuously for some time: this effectually bleaches the oil.

Olive, and some other vegetable oils, are refined by agitating them with a saturated solution of caustic soda. This renders the whole soapy; but after a time the oil precipitates a saponaceous deposit, and the remainder becomes quite clear and pure, and is then poured off. The value of several of the most important oils of commerce is so greatly increased by refining, that this art has now become a very important branch of business, and is carried out on a large scale.

**OILS (including Fats).** The fats and fixed oils constitute an important and well-marked group of organic compounds, which exist abundantly both in the animal and vegetable kingdoms. They are not simple organic compounds, but each of them is a mixture of several such compounds to which the term *glycerides* is applied; and the glycerides which by their mixture in various proportions form the numerous fats and oils are mainly those of palmitic, stearic, and oleic acids—if we adopt the recent view that Margoric Acid (q. v.) has no independent existence—and to a less extent those of other fatty acids, which will be presently noticed, such as butyric, caproic, caprylic, and capric acids, which are obtained from butter; myristic acid, which is obtained from cocoa-nut oil, &c. The members of this group may be solid and hard, like suet; semi-solid and soft, like butter and lard; or fluid, like the oils. The solid and semi-solid are, however, generally placed together and termed fats, in contradistinction to the fluid oils. The most solid fats are readily fusible, and become reduced to a fluid or oily state at a temperature lower than that of the boiling-point of water. They are not volatile, or, in other words, they cannot be distilled without decomposition, and it is not until a temperature of between 500° and 600° is reached that they begin nearly simultaneously to boil and to undergo decomposition, giving off acrolein (an acrid product of the distillation of glycerine) and other compounds. In consequence of this property, these oils are termed *fixed oils*, in contradistinction to a perfectly separate group of oily matters, on which the odoriferous properties of plants depend, and which, from their being able to bear distillation without change, are known as *volatile oils*. These, which are also known as *essential* or *etheral oils*, differ *in toto* in their chemical composition from the compounds we are now considering, and will be separately noticed in the latter part of this article. All the fats and oils are lighter than water, and are perfectly insoluble in that fluid. Their specific gravity ranges from about 0.91 to 0.94. They dissolve in ether, oil of turpentine (one of the volatile oils), benzol, and to a certain extent in alcohol; while, on the other hand, they act as solvents for sulphur, phosphorus, &c. If a fatty matter be shaken with a watery solution of albumen, gum, or some other substance that increases the density of the water, and renders it viscid, the mixture assumes a milky appearance, in consequence of the suspension of the fat or oil in the form of microscopic globules, and is termed an *emulsion*. These bodies possess the property of penetrating paper and other fabrics, rendering them transparent, and producing what is well known as a greasy stain. They are not readily inflammable unless with the agency of a wick, when they burn with a bright flame. In a pure and fresh state they are devoid of taste and smell, but on exposure to the air they become oxidised and acid, assume a deeper colour, evolve a disagreeable odour, and are acrid to the taste; or, in popular language, they become *rancid*. The rapidity with which this change occurs is considerably increased by the presence of mucilaginous or albuminous bodies. The rancidity may be removed by shaking the oil in hot water in which a little hydrated magnesia is suspended.

The general diffusion of fats and oils in the animal kingdom has been already described. (See FATS, ANIMAL.) In the vegetable kingdom they are equally widely distributed, there being scarcely any tissue of any plant in which traces of them may not be detected; but they are specially abundant in the seeds. The seeds of the *cruciferae* are remarkably rich in oil; linseed yielding fully 20 per cent., and

rape-seed about 40 per cent. of oil; and some fruits, as those of the olive and oil-palm, yield an abundance of oil.

The uses of the oils and fats are numerous, and highly important, various members of this group being extensively employed as articles of food, as medicines, as lubricating agents, in the preparation of soaps, plasters, ointments, varnishes, pigments, candles and other means of illumination, for the purpose of dressing leather, &c. The following are the most important members of the group:

1. *Vegetable Fats*.—The chief solid fats of vegetable origin are cocoa-nut oil, nutmeg butter, and palm oil. The fluid vegetable fats or oils are divisible into the *non-drying* and the *drying oils*; the latter being distinguished from the former by their becoming dry and solid when exposed in thin layers to the air, in consequence of oxygenation; while the former do not absorb oxygen, but are converted by hyponitric acid or sub-oxide of mercury into elaidine (as described in the article *OLEINE*), a reaction which is not exhibited by the drying oils. Some of the drying oils, especially linseed oil, when mixed with cotton, wool, or tow, absorb oxygen so rapidly, and consequently become so heated as to take fire, and many cases of the spontaneous combustion of heaps of oily materials that have been employed in cleaning machinery have been recorded. The drying property may be much increased by treating the oils with a little litharge or oxide of manganese, and linseed oil thus treated is then known as *boiled oil*. The chief non-drying oils are olive oil, almond oil, and colza oil; while the most important drying oils are those of linseed, hemp, poppy, and walnut; castor oil seems to form a link between these two classes of oils, since it gradually becomes hard by long exposure to the air.

2. *Animal Fats*.—The chief solid fats are suet, lard, butter, goose grease, &c.; while among the fluid fats or oils, sperm oil, ordinary whale oil, cod-liver oil, and neat's-foot oil may be especially mentioned. In many of their characters, spermaceti and bees-wax resemble the solid fats, but, as will be shewn in the articles on these subjects, they are not glycerides. As a general rule, stearine and palmitine, both of which have comparatively high fusing points (between 157° and 114°), preponderate in the solid fats; while oleine, which is fluid at 32°, is the chief constituent of the oils.

One or two of the most important of the decompositions of the fats must be noticed. When any of these bodies are heated with the hydrated alkalies, they undergo a change which has long been known as saponification, or conversion into soap (q. v.), in which the fatty acid combines with the alkali to form a soap, while the sweet viscid liquid glycerine is simultaneously formed. The combination of a fatty acid with oxide of lead forms a *plaster*. For further details on these points, the reader is referred to the articles *SOAP* and *PLASTERS*.

The process of saponification affords a ready means of isolating the fatty acids, as the stearic or oleic acid may be at once separated from an alkaline stearate or oleate by the addition of hydrochloric or tartaric acid. When the fatty acids are, however, required on a large scale, as for the manufacture of the so-called stearine candles, which in reality consist mainly of stearic and palmitic acids, sulphuric acid and the oil or fat are made to act upon each other at a high temperature. See *CANDLE*. The fatty acids may also be procured in a very pure form by the injection of superheated steam at a temperature of between 500° and 600° into heated fat—a process which, according to Professor Miller, 'from its simplicity and from the purity of the products which it yields, bids fair to

supersede those previously employed in the preparation of the fatty acids for illuminating purposes.'

The only fatty acids which have been specially mentioned in this article are those which occur in natural glycerides, such as stearic, palmitic, and oleic acids. The term *fatty acid* has, however, in Chemistry a wide signification, and is applied to many acids homologous to stearic acid, but not occurring in any natural fats or oils. Thus stearic acid may be taken as the type of a group of acids (of which seventeen are already known) represented by the general formula,  $C_{2n}H_{4n}O_2$ , commencing with formic acid ( $C_1H_2O_2$ ), including acetic, propionic, butyric, valeric (or valerianic), caproic, oenanthylic, caprylic, pelargonic, capric, lauric, myristic, palmitic, stearic, arachidic, and cerotic acids, and terminating with melissic acid ( $C_{26}H_{50}O_2$ ). These are divided into the volatile and the true (or solid) fatty acids; the volatile acids being those from formic to capric acid, while the remainder, beginning with lauric acid, are the true fatty acids. The *volatile fatty acids* are fluid, and for the most part only at ordinary temperatures, may be distilled without change, possess a pungent odour, and are acrid to the taste, and their solutions redden litmus paper strongly. The *true fatty acids*, on the other hand, are solid at ordinary temperatures, are devoid of taste and smell, cannot be distilled, except *in vacuo*, without decomposition, and only exert a slight action on litmus. The volatile acids occur in the animal and vegetable kingdoms (formic acid, for example, in red ants, and valeric acid, in the root of valerian), and they are likewise produced by the oxidation and spontaneous decomposition of numerous animal and vegetable products. The entire series, up to capric acid, may be obtained by oxidising oleic acid with nitric acid. The true or solid acids only occur as constituents of animal and vegetable fats.

Professor Miller makes a second group of fatty acids, of which oleic acid is the type, and which have the general formula  $C_nH_{2n-2}O_2$ ; but as oleic acid is the only member of this group which is of any practical importance, it is sufficient to refer the reader to the special article on that acid.

A complete list of even the chief fats and fixed oils would take up far more space than we can command. In the article 'Fixed Oils,' in *The English Cyclopædia*, the reader will find 64 of the most important of these substances mentioned, with in most cases a brief notice of the origin and properties of each. The British pharmacopœia contains hog's lard, mutton suet, cod-liver oil, concrete oil (or butter) of nutmeg, and almond, castor, croton, linseed, and olive oils, besides the closely allied substances spermaceti and wax.

The *Volatile or Essential Oils* exist, in most instances, ready formed in plants, and are believed to constitute their odorous principles. They form an extremely numerous class, of which most of the members are fluid; a few (oil of aniseed, for example) being solid at ordinary temperatures, but all of them are capable of being distilled without undergoing change. They resemble the fixed oils in their inflammability, in their solubility in the same fluids, and in their communicating a greasy stain to paper or any other fabric; but the stain in this case soon disappears, and they further differ in communicating a rough and harsh rather than an unctuous feeling to the skin. Their boiling points are in almost all cases far higher than that of water, but when heated with water, they pass off with the steam—a property on which one of the chief modes of obtaining them depends. See *PERFUMERY*. The oils have characteristic penetrating odours, which are seldom so pleasant as those of the plants from which they are obtained, and their taste is hot and irritating.

## OILS.

They vary in their specific gravity, but most of them are lighter than water, and refract light strongly. Most of them are nearly colourless when fresh, but darken on exposure to light and air; but a few are green, and two or three of a blue colour. By prolonged exposure they absorb oxygen, and become converted into resins.

By far the greater number of them are products of the vital activity of plants, in which most of them exist ready formed, being enclosed in minute cavities, which are often visible to the naked eye. Although diffused through almost every part of a plant, the oil is especially abundant in particular organs of certain families of plants. In the *Umbelliferae*, it is most abundant in the seeds; in the *Rosaceae*, in the petals of the flowers; in the *Myrtaceae* and *Labiatae*, in the leaves; in the *Aurantiaceae*, in the rind of the fruit. As in the case of the animal and vegetable fats and fixed oils, so most of the essential oils occurring in plants are mixtures of two or more distinct chemical compounds, one of which usually contains no oxygen, while the others are oxidised. Of these, the former, which is a pure hydrocarbon, is the more volatile, and acts as a solvent for the others. Most of these oils, when cooled, separate into a solid and a fluid portion, to which the terms *Stearopten* and *Elæopten* have been applied.

In the comparatively few cases in which the oils are not formed naturally, they are produced by a species of fermentation, as in the case of Oil of Bitter Almonds and Oil of Mustard (q. v.), while others are the product of the dry distillation or of the putrefaction of many vegetable bodies. Some of the natural oils, as those of cinnamon, spiræa, and winter-green, have also been artificially produced.

The essential oils are much employed in the fabrication of Perfumery (q. v.), for the purpose of flavouring liqueurs, confectionary, &c., for various purposes in the arts (as in silvering mirrors), and in medicine. The special uses of the most important of these oils in medicine will be noticed subsequently.

The members of this group, which is an extremely numerous one (more than 140 essential oils being noticed in the article on that subject in *The English Cyclopædia*), admit of arrangement under four heads. 1. Pure Hydrocarbons; 2. Oxygenous Essential Oils; 3. Sulphurous Essential Oils; 4. Essential Oils obtained by Fermentation, Dry Distillation, &c.

1. The *Pure Hydrocarbons* are for the most part fluid, and have a lower specific gravity, a lower boiling point, and a higher refractive power than the oxygenous oils. They absorb oxygen, and are converted into oxygenous oils and resins. They may be separated from oxygenous oils, with which they are usually associated, by fractional distillation. They include oil of turpentine ( $C_{10}H_{16}$ ), and the oils of bergamot, birch, chamomile, caraway, cloves, lemi, hop, juniper, lemons, orange, parsley, savine, and valerian, most or all of which contain the same hydrocarbon as Oil of Turpentine (q. v.), and in addition to it an oxidised compound; oil of copaiva ( $C_{20}H_{34}$ ), attar of roses ( $C_{15}H_{26}$ ), &c.

2. The *Oxygenous Essential Oils* may be either fluid or solid, the latter being also termed *Camphora*. A stearopten separates from most of the fluid oils on cooling. They are more soluble in water and spirit of wine than the pure hydrocarbons. They may be divided into (1.) those which are fluid at ordinary temperatures, such as those of aniseed, chamomile,\* cajeput, caraway,\* cinnamon, cloves,\* fennel, lavender, peppermint, rue, spiræa, thyme,\* winter-green, &c. Those marked with a (\*) are associated with the pure hydrocarbons already

described. (2.) The camphora, such as ordinary camphor ( $C_{10}H_{16}O_2$ ), Borneo camphor ( $C_{15}H_{22}O_2$ ), &c.

3. The *Sulphurous Essential Oils* are chiefly obtained from the *Cruciferae*. They probably all contain the radical *allyl* ( $C_3H_5$ ). The oils of garlic and of mustard (both of which have been described in special articles), and those of horse-radish, scurvy-grass, and asafetida, are the best illustrative of this division.

4. Amongst the essential oils obtained by fermentation, dry distillation, &c., may be mentioned the oils of bitter almonds and of black mustard, the oils of milfoil, plantain, centaury, &c. (whose leaves have no smell until they have been moistened for some time with water, when a kind of fermentation is set up, and oil is yielded in abundance), Furfuramide (q. v.), &c.

The British pharmacopœia contains the essential oils of anise, cajeput, caraway, chamomile, cinnamon, cloves, copaiva, coriander, cubebs, dill, juniper, lavender, lemon, nutmeg, peppermint, pimento, rosemary, rue, savine, spearmint, and turpentine. Of these, the oils of anise, cajeput, caraway, chamomile, coriander, dill, peppermint, pimento, and spearmint are used as stimulants and antispasmodics in cases of flatulence, griping, &c.; and to disguise the nauseous taste of various medicines. The oils of cajeput, cinnamon, and rue act similarly but more powerfully. The oils of copaiva and cubebs act in the same manner as the substances from which they are derived; oil of juniper is a powerful diuretic, and oil of savine (and to a less extent oil of rue) an emmenagogue. The oils of lavender and lemon are used to conceal the smell of sulphur ointment, and to give an agreeable odour to lotions, &c. The oil of rosemary is chiefly employed as a stimulating liniment, especially in cases of baldness; and the oil of nutmeg is seldom given medicinally except in the form of aromatic spirit of ammonia, into the composition of which it enters.

The length to which this article has been unavoidably extended, has precluded us from making any use of the admirable paper on the essential oils, which was recently (December 1863) read by Dr Gladstone to the Chemical Society.

Bland oils—such, for example, as olive oil—were much used by the ancients as external applications in various forms of disease. Celsus repeatedly speaks of the use of oil applied externally with friction in fevers, and in various other diseases. Pliny says that olive oil warms the body and at the same time cools the head, and that it was used with these objects previously to taking cold baths. Aretæus recommends a sitz-bath of oil in cases of renal calculi, and Josephus relates that a similar mode of treatment was employed in the case of Herod. Galen prescribed 'oil and wine' for wounds in the head; and the parable of the good Samaritan affords additional evidence that this was a common mode of treating wounds. The use of oil preparatory to athletic exercises is referred to by numerous Greek and Latin writers.

As a cosmetic—that is to say, as a means of giving to the skin and hair a smooth and graceful appearance—its use has been prevalent in hot climates from the earliest times. There is abundant historical evidence of this usage of oil amongst the Egyptians, the Jews, the Greeks, and the Romans; and Pliny's statement that butter is used by the negroes, and the lower class of Arabs, for the purpose of anointing, is confirmed by the observation of all recent African travellers. In hot climates, there is doubtless a practical as well as an æsthetic object in anointing. The oil, being a bad conductor of heat,

OILS.

affords a certain amount of protection against the direct action of the solar heat; it is likewise serviceable as a protection against the attacks of insects, and as a means of checking excessive perspiration. The fact of oily and fatty matters being bad conductors of heat, serves also to explain why the Esquimaux and other dwellers in Arctic regions have recourse to the inunction of the blubber, &c. In their case the oily investment serves to prevent the escape of the bodily heat.

The Greeks and Romans not only employed oil for the purposes already mentioned, but in their funeral rites; the bodies of their dead being anointed with oil, with the view probably of postponing incipient decomposition. A similar practice existed amongst the Jews, and in the Gospels we find various passages in which our Lord referred to his own body being anointed by anticipation. It appears from the evidence of S. Chrysostom, and other writers, that this ancient usage of anointing the bodies of the dead was long retained in the Christian Church. See UNCTION; EXTREME UNCTION.

In conclusion, we may remark that the ancient system of anointing, as a means of medical treatment, has to a certain extent been revived in modern times. Many physicians of the present day combine the inunction of cod-liver oil with its internal administration, a combination first recommended by Professor Simpson of Edinburgh; and Sir Henry Holland advocates the practice of anointing the harsh, dry skin of dyspeptic patients with warm oils. There can, we think, be little doubt that there are many forms of disease in which the local application of medicinal oils would prove advantageous; but the great drawback to their use is, that the time required for properly rubbing them into the skin is more than most patients are willing to concede. For much curious information on the subject of this article, the reader is referred to a very interesting paper by Mr Hunter, 'On the External Application of Oils,' in the second volume of *The Edinburgh Medical and Surgical Journal*.

**OILS IN THEIR COMMERCIAL RELATIONS.**—The solid animal oils found in commerce are butter and lard, tallow, mares' grease, goose grease, neats-foot oil, and unrefined yolk of egg oils. The two first are fully described under their names. See BUTTER, LARD. Tallow is the fat of oxen and sheep, but more especially the fat which envelops the kidneys and other parts of the viscera, rendered down or melted. The qualities of this solid oil render it particularly well adapted for making candles, and until the end of the first quarter of the present century, candles for ordinary use were almost wholly made of it, the high price of wax and spermaceti preventing their employment except by the most wealthy and for ecclesiastical purposes. Besides its use in making candles, tallow is most extensively used in the manufacture of soap, and for the purpose of preserving machinery from rust. The trade in tallow with Russia, which produces the largest quantity and the best, and with North and South America, and even with India and other countries, is very considerable; but it is declining, owing of course to the extension of gas and the enormous development of the paraffine and petroleum oils, and other light-giving materials. The quantities imported of late years into Britain were as follows:

	Tons.
1830—1860, . . . . .	94,625
1870—1881, . . . . .	117,988
1861—1873, . . . . .	100,122
1863—1863, . . . . .	78,579
1863—1864 (to 13th February), . . . . .	79,967

The chief use of tallow in this country is now in the manufacture of Soap (q. v.), and even in this it

has yielded in importance to palm and cocoa-nut oils.

Mares' Grease is not nearly so solid as tallow, it is a yellowish-brown grease, imported extensively from Monte Video and Buenos Ayres, where vast numbers of horses are slaughtered for their hides, bones, and grease; it is particularly valuable as a lubricant for machinery, and is chiefly employed for that purpose after much of its stearine has been removed for candle-making. The reason this material is called *mares' grease*, is said to be from the circumstance, that in South America horses are chiefly used, and mares are slaughtered as comparatively useless. Goose Grease is another soft fat, much valued by housewives for many purposes, but excepting that it is sold in some districts as a remedial agent, it has no commercial importance. Neats-foot Oil is a soft fat procured in the preparation of the feet and intestines of oxen for food as sold in the tripe-shops. The quantity obtained is not very great, but it is in much request by curriers for dressing leather. Yolk of Egg Oil is a hard oil, which, though little known in Britain, is extensively used in other countries where eggs are cheaper. In Russia, for instance, it is manufactured on so large a scale as to supply some of the largest makers of fancy soaps, and it forms the principal material in the celebrated Kazan Soap; and certain pomades are made of it which have a great reputation, and realize very high prices. This oil is not unlike palm oil in colour and consistency; but when refined is liquid, and has a reddish-yellow colour. Its price at Moscow is as high as 8s. per lb.

The liquid animal oils are more numerous, and, excepting tallow, are far more important, the so-called fish-oils being the principal. These are whale, porpoise, seal, cod, herring, shark, &c. The whales which are pursued for their oil are: (1.) The Sperm Whale. This huge creature is from 60 to 70 feet in length, and yields generally from 5000 to 6000 gallons of oil. The finest oil is taken from the great reservoir on the head. The oil of this species is all of a quality superior to others, and is known as sperm oil. For the method of procuring this oil, see CACHOLOL. (2.) The Right Whale, which yields by far the largest proportion of whale oil. This, with that yielded by other less important species, is usually called train oil. The term *train* is supposed to be a corruption of *drain*, and applies to the circumstance of the oil being drained out of the blubber; and in this sense it is also applied to sperm oil from the blubber of the cacholot, in contradistinction to the finer oil from the head matter. The Right Whale forms the chief object of the northern fisheries, but other species of *Balaena* are pursued in different parts of the world for the sake of their oil. See WHALE.

Amongst the smaller Cetaceans, the porpoises, called also dolphins and grampuses, yield an excellent oil, second only in value to that of regular oil whales; and to obtain it, large numbers are occasionally killed in the British seas. The price of sperm oil ranges from £75 to £90 per tun, and that of ordinary train oil from £40 to £45 per tun of 252 gallons. The imports and consumption of the various kinds of whale oil for the last seven years are as follows:

	Imported.		Consumption.	
	Tons.	Tons.	Tons.	Tons.
1856 to Jan. 1, 1857, . . . . .	5298	4994		
1858, . . . . .	4251	5111		
1859, . . . . .	6556	5806		
1860, . . . . .	4350	5703		
1861, . . . . .	4751	4591		
1862, . . . . .	4548	3182		
1863, . . . . .	3648	3646		

A large quantity of very valuable oil is obtained

from Seals, and the seal-fishery, as a means of obtaining oil, is only second in importance to that of the whale. It is carried on chiefly on the shores of Newfoundland, Greenland, and Labrador. Like the whales, the seals have a thick layer of blubber, in which the oil is contained. See SEAL. The first draining from the blubber is of a fine clear pale-straw colour; the next, yellow or tinged; and the last is brown or dark. The price ranges in our markets at about £48 to £50 per tun for pale, £42 to £45 for yellow, and £40 to £42 for brown. The whale and the seal oils are nearly all used for burning in lamps, and for this purpose they are admirably adapted by their great illuminating power. They are also the best lubricants for machinery.

Of the true fish oils, that from the cod is first in importance, more especially since its medicinal properties were discovered. It is made only from the liver of the fish; and the attempt which was made to induce a popular belief that the so-called cod-liver oil was different from the ordinary cod oil of commerce, was simply a cheat; no difference exists, and the oil is obtained just as good from the oil merchant, at a moderate price per gallon, as from the empiric at an exorbitant price per pint. Indeed, the purer the oil can be got, the better it is in a remedial point of view, notwithstanding the efforts made to convince the public that a certain colour is better than any other.

Instead of the old and somewhat rude methods of preparing the oil (see COD-LIVER OIL), much more complete and efficient arrangements are now adopted. The livers, when taken from the fish, are all examined, washed in clean water, and placed in sieves to dry. Thence they are transferred to pans heated with steam, and after being exposed to a gentle heat for about three-quarters of an hour, the heat is discontinued; and when cold, the oil which has separated is skimmed off, and strained through flannel bags into tubs. Here certain impurities subside, and the clear oil is poured off from the dregs, and the contents of numerous tubs are transferred to galvanised iron cisterns, in which a further settlement takes place. The oil is now ready for the filters, which are made of the strong cloth called moleskin, through which it is forced by atmospheric pressure into the store-tanks, which are also of galvanised iron. Hence it is pumped into the casks for export, which are usually hogheads, tierces, and barrels. The value of cod-liver oil is about £50 to £53 per tun. The imports vary much according to the success of the fishery; they have reached nearly 1000 tons per annum. Besides its consumption in lamps, and for medicinal purposes, cod oil is used in making some kinds of soap. Oil is occasionally made from the herring, but not in very great quantities; it, however, forms a commercial article. It is made from the whole of the fish, the smell of which it retains to a very disagreeable extent.

The lightest of all the fixed oils is made from the liver of the common shark; it ranges from specific gravity 0.865 to 0.867. This, and the oil made from the livers of the Common Skate (*Raja batia*), the Thornback (*R. clavata*), and the White Skate (*Rhinobatus cerniculus*), are often substituted for the cod-liver oil used medicinally, but have not its valuable properties.

Under the name of lard oil, large quantities of the oleine of lard have been imported of late years from America. It is a secondary product, arising from the great manufacture of lard stearine for candle-making which has arisen in that country. Lard oil is worth about £45 to £50 per tun, and is principally used as a lubricant for machinery.

The solid vegetable fixed oils which find a place

in commerce are palm oil, cocoa-nut oil, kokum or vegetable tallow, and carapa or carap oil. The palm oil is an oil of a bright orange-yellow colour and an agreeable violet odour, which is obtained from the not very thick covering of the hard seeds of the Oil-palm (q. v.). The fruits, when gathered, are shaken out of the clusters, and are laid in heaps in the sun for a short time, after which the natives boil them slowly in water, when the oil separates and is skimmed off the surface, and carried in small quantities to the depôts of the traders, who transfer it to casks which are prepared to receive it on board the ships. The quantity thus collected is enormous. The imports into Britain alone for the last five years have been as follows, in tons weight: 1859, 28,300; 1860, 34,000; 1861, 33,100; 1862, 38,828; 1863, 34,428. Previous to 1840, the chief use of palm oil was in making soap, but it was about that time found that the palmitine or fat acid of this oil was admirably adapted for the manufacture of Candles (q. v.); and since then it has become of much greater importance.

Cocoa-nut Oil is a white fat, with the peculiar smell of the kernel; it is made by grinding or pounding the kernel of the cocoa nut. After it has been boiled in water for a short time, the paste is submitted to great pressure, and a large quantity of milky juice is obtained; this is slowly boiled, and the oil separates and rises to the surface in considerable quantity, and is skimmed off. Twenty ordinary-sized nuts will yield as much as two quarts of oil. This oil is now very largely imported, and, treated in the same way as palm oil, forms a stearine, which greatly improves that of palm oil when mixed with it in proper proportions; neither does so well separately, and the consumption of cocoa-nut oil has consequently very greatly increased. Most of it comes from Ceylon, where the tree is largely cultivated on purpose. The imports in 1859 were 9600 tons; in 1861, 13,800 tons; and in 1863, 14,534 tons. By far the greater proportion of this vast quantity is used by the candle manufacturers, and the remainder in making common soap, its disagreeable smell preventing its being employed for the better kinds.

Vegetable Tallow, or Kokum Oil, is also used by the candle-makers; only small quantities, however, are imported. It comes from Singapore, and is produced from the seed of *Garcinia purpurea*, a species of the same genus with the mangosteen. Another kind of vegetable tallow is made in China, from the seeds of *Sillinia sebifera*.

Carapa, Carap, Crab, or Andiroba Oil, is very extensively made in British Guiana and the West India, but it is nearly all used there, either as a pomade for preserving the hair, or as an unguent for rheumatism and neuralgic pains, for which purposes it is said to be very useful. See CARAPA.

The Bassia Oil is beginning to attract attention, and several importations have taken place from India, and some rather large quantities have reached Liverpool from Bombay, under the name of Muohwa Oil. This oil is of a soft butter-like consistence, and yellowish-green colour, and is well adapted for soap-making and for machinery grease. See BASSIA.

The liquid vegetable oils are very numerous, and several are of great commercial importance. First in rank is Olive Oil, made from the ripe fruit of the Common Olive (*Olea Europea*). When good and fresh, it is of a pale greenish-yellow colour, with scarcely any smell or taste, except a sweetish nutty flavour, much esteemed by those who use it. The finest qualities are the Provence Oil (rarely seen in Britain), Florence Oil, and Lucca Oil. These are all used for salads and for cooking. The Genoa oil is used on the continent for the same purposes.

and Galipoli, which is inferior, constitutes the great bulk of what is received in this country for cloth dressing, Turkey-red dyeing, and other purposes; the continental soap-makers also employ it extensively. The high price of the best qualities leads to much adulteration with poppy and other oils, but it is generally pretty safe when in the original flasks as imported. The mode of obtaining the finest kinds is by gentle pressure of the fruit. The cake is afterwards treated with hot water, from the surface of which an inferior quality is skimmed. The Galipoli oil is obtained by allowing the olives to ferment in heaps, and then to press them in powerful oil-presses; the cake or *marc* is then treated with water once or twice, until all the oil is removed; this inferior oil is darker in colour, being a yellowish or brownish green. We receive the finest from Italy, and the commoner qualities from the Levant, Mogador, Spain, Portugal, and Sicily. The present values range from £52 to £58 for common kinds, and the finest Lucca is £1 the half chest, or nearly £85 per tun measure. The total quantity imported during the last four years is as follows: 1860, 21,800 tons; 1861, 16,500 tons; 1862, 19,062 tons; and in 1863, 19,299 tons.

Nearly all the other liquid vegetable oils of this class are obtained from seeds, and as they are most of them treated in the same way, one description will suffice. First, the seeds are ground—and this in Britain is always done by vertical stones (see MILL, fig. 4)—into a kind of coarse meal, which is first warmed in pans, and then put in certain portions in woollen cloths or bags, so arranged as to be of uniform thickness; these are again wrapped in horse-hair cloths, and each parcel is placed

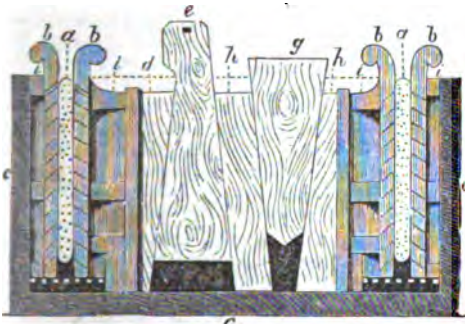

Fig. 1.

between two flat boards slightly fluted on their inner sides, and then placed in the wedge-press (fig. 1). In this *a, a* are two flannel bags filled with the meal and enclosed in horse-hair bags, each flattened between the flat boards, *b, b, b, b*. They are set upright, between the pressing-plates, *i, i, i, i*, one at each end of the press-frame, *cc*, which is made of great strength, and often of cast iron; its section is seen in fig. 2. Next is placed the wedge *d*; the other wedge, *e*, is then suspended by a cord in the position represented; *h, h* are then placed, as seen in the drawing; the main wedge, *g*, is lastly inserted, and the press is ready for action. The operation is very simple;

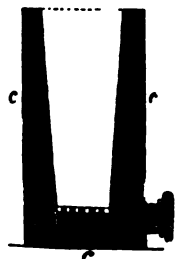

Fig. 2.

wedge, *g*, is lastly inserted, and the press is ready for action. The operation is very simple;

a heavy wooden stamper, from 500 to 600 pounds weight, is raised by machinery about two feet, and allowed to fall upon the wedge *g*. This tightens all the other wedges and pressing-plates, and exerts a pressure of about 60 tons on each bag when fully driven home. The pressing-plates, *i, i, i, i*, are pierced with holes, and so are the plates *b, b, b, b*; and through these holes the oil trickles and passes away by the pipe, *k*, shewn in fig. 2.

One of the chief seed oils is that of linseed (*q. v.*). Very little linseed oil is imported into Britain; the improved machinery, and the great demand for the oil-cake (see OIL-CAKE), cause it to be manufactured at home, and at present it is exported in considerable quantities; thus, from Hull alone there was exported in 1861, 16,180 tons weight; 1862, 14,200 tons; 1863, 9793 tons. The total production of Great Britain for the last six years has been as follows: 1858, 42,000 tons; 1859, 55,500 tons; 1860, 65,000 tons; 1861, 50,000 tons; 1862, 46,000 tons; and 1863, 42,000 tons weight; the remarkable decrease is attributed to over-speculation. It is worth about £36 per ton. Rape or Colza Oil is a name which covers the product of several cruciferous seeds, as rape, turnip, and other species of *Brassica*, radish, *Sinapis toria*, Gold of Pleasure, &c. The oil is clear brown and usually sweet, but with a mustard-like flavour; its illuminating powers are excellent, and it is also well adapted for wool-dressing. Very large quantities are made in Great Britain, chiefly from *Sinapis toria* and other Indian mustard seeds, which are imported under the name of Surzee Seed. The imports of these seeds are occasionally as much as 60,000 quarters per annum. Hemp Seed yields a green oil which is much used in making soft soap, especially in Holland. In Russia it is much eaten with various kinds of food, and is greatly liked by all classes.

The following are the names of a number of oils which are more or less used in this country: Cotton-seed Oil. Palm-nut Oil, a clear limpid oil from the hard nut of the oil-palm; this nut was formerly rejected as useless after the oil had been obtained from the fruit. Safflower-seed Oil, from the seeds of *Carthamus tinctorius*; it constitutes the real Macassar Oil. Sunflower-seed Oil, from seed imported from the Black Sea provinces of Russia; a rapidly increasing trade is springing up in this excellent oil. Poppy-seed Oil, from the seed of *Papaver somniferum*, largely imported from India; it is as sweet as olive oil, and is extensively substituted for it, especially in France, where it is also very largely cultivated. Gingelli-seed Oil, from the seed of *Sesamum orientale*, an important Indian staple of which we are large consumers; the oil is much used for wool dressing, &c. Ground-nut Oil, from the seeds of *Arachis hypogaea*, imported from Western Africa and India; this oil is particularly adapted for fine machinery, as it is not affected by cold. Niger, Til, or Teel-seed Oil, from the seeds of *Guizotia oleifera*, much imported from Bombay. Croton Oil, from the seeds of *Jatropha curcas*, largely used in wool dressing. The Croton Oil used in medicine is from *Croton tiglium*, of which only small quantities are imported; whereas of the other 1200 or 1400 tuns, besides a quantity of the seed, often reach us in one year. Another highly valuable medicinal oil, Castor Oil (*q. v.*), is of great commercial importance. Almond Oil, chiefly used for perfumery purposes, is made from the kernels of the sweet and bitter almond; it is the most free from flavour and odour of any oil in use, notwithstanding that the essential oil of bitter almonds is so strongly flavoured.

Oils made from the seeds of the following plants

have some commercial value in other countries: *Morlia sativa*; *Argemone Mexicana*; various species of Gourds; Garden Cress (*Lepidium sativum*); tobacco, now extensively used in Southern Russia, Turkey, and Austria; maize, rarely made in Vienna; hazelnuts; walnuts; nuts of stone pine; pistachio nut; tea-seed, this in China is a common painter's oil; and the grape, from the seeds or stones, as they are called, saved from the wine-presses, used in Italy; Brazil-nuts (*Bertholetia excelsa*); *Calophyllum inophyllum*, called Pinnacottay Oil in India; *Melia azadirachta*, called in India by the names Neem and Margosa Oil; *Alewives triloba*, called in India, Country Almond Oil, and much used for burning in lamps and torches; *Psoralea corylifolia*, called Baw-chee-seed Oil. The seed is sometimes imported to this country for pressing. Ben-seeds (*Moringa Pterygosperma*); Bonduc-nuts, the seeds of *Guilandina bonduc* and *G. bonducella*.

The following oils, new to European commerce, were shown in the International Exhibition of 1862. India.—Teorah Oil, from the seeds of *Brassica erucastrum*; Capala Oil, from the seeds of *Rottlera tinctoria*; Cardamom Oil, from the seeds of *Elettaria Cardamomum*; Hidgelee Badham Oil, from the seeds of *Anacardium occidentale*, or Cashew-nut, now largely cultivated in India; Cassia-seed Oil; Chaulmoogra Oil, from the seeds of *Hydnocarpus odorata*; Cheerongee Oil, from the seeds of *Buchanania latifolia*; Chemmarum Oil, from the seeds of *Amoora rohituka*; Circassian-bean Oil, from the seeds of *Adeanthera pavonina*; Hoorhoorya Oil, from the seeds of *Potania icosandra*; Custard Apple-seed Oil, from the seeds of *Anona squamosa*; Exile Oil, from the seeds of *Cerbera Thevetia*; Monela-grain Oil, from the seeds of *Dolichos uniflorus*; Kanari Oil, from the seeds of *Canarium commune*; Khaliziri Oil, from the seeds of *Vernonia Anthelmintica*; Malkungunnee Oil, from the seeds of *Celastrus paniculatus*; Bakul Oil, from the seeds of *Mimusops elengi*; Rana Oil, from the seeds of *Mimusops Kaki*; Moodooga or Pulas Oil, from the seeds of *Butea fr. vilosa*; Nahor or Nageshur Oil, from the seeds of *Mesua ferox*; Hone-seed Oil, from seeds of *Calophyllum calaba*; Poonga, Caron, or Kurrmig Oil, from the seeds of *Pongamia glabra*; Vappanley Oil, from seeds of *Wrightia antidysenterica*; Babool Oil, from seeds of *Acacia Arabica*; Gamboge Oil, from seeds of the Gamboge-tree (*Garcinia pictoria*); Coodiri Oil, from the seeds of *Sterculia fetida*; Kikuel Oil, from the seed of *Salvadorea persica*; Marotty, Surrate, or Neeradimootoo Oil, from the seeds of *Hydnocarpus nebricans*; and Pundi-kai Oil, from the nutmegs of *Myristica malabarica*.

From Brazil.—Oils from the seeds of *Feuillea cardifolia*, *F. monosperma*, *Anisoperma passiflora*, *Cucurbita citrullus*, *Mabea fistuligera*, *Anda gomesii*, *Myristica bicuhiba*, *Carpotroche Brasiliensis*, *Dipteris odorata*, *Theobroma cacao*, *Acrocomia sclerocarpa*, *Nectandra cymbarum*, and from the fat of the Alligator and the Tapir, all for medicinal and perfumery purposes; and oils from the seeds of *Enocarpus Bacaba*, *C. pataud*, *Caryoca Brasiliensis*, and *Euterpe edulis*, used for culinary and lighting purposes.

From British Guiana.—Oil drawn from the stem of *Oreodaphne opifera*; it resembles refined turpentine, and is suggested as a solvent for india-rubber. Wallaba Oil, from the wood of the Wallaba-tree (*Eperera falcata*), medicinal.

The preparation of the essential oils is treated of in PERFUMERY.

The importance of the manufacture of oils is very great; in 1862 the value of the imports of the leading staples of this trade—viz., fish, palm, cocoa, and olive oils—was no less than £4,396,218. The

aggregate of the other kinds was a little over half a million. In addition, oil seeds to the value of £3,806,510 were imported for crushing in Great Britain; whilst the exports of oil amounted in value to £1,025,308. Thus, it will be seen that this industry represents a capital of nearly £10,000,000 sterling.

OIRIR-GAEL, a name which, in the early times of Scottish history, was applied to the Gaels of the coasts, in contradistinction from the Gall-Gael or Islesmen. There was long a struggle for superiority between these two races, represented respectively by Somerled of the Isles and the later kings of Man, in which the latter were eventually successful, uniting under one head the dominion of Argyle and the Isles.

OISE, a river of France, one of the chief affluents of the Seine, rises in the vicinity of Rocroy, in the north of the department of Ardennes, and flows south-west, joining the Seine at Conflans-Sainte-Honorine, after a course of 150 miles, for the last 75 of which it is navigable. The fall of the river is very gradual, and its course is extremely sinuous. It is connected by canals with the Somme, the Sambre, and the Scheldt, and forms one of the chief commercial routes between Belgium and Paris. It becomes navigable at Chauny.

OISE, a department in the north of France, is bounded on the E. by the department of Aisne, and on the W. chiefly by that of Seine-Inférieure, which intervenes between it and the English Channel. Area, 1,446,869 English acres, of which 950,000 acres are in arable land; pop. (1862) 401,417. The principal rivers are the Oise—from which the department derives its name—and its tributaries the Aisne and Therain. The department is almost wholly included in the basin of the Oise; and as the course of that river indicates, the surface—consisting for the most part of extensive plains—has a general slope toward the south-west. The soil is in general fertile, and agriculture is well advanced. The products are the usual grain-crops, with an immense quantity of vegetables, which are sent to the markets of the metropolis. The department is divided into the four arrondissements of Beauvais, Clermont, Compiègne, Senlis; capital, Beauvais.

OITI (*Moquilea tomentosa*), a tree of the natural order *Chrysobalanaceae*—by many botanists regarded as a suborder of *Rosaceae* (q. v.)—a native of the north of Brazil, and valuable on account of its timber, which is very good for ship-building.

O'KA, an important commercial river of Central Russia, the principal affluent of the Volga from the south, rises in the government of Orel, and flows in a generally north-east direction, forming a common boundary between the governments of Tula, Kaluga, and Moscow; and afterwards flowing through the governments of Riazan, Vladimir, and Nijni-Novgorod. It joins the Volga at the city of Nijni-Novgorod, after a course of 837 miles. Its basin, estimated at 127,000 square miles in extent, comprises the richest and most fertile region of Russia. The principal towns on its banks are Orel, Bellef or Bielef, Kaluga, Riazan, and Muroc; the most important affluents are the rivers Moscow, Kliasma, and Tzna. During spring, the Oka is navigable from Orel to the Volga; but in summer the navigation is obstructed by sandbanks. It communicates with the ports on the Baltic, Caspian, and White Seas; and the cargoes annually shipped down the river amount in value to several million pounds sterling.

O-KEE-CHO-BEE, a lake bordering on the Everglades of Southern Florida (see FLORIDA), about 120 miles in circuit, receiving several small rivers,

and having for its outlet the river Caloo-sa-hatchee, which flows westerly into the Gulf of Mexico.

OKEN (originally OCKENFUSS), LORENZ, a celebrated German naturalist, was born at Bohlsbach, in Württemberg, August 1, 1779. He studied at Würzburg and Göttingen; became extra-ordinary professor of medicine at Jena in 1807, where his lectures on natural philosophy, natural history, zoology, comparative anatomy, vegetable and animal physiology, attracted much notice. In 1812, he was appointed ordinary professor of natural science; and in 1816, commenced the publication of a journal partly scientific and partly political, called *Iris*, which continued to appear till 1848. The opinions promulgated in the *Iris* led to government interference, and O. resigned his chair, and became a private tutor, devoting his leisure to the composition of works on natural history. In 1828, he obtained a professorship in the newly-established university of Munich; but in 1832, exchanged it for another at Zürich, where he died, 11th August 1851. O. aimed at constructing all knowledge *à priori*, and thus setting forth the system of nature in its universal relations. The two principal works in which this idea is developed are his *Lehrbuch der Naturphilosophie* (Jena, 1803—1811), and his *Lehrbuch der Naturgeschichte* (3 vols. Leip. 1813—1827). The former has been translated into English, and published by the Ray Society under the title of *Elements of Physio-philosophy*. As O.'s philosophic system of nature was very peculiar, and quite unlike anything that had preceded it, O. invented a nomenclature of his own, which, however, in many cases is forced and pretentious, composed for the most part of new-coined words, and difficult to remember. It therefore found little favour, and O. was long regarded—particularly by French and English savans—as a mere dreamer and transcendental theorist; nor can it be denied that he is largely such, infected with the worst vices of the school of Schelling, to which he belonged; but some of his 'intuitions'—if we may so term his scientific suggestions—were remarkably felicitous, and in the hands of rigorous demonstrators, have led to great results. In his work *Die Zeugung* (On Generation, Bamb. 1805), he first suggested that all animals are built of vesicles or cells; in his *Beiträge zur vergleichenden Zoologie, Anatomie und Physiologie* (1806), he pointed out the origin of the intestines in the umbilical vesicle; and in the same year lighted accidentally upon the idea, since so prolific of results, that the bones of the skull are modified vertebrae. On account of this discovery, he has been termed 'the father of morphological science.' That O., and not Göthe, was the original discoverer of the vertebral relations of the skull, has been conclusively shewn by Owen, in a valuable notice of O. in the *Encyclopædia Britannica*.

OKHO'TSK, SEA OF, an extensive inlet of the North Pacific Ocean, on the east coast of Russian Siberia. It is bounded on the N. by the wastes of Siberia, on the E. by the peninsula of Kamtchatka, and is partially enclosed by the Kurile Islands on the S., and by the island of Saghalien on the W. It is 1000 miles in length, and 500 miles in breadth. The river Ud, which enters it on the north, is 400 miles in length. Owing to climate and position, the Sea of O. is unlikely ever to become the scene of much commerce. On its northern shore, at the mouth of the Okhota—from which it derives its name—is the small seaport of Okhotsk, lat. 57° 21' N., long. 143° 17' E. This town has only 236 inhabitants, and has been entirely superseded by the ports of Ayan and Nikolayevsk.

OLAF, the Saint, one of the most revered of the early Norwegian kings, was born in 995; and after

having distinguished himself by his gallant exploits, and made his name a terror in several warlike expeditions on the coasts of Normandy and England, succeeded, in 1015, in wresting the throne of Norway from Eric and Svend Jarl. The cruel severity with which he endeavoured to exterminate paganism by fire and sword, alienated the affection of his subjects, many of whom sought security from his persecution in the territories of Knut or Canute the Great, king of Denmark; and it was only through the powerful aid of his brother-in-law, the Swedish Anund Jacob, that his authority could be upheld. O.'s hot-headed zeal, however, after a time exhausted the patience of the people, who hastened to tender their allegiance to Knut, on his landing in Norway in 1028, when O. fled to the court of his brother-in-law, Jaroslav of Russia, who gave him a band of 4000 men, at the head of whom he returned, in 1030, and gave Knut battle at Stiklestad, where O. was defeated by the aid of his own subjects, and slain. The body of the king, which had been left on the field of battle, and buried on the spot by a peasant, having begun to work miracles, his remains were carefully removed to the cathedral of Trondhjem, where the fame of their miraculous power spread far and wide, attracting pilgrims from all parts of the Scandinavian peninsula. O. was solemnly proclaimed patron saint of Norway, in the succeeding century; and from that period till the Reformation, he continued to gather round him a rich heritage of mythical legends and popular sagas, the memory of which still lingers in the folk-lore of Norway. In 1847, the order of Olaf was created, in honour of the Saint, by King Oscar I. of Sweden and Norway.

OLBERS, HEINRICH WILHELM MATHIAS, a celebrated German physician and astronomer, was born at Arbergen, a small village of Bremen, October 11, 1758. He studied medicine at Göttingen from 1777 till 1780, and subsequently commenced to practise at Bremen, where, both as a physician and as a man, he was highly esteemed by his fellow-citizens. In 1811, he was a successful competitor for the prize proposed by Napoleon for the best 'Memoir on the Group.' O. has written little on medical subjects, for, from 1779, all the leisure time which he could abstract from professional occupations was devoted to the enthusiastic study of astronomy. The first thing which brought him into notice, was his calculation of the orbit of the comet of 1779, which was performed by him while watching by the bedside of a sick patient, and was found to be very accurate. Comets were the chief objects of his investigation, and he seems to have been seized with an irresistible predilection for these vagabonds of the solar system, which his two important discoveries of the planets Pallas (1802) and Vesta (1807) could not diminish. In 1781, he had the honour of first re-discovering the planet Uranus, which had previously been supposed, even by Herschel himself, to be a comet, and which had been sought for in vain. He also discovered five comets, in 1798, 1802, 1804, 1813, and 1821, all of which, with the exception of that of 1815 (hence called *Olbers' comet*), had been some days previously observed at Paris. His observations, calculations, and notices of various comets, which are of inestimable value to astronomers, were published in the *Annales de Bode* (1782—1829), in the *Annales de Encke* (1833), and in three collections by the Baron de Zach. Most of these calculations were made after a new method, discovered by himself, for determining the orbit of a comet from three observations; a method which, for facility and accuracy, he considered as greatly preferable to those then in use. A detail of it appeared in a journal published at Weimar (1797), and a new edition by Encke in 1847. O. was one of that small band of astronomers



## OLD POINT COMFORT—OLD RED SANDSTONE.

wh- ch included also Schröter, Gausa, Piazz, Bode, Harding, &c., who in the first ten years of the 19th c. devoted their energies to the observation of those planets which were coming to light between Mars and Jupiter. As above stated, two of them, the second and fourth in order of discovery, were detected by O. himself; and the general equality of the elements of the four planetoids, led him to propound the well-known theory, that these, and the other planetoids (q. v.) since discovered, are but fragments of some large planet which formerly revolved round the sun at a distance equal to the mean of the distances of the planetoids from the same luminary. It was this theory which led him, after the discovery of Pallas, to seek for more fragments of the supposed planet, a search resulting in the discovery of Vesta. O. also made some important researches on the probable lunar origin of meteoric stones, and invented a method for calculating the velocity of falling stars. O. died at Bremen, 2d March 1840; and in 1860, his fellow-citizens erected a marble statue in honour of him. O., as a writer, possessed great powers of thought, combined with equal clearness and elegance of expression. The dissertations with which he enriched the various branches of astronomy are scattered through various collections, journals, and other periodicals.

**OLD POINT COMFORT**, a village and watering-place in Virginia, U. S., at the entrance of Hampton Roads, and James River, 12 miles from Norfolk, and the site of Fortress Monroe, the largest military work in the United States.

**OLD RED SANDSTONE**, the name given to a large series of Palæozoic rocks, of which red sandstones are the most conspicuous portions, but which contains also white, yellow, or green sandstones, as well as beds of clay and limestone. The group lies below the Carboniferous strata, and was called 'Old' to distinguish it from a newer series of similar beds which occur above the Coal Measures. The discovery that the highly fossiliferous calcareous rocks of Devonshire and the continent occupied the same geological horizon, shewed that the name was very far from being descriptive of all the deposits of the period, and suggested to Murchison and Sedgwick the desirableness of giving them a new designation. They consequently proposed Devonian, which has been extensively adopted; but it is liable to the same objection as that urged against the name it was intended to supplant, inasmuch as it incorrectly limits geographically what the other limits lithologically. Many names used by geologists are similarly at fault; there is therefore no good reason why the old name should be given up, especially as it has been rendered classical by the labours and writings of Hugh Miller, the original monographer of these rocks.

The position of the O. R. S. series is easily determined, though the sequence of the various beds which form it is somewhat obscure. All the rocks are situated between the beds of the Silurian and Carboniferous periods. In Wales, Scotland, and Ireland it has been observed that there is an old series of red sandstones which are more or less conformable with the underlying Silurians, and a newer series unconformable with the older strata, but conformable with the overlying Carboniferous rocks. The great interval represented by this break has been believed to be that during which the Calcareous Devonian rocks were deposited. The recent researches, however, of Mr Salter shew that the one set of beds do not alternate with the other, but that they are really contemporaneous—the coarse shallow water deposits of conglomerate and

sandstone having been formed on the shores of that sea in whose depths the deposits of thicker mass, finer grain, and lighter colour, full of marine shells and corals, were at the same time being aggregated.

The strata of the period have been arranged in four groups. 1. Upper Old Red Sandstone, including the Marwood and Petherwin groups. 2. Middle Old Red Sandstone, including the Dartmouth and Plymouth groups. 3. Lower Old Red Sandstone, including the North Foreland and Torbay groups. 4. Tilestones or Ledbury Shales.

1. The Upper Old Red Sandstones are conformable with the inferior strata of the Coal Measures, and differ so little petrologically, or even palæontologically from them, that they have been considered as the basement series of that period. They consist of yellowish and light-coloured sandstones, which are at Dura Den, in Fifeshire, remarkably rich in some of their layers in the remains of *Holoptychius*, *Pterichthys*, *Dendrodon*, &c. In the south of Ireland, and at Dunse, similar beds contain a fresh-water shell very like the modern *Anodon*, and fragments of a fern called *Cyclopteris Hibernica*. Mr Salter has shewn, from the intercalation of the marine beds with the red sandstone, and from the identity of the fossils, that the Devonian representatives of these beds are the Marwood and Petherwin groups. These consist of dark-coloured calcareous and argillaceous beds, and gray and reddish sandstones. The fossils found in them are shells and land-plants, many of them belonging to the same genera, but different species to those which are found in the Carboniferous system. The little crustacean *Cypridina* and *Clymenia* are so characteristic of this division, that in Germany the strata are known as the *Cypridinian Schiefer* and *Clymenien Kalk*.

2. The Middle Old Red Sandstone is represented in the north of Scotland by the *Caitness flags*, a series of dark-gray bituminous schists, slightly micaceous or calcareous, and remarkably tough and durable. Throughout their whole thickness they are charged with fossil fish and obscure vegetable remains. The characteristic fishes belong to the genera *Coccosteus*, *Asterolepis*, and *Dipterus*. The corresponding beds in Devonshire are the Dartmouth and Plymouth groups, which consist of extensive deposits of limestones and schists, all of them abounding in the remains of corals, trilobites, and shells. In the German equivalent, the *Eifel Limestone*, but especially in the Russian, the characteristic invertebrate fossils of the Devonian calcareous beds have been found associated with the remains of *Coccosteus*, shewing beyond doubt the identity of these various beds. The *Calceola Schiefer* of German geologists belongs to the Middle Old Red; it receives its name from the abundance in it of a singular brachiopod (*Calceola sandalina*).

3. The Lower Old Red Sandstone consists of strata of red shale and sandstone, with beds of impure arenaceous limestone (cornstone), and frequently at the base great deposits of red conglomerate. The fossils peculiar to this division are the remarkable fish *Cephalaspis*, and the huge crustacea of the genus *Pterygotus*, besides a few shells. To the south of the Grampians, the strata consist of a gray paving-stone and coarse roofing-slate. The Devonian representatives of this section are the sandstones and slates of the North Foreland, Linton, and Torbay, and the series of slaty beds and quartz ore sandstones developed on the banks of the Rhine near Coblenz. The *Cephalaspis*, so characteristic of the cornstones, has been found in the Rhenish beds.

4. The Tilestones or Ledbury Shales consist of finely laminated reddish and green micaceous

## OLDBURY—OLDENBURG.

sandstones, which have been noticed underlying the Old Red only on its western borders in Herefordshire. The fossils of those beds shew a Silurian fauna with a number of Old Red forms; the Tilestones are consequently referred sometimes to the one period, and sometimes to the other.

The O. R. S. occupies a considerable portion of the surface of Great Britain. In the north, it forms the boundary lands of the Moray Firth; beginning even as far north as the Shetlands and Orkneys, it covers the whole of Caithness, and in more or less broken tracts the east of Sutherland, Ross, and Cromarty, and the north of Inverness, Nairn, and Elgin. In the great central valley of Scotland it is the setting in which the coal measures are placed, stretching across the country on the one margin from Forfar to Dumbarton, and occurring on the other in separated tracts in Lanark and Berwick. In the southern division of the island it is limited to a large triangular district in the south-west. The apex of the triangle is at Wenlock, in Shropshire; a line thence to Start Point, in Devon, would limit it on the east, and a second to Milford Haven would do so on the west. The Bristol Channel bisects it. A depression in the Welsh portion is occupied with South Wales coal-field; and in a similar depression in Devon, the culm-beds are situated. In Ireland, strata of this age are found in the counties of Kilkenny, Waterford, Cork, and Kerry. The Devonian rocks have been carefully studied in Belgium and the Rhine district, and also in Russia, where they cover a larger district in the north of the empire. The American representatives of this period are extensively developed in New York, Pennsylvania, and Canada. The invertebrate animals found in the Old Red do not differ much from those of the Upper Silurian. Corals are remarkably abundant and beautiful in the Devonian limestones. *Goniatites* and *Clymenia* make their first appearance in this period, with several forms of lower mollusca. *Trilobites* are still numerous. But the most striking feature in the period is the abundance of fish of curious forms, strongly protected outside by hard bony cases, or by a dense armour of ganoid scales.

OLDBURY, an important manufacturing town of England, in the county of Worcester, 29 miles north-north-east of the city of that name, on the river Tama. It contains numerous churches, meeting-houses, and schools. Owing to the extension of the iron-trade, O. has greatly increased in size and prosperity within recent years. There are coal and iron mines in the neighbourhood; and in the town, iron, steel, locomotive engines, mills, edge-tools, draining-pipes, &c., are made and constructed. The Stour Valley Railway passes close by the town, and there is a station here. Pop. (census of 1851, 5114); of 1861, 15,615.

OLDCASTLE, SIR JOHN, once popularly known as the 'good Lord Cobham,' whose claim to distinction is, that he was the first author and the first martyr among the English nobility, was born in the reign of Edward III.; the exact year is not known. He acquired the title of Lord Cobham by marriage, and signalled himself by the arduous of his attachment to the doctrines of Wickliffe. At that time, there was a party among the English nobles and gentry sincerely, and even strongly desirous of ecclesiastical reform—the leader of which was 'old John of Gaunt—time-honoured Lancaster.' O. was active in the same cause, and took part in the presentation of a remonstrance to the English Commons on the subject of the corruptions of the church. At his own expense, he got the works of Wickliffe transcribed, and widely disseminated among the people, and paid a large body

of preachers to propagate the views of the reformer throughout the country. During the reign of Henry IV., he commanded an English army in France, and forced the Duke of Orleans to raise the siege of Paris; but in the reign of Henry V. he was accused of heresy, and having, in a disputation with his sovereign, declared that 'as sure as God's word is true, the pope is the great Antichrist foretold in Holy Writ,' he was thrown into the Tower, whence, after some time, he escaped, and concealed himself in Wales. A bill of attainder was passed against him, and 1000 marks set upon his head. After four years' hiding, he was captured, brought to London, and—being reckoned a traitor as well as a heretic—he was hung up in chains alive upon a gallows, and fire being put under him, was burned to death, December 1417. O. wrote *Twelve Conclusions addressed to the Parliament of England*, several monkish rhymes against 'fleshly livers' among the clergy, religious discourses, &c.—See *Life of Oldcastle*, by Giffin.

O'LDENBURG, a grand-duchy of Northern Germany, consisting of three distinct and widely separated territories, viz., Oldenburg Proper, the principality of Lübeck, and the principality of Birkenfeld. The collective area of these districts is nearly 2399 square miles. Pop., in 1862, 295,242. Oldenburg Proper which comprises  $\frac{2}{3}$ ths of this area, and  $\frac{1}{3}$ ths of the entire population, is bounded on the N. by the German Ocean, on the E., S., and W. by the kingdom of Hanover. The principal rivers of O. are the Weser, the Jahde, and the Haase, Vehnne, and other tributaries of the Ems. The grand-duchy of Oldenburg Proper is divided into eight circles. The country is flat, belonging to the great sandy plain of Northern Germany, and consists for the most part of moors, heaths, marsh or fens, and uncultivated sandy tracts; but here and there, on the banks of the rivers, the uniform level is broken by gentle acclivities, covered with wood, or by picturesque lakes surrounded by fruitful pasture-lands. Agriculture and the rearing of cattle constitute the chief sources of wealth. The horses and cattle raised in the marsh-lands are excellent of their kind, and in great request; the horse-markets at Oldenburg, and the cattle-sales at Ovelgönne, being frequented by purchasers from every part of Germany. The scarcity of wood for fuel, and the absence of coal, are compensated for by the existence of turf-beds of enormous extent. With the exception of some linen and stocking looms, and a few tobacco-works, there are no manufactories. There are, however, numerous distilleries, breweries, and tan-yards in all parts of the duchy.

The trade is principally a coasting-trade, carried on in small vessels, from 20 to 40 tons, which can thread their way along the shallow channels connecting the larger rivers.

The exports are horses, cattle, linens, thread, hides, and rags, which find their way chiefly to Holland and the Hanseatic cities; while the imports include the ordinary colonial goods, and manufactures of numerous kinds.

The receipts for the collective grand-duchy were, for 1863, 2,181,040 thalers, and the expenditure, 2,219,040. The public debt, at the close of 1862, was 4,179,300 thalers.

The principality of Lübeck, consisting of the secularised territories of the former bishopric of the same name, is surrounded by the duchy of Holstein, and is situated on the banks of the rivers Schwartzau and Trave. It contributes 140 square miles to the general area of the grand-duchy, and 21,693 inhabitants to the collective population. It is divided into four administrative districts. It has several large lakes, as those of Plön—noted for

## OLDENBURG.

its picturesque beauty—Keller, Uklei, and Gross-Eutin; while in regard to climate, soil, and natural products, it participates in the general physical characteristics of Holstein. The chief town is Eutin (pop. 4000), pleasantly situated on the lake of the same name, with a fine castle surrounded by a magnificent park.

The principality of Birkenfeld, lying south-west of the Rhine, among the Hunsrück Mountains, and between Rhenish Prussia and Lichtenberg, is an outlying territory, situated in lat. 49° 30'—49° 52' N., and in long. 7°—7° 30' E. Its area is 192 square miles, and its pop. 34,391. The soil of Birkenfeld is not generally productive; but in the lower and more sheltered valleys, it yields wheat, flax, and hemp. Wood is abundant. The mineral products, which are of considerable importance, comprise iron, copper, lead, coal, and building-stone; while in addition to the rearing of cattle, sheep, and swine, the polishing of stones, more especially agates, constitutes the principal source of industry. The principality is divided into three governmental districts.

O. is a constitutional ducal monarchy, hereditary in the male line of the reigning family. The constitution, which is based upon that of 1849, revised in 1852, is common to the three provinces, which are represented in one joint chamber, composed of 47 members, chosen by free voters. Each principality has, however, its special provincial council, the members of which are likewise elected by votes; while each governmental district within the provinces has its local board of councillors, and its several courts of law, police, finance, &c.; although the highest judicial court of appeal, and the ecclesiastical and ministerial offices, are located at Oldenburg.

Perfect liberty of conscience was guaranteed by the constitution of 1849. The Lutheran is the predominant church, upwards of 200,000 of the population belonging to that denomination; while about 70,000 persons profess the Roman Catholic religion.

There are two gymnasia, one higher provincial college, several secondary, and 547 elementary schools; but in consequence of the scarcity of villages in the duchy, and the isolated position of many of the houses of the peasantry, schools are not common in the country districts, and the standard of education of the lower classes is, from these causes, scarcely equal to that existing in other parts of Northern Germany. The military forces of O. number 4007 men; while the federal contingent amounts to 2986 men, who are incorporated in one brigade with the troops of the three Hanseatic cities. O. has a separate vote in the *Plenum* of the federal diet, and a joint vote with Anhalt and Schwarzburg in the limited council.

*History.*—The territory now included in the grand-duchy of O., was in ancient times occupied by the Teutonic race of the Chauci, who were subsequently merged with the more generally known Frisii, or Frisians; and the land, under the names of Ammergau and Lerigau, was for a long period included among the dominions of the Dukes of Saxony. In 1180, the Counts of O. and Delmenhorst succeeded in establishing independent states from the territories of Henry the Lion, which fell into a condition of disorganisation after his downfall.

This family has continued to rule O. to the present day, giving, moreover, new dynasties to the kingdom of Denmark, the empire of Russia, and the kingdom of Sweden. See OLDENBURG, HOUSE OF. On the death, in 1667, of Count Anthony Gunther, the wisest and best of the O. rulers, his dominions, in default of nearer heirs, fell to the

Danish reigning family, and continued for a century to be ruled by viceroys nominated by the kings of Denmark. This union was, however, severed in 1773, when, by a family compact, Christian VII made over his O. territories to the Grand Duke Paul of Russia, who represented the Holstein-Gottorp branch of the family. Paul having renounced the joint countships of Delmenhorst and O. in favour of his cousin, Frederick Augustus, of the younger or Kiel line, of the House of O., who was Prince-bishop of Lübeck, the emperor raised the united O. territories to the rank of a duchy. The present reigning family is descended from Duke Peter Friedrich Ludwig, cousin to the Prince-bishop, Frederick Augustus. For a time, the duke was a member of Napoleon's Rhenish Confederation; but French troops having, in spite of this bond of alliance, taken forcible possession of the duchy in 1811, and incorporated it with the French empire, the ejected prince joined the ranks of the allies. In recognition of this adherence, the Congress of Vienna transferred certain portions of territory, with 5000 Hanoverians and 20,000 inhabitants of the quondam French district of the Saar, to the O. allegiance. From these new acquisitions were organised the district Amme, and the principality of Birkenfeld; while O. was raised to the dignity of a grand-duchy. The revolutionary movement of 1848 was quite as productive of violent and compulsory political changes in this as in other German states; and in 1849, after having existed for centuries without even a show of constitutional or legislative freedom, it entered suddenly into possession of the most extreme of liberal constitutions. The reaction in favour of absolutism, which the licence and want of purpose of the popular party naturally induced all over Germany, led in 1852 to a revision and modification of the constitution, which, however, in its present form contains the essential principles of popular liberty and security. Still, it must be confessed this is more verbal than real; and hitherto, under the assumption that the people have not yet acquired the necessary amount of political intelligence for the judicious use of national independence, the grand-dukes, with the co-operation of the contented bureaucracy who fill the chambers, have relieved the people of the labour and responsibility of sharing largely in the affairs of government.

OLDENBURG, capital of the grand-duchy of the same name, is pleasantly situated on the banks of the navigable river Hunte, 25 miles west-north-west of Bremen. Pop. 9000. O. is the seat of the administrative departments, and the focus of the literary, scientific, and commercial activity of the duchy. It has a normal school, a military academy, a public library of 80,000 vols., a picture-gallery, museum, &c. The grand-ducal palace is worthy of note for its fine gardens, its valuable pictures, and other art collections, and its library. The principal church is St Lambert's, containing the burying-vaults of the reigning family. O. is the seat of an active river-trade, and is noted for its excellent studs, and the great cattle and horse fairs which are annually held here in the months of June and August.

OLDENBURG, THE HOUSE OF, which lays just claim to being one of the oldest reigning families of Europe, has been rendered still more illustrious by various matrimonial alliances, which, in the course of ages, have successively been the means of creating new royal dynasties. Thus, for instance, in 1418, a scion of this House being elected king of Denmark, under the title of Christian I., became the progenitor of the Danish House of Oldenburg, the imperial

House of Russia, the late royal family of Sweden, and the collateral and junior Danish lines of Angustenburg, Kiel, and Sonderburg-Glücksburg. Christian owed his election to the recommendation of his maternal uncle, Duke Adolph of Slesvig, who, when the throne was offered to him on the sudden death of King Christopher, refused, on the ground of age, and proposed Christian of Oldenburg, who, as the direct descendant of Eric Glipping's daughter, Princess Richissa, was allied to the old extinct House of Denmark. The death, in 1459, of Adolph, Duke of Slesvig and Count of Holstein, without male heirs, opened the question of succession to those states, which has since become one of such vexatious import. The ancient law of Denmark recognised hereditary fiefs only in exceptional cases; crown fiefs being generally held for life or merely for a time *ad gratiam*. Such being the case, Slesvig might, on the death of Adolph, have been taken by the crown as a lapsed tenure; but Holstein, being held under the empire, would have been separated from it. Adolph and his subjects were alike anxious that Slesvig and Holstein should continue united; but although the Slesvig estates, at the wish of the Duke Adolph, had recognised Christian as successor to the duchy before his accession to the throne of Denmark, the Holstein Chambers were divided on the question of succession, the majority shewing a preference for the claims of the counts of Schauenburg, who were descended from male agnates of the Holstein House. Christian, in his eagerness to secure both states, was willing to sacrifice his rights in Slesvig to his schemes in regard to Holstein; and having bought over the Holstein nobles by bribes and fair promises, he was elected Duke of Slesvig and Count of Holstein at Ribe in 1460, where he signed a deed, alike derogatory to the interests and unworthy the dignity of his crown. In this compact, by which he bartered away the just prerogatives and independence of himself and his successors, for the sake of nominal present gain, he pledged his word for himself and his heirs, that the two provinces should always remain undivided, '*ewig bliben tosamende ungedeelt*,' and not be dismembered by division or heritage. This document, which remained for ages unknown or forgotten, was discovered by the historian Dahlmann amid the neglected papers of the Holstein state archives at Preetz, and proclaimed in 1848 by that ardent admirer of Germany as the unchangeable fundamental law of the Slesvig-Holstein provinces. The confusion, dissension, and ill-will to which this fatal deed has given rise, are the fruits which Christian's unscrupulous desire to secure power at any cost has produced for his descendants, whose complicated claims on the duchies are at the present moment devastating the Danish kingdom with an exterminating war. From Christian I. descend two distinct branches of the Oldenburg line: 1. The royal dynasty, extinct in the male line in Frederick VII., late king of Denmark, and the collateral branches of Sonderburg-Augustenburg, and Sonderburg-Glücksburg; 2. The ducal Holstein-Gottorp line, descended from Duke Adolph, who died in 1586, and was the second son of King Frederick I. This prince had received, during his father's lifetime, a portion of the Slesvig and Holstein lands, which he was permitted, on the accession of his elder brother, Christian III., to retain for himself and his heirs. This line became illustrious by the marriage of Prince Karl Friedrich, the son of Hedwig-Sofia, eldest sister of Charles XII. of Sweden (a direct descendant of Duke Adolph) with the Grand-duchess Anna, daughter of Peter the Great, and thus gave to Russia the dynasty which still occupies the imperial throne; while Adolph-Friedrich,

a cousin of Prince Karl Friedrich, by his election to the throne of Sweden in 1751, added another crown to those already held by the House of Oldenburg. The conduct of his descendants rendered the new dignity short-lived, for with the abdication of Gustavus IV., in 1809, the Holstein-Gottorp dynasty became extinct in Sweden.

The complicated relations of the House of O. in regard to the Danish succession, after giving rise to much angry discussion among the princes interested in the question, and the Danish people themselves, led the great powers to enter into a treaty, known as the London Treaty of 1852, for settling the question of succession, on the ground that the integrity of the Danish monarchy was intimately connected with the maintenance of the balance of power and the cause of peace in Europe. England, France, Austria, Prussia, Russia, Sweden, and Denmark, were parties to this treaty, in the first article of which it was provided, that on the extinction of the male line of the royal House, Prince Christian of Slesvig-Holstein-Sonderburg-Glücksburg, and his male heirs, according to the order of primogeniture, should succeed to all the dominions, then united under the sway of the king of Denmark. The rights of succession, which rested with the Augustenburg family, were forfeited by a compact which the Duke of Augustenburg entered into for the surrender of his claims, in consideration of a sum of money paid to him by Denmark. The duke'smorganatic marriage, and his subsequent rebellion, in 1848, against the Danish king, were the causes which led to the arrangement of this family compact on the existing terms. This treaty, known as the London Protocol of May 1852, was followed in October of the same year by the publication of a supplementary clause, which stipulated, that on the extinction of the heirs-male of Prince Christian of Slesvig-Holstein-Sonderburg-Glücksburg, the Holstein-Gottorp, or imperial Russian line should succeed to the Danish dominions. This article, even more than the original clauses of the treaty, met with the strongest opposition among the Danes, and after being twice rejected in the Landsting, the London Treaty was only ratified after a new election of members, and on the assurance of the king that in excluding all female cognate lines from the succession, there was no definite intention of advancing the claims of Russia. King Frederick's death, in 1863, has brought the crisis of the much-vexed question of the Danish succession; and although the London Treaty has been so far followed that Prince Christian has succeeded as king of Denmark, the evils that were anticipated from the measure are at this moment (April 1864) being made manifest; for the Duke of Augustenburg, notwithstanding the renunciation by his family of all claims to the succession, has appealed to the federal diet for the recognition of his rights on Holstein; and the German powers, glad of a pretext to extend their influence beyond the Eider, are occupying the Slesvig-Holstein (q. v.) territory, and endeavouring, by force of superior numbers, to advance the boundary of Germany to the borders of Jutland, or perhaps even to its northernmost extremity; and thus make a new division of the old Danish heritage of the House of O., which, if it be effected in accordance with the plans of the diet, will bring about the total dismemberment of Denmark.

OLDHAM, a parliamentary borough and flourishing manufacturing town of England, in the county of Lancashire, stands on the Medlock, six miles north-east of Manchester. It owes its rapid increase in population and in wealth to the extensive coal-mines in the vicinity, and to its cotton

manufactures, which have increased remarkably within late years. It is not only the great centre of the hat-manufacture, but is also celebrated for its manufactures of fustians, velveteens, cords, cotton, woollen, and silk goods. Numerous silk-mills, brass and iron foundries, machine-shops, tanneries, rope-works, &c., are in operation. The parish church, the town-hall, the Blue-coat and the Grammar-schools, are the chief edifices. Pop. in 1851 of municipal borough, 52,820; 1861, of municipal borough, 72,333, of parliamentary borough, (which returns two members to the House of Commons), 94,344.

**OLDHAMIA**, a genus of fossil zoophytes, dedicated by Forbes to Professor Oldham, who was their discoverer. Only two species are known, but they are of peculiar interest, because, with their associated worm-tracks and burrows, they are the first distinct evidence of life on the globe. They exist as mere tracings on the surface of the laminae of metamorphosed shales, all remains of the substance of the organism having entirely disappeared. The form of the hard polypidom is preserved, and shews a jointed main stem, giving off at each joint, in the one species, a circle of simple rays, and in the other a fan-shaped group. Forbes pointed out their affinities in some respects to the Hydrozoa, and in others to the Polyzoa. Kinahan, who described the genus at some length, considers them to have been Hydrozoa allied to Sertularia; while Huxley places them among the Polyzoa.

**OLDYS, WILLIAM**, a most erudite and industrious bibliographer, was a natural son of Dr William Oldys, Chancellor of Lincoln, and advocate of the Admiralty Court, and was born in 1687. Regarding his early life, little is known. His father dying in 1708, left him a small property, which O. squandered as soon as he got it into his own hands. The most of his life was spent as a bookseller's hack. He drank hard; and was so scandalously fond of low company, that he preferred to live within the 'rules' of the Fleet Prison to any more respectable place. As may easily be supposed from his habits, the dissolute old bookworm was often in extremely necessitous circumstances, and when he died (April 15, 1761), he left hardly enough to decently bury him. It is but fair to add that O. had some sterling merits. Captain Grose, who knew him, praises his good-nature, honour, and integrity as a historian, and says that 'nothing would ever have biassed him to insert any fact in his writings which he did not believe, or to suppress any he did.' For about ten years, O. acted as librarian to the Earl of Oxford, whose valuable collection of books and MSS. he arranged and catalogued. His chief works are *The British Librarian, exhibiting a Compendious Review of all Unpublished and Valuable Books in all Sciences* (London, 1737, anonymously); a *Life of Sir Walter Raleigh*, prefixed to Raleigh's *History of the World* (1738); a translation of Camden's *Britannia* (2 vols.); *The Harleian Miscellany, or a Collection of Scarce, Curious, and Entertaining Tracts* (8 vols. Lond. 1753). Besides these, O. wrote a great variety of miscellaneous literary and bibliographical 'articles' for his friends the booksellers, which it would be tedious to mention.

**OLEACEÆ**, a natural order of exogenous plants, consisting of trees and shrubs, with opposite leaves, and flowers in racemes or panicles. The calyx is in one piece, divided, persistent; the corolla is hypogynous, generally 4-cleft, sometimes of four petals, sometimes wanting; there are generally two, rarely four stamens; the ovary is free, 2-celled, the cells 2-seeded; the fruit is a drupe, a capsule, or a samara (see these heads); the cotyledons are

foliaceous. Nearly 150 species are known, mostly natives of temperate countries. Among them are the olive, ash, lilac, privet, phillyrea, fringe tree, &c. Between some of these there is a great dissimilarity, so that this order is apt to be regarded as a very heterogeneous group; but the real affinity of the species composing it is manifested by the fact, that even those which seem most unlike can be grafted one upon another, as the lilac or the olive on the ash. Bitter, astringent, and tonic properties are prevalent in this order.

**OLEANDER** (*Nerium*), a genus of plants of the natural order *Apocynaceæ*, having a 5-parted calyx, set round on the inside at the base with many tooth-like points or glands, a salver-shaped 5-cleft corolla, in the throat of which is a 5-parted and toothed or lacerated corona, five stamens, the anthers adhering to the stigma, the fruit composed of two follicles. The species are evergreen shrubs with leathery leaves, which are opposite or in threes; the flowers in false umbels, terminal or axillary. The COMMON O. (*N. oleander*), a native of the south of Europe, the north of Africa, and many of the warmer temperate parts of Asia, is frequently planted in many countries as an ornamental shrub, and is not uncommon in Britain as a window-plant. It has beautiful red, or sometimes white, flowers. The English call it ROSE BAY, and the French ROSE LAUREL (*Laurier Rose*). It attains a height of eight or ten feet. Its flowers give a splendid appearance to many ruins in the south of Italy. It delights in moist situations, and is often found near streams. All parts of it contain a bitter and narcotic-acrid juice, poisonous to men and cattle, which flows out as a white milk when young twigs are broken off. Cases of poisoning have occurred by children eating its flowers, and even by the use of the wood for spits or skewers in roasting meat. Its exhalations are injurious to those who remain long under their influence, particularly to those who sleep under it. A decoction of the leaves or bark is much used in the south of France as a wash to cure cutaneous maladies.—*N. odoratum*, an Indian species, has larger flowers, which are very fragrant.—*N. piscidium* (or *Eschaltum piscidium*), a perennial climber, a native of the Kaasya Hills, has a very fibrous bark, the fibre of which is used in India as hemp. The steeping of the stems in ponds kills fish.

**OLEASTER**. See **ELÆAGNUS**.

**OLEFIANT GAS** ( $C_2H_2$ ) is transparent and colourless, possesses a disagreeable alliaceous odour, and acts as a poison when breathed. Its specific gravity is 0.981. It takes fire when brought in contact with a flame, and burns with a bright clear light. When this gas is mixed with oxygen or atmospheric air in the proportion of 1 volume with 3 volumes of oxygen, or with 15 volumes of atmospheric air, it forms a powerfully explosive mixture. It is more soluble in cold than in hot water—100 volumes of water at 32° absorbing 26.5 volumes of the gas, while at 68° they only absorb 14 volumes. It was liquefied by Faraday, under great pressure, but remained unfrozen at -166°. If it be conducted through strongly-heated tubes, or if a continuous series of electric sparks be passed through it, it is decomposed into a very dense black carbon, and double its own volume of hydrogen; and if it is subjected to a less intense heat, the products of decomposition are carbon and light carburetted hydrogen or marsh gas ( $C_2H_4$ ). Chlorine acts upon this gas in a very remarkable manner. When the two gases are mixed in equal volumes, they combine to form a heavy oily liquid, to which the term chloride of olefiant gas, or Dutch Liquid (q. v.), is

given. It is from this reaction that the term *olefant* was originally applied to this gas.

Olefant gas is a constituent of the gaseous explosive admixtures that accumulate in coal-pits, and of the gaseous products yielded by the distillation of wood, resinous matters, and coal; and the brightness of the flame of ordinary gas is in a great measure dependent upon the quantity of olefant gas that is present.

This gas is most readily obtained by the action of oil of vitriol on alcohol; the reactions that ensue are too complicated to be described in these pages.

OLEIC ACID ( $C_{18}H_{32}O_2$ ), at temperatures above  $57^\circ$ , exists as a colourless limpid fluid, of an oily consistence, devoid of smell and taste, and (if it has not been exposed to air) exerting no action on vegetable colours. At  $40^\circ$ , it solidifies into a firm, white, crystalline mass, and in this state it undergoes no change in the air; but when fluid, it readily absorbs oxygen, becomes yellow and rancid, and exhibits a strong acid reaction with litmus paper. It is not a volatile acid, and on the application of a strong heat, it breaks up into several substances, such as capric, caprylic, and sebacic acids—the last-named being the most characteristic product of the distillation. If oleic acid be exposed to the action of hyponitric acid ( $NO_2$ ), it is converted into an isomeric, solid, fatty acid, termed *elaidic acid*. A very small quantity of hyponitric acid (1 part to 200 of oleic acid) is sufficient to effect this remarkable change, the nature of which is unknown. When distilled with moderately strong nitric acid, it is oxidised into a large number of products, including all the volatile fatty acids represented by the formula  $C_nH_{2n}O_2$ , from formic acid ( $C_1H_2O_2$ ) to capric acid ( $C_{10}H_{20}O_2$ ), with six fixed dibasic acids of the formula  $C_nH_{2n-2}O_4$ , viz., succinic acid, lipoic acid, adipic acid, pimelic acid, suberic acid, and anchoic (or leparglylic) acid. When heated with hydrated potash, it breaks up into palmitic and acetic acids, as shewn in the equation:

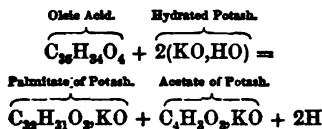

These decompositions and disintegrations seem to illustrate the facility with which, by the mere process of oxidation, which is perpetually at work in living structures, one organic acid can be converted into others.

Oleic acid is a constituent of *Oleine* (q. v.), which exists in most of the fats and fatty oils of the animal and vegetable kingdoms, and most abundantly in the liquid fats or oils, and hence its name is derived. It is very difficult to obtain the acid in a state of purity, in consequence of the readiness with which it oxidises; and we shall not enter into details regarding the method of its preparation. It is obtained in a crude form, as a secondary product, in the manufacture of stearine candles; but almond oil is generally employed when the pure acid is required.

Oleic acid forms normal (or neutral) and acid salts; but the only compounds of this class that require notice are the normal salts of the alkalies. These are all soluble, and by the evaporation of their aqueous solution, form *soaps*. Oleate of potash forms a soft soap, which is the chief ingredient in Naples soap; while oleate of soda is a hard soap, which enters largely into the composition of Marseille soap.

The oleates of the alkalies occur in the animal body, in the blood, chyle, lymph, and bile; they

have also been found in pus, in pulmonary tubercles, and in the excrements, after the administration of purgatives.

OLEINE ( $C_{14}H_{26}O_2$ ) is proved, by the researches of Berthelot, to be a triglyceride of oleic acid. See GLYCERINE. Pure oleine is a colourless and inodorous oil, which solidifies into acicular crystals at about  $23^\circ$ , is insoluble in water, and only slightly soluble in cold alcohol, but dissolves in ether in all proportions. By exposure to the air, it darkens in colour, becomes acid and rancid (from the gradual decomposition of the oleic acid), and finally assumes a resinoid appearance. Hyponitric acid converts it into an isomeric, white, solid fat, named *elaidine*—the glyceride of the elaidic acid described in the preceding article.

Pure oleine is obtained by cooling olive oil to  $32^\circ$ , which occasions the separation of the stearine and palmitine in a solid form. The fluid portion is then dissolved in alcohol, which, on being cooled to  $32^\circ$ , deposits in a solid form everything but oleine, which is obtained in a pure state by driving off by heat the alcohol from the decanted or filtered solution.

The drying oils, such as those of linseed, hemp, walnut, poppy, &c., contain a variety of oleine, which is not converted into elaidine by the action of hyponitric acid, or of subnitrate of mercury, which, when prepared without the aid of heat, contains enough of the acid to produce a similar effect. Hence, these substances may be used to detect fraudulent adulterations of olive or almond oil with poppy and other cheap drying oils.

OLEO'METER, or ELAÏOMETER, an instrument for ascertaining the densities of fixed oils. It consists of a very delicate thermometer-tube, the bulb being large in proportion to the stem. It is divided into fifty degrees, and floats at zero in pure oil of poppy-seed, at  $38^\circ$  to  $38\frac{1}{2}^\circ$  in pure oil of almonds, and at  $50^\circ$  in pure olive oil.

OLEOPHOSPHORIC ACID is a yellow viscid substance, which is insoluble in water and cold alcohol, but dissolves readily in boiling alcohol and in ether. When boiled for a long time with water or with alcohol, or when treated with an acid, it resolves itself into oleine and phosphoric acid; while alkalies decompose it into phosphoric acid, oleates, and glycerine. It exists, according to Frémy and other chemists, in the brain, spinal cord, kidneys, and liver.

OLÉRON, ISLE OF (anc. *Uliarus*), an island of France, forming a portion of the department of Charente-Inférieure, lies off the west coast of France, opposite the mouth of the river Charente. It is 19 miles long, and about 5 miles broad, and is unusually fertile, producing abundantly all the crops grown in the department to which it belongs. See CHARENTE-INFÉRIEURE. At its northern extremity, is the light-house of Chassiron. In the seaport of Oléron, distilleries, rope-walks, and ship-building yards are in operation. The town of Sainte-Pierre-d'Oléron (pop. 1556) stands near the centre of the island. The pop. of the island is given at 16,000.

OLÉRON, LAWS OF, or JUGEMENTS D'OLÉRON, a celebrated code of maritime law compiled in France in the reign of St Louis, and so named from a groundless story, that it was enacted by Richard I. of England during the time that his expedition to Palestine lay at anchor at that island. The real origin of these laws was a written code, called *Il Consolato del Mare*, of about the middle of the 13th c., compiled either at Barcelona or at Pisa, forming the established usages of Venice and the other Mediterranean states, and acceded to by the kings of France and counts of Provence. Besides containing regulations simply mercantile, this system

defined the mutual rights of belligerent and neutral vessels, as they have been since understood in modern international law. The so-called laws of Oléron were a code of regulations borrowed from the *Consolato*, which for several centuries were adopted as the basis of their maritime law by all the nations of Europe. Copies of the *Jugements d'Oléron* are appended to some ancient editions of the *Coutumier de Normandie*. See NORMANDY, CUSTOMARY LAW OF.

OLGA, St., a saint of the Russian Church, wife of the Duke Igor of Kiev, who, having undertaken an expedition against Constantinople, which proved unsuccessful, was slain on his return to his own dominions. His widow O. avenged his death, assumed the government in his stead, and for many years governed with much prudence and success. Having resigned the government to her son Vratslaf about the year 952, she repaired to Constantinople, where she was baptized, by the patriarch Theophilaktes, and received into the church, assuming at baptism the name of Helena, in honour of St Helena, mother of Constantine. She returned to Russia, and laboured with much zeal for the propagation of her new creed; but she failed in her attempt to induce her son, Swântoslav, to embrace Christianity. Her grandson, Vladimir, having married Chrysoberga, the sister of the emperors of Constantinople, Basil and Constantine, was baptized in the year 988; but his grandmother did not live to enjoy this gratification, having died in 978, or, according to other authorities, as early as 970. She is held in high veneration in the Russian Church. Her festival is held on July 21, and the practice of venerating her appears to date from the early period of the Russian Church, before the schism between the Eastern and Western churches.

OLIBANUM, a gum-resin, which flows from incisions made in *Boswellia serrata*, a tree found in some parts of the East. See BOSWELLIA. It is the *Lebanah* of the Hebrews, *Libanos* or *Libanotos* of the Greeks, *Thus* of the Romans, of all which terms the ordinary English translation is *Frankincense* (q. v.). It occurs in commerce in semi-transparent yellowish tears and masses; has a bitter nauseous taste; is hard, brittle, and capable of being pulverised; and diffuses a strong aromatic odour when burned. It was formerly used in medicine, chiefly to restrain excessive mucous discharges; but its use for such purposes is now rare. It sometimes enters as an ingredient into stimulating plasters. It is chiefly employed for fumigation, and is used as incense in Roman Catholic churches. It is sometimes distinctively called *Indian O.*; a similar substance, in smaller tears, called *African O.*, being produced by *Boswellia papyrifera*, a tree found growing on bare limestone rocks in the east of Abyssinia, and sending its roots to a great depth into the crevices of the rock. The middle layers of the bark are of fine texture, and are used instead of paper for writing.

OLIFANT'S RIVER. Two considerable streams of this name are found in the Cape Colony. The Olifant's River West rises in the Winterhoek Mountains, and enters the Atlantic in lat. 31° 40', after a course of 150 miles, and a basin of drainage of 25,000 square miles.—The Olifant's River East drains a great part of the district of George, and joins the Gauritz River 60 miles above the entrance of that river into the sea. Its course is upwards of 150 miles in length, and it is more available for irrigation than almost any other Cape river.

O'LIGARCHY (*oligo*, few, and *archo*, to govern), a term applied by Greek political writers to that perversion of an aristocracy in which the rule of the

dominant part of the community ceases to be the exponent of the general interests of the state, owing to the cessation of those substantial grounds of pre-eminence in which an aristocracy originated. The governing power in these circumstances becomes a faction, whose efforts are chiefly devoted to their own aggrandisement and the extension of their power and privileges.

OLINDA, a suburb of the Brazilian city of Pernambuco (q. v.).

OLIPHANT, MRS MARGARET (*née* WILSON), one of the most distinguished of our living female novelists, was born about the year 1820. The prevalent impression that she is a Scotchwoman, naturally enough derived from the obvious fondness with which in her earlier works she has treated Scottish character and incident, is not strictly correct. She is a native of Liverpool; her mother was, however, a Scotchwoman of a somewhat remarkable type, strongly attached to old traditions. In 1843, Mrs O. published her first work, *Passages in the Life of Mrs Margaret Maitland of Sunnyside*, which instantly won attention and approval. Its most distinctive charm is the tender humour and insight which regulate its exquisite delineation of Scottish life and character at once in their higher and lower levels. This work was followed by *Merkland* (1851); *Adam Graeme of Mossgrays* (1852); *Harry Muir* (1853); *Magdalen Hepburn* (1854); *Lilliesleaf* (1855); and subsequently by *Zaidee*, *Katie Stewart*, and *The Quiet Heart*, which originally appeared in succession in *Blackwood's Magazine*. Though these are of somewhat various merit, in all of them the peculiar talent of the writer is marked. They are rich in the minute detail which is dear to the womanly mind; have nice and subtle insights into character, a flavour of quiet humour, and frequent traits of delicacy and pathos in the treatment of the gentler emotions. It is, however, on the *Chronicles of Carlingford* that her reputation as a novelist most securely rests. In the first of the two sections separately published, apart from its other merits, which are great, the character of little Netty, the heroine, vivifies the whole work, and may rank as an original creation. The other, *Salem Chapel*, perhaps indicates a wider and more vigorous grasp than is to be found in any other work of the authoress. Certain of the unlovelier features of English dissent, as exhibited in a small provincial community, are here graphically sketched, and adapted with admirable skill to the purposes of fiction. The intrusion, however, in some portion of the work of a 'sensational' element, as it is termed, though it subserves intensity of interest, must be noted as a little defective in art, the tragic material coalescing throughout but indifferently with the circle of homelier fact, in which the story for the most part moves. In addition to her novels, this accomplished lady has, in her *Life of Edward Irving*, published in 1862, made a most valuable contribution to biographical literature.

OLIVAREZ, DON GASPARO DE GUZMAN, COUNT OF DUKE OF SAN LUCAR, and prime-minister of Philip IV. of Spain, was born on January 6, 1587, at Rome, where his father was ambassador. He belonged to a distinguished but impoverished family, received a learned education, became the friend of Philip IV., his confidant in his amours, and afterwards his prime-minister, in which capacity he exercised almost unlimited power for twenty-two years. O. shewed ability for government, but his constant endeavour was to wring money from the country that he might carry on wars. His oppressive measures caused insurrections in Catalonia and

## OLIVE—OLIVES.

Andalusia, and roused the Portuguese to shake off the Spanish yoke in 1640, and make the Duke of Braganza their king, an event which O. reported to Philip with satisfaction, as it enabled him to confiscate the duke's great estates in Spain. But the arms of Spain being unsuccessful, the king was obliged to dismiss the minister in 1643. He would probably have been recalled to the head of affairs, but for a publication in which he gave offence to many persons of influence. He was ordered to retire to Toro, and confine himself to that place, where he died, 12th July 1645. (Cespedes, *Hist. De Felipe IV.*)

**OLIVE** (*Olea*), a genus of trees and shrubs of the natural order *Oleaceae*; having opposite, evergreen, leathery leaves, which are generally entire, smooth, and minutely scaly; small flowers in compound axillary racemes, or in thyrsi at the end of the twigs; a small 4-toothed calyx, a 4-cleft corolla, two stamens, a 2-cleft stigma; the fruit a drupe. The species are widely distributed in the warmer temperate parts of the globe. The **COMMON O.** (*O. Europaea*), a native of Syria and other Asiatic countries, and perhaps also of the south of Europe, although probably it is there rather naturalized than indigenous, is in its wild state a thorny shrub



Common Olive (*Olea Europaea*):

a, fruit reduced; b, flower; c, flower with corolla and stamens removed to shew the pistil.

or small tree, but through cultivation becomes a tree of 20–40 feet high, destitute of spines. It attains a prodigious age. The cultivated varieties are very numerous, differing in the breadth of the leaves, and in other characters. The leaves resemble those of a willow, are lanceolate, entire, of a dull dark-green colour above, scaly and whitish-gray beneath; the flowers small and white, in short dense racemes; the fruit greenish, whitish, violet, or even black, never larger than a pigeon's egg, generally oval, sometimes globular, or obovate, or acuminate. The fruit is produced in vast profusion, so that an old olive-tree becomes very valuable to its owner. It is chiefly from the pericarp that olive oil is obtained, not from the seed, contrary to the general rule of the vegetable kingdom. Olive oil is much used as an article of food in the countries in which it is produced, and to a smaller extent in other countries, to which it is exported also for medicinal and other uses (see **OILS**). Olives, gathered before they are quite ripe, are pickled

in various ways, being usually first steeped in lime-water, by which they are rendered softer and milder in taste. They are well known as a restorative of the palate, and are also said to promote digestion. Disagreeable as they generally are at first, they are soon greatly relished, and in the south of Europe are even a considerable article of food. Dried olives are there also used, as well as pickled olives.—The wood of the olive-tree takes a beautiful polish, and has black cloudy spots and veins on a greenish-yellow ground; it is principally used for the finest purposes by cabinet-makers and turners. The wood of the root is marked in a peculiarly beautiful manner, and is used for making snuff-boxes and small ornamental articles. The bark of the tree is bitter and astringent; and both it and the leaves have febrifuge properties. A gum resin exudes from old stems, which much resembles storax, has an odour like vanilla, and is used in all parts of Italy for perfumery.—Among the Greeks, the O. was sacred to Pallas Athene (Minerva), who was honoured as the bestower of it; it was also the emblem of chastity. A crown of olive-twigs was the highest distinction of a citizen who had merited well of his country, and the highest prize of the victor in the Olympic games. An olive branch was also the symbol of peace (compare Gen. viii. 11); and the vanquished, who came to supplicate for peace, bore olive-branches in their hands.—The O. has been cultivated in Syria, Palestine, and other parts of the east, from the earliest times. Its cultivation extends southwards as far as Cairo, and northwards to the middle of France. It is very generally propagated by suckers, but where great care is bestowed on it, inarching is practised. It grows from cuttings. The climate of England is too cold for the O., yet in Devonshire it ripens its fruit on a south wall.—*Olea similis* and several other species are useful trees of South Africa, yielding a very hard and extremely durable wood. Some of them bear the name of **IRONWOOD** at the Cape of Good Hope. The **AMERICAN O.** (*O. Americana*) is also remarkable for the hardness of its wood. It is found as far north as Virginia. It is a tree of 30–35 feet high, with much broader leaves than the Common Olive. Its fruit is fit for use. Its flowers are fragrant. The **FRAGRANT O.** (*O. fragrans*, or *Osmanthus fragrans*) of China and Japan has extremely fragrant flowers, which are used by the Chinese for flavouring tea.

**O'LIVENITE**, a mineral, consisting chiefly of arsenic acid and protoxide of copper, with a little phosphoric acid and a little water. It is generally of some dark shade of green, sometimes brown or yellow. It is found along with different ores of copper in Cornwall and elsewhere. It is often crystallised in oblique four-sided prisms, of which the extremities are acutely bevelled, and the obtuse lateral edges sometimes truncated, or in acute double four-sided pyramids; it is sometimes also spherical, kidney-shaped, columnar, or fibrous.

**OLIVES, MOUNT OF**, called also **MOUNT OLIVET**, an inconsiderable ridge lying on the east side of Jerusalem, from which it is only separated by the narrow Valley of Jehosaphat. It is called by the modern Arabs *Jebel-el-Tur*, and takes its familiar name from a magnificent grove of olive-trees which once stood on its western flank, but has now in great part disappeared. The road to Mount Olivet is through St Stephen's Gate, and leads by a stone bridge over the now almost waterless brook Cedron. Immediately beyond, at the foot of the bridge, lies the Garden of Gethsemane; and the road here parts into two branches, northwards towards Galilee, and eastwards to Jericho. The



## OLIVETANS—OLORON.

ridge rises in three peaks, the central one of which is 2556 feet above the level of the sea, and 416 feet above the Valley of Jehosaphat. The southern summit is now called 'the Mount of Offence,' and was the scene of the idolatrous worship established by Solomon for his foreign wives and concubines. The northern peak is the supposed scene of the appearance of the angels to the disciples after the resurrection, and is remarkable in Jewish history as the place in which Titus formed his encampment in the expedition against the fated city of Jerusalem. But it is around the central peak, which is the Mount of O. properly so called, that all the most sacred associations of Christian history converge. On the summit stands the Church of the Ascension, built originally by St Helen, the modern church being now in the hands of the Armenian community; and near it are shewn the various places where, according to tradition, our Lord wept over Jerusalem, where the apostles composed the apostles' creed, where our Lord taught them the Lord's Prayer, &c. Near the Church of the Ascension is a mosque and the tomb of a Mohammedan saint. In the Garden of Gethsemane, at the foot of the hill, is shewn the scene of our Lord's agony. The northern peak spreads out into a plain of considerable extent, which is painfully notable in Jewish history as the place where, after the Jews on occasion of the revolt under Bar-Kochebah, were debarred by Adrian from entering Jerusalem, they were wont to assemble annually on the anniversary of the burning of the Temple to celebrate this mournful anniversary, and to take a distant look at their beloved Jerusalem. The scene is beautifully described, and with much dramatic feeling, by St Jerome.—*Com. in Sophoniam*, t. iii. p. 1665.

**OLIVETANS**, a religious order of the Roman Catholic Church, one of the many remarkable products of that well-known spiritual movement which characterised the 12th and 13th centuries. The O., or Brethren of Our Lady of Mount Olivet, are an offshoot of the great Benedictine Order (q. v.), and derive their origin from John Tolomei, a native of Siena, born in the year 1272. Tolomei had been a distinguished professor of philosophy in the university of his native city; but his career was suddenly interrupted by the loss of his sight. Although he was cured of his blindness (and, as he himself believed, miraculously), this visitation convinced him of the vanity of earthly things; and in company with some friends he withdrew to a solitary place near Siena, where he devoted himself to prayer and religious exercises. By the direction of the pope, John XXII., the new brethren adopted the Benedictine rule; but they chose as their especial province the cultivation of sacred science, and the duty of teaching. In the year 1319, Tolomei was chosen as the first general; and even in his lifetime the institute made rapid progress, especially in Italy. It numbered at one time eighty houses, but at present the number is reduced to four—namely, the parent house, so called, of Monte Oliveto, in the diocese of Arezzo in Tuscany, one at Rome, one at Genoa, and one at Palermo. The O. order has produced many distinguished ecclesiastics.

**OLIVINE.** See **CHRYSOLITE**.

**OLLA PODRIDA** (literally, *putrid pot*), a Spanish term, originally signifying an accumulation of remains of flesh, vegetables, &c., thrown together into a pot, but generally employed to designate a favourite national dish of the Spaniards, consisting of a mixture of different kinds of meat and vegetables stewed together. It has also come to be figuratively applied to literary productions of very miscellaneous contents. The French equivalent is

*pot-pourri*, and the Scotch *hotch-potch*, both of which, but especially the former, are also employed in a figurative sense.

**O'LMUTZ**, the chief fortress of Moravia, Austria, is the capital of a district of the same name, and is situated in lat. 49° 36' N., and in long. 17° 15' E., on an island of the river Morava, which, by means of sluices, can be opened into the moats, and thus made available for purposes of defence. O. is the see of an archbishop, nominated by the chapter, and is the chief seat of the administrative departments. It has a university, founded in 1581, dissolved in 1778, and reorganised in 1827; a library of 50,000 vols.; good natural history, physical, and other museums; a gymnasium, an archiepiscopal seminary, artillery and infantry academies, polytechnic and other schools, a hospital, an asylum for widows and orphans, &c. The most noteworthy of its 13 churches are the cathedral, a fine old building, and the church of St Mauritius, completed in 1412, with its celebrated organ, having 48 stops, and more than 2000 pipes. The noble town-hall, with its complicated clock-work, set up in 1574, and the lofty column on the 'Oberring', with several fine fountains in the squares, and the splendid archiepiscopal palace and chapter-house, all contribute towards the picturesque aspect for which O. is distinguished. The deficiency in public gardens has of late years been in part supplied by the draining and planting of some of the inner moats, and the conversion of some portions of the fortifications into pleasure-grounds. A mile from the city lies the recently-restored monastery of the Premonstratensians at Hradisch, founded in 1074. O. has a few manufactories of kerseymer, cloth, linen, and porcelain, and is the seat of an extensive trade in cattle from Poland and Moldavia. Pop. 12,000. Prior to 1777, when O. was raised into an archbishopric, its bishops had long been in the enjoyment of the rank of princes of the empire. The city suffered severely during the Thirty Years' War, and again in the Seven Years' Wars of Silesia, when it more than once fell into the hands of the Prussians. In 1848, Ferdinand I. signed his abdication here in favour of his nephew, the present emperor; while in 1850, O. was chosen as the place of conference between the Prussian, Austrian, and Russian plenipotentiaries, for the adjustment of the conflicting differences which had arisen in the German states generally, as the result of the revolutionary movement of 1848.

**OLONETZ**, a government in the north of Russia, bounded on the W. by Finland, and on the E. and N.-E. by Archangel. Area, exclusive of water, 49,104 square miles. Pop. 290,118. Large lakes abound in this government, the chief, after Lake Onega (q. v.), being Lakes Wygo and Sego. The surface is in general elevated, and about four-fifths of it are covered with wood. The soil is sterile, and the climate is cold and damp. The wealth of the government consists principally in its minerals. Its iron-mines supply the iron-works of Petrasowodsk, and from its quarries marbles are sent to St Petersburg. The principal employments of the inhabitants, who are principally Russians and Finns, and belong to the Greek Church, are carving in wood, fishing and hunting. Many of them also are employed in the ironworks and quarries. The women weave and spin. The government derives its name from the small but ancient town of Olonetz. Petrasowodsk is the centre of administration.

**OLORON**, or **OLORON-SAINTE-MARIE**, a town of France, in the department of Basses-Pyrénées, on the Gave d'Oloron, 15 miles south-west of

## OLYMPIA—OLYMPIC GAMES.

Pan. The Church of St Marie is in the transition style from Romanesque to Gothic. The principal articles of manufacture are the chequered handkerchiefs which form the favourite head-dresses of the peasantry of Aragon and Gascony, and also the 'barrets' or caps of the Béarnais. Pop. (1862) 7533.

**OLYMPIA**, the scene of the celebrated Olympic Games (q. v.), is a beautiful valley in Elis, in the Peloponnesus, through which runs the river Alpheus. As a national sanctuary of the Greeks, O. contained, within a small space, many of the choicest treasures of Grecian art belonging to all periods and states, such as temples, monuments, altars, theatres, and multitudes of images, statues, and votive-offerings of brass and marble. In the time of the elder Pliny, there still stood here about 3000 statues. The Sacred Grove (called the *Altis*) of Olympia, enclosed a level space about 4000 feet long by nearly 2000 broad, containing both the spot appropriated to the games and the sanctuaries connected with them. It was finely wooded, and in its centre stood a clump of sycamores. The *Altis* was crossed from west to east by a road called the 'Pompic Way,' along which all the processions passed. The Alpheus bounded it on the south, the Gladeus, a tributary of the former, on the west, and rocky but gently swelling hills on the north; westward it looked towards the Ionian Sea. The most celebrated building was the *Olympicum*, or *Olympium*, dedicated to Olympian Zeus. It was designed by the architect Libon of Elis in the 6th c. B. C., but was not completed for more than a century. It contained a colossal statue of the god, the master-piece of the sculptor Phidias, and many other splendid figures; its paintings were the work of Pausanias, a relative of Phidias. Next to the *Olympicum* ranked the *Heræum*, dedicated to Hera, the wife of Zeus, and the Queen of Heaven, containing the table on which were placed the garlands prepared for the victors in the games; the *Pelopium*, the *Metroum*, the ten *Thesauri* or Treasuries, built for the reception of the dedicatory offerings of the Greek cities, the temples of Eileithyia and Aphrodite also deserve mention; the *Stadium* and the *Hippodrome*, where the contests took place, stood at the eastern end of the *Altis*. The ploughshare now passes through the scene of these contests, but many ruins still attest the ancient magnificence of the buildings. Explorations, attended with great success, have been made by the French commission of the Morea.

**OLYMPIAD** (Gr. *olympias*), the name given to the period of four years that elapsed between two successive celebrations of the Olympic Games (q. v.); a mode of reckoning which forms the most celebrated chronological era among the Greeks. The first recorded olympiad dates from the 21st or 22d of July 776 B. C., and is frequently referred to as the Olympiad of Coræbus; for historians, instead of referring to the olympiad by its number, frequently designate it by the name of the winner of the foot-race in the Olympic games belonging to that period, though at times both the number and the name of the conqueror are given. A slight indefiniteness is frequently introduced into Greek chronology, from the custom of mentioning only the olympiad, neglecting to specify in which year of the olympiad a certain event happened. As this era commenced in 776 B. C., the first year of our present era (1 A. D.) corresponded to the last half of the fourth year of the 194th with the first half of the first year of the 195th olympiad, and 394 A. D. corresponds to the second year of the 233d olympiad, at which time reckoning by olympiads terminated. This era is used only by writers, and is never found on coins, and very seldom on

inscriptions. Another olympic era, known as the 'New Olympic Era,' was commenced by the Roman emperors, and dates from 131 A. D.; it is found both in writings, public documents, and inscriptions.

**OLYMPIAS**, the wife of Philip II., king of Macedon, and mother of Alexander the Great. She was the daughter of Neoptolemus I., king of Epirus. She possessed a vigorous understanding, but was of a most passionate, jealous, and ambitious character. Philip having, on account of disagreements, separated from her and married Cleopatra, niece of Attalus (337 B. C.), she went to reside with her brother Alexander, king of Epirus, where she incessantly fomented intrigues against her former husband, and is believed to have taken part in his assassination by Pausanias, 337 B. C. On the accession of her son Alexander to the throne, she returned to Macedonia, where she contributed to bring about the murder of Cleopatra and her daughter. Alexander was filled with indignation, but O. was his mother, and he could not obey the dictates of justice. During his brief but magnificent career he always treated her with the utmost reverence and esteem, though he never allowed her to meddle with his political schemes. After his death she endeavoured to get possession of the vacant throne, and obtained the support of Polysperchon in her designs. In 317, the two defeated Arrhidæus, the weak-minded step-brother and successor of Alexander, and his wife Eurydice, whom she caused to be put to death in the same year. She now began to glut her revenge on such of the Macedonian nobles as had shewn themselves hostile to her; but her cruelties soon alienated the minds of the people from her, even though she was the mother of their heroic king, whereupon Cassander (q. v.), her principal adversary, marched north from the Peloponnesus, besieged her in Pydna, and forced her to surrender in the spring of 316 B. C. She was immediately afterwards put to death. O. was a woman of heroic spirit, but of fierce and uncontrollable passions, and in the perpetration of crime, when she reckoned it necessary, displayed an unscrupulousness peculiarly feminine.

**OLYMPIC GAMES**, the most splendid national festival of the ancient Greeks, were celebrated every fifth year in honour of Zeus, the father of the gods, on the plain of Olympia (q. v.). Their origin goes back into prehistoric ages. According to the myth elaborated or preserved by the Elean priests, they were instituted by the Isean Herakles in the time of Kronos, father of Zeus; according to others, by the later Herakles, son of Zeus and Alkmene; while Strabo, rejecting the older and more incredible legends, attributes their origin to the Herakleids after their conquest of the Peloponnesus. But the first glimpse of anything approaching to historic fact in connection with the games is their so-called revival by Iphitos, king of Elis, with the assistance of the Spartan lawgiver, Lycurgus, about 884 B. C.; or, according to others, about 828 B. C., an event commemorated by an inscription on a disc kept in the *Heræum* at Olympia, which Pausanias (flor. 2d c. A. D.) saw. That festive games were celebrated here, in other words, that Olympia was a sacred spot, long before the time of Iphitos, can indeed hardly be doubted: the universal tradition that the Elean king had only 'revived' the games, proves this; but nothing whatever can be historically ascertained concerning their origin, character, or frequency, in this remoter time. Iphitos may, therefore, be regarded as their founder, yet the reckoning of time by Olympiads (q. v.)—the real dawn of the historical period in Greek history—did not begin till more than a century later. At

first, it is conjectured, only Peloponnesians resorted to the Olympic games, but gradually the other Greek states were attracted to them, and the festival became *Pan-Hellenic*. Originally, and for a long time, none were allowed to contend except those of pure Hellenic blood; but after the conquest of Greece by the Romans, the latter sought and obtained this honour, and both Tiberius and Nero figure in the list of Roman victors. Women—with one exception, the priestess of Demeter Chamyne—were forbidden to be present, on pain of being thrown headlong from the Tyspean Rock. The games were held from the 11th to the 15th of the Attic month *Hekatombeion* (our July—August), during which, first throughout Elis, and then throughout the rest of Greece, heralds proclaimed the cessation of all intestine hostilities; while the territory of Elis itself was declared inviolable. The combatants were required to undergo a preparatory training for ten months in the gymnasium at Elis, and during the last of these months the gymnasium was almost as numerously attended as the games themselves. Much uncertainty prevails as to the manner in which the contests were distributed over the different days. Krause (*Olympia*, p. 106) suggests the following order: On the first day the great initiatory sacrifices were offered, after which the competitors were properly classed and arranged by the judges, and the contests of the trumpeters took place; the second day was set apart for the boys who competed with each other in foot-races, wrestling, boxing, the pentathlon, the pankration, horse-races; the third and principal day was devoted to the contests of men in foot-races of different kinds (as, for example, the simple race, once over the course; the *dioulos*, in which the competitors had to run the distance twice; and the *dolichos*, in which they had to run it seven or twelve times); wrestling, boxing, the *pankration* (in which all the powers and skill of the combatants were exhibited), and the race of *hoplites*, or men in heavy armour; on the fourth day came off the *pentathlon* (contest of five games—viz, leaping, running, throwing the discus, throwing the spear, and wrestling), the chariot and horse races, and perhaps the contests of the heralds; the fifth day was set apart for processions, sacrifices, and banquets to the victors (called *Olympionikoi*), who were crowned with a garland of wild olive twigs cut from a sacred tree which grew in the Altis (see OLYMPIA), and presented to the assembled people, each with a palm branch in his hand, while the heralds proclaimed his name, and that of his father and country. On his return home, he was received with extraordinary distinction: songs were sung in his praise (14 of Pindar's extant lyrics are devoted to *Olympionikoi*); statues were erected to him, both in the Altis and in his native city; a place of honour was given him at all public spectacles; he was in general exempted from public taxes, and at Athens was boarded at the expense of the state in the Prytaneion.

The regulation of the games belonged to the Eleans, from whom were chosen the *hellanodikai*, or judges, whose number varied. At first there were only two, but as the games became more and more national, and consequently more numerous, they were gradually increased to ten, sometimes even to twelve. They were instructed in their duties for ten months beforehand at Elis, and held their office only for one year. The officers who executed their commands were called *alytai*, and were under the presidency of an alytarch.—See Krause's *Olympia oder Darstellung der grossen Olympischen spiele* (Wien, 1838).

OLYMPIODORUS, one of the latest of the Alexandrian Neoplatonists, flourished in the first

half of the 6th c. after Christ, during the reign of the Emperor Justinian. Regarding his life nothing is known. Of his writings, we possess a *Life of Plato*, with commentaries or scholia on several of his dialogues, the Gorgias, Philebus, Phædo, and Alcibiades I. In these he appears as an acute and vigorous thinker, and as a man of great erudition. O.'s *Life of Plato* was published by Wetstein (1692), Etwall (Lond. 1771), and Fischer (Leips. 1783); the best edition of the scholia is that of Mystoxides and Schinas (Venice, 1816).

OLYMPUS, the ancient name of several mountains or chains of mountains—e. g., of the north-western continuation of Taurus in Mysia, of a mountain in the island of Cyprus, of one in Lycia, of another in Elia, of one on the borders of Laconia and Arcadia, and of another on the frontiers of Thessaly and Macedonia. Of these, the last-mentioned (now called *Elymbos*) is the most famous. Its eastern side, which fronts the sea, is composed of a line of vast precipices, cleft by ravines, filled with forest-trees. Oak, chestnut, beech, plane tree, are scattered abundantly along its base, and higher up appear great forests of pine, as in the days of the old poets of Greece and Rome. With Euripides, it is *poludendros Olympos*; with Virgil, *frondosus Olympos*; and with Horace, *opacus Olympos*. Its highest peak is 9754 feet above the level of the sea, and is covered with snow for about nine months of the year. It was regarded by the ancient Greeks as the chief abode of the gods, and the palace of Zeus was supposed to be upon its broad summit. According to Greek legend, it was formerly connected with Ossa, but was separated from it by an earthquake, allowing a passage for the Peneius through the narrow vale of Tempe to the sea. The philosophers afterwards transferred the abode of the gods to the planetary spheres, to which they likewise transferred the name of Olympus.

OM is a Sanscrit word which, on account of the mystical notions that even at an early date of Hindu civilisation were connected with it, acquired much importance in the development of Hindu religion. Its original sense is that of emphatic or solemn affirmation or assent. Thus, when in the White-Yajur-Veda (see VEDA) the sacrificer invites the gods to rejoice in his sacrifice, the god Savitr'i assents to his summons by saying: 'Om (i. e., be it so); proceed!' Or, when in the Brihad-Aranyaka-Upanishad, Prajâpati, the father of gods, men, and demons, asks the gods whether they have understood his instruction; he expresses his satisfaction with their affirmative reply, in these words: 'Om, you have fully comprehended it;' and, in the same Upanishad, Pravâhan'a answers the question of S'wetaketu, as to whether his father has instructed him, by uttering the word 'Om,' i. e., 'forsooth (I am).' A portion of the R'igveda, called the Aitareya-Brahman'a, where describing a religious ceremony at which verses from the R'igveda, as well as songs called Gâthâs, were recited by the priest called Hotr'i, and responses given by another priest, the Adhwaryu, says: 'Om is the response of the Adhwaryu to the R'igveda verses (recited by the Hotr'i), and likewise *taihâ* (i. e., thus) his response to the Gâthâs, for Om is (the term of assent) used by the gods, whereas *taihâ* is (the term of assent) used by men' (the R'igveda verses being, to the orthodox Hindu, of divine, and the Gâthâs of human, authorship). In this, the original sense of the word, it is little doubtful that om is but an older and contracted form of the common Sanscrit word *avam*, 'thus,' which, coming from the pronominal base 'a'—in some derivations changed to 'e'—may have at one time occurred in the form *avam*, when, by the elision

of the vowel following *v*—for which there are numerous analogies in Sanscrit—*avam* would become *aum*, and hence, according to the ordinary phonetic laws of the language, *om*. This etymology of the word, however, seems to have been lost, even at an early period of Sanscrit literature; for another is met with in the ancient grammarians, enabling us to account for the mysticism which many religious and theological works of ancient and medieval India suppose to inhere in it. According to this latter etymology, *om* would come from a radical *av* by means of an affix *man*, when *om* would be a curtailed form of *amman* or *oman*; and as *av* implies the notion of 'protect, preserve, save,' *om* would be a term implying 'protection or salvation'; its mystical properties and its sanctity being inferred from its occurrence in the Vedic writings, and in connection with sacrificial acts, such as are alluded to before.

Hence *Om* became the auspicious word with which the spiritual teacher had to begin, and the pupil had to end each lesson: of his reading of the Veda. 'Let this syllable,' the existing Prâtiśākhya, or grammar of the R'igveda, enjoins, 'be the head of the reading of the Veda, for alike to the teacher and the pupil, it is the supreme Brahman, the gate of heaven.' And Manu (q. v.) ordains: 'A Brahman, at the beginning and end (of a lesson on the Veda), must always pronounce the syllable *Om*; for unless *Om* precede, his learning will slip away from him; and unless it follow, nothing will be long retained.' At the time when another class of writings, the Purân's (q. v.), were added to the inspired code of Hinduism, for a similar reason, *Om* is their introductory word.

That the mysterious power which, as the foregoing quotation from the law-book of Manu shews, was attributed to this word, must have been the subject of early speculation, is obvious enough. A reason assigned for it is given by Manu himself. 'Brahmâ,' he says, 'extracted from the three Vedas the letter *a*, the letter *u*, and the letter *m* (which combined result in *Om*), together with the (mysterious) words *Bhûh'* (earth), *Bhuvah'* (sky), and *Swah'* (heaven);' and in another verse: 'These three great immutable words, preceded by the syllable *Om*, and (the sacred R'igveda verse, called) *Gâyatri*, consisting of three lines, must be considered as the mouth (or entrance) of Brahman (the Veda)'—or, as the commentators observe—the means of attaining final emancipation; and 'The syllable *Om* is the supreme Brahman, (three) regulated breathings (accompanied with the mental recitation of *Om*, the three mysterious words, *Bhûh'*, *Bhuvah'*, *Swah'*, and the *Gâyatri*), are the highest devotion. . . . All rites ordained in the Veda, such as burnt and other sacrifices, pass away; but the syllable *Om* must be considered as imperishable, for it is (a symbol of) Brahman (the supreme Spirit) himself, the Lord of Creation.' In these speculations, Manu bears out, and is borne out by, several Upanishads. See VEDA. In the *Katha-Upanishad*, for instance, *Yama*, the god of death, in replying to a question of Nachiketâs, says: 'The word which all the Vedas record, which all the modes of penance proclaim, of which desirous the religious students perform their duties, this word I will briefly tell thee, it is *Om*. This syllable means the (inferior) Brahman and the supreme (Brahman). Whoever knows this syllable, obtains whatever he wishes.' And in the *Pras'na-Upanishad*, the saint Pippalâda says to Satyakâma: 'The supreme and the inferior Brahman are both the word *Om*; hence the wise follows by this support the one or the other of the two. If he meditates upon its one letter (*a*) only, he is quickly born on the earth; him carry the verses of the R'igveda to the world of man; and if

he is devoted there to austerity, the duties of a religious student, and faith, he enjoys greatness. But, if he meditates in his mind on its two letters (*a* and *u*), he is elevated by the verses of the Yajur-Veda to the intermediate region; he comes to the world of the moon, and having enjoyed there power, returns again (to the world of man). If, however, he meditates on the supreme Spirit by means of its three letters (*a*, *u*, and *m*), he is produced in light, in the sun; as the snake is liberated from its skin, so he is liberated from sin.' According to the Mân'd'ûkya-Upanishad, the nature of the soul is summarised in the three letters *a*, *u*, and *m*, in their isolated and combined form—*a* being *Vaisvânara*, or that form of Brahman which represents the soul in its waking condition; *u*, *Tajjasa*, or that form of Brahman which represents it in its dreaming state; and *m*, *Prâjna*, or that form of Brahman which represents it in its state of profound sleep (or that state in which it is temporarily united with the supreme Spirit); while *a*, *u*, *m* combined, i. e., *Om*, represent the fourth or highest condition of Brahman, which is unaccountable, in which all manifestations have ceased, which is blissful and without duality. *Om*, therefore, is soul; and by this soul, he who knows it enters into (the supreme) soul.' Passages like these may be considered as the key to the more enigmatic expressions used, for instance, by the author of the *Yoga* (q. v.) philosophy, where, in three short sentences, he says: 'His (the supreme Lord's name) is *Pranava* (i. e., *Om*); its muttering (should be made) and reflection on its signification; thence comes the knowledge of the transcendental spirit, and the absence of the obstacles' (such as sickness, languor, doubt, &c., which obstruct the mind of an ascetic). But they indicate, at the same time, the further course which superstition took in enlarging upon the mysticism of the doctrine of the Upanishads. For as soon as every letter of which the word *Om* consists was fancied to embody a separate idea, it is intelligible that other sectarian explanations were grafted on them, to serve their special purpose. Thus, while S'ankara, the great theologian and commentator on the Upanishads, is still contented with an etymological punning, by means of which he transforms 'a' (or rather 'â') into an abbreviation of *âpti* (pervading), since speech is pervaded by *Vaisvânara*; 'u' into an abbreviation of *utkarsha* (superiority), since *Tajjasa* is superior to *Vaisvânara*; and 'm' into an abbreviation of *miti* (destruction), *Vaisvânara* and *Tajjasa*, at the destruction and regeneration of the world, being, as it were, absorbed into *Prâjna*—the Purân's (q. v.) make of 'a' a name of *Vishn'u*; of 'u,' a name of his consort *S'rî*; and of 'm,' a designation of their joint-worshipper; or they see in *a*, *u*, *m* the Triad, *Brahmâ*, *Vishn'u*, and *S'iva*; the first being represented by 'a,' the second by 'u,' and the third by 'm'—each sect, of course, identifying the combination of these letters, or *Om*, with their supreme deity. Thus, also, in the *Bhagavadgîtâ*, which is devoted to the worship of *Vishn'u* in his incarnation as *Krîshn'a*, though it is essentially a poem of philosophical tendencies, based on the doctrine of the *Yoga*, *Krîshn'a* in one passage says of himself that he is *Om*; while, in another passage, he qualifies the latter as the supreme Spirit.—A common designation of the word *Om*—for instance, in the last-named passages of the *Bhagavadgîtâ*—is the word *Pranava*, which comes from a so-called radical *nu*, 'praise,' with the prefix *pra*, amongst other meanings, implying emphasis, and therefore literally means 'eulogium, emphatic praise.' Although *Om*, in its original sense, as a word of solemn or emphatic assent, is, properly speaking, restricted to the Vedic literature, it deserves notice

that it is now-a-days often used by the natives of India in the sense of 'yes,' without, of course, any allusion to the mystical properties which are ascribed to it in the religious works. See also the article OM MANI PADME HŪM.

That there exists no connection whatever, as has been supposed by some writers to be the case, between *Om* and *Amen*, requires scarcely any remark, after the etymological explanations given above; but it may not be without interest to observe that, though the derivation of *Om*, as a curtailment of *av-man*, from *av*, 'protect, save,' is probably merely artificial, and, as stated before, invented to explain the later mystical use of the Vedic word, it seems more satisfactory to compare the Latin *omen* with a Sanscrit *umman*, 'protection,' as derived by the grammarians from *āv* (in the Latin *āve-o*), than to explain it in the fashion of the Roman etymologists: 'Omen, quod ex ore primum elatum est, omen dictum;' or, 'Omen velut orem, quod fit ore augurium, quod non avibus aliove modo fit.' And since *pra-na*, from Sanscrit *nu*, 'praise,' is, like *Om*, used in the sense of 'the deity,' it is likewise probable that *numen* does not come, as is generally believed, from Latin *nu-(ere)*, 'nod,' but from a radical corresponding with the Sanscrit *nu*, 'praise.'

OM MANI PADME HŪM is the 'formula of six syllables' which has acquired much celebrity from the conspicuous part which it plays in the religion of the Buddhists, and especially in that form of it called *Lamaism* (q. v.). It is the first subject which the Tibetans and Mongols teach their children, and it is the last prayer which is muttered by the dying man; the traveller repeats this formula on his journey, the shepherd when attending his flock, the housewife when performing her domestic duties, the monk when absorbed in religious meditation, &c. It is met with everywhere; on flags, rocks, trees, walls, columns, stone-monuments, domestic implements, skulls, skeletons, &c. It is looked upon as the essence of all religion and wisdom, and the means of attaining eternal bliss. 'These six syllables,' it is said, 'concentrate in themselves the favour of all the Buddhas, and they are the root of the whole doctrine . . . ; they lead the believer to re-birth as a higher being, and are the door which bars from him inferior births; they are the torch which illuminates darkness, the conqueror of the five evils;' &c. They are likewise the *symbol* of transmigration; each syllable successively corresponding with, and releasing from, one of the six worlds in which men are reborn; or they are the mystical designation of the six transcendental virtues, each successive syllable implying self-offering (*dāna*), endurance (*kuhānti*), chastity (*s'tla*), contemplation (*dhyāna*), mental energy (*virya*), and religious wisdom (*prajñā*). The reputed author of this formula is the Dhyāni-Bodhisattwa, or deified saint, *Avalokites'wara*, or, as the Tibetans call him, *Padmapān'i* (i. e., the lotus-handed). It would not belong, accordingly, to the earliest stage of Buddhism, nor is it found in the oldest Buddhist works of the north of India or of Ceylon. Its original sense is rather obscure. Some suppose that it means O! (*ōm*), the jewel (*man'i*) in the lotus (*padme*), amen (*hām*); 'the jewel' being an allusion to the saint *Avalokites'wara* himself, and the word '*padme*, or in the lotus,' to the belief that he was born from a lotus. It is probably, however, more correct to interpret the formula thus: 'Salvation (*ōm*) [is] in the jewel-lotus (*man'i-padme*), amen (*hām*);' when the compound word 'jewel-lotus' would mean the saint and the flower whence he arose. If this interpretation be correct, the formula would be originally nothing more than

a salutation addressed to *Avalokites'wara* or *Padmapān'i*; and the mystical interpretation put upon each syllable of it, would then be analogous to that which imparted a transcendental sense to each of the letters of the syllable *Om* (q. v.). Dr Emil Schlagintweit, in his valuable work on *Buddhism in Tibet* (Leipzig, 1863), relates (p. 120) that 'in a prayer-cylinder which he had the opportunity of opening, he found the formula printed in six lines, and repeated innumerable times upon a leaf 49 feet long and 4 inches broad. When Baron Schilling de Canstadt paid a visit to the temple Subulin, in Siberia, the Lamas were just occupied with preparing 100,000,000 of copies of this prayer to be put into a prayer-cylinder; his offer to have the necessary number executed at St Petersburg was most readily accepted, and he was presented, in return for the 150,000,000 of copies he forwarded to them, with an edition of the Kanjur, the sheets of which amount to about 40,000. When adorning the head of religious books, or when engraved upon the slabs resting on the prayer-walls, the letters of the formula are often so combined as to form an anagram. The longitudinal lines occurring in the letters "*man'i padme hām*" are traced close to each other, and to the outer longitudinal line at the left are appended the curved lines. The letter "*om*" is replaced by a symbolical sign above the anagram, shewing a half-moon surmounted by a disc indicating the sun, from which issues a flame. Such a combination of the letters is called in Tibetan *nam chu wangdan*, "the ten entirely powerful (viz., characters, six of which are consonants, and four vowels);" and the power of this sacred sentence is supposed to be increased by its being written in this form. These kind of anagrams are always bordered by a pointed frame indicating the leaf of a fig-tree.—See also E. Burnouf, *Introduction à l'Histoire du Bouddhisme Indien* (Paris, 1844); C. F. Koepfen, *Die Religion des Buddha* (Berlin, 1857—1859); and the works quoted by these authors.

OMAGH (Irish, *Oigh magh*, 'seat of the chiefs'), an ancient town, capital of the county of Tyrone in Ireland, situated on the river Strula, distant 34 miles south from Londonderry, and 110 miles north-west from Dublin, with both which cities it is connected by railway. O. grew up around an abbey founded in the year 792, but is first heard of as a fortress of Art O'Nial in the end of the 15th c., about which time it was forced to surrender to the English, although its possession long continued to alternate between Irish and English hands. It formed part of James I.'s 'Plantation' grants, and was strongly garrisoned by Mountjoy. On its being evacuated by the troops of James II. in 1689, it was partially burned, and a second (accidental) fire in 1743 completed its destruction. But it has been well rebuilt, and is now a neat and prosperous town. Pop. in 1861, 3448, of whom 2150 are Catholics, 731 Protestants of the Established Church, and the rest Protestants of other denominations. O. contains a very handsome court-house, several neat churches (Roman Catholic, Protestant, and Presbyterian), a convent, several partially endowed and national schools, a district lunatic asylum, and the workhouse of the Poor-Law Union of which it is the centre. Its trade is chiefly in brown linens, corn, and agricultural produce.

OMAHA CITY, the capital of Nebraska Territory, U. S., is on the right bank of the Missouri River, opposite Council Bluffs, and 20 miles north of the mouth of the Nebraska River. Besides the government offices, it has a large trade by the rivers, and across the prairies, and will soon be connected by railways with the principal

towns on the Upper Mississippi. Pop. in 1860, 1912.

OMAN, the most eastern portion of Arabia, a strip of maritime territory, extending between Ras-el-Jiboul and Ras-el-Had, bounded on the north-east by the Gulf of Oman, and on the south-west by the deserts of the interior. It is about 370 miles in length; its greatest breadth is 120 miles. At a distance of from 20 to 40 miles from the coast, a chain of mountains runs parallel to it, which reaches in its highest ridge, called *Gebel Achdar* ('Great Mountain'), an elevation of 6000 feet; the average height is 4000 feet. There are a few not inconsiderable streams, and some richly fertile tracts in this region, but the greater part is a waste of sand, with here and there a small oasis, where, however, the vegetation is most luxuriant. Groves of almond, fig, and walnut-trees, tower to an enormous height, overshadowing the orange and citron trees, but are themselves overtopped by the splendid date-palms. The most powerful state of O. is *Muscat* (q. v.).

OMAR, ABÛ-HAFSA-IBN-AL-KHETTAB, the second calif of the Moslems, was born about 581. His early history is little known, but previous to his conversion he was an ardent persecutor of Mohammed and his followers. After his conversion he became as zealous an apostle as he had formerly been a persecutor, and rendered valuable aid to the prophet in all his warlike expeditions. After Mohammed's death, he caused Abu-bekr to be proclaimed calif, and was himself appointed *haujeb*, or prime-minister. Though of a fiery and enthusiastic temperament, he proved a sagacious adviser, and it was at his suggestion that the calif put down with an iron hand the many dissensions which had arisen among the Arabs after the prophet's decease, and resolved to strengthen and consolidate their new-born national spirit, as well as propagate the doctrines of Islam, by engaging them in continual aggressive wars. On the death of Abu-bekr, O. succeeded as calif, and pushed on the wars of conquest with increased vigour. He was summoned to Jerusalem in 637, to receive the keys of that city, and before leaving gave orders to build a mosque, now called by his name, on the site of the temple of Solomon. O. now took the command of a portion of the army, and reduced the other chief cities of Palestine. He then planned an invasion of Persia, which was commenced the same year, and by 642 the whole of what is now known as Persia was subdued. In the meantime the war in Syria was vigorously prosecuted, and the Byzantine armies, repeatedly defeated, at length gave up the contest. In 639, Amr, one of his generals, had invaded Egypt with a considerable force; but such was the prestige of the Arabs, or the incapacity of the lieutenants of the Emperor Heraclius, that this valuable country, with its six millions of people, was reduced under the calif's authority without a single contest, and only two towns, Misr and Alexandria, were even attempted to be defended. (For the story which was till lately believed concerning the destruction of the Alexandrian Library, see ALEXANDRIAN LIBRARY.) Barca and Tripoli were next subdued by Amr. On the north, Armenia was overrun in 641, and the calif's authority now reached from the Desert of Khiva to the Syrtis, an enormous extension in ten years. In 644, O. was assassinated in the mosque of Medina by a Persian slave from motives of revenge. He languished five days after receiving the wound, but refused to appoint a successor, and named six commissioners who were to choose one from themselves. He was buried in the mosque of

Medina, near the prophet and Abu-bekr, and his tomb is still visited by pilgrims.

O. may be called the founder of the Mohammedan power, as from a mere sect he raised it to the rank of a conquering nation, and left to his successor an empire which Alexander the Great might have envied. In him we find a rare combination of qualities, the ardent zeal of the apostle side by side with the cautious foresight and calm resolution of the monarch. His great military talents, and severity to 'obstinate unbelievers,' rendered him formidable to his enemies, and his inexorable justice rendered him no less obnoxious to the more powerful of his subjects, and gave rise to many attempts at his assassination. O. was the founder of many excellent institutions; he assigned a regular pay to his soldiers, established a night-police in towns, and made some excellent regulations for the more lenient treatment of slaves. He also originated the practice of dating from the era of the *Hedjrah* (q. v.). He assumed the title of *Emir-al-mumenin* ('Commander of the Faithful') in preference to that of *Khalifah-raouli-Ilahi*, the ordinary designation; and to the present day his name is held in the greatest veneration by the orthodox or Suni sect of Moslems.

OMAR PASHA, a celebrated Turkish general, was born at Plaski, an Austrian village in the Croatian Military Frontier, in 1806 (according to some authorities, in 1811). His real name was Mikail Lattas, and his father being an officer in the Austrian army, Mikail was educated at the military school of Thurn, near Carlsstadt, where he greatly distinguished himself. He afterwards joined one of the frontier regiments as a cadet, and was employed as secretary by the military inspector of roads and bridges; but having by some breach of discipline rendered himself amenable to punishment, he fled to Bosnia, where he became book-keeper to a Turkish merchant, and embraced Mohammedanism. He was next employed by Hussein Pasha, the governor of Widin, as tutor to his sons; and in 1834 was sent in charge of them to Constantinople, where his beautiful caligraphy gained for him the post of writing-master in the military school. Omar Effendi (as he was now called) was next appointed writing-master to Abdul-Medjid, the heir to the throne, and received the honorary rank of captain in the Turkish army, and the hand of a rich heiress. On his pupil's accession in 1839, O. was raised to the rank of colonel, and sent to Syria to aid in the suppression of disturbances which had broken out in that province, and in 1842 he was appointed military governor of the Lebanon district. The severity of his rule did not hinder the Maronites from desiring to have him as chief of the Mountain; but in the following year he was recalled, received the title of pasha, and was sent, along with Redschid Pasha, against the revolted Albanians. The skill and energy with which he suppressed this insurrection, as well as others in Bosnia and Kurdistan, raised him high in favour with the sultan. Towards the end of 1852 he opened the campaign against the Montenegrins, who were being rapidly subdued, when Austria interfered and compelled a treaty. On the invasion of the Principalities by the Russians (July 1853), O. collected at Schumla an army of 60,000 men to cover Constantinople; but being no less a politician than a soldier, he soon divined that the Russians would not immediately cross the Danube, and accordingly pushed on to Widin, where he crossed the river in presence of the enemy and intrenched himself at Kalafat. Another part of the Turkish army moved down the Danube to Turtukai, near Silistria, crossed the river at that

place, and intrenched themselves at Oltenitza. On November 4, the latter division were attacked by 9000 Russians, whom they totally defeated with a loss of nearly 4000 men and almost all their officers. The Russians also received two severe checks at Kalafat, on January 6 and March 15, 1855. O. kept up the spirit of his troops by occasional successful skirmishes with the Russians, and threw a garrison of 8000 men into Silistria. In the following spring the Russians passed the Danube at two points, and laid siege to Silistria (q. v.), but their assaults were invariably repulsed with severe loss. The Russians then withdrew from the Principalities, and O. entered Bucharest in triumph in August 1854. On 9th February 1855, he embarked for Eupatoria, where, on the 17th of the same month, he was suddenly attacked by 40,000 Russians, who were repulsed with great loss. He was soon afterwards (October 3, 1855) sent to relieve Kara, but arrived too late, and the armistice which followed (February 29, 1856) put a stop to his military career. He was subsequently made governor of Bagdad; but having been accused of maladministration, was banished to Kaarport in 1859. He was recalled in the following year, and in September 1861 was sent to pacify Bosnia and Herzegovina, which were again in insurrection. This being accomplished, he attacked the Montenegrins, who had been the instigators of these rebellions, captured their chief town of Cetinji, overran the country, and reduced it to the condition of a tributary state (9th September 1862). O. is Grand-cross of the Legion of Honour and a Knight of the Russian Order of St Anne.

OMBAY, or MALOEWA (Maluwa), an island between Celebes and the north-west coast of Australia, lies to the north of Timor, from which it is separated by the Strait of Ombay, lat. 8° 8'—8° 28' S., long. 124° 17'—125° 7'. Area, 961 square miles. In 1853 the population amounted to 193,751. The hills of O. are volcanic, and the coasts steep and difficult to approach. The inhabitants are dark brown, have thick lips, flat nose, and woolly hair; appearing to be of mixed Negro and Malay origin. They are armed with the bow, spear, and creese, and live on the produce of the chase, with fish, cocoa-nuts, rice, and honey. A portion of the island formerly belonged to the Portuguese, but since August 6, 1851, it is entirely a Netherlands possession. The Dutch postholder resides at the village of Alor, to which iron wares, cotton goods, &c., are brought from Timor, and exchanged for wax, edible nests, provisions, and other native products. O. has oxen, swine, goats, &c., and produces maize, cotton, and pepper. Amber is also found, and the Boeginese of Celebes import European and Indian fabrics, exchanging them for the produce of the island, which they carry to Singapore.

O'MEARA, BARRY EDWARD, was born in Ireland in the year 1786. Otherwise without claim to be remembered, his name remains notable from his connection with the first Napoleon, whom he accompanied to St Helena as household physician. At the age of 18 he entered the British army as assistant-surgeon. In 1808, being stationed at Messina, he became concerned in a duel as second, under circumstances which must more or less have been held discreditable, as his dismissal from the service by sentence of court-martial was the result. Afterwards he succeeded in procuring an appointment as surgeon in the navy, and as such for some years is certified to have discharged his duties with zeal and efficiency. As it chanced, he was serving with Captain Maitland in the Bellerophon when the Emperor Napoleon (q. v.) surrendered himself to

that officer. During the voyage from Rochefort to Plymouth he was introduced to Napoleon, on whom the impression he produced was favourable, leading to a proposal that he should accompany the emperor into exile as private physician, an arrangement to which he acceded, stipulating that he should retain his rank in the navy, and be permitted to return to it at pleasure. By Napoleon, with whom he remained in daily intercourse at St Helena for about three years, he seems to have been admitted to something more or less like intimacy; and occasionally it might well be, as he says, that the great captive would kill the creeping hours by loose talk with his attendant over the events of his strange life. Of these conversations O'M. naturally enough took notes, which he afterwards published. Meantime he became involved in the interest of Napoleon, in the series of miserable and petty squabbles which he waged with the governor, Sir Hudson Lowe (q. v.). The result of these, as regards O'M., was that in 1818, after a violent altercation with Sir Hudson, he was committed to close arrest, and was authorised by the emperor to resign his post. On his return to England, he addressed a letter to the Admiralty, in which, among other things, he accused Sir Hudson Lowe of intentions against the life of his captive, and even of having, by dark hints to himself, insinuated a desire for his services as secret assassin. For this he was instantly dismissed the service. The accusation was plainly monstrous and incredible. In 1822, after Napoleon's death, O'M. published *Napoleon in Exile*, by which book alone he is now remembered. As conveying to the world the first authentic details of the prison-life of the great deceased, it made on its appearance an immense sensation, and—though for obvious reasons everywhere to be accepted, if at all, with caution—it is still not utterly without interest. The last years of O'M.'s life were passed in obscurity in the neighbourhood of London, where, in 1836, he died.

O'MELET, or OMELETTE, French, a dish chiefly composed of eggs. These are broken, and their contents put into a proper vessel, in which they are whipped into a froth, which is poured into a very clean and dry frying-pan, with the addition of lard or butter to prevent sticking, and then fried carefully, so that the outside is nicely browned. Before frying, one of a number of ingredients may be added to vary the omelette, such as chopped savoury herbs, minced ham or bacon, salt-fish, shell-fish, game, &c. Or sweet omelettes may be made by placing preserved fruits upon them when quite or nearly cooked. The omelette is an excellent dish, and, simple though it be, it requires much skill to prepare it successfully.

O'MEN (for the deriv., see OMI), or PRODIGY (generally said to be from *pro* and *dico*, but more probably from *pro* and *ago*, to lead; hence anything conspicuous, or extraordinary), the name given by the Romans to signs by which approaching good or bad fortune was supposed to be indicated. The terms *Omen* and *Prodigy* were not, however, exactly synonymous; the former being applied rather to signs received by the ear, and particularly to spoken words; the latter to phenomena and occurrences, such as monstrous births, the appearance of snakes, locusts, &c., the striking of the foot against a stone or the like, the breaking of a shoe-tie, and even sneezing, &c. If an omen or prodigy was promised on the part of a god, it was to be interpreted according to the promise; but otherwise, the interpretation was extremely arbitrary. It was supposed that evil indicated as approaching might be averted by various means, as by sacrifice,

or by the utterance of certain magic formulas; or by an extempore felicity of interpretation, as when Cæsar, having fallen to the ground on landing in Africa, exclaimed: 'I take possession of thee, Africa.' Occasionally, it is true, we read of a reckless disregard of omens; as, for example, when P. Claudius, in the First Punic War, caused the sacred chickens, who would not leave their cage, to be pitched into the sea, saying: 'If they wont eat, they must drink.' Still the belief in them was universal, and in general the greatest care was taken to avoid unfavourable omens. The heads of the sacrificial priests were covered, so that nothing distracting might catch their eyes; silence was enjoined at the commencement of every sacred undertaking, and at the opening of the *Ludi*. Before every sacrificial procession ran the heralds, calling on the people to 'pay respect to it,' and admonishing them to cease working till it should have passed, that the priests might not hear unfavourable sounds. At the beginning of a sacrifice, the bystanders were addressed in the words *Favete Linguis* ('Speak no word of evil import'), and the aid of music was sought to drown whatever noises might prove unpropitious. Compare *AUGURIES AND AUSPICES*, and *DIVINATION*. See also Fallati, *Ueber Begriff und Wesen des Rom. Omen* (Tüb. 1836).

The belief in omens has existed in all ages and countries, and traces of it linger even yet in the most civilised communities; in the dread, for instance, that many entertain at sitting down to table in a party of *thirteen*. Not a little of the philosophy of omens is contained in the Scottish proverb: 'Them who follow freits, freits follow;' meaning, that a fatalistic belief in impending evil paralyses the endeavour that might prevent it.

OMENTUM. See *PERITONEUM*.

OMMI'ADES (Omsiades, or Ommeyades), a dynasty (deriving its name from an ancestor, Ommeyah) which succeeded to the Arabian califate on the death of Ali, the fourth calif after Mohammed, and possessed it till superseded by the Abbasides (q. v.) in 750. Moawiyah, the founder of the dynasty, was the son of Abu-Sofiau, who defeated Mohammed at Beder, and his mother was the notorious Hinda. After the death of Othman the third calif, Moawiyah, who was his cousin, claimed the throne, and during the whole of Ali's reign ruled over the western provinces of Syria and Egypt; but it was not till the death of that calif, and the abdication of his son Hassan in 661, that MOAWIYAH'S authority was fully recognised. In that year he transferred the seat of the califate to Damascus; Kufa having been the residence of Ali, and Medina of the first three califs. The Arabs continued to extend their conquests during his reign; the Turks in Khorassan were subdued, Turkestan invaded, and several important acquisitions made in Asia Minor. But besides aggrandising his empire, the calif neglected no means of consolidating it, and partly for this reason he made the succession hereditary, and caused his son YEZID (680—683) to be recognised as his heir. The reigns of Yezid and his successors, MOAWIYAH II. (683) and MERWÂN I., formerly the traitorous secretary of the calif Othman (683—685), are devoid of importance, as their sway extended only over Syria and Palestine. ABDULMELEK (685—705), an able and warlike prince, after a long and varying struggle of eight years, succeeded in rendering himself undisputed ruler of the Mohammedan world (692), but the latter part of his reign was much disturbed by rebellions in the eastern provinces. He was the first calif who interested himself in the promotion of liberal knowledge, by causing the most celebrated

poetical and other works of the Persians to be translated into Arabic; and under his reign coined money was first introduced. It was to this prince that his court-fool related the celebrated fabulous conversation between the owl of Bassora and that of Mosul. Four of his sons, WALID I. (705—716), SULIMAN (716—717), YEZID II. (720—723), and HESHÂM (723—742), successively occupied the throne, and a fifth son, Mosslemah, was, from his great military abilities and zealous devotion to the interests of his brothers, the terror of all their enemies, both domestic and foreign. Under Walid, the Ommiade califate reached the summit of its power and grandeur; Northern Africa (709) and Spain (712), Turkestan (707), and Galatia (710) were conquered; while towards the close of his reign, his empire was extended even to the Indus. The slender structure of the minaret was now for the first time introduced into mosque architecture. OMAR II. (717—720), who, in the justice and mildness of his government, surpassed the whole of the race of Ommeyah, was appointed to succeed Suliman; but having excited discontent among his relatives, by suppressing the formula of malediction, which had hitherto been regularly pronounced at all public ceremonies against Ali and his descendants, he was poisoned. During his reign, Mosslemah had completed the conquest of Asia Minor, and even compelled the Emperor Leo to submit to the humiliation of walking beside his horse through the principal streets of Constantinople itself, and paying a large ransom (equivalent to about £140,000) for his capital. Heshâm, though like his immediate predecessor, fond of pleasure, possessed all the qualities necessary for a sovereign. The Greeks, who still strove for the possession of Asia Minor, were repeatedly defeated: the fierce Turks of Northern Persia and Turkestan, were kept in stern subjection; and the civil affairs of the empire carefully and strictly administered. The death of Mosslemah, the champion of the Ommiade dynasty, seems to have been the signal for insurrection; the descendants of Ali raised the standard of revolt, and no sooner were they subdued than Ibrahim, the fourth in direct descent from Abbas the uncle of Mohammed, solemnly invested the celebrated Abu-Mosslem (stated to be a descendant of Koderz, one of the most distinguished heroes of Firdusi's admired work the *Shah-nameh*) with the arduous duty of enforcing his long-agitated claims to the throne. During this reign the progress of Arab conquest in Western Europe was checked by Charles Martel, who inflicted upon the Arabs a severe defeat at Tours (732), and almost annihilated their army at Narbonne (736). The reigns of WALID II. (742—743), YEZID III. (743—744), and IBRAHIM (744), though of ephemeral duration, were long enough to produce a complete disorganisation of the empire; and though MERWÂN II. (744—750), the next and last calif of the house of Ommeyah, was both an able and politic ruler, and a skilful warrior, the declining fortunes of his family was beyond remedy. Abu-Mosslem, who had published the claims of the Abbasides amidst the ruins of Meru in 747, took the field at the head of a small but zealous band, and carried the black flag of the Abbasides from victory to victory, till before the close of the following year the whole of Khorassan acknowledged his authority. Irak was subdued in 749; and though Ibrahim the Abbasside claimant was seized by Meerwân, and executed in the same year, his brother Abul-Abbas succeeded to his claims, and the unfortunate calif, defeated in two engagements, fled to Egypt (750), whither he was pursued and slain. Abdallah, the uncle of the successful claimant, treacherously invited the remaining members of the house of Ommeyah to a



conference, and ordered a general massacre of them. Two only escaped: the one to the south-east of Arabia, where he was recognised as calif, and his descendants reigned till the 16th century; the other, Abderrahman, to Spain, where he founded the califate of Cordova.

OMMIADES OF SPAIN.—ABDERRAHMAN I. (755—787), on accepting the Spanish throne which was offered him by the Arab chiefs, assumed the titles of *Calif* and *Emir-al-mumenin*, and in spite of numerous revolts, strengthened and extended his power in Spain, till, with the exception of Asturias and the country north of the Ebro, his authority was everywhere acknowledged. His defeat of Charlemagne at Roncesvalles (q. v.) is too widely known to require further notice. He divided his kingdom into six provinces, whose rulers, with the *walis* of the twelve principal towns, formed a sort of national diet. His successors, HESHAM I. (787—796) and AL-HAKEM I. (796—821), were much troubled with internal revolts, under cover of which the Christians in the north-east established the state known as the 'Spanish March.' ABDERRAHMAN II. (821—852) re-established internal quiet, and occupied his subjects with incessant wars against the Christians. These conflicts developed among the Arabs that chivalrous heroism which is found nowhere else in the Mohammedan world. Abderrahman, himself a man of learning, greatly encouraged the arts and sciences, and diffused information among his people; he also attempted, by regulating the laws of succession to property, to constitute his kingdom on a basis analogous to that of other European nations. During his reign Mohammedan Spain was the best governed country in Europe. His successors, MOHAMMED I. (852—880), MONDHAR (880—882), and ABDALLAH (882—912), followed in his footsteps. ABDERRAHMAN III. (912—961), after suppressing some dangerous revolts which had gathered head during his minority, conquered the kingdom of Fez from the Edrisites, and brought a long and exhausting war with the powers of Asturias and Leon to a victorious conclusion. This period is justly termed the golden age of the Arab domination in Spain, for at no period was their power so consolidated, and their prosperity so flourishing. Abderrahman, like his predecessors, was a great encourager of learning, and a poet of no mean ability. He founded schools which far surpassed those in other parts of Europe. His son, AL-HAKEM II. (961—976), was in every way worthy to be his successor, but his premature death was the cause of the downfall of the Ommiades in Spain. HESHAM II. (976—about 1013), a child of eight years, now occupied the throne; but fortunately his mother, Sobeiha, possessed the abilities necessary for such an emergency, and appointed as her son's vizier Mohammed ben Abdallah, surnamed Al-Mansor, who had originally been a peasant. This remarkable man gained the affections of all ranks by his pleasing manners and great abilities; his administration was equally just and judicious, and his encouragement of literature, science, and art alike liberal and discriminating. But it is as a warrior that he is chiefly remembered; he had vowed eternal enmity to the Christians, and in all his numerous expeditions fortune seemed chained to his standard. The lost provinces were recovered; Castile, Leon, and Barcelona were conquered; and Navarre was on the point of sharing the same fate, when a rebellion in Fez compelled him to detach a portion of his force for service in Africa, and the combined armies of the four Christian monarchies, seizing this opportunity, inflicted upon the Arabs a sanguinary defeat in 1001. Mohammed's spirit was completely broken

by this blow, and he died a few days afterwards. With him the star of the house of Ommeyyah set for ever. The rest of Hesham's reign was a scene of disorder and civil war. Pretenders to the califate arose, while the 'walis' of the various provinces set up as independent rulers, and the invasions of the Christians added to the confusion. Hesham finally resigned the throne about 1013; and, with the exception of the brief reign of HESHAM III. (1027—1031), from this time the family of Ommeyyah, which had for more than two centuries so happily and brilliantly governed the greater part of Spain, disappears from history. One remarkable feature of their rule deserves mention, as it contrasts them so favourably with the contemporary and subsequent rulers of Spain, even to the present time, and that is their universal toleration in religious matters.

O'MNIBUS (Lat. *omnibus*, 'for all'), familiarly contracted into 'bus,' is the largest kind of public street conveyance, and is appointed to travel between two fixed stations, starting at certain fixed hours, and taking up or setting down passengers at any point in its route. Vehicles of this sort were first started in Paris in 1662, when it was decreed, by a royal edict of Louis XIV., that a line of *carrosses à cinq sous* ('twopence-halfpenny omnibuses'), each containing eight places, should be established for the benefit of the infirm, or those who, requiring speedy conveyance from one part of the town to another, were unable to afford a hired carriage for themselves; these 'carrosses' were bound to run at fixed hours from one station to another, whether full or empty. The public inauguration of the new conveyances took place March 18, 1662, and was the occasion of a grand fête; and the novelty took so well with the Parisians, that the omnibuses were for some time monopolised by the wealthier classes. However, when the rage for them died away, it was found that those for whose special benefit they were instituted made no use of them, and they, in consequence, gradually disappeared. The omnibus was not revived in Paris till 1827, when it was started in its present form, carrying from 15 to 18 passengers inside, with only the driver above and the conductor behind; and on July 4, 1829, they were introduced into London by a Mr Shillibeer. Shillibeer's conveyances, which for some time afterwards were known as *shillibeers* (an epithet still in common use in New York), were of larger size than the French ones, carrying 22 passengers inside, and were drawn by three horses abreast. The omnibus was introduced into Amsterdam in 1839, and since that time its use has been extended to all large cities and towns in the civilised world. The seats of the omnibus are generally placed lengthwise, and the door behind. The omnibus is under the management of a driver and a conductor. In New York, omnibuses are drawn on street-railways; but this practice, though introduced into several towns of Great Britain, has not met with general approval.

O'MNIUM, a term used at the Stock Exchange to express the aggregate value of the different stocks in which a loan is funded. See M'Culloch's *Dictionary of Commerce*.

OMSK, a town of Western Siberia, in the government of Tobolsk, stands on both banks, and at the confluence of the Om—a river upwards of 200 miles in length—with the Irtish; 2225 miles from St Petersburg. Lat. 54° 59' N., long. 73° 62' E. It was built in 1716, as a defence against the Khirghiz; but is now of no importance as a fortress. It is the centre of government for Western Siberia, is the residence of the governor-general, the centre of the administration of the Siberian Khirghiz, the seat of

the courts of justice, and of the Siberian corps of cadets. It contains 35 manufactories and mining works. Hitherto its commerce has been limited to a trade with the Khirghiz, who drive up their cattle to this place; but its advantageous position on the great post-road and commercial line of traffic from Europe across the whole of Siberia to the Chinese frontier, makes it probable that it will some day become an intermediate station for extensive commercial exchanges. Pop. 17,363.

**OMUL** (*Salmo migratorius*), a fish of the salmon and trout tribe, abounding in Lake Baikal and other waters of the east of Siberia, from which great quantities are sent salted to all the western parts of that country. In size it is rarely more than 15 or 16 inches long. Its flesh is very white and tender. It ascends rivers in shoals for the purpose of spawning.

**ONAGER.** See **ASS.**

**ONAGER.** See **BALISTA.**

**ONÁGRA'CEÆ, ONAGRARIÆ, or GENOTHERA'CEÆ,** a natural order of exogenous plants, consisting chiefly of herbaceous plants, but including also a few shrubs; with simple leaves; axillary or terminal flowers; the calyx superior, tubular, sometimes coloured, its limb usually 4-lobed; the petals inserted into the throat of the calyx, generally equal in number to its segments; the stamens generally four or eight, rarely one or two, inserted along with the petals; the ovary generally 4-celled, sometimes 2-celled; the style threadlike, the fruit a capsule or a berry. There are about 450 known species, natives chiefly of temperate climates, among which are some much cultivated for the beauty of their flowers, particularly those of the genera *Fuchsia*, *Oenothera* (Evening Primrose), *Clarkia*, and *Godetia*. The British genera are *Epilobium* (Willow-herb) and *Circea* (Enchanter's Nightshade). A few species produce edible berries, and the roots of one or two are eatable; but none are of economical importance. The root of *Icnarda alternifolia*, found in the marshes of Carolina, and called *Bowman's Root*, is emetic. Some species of *Jussiaea* are used in dyeing in Brazil.

**ONCOCARPUS,** a genus of trees of the natural order *Anacardiaceæ*. One of the most remarkable trees of the Fiji Islands is *O. atra*, or *O. vitiensis*, a tree about sixty feet high, with large oblong leaves and a corky fruit, somewhat resembling the seed of a walnut; the sap of which, if it comes into contact with the skin, produces a pain like that caused by red-hot iron. The wood is often called Itch-wood, because of the effect produced on persons who ignorantly or incautiously bark it whilst the sap is fresh, even the exhalations causing an intolerable itching and innumerable pustules, with excessive irritation for several days, whilst the effects continue to be unpleasantly felt even for months.

**ONE'GA,** a small town and seaport in the north of Russia, in the government of Archangel, and 90 miles south-west of the city of that name. It stands at the mouth of a river, and on the shore of a gulf of the same name; the latter a branch of the White Sea. Lat. 63° 54' N., long. 38° 7' E. Pop. 1903, employed in connection with the saw-mills of the 'Onega Trading Wood Company.' In these mills, where 400 men are at work, an English steam-engine has recently been erected. About 50 ships leave the port annually for England, with cargoes of deals and timber to the value of £37,000.

**ONEGA, LAKE,** an extensive lake in the north of Russia, government of Olonetz, and, after Ladoga, the largest lake in Europe, is 59 miles in greatest

breadth, and about 150 miles in length. Area 4830 square miles. It is fed by numerous rivers, and receives through the river Wodlo the waters of the lake of that name. Its only outlet is the river Swir, which flows south-west into Lake Ladoga. By means of the Mariinsky system of communication, Lake O. communicates with the Volga, and thence with the Caspian Sea on the south, and with the Dwina, and thence with the White Sea on the north. The clear and beautiful waters of this lake are rich in fish, and embrace many islands. The depth ranges from 550 to 700 feet. The navigation of the lake is dangerous, and commerce is chiefly confined to the Onega Canal, which extends from the town of Vytegra on the river of that name to the river Swir.

**ONEROUS CAUSE,** in Scotch Law, means a pecuniary or valuable consideration.

**ONION** (Fr. *oignon*, from Lat. *unio*, a pearl, but found in Columella, signifying a kind of onion), the name given to a few species of the genus *Allium* (q. v.), and particularly to *A. cepa* (Lat. *cepa*), a biennial bulbous-rooted plant, with a swelling stem, leafy at the base, tapering fistular leaves, a reflexed spathe, a large globose umbel, usually not bifurcated, the lobes of the perianth obtuse and hooded, not half as long as the stamens. The bulb is simple—not composed of cloves, like that of garlic; and in the common variety is solitary, shewing little tendency to produce lateral bulbs. The native country of the O. is not certainly known, some supposing it to be India and some Egypt, in both of which it has been cultivated from the most remote antiquity. The part chiefly used is the bulb, but the young leaves are also used, and young seedlings drawn from onion beds are a very common ingredient in soups and sauces in the beginning of summer. These are known in Scotland as *syboes* (evidently another form of the word *Cibol*). In warmer climates, the O. produces a larger bulb, and generally of more delicate flavour, than in Britain; and is more extensively used as an article of food, being with us, whether fresh or pickled, generally rather a condiment. In Spain and Portugal, a raw O. is often eaten like an apple, and often with a piece of bread forms the dinner of a working-man. The O. is, however, very nutritious. It contains a large quantity of nitrogenous matter, and of uncrystallisable sugar; with an acrid volatile sulphurous oil, resembling oil of garlic. The oil of the O. is dissipated by boiling, so that boiled onions are much milder than raw onions. In Britain, onions are sown either in spring or in August. Great fields of them, as of other favourite vegetables, are cultivated for the London market; and large quantities of onions are also imported from more southern regions. The Bermudas are celebrated for their onions. The O. loves a rich light soil and a dry subsoil. The transplanting of onions is often practised, especially of onions sown in autumn, which are transplanted in spring, and when these are placed so that the small bulbs are on the surface of the ground, and surrounded with decayed manure, very large bulbs are obtained. The frequent stirring of the soil is of great advantage. The bulbs are taken up when the leaves decay, and after being dried in the open air or in a loft, may be kept for a considerable time.—The **POTATO O.**, also called the **EGYPTIAN or GROUND O.**, is a perennial variety which produces offset bulbs at the root, like the shallot; but the bulbs are much larger than those of the shallot, and have less of the flavour of garlic, although stronger than those of the common onion. It is sometimes said to have been introduced into Britain from

Egypt by the British army in 1805, but erroneously, as it was cultivated in some parts of Britain long before. It is in very general cultivation among the peasantry in some parts of Scotland.—The PEARL O. is a similar variety, with much smaller bulbs.—The TREE O. is also generally regarded as a variety of the common onion. It produces bulbs at the top of the stem, the umbels becoming viviparous.—Onions are similar to Garlic (q. v.) in medicinal properties, but milder. As a condiment or article of food, they agree well with some stomachs and stimulate digestion, but are intolerable to others. Roasted onions with oil make a useful emollient and stimulating poultice for suppurating tumours. The use of onions stimulates the secreting organs.—The CIBOL or WELSH O. (*A. fistulosum*), a native of Siberia, cultivated in Britain, but more generally in Germany, has a perennial fibrous root, with no bulb, very fistular leaves, and a 3-cornered ovary. It is useful as supplying tender green leaves for culinary use in the beginning of spring, like the chive, and somewhat earlier in the season. It is much larger than the chive, but its use is similar.

ONISCUS. See WOODLOUSE.

ONKELOS, the supposed author of an Aramaic version (Targum) of the Pentateuch. The name seems a corruption from that of Akilas, one of the Greek translators of the Old Testament (see VERSIONS). The translation, said to be by O., is, in its present shape at least, probably the work of the Babylonian schools of the 3d and 4th centuries A.D. At first orally transmitted, various portions of it began to be collected and written down in the 2d c., and were finally redacted about the time mentioned. The history of the origin and growth of Aramaic versions in general will be treated under *Targum* (VERSIONS). The idiom of O. closely resembles that of Ezra and Daniel. The translation itself is executed in accordance with a sober and clear, though not a slavish exegesis, and keeps closely to its text in most instances. In some cases, however, where the meaning is not clear, it expands into a brief explanation or paraphrase, uniting the latter sometimes with Haggadistic by-work, chosen with tact and taste, so as to please the people and not to offend the dignity of the subject. Not unfrequently it differs entirely from the original, as far, e. g., as anthropomorphisms and anthropopathies—anything, in fact, which might seem derogatory to the Deity—are concerned. Further may be noticed a repugnance to bring the Divine Being into too close contact, as it were, with man, by the interposition of a kind of spiritual barrier (the 'Word,' 'Shechinah,' 'Glory') when a conversation, or the like, is reported between God and man. Its use lies partly in a linguistic, partly in a theological direction; but little has been done for its study as yet. Notwithstanding the numerous MSS. of it extant in almost all the larger libraries of Europe, and in spite of the grossly incorrect state of our current printed editions, no critical edition has ever been attempted.

ONOBRYCHIS. See SAINTFOIN.

ONOMACRITUS, a celebrated religious poet of ancient Greece, lived at Athens in the time of the Peisistratids. He collected and expounded—according to Herodotus—the prophecies or oracles of Musesus (q. v.), but is said to have been banished from the city by Hipparchus, about 516 B.C., on account of interpolating something of his own in these oracles. He then, we are told, followed the Peisistratids into Persia, and while there was employed by them in a very dishonourable way. They got him to repeat to Xerxes all the ancient sayings that seemed to favour his meditated

invasion of Greece. Some critics, among whom is Aristotle, have inferred from a passage in Pausanias that O. is the author of most of the so-called Orphic hymns. More certain, however, is the view which represents him as the inventor of the great Orphic myth of Dionysus Zagreus, and the founder of Orphic religious societies and theology. Pausanias states that 'Onomacritus established orgies in honour of Dionysus, and in his poems represented the Titans as the authors of the sufferings of Dionysus.' See Müller's *Geschichte der Griech. Literatur bis auf das Zeitalter Alexander's* (Breslau, 1841); Grote's *History of Greece*, &c.

ONOMATOPŒIA, the Latin form of the Greek word *onomatopœia*, means literally the making or invention of names, and is used in philology to denote the formation of words in imitation of natural sounds, as in *cuckoo*, Lat. *cuculus*); *pee-wit*, Scan. *pee-weip*, Dutch, *kiewit*; *cock*; *clash*, *rap*, *lap*, *quack*, *rumble*, *whizz*, *clang*. Such words are sometimes called *onomatopœias*; more properly, they are *onomatopœian*, or formed by *onomatopœia*.

In a more extended sense, the term is applied to the rhetorical artifice by which writers (chiefly poets) seek, through the choice and arrangement of words, to make the 'sound,' throughout whole phrases and sentences, 'an echo to the sense,' as in Homer's well-known *poluphloisotoi thalasses*, expressive of the breaking of waves upon the seashore; or where Tennyson makes the sea

Roar rock-thwarted under bellowing caves.

The occurrence of so many obviously onomatopœian words in all known languages, suggests the question, whether the same principle may not have been concerned in producing the original germs or roots of the great bulk of words. There is little hope that the question will ever be conclusively settled either way; for the changes of time have made it, in most cases at least, impossible to say what the first form and signification of a root were; but the balance of arguments seems in favour of the affirmative answer. 'The action of the mind,' as it has been expressed, 'produced language by a spontaneous repercussion of the impressions received.' Now, the articulate sound first affixed in this way to an object or an action as its sign cannot be conceived as arbitrary; nor is there any mysterious and inherent correspondence between any one conception of the mind, and a particular articulate sound. The sound uttered must have been suggested by something connected with the object or action itself; and by what more naturally than by the inarticulate sound which the object or action itself emits?

The chief objection to this theory is, that if the first words were merely reproductions of natural sounds, the same natural objects would have had the same names all the world over. To which it is answered, that the mind in its first efforts at naming did not seek an exact reproduction of the sound, but a suggestive imitation; primitive words were not echoes, but 'artistic representations.' Now, the sounds of nature are not simple, but composite. Like other concrete phenomena, they present a variety of aspects; and according as one or another aspect seemed the most prominent to the observer, a different vocal sound would suggest itself as the appropriate symbol. Thus, when Professor Max Müller argues (*Science of Language*, Lond. 1861) that if the 'bow-wow' theory, as he nicknames it, were true, men would have everywhere spoken of a *moo*, as is done in the nursery, and not of a *cow*; it seems a valid answer to say, that the Indian *gu*, the Teut. *kuh* (Eng. *cow*), and the Græco-Lat. *bou-*, are really as suggestive imitations of the animal's

ONTARIO—OOLITE.

actual voice as *moo*. To take a more striking instance: few words differ more in sound and aspect than the Eng. *thunder* (Ger. *donner*, Lat. *tonitru*, Fr. *tonnère*) does from the Mexican name for the same thing, *tlalatnizel*, and yet it would be difficult to say which is the more suggestive of the natural sound.

It is no doubt true that the great bulk of names are derived from roots having a general predicative power; but this by no means excludes the principle of onomatopoeia. Thus, to take one of the instances adduced by Professor Müller himself, that of *raven* or *crow* (Sans. *kāra*, Lat. *corvus*, Gr. *korōnē*); this is derived from the root *ru* or *bru*, which means to cry or call, and the bird was called a *kāra*, or *crow*, not in imitation of his voice, but because he was 'a shouter, a caller, a crier.' The name might have been applied to many birds, but it became the traditional and recognised name of the crow.' But how came the articulation *ru* or *bru* to be chosen to convey the general meaning of crying or calling; may we not suppose that it was suggested by the voice of birds of the crow kind, whose notes are most markedly cries or calls to their fellows, as distinguished from singing? Once adopted in this particular case, it would naturally be extended to any kind of cry or call, from the harshest to the softest.

ONTARIO, the easternmost and smallest of the five great lakes of North America, lies in 43° 10'—44° 8' N. lat., and 76° 30'—80° W. long. At its south-west corner it receives the waters of the upper lakes by the Niagara, and at its north-east corner it issues into the St Lawrence; which for some distance below is called the Lake of the Thousand Isles. Its surface, which varies a few feet with the seasons, is about 330 feet below that of Lake Erie and 234 feet above tide-water. Its bottom, therefore, must be considerably lower than the level of the Atlantic, as it is in some places 600 feet deep. It is 190 miles long, 55 in its widest part, and about 480 in circumference. Sufficiently deep throughout for vessels of the largest tonnage, it has many convenient and thriving ports, of which the chief are Kingston, Port Hope, Cobourg, Toronto, Hamilton, on the Canadian shore, and Oswego, Sackett's Harbour, Port Genesee in the United States. Its navigation has been facilitated by the erection of 15 light-houses on the American side, and 13 on the Canadian; while it is connected with Lake Erie by the Welland Canal, with the Erie Canal and New York by the Oswego Canal, and by the Rideau Canal with the Ottawa. Lake O. is subject to violent storms, and it is probably owing chiefly to the constant agitation of its waters that it freezes only for a few miles from the shore. The shores of Lake O. are generally very flat, but the Bay of Quinte, a long crooked arm of the lake, which stretches about 50 miles, possesses some attractive scenery. Burlington Bay, on which Hamilton lies, is a large basin, almost entirely enclosed by a natural, but strangely accumulated bank of sand, which forms a beautiful drive for the citizens.

ONTOLOGY. See METAPHYSICS.

ONUS PROBANDI, i. e., the burden of proof, is often a difficult question in litigation; but as a general rule, the plaintiff who institutes the suit is bound to give proof of the allegations on which he relies. There are many nice and technical rules on the subject, both in suits and actions, which are too minute to be here stated.

ONYX, an agate formed of alternating white and black, or white and dark-brown stripes of chalcedony. More rarely, a third colour of stripes occurs. The finest specimens are brought from

India. O. is in much esteem for ornamental purposes. The ancients valued it very highly, and used it much for cameos. Many of the finest cameos in existence are of onyx. The name O., however, appears to have been applied by the ancients more extensively than it now is, and even to striped calcareous alabaster, such as is now called Onyx Marble. The *Sardonyx* of the ancients is a variety of O., in which white stripes alternate with stripes of a dark-red variety of carnelian, called *sard* or *sarda*. It is one of the rarest and most beautiful kinds of O., and is more valued than carnelian.

ONYX MARBLE, a very beautiful material, which first came into general notice in this country in 1862, when the French made a large display of it in the International Exhibition. It is a stalagmitic formation, which was discovered by the French in making roads in the province of Oran in Algeria. It is a translucent limestone, containing traces of magnesia and carbonate of iron; its specific gravity is 2.730. The quarries are worked by a company, and the artistic workmen of France are turning it to good account, in the manufacture of very beautiful ornamental works.

O'OJE'N. See UJEN.

O'OLITE (Gr. egg-stone), a variety of limestone, often very pure calcareous spar, distinguished by its peculiar structure, being composed of grains connected together by a calcareous cement; the whole much resembling the roe of a fish. The grains are not unfrequently hollow. Many oolites, as in the south of England, are excellent building-stones. There is no important mineralogical difference between O. and *Pisolite*, or *Pea-stone*. O., as a geological term, is extended far beyond its mineralogical and original signification.

OOLITE or JURASSIC GROUP (in Geology), an extensive and important series of strata of Secondary age, underlying the Chalk formation, and resting on the Trias. In Britain they received the name Oolite, because in the district where they were first examined and described by Dr W. Smith, the limestones contained in them had an oolitic structure (see foregoing article). The name Jurassic has been given to them on the continent, because the range of the Jura Mountains in the north-west of Switzerland is almost entirely composed of them. The strata of the group have been arranged in the following order. The maximum thickness of each division is given in feet:

UPPER OOLITE.		Feet.
1. Purbeck Beds,	. . . . .	200
2. Portland Beds,	. . . . .	170
3. Kimmeridge Clay,	. . . . .	600
		— 970
MIDDLE OOLITE.		
4. Coral Rag,	. . . . .	190
5. Oxford Clay,	. . . . .	600
		— 790
LOWER OOLITE.		
6. Cornbrash and Forest Marble,	. . . . .	80
7. Great Oolite and Stonesfield Slate,	. . . . .	160
8. Fuller's Earth,	. . . . .	160
9. Inferior Oolite,	. . . . .	250
		— 630
LIAS.		
10. Upper Lias,	. . . . .	300
11. Marlstone,	. . . . .	300
12. Lower Lias,	. . . . .	600
		— 1100
Total,	. . . . .	3490

It is apparent from this table that the Oolitic rocks consist of three extensive clay deposits, each of which forms the basis of a smaller and variable set of sands and limestones; the Upper

Oolites resting on the Kimmeridge Clay, the Coral Rag on the Oxford Clay, and the Lower Oolite on the Lias.

1. The Purbeck beds, unlike the other oolitic rocks, are chiefly freshwater deposits. Though lithologically they are very similar throughout, the peculiarities of the contained fossils have caused them to be grouped into three series—the Upper, Middle, and Lower. The Upper Purbecks are purely freshwater, containing beds of limestone and shale, which abound in shells of lake and river mollusca and cypridea. The stone called Purbeck Marble, formerly so extensively used in the ornamental architecture of English churches and other buildings, belongs to this division; it consists of the shells of *Paludina*, held together by a somewhat argillaceous paste. The Middle Purbecks are partly freshwater, and partly brackish or marine. The 'cinder-bed,' composed of a vast accumulation of shells of *Ostrea distorta*, occurs in this section, and near it is the narrow layer from which Mr Beckles recently obtained the remains of several mammalia. The Lower Purbecks are chiefly freshwater, with some intercalated brackish or marine beds, and one or two old vegetable soils called by the quarrymen 'dirt-beds,' which contain the stems of Cycadaceae and Coniferous plants. 2. The Portland beds consist of oolitic and other limestones interstratified with clays, and passing below into sands and sandstones, from which the well-known building-stone is obtained, of which St Paul's and many of the principal buildings in London are built. 3. The Kimmeridge Clay is generally a dark-gray bituminous shale, with intercalated beds of sand, calcareous grit, and layers of septaria. The dark shale in some places passes into an impure brown shaly coal. 4. The Coral Rag contains, as its name implies, an abundance of corals, in bluish limestone beds mixed with layers of calcareous grit. The Solenhofen lithographic stone, with its beautifully preserved and varied fossil remains, belongs to this division. 5. The Oxford Clay is a dark-blue or blackish clay without corals, but having a large number of beautifully preserved Ammonites and Belemnites. Beds of calcareous sandstone, called Kelloway Rock, occur in its lower portion. 6. The Cornbrash consists of thin beds of cream-coloured limestone, with sandstones and clays, and the Forest Marble (so named from Wychwood Forest) is composed of an argillaceous limestone, with numerous marine fossils, blue marls and shales, and yellow silicious sand. At Bradford, Wiltshire, the Forest Marble is replaced by a considerable thickness of blue unctuous clay. 7. The Great Oolite is composed of shelly limestones, sandstones, and shelly calcareous sandstones, and the Stonesfield Slate is a slightly oolitic shelly limestone, which splits into very thin slabs, erroneously called 'slates;' it is remarkable for the remains of terrestrial reptiles and mammalia found in it. The Bath Oolite, a celebrated building-stone, belongs to this division. 8. The Fuller's Earth group is a local deposit found near Bath; it consists of a series of blue and yellow shales and marls, some of which have properties fitting them for the use of the fuller. 9. The Inferior Oolite is composed of a series of beds of pisolitic and shelly limestones, brown marl, and brown sandy limestone, all abounding in fossils. 10. The Lias (q. v.) is a great clay deposit. It is divided into the Upper and Lower Lias, which consist of thin beds of limestone scattered through a great thickness of blue clay, and, separating these two groups, the Marlstone, or calcareous or ferruginous sandstone. The Lias abounds in beautifully preserved fossils.

The oolite occupies, in England, a zone nearly

thirty miles in breadth, extending across the country from Yorkshire to Dorsetshire. In Scotland, patches of lias and Oxford clay occur in the islands of Mull and Skye, and on the western shores of the mainland, and beds belonging to the lower oolite are found at Brora, on the east coast of Sutherland, which contain an impure coal. The only oolite rocks in Ireland are a few isolated patches in Antrim, which abound with the fossils of the lower lias. On the continent, rocks of this age occur in Germany and France, but they have been most extensively studied in the Jura Mountains, which, though having a height of 6000 feet, are entirely composed of oolite and cretaceous rocks. The strata are greatly bent and contorted, and as they approach the Swiss Alps, the great mass of which is also formed of oolite, they become completely metamorphosed into clay slates, mica schists, gneiss, and crystalline limestones. Beds of oolite have been noticed in Cutch, in India. In Australia similar beds occur on the western coast, and probably some of the coal-beds of New South Wales, Victoria, and Tasmania belong to the oolite. In both North and South America, fossils, apparently of oolitic age, have been found; but these deposits require to be more exactly examined.

The oolite is remarkable for the abundance of its fossils, and is in this respect in striking contrast to the immediately preceding Triassic and Permian periods. The several freshwater deposits, and the ancient vegetable surfaces, contain the remains of a considerable number of plants. Ferns still abound, and with them are associated species that are evidently related to the living genera *Cupressus*, *Araucaria*, and *Zamia*.

Corals abound in several of the beds. The brachiopods are the only division of the mollusca that is not largely represented. The conchifers and gasteropods shew a great number and variety of new genera, which are nearer the forms of the present day than those that preceded them. But the remarkable feature of molluscan life is the enormous development of the cephalopoda. Whole beds are almost entirely made up of their shells. No less than 600 species of ammonites have been described, chiefly from the rocks of this period, and the belemnites were also very numerous. The crinoids have become scarce, but are replaced by star-fishes and sea-urchins. The freshwater beds contain the remains of many insect forms. The heteroceraltailed fish give way to the more modern homocericals, and the true sharks and rays make their appearance, though the old cestracions are still represented by some survivors. The characteristic feature of the oolitic period was its reptiles. The land, the sea, and the air had each their fitting inhabitants of this class. The various species of pterodactyles, some not larger than the bat, others surpassing, in the stretch of their membranous 'wing,' the size of the largest living bird, were the terrors of the air; while their allies, the monster ichthyosaurs and plesiosaurs, held the mastery of the waters; and the huge megalosaurs, some not less than 30 feet in length, trod the earth. The few mammalian remains hitherto found, have a special interest from their antiquity, being the first evidence of this high order of animals on the globe. They belong, apparently, to marsupial animals; one species is, however, supposed by Owen to have been a hoofed and herbivorous placental mammal.

OONALA'SKA. See UNALASKA.

OORALSK. See URALSK.

OORFA. See URFA.

OORGA. See URGA.

**OORI** or **LIMPOPO RIVER**, an important river system of South-Eastern Africa, rising in lat. 26° S. in the high plateau called the Magaliesberg, which bounds the basin of the Orange River to the north, and with its different branches, the Mariqua, Ngotnane, Lipalula, &c., draining the regions now known as the Transvaal Republic. Flowing first to the north, the O. gradually turns to the east, and is supposed to reach the Indian Ocean at Imhambane, in lat. 24°, after a course of 950 miles, and draining a basin of not less than 250,000 square miles, yet, like other South African rivers, it is not navigable, and the very position of its embouchure is not yet very satisfactorily ascertained. The basin of this river occupies the depression which exists between the watershed of the Orange River on the south, and the south tributaries of the Zambesi on the north.

**OOROOMFYAH**, town and lake. See **URUMFYAH**.

**OOSTERHOUT**, a flourishing town in the Netherlands, province of North Brabant, six miles north-north-east from Breda, is situated in a well-wooded, fertile district of country. Pop. (1863) 8844, of whom 8457 belonged to the Roman Catholic Church. Much business is done in the grain and cattle markets. There are 14 tanyards, several flourishing beer-brewing establishments, 5 potteries, and 4 brick-works. O. has a grammar-school, and a nunnery, the inmates of which employ themselves in teaching the children of the poor. The handsome town-house and great Roman Catholic Church stand on the market-place, which is shaded with linden-trees.

Near O. is an extensive wood, where are the ruins of the house of Stryen or Oosterhout, formerly the residence of the Counts of Stryen, under whose jurisdiction were not only the town and barony of Breda, but also the marquisate of Bergen-op-Zoom.

**OOTACAMUND**, the chief town in the Neilgherry Hills, and the great sanitarium of Southern India. These hills are situated between 11°—12° N. lat. and 76°—77° E. long. The elevation of O. is 7400 feet above the sea; the mean temperature being about 49°, the maximum 77°, and the minimum 38°. The average rainfall is 45 inches. Its distance is only about 350 miles from Madras, and it is easy of access, as the railway now conveys the traveller to the foot of the Hills. The other stations on the Neilgherries are Coonoor, Kottagherry, and Jacketalla, or Wellington. In the last place, there is a fine range of barracks for European troops. The number of European settlers on these hills is increasing. There are thriving plantations of tea and coffee, and the cinchona or quinine plant.

**O'PAH**, or **KING-FISH** (*Lampris guttatus* or *L. lura*), a fish of the Dory (q. v.) family (*Zeldue*), occasionally found in the British seas, but more common in more northern regions, and found not only in the Atlantic and Arctic Oceans, but also in the Pacific, as on the coasts of China and Japan. It is of an oval form, greatly compressed, with small thin scales, the mouth small and destitute of teeth, a single dorsal fin much elevated in front and extending almost to the tail. This fish attains a large size, being sometimes five feet long and 150 pounds in weight. It is brilliantly coloured; the upper part of the back and sides rich green, reflecting purple and gold in different lights, the lower parts yellowish-green, round yellowish-white spots above and below the lateral line; all the fins bright vermilion. The flesh is much esteemed; it is red like salmon, and is said to resemble it in flavour.

**O'PAL**, a mineral which differs from quartz in containing from 5 to 13 per cent. of water, its only other essential constituent being silica, although a little alumina, oxide of iron, &c., is often present. It is never found crystallised, and does not exhibit a crystalline structure like quartz. It has a conchoidal fracture, and is very easily broken. There are many varieties, which pass into one another, so that their precise limits cannot be defined, from which has arisen no little confusion of names. The finest kind is called *Precious O.* or *Noble O.*, and sometimes *Oriental Opal*. It is semitransparent or translucent, usually of a bluish or yellowish white colour, yellow by transmitted light, and exhibits a beautiful play of brilliant colours, owing to minute fissures which refract the light. It is much valued for setting in rings, brooches, &c., and is polished with a convex surface, never cut into facets, both because of its brittleness, and because its play of colours is thus best exhibited. The ancients valued opals very highly. The Roman senator Nonius preferred exile to giving up an O. to Mark Antony. This O. was still to be seen in the days of Pliny, who ascribes to it a value equal to more than £100,000 sterling. The imperial cabinet of Vienna contains the most celebrated O. now known to exist. It is five inches by two inches and a half. The finest opals are almost all brought from Kaschan in Hungary, where they are found disseminated in a trachytic conglomerate. They are mostly very small, but even a very small O., if really beautiful, is worth four or five pounds; and the price increases very rapidly with increase of size. Precious O. is found also in Saxony, in South America, &c. When the colours are not equally diffused, but in detached spots, jewellers call it *Harlequin Opal*. There is a dark or blackish variety, apparently tinged by oxide of iron, which occasionally exhibits very beautiful reflections, and is then much prized. *Girasol* (q. v.) and *Cacholong* (q. v.) are varieties of opal. What lapidaries call *Prime d'Opal* is clay-porphry, or other stone containing many small grains of opal. It is cut into slabs, and made into boxes and other ornamental articles; the stone which contains the opals being often artificially blackened by boiling in oil, and afterwards exposing to a moderate heat.—*Common O.* is semitransparent, white, yellow, green, red, or brown, and does not exhibit any play of colours. It is not a rare mineral, and is chiefly found in clay-porphry. *Semi-opal* is more opaque. *Wood O.* is a petrification, and exhibits the form and structure of wood, the place of which has been taken by the siliceous mineral. *Hyalite* and *Menilite* are varieties of opal.

**OPEN-BILL** (*Anastomus*), a genus of birds of the Heron family (*Ardeidae*), natives of the East Indies and of Africa, remarkable for the structure of the bill, the mandibles being in contact only at the base and tip, with a wide interval between their edges in the middle. They frequent the sea-coast and rivers, and prey on fish and reptiles. One species is well known in India as the Coromandel Heron.

**OPEN DOORS, LETTERS OF**, in Scotch Law, mean a writ authorising a messenger to pound or seize goods deposited in lockfast-places, and to break open the locked doors in order to effect the seizure. See **HOUSE**.

**OPERA**, a musical drama, in which music forms an essential part, and not a mere accessory accompaniment. As in the higher drama, poetry supercedes the prose of ordinary life, so in the opera, with perhaps as great artistic right, the language of music is introduced at a considerable sacrifice of probability. The libretto or words are, in the

## OPERA.

modern opera, a peg on which to hang the music, rather than the music an accessory to the written drama. The component parts of an opera are recitatives, duets, trios, quartets, choruses, and finales, accompanied throughout by an orchestra, and the whole is preceded by an instrumental Overture (q. v.). Recitative is declamation, which, in its succession of musical sounds and rhythm, strives to assimilate itself as much as possible to the accents of speech, and therefore does not entirely conform to musical rhythm. The accessories of scenic representation are also present, and a Ballet (q. v.) is also frequently introduced. In some of the German operas, and in the French *opéra comique*, spoken dialogue without music takes the place of recitative. Among the different varieties of the opera enumerated are the great opera or *opéra seria*, of a dignified character; the romantic opera, embracing an admixture of the grave and lively; the comic opera, or *opéra buffa*; as well as many intermediate varieties.

The idea of the opera may in part have arisen from the Greek drama, which possessed, to a considerable extent, the operatic character: the choral parts were sung, and the dialogue was delivered in a sustained key, probably resembling operatic recitative more than ordinary speech. The earliest extant example of any composition resembling the lyric drama of the moderns is Adam de la Halle's comic opera of *Li gieux (le jeu) de Robin et de Marian*, composed in the 13th c., the music of which is wonderful for its date. The next appearance of anything like opera is in the 16th century, when various musical dramas were composed in the madrigalesque style. An opera composed by Zarlino is said to have been performed at Venice when Henry III. passed through that city on his way from Poland to France. About the same time, a pastoral called *Dafne*, written by the poet Rinucci, was set to music by Peri; and the same poet and musician conjointly produced the lyric tragedy of *La Morte di Euridice*, which was represented at the theatre of Florence in 1600. Claudio Monteverde, one of a society of amateurs, known as the 'Florentine Academy,' who devoted themselves avowedly to the study and revival of Greek music, soon afterwards produced his *Orfeo*, a 'favola di musica,' in whose performance an orchestra of no fewer than 36 performers was called into requisition, most of the instruments being, however, only used in twos or threes, and never more than ten at a time. From these beginnings, the opera advanced into one of the permanent institutions of Italy—a development of music at first strongly opposed in character and style to the music of the church. With the progress of music, and the perfecting of the musical instruments which went to form the orchestra, the lyric drama began, towards the middle of last century, to approach its present character. Of the innumerable Italian operas of last century, only Cimarosa's *Matrimonio Segreto* retains its place on the stage. Cherubini, the first of the more modern school, after producing his *Quinto Fabio* at Milan, became naturalised in France: Rossini, who succeeded him in Italy, is the greatest name in the Italian opera. Nothing can exceed the deliciously fresh character of the best known operas of this now aged musician, *Il Barbiere di Siviglia*, *Otello*, *La Gazza Ladra*, *Semiramide*, and *Guillaume Tell*. Next to them rank the equally well-known works of Bellini, *Norma*, *La Sonnambula*, and *I Puritani*; *Lucia di Lammermoor*, *Lucrezia Borgia*, and *L'Elisir d'Amore*, the three *chefs-d'œuvre* of Donizetti, alone rivalling them in public estimation. A newer school of opera has recently sprung up in Italy, more grand if less fresh, of which the chief

master is Verdi, whose *Ernani*, *Nabuchodonosor*, *I Lombardi*, *Otello*, *Rigoletto*, *Il Trovatore*, *La Traviata*, and others have attained immense popularity in Italy, and wherever the Italian opera has been naturalised.

From Italy the opera was introduced into Germany, where, more scientific and less sensuous than in Italy, it flourished in opposition to national as well as ecclesiastical music. Germany divides with Italy the honour of perfecting orchestral music and the opera. Glück, educated in Italy, produced his *Orfeo* in Vienna, and then went to Paris, where the French adopted him as we did Handel. Mozart was the first composer of operas for the modern orchestra; *Idomeneo*, *Il Seraglio*, *Le Nozze di Figaro*, *Don Giovanni*, and *Zauberflöte* are his principal operatic works, unsurpassed by anything that has succeeded them. The most important German operas composed since their date are *Fidelio* by Beethoven; *Der Freischütz*, *Euryanthe*, and *Oberon* by Weber; *Faust* by Spohr; and the gorgeous operas of Meyerbeer, *Robert le Diable*, *Les Huguenots*, and *Le Prophète*, and *L'Étoile du Nord*. *Les Huguenots*, notwithstanding its involving enormous difficulties in representation, keeps its place in every operatic theatre in Europe. Wagner, the chief exponent of a more recent school arrogating to itself the title of the 'music of the future,' or rather 'work of art of the future,' has produced the opera of *Tannhäuser*, which enjoys at present a large share of public favour in Germany.

In France, the earliest operatic representation of which we have any record was in 1582. About 1669, the Abbot Perrin obtained from Louis XIV. the privilege of establishing an opera in the French language at Paris, and in 1672 the privilege was transferred to Lulli, who may be considered the founder of the French lyrical drama. Lulli's popularity continued during a long period, and was only put an end to by the rise of the German Glück, who, naturalised in Paris, produced there his *Iphigénie en Aulide* and *Alceste*. It is greatly through Glück's influence that the modern French opera has become what it is, a composite work combining French, German, and Italian elements. Its best-known productions include Méhul's *Joseph*, Halévy's *Juive*, Auber's *Masaniello*, *Fra Diavolo*, and *Diamans de la Couronne*, and Gounod's recent opera of *Faust*. The Italian opera, introduced in Paris in 1646 by Cardinal Mazarin, and superseded in 1670, was revived in the beginning of the present century, and has since flourished side by side with the national opera of France.

The possibility of a national English opera seems first to have been shewn by Purcell, who, through Humphreys, had learned much from Lulli. His music to Dryden's *King Arthur* is very beautiful, though kept throughout subordinate to the business of the drama. *The Beggar's Opera*, as set to music by Dr Pepusch, was a selection of the airs most popular at the time. It has retained its place on the stage, as also has Dr Arne's *Artaxerxes*, a translation from Metastasio adapted to music rich in melody. The importation of the Italian opera put a stop, for a time at least, to the further development of an opera in England. In 1706, *Arsinoé*, with English words adapted to Italian airs, was performed at Drury Lane. In 1710, *Almahide*, wholly in Italian, was performed exclusively by Italian singers at the Haymarket Theatre; and a succession of attempts of the kind ended in the permanent establishment of the Italian opera. The arrival of Handel in England decided the future progress of the opera. That great master was during the greater part of his life an opera composer and opera manager. He composed for the London stage no fewer than 44

OPERA—OPERA-GLASS.

operas, German, Italian, and English. These now forgotten operas were of course not the complex compositions of a later period, which could not have been performed in the then imperfect state of orchestral instruments. A recitative was set to music nearly as fast as the composer could put notes on paper, and the songs were accompanied in general by only one violin and bass, the composer sitting at the harpsichord, and supplying what was wanting. From Handel's time onwards, the opera flourished as an exotic in Britain, the singers being foreign, and the works performed being either Italian or occasionally German or French. Attempts crowned with some measure of success have latterly been made to establish an opera of a national character in England. Balfe's *Bohemian Girl* and *Rose of Castile*, are the best works which this school has produced, and have attained with other operas by Balfe, Wallace, and Macfarren, a considerable measure of popularity. See Hogarth's *Memoirs of the Opera* (London, 1851).

**OPERA-GLASS** (Fr. *lorgnette*, Ger. *theater-periscopiv*). This is a double telescope, which is used for looking at objects that require to be clearly seen rather than greatly magnified, such as adjoining scenery and buildings, the performers of a theatre or opera, &c. It is from its use at an opera that it derives its name. The opera-glass is short and light, and can be easily managed with one hand. Its small magnifying power (from 2 to 3 at the most), and the large amount of light admitted by the ample object-glass, enable it to present a bright and pleasing picture, so that the eye is not strained to make out details, as in telescopes of greater power, which generally shew a highly magnified but faint picture. It allows the use of both eyes, which gives to the spectator the double advantage, not possessed by single telescopes, of not requiring to keep one eye shut, a somewhat unnatural way of looking, and of seeing things stand out stereoscopically as in ordinary vision. The opera-glass is in consequence the most popular of telescopes, and requires almost no art in its use.

The opera-glass is the same in principle as the telescope invented by Galileo. It consists of two lenses, an object lens, and an eye-lens. The object-lens is convex, and the eye-lens concave. They are placed nearly at the distance of the difference of their focal lengths from one another. Fig. 1 represents the action of the telescope; *o* is the object-lens, and *e* the eye-lens, and *oe* is the axis of the instrument. The object-lens would form

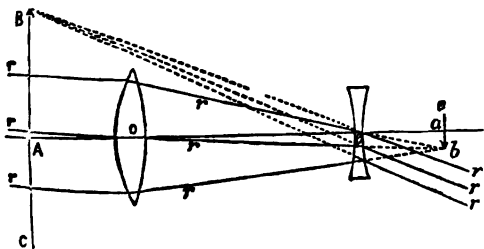

Fig. 1.

an image, *cab*, of the object looked at at or near its focus, but the eye-lens intervening, converts the light converging to *cab* to light diverging apparently from an object in front, *CAB*. To shew more clearly the changes which the light undergoes, the course of a pencil of rays proceeding from the top of an object is traced. The ray proceeding from the top of the object to the centre of the lens, *o*, makes an angle, *roA*, with the axis. This

is the same as the angle *aob*; and either of these angles gives half the angle under which the object is seen to the unaided eye. The three extreme rays, *r, r, r*, of the pencil appear in the figure nearly parallel, although they come from a point. The object is at a considerable distance from the object-glass or eye, so that it is not possible in so limited a figure to shew their divergence. After passing through the object-lens, the three rays proceed to the point *b*, in the image which the object-lens would form at *cab*, if no eye-lens were there. This image, as shewn in the figure, is inverted, and would be seen as such if the eye were placed about ten inches (the distance of distinct vision) behind it. The three rays in question do not reach the point *b* in consequence of the eye-lens intervening, and their course onwards to that point, after passing the eye-lens, is shewn by dotted lines. The actual course, after passing the second lens, is shewn again by the full lines, *r, r, r*, which to the eye placed immediately behind the eye-lens appear to proceed from the point *B* in front. As the light comes from *B* in the same direction as it comes from the actual point in the object, the image is erect. What holds for the point *B*, holds for every point in the image and object. To find the magnifying power, it is necessary to join *Be* and *Ce*, and produce the lines thus formed to *b* and *c*. As the eye is placed immediately behind the eye-lens, the angle under which the magnified object is seen is the angle *Bec*, which is equal to *ceb*. Now, the angle under which the object itself is seen at *o* or at *e*—for the slight difference has no effect at the distance at which objects require to be seen by a telescope—is twice the angle *roA*, or which is the same thing, the angle *cob*. The ratio of the angle *ceb* to the angle *cob*, which is the magnifying power, is easily seen to be the same as that of the line *oa* to the line *ae*. But *oa* is the focal length of the object-glass, and *ae* is the focal length of the eye-glass, so that the magnifying power of the instrument is the number of times the focal length of the eye-glass is contained in that of the object-glass. The longer, therefore, the focal length of the object-lens, or the shorter the focal length of the eye-lens, the greater the magnifying power. This may be practically expressed thus: the flatter the object-lens, and the hollower the eye-lens, the more are objects magnified by the glass. The magnifying power may be found with sufficient accuracy by looking at an object with one eye through the tube and the other eye unaided, and so handling the glass that the magnified image seen by the one eye is superposed on the object seen by the naked eye, when a comparison of their relative sizes can be easily made. For great magnification, the instrument requires to be greatly lengthened—a condition inconsistent with its use as an opera-glass. In addition, a high magnifying power is attended with the disadvantage that the field of view, or amount of object or objects seen, becomes too limited. On screwing out the instrument, it will be seen that objects increase in size as the instrument is lengthened, but that the picture becomes more and more limited, shewing that a large power and a large field are incompatible. The opera-glass need not be set to the same precise point as is necessary with ordinary terrestrial telescopes, as the lengthening or shortening of the instrument does not produce so decided an effect on the divergence of the light; the change of divergence, caused by screwing the opera-glass out or in, is so slight as not much to overstep the power of adjustment of the eye, so that an object does not lose all its distinctness at any point within the range of the instrument. There is, however, a



particular point at which an object at a certain distance is best seen.

Fig. 2 gives a section of the opera-glass, which is sufficiently simple to require no further description. The two telescopes are identical in construction,

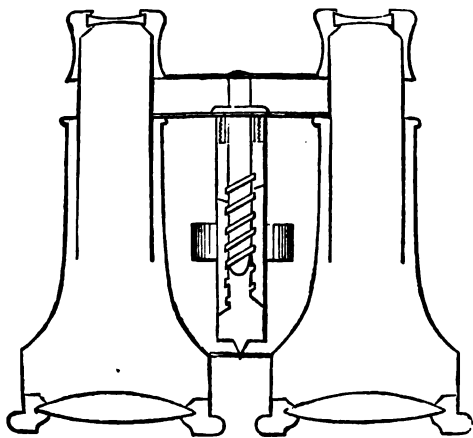

Fig. 2.

and are placed parallel to each other. The blending of the two images is easily effected by the eyes, as in ordinary vision. Opera-glasses have now come into such demand, that they form an important article of manufacture, of which Paris is the great seat. So largely and cheaply are they produced in Paris, that it has nearly a monopoly of the trade. They may be had from 2s. 6d. to £6 or £7. The cheapest opera-glasses consist of single lenses, those of the better class have compound achromatic lens. A very ordinary construction for a medium price is to have an achromatic object-lens, consisting of two lenses and a single eye-lens. In the finest class of opera-glasses, which are called *field-glasses*, both eye-lenses and object-lenses are achromatic. Plössl's celebrated field-glasses (Ger. *Feldstecher*) have twelve lenses, each object-lens and eye-lens being composed of three separate lenses.

**OPERCULUM** (Lat. a lid), a term used in botany chiefly to designate the lid or covering of the mouth of the urn or capsule (*theca*) which contains the spores of mosses. Before the ripening of the spores, the operculum is generally concealed by the *calyptra*; but after the calyptra has been thrown off, the operculum itself also generally falls off, leaving the peristome visible, and the mouth of the urn open. In some cases the operculum does not fall off, and the urn opens by valves.

In Zoology, the term operculum is chiefly employed to denote the covering which many gasteropod molluscs form for the mouth of their shell. It is attached to the back of the foot of the mollusc. In some it is calcareous, forming a shelly plate; in some it is horny; whilst gasteropods very nearly allied to those which possess it, are destitute of it altogether. The operculum increases in various ways, so as to present in different genera great diversity of structure, concentric, spiral, unguiculate, &c.

**OPHICEPHALUS**, a genus of fishes, of the family *Anabasidae* (q. v.), sometimes regarded as constituting a distinct family *Ophicephalidae*, because there is a mere cavity for retaining water to supply the gills, and no pharyngeal lamina, and because of the long eel-like form and the flattened head, which is covered with large scales. Some of them are common in the fresh waters of the East Indies, are

often found among wet grass, often travel from one pool to another, and are capable of subsisting for a long time in half-dried mud, descending into it when the pools dry up. The *CORA-MOTA* or *GACHUA* of India (*O. gachua*) is much used for food by the natives, although generally rejected by Europeans on account of its very snake-like appearance. It is very tenacious of life, and is not only brought to the Indian markets alive, but is cut to pieces whilst still living for the convenience of buyers.

**O'PHICLEIDE** (Gr. *ophis*, serpent, and *kleis*, key), a musical wind-instrument of brass or copper, invented to supersede the Serpent (q. v.) in the orchestra and military bands. It consists of a conical tube, terminating in a bell like that of the horn, with a mouthpiece similar to that of the serpent, and ten ventages or holes, all stopped by keys like those of the bassoon, but of larger size. Ophicleides are of two kinds, the bass and the alto. The bass ophicleide offers great resources for maintaining the low part of masses of harmony. Music for it is written in the bass clef, and the compass of the instrument is from B, the third space below the bass staff, to C, the fifth added space above it,



including all the intervening chromatic intervals. The alto ophicleide is an instrument of very inferior quality, and less used. Its compass is also three octaves and one note. The music for it is written in the treble clef, and an octave higher than it is played. Double bass or monster ophicleides have sometimes been used in large orchestras, but the amount of breath which is required to play them has prevented their coming into general use.

**OPHI'DIA**. See SERPENTS.

**OPHIOGLOSSEÆ**, a suborder of *Filices* or Ferns (q. v.), consisting of a few rather elegant little plants with an erect or pendulous stem, which has a cavity instead of pith, leaves with netted veins, and the spore-cases (*thecae*) collected into a spike formed at the edges of an altered leaf, 2-valved, and without any trace of an elastic ring. They are found in warm and temperate countries, but abound most of all in the islands of tropical Asia. Several species are European, and two are British, the *Botrychium* (q. v.) *lunaria*, or Moonwort, and the Common Adder's-tongue (*Ophioglossum vulgatum*), which was at one time supposed



Ophicleide.



Adder's-Tongue (*Ophioglossum vulgatum*).

## OPHIR—OPHTHALMIA.

to possess magical virtues, and was also used as a vulnerary, although it seems to possess only a mucilaginous quality; on account of which some of the other species have been employed in broths. It is a very common plant in England, its abundance in some places much injuring pastures.

**OPHIR**, a region frequently mentioned in the Old Testament, and from which the ships of Solomon, fitted out in the harbours of Edom, brought gold, precious stones, sandal-wood, &c. The voyage occupied three years. Where Ophir was situated, has been a much, in fact, a superfluously disputed question. It was probably either on the east coast of Africa about Sofala, or in Arabia, or in India, but in which of the three countries is doubtful. Huet, Bruce (the traveller), the historian Robertson, M. Quatremère, &c., are in favour of Africa; Michaelis, Niebuhr (the traveller), Gosellin, Vincent, Winer, Fürst, Knobel, Forster, Crawford, and Kalisch, of Arabia; Vitringa, Reland, Lassen, Ritter, Bertheau, and Ewald, of India. Josephus, however, it should be said, placed O. in the peninsula of Malacca, and his very respectable opinion has been adopted by Sir J. Emerson Tennent in his work on Ceylon. For a complete discussion of the point, see Karl Ritter's *Erkundung* (vol. xiv. 1848), 80 octavo pages of which are devoted to Ophir. According to Ritter, who accepts the view of Lassen, O. was situated at the mouth of the Indus.

**OPHIR**, called by the Malays, Gunong Pasaman, a volcanic mountain in the highlands of Padang, island of Sumatra, lies in 0° 4' 58" N. lat., and 99° 55' E. long.; the eastern peak, called Telaman, attains the height of 9939 feet above the sea. The western peak is called Pasaman. The numerous inhabitants have cleared off forest and brought under cultivation large tracts of land on the slopes of O., and its base is studded with villages. The O. districts are most beautiful, and the lofty waterfalls, contrasting with the bright-green foliage of the mountain, highly picturesque.

**OPHISURUS.** See SNAKE-EEL.

**OPHITES** (Gr. *ophitai*, 'serpent-brethren,' from *ophis*, a serpent), a sect of Gnostics (q. v.), who while they shared the general belief of dualism, the conflict of matter and spirit, the emanations, the Demiurgos, and other notions common to the many subdivisions of this extraordinary school, were distinguished from all by their peculiar doctrine and worship connected with their *ophis* or serpent. The O., like most other Gnostics, regarded the Demiurgos, or the Jehovah of the Old Testament, with great abhorrence, but they pursued this notion into a very curious development. Regarding the emancipation of man from the power and control of the Demiurgos as a most important end, they considered the serpent who tempted Eve, and introduced into the world 'knowledge' and revolt against Jehovah, to have been the great benefactor of the human race. Hence their worship of the serpent. Some of the details of their system were very strange. We may instance their singular attempt to engraft 'Ophism' on Christianity; their seeking, as it were, to impart to the Christian Eucharist an Ophite character, by causing the bread designed for the Eucharistic sacrifice to be *licked by a serpent*, which was kept in a cave for the purpose, and which the communicants kissed after receiving the Eucharist (*Epiph. Hor.* 37, v. 5). Our information, however, regarding them is very meagre, and comes chiefly from antagonistic sources. The O. originated in Egypt, probably from some relation to the Egyptian serpent-worship, and spread thence into Syria and Asia Minor.

Offshoots of this sect are the Cainites. See CAIN and SETHITES.

**OPHTHALMIA** (derived from the Greek word *ophthalmos*, the eye) was originally and still is sometimes used to denote inflammation of the eye generally, but it is at the present time usually restricted to designate inflammatory affections of the mucous coat of the eye, termed the *conjunctiva*.

There are several important and distinct varieties of ophthalmia (in the restricted sense of the word) which require special notice.

**Catarrhal Ophthalmia.**—Its leading symptoms are redness of the surface of the eye (the redness being superficial, of a bright scarlet colour, and usually diffused in patches), sensations of uneasiness, stiffness and dryness, with slight pain, especially when the eye is exposed to the light; an increased discharge, not of tears, except at the beginning of the attack, but of mucus, which at first is thin, but soon becomes opaque, yellow, and thicker; pus (or matter, as it is popularly termed) being seen at the corner of the eye, or between the eyelashes along the edges of the lids, which it glues together during the night. The disease results in most cases from exposure to cold and damp, and is very apt to be excited by exposure to a draught of air, especially during sleep. It is popularly known as a *cold* or a *blight* in the eye. With regard to treatment, the patient should remain in rooms of a uniform temperature, and should at once take about five grains of calomel, followed by a black draught. The eye should be frequently bathed with poppy decoction, lukewarm or cold as the patient prefers. If the affection does not readily yield to these measures, a drop of a solution of nitrate of silver (four grains of the nitrate to an ounce of distilled water) should be let fall into the eye twice or thrice a day. It usually causes a smarting sensation for about ten minutes, after which the eye feels much easier than it did before the drop was applied. The adhesion of the eyelids in the morning may be avoided by smearing their edges at bedtime with a little spermaceti ointment.

**Purulent ophthalmia** differs from catarrhal ophthalmia in the severity of its symptoms, and in its exciting causes. It is a violent form of inflammation of the conjunctiva; is accompanied with a thick purulent discharge on the first or second day of its commencement, and is very apt to occasion loss of vision. There are three remarkable varieties of this affection, called respectively (1) purulent ophthalmia of adults, or Egyptian ophthalmia, or contagious ophthalmia; (2) gonorrhoeal ophthalmia; and (3) purulent ophthalmia of newly-born children. (1) *Purulent ophthalmia of adults* begins with the same symptoms as catarrhal ophthalmia, but in a very exaggerated form. The conjunctiva rapidly becomes intensely red, and soon appears raised from the sclerotic by the effusion of serum between them, projecting around the cornea, which remains buried, as it were, in a pit. Similar effusion takes place beneath the mucous membrane lining the eyelids, causing them to project forwards in large livid convex masses, which often entirely conceal the globe of the eye. These symptoms are accompanied by severe burning pain, great headache, fever, and prostration. When the disease is unchecked, it is liable to produce ulceration or sloughing of the cornea, with the escape of the aqueous humour and protrusion of the iris; and even when these results do not follow, vision is often destroyed by permanent opacity of the cornea. It is a common disease in India, Persia, and Egypt; and in consequence of its having been imported from the last-named country into England by our troops in the beginning of the present century, it got the name of

**Egyptian ophthalmia.** Some idea of its prevalence and of its danger may be formed from the facts (1) that two-thirds of the French army in Egypt were labouring under it at the same time, and (2) that in the military hospitals at Chelsea and Kilmainham there were, in December 1810, no fewer than 2317 soldiers who had lost the sight of both eyes from this disease. Until after the war in Egypt, the disease was unknown in Europe. Since that time it has not unfrequently broken out in this country—not only among troops, but in schools, asylums, &c. The disease is unquestionably contagious, but there are good reasons for believing that it often arises, independently of contagion, from severe catarrhal ophthalmia under unfavourable atmospheric and other conditions; and that having so originated, it possesses contagious properties. *Gonorrhœal ophthalmia* arises from the application of gonorrhœal discharge or matter to the surface of the eye; and hence is most common in persons suffering from the disease from which this variety obtains its specific name. It is, moreover, not unfrequently occasioned by the common but disgusting practice, adopted by the poorer classes, of bathing the eyes in human urine, under the idea that by this procedure they strengthen the sight. In its symptoms, it is almost identical with ordinary purulent ophthalmia. The *purulent ophthalmia of children* usually begins to appear about the third day after birth. It is a very common affection, and its importance is apt to be overlooked until it has made considerable progress. If the edges of the lids appear red and glued together, and if the eye, when the lids are separated, shews redness and swelling of the conjunctiva, there is no doubt of the nature of the disease, which, if not checked, progresses in much the same way as in adults. It is, however, much more amenable to treatment, and with proper care the sense of sight is seldom impaired, provided the disease has not extended to the cornea before medical aid is sought. Of the treatment of purulent ophthalmia in these various forms, we shall say nothing more than that it must be left exclusively to the medical practitioner, whose advice should be sought as soon as there is the slightest suspicion of the nature of the case.

There is one more form of this disease which is of very common occurrence, and has received the various names of *strumous* (or *scrofulous*), *pustular*, and *phlyctenular ophthalmia*. It is intimately connected with the scrofulous constitution, and is most prevalent in children from four to ten or twelve years of age. The most prominent symptom is extreme intolerance of light, the lids being kept spasmodically closed. When they are forcibly separated, a slight vascularity, usually stopping at the edge of the cornea, is observed, and at or about the line of separation between the cornea and sclerotic small opaque pimples or pustules appear. The treatment consists (1) in improving the general health by due attention to the secretions, and the subsequent administration of tonics (such as quinia and cod-liver oil), and change of air; and (2) in local applications, such as solution of nitrate of silver, or wine of opium, dropped into the eye, or stimulating ointments (such as dilute citrine ointment) smeared over the edges of the lids at bedtime. This form of disease, being dependent on constitutional causes, is often very obstinate, and is always liable to recur. It is not unfrequently attended with the annoying complication of a skin disease, known as *crusta lactea*, on the cheeks, in consequence of the irritation caused by the flow of scalding tears. The crusts or scabs are easily removed by a poultice or warm-water dressing, after which the part must be bathed by a lotion, consisting of a drachm of

oxide of zinc in four ounces of either pump or rose water.

**OPHTHALMOSCOPE, THE,** is an instrument recently invented for the purpose of examining the deep-seated structures of the eye, and for detecting disease in them. In its simplest form, it is merely a concave circular mirror, of about ten inches focus, made of silvered glass or polished steel, and having a hole in the centre; and with it there is supplied, as a separate piece of apparatus, a convex lens an inch and a half in diameter, with a focal length of about two and a half inches, set in a common eye-glass frame, with a handle three inches long. The patient (his pupil having been previously dilated by the application of a drop of solution of atropine) is made to sit by a table in a dark room, with a sliding argand lamp placed by the side of his head, with the flame on a level with the eye, from which it is screened by a little flat plate of metal attached to the burner. The following description of the mode of using the instrument, and of the parts brought into view by it, is borrowed from the article on this subject contributed by Mr Haynes Walton to the last edition of Druitt's *Surgeon's Vade Mecum*: 'The operator sits directly in front, and holding the instrument close to his eye, and a little obliquely to catch the light from the lamp, he commences, at the distance of about 18 inches from the patient, to direct the reflection on the eye. When this is got, the convex lens must be held at a distance of two and a half inches from the eye, and the focusing commenced by moving it slowly backwards and forwards. When the light fairly enters the eye, a reddish glare appears; and as it is focused, an orange-red or orange-yellow is seen; then the blood-vessels of the retina come into view. The retina itself presents a whitish aspect, through which the choroid is more or less discernible. The entrance of the optic nerve should now be sought. The way to discern it is to make the patient look inward. It appears as a white circular spot, in the centre of which are the central vein and artery of the retina, giving off six or eight branches.' This optic disc is the most important part to be observed; but a thorough ophthalmoscopic examination will reveal structural differences, not only in it, but in the retina, choroid, and vitreous humour, and will reveal cataract in its early stage. In short, the ophthalmoscope is now as essential in the diagnosis of diseases of the deep-seated parts of the eye as the stethoscope is in the diagnosis of thoracic diseases.

**OPIE, JOHN, R.A.,** was born at the village of St Agnes, seven miles from Truro, Cornwall, in May 1761. His father, a master-carpenter, wished him to follow the same trade, but his bias for art was strong; and his attempts at portrait-painting having attracted the notice of Dr Wolcott, afterwards celebrated as Peter Pindar, he had the advantage of his advice in the practice of the art, and his exertions in procuring him employment. And at length, in 1780, he was taken to London by Dr Wolcott; and immediately came to be acknowledged by the fashionable world as the 'Cornish Wonder.' This tide of good-fortune soon ebbed, but not before O. had realised a moderate competency. The loss of popular favour, however, only served to bring out more strongly those points in O.'s character on which his reputation mainly rests, viz., manly independence and strong love of art. He stooped to no device to retain fashionable patronage, but calmly and unremittently entered on that department of painting which, according to the notions of his time, was the only style of high art, viz., historical or scriptural subjects, executed on a large scale. His pencil was employed by Boydell in his well-meant

and magnificent scheme to elevate British art; he also painted a number of works in the illustration of Bowyer's English History, Macklin's Poets and Biblical Gallery, and other similar undertakings. His pictures of the 'Murder of James I. of Scotland,' 'The Slaughter of Rizzio,' 'Jephtha's Vow,' 'Presentation in the Temple,' 'Arthur and Hubert,' 'Belisarius and Juliet in the Garden,' are his most noted works. O. was elected an Associate of the Royal Academy in 1786, and Academician in the following year. He devoted part of his time to various literary efforts tending to the illustration of art: these were chiefly the 'Life of Reynolds' in Dr Wolcott's edition of Pilkington's *Dictionary of Painters*; a letter in the *North Briton*, recommending the formation of a National Gallery, reprinted as *An Inquiry into the Requisite Cultivation of the Fine Arts in Britain*; lectures on art, delivered at the Royal Institution, which, though listened to with great attention by a select and fashionable audience, do not seem to have been satisfactory to himself, as he declined to continue them. When Fuselli, on being appointed keeper, resigned the professorship of painting, O. was appointed to that office; and the four lectures which he delivered—he died before completing the course—bear the stamp of practical experience and shrewd observation. O. was twice married. He obtained a divorce from his first wife; but his second, well known as one of the most popular novelists of the day, appreciated his high character, which she set forth, after his death, in a memoir published along with his lectures. He died somewhat suddenly in his house, St Bernard Street, Oxford Street, April 9, 1807, and was buried in the crypt of St Paul's, near the grave of Reynolds.

**OPINICUS**, one of the fabulous creatures known in Heraldry, with the head and neck of an eagle, the body of a lion, wings, and a short tail like that of a camel. Such a monster, with wings endorsed or, was the crest of the company of barber-surgeons of London.

**OPINION OF COUNSEL** is the technical name for the advice given by a barrister or advocate. The attorney or solicitor writes a statement of facts, called 'a case' in England, and 'a memorial' in Scotland, which ends by asking certain queries, and the answer written by the counsel is his opinion. A counsel is not liable for any damages caused by his giving a wrong opinion though the result of gross ignorance, this being one of the privileges of counsel.

**OPITZ, MARTIN**, a famous German poet, was born December 23, 1697, at Bunzlau, in Silesia. He received an education of the highest kind; and after some time spent at the court of the Duke of Liegnitz, he accepted, in 1622, an invitation by Bethlen Gabor, Prince of Transylvania, to teach Philosophy and the *Humaniora* at Weissenburg; but disliking the rudeness of the country, he soon returned to the court of the Duke of Liegnitz. In 1624, his first poems were published, and in the same year his work *Von der deutschen Poeterei*, in which he laid the foundation of a system of German poetics. In 1625, he went to Vienna, where, on account of an elegy on the death of an archduke, he received a laurel crown from the hands of the emperor, Ferdinand II. In 1626, he became secretary, although a Protestant, to the Burggraf Karl Hannibal of Dohna, a distinguished Roman Catholic and imperialist, and was employed in various transactions with foreign courts. In 1629, the emperor raised him to the rank of nobility. After the death of the Burggraf of Dohna, in 1633, he returned to the courts of Liegnitz and Brieg. About this time he published *Vesuv*, a didactic

poem, and his *Trostgedicht in Widerwärtigkeit des Kriegs*, the best of his poems, which were followed by an opera called *Judith*, a translation of the *Antigone* of Sophocles, and a translation of the Psalms. In 1638, he was appointed Secretary and Historiographer to Ladislaus IV. of Poland. But in the midst of his days, and when he had attained to fame and prosperity, he was cut off by the plague at Dantzic, August 20, 1639. O. was more honoured by his contemporaries than almost any other poet ever was. German poetry, which had been neglected and despised, began again to be esteemed and cultivated. The popularity of O., and his relations with the chiefs of the Roman Catholic party, led to the adoption, throughout the whole of Germany, of the form given to the German language by Luther, which had previously obtained general acceptance only in the Protestant states. His poetry is characterised by careful attention to language and metre, and by reflection rather than by brilliant fancy or deep feeling. There are several complete editions of his works (3 vols. Breslau, 1690; 3 vols. Amst. 1646; and 3 vols. Frankfurt and Leipzig, 1724).

**OPIUM**, one of the most valuable of medicines, is the dried juice of the unripe capsules of a species of Poppy (q. v.), *Papaver somniferum*, sometimes called the Common Poppy, and sometimes the White Poppy, although the latter name is really appropriate only to one of its varieties. The plant is probably a native of some of the warmer parts of Asia, although it is now common in cultivated and waste grounds throughout all the south and middle of Europe, and is occasionally found in Britain. It is an annual, varying in height from one to six feet, erect, branched, of a glaucous green colour, with ovate-oblong sessile leaves, the stem and leaves generally smooth, the branches terminated by large flowers on long stalks, the capsules globose or roundish-ovate and smooth. There are two principal varieties cultivated for the opium which they yield, which have been regarded by some botanists as distinct species; the one (*Papaver somniferum*) having generally red or violet-coloured flowers, numerous flower-stalks rising together, globose capsules opening by a circle of pores under the persistent stigma, and black seeds; the other (*P. officinale*) having white flowers, solitary flower-stalks, the capsules somewhat ovate, the circle of pores almost wanting, the seeds white. The former variety is generally cultivated in the mountainous parts of the north of India, the latter in the plain of Bengal, where the poppy-fields are described by Dr Hooker as resembling green lakes studded with white water-lilies. The cultivation of the poppy for the sake of opium is carried on in many parts of India, although the chief opium district is a large tract on the Ganges, about 600 miles in length and 200 miles in breadth, which has been divided by the East India Company into two agencies, that of Behar and that of Benares, the central factory of the former being at Patna, and that of the latter at Ghazee-pore. The poppy is also extensively cultivated for opium in the Asiatic provinces of Turkey, in Egypt, and in Persia. Opium of very good quality is also produced, although not to any considerable amount, in some parts of Europe, and even in Britain. It is sometimes alleged that a much warmer climate than that of Britain is requisite for the profitable production of opium, but the chief fault of the climate seems rather to be the frequency of wet weather. Very fine specimens of opium have been produced, and the produce per acre has been found amply remunerative; but a great difficulty is experienced in obtaining labour at a moderate rate for a few days only at a time

## OPIUM.

and when the experiment is conducted on a small scale, only for a few hours daily. This difficulty was much felt in an experiment, otherwise most successful, which was made at Edinburgh, by Mr Young, a surgeon, who about the year 1830 obtained 56 lbs. of opium from one acre of poppies, and sold it at 36s. a lb. It was of excellent quality. His mode of cultivation was similar to that usual in India. The seed being sown in spring on a rich soil, the plants were kept clear of weeds, and when they had flowered and produced capsules, incisions were made in the capsules, and the exuded juice collected as described below. The capsules vary from the size of a hen's egg to that of the fist. In India, the poppy flowers in the end of January and beginning of February.

The poppy requires for its profitable cultivation a rich soil, and in India is generally sown in the neighbourhood of villages where manure can be easily obtained. The soil ought to be fine and loose when the seed is sown. The subsequent cultivation consists chiefly in thinning and weeding. Irrigation is practised. Mild moist weather, with night-dews, is deemed most favourable during the time of the collection of the opium. Very dry weather diminishes the flow of the juice, and much rain is injurious.

The opium poppy is cultivated for other purposes besides the production of opium, concerning which see POPPY.

Opium, as a commercial article, is of great importance, exceeding indeed that of any other drug in use, and the cultivation of the opium poppy (*Papaver somniferum*) in British India forms a most extensive branch of agriculture, and the collection and preparation of the drug itself employs a large number of persons in the Patna, Malwa, and Benares districts of Bengal. Indeed during the whole existence of the East India Company, the production of this drug was of the first importance; its employment as a habitual narcotic, as well as a medicine amongst all the eastern nations, demands an enormous supply. The seed is sown in India in



Fig. 1.

the beginning of November; it flowers in the end of January, or a little later; and in three or four weeks after, the capsules or poppy-heads are about the size



Fig. 2.

it off with a kind of scoop, called a *sitoocha*, and transferred to an earthen vessel, called a *kurrace*,

hanging at the side of the collector. When this is full, it is carried home and transferred to a shallow open brass dish, called a *thullee*, and left



Fig. 3.

for a time tilted on its side, so that any watery fluid may drain out; this watery fluid is called *puasewah*, and is very detrimental to the opium unless removed. It now requires daily attendance, and has to be turned frequently, so that the air may dry it equally, until it acquires a tolerable consistency, which requires three or four weeks; it is then packed in small earthen jars, and taken to the *godowns* or factories; here the contents of each jar are turned out and carefully weighed, tested, valued, and credited to the cultivator. The opium is then thrown into vast vats, which hold the accumulations of whole districts, and the mass being kneaded, is again taken out and made into balls or cakes for the market.

This is a very important operation, and is conducted in long rooms, the workmen sitting in rows, carefully watched by the overseers to insure the work being carefully performed. Before each workman (fig. 4) is a tray, and within easy reach is placed the



Fig. 4.

*tagar*, a tin vessel for holding as much opium as will make three or five balls. On the tray is another basin containing water, and a smaller tray; on this tray stands a brass cup, into which the ball or cake is moulded, also a supply of thin layers of poppy petals, formed by laying them out overlapping each other, and pressing them upon one another; these are prepared by women in the poppy-fields, and with these is a cup filled with a sticky fluid called *iewah*, made from opium of inferior quality. The operator

## OPIUM.

begins his work by taking the brass cup and placing on its bottom one of the cakes of poppy petals, which he smears over with the *lewah*; then adds other cakes of petals to overlap and adhere to the first, until the cup is lined and a coat of petals is thus formed for the opium, of which he takes the exact quantity as near as he can guess, works it into a ball, and places it in the basin, so that the lining of petals encloses it and sticks to it, in consequence of the *lewah* smeared on the inner side of the thin cakes of petals. Other petals are put on the upper part of the ball, and the whole gathered round it, forming a case about as thick as a bank-note. Each man's work for the day is kept by itself, and after having been duly registered, is taken to a vast drying-room (fig. 5), where the balls are placed in tiers on lattice-

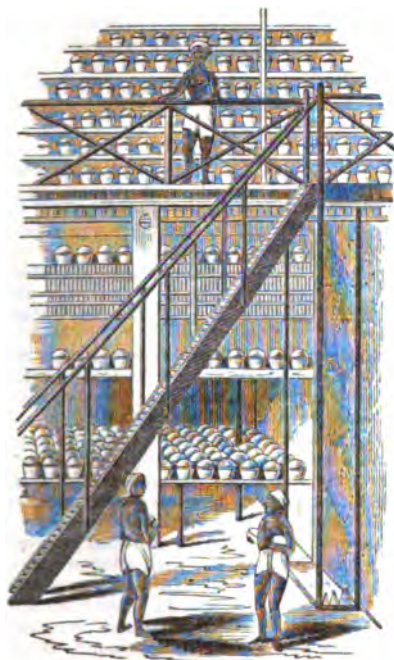

Fig. 5.

work racks, and are continually turned and examined by boys, to keep them from insects and other injuries. After being fully dried, these balls are packed in chests for the market.

The manufacture of opium is carried on to the greatest extent in India, but large quantities are also made in Turkey, and this latter is considered the best in quality. It is also made at Trebizond in Persia, and in Egypt; occasionally it has been produced in Germany, France, and England. Of the Indian opium there are several qualities, as Bengal, Patna or Benares opium, Garden Patna, Malwa, fine Malwa, Cutch, and Kandeish opium.

The quantity exported from India in 1860 was 53,681 chests, or 3929 tons, the value of which was £9,054,393. Of this, China alone took 54,863 chests, of the value of £8,366,335. In 1861, the quantity exported was increased to 63,490 chests, or 4251 tons, of the value of £10,184,713; and China's share was 59,405 chests, of the value of £9,428,887. Next to China, the largest consumption of Indian opium is by the Burmese and the natives of the Malacca Straits, who took in 1861 to the value of three-quarters of a million sterling.

In Europe, with very slight exceptions, opium is used for medicinal purposes only, and large quantities of it undergo a still further stage of manufacture, in order to separate from it the active principles morphine, narcotine, &c. In Great Britain, the chief manufacture of these salts of opium is carried on in Edinburgh, where two firms, Messrs T. and H. Smith, and J. F. Macfarlane & Co., have attained great reputation, and manufacture these products upon an immense scale, supplying probably a fifth of the whole quantity manufactured.

*Chemical and Medicinal Properties.*—The only variety recognised in the British pharmacopœia is the Turkey opium. The chemical composition of opium has been studied by various chemists, amongst whom must be especially mentioned Professor Mulder of Utrecht, and Professor Anderson of Glasgow. The following constituents occur in most kinds of opium:

Organic Bases or Alkaloids.	Meconic Acid, $3\text{HO}, \text{C}_{14}\text{HO}_{11}$ ,	from 4 to 8 per cent.
	Morphia, . . . . . $\text{C}_{17}\text{H}_{19}\text{NO}_6$ ,	from 4 to 12 . .
	Codeia, . . . . . $\text{C}_{16}\text{H}_{21}\text{NO}_6$ ,	less than 1 . .
	Thebaia, . . . . . $\text{C}_{16}\text{H}_{21}\text{NO}_6$ ,	" . .
	Papaverine, . . . . . $\text{C}_{20}\text{H}_{27}\text{NO}_6$ ,	" . .
	Narcotine, . . . . . $\text{C}_{40}\text{H}_{53}\text{NO}_{14}$ ,	from 6 to 10 . .
	Narceia, . . . . . $\text{C}_{46}\text{H}_{59}\text{NO}_{18}$ ,	from 6 to 13 . .
	Meconine, . . . . . $\text{C}_{20}\text{H}_{27}\text{NO}_6$ ,	less than 1 . .
	Resinous Matter,	from 2 to 4 . .
	Caoutchouc, . . . . .	from 4 to 6 . .
	Mucilage, Gum, and Extractive } Matters, . . . . . }	from 40 to 50 . .

In addition to the six alkaloids named in this table, a seventh, named opianine, has been found in Egyptian opium, but in no other varieties.

Some of the most important and characteristic of these constituents, as meconic acid, morphia, and narcotine, are noticed in special articles. The only isolated constituents of opium which are now used in medicine are *Codeia* (so called from the Greek word *kōdeia*, a poppy-head), which has been asserted by Magendie and others to act in the same manner as, although less powerfully than, morphia, but which is now seldom prescribed, as it is not a pharmacopœial preparation; and *Morphia*, which has already been described.

The only test given in the British pharmacopœia for the purity of opium is the determination of its percentage of morphia, which is a process requiring a considerable amount of chemical skill.

Following the arrangement adopted by Pereira (*Elements of Materia Medica*, 4th ed.), we have just quoted, we shall consider (1) the effects of one or a few doses of opium employed medicinally or as a poison; (2) the effects of the habitual employment of opium, either by chewing or smoking it; and (3) its good and bad effects on the different systems of organs.

1. In *small doses*, as from a quarter of a grain to a grain, it acts as an agreeable stimulant, this effect being followed by a desire to sleep, accompanied by dryness of the mouth and throat, thirst, and slight constipation. When it is given in a *full medicinal dose* (as from two to four grains), the stage of excitement is soon followed by well-marked depression or torpor, both of the bodily and mental organs, and an almost irresistible sleepiness, these effects being usually succeeded by constipation, nausea, furred tongue, headache, and listlessness. When it is administered in a dangerous or poisonous dose, the symptoms, as summed up by Dr Christison in his work *On Poisons*, begin with giddiness and stupor, generally without any previous stimulus. The stupor rapidly increasing, the person becomes motionless, and insensible to external impressions; he breathes very slowly, generally lies quite still, with his eyes shut and the pupils contracted; and the whole

expression of the countenance is that of deep and perfect repose. As the poisoning advances, the features become ghastly, the pulse feeble and imperceptible, the muscles exceedingly relaxed, and, unless assistance is speedily procured, death ensues. If the person recovers, the insensibility is succeeded by prolonged sleep, which commonly ends in twenty-four or thirty-six hours, and is followed by nausea, vomiting, giddiness, and loathing of food.

2. The *habitual use of opium*, whether the drug be eaten or smoked, is undoubtedly in most cases injurious to the constitution, although probably not to the extent that some eastern travellers assert. Dr Christison, and other physicians of eminence, have shewn that in numerous cases very large quantities of this drug may be regularly taken with impunity; and Dr Chapman (*Elements of Therapeutics*, vol. ii. p. 199) relates two remarkable cases of this kind—one in which a wineglassful of laudanum was taken several times in the twenty-four hours, and another (a case of cancer of the uterus) in which the quantity of laudanum was gradually increased to *three pints* daily, a considerable quantity of solid opium being also taken in the same period.

*Opium-smoking* is a habit that is chiefly confined to China and the islands of the Indian Archipelago. An extract, called *chandoo*, is made into pills about the size of a pea. The following is the account given by Marsden, in his *History of Sumatra*, of the process employed: 'One of these pills being put into the small tube that projects from the side of the opium pipe, that tube is applied to a lamp, and the pill being lighted is consumed at one whiff or inflation of the lungs, attended with a whistling noise. The smoke is never emitted by the mouth, but usually receives vent through the nostrils.' Although the immoderate practice of opium-smoking is most destructive to those who live in poverty and distress, yet from the evidence of Mr Smith, a surgeon resident at Pulo Penang, and of Dr Eatwell, who passed three years in China, it does not appear that the Chinese in easy circumstances, and who have the comforts of life about them, are materially affected in respect to longevity by addiction to this habit.

3. As the discussion of the physiological action of opium on the different organs would, in its most condensed form, occupy too much space, we shall confine our remarks to the practical conclusions at which physiologists and physicians have arrived respecting the utility and the danger of prescribing this drug in various conditions of the principal vital organs.

*a. Cerebro-spinal System.*—Under proper regulations it is a remedy which may be used to stimulate the circulation within the cranium, to promote sleep, to diminish abnormal or increased sensibility, and to allay pain generally; while it is contra-indicated in apoplexy, cerebral inflammation, paralysis, and hysteria. Dr Pereira relates a case in which *one grain* of opium, administered to an hysterical young woman, proved fatal.

*b. Digestive System.*—'Under proper regulations,' says Pereira, 'opium is an admissible remedy for the following purposes: to diminish excessive hunger; to allay pain, when unaccompanied by inflammation; to diminish the sensibility of the digestive organs in cases of acrid poisoning, and in the passage of biliary calculi; to produce relaxation of the muscular fibres of the alimentary canal in colic, and of the gall-ducts in the passage of calculi, and to diminish excessive secretion from the intestinal canal in diarrhoea;' while it is contra-indicated 'in diminished secretion from the gastrointestinal membrane, in extreme thirst, in loss of

appetite and weak digestion, in obstinate costiveness, and in diminished excretion of bile.'

*c. Vascular System.*—In vascular excitement with great diminution of power, as after hemorrhage, opium is often serviceable; but when the pulse is strong as well as quick, or when there is simultaneously a tendency to abnormal sleepiness, it is contra-indicated.

*d. Respiratory System.*—'Opium, under proper regulations, may be useful to diminish the contractility of the muscles of respiration, or of the muscular fibres of the air-tubes, as in spasmodic asthma; to diminish the sensibility of the bronchia in the second stage of catarrh, and thereby to allay cough by lessening the influence of the cold air; and, lastly, to counteract excessive bronchial secretion;' while it is contra-indicated in difficulty of breathing, arising from a deficient supply of nervous energy, as in apoplectic cases; in cases in which the venous is imperfectly converted into arterial blood; and in the first stage of catarrh and pneumonia, both from its checking secretion, and from its tendency to impede the due arterialisisation of the blood.

*e. Urinary System.*—Opium is a valuable remedy to allay the pain in the kidney and adjacent parts in cases of renal calculi, and also to produce relaxation of the ureters when the calculi are passing along these tubes; it is also of great service in certain forms of irritable bladder.

There can be no doubt that the essential and primary operation of opium is on the nervous system, the other effects being for the most part secondary.

Opium is undoubtedly the most valuable remedy of the whole materia medica. 'For other medicines,' says Dr Pereira, 'we have one or more substitutes; but for opium, none—at least in the large majority of cases in which its peculiar and beneficial influence is required.' We not only exhibit it to mitigate pain, to allay spasm, to promote sleep, to relieve nervous restlessness, to produce perspiration, and to check profuse discharges from the bronchial tubes and intestinal canal; but we also find it capable of relieving some diseases in which none of the above indications can be always distinctly perceived. In combination with tartar emetic, it has been strongly recommended in fever with much cerebral disturbance; in association with calomel, it is the most trustworthy remedy in cases of inflammation of membranous parts; in insanity, its value cannot be overestimated; it is the remedy chiefly trusted to in delirium tremens; it is more serviceable than any other medicine in diabetes; and to conclude with a more common and less serious affection, its efficiency, when administered in small doses (as ten or fifteen drops of laudanum three times a day), in promoting the healing of ulcers in which granulation proceeds too slowly is very marked.

In addition to the solution of Muriate of Morphia (q. v.), which, on the whole, is the best preparation of opium for internal use in the majority of cases, the British pharmacopoeia contains an opium pill (containing one part of opium in five of the pill); a pill of lead and opium (chiefly used in pulmonary hemorrhage); an aromatic powder of chalk and opium (containing one part of opium in forty of the powder); powder of ipecacuan and opium (or Dover's Powder [q. v.], containing one part of opium in ten of the powder); powder of kino and opium (containing one part of opium in twenty of the powder, and, like the aromatic powder, chiefly used in diarrhoea); tincture (see LAUDANUM), and camphorated tincture of opium (commonly known as Paregoric Elixir, and much used in chronic cough—containing two grains of opium in the fluid ounce); in addition to an *eneura*;

a wine (used chiefly as a local application to the eye in cases of ophthalmia); an ointment of galls and opium (used as an external application to piles); and a liniment and a plaster, which are applied to remove local superficial pains.

In a case of poisoning by opium, the first and most essential point is the evacuation of the contents of the stomach. The stomach-pump, if it can be procured, should be employed, and strong coffee should then be pumped into the stomach after the removal of its contents. The next best remedy is an emetic of sulphate of zinc (about a scruple), and if this is not at hand, a dessert-spoonful of flour of mustard, stirred up in a tumbler of warm water, will usually produce the desired effect. The patient must, if possible, be prevented from falling asleep, and for this purpose he should be kept constantly walking between two strong men, while a third person in the rear should, at short intervals, flick him sharply with a rough wet towel, or (if procurable) a good birch rod. Cold water should also be occasionally dashed over the head and chest. In a few apparently hopeless cases, death has been averted by artificial respiration, and by the application of electro-magnetism.

**OPOBALSAMUM.** See BALSAM and GUM.

**OPODELDOC** is a popular synonyme for *Soap Liniment* (q. v.). The origin of the term, which was apparently applied by Paracelsus to various forms of liniments or local applications, is not known. The *opo* is the same as the *opo* of *opoponax*, *opobalsamum*, &c., and is doubtless derived from the Greek *σπος*, juice. It has been suggested by an eminent Anglo-Saxon scholar that the original word was *opodilla*, and that *doc* or *dock* was added merely as a gloss to *dilla*—a view that is confirmed by the fact, that in *Ælfric's Glossary*, *dill* (*dilla*) is Englished by *dock*.

**OPO'PONAX**, a gum resin obtained by puncturing the roots of a species of parsnip (*Pastinaca Opoponax*). The chief interest in this material is the great importance which the ancient physicians attached to it as an antispasmodic medicine. It was employed by Hippocrates, Theophrastus, and Dioscorides, who have each left descriptions of it. The plant grows generally throughout Southern Europe, and the gum is still collected, but is not much used.

**OPO'ERTO** (Portug. *O Porto*, the port), a city of Portugal, and, after Lisbon, the most important seaport of the country, in the province of Minho, on the right bank, and two miles from the mouth of the Douro, in lat. 41° 9' N., long. 8° 37' W.; and is 195 miles north-north-east of Lisbon. Though possessing few imposing edifices, the town, seen from a distance with its irregular outline marked with many towers, its whitewashed houses gleaming among trees and terraced gardens, has a fine picturesque effect. Its picturesqueness, however, has been secured at the cost to a great extent of comfort, as many of its streets are narrow, dirty, and so steep as to be impassable for carriages. Of the old walls that surrounded the ancient town, remains are still to be seen. The principal street is the *Rua Nova dos Ingleses*, a spacious, handsome, modern thoroughfare, from which a good view of the Bishop's Palace, which seems to be hung high in the air, is obtained. Here is situated one of the finest edifices in O., the English Factory House, a building of white granite with a beautiful façade, and comprising on a magnificent scale all the appurtenances of a club-house, as ball-room, library, refreshment-room, &c. The houses in the *Rua Nova de S. João*, the most regular street in the city, are lofty, and are faced with

gaily painted and gilt balconies. Of the 11 squares, the greatest is the *Praça de S. Ovidio* on a height, the appearance of which is enhanced by beautiful buildings and a terrace, with a fine seaward view, planted with trees. On the high rocks, on the southern bank of the river, stands the convent of *da Serra*, which at one time was extraordinarily rich. The most beautiful of the convents was that of *S. Bento*, now converted into barracks. The cathedral, which must originally have been a noble edifice, but has been infamously modernised, stands near the Bishop's Palace. The *Torre dos Clerigos* (Tower of the Clergy), said to be the highest in Portugal, was built in 1748. Formerly, there were in all 80 convents and chapels in the city. Of existing institutions, there are four hospitals, and numerous educational and benevolent establishments. O. is the principal industrial seat in the country. It carries on manufactures of linen, silk, cotton, and woollen fabrics, cloth of gold, silk and cotton hosiery, lace, buttons, gold and silver wire, cutlery and hardware, excellent furniture, pottery, glass, leather, paper, hats, sails, and the articles required on ship-board. Royal tobacco and soap-works, two iron-foundries, and several sugar-refineries are also in operation. The entrance to the Douro is rendered highly dangerous by a shifting bar of sand; but yet the commercial traffic on the river is considerable. Its imports for 1861, consisting principally of cotton, woollen, iron, and hardware manufactures from England, salt-fish, wheat, rice, hemp, and flax, amounted to £2,029,295; its exports, consisting of port (so called from the name of the town whence shipped) and other wines, oils, sumach, oranges, lemons, &c., amounted to £1,392,050. Pop., including suburbs, about 90,000.

In ancient times, the site of O. was occupied by the harbour-town *Portus Cale*, afterwards *Porto Cale*, from which has been derived the name of the kingdom, Portugal. It was an important city during the supremacy of the Moors, was destroyed in 820 by Almanzor of Cordova, but was restored and peopled by a colony of Gascons and French in 999. It was famous for the strength of its fortifications during the middle ages, its walls being 3000 paces in circumference, 30 feet in height, and flanked with towers. From the 17th to the present century, O. has been the scene of an unusual number of popular insurrections. In 1808, it was taken by the French; but in the following year it was retaken by an Anglo-Portuguese force under Wellington. In 1832, Dom Pedro, the ex-emperor of Brazil, was unsuccessfully besieged for a year in this city by the forces of Dom Miguel.

**OPO'SSUM** (*Didelphis*), a genus of *Marsupialia*, having ten cutting teeth in the upper jaw, and eight in the lower, one canine tooth on each side in each jaw, three compressed premolars, and four sharply-tuberculated molars on each side—fifty teeth in all; the tongue bristly; the tail long, prehensile, and in part scaly; the feet plantigrade; five toes on each foot, their claws long and sharp; but the inner toe of the right foot converted into a thumb, destitute of a claw, and opposable to the other digits; the muzzle long and pointed, the month very wide, the ears large and destitute of hair. The unwebbed feet and non-aquatic habits distinguish this genus from *Cheironectes* (q. v.), also belonging to the family *Didelphida*. But the genus *Didelphis* itself is divided by some naturalists into several genera; and there are differences not unimportant, particularly in the well-developed pouch of some species, and the merely rudimentary pouch or abdominal folds of others. All the existing species are American, but fossil species are found in other parts of the world. The opossums were the first marsupial



animals known, and are noticed as very wonderful creatures by some of the earliest writers on America. Some of the smaller species much resemble rats and mice, except in their long and pointed muzzle; others greatly resemble shrews; the largest known species are scarcely equal in size to a large cat. It is in some of the smaller species that the pouch is rudimentary; all the larger species have a well-developed pouch, in which the young are carried, and to which, even after beginning to venture forth from it, they retreat on the approach of danger. The young of the species which have a merely rudimentary pouch, also remain attached to the nipple of the mother for a time; and afterwards for a time are carried on her back, intertwining their prehensile tails with hers, and clinging to the fur of her back.—The VIRGINIAN O. (*D. Virginiana*) is one of the largest species. It abounds in the warmer parts of North America, and



Virginian Opossum (*Didelphis Virginiana*).

its range extends considerably to the north of Virginia. Its form is robust, its head very large, its colour dull white; its fur long, fine, and woolly, thickly interspersed with longer coarse white hairs, except on the head and some of the upper parts, where the hair is short and close. The tail is not quite so long as the body. The Virginian O. lives much in forests and among the branches of trees, to which it usually retreats to devour its prey, twining its tail around a branch for security. Its food consists of small quadrupeds and reptiles, birds' eggs, and insects; also in part of fruits and the juicy stalks of plants. It often visits poultry-yards, and displays much cunning in its stealthy quest of prey; although otherwise it seems, like the other *Marsupiatæ*, to be very low in the scale of intelligence. It seeks to escape from enemies by running to the woods and ascending a tree; but if escape is impossible, it feigns death, and maintains the imposture in very trying circumstances, however it may be kicked and beaten; but the true state of the case may be ascertained by throwing it into water. The American word '*possuming*' makes a figurative application of this part of the natural history of the opossum. The female sometimes produces sixteen young at a birth; the young when born are blind, naked, and shapeless, and weigh scarcely more than a grain each; they do not begin to leave the pouch until they have attained about the size of a mouse. The female O. shews a very strong attachment to her young. The O. is very easily tamed, but its strong odour makes it an unpleasant pet. The flesh of the O. is said to be good. The hair is woven into garters and girdles by the Indian women.—Other species of O. are found in the more southern parts of America. Of these, one of the largest is the CRAB-EATING O. (*D. cancrivora*) of Guiana and Brazil; which is nearly as large as the Virginian O., lives chiefly in

marshy places, and feeds much on crabs. The smaller species are numerous in the tropical parts of America.—The name O. is often given in Australia to the Phalangers (q. v.).

O'PPELN, a town of Prussian Silesia, capital of the government district of the same name, on the Oder, 51 miles south-east of Breslau. Since 1816, when it was erected into an especial seat of government for Upper Silesia, the town has been much beautified both with new edifices and with parks and gardens. It contains four churches—one of which, Adelbert's Church, was founded in 995—an old castle on the island Pascheke in the channel of the Oder, a town-house, and theatre. Pop. 9608, who carry on a considerable transit-trade in timber, zinc, lead, hardware, cattle, and wines; and manufacture ribbons, linen goods, leather, and pottery.

OPPOSITION, the party in either House of the British parliament who are opposed to the existing government, and who would probably come into power on its displacement. The existence of a fair and temperate opposition, keeping a watch over the acts of the ministry, is undeniably conducive to good government; while, on the other hand, the conduct of public affairs may be seriously embarrassed by an opposition whose proceedings are conducted in a factious or obstructive spirit. The name Opposition is not generally applied to a party, merely because opposed to the existing administration, if there is no likelihood of their succeeding to power on a change of government.

OPTIC NERVE. See EYE.

O'PTICAL ILLUSION. Of all the senses none is more deceptive than the sense of sight; it often deceives us as to the distance, size, shape, and colour of objects; it frequently makes them appear as if in situations where their existence is impossible; and often makes us think them movable when they are not so, and *vice versa*. An object appears to us as large or small, near or distant, according as the rays from its opposite borders meeting at the eye form a large or a small angle: when the angle is large, the object is either large or near; when small, the object must be small or distant. Practice alone enables us to decide whether an object of large apparent size is so on account of its real size, or of its proximity; and our decision is arrived at by a comparison of the object *in position*, with other common objects, such as trees, houses, &c., which may chance to be near it, and of which we have by experience come to form a correct idea. The same is, of course, true of apparently small objects. But when all means for comparison are removed, as when we see a distant object floating on an extensive sheet of water, or erect in an apparently boundless sandy plain, where no other object meets the eye, then our judgment is completely at fault. Imperfection in the acquired perceptions of sight, as it is called, produces many other illusions; it leads us to consider spherical solids at a distance as flat discs, and deceives us regarding the size of objects, by their colour; the sun appears larger than he would if illumined by a fainter light, and a man in a white habit seems larger than he would if he wore a dark dress. Illusions are also produced by external causes; and instances of this sort are given under MIRAGE, REFLECTION, and REFRACTION.

The property which the eye possesses of retaining an impression for a very brief, though sensible period of time (about one-quarter of a second), after the object which produced the impression has been removed, produces a third class of illusions. Common examples of this are the illumined circle formed by the rapid revolution of an ignited carbon

point, piece of red-hot iron, or other luminous body, and the fiery curve produced by a red-hot shot projected from a cannon.

Another form of illusion is produced to a person who is seated in a vehicle in motion, and it is very deceptive when the motion is so equable as not to be felt by the person himself. The illusion is most complete when the attention is riveted on an object several yards off; this object then appears as a centre round which all the other objects seem to revolve, those between the observer and the object moving backwards, and those beyond the object moving forwards. This illusion occurs on a large scale in the apparent motion of the heavenly bodies.

Other illusions arise from a disordered state of the organs of vision; such are the seeing of things double or movable (if they are not so), or of a colour different from the true one; the appearance as of insects crawling over a body at which the eye is directed, &c.

OPTICS is the science whose object is the investigation of the laws that regulate the phenomena of light and vision. The nature of light will be found treated of under LIGHT, and its various properties under CHROMATICS, DIFFRACTION, INTERFERENCE, LENS, POLARISATION, REFLECTION, REFRACTION, SPECTRUM, &c.; and we shall confine ourselves in this article to a historical sketch of the rise and progress of the science.

Optics, as a science, is entirely of modern growth, for though the Greeks and their disciples the Arabs had made some progress in mathematical optics, their knowledge was confined to the law of reflection and its more immediate consequences. Euclid, Aristotle, Archimedes, Hero, and Ptolemy were acquainted with the fact that light is transmitted in straight lines, but with the important exception of Aristotle, and some of his followers, the ancient philosophers believed that rays proceeded from the eye to the object, instead of in the contrary direction. Ptolemy was well acquainted with atmospheric refraction. Alhacen (1070) and Vitellio the Pole (1260) were almost the only cultivators of this science during the middle ages, and their additions to it were unimportant. The lens, though known from early antiquity, was not applied as an aid to defective eyesight till after the time of Roger Bacon. Jansen, Metius, and Galileo separately invented the telescope about the beginning of the 17th c.; and the last-mentioned philosopher, by its means, made various important astronomical discoveries. Kepler, a short time after, gave the true theory of the telescope, explained the method of finding the focal length of lenses, and applied it to find the magnifying power of the telescope, besides pointing out the mode of constructing an instrument better adapted for astronomical purposes than that of Galileo; he also made some useful experiments on the nature of colours, and shewed that images formed on the retina of the eye are inverted, a fact previously discovered by Maurolycus of Messina. From this period the science of optics steadily advanced, and its treasury of facts received numerous additions through the labours of De Dominis, Snell (the discoverer of the law of refraction in 1621), Descartes, Fermat, Barrow, Mariotte, and Boyle. Up to the time of Newton it was generally believed that colour was produced by refraction, but that philosopher shewed by a beautiful series of experiments that refraction only separates the colours already existing in white light. In his hands the theory and construction of the telescope underwent many valuable improvements, and in 1672 the description of his reflecting telescope was submitted to the Royal Society.

Gregory had constructed an instrument on similar principles some years before. About the same time, Grimaldi made his interesting series of experiments on the effects of diffraction, and noticed the remarkable fact of the interference of one pencil of light with the action of another. The complete theory of the rainbow, with an elegant analysis of the colours of thin plates, and the hypothesis concerning the nature and propagation of light, now known as the 'corpuscular' theory, completed Newton's contributions to the science. The important services of the ingenious but eccentric Hooke cannot be easily stated in such a brief abstract, as he discovered a little of everything, completed nothing, and occupied himself to a large extent in combating faulty points in the theories of his contemporaries. It must not, however, be forgotten that he has as much right as Huyghens to the credit of originating the undulatory theory, which is the favourite one at present. The double refraction of Iceland spar was discovered (1669) by Bartholin, and fully explained in 1690 by Huyghens, the propounder of the undulatory theory, who also aided the progress of mathematical optics to a considerable extent. The velocity of light was discovered by Römer (1675), and in 1720 the aberration of the fixed stars and its cause were made known by Bradley, who likewise determined with accuracy the amount of atmospheric refraction. Bouguer, Porterfield, Euler, and Lambert rendered essential service to physical optics; the same was done for the mathematical theory by Dollond (the inventor of the achromatic telescope), Clairaut, D'Alembert, Boscovich, &c.; while in later times the experiments of Delaval on the colours produced by reflection and refraction; the discussion of the phenomena arising from unusual reflection or refraction, carried on by Vince, Wollaston, Biot, Monge, and others; the discovery of polarisation of light by Malus (1808), and its investigation by Brewster, Biot, and Seebeck; of depolarisation by Arago (1811), and of the optical properties as connected with the axes of crystals (1818) by Brewster; and the explanation of these and other optical phenomena, in accordance with the undulatory hypothesis by Young—the discoverer of the *Interference* (q. v.) of rays—and Fresnel, went far to give optics a width of scope and symmetry which is possessed by few other sciences. The development of the undulatory theory and of optical science generally has been carried on in the present century by Lloyd, Airy, Cauchy, and others; and more recently important discoveries in connection with the physical modifications and chemical properties of light have been made (the latter chiefly, as far as the spectrum is concerned, by Kirchhoff), for a notice of which, and other discoveries, see PHOTOGRAPHY, SPECTRUM, and other articles.

OPTIMISM (Lat. *optimus*, best), the name given to the doctrine of those philosophers and divines who hold that the existing order of things, whatever may be its seeming imperfections of detail, is nevertheless, as a whole, the most perfect or the best which could have been created, or which it is possible to conceive. Some of the advocates of optimism content themselves with maintaining the absolute position, that although God was not by any means bound to create the most perfect order of things, yet the existing order is *de facto* the best; others contend, in addition, that the perfection and wisdom of Almighty God necessarily require that His creation should be the most perfect which it is possible to conceive. The philosophical discussions of which this controversy is the development are as old as philosophy itself.

and form the groundwork of all the systems, physical as well as moral, whether of the Oriental or of the Greek philosophy; of Dualism, Parsism, and of the Christian Gnosticism and Manicheism in the east; and in the west, of the Ionian, the Eleatic, the Atomistic; no less than of the later and more familiar, Stoic, Peripatetic, and Platonistic Schools. In the philosophical writings of the fathers, of Origen, Clement of Alexandria, and above all of Augustine, the problem of the seeming mixture of good and evil in the world is the great subject of inquiry, and through all the subtleties of the medieval schools it continued to hold an important and prominent place. But the full development of the optimistic theory as a philosophical system was reserved for the celebrated Leibnitz (q. v.). It forms the subject of his most elaborate work, entitled *Theodicea*, the main thesis of which may be briefly stated to be—that among all the systems which presented themselves to the infinite intelligence of God, as possible, God selected and created, in the existing universe, the best and most perfect, physically as well as morally. The *Theodicea*, published in 1700, was designed to meet the sceptical theories of Bayle, by shewing not only that the existence of evil, moral and physical, is not incompatible with the general perfection of the created universe, but that God, as all-wise, all-powerful, and all-perfect, has chosen out of all possible creations the best and most perfect; that had another more perfect creation been present to the divine intelligence, God's wisdom would have required of Him to select it; and that if another, even equally perfect, had been possible, there would not have been any sufficient determining motive for the creation of the present world. The details of the controversial part of the system would be out of place in this work. It will be enough to say that the existence of evil, both moral and physical, is explained as a necessary consequence of the finiteness of created beings; and it is contended that in the balance of good and evil in the existing constitution of things, the preponderance of the former is greater than in any other conceivable creation. The great argument of the optimists is the following: If the present universe be not the best that is possible, it must be either because God did not know of the (supposed) better universe, or because God was not able to create that better one, or was not willing to create it. Now every one of these hypotheses is irreconcilable with the attributes of God: the first, with His omniscience; the second, with His omnipotence; and the third, with His goodness. See Leibnitz, *Theodicea*; Baumeister's *Historia de Mundo Optimo* (Corleto, 1741); Wolfurt, *Controversia de Mundo Optimo* (Jena, 1743); Creuzer, *Leibnitii Doctrina de Mundo Optimo sub Examine denuo Revocata* (Leipsia, 1795).

OPUNTIA. See PRICKLY PEAR.

O'PUS OPERA'NTIS (Lat. literally 'the work of the worker'), a well-known theological phrase, intended to convey that the effect of a particular ministration or rite is primarily and directly due, not to the rite itself (*opus*), but to the dispositions of the recipient (*operans*). Thus, in the act of kissing or praying before a crucifix, of sprinkling one's self with holy water, of telling the prayers of the rosary upon blessed beads, the fervour and personal piety of the supplicant, and not the material object of the religious use, is held to be the efficient cause of the grace which is thereby imparted. The term is used chiefly by writers of the Roman Catholic schools, in whose system, however, the sacramental rites are held to differ from all others in this respect. See OPUS OPERATUM.

OPUS OPERATUM (Lat. literally 'the work wrought') is the phrase employed in the Catholic theological schools to describe the manner of the supposed operation of the sacramental rites in the production of Grace (q. v.). It is intended to imply that the ministration of the rite (*opus*) is in itself, through the institution of Christ, an efficient cause of grace, and that, although its operation is not infallible, but requires and presupposes certain dispositions on the part of the recipient, yet these dispositions are but *conditiones sine qua non*, and do not of themselves produce the grace; and hence, when the sacraments are administered to dying persons in a state of apparent insensibility, this is done in the hope and on the presumption that the dying person may, though seemingly unconscious, be nevertheless really disposed to receive the sacrament; but it is by no means held that if these dispositions be wanting, the sacrament will itself justify him. It is a mistake, therefore, to suppose, as is often done in popular controversy, that Catholics ascribe to the sacramental rites such magical or talismanic power that they can sanctify even an unrepentant sinner. Their efficacious operation *presupposes as conditions* the repentance and other moral dispositions of the recipient, although the grace which they give is due, not to these dispositions, but to the sacraments as received with the dispositions.



Or.

OR, in Heraldry, the metal gold, represented in heraldic engravings by an unlimited number of dots.

O'RACHE (*Atriplex*), a genus of plants of the natural order *Chenopodiaceae*, having male, female, and hermaphrodite flowers; the male and hermaphrodite flowers with a 3-5-partite calyx, and 3-5 stamens; the female flowers with a compressed and 2-lobed or 2-partite calyx. The species are numerous. Some of them are of frequent occurrence in waste places, and as weeds in gardens in Britain and throughout Europe. GARDEN O. (*A. hortensis*), also called MOUNTAIN SPINACH, was formerly much



Orache patula.

cultivated in England, and is still cultivated in some parts of Europe as a substitute for spinach. It is a native of Tartary, an annual, with a stem about three feet high, and cordate-triangular leaves, which are thick and glaucous, and have a

slightly acid flavour. The leaves are sometimes greenish, sometimes reddish, which is the case also in other species, and the flowers resemble the leaves in colour.—The leaves of the Sea O. (*A. littoralis*), a native of the British coasts, are used in the same manner, and those of the common garden-weeds, *A. patula* and *A. angustifolia*, are excellent substitutes for spinach.—It is mentioned in Remy and Brenchley's *Journey to the Salt Lake City*, that an crache, with pale pink leaves and a salt taste, is cultivated by the Indians on the Humboldt River for its seed, which resembles that of Quinoa (q. v.), and is used like it for making porridge and bread.

**O'RACLE**, the response delivered by a deity or supernatural being to a worshipper or inquirer; also the place where the response was delivered. These responses were supposed to be given by a certain divine afflatus, either through means of mankind, as in the orgasms of the Pythia, and the dreams of the worshipper in the temples; or by its effect on certain objects, as the tinkling of the caldrons at Dodona, the rustling of the sacred laurel, the murmuring of the streams; or by the actions of sacred animals, as exemplified in the Apis or sacred bull of Memphis, and the feeding of holy chickens of the Romans. This arose, in fact, from the idea that the deity signified his intentions to men by signs or inspirations, which, however, had always to be interpreted to the inquirer by the priesthood. Such responses were, however, closely allied to augury, which differed in this respect that auguries could be taken anywhere, while the oracular spots were defined and limited. Oracle dates from the highest antiquity, and flourished in the most remote ages, and gradually declined with the increasing knowledge of mankind. Among the Egyptians all the temples were probably oracular, although only a few are mentioned by Herodotus, as the oracle of Latona, in the city of Buto; those of Hercules, Mars, Thebes, and Meroe. In the hieroglyphic texts the gods speak constantly in an oracular manner, and their consultation by the Pharaohs is occasionally mentioned. In later days the most renowned of these oracles was that of Ammon, in the Oasis (q. v.), where oracular responses were rendered either by the shaking of the statue of the god, or by his appearance in a certain manner. Oracles were also used by the Hebrews, as in the consultation of the Urim and Thummim by the high priest, and the unlawful use of Teraphims, and consultations of the gods of Phœnicia and Samaria. The Hebrew oracles were by word of mouth, as the speech of God to Moses, dreams, visions, and prophetic denunciations; besides which, there were oracles in Phœnicia, as that of Belzebub and others of the Baalim. They were also in use throughout Babylonia and Chaldæa, where the responses were delivered by dreams given to the priestesses, who slept alone in the temples as concubines of the gods. So numerous were they in the ancient world, that 300 are said to have been in existence.

The most celebrated oracles of Asia Minor were those of Telmissus in Caria or Lycia, which gave responses by dreams, and that of Apollo at Patara; but the Grecian oracles enjoyed the highest reputation for truthfulness, and the most celebrated of these were the Dodonean, the Delphic, and that of Trophonius and Amphiaraus. The Dodonean (see DODONA) was the only oracle in Greece which was given by Jupiter; the others were either those of Apollo, or of certain soothsayers, to whom that god had imparted the gift of prophecy, or of other gods. The most renowned of all was the Delphic oracle (see DELPHI), and was Panhellenic or open to all Greece, consulted for public purposes, and occupying

a position resembling in some respects that of the papacy in the middle ages in Europe. The name of the first priestess who gave oracles was Pheemonca. The consultations were generally in the Delphic mouth, *Byzios* or April, and once a day on these months; and the precedence of consulting the oracle was determined by lot, but rich presents obtained for Croesus and the Lydians the privilege of first consultation. Sacrifices were offered by the inquirers, who walked with laurel crowns on their heads, and delivered in sealed questions; the response was deemed infallible, and was usually dictated by justice, sound sense, and reason, till the growing political importance of the shrine rendered the guardians of it fearful to offend, when they framed the answers in ambiguous terms, or allowed the influence of gold and presents to corrupt the inspirations. The other oracles of Apollo were at Aba in Phocis; at Ptoon, where a man prophesied, which was destroyed in the days of Alexander the Great; and at Ismenus, south of Thebes, Hysia, Tegyra, and Eutressis. In Asia Minor the most celebrated was that of Branchidæ, close to Miletus, celebrated in Egypt, Gryneum, and Delos. Besides that of Dodona, Zeus had another at Olympia; and those of various other deities existed elsewhere. A secondary class of oracles of heroic or prophetic persons existed in Greece, the two most celebrated of which were those of Amphiaraus and Trophonius. The first mentioned was one of the five great oracles in the days of Croesus, and was situate at Oropus, in Attica, being the shrine of a deified magician, or interpreter of dreams, having a fountain close to it. Those who consulted it, fasted a whole day, abstained from wine, sacrificed a ram to Amphiaraus, and slept on the skin in the temple, where their destiny was revealed by dreams. That of Trophonius was at Lebæa, in Bœotia, and owed its origin to a deified seer. It was given in a cave, into which the votary decended, bathed, and anointed, holding a honeyed cake. He obtained a knowledge of futurity by what he saw or heard, and returned dejected from the cavern. Then, seated upon the seat of Mnemosyne, he gave an account of what he had heard, and conducted to the chapel of Good Fortune or Good Genius, recovered his usual composure. There were some other oracles of minor importance. Besides these oracles, written ones existed of the prophecies of celebrated seers, as Bacis and Musæus, which were collected by the Pisistratidæ, and kept in the Acropolis of Athens. Those of the Enclius, Panolmus, and Lycus were also celebrated. Others of the Sibyls or prophetic women, daughters of Zeus and Lamia, were popular, and at a later period (see SYBILS), Athenais and others, prophesied in the days of the Seleucidæ. Amongst the oriental nations, as the Arabs and others, divination was and is extensively practised, but there are no set oracles. The Celtic Druids are said to have delivered responses, and the oracle of the Celtic god Belenus or A belio, in the Isle de Sein, was celebrated. Herodot. *Hist.* v. 89, viii. 82; Curtius, iv. 7; Hare, *Ancient Greeks*, (12mo, Lond. 1836, p. 141); Bos, *Antiquities of Greece* (1823, p. 31).

**ORA'N** (Arab. *Waran*), a thriving municipal town and seaport of Algeria, capital of the province of the same name, stands at the inner extremity of the Gulf of Oran, 220 miles west-south-west of Algiers. The province of Oran, sometimes called the province of the West, from the fact of its forming the western frontier of the country, is bounded on the N. by the Mediterranean, on the E. by the province of Algiers, on the W. by the empire of Morocco, and on the S. by the desert. Area, 39,384 square miles, of which 13,514 belong to the Tell (q. v.)

and 25,870 to the Sahara. Pop. 670,697. Of the inhabitants, 66,223 were immigrants, 32,055 being French; and 604,474 were natives, 592,923 being Moslems, and 11,551 Jews. The town of O. is the seat of the government offices—the prefecture, the civil, criminal, commercial tribunals, &c. It also contains a college, primary and native schools, Protestant and other churches; synagogues; mosques; a branch of the bank of Algeria; exchequer, post, and telegraph offices; three great barracks, Saint-Philippe, le Château-Neuf, and le Château-Vieux; a military hospital, with accommodation for 1400 beds (an immense new building, which overtops all surrounding edifices), and various splendidly appointed magazines and government stores. The town, which is girt by walls, and defended by strongly armed forts, is seated at the foot of a high mountain, crowned by the forts Santa-Cruz and Saint-Gregoire. The port does not offer safe anchorage; although it has been much improved within recent years, and made accessible for large vessels. In 1864, vessels had no other shelter than the roadstead of Mers-el-Kebir. The streets and promenades of O. are generally spacious, the houses elegant and airy. The principal edifices are the Château-Neuf, the residence of the general of division; the Hôtel de la Préfecture; the great mosque de la Rue Philippe; the Catholic church; and the barracks. Pop. of commune, comprising the three suburbs, Mers-el-Kebir, La Senia, and Ain-el-Turk, 34,106. The country in the vicinity is bare and arid, although the land is not sterile. To the south of the town, the country is uncultivated; but towards the south-east, highly cultivated lands are seen. In the vicinity there are a great many farms, cultivated with the greatest care, and most of them furnished with buildings necessary to their efficiency. Cattle are reared, and grain, tobacco, and cotton are grown. The vine already covers large tracts of land, and its cultivation is annually extending. It is cultivated with the most complete success, and the wines are of good quality.

Besides the commune of O., there are in the province the communes of Sidi-bel-Abbès (q. v.), of Mostaganem (pop. 11,950), of Mascara (pop. 8629), and of Tlemcen (q. v.).

The town of O. was built by the Moors. It was taken by the Spaniards in 1509, by the Turks in 1708, and again by the Spaniards in 1732. In 1791, it was destroyed by an earthquake, and shortly after it was altogether abandoned by the Spaniards. O. was taken by the French in 1831, has since remained in their hands, and has by them been developed into a large and prosperous town. In 1858, 1584 vessels, of 64,723 tons, entered and cleared the port. In the same year the imports amounted to £1,307,616, and the exports to £260,964.—*Annuaire Général de l'Algérie*, 1864.

ORA'NG, or ORA'NG-OUTA'NG (*Simia satyrus*, or *Pithecus satyrus*, or *P. Abellii*), a species of ape found in the forests of Malacca, Cochin-China, and some of the islands of that part of the world. The name is sometimes extended in signification, so as to include all the species of the restricted genus *Simia* or *Pithecus*, a genus which exists only in the south-east of Asia and the Eastern Archipelago; and was also till of late extended even to the African apes now forming the genus *Troglodytes*, the species which is the subject of this article being distinctively called the RED O., when it and the Chimpanzee were the only *anthropoid* apes known. The name orang is Malayan, and signifies *man* or *rational being*; outang signifies *wild*, or *of the woods*. The genus *Simia* or *Pithecus* differs from *Troglodytes* (the Chimpanzee and Gorilla) in the more lengthened muzzle—the lower part of the face projecting

suddenly and remarkably; in the very large canine teeth; in the great breadth of the central incisors; and in the great length of the arms, which are so long that the fingers can touch the ground when the animal stands erect. The ears are also small, and lie close to the head. The eyes are close together; the nose is little elevated; the lips are scarcely visible when the mouth is shut. The apes of this genus are arboreal in their habits, and not



Orang-Outang (*Simia satyrus*).

gregarious. They are ill adapted for walking on the ground, and in a wild state probably almost never assume an erect posture, and although they can be taught to do it in confinement, they maintain it with difficulty, and only when standing still; even then often seeking to adjust the balance of the body by raising the arms above and behind the head. In climbing and swinging among the branches of trees, the hands of the hinder extremities are used as readily as those of the anterior, and the great length of the arms is useful in enabling them to take hold of distant branches. The fingers of all the extremities are very long.

Some of the most important distinctions between the anatomy of the anthropoid apes and that of man, are noticed in the article CHIMPANZEE. The O. and its congeners are regarded as differing more widely from man in their anatomical characters than the chimpanzee and gorilla; although the number of ribs is the same as in man, and there are a few other particulars in which the O. more nearly resembles a human being than any of the African apes do. The projecting muzzle is much less notable in the young than in the adult O., and the aspect of the adult males is further rendered hideous by great callosities on the cheeks. In the adult state, the ridges of the skull also greatly increase in thickness and prominence.

The species of this genus exhibit in a much greater degree than those of *Troglodytes* an anatomical character common also to many other apes and monkeys, a pouch in the throat, opening from the windpipe, and capable of being dilated with air at the pleasure of the animal. In the O., it branches into several subordinate pouches, which are situated among the muscles of the throat. The use of this organ is not known. It does not appear to have any connection with the voice; and has been supposed, not very probably, to be of some service in leaping, by diminishing the specific gravity of the animal.

## ORANGE.

There are at least two other species of the genus besides that best known as the O., one of these being the great Pongo (q. v.) of Borneo (*S.* or *P. Formosii*), and the other (*S.* or *P. morio*), also a native of Borneo, of comparatively small size. The natural history of these apes has not been thoroughly investigated; and, until recently, it was supposed that the species first known might be identical with the great ape believed to exist in the woods, and that the differences of size and other characters might depend merely on age. The O. is about three feet in length from the heel to the crown of the head. It is covered with brownish-red hair, which, on the back and arms, is five or six inches long, but very short on the backs of the hands and feet. There is little hair on the face, and none on the palms of the hands. When taken young, it is easily tamed, and becomes sufficiently familiar. It displays considerable sagacity, and some playfulness and love of mischief, but is not so frolicsome as many of the monkey tribe. Young specimens have sometimes been brought to Europe, but none have lived long. The temper is believed to change very much to the worse, when the animal reaches maturity.

**ORANGE**, the name of one or more species of *Citrus* (q. v.), of which the fruit is much prized. Botanists generally regard all the oranges as of one species, *Citrus aurantium*, but some follow Risso in making the Sweet O., the Bitter O., the Bergamot O., &c., distinct species. The wild state of the O. is not certainly known, although its characters may be pretty confidently inferred from the degeneration of cultivated varieties; and no cultivated plant shews a greater liability to degenerate, so that seedling oranges are almost always worthless. Nor is its native country more certain, although there is much reason to believe that all the kinds have spread over the world from the warmer central and eastern parts of Asia. It has been alleged that the O. is a native of North America, near the Gulf of Mexico; but the probability rather seems to be that it has been introduced, and has become naturalised.

The **COMMON O.**, or **SWEET O.** (*Citrus aurantium* of Risso), is an evergreen tree of moderate size, with greenish-brown bark; the leaves oblong, acute, sometimes minutely serrated, the leaf-stalks more or less winged, the flowers white, the fruit roundish, the oil-cysts of the rind convex, the juice sweet and acid. It is cultivated in almost every part of the world of which the climate is warm enough, but succeeds best in the warmer temperate or sub-tropical climates, as in the south of Europe, where it is very extensively cultivated, as far north as the south of France. The O. does not seem to have been known to the Greeks or Romans, but was probably brought to Europe by the Moors, and is supposed to have been introduced into Italy so recently as the 14th c., fully 1000 years after the citron. In the north of Italy, oranges are sometimes grown in conservatories, but often in the open air, except during winter, when they are covered with temporary houses of boards. In the south of England, they are sometimes in like manner grown in the open air, with a shelter of boards or matting in winter, but trained against a south wall; attaining a large size, and yielding good fruit. The abundant importation of the fruit, however, renders the cultivation of the O. in Britain unnecessary; and, in general, only small plants are to be seen in green-houses or conservatories, as mere objects of interest. In former times, when the evergreen shrubs in cultivation were much fewer than now, O. trees were very commonly cultivated in pots, both in green-houses and in windows of apartments in Britain, as is still the case in the northern parts of Germany. The O. loves a rich soil, and succeeds well in a strong clay.

There are many varieties in cultivation, which are perpetuated by grafting upon seedling O. stocks, and by layers.

Of the varieties of the Sweet O., perhaps the most deserving of notice are the **PORTUGAL** or **LISBON O.**, the most common of all, having the fruit generally round or nearly so, and a thick rind; the **CHINA O.**, said to have been brought by the Portuguese from China, and now much cultivated in the south of Europe, having a smooth thin rind and very abundant juice; the **MALTESE** or **BLOOD O.**, remarkable for the blood-red colour of its pulp; the **EGG O.**, having fruit of an oval shape; and the **TANGERINE O.**, having a small flat fruit, with a pleasant odour and finely flavoured pulp. The **ST MICHAEL'S O.** appears to be a subvariety of the China Orange. The **MAJORCA O.** is seedless, resembling in this certain cultivated varieties of other fruits.

The **BITTER O.**, **SEVILLE O.**, or **BIGARADE** (*Citrus vulgaris*, or *C. bigaradia*), is distinguished from the Sweet O. by the more truly elliptical leaves, the acid and bitter juice of the fruit, and the concave oil-cysts of its rind. Its branches are also spiny, which is rarely the case with the Sweet Orange. The varieties in cultivation are numerous. The Bitter O. was extensively cultivated by the Moors in Spain, probably for medicinal purposes. The rind is more bitter than that of the Sweet O., and is used as a stomachic and tonic. Its chief use, however, is for flavouring puddings, cakes, &c., and for making marmalade.

The **BERGAMOT O.** (*C. Bergamia*) is noticed in a separate article.

The **MANDARIN O.**, or **CLOVE O.** (*C. nobilis*), recently introduced from China, has fruit much broader than long, with a thick rind, very loosely attached to the flesh, so that there is often a space between them. The leaves are smaller than those of any other kind of orange.

O. leaves are feebly bitter, and contain a fragrant volatile oil, which is obtained by distilling them with water, and is known in the shops as *Essence de Petit Grain*. O. flowers yield, when distilled with water, a fragrant volatile oil, called *Oil of Neroli*, which is used in making *Eau de Cologne*, and for other purposes of perfumery. The flowers both of the Sweet O. and of the Bitter O. yield it, but those of the Bitter O. are preferred. Dried O. flowers, to be distilled for this oil, are an article of export from the south of Europe. They are packed in barrels, and mixed with salt. The dried flowers have a yellowish colour; the fresh flowers are white and very fragrant. The use of them as an ornament in the head-dress of brides is common throughout great part of the world.—The small green oranges, from the size of a pea to the size of a cherry, which fall from the trees, both of the Sweet O. and the Bitter O., when the crop is too great to be brought to maturity, are carefully gathered and dried, and are the *O. berries* of the shops. They are used in making Curaçoa. They also yield a fragrant oil on distillation, the original *essence de petit grain*; and they are smoothed in a turning-lathe, and employed as *essence pease*; not readily acquiring a fetid odour, as pease do when employed for this purpose.—The dried and candied rind of the ripe Bitter O., well known as *Orange-peel*, is used as a stomachic, and very largely for flavouring puddings and articles of confectionary. The rind of the Sweet O. is sometimes employed in the same way, but is inferior. A fragrant essential oil is obtained from the rind of the O. by distillation with water, and is sold by perfumers as *Oil of Sweet O.*, or *Oil of Bitter O.*, according as it is obtained from the one or the other, although the two kinds of oil are very similar. The rind of the O. is used in the preparation of a fine

liqueur called *O. Rosoglio*, which is an article of export from some parts of Italy. Besides the use of the Sweet O. as a dessert fruit, and as a refrigerant in cases of sickness, its juice is extensively used as a refrigerant beverage, and is particularly valuable in febrile and inflammatory complaints.

O. trees are often extremely fruitful, so that a tree twenty feet high, and occupying a space of little more than twelve feet in diameter, sometimes yields from 3000 to 4000 oranges in a year. The O. tree attains an age of at least 100 to 150 years. Young trees are less productive than old ones, and the fruit is also less juicy, has a thicker rind, and more numerous seeds.

The wood of the O. tree is yellowish white and close-grained. It is used for inlaying and for turnery.

The fruit of the O. tree is of great commercial importance, for not only is it one of the most delicious and wholesome of fruits, but fortunately it is also the most easily kept and carried from place to place. No fresh fruit possesses in the same degree as the O., and its congeners, the lemon, citron, lime, &c., the property of being easily packed in boxes, when nearly ripe, and being in that state able to stand the close confinement of a ship's hold during a voyage of two or three weeks. The O. is much cultivated in the Azores, Malta, Sicily, Spain, and Portugal, and it is from these localities that Britain receives its supply. Those from St Michael's, one of the Azores, and from Malta, are the best varieties in our markets; but the *Mandarin* O. of China and the *Navel* O. of South America are much superior. The latter occasionally reach this country in small quantities from Brazil; they are nearly double the size of the ordinary O., and have a peculiar navel-like formation on the top of the fruit, which is somewhat oval in shape. The very small O., now often seen in our shops, with an extremely aromatic rind, is the *Tangerine* O., of which there are two varieties—the greater and lesser. The latter is hardly an inch in diameter, but the flesh is sweet, and the rind deliciously fragrant. The larger variety is about half the size of a common O., and is the one generally seen.

The Bitter O. is called the *Seville* O. in consequence of large plantations, which the Moors planted round the city of Seville, having for a long time furnished the chief part of those used in this country; but it also has several varieties, which are all remarkable for the bitterness of the rind, and the not very pleasant sharpness of the juice. Their chief use is for making the well-known confection called *Orange Marmalade*, and for this the true *Large-fruited* variety is the best, but it is now somewhat scarce.

Oranges, when gathered for export, must not be quite ripe; those fully formed, and with the colour just turning from green to yellow, are chosen. Each is wrapped in a piece of paper, or in the husk of Indian corn, and they are packed in boxes and half-boxes, chests and half-chests—the former are the *Sicilian* packages, the latter are *St Michael's*, *Spanish*, and *Portuguese*. A box contains about 250, a chest about 1000 oranges; and the price ranges from 15s. to 30s. per box, and from 30s. to 50s. a chest. The crop begins to arrive early in November, and the ships continue to bring them until the spring. The quantity consumed in Great Britain alone is enormous; and since the duty was removed, has reached nearly one million of bushels annually.

Orange-peel, or the rind of the O., is used both in medicine and in confectionary—for the former purpose, it is merely cut into long strips, and dried; for the latter, it is carefully separated, either in

halves or quarters, from the fruit, and after lying in salt-water for a time, is washed in clear water, and then boiled in syrup of sugar, or candied, and is sold extensively as candied peel. The rinds of the citron and lemon are treated in the same manner.

ORANGE (the ancient *Arausio*), an ill-built, decaying, and dirty, but also an interesting town of France, in the department of *Vaucluse*, stands in a beautiful plain on the left bank of the *Aigue*, 16 miles by railway north of *Avignon*. Its chief manufactures are silks, muslins, serges, &c.; and there are numerous oilworks, dyeworks, and tanneries. It carries on a considerable trade in wine, spirits, oils, truffles, saffron, honey, madder, and essences. Pop. (1862) 6391.

O. was the capital of a small independent principality of the same name (now comprised in the department of *Vaucluse*), which was ruled by its own sovereigns from the 11th to the 16th century. The last of these sovereigns, *Philibert de Chalons*, died in 1531, without issue. His sister, however, had married a Count of *Nassau*, and to that House the estates and titles passed. The Count of *Nassau* who obtained the principality of O. was *William*, the father of *William I.*, the *Stadtholder* of the *United Provinces*. *William III.*, Prince of *Orange* and king of *England*, having died in 1702 without issue, *Frederick I.* of *Prussia*, in virtue of the will of his maternal grandfather, *Prince Henry Frederick* of *Orange*, claimed succession. The princes of *Nassau-Siegen* also advanced their claims; but the discussion was closed at the peace of *Utrecht* (1713), when the king of *Prussia* finally made over the principality of *Orange*, for certain equivalents, to the king of *France*. The House of *Nassau-Dietz* retains, among other titles, that of the *Prince of Orange*.

In the vicinity of O. are several notable Roman remains. The triumphal arch, 60 feet high, with one central arcade and two lateral ones, is celebrated for the beauty of its architecture, and for its richly sculptured *bassi-relievi*. Of the theatre, the remains, though stripped of all ornamentation, are sufficiently entire to give a good idea of the arrangements of this institution as it existed among the *Romans*. The colossal wall which formed the *scena*, the chord of the semicircle, is 121 feet high, 334 feet long, and 13 feet thick.

O'ORANGE, a township in *New Jersey*, U. S., four miles north-west of *Newark*, containing three villages, *Orange*, *North Orange*, and *South Orange*. *Orange Mountain* commands a noble view of *New York City* and *Bay*, and its slope is laid out in beautiful parks, and ornamented with villas. It is the site of a *Roman Catholic College* and a *Water-cure establishment*. Pop. in 1860, 8877.

ORANGE COLOURS, for painters' use, are various shades of alteration produced on chrome yellow (see *YELLOW*), by acting on it either with diacetate of lead or a weak alkaline lye, both of which redden the otherwise pure yellow, and give it an orange tint.—For dyers, a beautiful orange red is obtained from safflower; and orange yellows are made by mixing, in proper proportions, any of the red with the yellow dyes.

ORANGE RIVER. See *GARIEP*.

ORANGE RIVER FREE STATE. The *Orange River Free State* is the name assumed by the republic of *Dutch boers*, who, after retiring from *Natal* when declared a *British colony*, established themselves in the country lying between the two great branches of the *Orange River*, the *Ky* and the *Gariiep*, known to the colonists as the *Vaal* and *Orange Rivers*, and separated from the coast

## ORANGE RIVER FREE STATE—ORANGEMAN.

region by the great chain of the Quathlamba, Maluti, and Drachenberg mountains.

The Orange River Free State forms a sort of connecting-link between the Cape Colony, the Transvaal Republic, and Natal. It consists chiefly of vast undulating plains, which slope down from the Maluti Mountains to the Vaal River, dotted over here and there with rocky hills, locally called 'Kopjies,' although in the northern part hundreds of square miles are found with hardly a break on the horizon. It comprises an area of about 50,000 square miles.

When the emigrant Dutch boers took possession of this country, it was inhabited by different tribes of Betjouanas and Corannas, all whom have been dispersed except the powerful Abasutu tribe, under the chief Mosheshi, who still maintain themselves in the fastnesses of the Maluti Mountains, and a few Batclapi and other Betjouanas, who dwell round the Wesleyan mission station of Thab' Unchu and Merametsu.

All the rivers of this region are affluents of either of the branches of the Gariep; amongst them may be named the Modder, Valsch, Great and Little Vet, which run into the Ky Gariep or Vaal River, and the Caledon, a considerable stream, which joins the Orange River after draining the Basutu country.

This region is a vast plateau, rising from 3000 to 5000 feet above the sea-level, with very little wood, except along the lines of the water-courses that traverse it. Travellers crossing this state from the Cape Colony to Natal arrive at the top of the passes leading to the latter colony without a mountain being in sight, and then find themselves suddenly on the edge of an immense mountain-chain, with the coast region several thousand feet below them, extending to the Indian Ocean. Immense herds of the larger antelopes formerly tenanted these vast plains, and are vividly described by Captain Harris, Gordon Cumming, and others; they are now fast disappearing, and their places are supplied by more valuable herds of horned cattle and flocks of wool-bearing sheep.

The Free State is divided into the following districts: Bloem Fontein (chief town, Bloem Fontein the capital, Boshof); Winburg (chief town, Winburg, Cronstadt); Smithfield (chief town, Smithfield); Harrismith (chief town, Harrismith); Fauresmith (chief town, Fauresmith). The chief town Bloem Fontein is situated about 150 miles north-west of Colesberg, on a tributary of the Modder River, in lat. 29° 8' S. It contains about 250 houses; a Dutch, Episcopal, and Roman Catholic Church; has two local banks, and is the seat of an Episcopal see of the Church of England. It is distant about 800 miles overland from Cape Town, and has a post twice a week with it. The other villages or small towns are all increasing and flourishing, but do not present anything remarkable.

By the latest returns, the population of the Free State was about 15,000 white and 12,000 coloured inhabitants; and the revenue, principally derived from local taxation and quit rents of farms, was £19,000.

The history of the country forming the Free State may be summed up in a few words. Captain Harris describes it, before 1836, as a howling wilderness, inhabited by wandering hordes of Bushmen and broken tribes of Betjouana and Zulu refugees from the armies of the great Zulu tyrants, Chaka, Dingaan, and Maselikutsa. After the Kaffir war of 1835—1836, a spirit of dissatisfaction arising in the minds of many of the frontier boers, an extensive emigration took place along the north-east frontier of the Cape Colony; the majority of the emigrants, however, having Natal as their ultimate goal.

However, after the British government had declared it an English colony in 1843, the boers again fell back on this region, and by degrees declaring their independence of the British crown, and forming a sort of Alsatia on our very borders, after some opposition, and one or two conflicts with our troops, the country was annexed by Sir H. Smith to the British empire, under the name of the Orange River Sovereignty; and continued so until 1854, when Sir G. Clerk formally gave it up, and allowed the inhabitants to form a government according to their own wishes. The government is now in the hands of a president, freely elected by the landrost and heemraden in the several districts; while the volksraad, or peoples' council, exercise legislative functions. But within the last year or two this little community seems almost tired of self-government; and it is very probable that before long it will endeavour to annex itself, either federally or otherwise, with the Cape Colony, as it labours under the very serious disadvantage of being, like the kingdom of Bohemia, entirely inland, and has no port on the ocean at which customs dues can be collected; thus throwing the whole of the expense of government on local taxation.

A year or two ago, a large number of Griquas—a tribe of Bastard Hottentots, who inhabited the south part of the state, and were independent—sold their farms to the Free State government, and migrated in a body to the coast side of the mountains in Independent Kaffraria, occupying a large tract of country, there known by the name of No Man's Land, on the upper waters of the Umsinvooboo River.

The Dutch boers profess the Dutch Reformed faith, and speak a dialect of Dutch, corrupted with Hottentot and English words. They marry young, and keep up, to some extent, nomadic habits. The roads and internal communication are good. Lime and timber are rather scarce, but building stone and thatch abundant. Woolled sheep have increased amazingly within the last few years; and farms that ten years ago would hardly fetch £50, are now selling freely at from £2000 to £3000.—Harris; Cumming; Blue-books; personal knowledge.

O'RANGEMAN, one of the unhappy party designations which contributed for nearly a century to create and keep alive religious and political divisions of the worst character throughout the British empire, but especially in Ireland. The Orange organisation had its origin in the animosities which had subsisted between Protestants and Catholics in Ireland from the Reformation downwards, but which reached their full development after the Revolution of 1688, and the wholesale confiscations of Catholic property by which that event was followed. From that time, the Catholics of Ireland may be said legally to have lost all social, political, and religious status in Ireland. Some attempts which were made in the latter part of the 18th c. to ameliorate their condition, excited, especially in the north, the alarm of the Protestant party, who regarded the traditional 'Protestant ascendancy' as endangered. Acts of violence became of frequent occurrence; and, as commonly happens, combinations for aggressive and defensive purposes were formed, not alone by the Protestants, but also by their Catholic antagonists. The members of the Protestant associations appear at first to have been known by the name of 'Peep-of-day Boys,' from the time at which their violences were commonly perpetrated; the Catholics who associated together for self-defence being called 'Defenders.' Collisions between armed bodies of these parties became of frequent occurrence. In 1785, a pitched battle, attended with much bloodshed, was fought in the county of



Armagh. The steps taken to repress these disorders were at once insufficient in themselves to prevent open violence, and had the effect of diverting the current into the still more dangerous channel of secret associations. The rude and illiterate mob of Peep-of-day Boys made way for the rich and influential organisation of the Orange Society, which, having its first origin in the same obscure district which had so long been the scene of agrarian violence, by degrees extended its ramifications into every portion of the British empire, and into every grade of society from the hovel to the very steps of the throne. The name of the Orange association is taken from that of the Prince of Orange, William III., and was assumed in honour of that prince, who, in Ireland, has been popularly identified with the establishment of that Protestant ascendancy which it was the object of the Orange association to sustain. The first 'Orange Lodge' was founded in the village of Loughgall, county Armagh, September 21, 1795. The immediate occasion of the crisis was a series of outrages by which Catholics were forcibly ejected from their houses and farms, 12 or 14 houses being sometimes, according to a disinterested witness, wrecked in a single night; terminating, September 1795, in an engagement, called from the place where it occurred, the Battle of the Diamond. The association which began among the ignorant peasantry soon worked its way upwards. The general disaffection towards English rule, which at that time pervaded Ireland, and in which the Catholics, as a natural consequence of their oppressed condition, largely participated, tended much to identify in the mind of Protestants the cause of disloyalty with that of popery; and the rebellion of 1798 inseparably combined the religious with the political antipathies. In November of that year, the Orange Society had already reached the dignity of a grand lodge of Ireland, with a grand master, a grand secretary, and a formal establishment in the metropolis; and in the following years, the organisation extended over the entire provinces of Ulster, and had its ramifications in all the centres of Protestantism in the other provinces of Ireland. In 1803, it extended to England. A grand lodge was founded at Manchester, from which warrants were issued for the entire kingdom. The seat of the grand lodge was transferred to London in 1821. The subject more than once was brought under the notice of parliament, especially in 1813; and, in consequence, the grand lodge of Ireland was dissolved; but its functions in issuing warrants, &c., were discharged vicariously through the English lodge. The most memorable crisis, however, in the history of the Orange Society was the election of a royal duke (Cumberland) in 1827 as grand master for England; and on the re-establishment of the Irish grand lodge in 1828, as imperial grand master. The Catholic Relief Act of the following year stirred up all the slumbering antipathies of creed and race, and the Orange association was propagated more vigorously than ever. Emissaries were sent out for the purpose of organising lodges, not alone in Wales and Scotland, but also in Canada, in the Mediterranean, and in the other colonies. But the most formidable part of this zealous propagandism was its introduction into the army. As early as 1824, traces of this are discoverable, and again in 1826. No fewer than 32 regiments were proved to have received warrants for holding lodges in Ireland, and the English grand lodge had issued 37 warrants for the same purpose.

The organisation of this strange association was most complete and most extensive. Subject to the central grand lodge, were three classes—county, district, and private lodges—each of which corresponded, and made returns and contributions to

its own immediate superior, by whom they were transmitted to the grand lodge. Each lodge had a master, deputy-master, secretary, committee, and chaplain. The only condition of membership was, that the party should be Protestant, and 18 years of age. The election of members was by ballot, and each lodge also annually elected its own officers and committee. The general government of the association was vested in the grand lodge, which consisted of all the great dignitaries, the grand masters of counties, and the members of another body called the grand committee. This lodge met twice each year, in May and on November 5—the day pregnant with associations calculated to keep alive the Protestant antipathies of the body. All the dignitaries of the society, as well as its various committees and executive bodies, were subject to annual re-election. In 1835, the association numbered 20 grand lodges, 80 district lodges, 1500 private lodges, and from 200,000 to 220,000 members. The worst result of the Orange association was the constant incentive which it supplied to party animosities and deeds of violence. In the north of Ireland, the party displays and processions were a perpetually recurring source of disorder, and even of bloodshed; and the spirit of fraternity which pervaded its members was a standing obstacle to the administration of the law. It was known or believed that an Orange culprit was perfectly safe in the hands of an Orange jury; and all confidence in the local administration of justice by magistrates was destroyed. These facts, as well as an allegation which was publicly made, of the existence of a conspiracy to alter the succession to the crown in favour of the Duke of Cumberland, led to a protracted parliamentary inquiry in 1835; and the results of this inquiry, as well as a very shocking outrage perpetrated soon afterwards by an armed body of Orangemen on occasion of a procession in Ireland, tended so much to discredit the association, and to awaken the public mind to a sense of the folly and wickedness of such associations, that its respectability has since that time gradually diminished. So great was the popular distrust of the administration of justice in party questions, that for several years the Lord Chancellor laid down a rule, by which no member of the Orange association was admitted to the commission of the peace; and although the association still subsists, it is comparatively without influence, except among the very lowest classes in the north of Ireland. Of the colonial offshoots of the Orange Association, those of Canada have at all times been the most active and the most flourishing. The Canadian Orangemen being, for the most part, Irish emigrants, carried with them all the bitterness of the domestic feud with the Roman Catholics. Outrages directed against Catholic churches, convents, and other institutions were of not unfrequent occurrence until recently; and on occasion of the late visit of the Prince of Wales to Canada, an attempt was made to force from his Royal Highness a recognition of the Association, which was only defeated by his own firmness, and by the judicious and moderate counsels of his advisers.—See *Reports on the Orange Association*, presented to parliament in 1835, from which the history of the society, down to that year, is for the most part taken.

ORATORIO (Ital. *oratorio*, chapel or oratory, the place where these compositions were first performed), a kind of sacred musical composition, either purely dramatic or partaking both of the drama and the epic, in which the text is illustrative of some religious subject, sometimes taken directly from Scripture; and the music consists of recitatives, arias, duets, trios, quartets, choruses, accompanied by an

orchestra, sometimes also by an organ, and introduced by an instrumental overture. The oratorio is not intended for scenic representation.

St Filippo Neri, born in 1515, has been considered the founder of the oratorio. He engaged poets and composers to produce dialogues, on subjects from scriptural and legendary history, in verse, and set to music, which were performed in his chapel or oratory on Sundays and church festivals. The subjects were *Job and his Friends*, *The Prodigal Son*, *The Angel Gabriel with the Virgin*, and *The Mystery of the Incarnation*. Stradella composed various oratorios, of which *San Giovanni Battista*, produced in 1670, is praised by Dr Burney. A number of oratorios, or *azioni sacre*, by Apostolo Zeno and Metastasio, were set to music by Caldara in the beginning of last century. Sebastian Bach's *Passions-Musik* was a species of oratorio, originally performed during the service of the church, the congregation joining in the chorales. Its form arose out of the practice prevalent in the Lutheran Church, of having the gospels for the day repeated on Good Friday, and some other festivals, by different persons in a recitative and dialogue style. By far the greatest master of oratorio was Handel, who perfected that species of composition, and was the first to introduce it into England. At the age of 20, when on a visit to Italy, he produced his oratorio of *La Resurrezione* at Rome. *Esther*, the first oratorio written by him in England, was composed for the chapel of his patron, the Duke of Chandos, in 1720, the words altered from Racine. It was performed privately at Cannons in the same year, but laid aside, and not produced in public till 1732. An oratorio was then so complete a novelty in England, that it was deemed necessary to give the following explanation in advertising it: 'By His Majesty's command, at the King's Theatre in the Haymarket, on Tuesday the 21 May, will be performed the sacred Story of Esther, an oratorio in English, composed by Mr Handel, and to be performed by a great number of voices and instruments.—N.B. There will be no acting on the stage, but the house will be fitted up in a decent manner for the audience.' For many years after the appearance of *Esther*, no more oratorios were produced by Handel, who devoted himself to operas and other secular music; and it was only after the temporary failure of his health, that at the ripe age of 53 he resumed the composition of oratorios. The great oratorios which have made his name immortal were all produced in the decline of life, some of them after he was afflicted with blindness, and they were performed for the most part in the Old Haymarket Theatre. *Deborah* was first performed in 1733; *Athaliah*, in 1734; *Israel in Egypt*, in 1738; *The Messiah*, in 1741; *Samson*, in 1742; *Judas Maccabæus*, in 1746; *Joshua*, in 1747; *Solomon*, in 1749; and *Jephtha*, in 1751. The two crowning works were *Israel in Egypt* and *The Messiah*—the former ranks highest of all compositions of the oratorio class. *The Messiah*—which, in consequence of its text being taken entirely from Scripture, was called by Handel *The Sacred Oratorio*—ranks very near it in point of musical merit, and has attained an even more universal popularity; from the time when it was first brought out, down to the present day, it has been performed for the benefit of nearly every important charitable institution in Britain. *Judas Maccabæus* is perhaps best known from the flowing and martial grace of that unrivalled military march, 'See the Conquering Hero Comes;' and *Saul* is associated in every one's mind with the most solemn of all funeral marches. The orchestra was but imperfectly developed in Handel's time, and his oratorios had therefore originally but

meagre instrumental accompaniments; they have since been generally performed with additional accompaniments written by Mozart. From Handel's time downwards, it was the practice in London to have oratorios performed twice a week during Lent in the various theatres, which were only given up on the institution of the oratorio performances at Exeter Hall. Haydn composed three oratorios—*The Return of Tobias*, *The Seven Last Words*, and *The Creation*. *The Seven Last Words*, a work full of sweetness and of energy, hardly answers to the common conditions of an oratorio; it is rather a series of symphonies, intended to follow as many short sermons on the sentences uttered by our Lord on the cross, the text being a subsequent addition by the composer's brother, Michael Haydn. *The Creation* originated in a visit of Haydn to London in 1791, when he heard for the first time some of the works of Handel, none of which were then known in Germany. Though less grand than the oratorios of Handel, it is full of fresh lovely songs, bright choruses, picturesque recitatives, and exquisite instrumentation. Beethoven's sole oratorio, *The Mount of Olives*, is a pure drama, rather than the mixed composition generally known under the name. Spohr's *Last Judgment*, produced in 1825, contains some grand music, particularly in the choruses. Costa's *Eli* deserves mention among modern oratorios. But since the time of Handel no other writer of oratorios has approached Mendelssohn. The greatest works of that composer are his oratorios of *St Paul* and *Elijah*; the former was first produced at Düsseldorf in 1836, the latter at Birmingham in 1846; and at the time of his death he was engaged in a third oratorio, called *Christus*, which he expected would be his greatest, and of which but a few fragments have been published. The oratorios of Mendelssohn have tended greatly to revive the popularity of this kind of composition in Britain. At Exeter Hall in London, and at the musical festivals throughout England, oratorios are performed on a large scale, and with a power, a precision, and a perfection unknown elsewhere. The choruses at the provincial festivals are, for the most part, supplied by Birmingham, Manchester, Leeds, and the other large towns. The greatest oratorio performances are now those of the Triennial Festivals at the Sydenham Crystal Palace. At the festival of 1862, the chorus amounted to 3120 voices, and there was an orchestra of 605 performers.

**ORATORIUM** (Lat. 'oratory,' called in Greek, *eukterion* or *proseukterion*), as contradistinguished from *ecclesia*, 'a church,' is the name given to an apartment or building designed for worship of a private or domestic character. From the earliest times, the use of oratoria is traceable in the history of the church; and before the regular organisation of parishes, they had probably a considerable place in the common, although not in the public worship. At a later period, oratoria became a common appendage of the castles and residences of the nobility, and were of two kinds; the first, simply for private or family prayer and other devotion; the second, for the celebration of mass. The latter fell properly under the jurisdiction of the bishop or the parochial clergy, and many jealousies and disputes grew out of their establishment or direction. The Council of Trent (Sess. xxii., *De Reformatione*), placed them under very stringent regulations, which have been enforced and developed by later popes, especially by Benedict XIV.

**ORATORY, CONGREGATION OF THE** The origin of this learned Congregation, and its early history, have been detailed under the head of **ST PHILIP NERI** (q. v.). It is remarkable, however, that this

extraordinary man, unlike most other founders of religious bodies in the Roman Catholic Church, had never committed to writing any definite body of rules for the government and direction of the brethren. Even his scattered papers, from which his plans and intentions might have been collected, had been burned by his orders a short time before his death. Soon after that event, the Fathers, at the instance of Baronius, compiled from the existing practices and from memory a rule for the Congregation, framed so as to embody the spirit of St Philip. This rule was approved of by Paul V. on February 21, 1612. The Fathers of the Congregation are a body of priests living in community, but without vows, and under a constitution of a highly democratical character. They are at liberty to withdraw at any time, and to resume possession of the property which they had brought with them at entrance; and even during their association, each member manages his own financial concerns, only contributing a fixed sum to the common expenses of the community. There is no superior-general, as in other orders. Each house is distinct and independent. In each, the superior is elected only for three years, and his position does not give him any personal pre-eminence whatever. The members take their places according to seniority, not according to official rank, and the superior is compelled to take his turn in all the duties, even down to the semi-menial office of serving in the refectory. The main occupations of the Fathers, beyond those of attending to the public service of the church, and the duties of the pulpit and the confessional, lie in the cultivation of theological and other sacred studies, of which 'conferences' for the discussion, in common, of theological questions, form a principal feature. The Congregation has produced many men of great eminence in sacred science, among whom have been already named the great church historian, Cardinal Baronius, and his continuators. To these may be added the celebrated explorers of the Roman catacombs, Bosio, Severani, and Aringhi; and the no less eminent patristical scholar, Gallandi. The houses of the Oratory in Italy before the Revolution were numerous, and in high repute. Few towns of any importance were without a house of the Oratory. The Congregation was early established in France by the celebrated Pierre (afterwards Cardinal) de Berulle, in common with two Italian Fathers, and from France it extended to the Low Countries. One important difference, however, is noticeable between the French Oratory and the Roman original. In the former, all the houses of the country are subject to a single superior-general. In France, also, the Oratorians took charge of seminaries and of theological teaching. The French Oratory, as well as the Italian, reckons many illustrious members; but the fame and utility of the French Congregation were much marred by the unhappy controversy about Jansenism. In the year 1847, this Congregation was introduced into England by Dr John Henry Newman (q. v.). Soon after his secession from Anglicanism, he established a house, the members of which were for the most part ex-Anglicans like himself, near, and finally at Birmingham; and soon afterwards, a second at London, which has since been transferred to Brompton.

ORBIS PICTUS (the *Pictured World*), the title of the first picture-book or illustrated manual of instruction for the young, by the celebrated educationist, Comenius, published at Nurnberg in 1657. It was long a great favourite with the youth of Germany, and continued to be reprinted, in various modified forms, down to recent times. Comenius, with the instinct of a great teacher, felt

that to give words without things to the pupil was not simply to retard his progress, but to lay the foundation of vague and inaccurate conceptions. Hence his introduction of the pictures of things into the work above named, which, among other things, was intended for those beginning the study of Latin, the connecting of the word with the picture tending to give the pupil a firmer hold or a quicker perception of both word and thing. The great and distinguishing merit of Comenius's book is, that it brought distinctly into notice the necessity of giving children in the earliest stages of their education, not simply a word, but the form of the thing of which the word was the symbol. A further advance on this idea was made by Pestalozzi, who aimed at presenting to the eye of the child the thing itself, whenever it was practicable to do so; and he regarded this as essential to the right education of the human faculties in their infancy. From this, again, flowed the excellent custom of giving Object Lessons in Infant Schools.

ORBIT, in Astronomy, is the path described in space by a heavenly body in its revolution round its primary.\* The path so described is of an elliptic form, and would be accurately an ellipse, were it not for the disturbing influence of the other heavenly bodies. See PERTURBATIONS. The complete determination of a planet's orbit is of the last importance to astronomers, as it enables them to predict the planet's place in the heavens at any period, and thus determine the exact date of eclipses of the sun and moon, of transits and occultations of the planets, and of the appearances and disappearances of comets. For the determination of a planet's orbit, it is necessary to know three things: 1. The situation of the *plane* of the orbit in space; 2. The position of the orbit in this plane; and 3. The situation at a given epoch, and rate of motion, of the planet in its orbit. Since the plane of the ecliptic is for convenience taken as the reference plane, the position of the plane of a planet's orbit is known when its inclination to the plane of the ecliptic (1), and the line of intersection of the two planes (2), are known. Since the sun, which is the focus of the planetary orbits, lies in this line of intersection, the orbit cannot lie wholly above or below the plane of the ecliptic, but must cut it in two points, called *Nodes* (q. v.), and the position of the line of intersection, or line of nodes, is generally given in terms of the longitude (or angular distance) of the ascending node, reckoning from the equinox. The situation of a planet's orbit in its plane is determined when we know its form (3), size (4), and the position of its major axis or line of apsides (5). The size and form of the orbit depend upon the length of its major and minor axes, but astronomers prefer to employ the major axis and eccentricity (see ELLIPSE); and the position of the major axis is known by determining the heliocentric longitude of its *perihelion* (i. e., the extremity of it which is nearest the sun). To complete our knowledge of a planet's motion, all we now require are the epoch of its appearance at some determinate point of its orbit, say, at the perihelion (6), and the velocity of its motion in its orbit (7), for when this last is known, the law of areas, as given in Kepler's second law, enables us to determine the position of the planet in its orbit at any future period. These seven facts, the possession of which gives us a complete clue to a planet's motion, are called the seven 'elements of a planet's orbit.' What has been here stated concerning the planetary orbits, is equally

\* The sun is the primary of the planets and comets, and each planet is the primary of its satellites (secondary planets).

true of the orbits of the comets and satellites, though, in the case of the latter, the effect of disturbing forces is so great as to produce a considerable change of the elements in one revolution.

**O'RGHARD** (Goth. *aurtigards*, Middle High Ger. *saurgarte*, Ang.-Sax. *vyrtjeard*, *ortgeard*, a yard or garden for worts or vegetables), a piece of ground specially devoted to the growth of fruit-trees, and in which these are planted as near to each other as their profitable cultivation will admit of, no space being left for culinary vegetables, as in the fruit-garden. The introduction of such crops to any considerable extent is injurious to the trees of an orchard, by exhausting the soil, and the vegetables produced are not good. In some orchards, the soil is regularly digged, and manure pretty freely supplied, the trees being *dwarf standards*, trained to a low and bushy form, in rows about twelve feet apart, with rows of gooseberries, currants, or raspberries between them. Such orchards are often very productive, and are not liable to suffer much from winds, whilst the trees also protect each other from frosts in spring. Other orchards are formed in old pastures, the turf being replaced when the trees are planted, or, if they are formed on land that has been under the plough, it is sown down with grass. In these, also, manure is occasionally given. In many cases, the grass of orchards is employed for pasturing cattle or sheep, the trees being standards or half-standards, with stems so tall that their branches are beyond the reach of the animals, and in this way the grass produced by the soil is returned to it in the form of manure. In forming orchards of this kind, it is not unusual to plant the *stocks*, upon which the proper grafts or buds are afterwards inserted. Great orchards of this kind exist in Devonshire, Herefordshire, and some other southern counties of England, devoted to the growth of apples for the production of cider, and to a smaller extent, of pears for the production of perry. Orchards are not so common in Scotland as in England, where they are not only frequent appendages of the manor-house, but even of the farm-house. Apples, pears, plums, and cherries, not of the finest kinds, are the fruits chiefly produced in British orchards, although some in England also yield walnuts, chestnuts, medlars, mulberries, quinces, &c., and there are even a few small fig-orchards in the most southern parts. Fig and peach orchards are very common in the more southern parts of Europe; and oranges, lemons, &c., on the shores of the Mediterranean.

An orchard requires a dry soil, which ought also to be free and open, not a stubborn clay. A gentle slope, exposing it to the sun, is preferable to perfectly level ground. Protection from prevalent winds, especially in Britain from the south-west winds which often blow strongly in autumn, is very necessary; but it is not less important that there should be a free circulation of air, in default of which the trees become covered with lichens and mosses, and cease to be productive. An orchard is often surrounded by a hawthorn-hedge, but a small orchard must not have a very high hedge. Forest trees are often planted as a screen, but must not be too near. Where walnut and chestnut trees will ripen their fruit, they are often planted, on the side most exposed to winds, for shelter.

In laying out the ground for an orchard, it is not unusual to form it into ridges, on the crown of which the trees are planted. But, however this may be, the trees are planted in rows running north and south, so that the rays of the sun may penetrate among them somewhat equally. In planting the trees, their roots are spread out as much as possible, as it is found desirable to encourage

them to extend near the surface, rather than to penetrate deep into the ground, particularly where no digging or cropping is intended. The remarks on soil and manures in the article **FRUIT-GARDEN** are applicable also to orchards.

The districts of Scotland most celebrated for their orchards are a portion of Clydesdale (Lanarkshire) and the Carse of Gowrie (Perthshire), in both of which the apple-orchards are of very considerable economical importance.

**ORCHARD-HOUSE**, a structure adapted to the cultivation of fruits, of finer kinds than can be produced in the open air, or in greater perfection, without the aid of artificial heat. It is the invention of Mr Rivers of London, and is a 'glass-roofed shed,' the front of which is lower than the back, so that the roof slopes towards the sun. The merit of the invention, however, consists not so much in the structure itself, or in the protecting of fruit-trees and admitting of the sun's rays by glass, as in the mode of their treatment, by which a limited space can be made to produce a prodigious quantity of fine fruit. The trees are planted in pots, are never allowed to attain a considerable size, and are so trained and pruned as to have the greatest possible amount of fruitful wood within the smallest possible compass. The pots have a large hole in the bottom, through which the roots may pass; and are placed upon a border carefully prepared for them, of loose and open materials, such as cinders, lime-rubbish, and broken bricks, enriched by manure. After the fruit is gathered, the roots are cut through at the bottom of the pot, and the trees are set aside to rest for the winter; and this treatment is repeated from year to year. The orchard-house is generally a very low structure, so that the foliage and fruit are very near the glass; its back being only 7 feet high, and its front only 2½ feet, for a width of 12 feet. A path is excavated as a trench of 2 feet deep, and 2½ feet wide, through the middle of it. For details as to glazing, ventilation, &c., we refer to Mr Rivers's pamphlet, *The Orchard-house*, and to Chambers's *Information for the People*, i. pp. 575, 576. Plants for orchard-houses may now be purchased in nurseries. In the pamphlet of Mr Rivers, instructions will be found as to the training and treatment of different kinds of trees.

**O'RGHESTRA** (Gr. *orchēstra*, from *orchēomai*, I dance), in the Greek theatres, the place allotted to the chorus of dancers; in modern theatres, the part of the building assigned to the instrumentalists; and in the modern concert-room, the place occupied by the instrumental and vocal performers. The word orchestra is also used to denote the musicians collectively.

A complete orchestra consists of stringed and wind instruments, and instruments of percussion. The employment of stringed and wind instruments together was long deemed a barbarism. Glück was among the first composers who shewed that they could be effectively combined, and his ideas were more fully developed by succeeding composers. The perfecting of the old instruments, and the introduction of new ones, formerly confined to military bands, have added immensely to the power and resources of the modern orchestra, whose capacities, however, have sometimes been misused.

The proper strength of an orchestra must depend on considerations connected with the locality. The stringed instruments should in all cases greatly outnumber the wind instruments; and those latter, the instruments of percussion. The stringed instruments in general use are the violin, viola, violoncello, and double-bass, and their force often amounts to as many as fifty, while even in a large orchestra

there are seldom more flutes, hautboys, or bassoons than two of each. The horn, trumpet, and ophicleide or serpent, the other wind instruments admitted into the orchestra, are used as sparingly; and of instruments of percussion, a pair of kettle-drums is often considered sufficient, though cymbals and triangles are occasionally added. In a small orchestra, trumpets, trombones, the serpent, and the kettle-drum should be avoided as being too noisy. By far the greatest part of the work falls to the share of the stringed instruments, the parts for which form a complete quartett for first violin, second violin, viola, and violoncello, which should be perfect within itself, independently of the parts for the wind instruments. The object of the double-bass is to enforce the violoncello part. This full quartett is occasionally interrupted by harmony in two or three parts, or passages in unisons or octaves. The success of the combination of wind and stringed instruments depends on the skill and judgment of the composer. The bassoon, horn, or flute may double any given part of the stringed instrument quartett, so as to produce an effect of reinforcement, or it may have its own distinctive melody. An occasional variety is produced by the entire cessation of stringed instruments for a short period, letting the wind instruments be heard alone.

The orchestra of a concert-room should be so arranged that the front is about five feet above the level of the floor, and it should rise gradually in steps towards the end wall, whose angles ought to be rounded off so as to enable the whole body of sound to be reflected. Reverberation is essential to the proper effect of music. From the exigencies of dramatic representation, a theatrical orchestra must necessarily be much inferior to a concert orchestra; the instrumentalists, brought together in the lowest part of a theatre on a horizontal plane between the spectators and the stage, are deprived of most of the advantages arising from a proper arrangement.

ORCHIDÆ, or ORCHIDACEÆ, often popularly called ORCHIDS, a natural order of endogenous plants, remarkable for the structure of their flowers, which are also of great beauty and exquisite fragrance. The perianth sometimes exhibits much variety of forms, even in the same species; but is always irregular, its segments differing much from each other. There are usually six segments, arranged in two rows (*calyx* and *corolla*); although some of the most extraordinary forms of orchideous flowers are produced by the combination of certain segments into one piece. Spurs and other appendages of some of the segments are also common. The inner segments are often beautifully coloured. The inferior segment of the corolla is called the lip (*labellum*), and is often lobed, spurred, or furnished with curious appendages of different kinds. The stamens are united with the style into a single central column; the distinctive character of the Linnean class *Gynandria*, of which the *O.* form the chief part. There is usually only one anther, with a tubercle on each side of it, the tubercles being abortive anthers; but sometimes the two lateral anthers are perfect, and the central one is abortive; and very rarely all the three anthers are perfect. The anthers are usually two-celled; the grains of pollen cohering in two or more masses. The ovary is inferior, one-celled; the stigma usually a mere hollow in front of the column. The fruit is usually a capsule, opening with six valves, three of which have placentæ; the seeds numerous and very small. In a few cases, the fruit is fleshy. The *O.* are generally herbaceous perennials; but some of those found in warm

climates are shrubs, and some of these, as *Vanilla*, are climbers. The root is usually composed of simple, cylindrical fibres, which are often accompanied with one or two fleshy tubercles, a tubercle dying and a new one being produced annually.



Orchis morio :  
a, parts of the flowers.

The leaves are always simple, alternate, often sheathing at the base, often leathery, sometimes arising, in tropical species, not directly from the stem, but from fleshy bulb-like excrescences of it.—The species of *O.* are very numerous, about 3000 having been described. They are found in all parts of the world, except the coldest and the most arid regions; but are most numerous in the humid forests of the torrid zone, and particularly in America. Many of them are epiphytes, adorning the boughs of trees with splendid flowers. This is chiefly the case with tropical species, those of colder climates mostly growing on the ground. Only about thirty-eight species are reckoned in the British flora.—*SALEP* (q. v.), a delicate and nutritious article of food, is obtained from the root-tubercles of a number of species. The only other product of the order, which is of any commercial importance, is *Vanilla* (q. v.). The fragrant *Faam* (q. v.) leaves are the leaves of an orchid. Several species are known to possess tonic, stimulant, and antispasmodic properties, but none are of much importance in medicine.

Orchids have of late been much cultivated on account of their flowers, and many tropical species are amongst our most esteemed hothouse plants; houses being sometimes specially devoted to them. Many of the epiphytal kinds may be planted in pots filled with loose fibrous peat, the roots of others are placed in baskets, or are fastened to blocks of wood, with a little moss or some such thing around them, to keep them from becoming too dry, and are thus placed on the shelves, or suspended from the roof of the house. Careful attention to temperature is necessary, and also to ventilation; and although much heat and moisture are requisite, the atmosphere must not be constantly very hot and humid, but seasons of rest must be given to the plants, which in their native climates have generally a wet and a dry season, the latter being to them in many respects what the winter is to plants of temperate regions.

## ORCHIL AND ORCHELLA WEED—ORDEAL.

Lindley has particularly signalised himself in the study of this interesting order of plants.

**ORCHIL AND ORCHELLA WEED.** See **ARCHIL.**

**ORCHIS** is a genus of *Orchideæ*, to which, as now restricted, eleven of the British species are referred. Some of them are among the most common of British *Orchideæ*, adorning meadows and pastures with their flowers in summer. The roots



Orchis mascula :  
a, the lip of the perianth.

of some of the species yield salep. The lip of the flower in this genus has a spur. The flowers of the Early Purple O. (*O. mascula*), one of the most common species, are sometimes fragrant; but those of the Lizard O. (*O. hircina*), found in chalky districts in the south of England, are remarkable for their disagreeable goat-like or lizard-like smell.

**ORCHOMENOS**, a famous and very ancient city of Bœotia, the capital of the once independent kingdom of the Minyæ, and hence called Minyean O., to distinguish it from another O. in Arcadia. It was situated northward from the Lake Copais, on the left bank of the Cephissus, and extended from the marshy edges of the lake up the face of a steep rocky hill, on which stood the Acropolis. In the earliest times, its dominions extended to the sea. Homer compares its treasures to those of Egyptian Thebes, and tells us that it sent 30 ships to the Trojan war. Some time after this event, it became a member of the Bœotian confederacy. During the Persian war, like the other towns of Bœotia, it abandoned the national cause. Its government was thoroughly aristocratic, and after the Peloponnesian war, when Thebes became a democracy, O. took part with Sparta, and shared in its first triumph over Thebes; but the victory of Epaminondas at Leuctra (371 B.C.) placed O. at the mercy of the Thebans, who soon after destroyed it by fire, and sold its inhabitants as slaves. It was again rebuilt during the Phœcian war, but a second time destroyed in the reign of Philip of Macedon, who, however, once more rebuilt it; but it never again became prominent in history. O. was famous for its great musical festival in honour of the Graces, when poets and musicians assembled from all quarters to compete for prizes. The ruins of O. are still to be seen near the modern village of Skripû.—See K. O.

Müller's *Orchomenos und die Minyer*, Leake's *Northern Tour in Greece*, and Mure's *Tour in Greece*.

**ORCIN AND ORCEIN** are colouring matters obtained from lichens. Orcin ( $C_{14}H_6O_4 + 2Aq$ ) may be obtained by boiling certain species of *Roccella* or *Lecanora* with lime for some hours, removing the lime, by a current of carbonic acid, evaporating and extracting with boiling alcohol, from which the orcin separates in red crystals. With chloride of lime, it gives a purple red colour, which quickly changes to a deep yellow. Orcin is the true colour-producing substance or chromogen of these lichens. In the presence of ammonia, it absorbs oxygen, and is converted into *orcein* ( $C_{14}H_7NO_5$ ), a nitrogenous compound of strong tinctorial power. When isolated, orcein forms a red flocculent powder, which is freely soluble in alcohol, forming a scarlet fluid. Potash and ammonia dissolve it readily, forming a splendid purple colour, which is the basis of the ordinary archil of commerce. With metallic salts, its alkaline solutions yield beautiful purple lakes.

**ORDEAL** (Anglo-Saxon, *ordaal*; from *or*, primitive, and *daal*, judgment; Ger. *Urtheil*, judgment), a practice which has prevailed largely among various widely-separated nations, of referring disputed questions, particularly such as relate to the guilt or innocence of an individual, to the judgment of God, determined either by lot, or by the success of certain experiments. Of its existence among the ancient Jews, we have an instance in Numbers v., where a Hebrew woman, accused of adultery, is required to drink the waters of jealousy as a test of innocence; a similar ordeal for incontinence is in use among the natives of the Gold Coast of Africa. Compurgation of accused persons by fire, as existing among the Greeks, is referred to in Sophocles's *Antigone*. Among the Hindus, the ordeal has been in use to be practised in nine different ways—by the *balance*, by *fire*, by *water*, by *poison*, by the *cosha* or drinking water, in which images of the sun and other deities had been washed, by *chewing-rice*, by *hot oil*, by *red-hot iron*, and by drawing two images out of a jar into which they have been thrown. (*Asiatic Researches*, vol. i. p. 339.)

The ordeal seems to be prevalent throughout Africa. 'When a man,' says Dr Livingstone, 'suspects that any of his wives have bewitched him, he sends for the witch-doctor, and all the wives go forth into the field, and remain fasting till that person has made an infusion of the plant (called "goho"). They all drink it, each one holding up her hand to heaven in attestation of her innocence. Those who vomit it are considered innocent, while those whom it purges are pronounced guilty, and put to death by burning. The innocent return to their homes, and slaughter a cock as a thank-offering to their guardian spirits. The practice of ordeal is common among all the negro nations north of the Zambesi.' The women themselves eagerly desire the test on the slightest provocation; each is conscious of her own innocence, and has the fullest faith in the *muavi* (the ordeal) clearing all but the guilty. There are varieties of procedure among the different tribes. The Barotse pour the medicine down the throat of a cock or dog, and judge of the innocence or guilt of the person accused by the vomiting or purging of the animal.

Throughout Europe in the dark ages the ordeal existed under the sanction of law, and of the clergy. The most prevalent kinds of ordeal were those of *fire*, *water*, and the *wager of battle*. *Fire ordeal* was only allowed to persons of high rank. The accused had to carry a piece of red-hot iron for some distance in his hand, or to walk nine feet barefoot and blindfolded over

red-hot ploughshares. The hand or foot was bound up and inspected three days afterwards: if the accused had escaped unhurt, he was pronounced innocent; if otherwise, guilty. Under such a judicial system, there were probably few acquittals; but it is believed that in the severer kinds of ordeal, precautions were sometimes taken by the clergy to protect those whom they wished to clear from suspicion. Queen Emma, mother of Edward the Confessor, when suspected of a criminal intrigue with Alwyn, Bishop of Winchester, is said to have triumphantly vindicated her character by walking unhurt over red-hot ploughshares. *Water ordeal* was the usual mode of trial allowed to bondsmen and rustics, and was of two kinds—the ordeal of *boiling water*, and of *cold water*. The ordeal of *boiling water*, according to the laws of Athelstane, consisted in taking a stone out of boiling water, where the hand had to be inserted as deep as the wrist; what was called the triple ordeal, deepened the water to the elbow. The person allowed the ordeal of *cold water* (the usual mode of trial for witchcraft), was flung into a river or pond; if he floated without any appearance of swimming, he was judged guilty—while if he sank, he was acquitted.

The *wager of battle* was a natural accompaniment of a state of society which allowed men to take the law into their own hands. The challenger faced the west, the challenged person the east; the defeated party, if he craved his life, was allowed to live as a 'recreant;' that is, on retracting the perjury which he had sworn to. See **BATTEL, TRIAL BY.**

Other kinds of ordeal were practised in particular circumstances in different parts of Europe. In the ordeal of the *bier*, a supposed murderer was required to touch the body of the murdered person, and pronounced guilty if the blood flowed from his wounds. The ordeal of the *Eucharist* was in use among the clergy: the accused party took the sacrament in attestation of innocence, it being believed that, if guilty, he would be immediately visited with divine punishment for the sacrilege. A somewhat similar ordeal was that of the *corned*, or consecrated bread and cheese: if the accused swallowed it freely, he was pronounced innocent; if it stuck in his throat, he was presumed to be guilty. Godwin, Earl of Kent, in the reign of Edward the Confessor, when accused of the murder of the king's brother, is said to have appealed to the ordeal of the corned, and been choked by it. An early form of ordeal, abolished by Louis le Debonnaire in 816, was that of the *cross*: the accuser and accused stood upright before a cross, and he who first fell, or shifted his position, was pronounced guilty. It was done away with, as being irreverent towards the mystery of the cross. Besides these, there was the ordeal by *lot*, dependent on the throw of a pair of dice, one marked with a cross, the other plain.

Trial by ordeal at first carried with it the sanction of the priests, as well as of the civil power, though the clergy in the course of time came to discountenance it. In England it seems to have been continued till the middle of the thirteenth century. On the continent it was, generally speaking, abolished rather earlier, although as late as 1498 we find the truth of Savonarola's doctrine put to the test, by a challenge between one of his disciples and a Franciscan friar, to walk through a burning pile. In Scotland, in 1180, we find David I. enacting, in one of the assemblies of the frank tenantry of the kingdom, which were the germ of parliaments, that no one was to hold an ordinary court of justice, or a court of ordeal, whether of battle, iron, or water, except in presence of the

sheriff or one of his sergeants; though if that official failed to attend after being duly summoned, the court might be held in his absence. The first step towards the abolition of this form of trial in Saxon and Celtic countries, seems to have been the substitution of compurgation by witnesses for compurgation by ordeal. The near relatives of an accused party were expected to come forward to swear to his innocence. The number of compurgators varied, according to the importance of the case; and judgment went against the party whose kin refused to come forward, or who failed to obtain the necessary number of compurgators. To repel an accusation, it was often held necessary to have double the number of compurgators who supported it, till at length the most numerous body of compurgators carried the day.

**ORDER.** In Classic Architecture, the Order or ordonnance comprises the column with its base and capital and the entablature. There are five orders: (1) Tuscan, (2) Doric, (3) Ionic, (4) Corinthian, (5) Composite. The first and fifth are Roman orders, and are simply modifications of the others. The remaining three are the Greek orders. See **COLUMN, GREEK ARCHITECTURE, ROMAN ARCHITECTURE.**

**ORDER**, in Natural History, a group constituted for the purpose of classification, inferior to *class* and *sub-class*, but superior to *family*, *tribe*, *genus*, &c. The term **NATURAL ORDER** is used in botany to designate an order belonging to the natural system of classification, in contradistinction to one of an artificial system devised for mere convenience of the student, and signifies that the limits of the order agree with the truth of nature, and that it thus exhibits affinities really existing. In all branches of natural history, classification now proceeds on this principle.

**ORDER.** This word is applied to an aggregate of conventual communities comprehended under one rule, or to the societies, half military half religious, out of which the institution of knighthood sprang. Religious orders are generally classified as monastic, military, and mendicant.

The earliest comprehension of monastic societies under one rule was effected by St Basil, Archbishop of Cæsarea, who united the hermits and cenobites in his diocese, and prescribed for them a uniform constitution, recommending at the same time a vow of celibacy. The Basilian rule subsists to the present day in the Eastern Church. Next in order of time was the Benedictine order, founded by St Benedict of Nursia, who considered a mild discipline preferable to excessive austerity. The offshoots from the Benedictine order include some of the most important orders in ecclesiastical history, among others the Carthusians, Cistercians, and Præmonstrants. The order of Augustinians professed to draw their rule from the writings of St Augustine; they were the first order who were not entirely composed of laymen, but of ordained priests, or persons destined to the clerical profession.

The military orders, of which the members united the military with the religious profession, arose from the necessity under which the monks lay of defending the possessions which they had accumulated, and the supposed duty of recovering Palestine from the Saracens, and retaining possession of it. The most famous orders of this kind were the Hospitallers or Knights of St John of Jerusalem, the Knights Templars, and the Teutonic order. Many other military orders existed, and not a few continue to exist, particularly in Spain and Portugal. The phraseology of the old military orders is preserved in the orders of knighthood of modern

## ORDERICUS—ORDERS IN COUNCIL

times, into which individuals are admitted in reward for merit of different kinds, military and civil.

The three mendicant orders of Franciscans, Dominicans, and Carmelites were instituted in the 13th century. Their principal purpose was to put down the opposition to the church, which had begun to shew itself, and also to reform the church by example and precept. At a later period the order of the Jesuits was founded, with the object of increasing the power of the church, and putting down heresy.—Notices of the more important orders, monastic, military, and mendicant, will be found under separate articles. See also **KNIGHTS and MONACHISM**.

**ORDERICUS, VITALIS**, a medieval historian, born at Atcham, near Shrewsbury, in 1075, was taken to France at the age of five, and educated for the monastic life in the abbey of Ouche, at Lisieux. He became a priest in 1107, and died, it is thought, about 1143. O. is the author of a so-called Church History (*Historia Ecclesiastica*), in 13 vols. It is a chronicle of events from the birth of Christ down to his own time. Books 3—6 give an account of the Norman wars in England, France, and Apulia down to the death of William the Conqueror. The last half of the book is the most valuable, being a record of the history of the author's own times. The first edition of the *Historia Ecclesiastica* was published by Duchesne, in his *Hist. Norm. Scrip.* (1619). It has also been printed by the French Historical Society (2 vols. 1840), and was translated into French by Dubois (4 vols. 1825—1827).

**ORDERLIES** are soldiers or sergeants appointed to wait upon general and other commanding officers, to communicate their orders, and to carry messages. The *Orderly Officer*, or officer of the day, is the officer of a corps or regiment, whose turn it is to superintend its interior economy, as cleanliness, the goodness of the food, &c. *Orderly Non-commissioned Officers* are the sergeants in each company who are 'orderly,' or on duty for the week. On the drum beating for orders, they proceed to the Orderly Room, take down the general or regimental orders affecting their respective companies, shew them to the company officers, and warn the necessary men for any duties specified in those orders. An *Orderly Boat* is provided by the captain of each troop or company in a regiment for the insertion of general or regimental orders from time to time issued.

**ORDERS, ARMY**, are general, divisional, brigade, or regimental. General orders are issued by the commander-in-chief of an army, and affect the whole of his force. The others emanate from generals of division or brigade, or from officers commanding regiments, and severally affect their respective commands.

**ORDERS IN COUNCIL**, orders by the sovereign with the advice of the privy council. The privy council of Great Britain has no power to legislate, except so far as authorised to do so by parliament; but in periods of emergency, it has nevertheless occasionally issued and enforced orders of a legislative kind; those who were concerned in passing, promulgating, or enforcing the orders, trusting to parliamentary protection, and taking on themselves the personal responsibility of the proceeding. In such cases, an act of indemnity afterwards passed has relieved from liability those who advised the order or acted under it, and given compensation to all who suffered by its enforcement. This course was adopted in 1766 with regard to an embargo on the exportation of corn, issued in consequence of a deficient harvest and prospect of famine. An important constitutional question was raised by the famous Orders

in Council issued by Great Britain in 1807 and 1809, in reprisal for Napoleon's Berlin and Milan decrees. The Berlin decree, issued on the 21st of November 1806, declared the whole of the British islands to be in a state of blockade, and all vessels trading to them to be liable to capture by French ships. It also shut out all British vessels and produce both from France and from all the other countries which gave obedience to the French. A subsequent decree, issued soon afterwards, obliged all neutral vessels to carry letters or certificates of origin—that is, attestations by the French consuls of the ports from which they had sailed, that no part of the cargo was British. In retaliation for the Berlin decree, the British government issued, on the 7th January 1807, an Order in Council, subjecting to seizure all neutral vessels trading from one hostile port in Europe to another with property belonging to an enemy. This order was at first extensively evaded, while the French made vigorous efforts to enforce the Berlin decree; the result was, that new Orders were issued by the British government on the 11th and 21st of November 1807, declaring France and all states subject to the French to be in a state of blockade, and all vessels liable to seizure which were found to have certificates of origin on board, or which should attempt to trade with any of the ports of the world thus blockaded. Neutral vessels intended for France, or any other hostile country, were ordered, in all cases, to touch first at some British port, and to pay custom-house dues there, after which they were in certain cases to be allowed to depart for their destination; and vessels clearing from a hostile country were similarly to touch at a British port before proceeding on their voyage. On the 27th of December 1807, Napoleon's Milan decree was issued, which declared the whole British dominions to be in a state of blockade, and all countries were prohibited from trading with each other in any articles of British produce or manufacture. The Americans, and those of the public of Great Britain who were interested in the export trade, exclaimed loudly against the edicts of both powers, and the legality as well as the expediency of the Orders in Council were called in question in parliament. The result was, that an inquiry was instituted into the effect of the orders, from which no direct result followed. But, in the meantime, on the 26th April 1808, a new Order in Council was issued, limiting the blockade to France, Holland, a part of Germany, and the north of Italy, and the order which condemned vessels which had certificates of origin on board was rescinded. Subsequent orders introduced a system of furnishing licences to vessels to proceed to hostile ports after having first touched and paid custom-house dues at a British port; no fewer than 16,000 of these licences are said to have been granted. The legality of these Orders has been called in question, on the ground that they were more of a legislative than an executive character, in so far as a fictitious blockade, where there is no blockading force present, is contrary to the law of nations; it has been defended on the ground that they were issued in execution of the royal prerogative of declaring and conducting war. They are generally believed to have added to the general distress, and the check on the progress of manufactures produced by Napoleon's decrees; but, on the other hand, it has been maintained that they were essential to the effective prosecution of the war.

There are various matters connected with trade and the revenue as to which Orders in Council have been authorised by statute; parliament, in



fact, delegating its legislative authority to the Queen in Council. For example, the International Copyright Act, 7 and 8 Vict. c. 12, contains a provision for empowering the crown, by Order in Council, to extend the privileges of British copyright to works first published in any state which gives a like privilege to the productions of this country.

**ORDERS, HOLY**, an institution regarded in the Greek and Roman churches as a sacrament, by which ministers are specially set apart for the service of religion, and are regarded as receiving a certain religious consecration, or, at least, designation for their office. While some of the reformed churches altogether deny the distinction of ranks in the ministry, none of them admits more than three ranks, of bishop, priest, and deacon. But in the Roman and Greek churches, a further classification exists. In the Roman Church, a distinction is made between the major (or holy) orders and the minor orders. Of the major orders, three have been described in general terms, under the head **HIERARCHY** (q. v.), viz., the classes of bishops, priests, and deacons. A fourth rank of sub-deacons is generally regarded as one of the major orders, but its functions closely resemble in their nature and their degree those of the deacon. The minor orders in the Roman Church are four in number—those of door-keeper, reader, exorcist, and acolyte. To none of these orders is any vow of celibacy annexed. Some of their functions had their origin in the peculiar religious condition of the early church. The duties of door-keeper arose chiefly out of the discipline in regard to the penitents and catechumens; but although these functions find no room in the modern discipline of the Roman Church, the door-keeper of the modern church is held to succeed to other functions of his ancient prototype in relation to the catechetical instruction of children and of the poor and ignorant. Preparatory to the receiving of these orders, candidates are initiated in what is called the *Tonsure*, which consists in the cutting off of the hair, as a symbol of separation from the world and its vanities—a rite which appears also as one of the ceremonies of the religious profession. Tonsure, however, is not reckoned as an order; it is but a distinguishing characteristic of a class. In the Roman Church, the sacrament of orders is held to produce an indelible character, and therefore to be incapable of being forfeited and of being validly repeated. This, however, applies only to the holy orders. The Greek Church has the distinction of major and minor orders, in common with the Roman. But the Greeks commonly exclude sub-deaconship from the major orders, and all the functions of the four minor orders of the Roman Church are united by the Greeks in one single order, that of reader (*anagnostes*).

In the Anglican and other Reformed Episcopal Churches, the three higher orders of bishop, priest, and deacon are alone retained. An Anglican clergyman may be deprived of his benefice, or suspended by his bishop for various ecclesiastical offences; and the right of the Court of Arches to pronounce sentence of deprivation has also been recognised. But in the usual case of deprivation, the clergyman does not forfeit his status of priest or deacon, which can only be lost by deposition or degradation. Statute 23, Hen. VIII, c. 1. s. 6, reserves to the ordinary the power of degrading clerks convicted of treason, petit treason, murder, and certain other felonies before judgment. A bishop may be deprived of his see by his metropolitan, with or without the co-operation of a synod of the bishops of the province, but it has been questioned whether he can be lawfully

deprived of his orders as bishop. A clergyman of the Church of England and Ireland cannot become a member of the House of Commons. In the Presbyterian and other non-episcopal churches, the ceremony of ordination is not held to impart any indelible character. A minister found guilty of heresy or immorality, is deprived of his office by deposition, by which his clerical status is forfeited. His removal from his charge, however, in any other way, does not affect his office as a minister; and a minister removed from one charge to another, or, after a time, inducted into a new charge, is not re-ordained. A minister having no charge or flock, may yet dispense the sacraments, if duly called upon. A minister deposed ceases altogether to be a minister, and is no more capable of any of the functions of the office, than if he had never been ordained.

The ceremony of *imposition of hands* is used in almost all Protestant churches in the ordination of ministers, the ordaining bishop or presbyters placing the right hand on the head of the person ordained; and is always accompanied with prayer. It is deemed a proper and Scriptural form (1 Tim. iv. 14), but not essential.

In the Church of Scotland and other Presbyterian churches, when an already ordained minister is inducted into a new charge, no imposition of hands takes place. In the Scottish and American Presbyterian churches, candidates for the ministry are licensed to preach the gospel before being called to any particular charge, and are then styled *licentiates* or *probationers*. They are licensed, according to an old phrase, 'for trial of their gifts,' but are not entitled to dispense the sacraments.

There is nothing to prevent a minister of the Church of Scotland, or any Presbyterian or Independent church, from being a member of the British House of Commons.

**O'RDINAL**, the service used in Episcopal churches for the ordination of ministers. The English ordinal was drawn up by a commission appointed in the third year of Edward VI. (1550), and added to the *Book of Common Prayer*. It was slightly modified in the reign of Elizabeth, and was again revised by the Convocation of 1661. The English ordinal, in its general structure, resembles the ancient services used for that purpose, but possesses much greater simplicity, and has some features—e. g., the numerous questions addressed to the candidates—peculiar to itself. There are separate services for the 'making of deacons' and the 'ordering of priests,' but these are practically joined in one, and used on the same day. The service for the consecration of bishops is altogether distinct.

The ordination takes place at one of the Ember seasons, and during the public service, after morning prayer and a sermon on the subject, and begins with the presentation of the candidates by the arch-deacon. The bishop inquires as to their fitness, and commends them to the prayers of the congregation. The litany is then said with special petitions for the candidates for each order, and the communion service commences with a special collect, epistle, and gospel. Between the epistle and gospel, the oath of supremacy is administered, and the candidates for deacons' orders are questioned by the bishop and ordained. The gospel is read by one of the newly-ordained deacons. The candidates for priests' orders are then solemnly exhorted and interrogated, and the prayers of all present are asked for the divine blessing upon them. For this purpose a pause is made in the service for silent prayer. After this the hymn, *Veni Creator Spiritus* (Come, Holy Ghost, our Souls Inspire)—a composition of great antiquity, supposed to be as old as the

4th c.—is sung, and the candidates kneeling before the bishop, he and the assistant presbyters lay their hands upon the head of each, with the words, 'Receive the Holy Ghost for the office and work of a priest in the Church of God,' &c.

The only other ceremony is the presentation of each candidate with the Bible in token of authority to preach; as the deacons had been before presented with the New Testament with authority to read the gospel. The service concludes with the administration of the sacrament of the Lord's Supper.

The consecration of bishops is performed by an archbishop, or some bishop appointed in his place, and two or more of his suffragans, and may take place on any Sunday or holy day. The service is very similar to that for the ordination of priests.

**ORDINARIES, or HONOURABLE ORDINARIES**, in Heraldry, certain charges composed of straight lines, and in very common use, to which writers on heraldry had assigned abstruse symbolical meanings, but whose real chief peculiarity seems to be that they originally represented the wooden or metal fastenings of the shields in use in actual warfare. The ordinaries are usually accounted nine—the Chief, Pale, Fess, Bar, Bend, Bend Sinister, Chevron, Saltire, and Cross. Heralds vary a little in their enumeration, some taking in the Pile in place of the Bar. Each is noticed under a separate article.

**ORDINARY**, a term used in the British navy in two senses. First, as regards ships, vessels in ordinary are those out of actual use, commonly dismasted, and occasionally roofed over, to protect them from the weather. They are congregated near the several dockyards, where their masts and gear lie ready for their immediate fitting for sea when required. A few men have charge of each vessel; a certain number of vessels constitute a division, with a lieutenant in command; and a line-of-battle-ship, called a 'guard-ship of ordinary,' is responsible for the different divisions at each port. The ships are moored in safe places, as up the Medway, in the recesses of Portsmouth and Plymouth harbours, &c.

As regards men, an *ordinary seaman* is one capable of the commoner duties, but who has not served long enough at sea to be rated as an able seaman (q. v.). His pay is £1, 11s. per month on entering, and £1, 18s. 9d. a month on promotion to the first class.

**ORDINARY** (Lat. *ordinarius*) is the name commonly given to a person, who, in virtue of his office, and in his own consequent right, is competent to do certain acts or to decide certain causes. In this sense, there are many functionaries who may be called by the name ordinary. But the word in canon law, when used without other additions, is understood to mean the bishop, who is the ordinary of his own diocese, and is competent of himself to do every act necessary for its government, and for the ordering of the spiritual concerns of his flock. The jurisdiction of the ordinary is called by that name, in contradistinction to 'extra-ordinary jurisdiction,' which arises from some abnormal circumstances, and from 'delegated' jurisdiction, which is imparted by the ordinary to another person to be exercised vicariously.

In English Law, the ecclesiastical jurisdiction which was formerly vested in bishops and their officers relating to wills and marriages, was recently abolished, and transferred to a new judge, called the Judge Ordinary, who is entirely disconnected with the church. The bishops still retain their jurisdiction in matters of discipline as regards the clergy.—In Scotland, the Judge Ordinary generally

means the sheriff depute or substitute, who has ordinary jurisdiction in the county. Lord Ordinary is the name given to certain judges of the Outer House in the Court of Session.

**ORDINARY OF ARMS**, in Heraldry, an index or dictionary of armorial coats, arranged, not according to names, like an armory, but according to the leading charges in the respective shields, so as to enable any one conversant with heraldic language, on seeing a shield of arms, to tell to whom it belonged. A very imperfect ordinary for England is appended to Edmonson's *Heraldry*: a far more complete and elaborate work of the same kind, called Papworth's *Ordinary of British Armorial*, is now in course of publication.

**ORDINATION**, the rite or ceremony by which ministers of the Christian Church are dedicated to their sacred office. The use of a ceremonial for such purposes is traceable among the Jews (Exod. xxix. 24, Levit. xxi. 10, Num. iii. 3); and the New Testament contains frequent reference to the specific ceremonial of 'imposition of hands' (Acts vi. 1—7, xiii. 1—4, xiv. 23; 1 Tim. iv. 14, v. 22; 2 Tim. i. 6). In the Roman, the Greek, and the other Eastern Churches, this rite of ordination is held to be sacramental, and it is reserved, at least as regards the major orders (see **ORDERS, HOLY**), exclusively to bishops. In extraordinary cases, it was permitted to cardinals and to certain abbots to confer the minor orders. Considerable controversy exists among Catholic writers as to what are the essential portions (*Materia Sacramenti*) of the rite of ordination. Some place it in the 'imposition of hands,' some in the 'presentation of the instruments' symbolical of each order. The controversy derives some importance from the diversity which exists between the Greek and Roman ceremonial; but on this head Roman Catholics maintain that the essential rites are contained alike in both ceremonials. As regards the *validity* of the rite of ordination, the mere fact of its being conferred by a bishop suffices; but there is not any part of the Roman discipline which is more jealously guarded by laws than the administration of orders. The candidate can only be *lawfully* ordained by 'his own bishop' (*proprius episcopus*), or with the authority of his own bishop, which must be communicated to the ordaining bishop by what are called dimissorial letters. The candidate may be claimed by a bishop as by 'his own bishop' under any of four titles—of birth, of domicile, of benefice, or of connection by personal service; and if an ordination be attempted without some one of these titles, heavy ecclesiastical penalties are incurred as well by the ordainer as by the ordained. On the part of the candidate himself, certain qualifications are required; and certain disqualifications created or propounded by the canon law, called *irregularities*, are held to render an ordination in some cases invalid, and in all unlawful.

In the Church of England and other Reformed Episcopal churches, the rules of the ancient canon-law are retained, by which no one could be ordained without previous examination of his fitness, or who was disqualified by bodily infirmity, illegitimacy, immorality, or simony, or who was unprovided with a title (i. e., an appointment to serve in some church) which should provide him with a maintenance; or who, being a candidate for deacon's orders, was under 20, and for priest's, under 24 years of age; but the age for admission to deacon's orders is changed to 23. A college Fellowship is admitted as a title. (For the ceremony of Ordination see **ORDINAL**.) A person can only be ordained by the bishop in whose diocese he is to serve, except on *letters dimissory* from that bishop to another.

In other Reformed churches ordination is performed by the presbytery, or by one or more ordinary ministers. Some small Protestant denominations have no ceremony of ordination whatever.

**ORDNANCE** (*ordnance*, primarily, any disposition, arrangement, or equipment; and then applied incidentally to a particular part of the equipment or apparatus of war), a name applied to the guns and munitions of an army generally, and in particular to the great guns. Descriptions of the various sorts of ordnance will be found under **CANNON, FIREARMS, GUN, HOWITZER, MORTAR, RIFLED ORDNANCE**.

**ORDNANCE DEPARTMENT**, one of the oldest departments under the crown, was abolished by an Order in Council of the 25th May 1855, after an existence of at least 400 years. Its constitution, its important functions, and the causes which led to its dissolution, will be found under **BOARD OF ORDNANCE**. The early history of the department is lost in the middle ages; but it appears to have risen gradually under the Lancastrian kings, the first chiefs having been the commandants of the king's artillery. A Master of the Ordnance is mentioned in the time of Richard III.; but we read of John Louth being Clerk of the Ordnance as early as 1418. Henry VIII. constituted the Board, adding a Lieutenant, a Surveyor, and a Storekeeper, to whom a Clerk of the Cheque was subsequently joined. With the exception of the last, whose office was abolished in the beginning of the present century, this organisation was maintained until the abolition of the whole. In 1604, James I. dignified the Master and Lieutenant with the respective titles of Master-general and Lieutenant-general. The history of the Ordnance Office is of importance in British history, as in all wars it has been responsible not only for the management of the *matériel* of the armies, but also for the direction of the *personnel* of the artillery and engineers.

**ORDNANCE SELECT COMMITTEE** is a committee composed of scientific officers, and advises the Secretary of State for War on all inventions in war *matériel*. It has its offices at Woolwich, in the midst of the manufactories of the Royal Arsenal, and near the head-quarters of the royal artillery, by whom most of the designs have to be practically tested. The president of the committee is usually a general officer of artillery; and a captain in the royal navy serves as vice-president. The members comprise two artillery officers, one officer of engineers, and one of the line. The secretary and assistant-secretary are likewise artillerymen. With an establishment of clerks, printers, &c., the cost of the committee amounted for 1864 to £6607, exclusive of the larger sum involved for their expensive experiments.

**ORDNANCE SURVEY**. By this term is understood the various operations undertaken by the Ordnance department of the British government for preparing maps and plans of the whole kingdom and its parts. The idea of a general map of the country to be executed by the government was first proposed after the rebellion in 1745, when the want of any reliable map of the northern parts of Scotland was much felt by the officers in command of the royal troops. Its execution was intrusted to Lieutenant-general Watson, the deputy quarter-master of North Britain; but it was mostly carried out by Major-general Roy, an officer of engineers. The drawing, on a scale of one inch and three-fourths to the mile, was completed in 1755; but in consequence of the war which broke out in that year, was never published. In 1763 it was proposed to extend the

survey to the whole kingdom; but the first steps to effect this were taken only in 1784, when Major-general Roy commenced measuring a base-line on Hounslow Heath, near London. This principal triangulation was designed partly for astronomical purposes, and partly as a basis for a map on a small scale. The base-line was remeasured with great care in 1791; and detail plans were commenced by officers of the Royal Engineers, partly for practising them in military drawing, and partly for the purpose of forming plans of some portions of Kent for the use of the Ordnance. The principal object was, however, the instruction of a corps of military surveyors and draughtsmen, the plans themselves being regarded as of secondary importance. In 1794, the survey for the one-inch map was begun, and some sheets were published in 1796. As the series of principal triangles were extended westwards towards the Land's End, it was thought right to measure another base, for verification, on Salisbury Plain in 1794; and two other base-lines were subsequently measured—one in 1801 at Misterton Carr, and the other in 1806 on Ruddlan Marsh. Though first intended chiefly as a military map, the publication of the survey soon created a desire on the part of the public for better maps, and surveyors were then hired to hasten its progress. This, however, was very slow, the map being at one time entirely suspended during the war in the beginning of this century, and even the parts which were executed, having been done by contract, were found very inaccurate. In this condition the survey of England continued during the first quarter of the present century, sometimes delayed by the government from motives of economy, at other times urged on by the county gentlemen, who wished the map either as a hunting-map or for local improvements.

In Scotland, the principal triangulation was begun in 1809, but was discontinued in the following year, to enable the persons who had been employed there to carry forward the subordinate triangulation required for constructing the detail maps in England. In 1813 it was resumed, and continued steadily up to 1819; a new base-line having been measured on Belhelvie Links, near Aberdeen, in 1817, and the great sector used at various stations, both on the mainland and in the islands. In 1820 it was again suspended, was resumed in 1821 and 1822, and anew broken off in 1823, the large theodolite being wanted in order to proceed with the principal triangulation in South Britain. In 1824 the survey of Ireland was begun, and nothing more was done in Scotland till 1838, except that some detail surveying for a one-inch map was continued for a few years in the southern counties. The chief strength of the surveying corps was now transferred to Ireland. A map of that country was required for the purpose of making a valuation which should form the basis of certain fiscal arrangements and other improvements which the social evils and anomalies of Ireland urgently demanded. For this map a scale of six inches to the mile was adopted, as best suited for the purposes in view. On this scale the whole map was completed, and published in 1845, though the first portions were in an imperfect form, and needing revision, which is now going on.

In 1838 the triangulation of Scotland was resumed; and the survey of Ireland having been finished in 1840, surveys for a six-inch map were begun for the northern portions of England which had not been mapped on the one-inch scale. In connection with this map, the base-line on Salisbury Plain was remeasured with great accuracy in 1849, and its length found 36577·8581 feet. In 1941, a new

## ORDNANCE SURVEY.

secondary operations for a map of Scotland, also on a six-inch scale, were begun; but proceeded so slowly, that in 1850 only the map of Wigtownshire and some parts of Lewis were completed. Much dissatisfaction having been expressed in Scotland by the press and public bodies, as to the slow progress of the map and the six-inch scale on which only it was published, a committee of the House of Commons (Lord Elcho's) recommended the six-inch maps to be stopped, and the one-inch map completed as speedily as possible. This change produced much discussion as to the relative value of the one-inch and six-inch scales then in use, and the expediency of adopting a still larger scale as more valuable to the public. Circulars were issued, asking the opinion of various public bodies, and of scientific and practical men, as to the proper scale for a great national survey. The great preponderance of opinion was in favour of a scale of 1-2500 of nature, or nearly one inch to the acre. This scale was therefore ordered by a treasury minute of 18th May 1855 (Lord Palmerston's), and though subsequently stopped, in consequence of a motion by Sir Denham Norreys in the House of Commons in June 1857, was again recommended by a royal commission (December 1857), and ordered to be resumed by another treasury minute (11th September 1858). In 1861 a select committee was again appointed, and reported that it is desirable that the cadastral survey on the scales directed by the treasury minute of the 18th May 1855 be extended to those portions of the United Kingdom that have been surveyed on the scale of one-inch to the mile only. This recommendation has now been adopted by the government, and the survey is at present proceeding on the following scales: Towns having 4000 or more inhabitants are surveyed on a scale of 1-500 of the linear measurement, which is equivalent to 126.72 inches to a mile, or 41½ feet to an inch; Parishes (in cultivated districts) 1-2500 of the linear measurement, equal to 25.344 inches to a mile, or one square inch to an acre; Counties on a scale of six inches to a mile; Kingdom, a general map one inch to a mile.

The sheets of the one-inch map join together, so as to form a complete map of the whole kingdom. This is true also of the sheets of each county on the six-inch scale, and of each parish on the 1-2500 scale, but the sheets of different counties and parishes are not connected. The 1-2500 scale also applies only to cultivated, populous and mineral districts; the Highlands of Scotland, and other extensive moorland and uncultivated tracts, being only surveyed on the six-inch scale, and published on the one-inch scale.

The state of the survey, at the commencement of 1864, in the three kingdoms, was as follows (Reports 1862—1863):

In England—Durham, Westmoreland, Northumberland, and Cumberland had been surveyed on the 1-2500 scale, and maps on this and the six-inch scale were being published. The revision and publication of the map on the same scale had begun in the southern counties. Lancashire and Yorkshire were published on the six-inch scale only. The whole kingdom on the one-inch scale was published except eight sheets in the north.

In Scotland, the whole country south of Aberdeen, except Argyll on the west, has been surveyed and drawn on the 25 and 6 inch scales. On the six-inch scale, 7652 square miles (including the isle of Lewis) has been published, and about 3540 miles also on the 25-inch plans. Of the one-inch map, 5047 square miles, including Fife, the Lothians, Ayr, Wigtown, and parts of Dumfries, Roxburgh, and Berwick have been completed and published with hills.

In Ireland, as stated, the six-inch maps have been

long published, and are now in process of revision. A one-inch map of the whole in outline is also published, and 3557 square miles completed with hills. The engraving of hills in the remainder is also being proceeded with.

The sketch now given of the history of this great national undertaking will shew that it has been conducted at different times on different scales and plans, and that the system now pursued was only adopted after much discussion both in parliament and out of doors. In some respects it has been the mere result of accident, and much delay and great waste of public money has resulted from no fixed and well-matured plan having been adopted in the first instance, and pursued consistently to the end. The map was originally begun as a military map, and the scale of one inch to the mile chosen, without considering whether some other scale would not offer greater advantages. Many now think that a scale a little larger, and an aliquot part of nature, such as 1-50,000, or about 1¼ inch to the mile, would have been preferable for the small map; in which case a scale of 1-10,000 of nature, or about 6½ inches, might have been chosen for the intermediate, instead of the six-inch scale selected at first for mere local purposes in Ireland. Be this as it may, the arguments in favour of the one-inch map are, that it is the most convenient both as a general and travelling map. For general views of the structure of a country, the distribution and relations of its mountains, plains, valleys, and rivers, the one-inch is admitted to be superior to the six-inch, and thus better adapted in the first instance for laying out roads, railways, or other extensive public works, or for the publication of a general geological survey. Such a map, on the other hand, is on too small a scale to admit of correct measurements of small distances; it is in some respects a generalised picture, and not a correct plan. The six-inch maps were at first selected in Ireland as the smallest size on which correct measurements of distances and areas could be made. On them every house and field, and almost every tree or bush, might be laid down. Hence they are superior for working out details, as in minute surveys of railways or roads, or the complex geological structure of rich mineral districts. On such sheets, too, a proprietor or farmer may find every field laid down, and the relative heights indicated by contour lines, and may therefore use them for drainage and other improvements. It has also been proposed to use these six-inch maps as a record of sales or encumbrances of land, thus lessening the cost and simplifying the transfer of property. On the other hand, their size unfits them for most of the purposes for which the one-inch map is useful, and the contour lines give a far less vivid and correct impression of the physical features of a country than the hill sketching of the one-inch map. Most of the purposes of the six-inch plans are attained in a still more perfect manner from the 25-inch plans or cadastral survey. This last name is taken from the French *cadastre* (a register of lands), and is defined (in the *Recueil des Lois, &c.*) as a plan from which the area of land may be computed, and from which its revenue may be valued. The purposes to which these large plans may be applied are, as estate plans, for managing, draining, and otherwise improving land, for facilitating its transfer by registering sales or encumbrances; and as public maps, according to which local or general taxes may be raised, and roads, railways, canals, and other public works, laid out and executed.

Nearly all the states of Europe have produced trigonometrical surveys, many of them of great excellence as scientific works. All of these have

## ORDNANCE SURVEY—OREIDE.

been published, or are in course of publication, on convenient scales; generally smaller than one inch to a statute mile. The most important of these are:

- Austria and Northern Italy, scale  $\frac{1}{100,000}$  or  $\frac{1}{3}$ ths of an inch to a mile.
- Bavaria, Baden, Wurtemberg, and the Hessen territories  $\frac{1}{100,000}$  or  $\frac{1}{3}$ ths of an inch to a mile.
- Belgium,  $\frac{1}{100,000}$  or  $\frac{1}{3}$ ths of an inch to a mile
- Denmark, survey map in preparation.
- , Iceland, surveyed and published on different scales.
- France,  $\frac{1}{100,000}$  or  $\frac{1}{3}$ ths of an inch to a mile; and a reduction to  $\frac{1}{100,000}$  or 5 miles to an inch.
- Great Britain, 1 inch, 6 inches, and, in the lowland districts, 25 inches to a mile; and the coast survey, general charts,  $\frac{1}{2}$  miles to an inch; harbours and bays, from 2 inches to 12 inches to a mile.
- Hanover and East Prussia,  $\frac{1}{100,000}$  or  $\frac{1}{3}$ ths of an inch to a mile.
- Italy (see Sardinia, Tuscany, &c.), survey maps of Naples, Rome, &c., in progress.
- Greece (French survey)  $\frac{1}{100,000}$  or  $\frac{1}{3}$ ths of an inch to a mile.
- Netherlands,  $\frac{1}{100,000}$  or  $\frac{1}{3}$ ths of an inch to a mile.
- Prussia,  $\frac{1}{100,000}$  or  $\frac{1}{3}$ ths of an inch to a mile, and many smaller.
- Russia, survey map in progress.
- Sardinia,  $\frac{1}{100,000}$  or  $\frac{1}{3}$ th of an inch to a mile.
- Saxony,  $\frac{1}{100,000}$  or  $\frac{1}{3}$  inches to a mile.
- Switzerland,  $\frac{1}{100,000}$  or  $\frac{1}{3}$ ths of an inch to a mile.
- Spain and Portugal, surveys commenced.
- Sweden and Norway, surveys in progress.
- Tuscany  $\frac{1}{100,000}$  or about 3 miles to an inch.

The greatest extra European work of the kind is the *Trigonometrical Survey of India*, which has been conducted with great ability, and is now drawing to a close. The maps are published on a scale of  $\frac{1}{100,000}$  or  $\frac{1}{3}$ th of an inch to a mile, and it is expected that the whole will be completed in 1868 or 1870. In America, the coast Survey of the United States, a map of great accuracy and minute detail, has been going on for many years. The general charts are published on a scale of  $\frac{1}{100,000}$  or  $\frac{1}{3}$ ths of an inch to a mile; the harbours and ports  $\frac{1}{100,000}$  or  $\frac{1}{3}$ th of an inch to a mile. No systematic survey has yet been undertaken for the interior of the country.

No portion of South America has been trigonometrically surveyed, except the republics of Peru and Chili, which are in progress.

The Geological Survey, though under a different department of government (Science and Art), may be shortly noticed here. The English survey was begun in June 1835, by Sir Henry de la Beche, and the first Report on the Geology of Cornwall, Devon, and West Somerset was published in 1839. The Irish survey was begun in 1840, but was subsequently suspended till 1845. In 1854, the survey was extended to Scotland. The surveys are made on the six-inch maps in the parts of the country where these exist, but the results are published on the one-inch scale only, except some of the coal-fields, which are issued also on the six-inch scale. Besides the maps, sheets of sections, horizontal and vertical, with valuable memoirs, are also published. The geological survey of England began in the west, and now extends north to Lancashire, and east to the vicinity of London and Kent. The Irish survey commenced in the south, and is now published to beyond Dublin on the east coast, and the vicinity of Galway on the west. In Scotland, it has as yet been principally confined to the Lothians, Fife, and some portions of the neighbouring counties, of which several sheets are published.

**O'REGON**, one of the United States of America, in lat. 42°—46° N., long. 116° 40'—124° 25' W., bounded N. by Washington, from which it is chiefly separated by Columbia River; E. by Idaho, the Lewis or Snake River intervening; S. by Nevada and California; and W. by the Pacific Ocean; being 320 miles

from east to west, by 280 from north to south, with an area of 95,274 square miles. The principal rivers are the Columbia, and its branches—the Willamette, Fall River, Snake River, and the Owyhee. The Columbia is a large river, navigable 96 miles to the Cascade Mountains, through which it passes, but the entrance is difficult. The Willamette drains a large and fertile valley between the mountains and the ocean. The Cascade Mountains, which have extinct volcanic peaks of 4000 to 10,000 feet high, run north and south, dividing the state into two unequal regions. The western third of the state, bordering the Pacific, has a mild, equable, and moist climate, with valleys of great fertility, where pines grow from 250 to 300 feet high, and firs from 4 to 10 feet in diameter. The rainfall at Astoria, mouth of the Columbia River, is 86 inches. East of the mountains, the climate is dry and variable, and the soil less fertile. Gold and silver are found in the Cascade Mountains, with copper, platinum, iridium, and osmium. Coal has been discovered on Coose Bay. The chief agricultural productions are wheat, oats, potatoes, and apples. The great forests abound with the grisly and black bear, panther, wild-cat, elk, deer, antelope; among the birds are the California vulture, golden eagle, American swan, Canadian goose, &c.; while the rivers swarm with salmon. There were, in 1860, 19 organised counties. Most of the settlements are on the Columbia River and in the Willamette Valley. The chief towns are—Salem, the capital, on the Willamette River, pop. 1500; Portland, 2700; and Oregon City, about 2000. Within the state are about 10,000 Indians and 2000 Chinese. Two colleges have been founded, 7 academies, and 300 common schools, 2 daily and 12 weekly papers, and numerous churches. O. was the name formerly given to the whole territory west of the Rocky Mountains, claimed by the United States, as far north as lat. 54° 40' N. This claim was resisted by the British government, which asserted a right to the entire territory, and in 1818 a treaty was made, and renewed in 1827, giving joint occupation, which was terminated in 1846 by notice from the United States government, and the question seemed likely to involve the two countries in war, when a compromise was offered by Lord Aberdeen, on the part of the British government, and accepted by that of the United States, by which the boundary was settled on the 49th parallel. The northern portion is now Washington, and the eastern, Idaho Territory. The coast was discovered, and Columbia River entered in 1792 by Captain Gray, of Boston. It was explored in 1804 and 1805 by Captains Lewis and Clarke, U.S. army. In 1811, John Jacob Astor founded Astoria as a trading-dépôt of the American Fur Company, but sold out afterwards to the North-west Fur Company. In 1845, the gift of 320 acres of land to each married couple of settlers caused a large emigration. The territorial government was organised in 1848, and in 1859 it was admitted as a state. Pop. in 1860, 52,464.

**OREIDE**, a new alloy lately introduced by the French as a substitute for ormolu, which it excels in its gold-like character. There are two formulas for composing it. In the first the ingredients are: copper, 100.0; tin, 17.0; magnesia, 6.0; sal ammoniac, 3.6; quicklime, 1.80; argols, or unrefined tartar, 9.0. In the second, zinc is substituted for the tin. The latter does not possess the same brilliancy as the former. The metals are first melted, and the other ingredients, after being thoroughly incorporated together by powdering and mixing, are slowly added, and the whole is kept in a state of fusion for about an hour, and the scum removed from time to time.

OREL, a government in the south-west of Central Russia, bounded on the W. by Little Russia and the government of Smolensk. Area, 17,395 square miles; pop. 1,547,975. The surface is flat, with rising grounds in the vicinity of the towns of Kromy and Malo-Archangelsk, from which the Oka and Sosna respectively take their rise. The government is drained by the Desna on the west, an affluent of the Dnieper; the Oka on the north, an affluent of the Volga; and the Sosna on the east, an affluent of the Don. The soil is fertile, and the climate mild. The western part of the government abounds in woods. In the district of Briansk, in the north-west, there are a number of iron mines. Agriculture and the cultivation and preparation of hemp are the chief employments of the people. Corn is very extensively grown, and great quantities are sent to St Petersburg, Riga, and the Black Sea ports for export. The principal article of export is wheat, in grain and in flour. Sail-cloth, rope and hemp-yarn manufactures are carried on; glass and iron works are numerous. The hemp of O. is reckoned the best in Russia; and the oil obtained from hemp-seed, and used in Russia as an article of food, is extracted at 2000 mills. The rearing of cattle and horses is much attended to; almost all the considerable landowners keep studs.

OREL, a thriving town of Great Russia, capital of the government of the same name, stands on the Oka, at its confluence with the Orlik, 226 miles south-south-west of Moscow, and 678 miles south-south-east of St Petersburg. It was founded in 1566, as a stronghold in defence of what was then the Russian frontier, against the inroads of the Tartar tribes of the Crimea. Its importance as a fortress ceased after the annexation of Little Russia, and it then became a commercial town. The town owes much to its advantageous position on a navigable river in the midst of the most fertile provinces of Russia. The projected railway from Moscow to Sebastopol will pass through O., and the Witebsk line will afford it direct railway communication with the port of Riga, and thus greatly facilitate its export trade. It is the seat of a bishop, and contains numerous churches; its houses are for the most part constructed of wood. There is an important ferry here over the Oka. The chief manufacturing establishments in the town are yarn and rope factories. The principal articles of export are cereals and hemp. On the 7th June 1848, O. suffered severely from a great fire, which destroyed 1237 houses, four bridges, and a number of granaries. Pop. 35,856.

ORELLI, JOHANN KASPAR, an eminent philologist and critic, was born at Zürich, 13th February 1787. His father was long the *Landvogt* of Wädenschweil. He studied in the *Carolinum* at Zürich, and betook himself enthusiastically to the study both of the ancient and of modern languages and literature. In 1806, he was ordained as a clergyman. He spent some years as a tutor at Bergamo; and while there, published, in 1810, two parts of a work entitled *Beiträge zur Geschichte der Ital. Poesie*. In 1813, he became a teacher in the cantonal school at Chur; in 1819, Professor of Eloquence and Hermeneutics in Zürich; and after the foundation of the Zürich High School, in which he took an active part, he was one of its chief ornaments. There never was a man more zealous in the cause of education. It was during this latter and most distinguished period of his career that he produced most of his learned works, and trained to a correct knowledge of antiquity a numerous band of scholars. His political sympathies and opinions were not,

however, confined to the ancient world; he took the liveliest interest in the struggles of Greece for freedom, and in the political reformation of his native country. He died 6th January 1849. O. edited many classical authors with great learning, taste, and acute discrimination; in particular, his editions of Horace (2 vols. Zür. 1837—1838), Tacitus (2 vols. Zür. 1846—1847), and Cicero (4 vols. Zür. 1826—1831) deserve mention; also an *Onomasticon Tullianianum* (3 vols. Zür. 1836—1838), executed in association with Baiter, and an *Inscriptionum Latinarum Selectarum Collectio* (2 vols. Zür. 1828).

O'ORENBURG, one of the eastern frontier governments of European Russia, is bounded on the S.E. by the river Ural, and extends between the governments of Tobolsk on the N.E. and Samara on the S.W. Area, of the government proper, 153,928 square miles; pop. 1,810,275; but the so-called Orenburg Country, including the recently-organised government of Samara (q. v.), the lands of the Orenburg and Ural Cossacks, and of Khirghiz tribes, under different names, extends over an area of 539,830 square miles, from the Volga to the Sir-Daria and the Amu-Daria, and has 2,370,275 inhabitants. The populations, the surface, soils, flora, and fauna of this extensive country are of the most various kinds. The government is one of the most elevated in the empire; but it also contains extensive low-lying tracts and steppes. It is traversed by numerous navigable rivers, by means of which and by canals it is in communication with the Caspian and Baltic Seas, and with the Arctic Ocean. The main streams are the Kama, a branch of the Volga, with its affluents the Bielaia and Tchussovaia; the Tobol, a branch of the Obi and the Ural. Forests abound, except in the south; the soil is fertile, but is not yet much cultivated; and other natural resources are rich, but in great part undeveloped. The climate is in general healthy. The government is divided into nine districts; the centre of the governor-generalship is at Orenburg (q. v.), though the chief town is Ufa. The inhabitants are made up of Russians, Bashkir, Tartar and Khirghiz tribes, Kalmucks and certain Finnish tribes. The trade is chiefly with Bokhara, Khiva, Tashkent, and the Khirghiz; the exports are gold, silver, and other metals, corn, skins, and manufactured goods; the imports, cattle, cotton—the demand for and supply of which have greatly increased since the commencement of the American war—and the other articles of Asiatic trade. The imports are either disposed of to Russian merchants in the custom-house on the frontier, or are carried by Asiatic traders into Russia, and sold at the great national market of Nijni-Novgorod. In 1862, the value of the imports, as checked by custom-house inspection, was £900,000, and the value of the exports £485,000. The actual amount, however, of the exports and imports of this government is much greater than that represented by the figures given, as, owing to the border-line being so extensive and sparsely peopled, smuggling is largely carried on. There are in the province numerous iron and copper works, as well as valuable gold diggings, both belonging to the crown and to private individuals. In 1861, the crown gold-mines yielded 33 puds (a pud = 36 lbs. Avor., nearly) of gold, and the private gold-mines 64½ puds. There are also many small arms and other factories, and valuable salt-mines. The Bashkir tribes are the chief traders; cattle-breeding and fishing are carried on by the Ural Kossacks. The principal fair in the government is that of the district town of Menselinsk, where about £170,000 worth of goods is sold annually.

**ORENBURG**, a town on the eastern frontier of European Russia, in the government of the same name, on the river Ural, 1393 miles south-east of St Petersburg, lat. 51° 45' N., long. 88° 6' E. The foundation of the fortress and town were laid here in 1742. Pop. 24,078. It is the centre of the governor-generalship of the government of the same name, has an excellent custom-house, and carries on an extensive trade with Khirghiz and other Asiatic tribes. It imports cotton, silk-stuffs, and shawls from Bokhara, Khiva, and Tashkent; tea (brought mostly on camels) from China; and sheep and cattle from the Kossacks and Khirghiz. The sheep are killed in autumn for the fat and skins, which are purchased by Russian merchants. Corn, skins, and metals are the principal exports. The imports amounted, in 1862, to £463,000, and the exports to £256,000.

**OREODA'PHNE**, a genus of trees of the natural order *Lauraceae*, sometimes called **MOUNTAIN LAUREL**. The fruit is succulent, partly immersed in a deep thick cup formed of the tube of the calyx. *O. opifera* is a native of the countries on the lower part of the Amazon. A volatile oil obtained from the bark is used as a liniment, and when kept for a short time deposits a great quantity of camphor.—*O. cupularis* is a very large tree with strong-scented wood, the bark of which yields the cinnamon of Mauritius. It grows also in Bourbon and Madagascar.—*O. fetens*, a native of the Canaries, has wood (*Til-wood*) of a most disagreeable odour. *O. bullata*, found at the Cape of Good Hope, is also remarkable for the disagreeable odour of its wood, the *Stink-wood* of the colonists; but it is hard, durable, beautiful, takes an excellent polish, and is used in ship-building.

**ORES**. Any mineral or combination of minerals containing as much metal as to be profitably extracted, is reckoned by miners an ore. The proportion necessary for this purpose is, of course, very various, according to the value of the particular metal and the facility or difficulty of *reducing* the ore. A rock containing only 1 per cent. of iron is never called an ore; one containing the same proportion of gold is a very rich ore. Metals rarely exist in ores in a pure or native state; they are almost always chemically combined with oxygen, sulphur, or other elements.

Ores present themselves in a multiplicity of forms and positions in the solid crust of the earth. Sometimes they are sprinkled through the whole mass of the rocks in which they occur, as is often the case with gold, tin ore, and magnetic iron ore. Sometimes they are deposited in regular parallel beds between the strata of other rocks, as in the case of many iron-stones and of cupreous schist. At other times, they occur in irregular lumps or concretions; or they fill up the fissures of other rocks, forming veins, particularly silver, copper, and lead ores; or lastly, they are found in detritus, gravel, sand, and other alluvial deposits. This last form is evidently the result of disturbance and transport from some of the other positions above specified. And as the metallic parts of the mineral masses or rocks so disturbed and transported are the heaviest, and are insoluble in water, they are more concentrated in these deposits than in their original position, and can therefore be extracted with greater advantage. Such deposits are called *washings*, from the metal being separated from the other debris by the process of washing. Gold and platinum are mostly got in this way in the Ural and Altai Mountains, and gold in Guiana, California, and Australia. Tin ore is also found in alluvial deposits in Cornwall and India. The

reduction of ores is treated of under **METALLURGY** and the names of the several metals.

**ORFILA**, **MATEO JOSÉ BONAVENTURA**, a celebrated physician and chemist, and the recognised founder of the science of toxicology, was born at Mahon in Minorca, 24th April 1787. His father, who was a merchant, intended that his son should follow the same pursuit; but young O. shewed so strong a predilection for the study of medicine, that all thoughts of a mercantile career for him were dismissed, and he was sent to the medical schools of Valencia and Barcelona. In the latter of these seminaries, he so distinguished himself, that the junta of the province resolved to defray the expense of his further education in Paris, on condition of his returning to Barcelona to fill one of the chairs in their medical school; and accordingly O. departed for Paris in 1807. The junta were prevented from fulfilling the agreement by the outbreak of war with France; but O., who had now made many friends in Paris, was enabled to continue his studies. In October 1811, he received the degree of Doctor of Medicine, and immediately commenced a private course of lectures on chemistry, botany, and anatomy, which was largely attended, and, along with his successful practice, soon rendered him famous. In 1813 appeared the first edition of his celebrated work on poisons, entitled *Traité des Poisons tirés des Règnes Minéral, Végétal, et Animal*, or *Toxicologie Générale* (Paris). The work was commended by the Institute, and rapidly passed through a number of editions. In 1816, on the occasion of a short visit to Minorca, he met with an enthusiastic reception; and on his return to Paris, became court physician. In 1819, he was created a citizen of France, and became professor of jurisprudence; and in 1823, was transferred to the chair of chemistry, to which, in 1831, was added the deanship of the faculty. His prosperity was now at the full; his lectures were more popular than ever; his works were reckoned as master-pieces; and he himself, by the geniality of his disposition and his many accomplishments, was a universal favourite in society. In all cases of suspected poisoning, he was a most important witness. From 1834, he was a member of the council of public instruction, and procured the passing of many useful measures, such as the creation of secondary medical schools, and the multiplication of means of instruction and observation. He also organised the clinical hospital, founded a new botanic garden, and a museum of comparative anatomy which is now known by his name. On the outbreak of the revolution of 1848, he was deprived of his place in the medical faculty on account of his conservative opinions, but retained his professorship. He died at Paris, March 12, 1853. His great work on toxicology has gained for him undying fame; it is a vast mine of information, the result of the author's solitary indefatigable researches; and includes symptoms of poisoning of all kinds, the appearances in the body to which poisons give rise, their action, and the means for their detection. It is well written, and exhibits the accuracy of language equally with the sound judgment of its author. His other works are not nearly so famous, partaking more of the character of compilations; the chief of them are—*Elémens de Chimie appliqués à la Médecine* (Paris, 1817; 8th edition, 1851); *Traité de Médecine Légale* (1823—1825; 4th edition, 1847); *Mémoires sur Plusieurs Questions Médico-légales* (Paris, 1839); and *Recherches sur l'empoisonnement par l'Acide Arsenieux*, &c. (Paris, 1841). He also contributed largely to various journals, dictionaries, encyclopedias, and other periodicals. He has left a number of Memoirs, which have not yet been published.

## ORGAN.

**ORGAN** (Gr. *organon*, a contrivance requiring skill on the part of the user of it), a musical instrument played by finger-keys, and in general partly also by foot-keys, and consisting of a large number of pipes of metal and wood made to sound by a magazine of wind accumulated by bellows, and admitted at will by the player. The following description is necessarily restricted to the most fundamental arrangements of this very complicated instrument. As met with in cathedrals and large churches, the organ comprises four departments, each in most respects a separate instrument with its own mechanism, called respectively the *great-organ*, the *choir-organ*, the *swell-organ*, and the *pedal-organ*. Each has its own clavier or keyboard, but the different claviers are brought into juxtaposition, so as to be under the control of one performer. Claviers played by the hands are called *manuals*; by the feet, *pedals*. Three manuals, belonging to the choir, great, and swell organs respectively, rise above each other like steps, in front of where the performer sits; while the pedal-board by which the pedal-organ is played is placed on a level with his feet. The condensed air supplied by the *bellows* is conveyed through wooden tubes or trunks to boxes, called *wind-chests*, one of which belongs to each department of the organ. Attached to the upper part of each wind-chest is a *sound-board*, an ingenious contrivance for conveying the wind at pleasure to any individual pipe, or pipes, exclusively of the rest. It consists of two parts, an *upper board* and an *under board*. On the upper board rest the *pipes*, of which a number of different quality, ranged behind each other, belong to each note. In the under board is a row of parallel *grooves*, running horizontally backwards, corresponding each to one of the keys of the clavier. On any of the keys being pressed down, a valve is opened which supplies wind to the groove belonging to it. The various pipes of each key stand in a line directly above its groove, and the upper surface of the groove is perforated with holes bored upwards to them. Were this the whole mechanism of the sound-board, the wind, on entering any groove, would permeate all the pipes of that groove; there is, however, in the upper board, another series of horizontal grooves at right angles to those of the lower board, supplied with *sliders*, which can, to a small extent, be drawn out or pushed in at pleasure by a mechanism worked by the *draw-stops* placed within the player's reach. Each slider is perforated with holes, which, when it is drawn out, complete the communication between the wind-chest and the pipes: the communication with the pipes immediately above any slider being, on the other hand, closed up when the slider is pushed in. The pipes above each slider form a continuous set of one particular quality, and each set of pipes is called a *stop*. Each department of the organ is supplied with a number of stops, producing sounds of different quality. The *great-organ*, some of whose pipes appear as show-pipes in front of the instrument, contains the main body and force of the organ. Behind it stands the *choir-organ*, whose tones are less powerful, and more fitted to accompany the voice. Above the choir-organ is the *swell-organ*, whose pipes are enclosed in a wooden box with a front of *louvre-boards* like Venetian blinds, which may be made to open and shut by a pedal, with a view of producing *crescendo* and *diminuendo* effects. The *pedal-organ* is sometimes placed in an entire state behind the choir-organ, and sometimes divided, and a part arranged on each side. The most usual compass of the manuals is from C on the second line below the bass staff, to D on the third space above the treble staff; and the compass of the

pedals is from the same C to the D between the bass and treble staves. The real compass of notes is, as will be seen, much greater.

*Organ-pipes* vary much in form and material, but belong to two great classes, known as *mouth-pipes* (or *flute-pipes*) and *reed-pipes*. A section of one of the former is represented in the figure. Its essential parts are the *foot* *a*, the *body* *b*, and a flat plate *c*, called the *language*, extending nearly across the pipe at the point of junction of foot and body. There is an opening, *de*, in the pipe, at the spot where the language is discontinuous. The wind admitted into the foot rushes through the narrow slit at *d*, and, in impinging against *e*, imparts a vibratory motion to the column of air in the pipe, the result of which is a musical note, dependent for its pitch on the length of that column of air, and consequently on the length of the body of the pipe: by doubling the length of the pipe, we obtain a note of half the pitch, or lower by an octave. Such is the general principle of all mouth-pipes, whether of wood or of metal, subject to considerable diversities of detail. Metal pipes have generally a cylindrical section; wooden pipes, a square or oblong section. A mouth-pipe may be stopped at the upper end by a plug called a *lompion*, the effect of which is to lower the pitch an octave, the vibrating column of air being doubled in length, as it has to traverse the pipe twice before making its exit. Pipes are sometimes half-stopped, having a kind of chimney at the top. The *reed-pipe* consists of a reed placed inside a metallic, or occasionally a wooden pipe. This *reed* is a tube of metal, with the front part cut away, and a tongue or spring put in its place. The lower end of the spring is free, the upper end attached to the top of the reed; by the admission of air into the pipe, the spring is made to vibrate, and in striking either the edge of the reed or the air, produces a musical note, dependent for its pitch on the length of the spring, its quality being determined to a great extent by the length and form of the pipe or bell within which the reed is placed. When the vibrating spring does not strike the edge of the reed, but the air, we have what is called the *free reed*, similar to what is in use in the Harmonium (q. v.). To describe the pitch of an organ-pipe, terms are used derived from the standard length of an open mouth-pipe of that pitch. The largest pipe in use is the 32-foot C, which is an octave below the lowest C of the modern pianoforte, or two octaves below the lowest C on the manuals and pedal of the organ: any pipe producing this note is called a 32-foot C pipe, whatever its actual length may be. By a 32-foot or 16-foot stop, we mean that the pipe which speaks on the lowest C on which that stop appears, has a 32-foot or a 16-foot tone.

The *stops* of an organ do not always produce the note properly belonging to the key struck; sometimes they give a note an octave, or, in the pedal-organ, even two octaves lower, and sometimes one of the harmonics higher in pitch. *Compound* or *mixture stops*, have several pipes to each key, corresponding to the different harmonics of the ground-tone. There is an endless variety in the number and kinds of stops in different organs; some are, and some are not continued through the whole range of manual or pedal. Some of the more important stops get the name of *open* or *stopped diapason* (a term which implies that they extend throughout the whole compass of the clavier); they are for the most part 16-feet, sometimes 32-feet stops; the *open diapason* chiefly of metal, the *close* chiefly of wood. The *dulciana* is an 8-foot manual

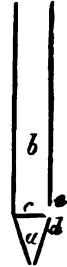



stop, of small diameter, so called from the sweetness of its tone. Among the reed-stops are the *clarion*, *oboe*, *bassoon*, and *vox humana*, deriving their names from real or fancied resemblances to these instruments and to the human voice. Of the compound-stops, the most prevalent in Britain is the *sesquialtera*, consisting of four or five ranks of open metal pipes, often a 17th, 19th, 22d, 26th, and 29th from the ground-tone. The resources of the organ are further increased by appliances called *couplers*, by which a second clavier and its stops can be brought into play, or the same clavier can be united to itself in the octave below or above.

Organs are now generally tuned on the equal temperament. See TEMPERAMENT. The notation for the organ is the same as for the pianoforte, in two staves in the treble and bass clefs; but in old compositions, the soprano, tenor, and alto clefs are used.

Instruments of a rude description, comprising more or less of the principle of the organ, seem to have existed early. Vitruvius makes mention of a hydraulic organ, but his description is not very intelligible. The organ is said to have been first introduced into church music by Pope Vitalian I. in 666. In 757, a great organ was sent as a present to Pepin by the Byzantine emperor, Constantine Copronymus, and placed in the church of St Cornelle at Compiègne. Soon after Charlemagne's time, organs became common. In the 11th c., a monk named Theophilus wrote a curious treatise on organ-building. But it was not till the 15th c. that the organ began to be anything like the noble instrument which it now is. The family of the Antignati, in Brescia, had a great name as organ-builders in the 15th and 16th centuries. The organs of England were also in high repute, but the puritanism of the civil war doomed most of them to destruction; and when they had to be replaced after the Restoration, it was found that there was no longer a sufficiency of builders in the country. Foreign organ-builders were therefore invited to settle in England, the most remarkable of whom were Bernhard Schmidt (generally called Father Smith) and his nephews, and Renatus Harris. Christopher Schreider, Snetzler, and Byfield succeeded them; and at a later period, Green and Avery, some of whose organs have never been surpassed in tone, though in mechanism those of modern builders are an immense advance on them. The largest English organs are those of York Cathedral, Birmingham Town Hall, and Christ Church, London. The two largest organs in the world are at Haarlem and Rotterdam; the former, 103 feet high and 50 broad, was built in 1738 by Christian Müller. The German organs are remarkable for preserving the balance of power well among the various masses, but in mechanical contrivances they are surpassed by those of England.

For a full account of the structure of the organ, see Hopkins and Rimbault, *The Organ, its History and Construction* (Lond. 1855). Rink's *Praktische Orgelschule*, Leipzig, v. y., is the best work on organ playing.

**ORGAN, ORGANIC, ORGANISM.** The word *organ* is derived from the Greek *organon*, an instrument, and is sometimes employed almost in its original sense. But it has received a signification more peculiarly its own, and with which alone the word *organism* is connected, as the designation of any of the parts or members of a living body, the *organism* being the living whole, animal or vegetable, which these organs compose. The idea of an organism or of organisation is almost as much involved in obscurity and difficulty as that of *life*, with which it is so closely connected. But it is observable that a living body is entirely composed

of organs, and these themselves of other organs, until we come to elementary cells; and also, that all the parts are mutually dependent on each other; and therefore an organism has been defined as a natural whole, in which all the parts are mutually to each other means and end. The juice which nourishes a plant is elaborated by the plant itself, although the supplies are drawn from without. The leaves of a plant are produced by the stem, but re-act upon the stem in promoting its growth. This mutual dependence of parts strongly distinguishes an organism from a *machine*, in which the parts concur for a common end, to which each contributes in its own way, but in which each does not contribute to the support of all or any of the rest. In organisms, moreover, besides this support and maintenance of the different parts or organs, there is a provision for the production of new organisms of the same kind, the reproduction or propagation of the species, to which there is nothing analogous beyond the sphere of organic life. Amongst organic beings, as we ascend in the scale from the lowest kinds of plants and animals to the highest, we observe an increasing number of organs and of functions of organs. In the animal kingdom, organic life appears as possessed of sensation and spontaneous motion; whilst plants are limited to growth, assimilation, and propagation. The question as to the nature of organic processes connects itself with a most difficult question as to the relation of chemical processes with psychical functions, chemical processes being certainly carried on, but singularly modified or directed by the living powers of the organic being.—The term *organio* is frequently applied to those things in which an analogy is traced to living creatures, in the mutual dependence of parts. Such an analogy may be traced in social life and in political life; and the more perfectly this relation of mutual dependence or mutual usefulness is established, the better is the state of things, social or political. It is also the highest praise of a work of art, that it suggests this idea of an organic relation of its parts to each other, and to the whole.—*Organic Laws* are those which are fundamental or most essential to the system to which they belong.

**ORGANIC ANALYSIS.** When a complex organic substance is submitted to chemical examination, the first point is to determine its *proximate* constituents, or, in other words, the several definite compounds of which it is made up. Opium, for example, is thus found to have as its proximate constituents meconic acid, morphia, codeia, and some ten or twelve other substances. The modes by which these proximate constituents are separated are various; the chief being the action of certain solvents, such as ether, alcohol, and water, which extract some of the materials and leave others undissolved. Thus ether is the special solvent of fatty and waxy matters, resins, and camphors; alcohol dissolves the same substances with less facility, but on the other hand takes up many substances which are insoluble in ether; while water, which scarcely acts upon the above-named matters, dissolves saccharine, gummy, and starchy matters, and salts of organic acids. The proximate constituents being thus determined, the next point is to determine their qualitative and quantitative (or ultimate) composition; and it is to these processes—especially the last—that the term *organic analysis* is for the most part restricted.

*Qualitative Analysis.*—It is shewn in the article ORGANIC COMPOUNDS, that the ordinary ingredients for which we must seek are carbon, hydrogen, oxygen, nitrogen, and sulphur. Carbon and hydrogen may be simultaneously detected by burning the compound (which must be previously well dried) in

## ORGANIC ANALYSIS—ORGANIC BASES.

a glass-tube in contact with oxide of copper, which readily yields up its oxygen. The carbon is thus converted into carbonic acid, which if passed into baryta water forms a white precipitate of carbonate of baryta, and the hydrogen into water, which collects in drops in a small cooled receiver attached to the tube. Carbon may also be usually recognised by the black residue which almost always remains on burning an organic matter, especially in a narrow test-tube in which there is little air. The presence of nitrogen may in most cases be readily ascertained by heating a portion of the substance in a test-tube with an excess of hydrate of potash, when a distinct odour of ammonia is perceived. Sulphur is detected by igniting the compound with hydrate of potash and nitre, whereby sulphuric acid is formed; and phosphorus and arsenic may be detected by the same means. The presence of oxygen cannot, as a general rule, be directly determined.

**Quantitative Analysis.**—The first attempts to determine the quantitative composition of organic bodies were made, scarcely half a century ago, by Gay Lussac and Thenard. The process originally proposed by them has been modified and improved by various chemists, especially by Berzelius, Prout, and Liebig, and it is mainly owing to the great simplifications introduced by the last-named chemist, and to the consequently increased facility of conducting an ultimate analysis, that our knowledge of the composition of organic bodies has so vastly enlarged during the last twenty years.

The operation is always effected by causing complete combustion of a known weight of the body to be analysed, in such a manner that the carbonic acid and water which are formed in the process shall be collected, and their quantities determined, from which, of course, the carbon and hydrogen they respectively contain may be readily calculated. The apparatus required for the analysis of a compound containing carbon, hydrogen, and oxygen

the oxide, while the tube is lastly filled to within an inch of its open mouth with the oxide alone. The tube is then placed in the furnace, which may be heated with charcoal or gas. (Hofmann's gas furnace, in which is a peculiar form of burner called the *atmopyre*, is the best. It is described in vol. xi. of *The Journal of the Chemical Society*.) Red-hot charcoal is now placed round the anterior part of the tube, containing the pure oxide of copper; and when this is red-hot, the fire is slowly extended towards the further extremity by shifting the movable screen shewn in the figure. When the tube has been completely heated from end to end, and no more gas is disengaged, the charcoal is gradually removed from the further extremity of the tube, and the point of the latter broken off; after which a little air is drawn through the whole apparatus, so as to secure any remaining carbonic acid and watery vapour. The parts are then detached, and the increase of weight of the chloride-of-calcium tube and potash apparatus is determined by an accurate balance. The following account of an actual analysis of crystallised cane-sugar (borrowed from Fownes's *Chemistry*) will serve to illustrate the preceding remarks:

	Grains.
Quantity of sugar employed, . . . . .	4.780
Potash apparatus, after experiment, . . . . .	781.18
" " before experiment, . . . . .	773.82
Carbonic acid, . . . . .	7.31
Chloride-of-calcium tube, after experiment, . . . . .	226.05
" " before experiment, . . . . .	223.30
Water, . . . . .	2.75

7.31 grains carbonic acid = 1.994 grains carbon; and 2.75 grains water = 0.3056 grains hydrogen; or in 100 parts of sugar, carbon, 41.98; hydrogen, 6.43; oxygen by difference, 51.59.

For the methods of determining other elements quantitatively, such as nitrogen, chlorine, sulphur, phosphorus, &c., we must refer to the various works that have been published on organic analysis, amongst which those of Liebig, Fresenius, and Rose deserve special mention.

**ORGANIC BASES.** The present remarks must be regarded as supplementary to the article ALKALOIDS. They refer (1) to the classification of organic bases and (2) to their formation.

(1) From the fact that nearly all artificial organic bases are (as will be afterwards shewn) actually constructed from ammonia, and that, whether artificially or naturally formed, they exhibit the property of basicity, which is the leading characteristic of ammonia, chemists have been led to refer organic bases generally to the typical body ammonia, and have succeeded in demonstrating that they are constructed upon or derived from the simple type  $\text{NH}_3$ . Berzelius believed that all the alkaloids actually contained ammonia as an ingredient of their composition, a view which is now untenable; and it is to Liebig that we are indebted for the idea that they are derivatives of ammonia, or, in other words, amidogen bases or ammonia in which an equivalent of hydrogen is replaced by an organic radical. The subject has been thoroughly worked out by Dr Hofmann, who originally proposed to classify these bodies under the heads of *amidogen*, *imidogen*, *nitrile*, and *ammonium* bases; but has since adopted the terms *primary amines*, *secondary amines*, and *tertiary amines*, in preference to *amidogen*, *imidogen*, and *nitrile* bases—the word *amines* being applied to all organic bases that are derived from ammonia ( $\text{NH}_3$ ). The amines may be (1) *monamines*, (2) *diamines*, (3) *triamines*, (4) *tetramines*, or (5) *pentamines*, according as they be constructed upon a single, double, treble, quadruple, or quintuple atom of  $\text{NH}_3$ . We shall confine our

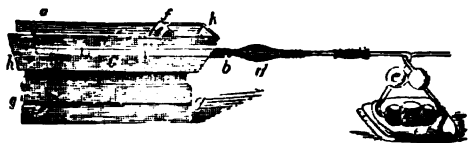

a, b, the combustion tube; c, the central portion, in which the mixture to be analysed is placed; d, the bulb-tube, containing chloride of calcium; ee, Liebig's potash apparatus; f, a movable iron screen; gg, bricks supporting AA, the furnace.

only, consists of (1) a *combustion tube*, composed of hard white Bohemian glass, having a diameter of half an inch or less, and a length of from 14 to 18 inches. One end is drawn out in a point and closed, while the edges of the other (or open) end are made smooth by fusion in the blow-pipe flame. (2) A thin sheet-iron furnace, in which the tube is placed and supported during combustion. (3) A small light tube (which may be either a bulb-tube, as in the figure, or a U-tube), which is filled with fragments of spongy chloride of calcium to absorb the watery vapour that is driven through it; and (4) Liebig's bulb-apparatus, containing a solution of potash of specific gravity 1.27, for the purpose of absorbing the carbonic acid. The chloride-of-calcium tube is connected by a well-dried perforated cork to the open extremity of the combustion tube, and by a little tube of flexible caoutchouc, secured by silk cord, to the potash apparatus.

In performing an analysis a little freshly prepared oxide of copper is first introduced into the combustion tube, then a mixture of about 5 grains of the substance to be analysed, with an excess of

illustrations of the meaning of these terms to the monamines, both because they form the most important group and because they are much more readily elucidated than the other groups, which are extremely complicated in their composition. *Monamines* are constructed upon the single atom of ammonia,  $H_3N$ . In *primary monamines* one of the atoms of hydrogen is replaced by an organic radical, R; and hence their general formula is  $RH_2N$ . Ethyl-amine or ethylia ( $C_2H_5H_2N$ , or  $C_2H_7N$ , is an example. In *secondary monamines* two of the atoms of hydrogen are replaced by two atoms of either the same or of different radicals. Hence their general formula is  $RR'HN$ , where R and R' may be the same or different radicals. Diethylia ( $C_2H_5)_2HN$ , or  $C_6H_{11}N$ , and methyl-ethyl-amine, or methyl-ethylia ( $C_2H_5$ )( $C_2H_5$ )HN, or  $C_4H_9N$ , are examples. In *tertiary monamines* the three atoms of hydrogen are replaced by three atoms of the same or different radicals; their formula therefore is  $RR'R''N$ , when R, R', R'' may or may not differ from one another. Trimethylamine or trimethylia ( $C_2H_5$ ) $_3N$ , or  $C_6H_{15}N$ , and methyl-ethyl-phenyl-amine or methyl-ethyl-phenylia ( $C_2H_5$ )( $C_2H_5$ )( $C_6H_5$ )N, or  $C_9H_{13}N$ , afford examples of the radicals being all the same and of their being all different. This last example affords a good illustration of the fact, that although the modern nomenclature of organic chemistry includes long and apparently complex words, these words to a great degree represent the composition of the substance they are used to indicate; methyl ( $C_2H_5$ ), ethyl ( $C_2H_5$ ), and phenyl ( $C_6H_5$ ), mainly contributing to form methyl-ethyl-phenylia.

(2) Although all attempts at forming in the laboratory those alkaloids that naturally exist in plants, such as morphia, quinia, and strychnia, have hitherto failed, a large number of organic bases have been prepared by artificial means, such as: a. By the destructive distillation of organic bodies containing nitrogen. Thus, in the preparation of coal-gas, four at least of these compounds are obtained—viz., aniline, picoline, leucolein (or quinoline), and pyridine. b. By the distillation of certain nitrogenous compounds with caustic potash. In this way aniline is obtained from indigo. c. By the combination of ammonia with the aldehyds and with certain volatile oils which possess the properties of aldehyds. Thus acetic aldehyd yields dimethylia, and oil of mustard yields thiosinamine. d. By the substitution (by the action of strong nitric acid) of one atom of nitrous acid ( $NO$ ) for one atom of hydrogen in certain hydrocarbons. e. By the processes of fermentation and putrefaction. Thus wheaten flour yields by putrefaction trimethylia, ethylia, and amyliia.

**ORGANIC COMPOUNDS.** It was formerly believed that the compounds to which the term *organic* is applied could only be produced by a vital force acting in a more or less complex animal or vegetable organism. It is, however, now known that this view is altogether untenable, and that many substances which are products of animal or vegetable organisms may also be formed artificially in the laboratory. Thus urea, the chief and most characteristic organic constituent of urine, may be formed by the direct union of chlorine and carbonic acid (which form *phosgene gas*) with ammonia; and glucose or grape-sugar may be artificially produced from starch, woody fibre, paper, linen, &c. Although such cases as that of urea, in which a complex organic product ( $C_2H_5O_4N_2$ ) is produced by the direct union of three inorganic substances (and many other cases of the same nature might be adduced), shew that there is no definite line of demarcation between organic and inorganic products, it is useful as a matter of convenience, to classify

chemical compounds according to their natural origin.

The following are the leading characteristics of organic compounds: Those which occur naturally rarely consist of more than four elements—viz., carbon, hydrogen, nitrogen, and oxygen—although a few contain sulphur, and possibly (but this is doubtful) phosphorus. By artificial means, however, organic compounds can be formed containing chlorine, bromine, iodine, selenium, tellurium, and many of the metals. Carbon is universally present both in natural and artificial organic compounds. The number of equivalents entering into the composition of organic compounds is usually higher than in the case of inorganic compounds. There is no organic compound into which less than two equivalents of carbon enter, and, according to some chemists, both oxygen and sulphur only enter these compounds in double equivalents. Melissic acid, for example (one of the constituents of wax), is represented by  $C_{60}H_{80}O_4$ ; that is to say, each equivalent of the acid is composed of 124 equivalents of the elements entering into its composition; and each equivalent of the solid fat, commonly known as stearine, contains 114 equivalents of carbon, 110 of hydrogen, and 12 of oxygen. No instance is known in which an organic compound has been formed by the direct union of its elements in a free state, as many sulphides, chlorides, and oxides (for example) are formed in inorganic chemistry. Their extreme readiness to decompose under the influence of heat, fermentation, putrefaction, &c., is another characteristic of organic compounds, although some artificially prepared inorganic compounds—as, for example, chloride of nitrogen—are also very unstable.

The following scheme may serve to elucidate the arrangement of the elements in organic compounds. Such compounds may be composed of carbon and oxygen, as carbonic oxide,  $C_2O_2$ ; or of carbon and hydrogen, as oil of turpentine,  $C_{10}H_{16}$ ; or of carbon and nitrogen, as cyanogen,  $C_2N_2$ ; or of carbon, hydrogen, and oxygen, as grape-sugar,  $C_{12}H_{22}O_{12}$ ; or of carbon, nitrogen, and oxygen, as anhydrous cyanic acid,  $C_2NO$ ; or of carbon, hydrogen, and nitrogen, as nicotine,  $C_{10}H_{14}N_2$ ; or of carbon, hydrogen, and sulphur, as oil of garlic,  $C_6H_8S$ ; or of carbon, hydrogen, nitrogen, and oxygen, as caffeine,  $C_{16}H_{10}N_4O_4$ ; or of carbon, hydrogen, nitrogen, and sulphur, as oil of mustard,  $C_6H_7NS_2$ ; or finally, of carbon, hydrogen, nitrogen, oxygen, and sulphur, as taurine,  $C_4H_7NO_5S_2$ . Hence organic compounds may be binary, ternary, quaternary, or quinary in their composition.

**ORGANIC RADICALS.** Under the term Organic or Compound Radicals (or Radicles, as some chemists write the word) are included a number of groups of elements, of which carbon is always one, which comport themselves chemically like simple elementary bodies. The careful study of organic compounds led chemists to perceive that many of these contained as a proximate constituent a more or less complex atomic group, which in its combining relations behaves precisely like the elementary substances, and which, like them, may be transferred from one compound to another; and hence the inference was drawn, that all organic compounds were combinations of organic radicals with oxygen, sulphur, hydrogen, or other elements, or of one organic radical with another. In accordance with this view, Liebig defined organic chemistry as *The Chemistry of Organic Radicals*. In order to shew how much the theory of organic radicals serves to elucidate the composition of organic compounds, and to reduce the laws of organic to those of inorganic chemistry, we will point out some of the chemical analogies between the radical *ethyl* ( $C_2H_5$ ) and the

metal potassium (K), and between the radical cyanogen (C<sub>2</sub>N) and the halogen chlorine (Cl). Ae is the symbol for ethyl, Cy for cyanogen.

KO = Oxide of potassium, or potash.	AeO = Oxide of ethyl.
KO,HO = Hydrated potash.	AeO,HO = Hydrated oxide of ethyl or ether.
KO,SO <sub>3</sub> = Sulphate of potash.	AeO,SO <sub>3</sub> = Sulphate of oxide of ethyl.
KCl = Chloride of potassium.	AeCl = Chloride of ethyl.
ES = Sulphide of potassium, &c.	AeS = Sulphide of ethyl, &c.
HCl = Hydrochloric acid.	HCy = Hydrocyanic acid.
KCl = Chloride of potassium.	KCy = Cyanide of potassium.
NH <sub>4</sub> Cl = Chloride of ammonium.	NH <sub>4</sub> Cy = Cyanide of ammonium.
HgCl = Chloride of mercury, &c.	HgCy = Cyanide of mercury, &c.

Again, if under certain conditions chloride of ethyl is brought into contact with hydrated potash, the reaction expressed in the following equation occurs :

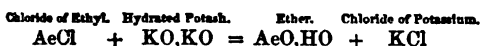

which shews that the ethyl and the potassium may mutually replace one another in compounds; and the same might be similarly shewn of cyanogen and chlorine.

Comparatively few organic radicals have been obtained in an isolated state; and in most cases the existence of any special radical is only inferred from the fact, that the group of atoms of which it is supposed to be composed can be transferred from one elementary substance to another, and can be made to enter into combination with other organic radicals. The existence of ethyl was thus inferred long before the substance itself was isolated, and the radical benzoyl, C<sub>7</sub>H<sub>5</sub>O<sub>2</sub> (symbol, Bz), which exists in the oil of bitter almonds, and on which Liebig specially bases his whole theory of organic radicals, has never been isolated. The simplicity obtained by adopting the radical theory in place of using merely empirical formulas, is well shewn in the two contrasted modes of symbolically representing the compounds which are obtained from this oil :

Empirical Formula.	Rational Formula (Bz = C <sub>7</sub> H <sub>5</sub> O <sub>2</sub> ).
Oil of bitter almonds, C <sub>7</sub> H <sub>5</sub> O <sub>2</sub>	= BzH, Hydride of benzoyl.
Benzoic acid, C <sub>7</sub> H <sub>5</sub> O <sub>2</sub> ,HO	= BzO,HO, Hydrated oxide of benzoyl.
Chlorine-compound, C <sub>7</sub> H <sub>5</sub> O <sub>2</sub> Cl	= BzCl, Chloride of benzoyl.
Sulphur-compound, C <sub>7</sub> H <sub>5</sub> O <sub>2</sub> S	= BzS, Sulphide of benzoyl.
Cyanogen-compound, C <sub>7</sub> H <sub>5</sub> O <sub>2</sub> N	= BzCy, Cyanide of benzoyl.

The organic radicals are either binary or ternary in their composition. Many of them—as, for example, ethyl—consist of carbon and hydrogen; others, as carbonyl (or carbonic oxide), of carbon and oxygen; others, as cyanogen, of carbon and nitrogen; and others again, like benzoyl, of carbon, hydrogen, and oxygen. Into a few radicals a metallic element enters; these are termed organo-metallic radicals; and cacodyl, which contains arsenic, and is represented by the formula As(C<sub>2</sub>H<sub>3</sub>), is the best example of this class. All recent works on organic chemistry are based either on the theory of organic radicals or on the more complicated theory of types, which will be noticed in a special article.

ORGANISTA, the common name of a number of small South American birds, allied to wrens, and remarkable for the sweetness of their song. The Peruvian O. (*Troglodytes leucophrys* of Tschudi) has a modest, cinnamon-brown plumage, with head and neck of dark olive. 'The tender melancholy strains,

and the singular clearness of the innumerable modulations, charm the ear of the astonished traveller, who, as if arrested by an invisible power, stops to listen.'—Tschudi's *Travels*.

ORGANO-METALLIC BODIES. Under this term are included a large number of chemical compounds in which organic radicals, such as methyl (C<sub>2</sub>H<sub>3</sub>), ethyl (C<sub>2</sub>H<sub>5</sub>), &c., are united to metals in the same way as chlorine is combined with zinc, forming chloride of zinc. If, for instance, in chloride of zinc (ZnCl) we replace the chlorine by ethyl, we produce one of the bodies belonging to this class—viz., zinc-ethyl, Zn(C<sub>2</sub>H<sub>3</sub>). This substance (which we take as a good example of the class) is obtained by digesting a mixture of equal volumes of iodide of ethyl and ether with granulated zinc, at a temperature of about 260°, for several hours. Subsequent distillation gives a mixture of zinc-ethyl and ether, from which the former may be obtained pure by rectification, in the form of a colourless, transparent, mobile liquid, which refracts light strongly, has a powerful but not disagreeable odour, and is rather heavier than water, its specific gravity being 1.182 at 64°. With the exception of cacodyl, As(C<sub>2</sub>H<sub>3</sub>), these bodies are the creation of the last ten or twelve years, during which period numerous compounds of organic radicals with zinc, cadmium, magnesium, antimony, arsenic, bismuth, mercury, lead, sodium, and potassium have been discovered.

For further information on this subject, the reader is referred to an article by Dr Frankland (who has most successfully devoted his attention to this class of compounds) in the 13th volume of *The Quarterly Journal of the Chemical Society*, and to an elaborate article on 'Organo-Metallic Bodies' (by the same chemist) in *The English Cyclopædia*.

ORGAN-POINT, or PEDAL-POINT, in Music, a bass note sustained through a series of chords, with only the first and last of which it is in harmony. The sustained note may be the dominant or tonic, and sometimes occupies an upper part instead of the bass.

ORGANZINE, a name applied to silk which after having been first wound off from the cocoons into hanks, is then placed on a winding machine, which reels off the hanks on to wooden reels. These are then placed on spindles, and the fibres of each are made to pass through a minute orifice and small brush, which together clean the thread and remove any knots or projections from it, throwing it at the same time into hanks again. Then the threads of two hanks are taken, and again reeled off, this time on to one hank, being twisted together to the left; then two of these doubled reels are taken, and the ends being laid together, are twisted to the right. These operations, consisting of winding, cleaning, throwing, and twice twisting and doubling, constitute organzine silk. See SILK.

ORGEAT, a kind of culinary preparation, which is both used as an agreeable syrup to mix in certain drinks, or medicinally as a mild demulcent. It is prepared by making an emulsion of almonds, which are blanched for the purpose, and beaten into a paste in a mortar, and then rubbed up with barley-water. The proportions are—1 lb. of sweet and 1 oz. of bitter almonds, to a quart of barley-water. To this emulsion are added 2 lbs. of powdered loaf-sugar, and a quarter of a pint of orange-flower water. There are other modes of making it, but this is the simplest and best. It is much used in France under the name of *Sirup d'Orgeat*.

**ORGIES** (probably from Gr. *ergo*, in the perfect, *ergo*, to sacrifice), or **MYSTERIES**, secret rites or customs connected with the worship of some of the pagan deities; as the secret worship of Ceres (q. v.), and the festival of Bacchus, which was accompanied with mystical customs and drunken revelry. The name is now applied to scenes of drunkenness and debauchery.

**ORGUES** are thick, long, wooden beams, pointed and shod with iron, hung vertically by separate ropes in the gateway of, and over the entrance to a fortified place. They answer the purpose of a portcullis or door, and are dropped into position by cutting the ropes from which they hang. Their descent is inevitable, in which they possess an advantage over the portcullis, which may be held up by the enemy or blown in by petards, whereas petards have little effect on orgues, for if one beam be destroyed, another can be dropped to fill up the gap.

**O'RIEL COLLEGE.** In 1324, Adam de Brom, almoner of Edward II., procured from the sovereign a charter of incorporation for a college, under the name of St Mary's House, in Oxford. The origin of the name 'Oriel College' is uncertain. It consisted originally of a provost and 10 fellows. The number of fellows was by subsequent benefactions raised to 18, and several exhibitions and scholarships were also founded at various times. By the commissioners under 17 and 18 Vict. c. 81, all the fellowships are thrown open, but three are in the meantime suspended for the purpose of increasing the number and value of the scholarships, and of augmenting the salary of the professor of modern history. By the same authority the scholars are placed on the foundation of the college, a position they did not before enjoy; the scholarships are made ten in number, tenable for five years, of value £60 per annum, with rooms free. This college was one of the first to throw open such of its fellowships as it could to competition, and hence the fellows of Oriel have long been among the most distinguished men in the university. For several years back, however, its undergraduates have done little in the schools. The fellows divide upwards of £200 a year, in addition to allowances; and the income of the provostship, to which is annexed a living in Essex and a canonry in Rochester Cathedral, is estimated at £2000 a year. There are thirteen benefices in the gift of this college.

**ORIEL WINDOW**, a projecting window having more sides than one, usually three, and commonly divided into bays by mullions. It is one of the most picturesque features in medieval and Elizabethan domestic architecture, and adds much to the convenience of the interior. The word oriel (Mod. Lat. *oriolum*, probably dim. from *os, oris*, as if a small opening or recess) formerly meant a chamber or apartment, and a window is so called which makes a small apartment, as it were, off a large room. Oriels are also called Bay or Bow Windows (q. v.).

**ORIENTATION.** As Christians from an early period turned their faces eastward when praying, so Christian churches for the most part were placed east and west, in order that the worshippers, as they looked towards the altar, might also look towards the east. Modern observation, however, has found that few churches stand exactly east and west, the great majority inclining a little either to the north or to the south. Thus, of three ancient churches in Edinburgh, it was ascertained that one (St Margaret's Chapel in the Castle) pointed E.S.E.; another (St Giles's Cathedral), E.-by-S.½S.; a third (Trinity College Church, now destroyed), E.½S.

This deviation from the true east has received, among English ecclesiologists, the name of 'Orientation.' Its origin or cause has not been satisfactorily explained. Some have supposed that the church was turned not to the true east, but to the point at which the sun rose on the morning of the feast of the patron saint. But, unfortunately for this theory, neighbouring churches, dedicated in honour of the same saint, have different orientations. Thus, All Saints' at West Beckham, in Norfolk, points due east; while All Saints' at Thwaite, also in Norfolk, is 8° to the north of east. There are instances, too, in which different parts of the same church have different orientations; that is to say, the chancel and the nave have not been built in exactly the same line. This is the case in York Minster and in Lichfield Cathedral. Another theory is, that orientation 'mystically represents the bowing of our Saviour's head in death, which Catholic tradition asserts to have been to the right [or north] side.' But this theory is gainsaid by the fact, that the orientation is as often to the south as to the north. Until some better explanation is offered, it may, perhaps, be allowed to hold, that orientation has had no graver origin than carelessness, ignorance, or indifference.

**O'RIFLAMME, or AURIFLAMME** (Lat. *auri flamma*, flame of gold), a banner which originally belonged to the Abbey of St Denis, and was borne by the Counts of Vexin, patrons of that church, but which, after the county of Vexin fell into the hands of the French crown, became the principal banner of the kingdom. It was charged with a saltire wavy or, with rays issuing from the centre crossways. In later times the oriflamme became the insignia of the French infantry. The name seems also to have been given to other flags; according to Sir N. H. Nicolas, the oriflamme borne at Agincourt was an oblong red flag split into five parts.

**ORIGENES (ORIGEN)**, called *Adamantinos* or *Chalchentzos*—both epithets expressive of his firmness of purpose and iron assiduity—one of the most eminent of the early Christian writers, 'the father of biblical criticism and exegesis in Christendom,' was born 185 A. D., at Alexandria, where his father, Leonidas, seems to have held some superior office in the church. O. received a most liberal education. While, on the one hand, he was initiated at an early age into Hellenic science and art, the teachings of Christianity were instilled into his mind by men like Fantœnus and Clemens of Alexandria. During the persecutions against the Christians, instituted by Sept. Severus, his father died the death of a martyr, and O., then 17 years of age, would have shared it of his own free will, had not his mother, left unsupported with six children, prevented him. After a short time his zeal and erudition procured for him the office of catechist in the Alexandrian church; but no salary being affixed to it, he was fain to dispose of his much-loved collection of classical authors for a daily stipend of four oboli (2d.) for several years. His wants were extremely limited, and his asceticism led him even to self-mutilation (in accordance with the view he took of Matt. xix. 12): an act for which he afterwards expressed the deepest sorrow, and which became a dangerous weapon in the hands of his antagonists. Not a few of his hearers being masters of Greek (Neoplatonic) philosophy, O., in order to ward off more successfully their attacks upon his doctrines, and to combat them on their own ground, applied himself particularly to this science, and Ammonius Saccas himself is said to have been his teacher. From this

period also may be dated O.'s transition from unconscious to conscious belief. He examined henceforth, with as little prejudice as possible, all the different systems of human speculations that came under his notice during the many journeys he undertook, proceeding on the principle 'that we are not, under the pretence of piety, to pin our faith on that which is held by the multitude, and which therefore alone seems to stand on high authority, but on that which results through examination and logical conclusions from established and admitted truths.' This liberality of his mind and doctrines could not fail, on the one hand, to bring about many conversions to the faith, as he taught it, both among 'pagans' and 'heretics,' the latter chiefly of the Gnostic sects; and on the other hand, to raise an outcry among less liberal professors and teachers of the faith, who had not been so successful in their labours. What gave the greatest offence in his teachings was his way of explaining, after the manner of the Midrash, known to him through the Jewish masters (from whom, at an advanced age, he had also learned Hebrew), allegorically and symbolically that which in the Scripture warred with the common human understanding, or seemed repugnant in manner or matter. Furthermore, while upholding all the ethical portions of the Bible, he rejected a great deal of its supposed historical and legal contents for all purposes, save, perhaps, as starting-points for homiletics. 'What edification,' he says, 'could we find in literally interpreting the story of Abraham's first telling Abimelech a lie, and then, with Sarah's consent, handing her over to him and prostituting her?' As to the discrepancies in the different gospels respecting the life of Christ, he says: 'One of two only is possible. Either these things are true in a *spiritual* sense only, or as long as the discrepancies are not satisfactorily explained away, we cannot believe in the gospels being dictated by the Holy Ghost, and redacted under the influence of his inspiration.'

In 211 he went to Rome, but soon afterwards, at the wish of Bishop Demetrius, he returned to Alexandria, which, however, he was obliged to leave precipitately, and to seek refuge from certain popular tumults in Palestine. Here the bishops received him with great honours, and desired him to institute public lectures, in which they themselves became hearers. Recalled again by the Alexandrian bishop, he was sent to Achaia to combat certain heresies that had broken out there. The wrath that had silently been gathering against him found its first vent when, in 228, the bishops assembled in Cæsarea in Palestine consecrated him presbyter. The Bishop of Alexandria took umbrage at this outrage, as he called it, on his authority. Two councils were convoked, and in 232, O. was deprived of his priestly office, and excommunicated, the principal heresy charged against him being his denial of eternal punishment. Yet the churches of the East remained faithful to him. Palestine, Arabia, Phœnicia, and Achaia remained in constant communication with him; and men like Gregory Thaumaturgus (q. v.), Athenodoros, and others remained or became his faithful disciples ever after, while the Bishop of Cæsarea allowed him openly to expound the Scripture in his church. The persecutions under Maximinus again forced him to seek refuge for two years in Cappadocia. Returning under Gordianus, he resumed his labours and journeys, until, when Decius ascended the throne, he was seized, imprisoned, and tortured for his faith. He did not survive his sufferings long, but died, in 254, at Tyre, where his tomb, near the high-altar of the cathedral, was shewn for many centuries, until it was destroyed during the Crusades.

The number of his works is stated by Epiphanius and Rufinus to have exceeded 6000, and although this is probably only meant as an exaggerated round number, yet the amount of writings that issued from his always busy brain and hands cannot but have been enormous. Seven secretaries and seven copyists, aided by an uncertain number of young girls, are by Eusebius reported to have been always at work for him. The great bulk of his works is lost; but among those that have survived, the most important by far are his two editions of the Old Testament, called respectively *Tetrapla* (fourfold) and *Hexapla* (sixfold). See HEXAPLA. The labour bestowed upon this work must have been immense, and no less than twenty-eight years is O. supposed to have been engaged upon it. On its importance for biblical criticism it is needless to enlarge here. Fragments only have come down to us, the original having been lost during the siege and capture of Cæsarea by the Arabs; and the Greek as well as the Roman clergy having almost laid an interdict upon the copying of any of O.'s much suspected writings. Montfaucon has collected and edited these fragments (*Hexaplorum Origenis quas supersunt*, 2 vols. fol. Paris, 1714), which were re-edited by C. F. Bahrdt (1769—1770). Of his other partly extant, partly lost works, the chief are his books 'On the Resurrection,' 'On Martyrdom,' 'Eight Books against Celsus,' 'On Prayer,' besides Epistles, &c. He further revised and enlarged Philo's Lexicon of Hebrew Names (*Hebraicorum Nominum S. Scripturæ et Mensurarum Interpretatio*), whence it has often, together with many other spurious works, been ascribed to him exclusively. Little also has survived of his many exegetical writings, commentaries, brief notes, and homilies on both Testaments. The best editions of his collected works are by De la Rue (Rudens), (Paris, 1733—1759, 4 vols. fol.); by Oberthür (Wurzburg, 1785—1794, 15 vols.); and by Lommatzsch, which is critical and more complete (Berlin, 1831), &c.

ORIGINAL SIN. According to this theological tenet, when stated in its extremest form, men come into the world with the reason and will utterly corrupt. This corruption originated in the fall of Adam, and has been inherited equally by all his posterity, so that the natural man is not only incapable of knowing and loving God and goodness, but is inclined to contemn God and pursue evil; on which account the anger of God has subjected him to temporal death, and destined him to everlasting punishment in hell. The doctrine is founded on the account of the fall given in Genesis, and on some passages in Paul's Epistle to the Galatians, and in that to the Romans; which passages, however, are held by others to contain no such doctrine; and indeed nearly every point in the history of the doctrine is the subject of as much controversy as the details of the doctrine itself. The early church, it is maintained by one school, was unacquainted with it; and the most orthodox admit that the doctrine had not at that time been fully developed. The Christian fathers, Justin Martyr, Clemens Alexandrinus, Irenæus, and others, ascribe to the natural man a certain ability to know God and choose the good, they are said to reject distinctly all propagation of sin and guilt, and even to refer human mortality not to Adam's sin, but solely to the constitution of the body. Origen, on the other hand, in opposition to the Gnostics and Manichees, who grounded the sinfulness of men on the connection of the soul with a material body, asserted that the sinfulness was in existence at birth, but ascribed the development of actual sins and their consequences not

to propagation, but to the moral operation of precept and example. He accordingly found the cause of sin to be in the freedom of the will, the abuse of which he explained partly by the operation of evil powers, partly by the predominance of the sensuous part of man's nature over the rational mind. The orthodox teachers of the Greek Church, again, held that Adam, by the fall, rendered himself and all his posterity mortal, but, according to the less rigid schools, they looked for the origin of sin in the freedom of the will acted upon by the flesh, and by demoniacal influences, and ascribed to man the power of resisting every evil if he chose. These views, it is alleged, continued to be held, in substance, by the Christian teachers in the east, and were fully developed by Chrysostom; but Catholic writers maintain that in all this Chrysostom and the other Greek Fathers are speaking not of the natural powers of the will, but of the will as assisted by divine grace.

The doctrine took another shape in the Latin Church. Tertullian, following up his dogma of Traducianism, according to which the child derives not only its body but its soul from its parents, maintained that sinfulness had been propagated, along with mortality, from Adam to all mankind; he thus defended an *originis vitium*, without conceiving it as actual sin and denying all capacity for good in man. This view was followed by Cyprian, Ambrose, and even by Augustine in his earlier writings. It was only during his controversy with Pelagius and Cælestius that Augustine came to develop the doctrine of original sin into the full form given above. His great influence in the western churches procured the condemnation of his opponents, the Pelagians (q. v.), as heretics at the Councils of Carthage (412, 416, 418), although the Councils of Jerusalem and Diospolis (415) decided in their favour. Building upon the foundation of Traducianism, Augustine laid down that every natural man is in the power of the devil, and upheld the justice of this as a punishment for the share which the individual had in Adam's transgression; for as all men existed in the loins of Adam, all sinned with him. Pelagius, on the other hand, who rejected the Traducian theory, denied that sin is propagated physically, or that the fall of Adam has exercised any prejudicial influence on the moral constitution of his posterity; and maintained that all men are born in a state of innocence, possess the power of freewill, and may therefore live without sin. He and his followers objected to Augustine, that his doctrine was in direct contradiction to clear passages of Scripture, and that it made God the originator of evil and an unrighteous judge.

Great as was the respect for Augustine, the harshness of his doctrine was too shocking to the natural sentiments to meet with lasting acceptance. In the eastern church it never gained a footing, and even in the west it met with opposition. In Gaul, John Cassian, Faustus, Arnobius, and others, took up a view midway between the views of Augustine and Pelagius, from which they were called Semipelagians. They attributed to man a capacity for good which makes it possible for him, not indeed to merit the favour of God, but to make himself capable of receiving it; and maintained that it is only a certain inborn weakness that men inherit from the first pair. The Semipelagian doctrine found acceptance especially among the monks (in particular among the Franciscans), continued to prevail during the middle ages, and among the scholastics found partisans in the Scotists. Augustine's views also found advocates among the scholastic philosophers, who, however, added to it many limitations and explanations. Regarding the way

in which original sin is propagated, many held by the Traducian theory, while others conceived it to be a sort of infection of the soul by the defiled body, or an imputation of guilt to all partakers of the human nature. Petrus Lombardus adhered to Augustine. Anselm of Canterbury conceived original sin to be a want of requisite righteousness, and thought that this want was imputed to all the posterity of Adam, although not in the same degree as if they had themselves sinned. Anselm's view was adopted by Duns Scotus, while Bonaventura and Thomas Aquinas sought to combine the opinions of Anselm and Augustine. Anselm had thought that his theory afforded a better explanation of the sinless birth of Christ; and about the 12th c. it began to be maintained that Mary also was conceived without sin.

The reformers of the 16th c. everywhere made original sin a leading doctrine, and thus were enabled to combat effectively the Roman Catholic doctrine of the merit of works; while the Catholic Church, in the fifth session of the Council of Trent, stamped what the Calvinist school would call Semipelagianism as the orthodox doctrine. The reformed churches agreed with the Lutheran on the point of original sin. In this they followed Calvin rather than Zwingli, who looked upon it as an evil or disease, and as becoming sin only when a commandment is transgressed. The Arminians and Socinians, on the other hand, denied the doctrine of hereditary sin in the ecclesiastical sense. The Mennonites spoke of a loss of the divine image in consequence of the fall of Adam, but still asserted the freewill of man. The Quakers rejected the name of original sin altogether; they held that there is a germ of sin in man, from which innumerable sin springs, and that, however corrupt, he has still the susceptibility of being awakened to the inward light. The whole Protestant Church held, besides, that Jesus alone was free from sin, both original and actual. The Roman Catholic Church ascribed this attribute also to Mary, though no public and distinct declaration on the point was given by the Council of Trent. See IMMACULATE CONCEPTION.

The harshness of the Augustinian dogma led, at the time of the Reformation, to keen controversies; Erasmus disputed the point with Luther, and would only admit a weakness of the freewill arising from original sin, and by no means a complete annihilation of it. From that time the doctrine in Germany continued to be variously attacked and defended. It has been discussed by the schools of philosophy. Kant shewed the moral signification of the dogma, and made out original sin to be a propensity to evil inherent in man. The Schelling-Hegel school, again, explained it as the finite nature with which the individual is born. In recent times, the theologians of the old Lutheran and strictly orthodox tendencies, such as Olshausen, Tholuck, Hengstenberg, and others, have come forward as adherents and defenders of the Augustinian doctrine; while the more liberal theologians modify it in various ways, not admitting any moral inborn corruption arising from the fall, but only a weakness in man's nature for the knowledge and performance of good. How far, and with what differences, the extreme Augustinian view is held by the churches of England and Scotland, will be seen from the following extracts from the *Thirty-nine Articles* and the *Westminster Confession of Faith*.

From Art. ix. of the *Thirty-nine Articles*: 'Original sin standeth not in the following of Adam (as the Pelagians do vainly talk); but it is the fault and corruption of the nature of every man, that naturally is engendered of the offspring of

Adam, whereby man is very far gone from original righteousness, and is of his own nature inclined to evil, so that the flesh lusteth always contrary to the spirit; and therefore in every person born into the world, it deserveth God's wrath and damnation.'

From chap. vi. of the *Westminster Confession*: 'By this sin' (i. e., the eating of the forbidden fruit), 'they' (i. e., our first parents) 'fell from their original righteousness and communion with God, and so became dead in sin, and wholly defiled in all the faculties and parts of soul and body. They being the root of all mankind, the guilt of this sin was imputed, and the same death in sin and corrupted nature conveyed to all their posterity, descending from them by ordinary generation. From this original corruption, whereby we are utterly indisposed, disabled, and made opposite to all good, and wholly inclined to all evil, do proceed all actual transgressions.'

ORIHUELA, an ancient town of Spain in the modern province of Alicante, and 36 miles south-west of the city of that name, stands on the banks of the Segura, in a plain remarkable alike for its beauty and its fertility. It is long and straggling, while its palm-trees, square towers, and domes give it an oriental appearance. It contains a cathedral, numerous churches and convents, barracks, &c. The manufactures are linen goods and hats, and many corn and oil mills and tanneries are in operation. Olive oil is very extensively made. The vegetation here is gigantic; the oleanders are actual trees. O. has been possessed by Carthaginians, Romans, Moors, and Spaniards in turn. Pop. 16,500.

ORILLON, in Fortification, and especially in the earlier systems, is a semicircular projection at the shoulder of a bastion, intended to cover from

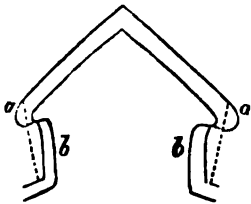

Orillon :

a, a, orillons; b, b, retired flanks (the dotted lines shew the original bastion).

the observation of the enemy the guns and defenders on the flank, which, with such a construction, is somewhat retired or thrown back. The flank thus protected is held by many distinguished engineers to be most valuable in the defence of the ditch, in clearing it from an attacking party, or from hostile miners. The retired flank is sometimes straight, at others curved, as in the figure. The orillon is as old as the bastion, and is found in the works of Pagan and Speckle.

ORINO'CO, a great river of South America, flows through Guiana and Venezuela, and reaches the Atlantic Ocean south of Trinidad, in lat. 8° 40' N. The country in which it takes its rise is inhabited by an aboriginal race called the Guacacas, who have hitherto prevented all access by foreigners to its sources; but it is known to rise in the Sierra Parime, one of the chief mountain chains of Guiana, near lat. 3° 40' N., long. 64° 30' W. It has been explored by Humboldt to the village of Esmeraldas (lat. 3° 8' N., long. 66° 5' W.), and by Schomburgk to within 30 miles of its source. After flowing west-south-west 20 miles past Esmeraldas the river bifurcates, and the southern branch, the Cassiquiari (q. v.), flowing south-west, joins the Rio Negro, an affluent of the Amazon. From this point the O. flows north-west to its junction with the Guaviare, then north-north-east to its junction with the Apure, after which it flows in an eastward direction to its mouth. Length of course, 1960 miles. The head of uninterrupted navigation is at the confluence

of the O. with the Apure, 777 miles from the mouth of the river. Above this point the course of the river is interrupted by 'raudals' or cataracts, of which those of Maypures and Atures are the most celebrated. Its principal affluents from the left are the Guaviare, the Vichada, the Meta, and the Apure; from the right, the Ventuare, Caura, and Caroni. The O., which is joined by 436 rivers, and upwards of 2000 streams, drains an area (usually stated at 250,000 square miles) which, according to Wappäu's *Republik von Süd-Amerika*, may be estimated at 650,000 square miles. It begins to form its delta 130 miles from its mouth, by throwing off a branch which flows northward into the Atlantic. Several of the mouths are navigable, and the main stream, the Boca de Navios, is divided by a line of islands into two channels, each two miles in width. Bolivar, a town upwards of 250 miles from the mouth of the river, marks the head of tide-water, and here the river is 4 miles wide and 390 feet deep. Below the junction of the Apure the character of the scenery seems to be uniform—forests on the right bank, and llanos on the left.

O'RIOLE (*Oriolus*), a genus of birds of the Thrush family (*Merulida* or *Turdida*), having an elongated conical beak, broad at the base; the upper mandible ridged above, and notched at the point; wings of moderate size, the first feather very short, the third the longest; the tail of moderate length, and rounded; the tarsus not longer than the middle toe; the outer toe joined at its base to the middle toe; claws strong and curved. The species are numerous, all natives of the Old World, and chiefly of the warmer parts of it; the adult males generally of much brighter plumage than the females and young males, the prevalent colour yellow. Only one species is found in Europe, the GOLDEN O. (*O. galbula*), pretty common in Italy and some other parts of Europe, but a rare summer visitant of England, and never seen in Scotland, although it occasionally breeds in the south of Sweden.—The name O. is still very commonly given to the Baltimore Bird (q. v.) and other American birds of the Starling family, the chief resemblance of which to the true orioles is in colour.

ORION, in Greek Mythology, was a gigantic hunter, and reputed the handsomest man in the world. His parentage is differently given. According to the commonly received myth, he was the son of Hyrieus of Hyria, in Beotia, and was called in his own country Kandaon. Another account makes him a son of Poseidon and Euryale, while some state that he was *Autochthonos*, or 'earth-born.' So immense was his size, that when he waded through the deepest seas he was still a head and shoulders above the water; and when he walked on dry land, his stature reached the clouds. Once on a time he came to Chios, in the Ægean Sea, where he fell in love with Æro or Merope, daughter of Cœnopion. He cleared the isle of wild beasts, and brought their skins as presents to his sweetheart; but her father always put off their marriage; whereupon O., one day giving way to passion (when under the influence of wine), sought to take the maiden by force. Cœnopion now called upon Dionysus (Bacchus) for help, who put out the eyes of the inebriate lover. O., however, recovered his sight in Lemnos, by following the advice of an oracle, and returned to Chios to take vengeance on Cœnopion. Not finding him, he went to Crete, where he spent the rest of his life hunting in company with Artemis (Diana). The cause and manner of his death are differently related. Artemis



say some, slew him with an arrow, because Eos, inflamed by his beauty, had carried him off to Ortygia, and thereby offended the gods. Others aver that Artemis, virgin-goddess though she was, cherished an affection for him, that made her brother Apollo fiercely indignant. One day, pointing out to her at sea a black object floating in the water, he told her that he did not believe she could hit it. Artemis, not recognising her favourite, drew her bow, and pierced him through the head; a third myth makes him find his death from the sting of a scorpion. Asklepios (*Æsculapius*) wished to restore him to life, but was slain by a bolt of Zeus. After his death, O. was placed with his hound among the stars, where, to this day, the most splendid constellation in the heavens bears his name.

ORI'SSA, an ancient kingdom of Hindustan, the authentic history of which goes back to 473 A.D., extended from Bengal—a part of which it included—on the N., to the banks of the Godavari on the S., and from the coast on the E. to the river Gondwana on the W. From its remains of sculptures, inscriptions, &c., we may infer that its early civilisation was high. The temple of the sun at Kanārek—erected about the 12th c.—exhibits carvings representing the planets, sculptured figures of animals, &c., which shew that at that date the plastic and mechanical arts were in a more advanced state in O. than they were in England. It maintained its position as an independent monarchy till 1558, when, its royal line having become extinct, it became an outlying province of the empire of the Great Mogul. On the breaking up of this empire, the more valuable portions of O. were seized by the Nizam of Hyderabad. The French, who had taken possession of a part of the country long known as the Northern Circars, attempted to drive the English (who had also formed commercial settlements on the coast), out of India. The result of the contest for supremacy in India between the French and English is well known. The Mahrattas, who had seized a portion of O. in 1740, were forced to surrender it to the English in 1803. The soldiers of the East India Company were marched into O. at the commencement of the present century, and an engagement was subsequently entered into between the Company and the native chiefs and princes, by which the former bound themselves to perform certain services for the country (as maintaining the river-banks in good repair), while the latter engaged to pay a yearly tribute. Of the many principalities into which O. was divided, a large number got into arrears with the government, and the result was that numbers of the estates were sold, and the government, as a rule, became the purchaser. Much of the territory originally forming a portion of this kingdom thus fell into the hands of the British. The ancient O., which existed as an independent monarchy for four centuries, and flourished as a principality of the Mogul empire after 1558, is now hardly to be recognised in the British dependency of Cuttack (q. v.), within the limits of which it is comprised. The country is traversed by a branch of the Eastern Ghauts running parallel with the coast. The hill-districts, which nowhere present an elevation of more than 3000 feet, are inhabited by the Gonds, the Koles, the Sourahs, and the Khonds. The Khonds are believed to be the descendants of the aboriginal inhabitants of the country. This tribe occupied an area extending from north of the Mahanaddi, south to the banks of the Godavari. Their mountain-haunts are admirably suited for defence, as the districts which they inhabit are almost inaccessible; and although they do not yet appear to have adopted firearms, they manage their battle-

axes and bows and arrows with an adroitness and courage that make them formidable enemies. The Khonds are a totally distinct race from the inhabitants of the plains, and there is but little resemblance between them and the other hill-tribes, the Gonds and Sourahs. The chief peculiarities of the Khonds are, that their language, which is quite distinct from those of the neighbouring tribes, is not in the least understood by the inhabitants of the plains; and that human sacrifice formed, till within the last few years, one of the distinguishing features of their religion. They do not barter or traffic, and all commercial transactions are managed for the Khonds by the Panus, who are regarded by their employers as an inferior race. There are, however, no caste prejudices among the Khonds such as generally prevail throughout the plains of India. Agriculture and war are the only employments. The revolting custom of human sacrifice prevailed among the Khonds from the earliest times, although it was not till 1836 that the attention of the government was specially called to the subject, at the conclusion of an insurrection, in the course of which British officers had been brought into contact with the Hill tribes. The Khond victims, called Meriah, were always bought with a price, sometimes from families of their own tribes who had fallen into poverty, but generally kidnapped from the plains by miscreants of the Panu race. The Meriah victims were of both sexes, and of every age; though adults were held in the highest esteem, because, being the most costly, they were supposed to be more acceptable to the deity. The object of the sacrifice was to propitiate the earth-god; and abundant crops, security from calamity, and general prosperity were supposed to be insured to any one who had cut off a portion of the flesh of the human victim, and buried it in his farm. The consummation of the Meriah sacrifice was often attended with circumstances of the most revolting and disgusting cruelty. In some cases the event was preceded by a month's feasting, intoxication, and dancing round the Meriah. On the day before the sacrifice, the priest thus addressed the victim: 'We have bought you with a price, and did not seize you; now we sacrifice you according to custom, and no sin rests with us.' On the following day the victim was made senseless from intoxication, and then suffocated; after which the officiating priest cut a portion of the flesh from the body, and buried it as an offering to the earth-god. The people, following his example, hewed the flesh from the bones, and carried the bloody trophy to their distant villages, where it was buried. In many cases the victim was not intoxicated before sacrifice; but the joints of his arms and legs were broken with a hatchet, in order to prevent the possibility of resistance. In 1837, General (then Captain) Campbell was appointed assistant-collector in Ganjam, the adjoining district in the plains, and with varied success devoted much of his time to endeavouring to suppress the rite. He was succeeded in 1841 by Major (then Lieutenant) Macpherson, C.B. Encouraged by the success of his labours, the government in 1846 established, under Macpherson, a separate agency for the suppression of Meriah sacrifices in the Hill tracts of O., in which he was succeeded, in 1847, by Major-general Campbell, who carried on, with undiminished success, the good work commenced by Macpherson, pushing his inquiries and exerting his authority among tribes unvisited by his predecessor; and reports have been sent in from all parts of the country, stating that for several years hardly any Meriah sacrifices have taken place in the great Hill tract of Orissa. In the year 1852

—1853, all victims retained for sacrifice were demanded, and in only one instance had the demand to be followed up by force. The practice of female infanticide, in this district at one time dreadfully common, to which attention was first called by Major Macpherson, has now also become almost wholly suppressed.

See *Report by Lieutenant M'Pherson, Calcutta, 1841; An Account of the Religion of the Khonds in Orissa, idem in the Trans. of Asiat. Societies, 1851; Personal Narrative of Service amongst the Wild Tribes of Khondistan, Major-General Campbell, 1864; Calcutta Review, No. IX., XI., XV., and XX.; Kaye's History of the Administration of the E. I. Coy., 1853; Memoir: Administration of India during Last Thirty Years, 1858 (London); Indian Records—History of the Rise and Progress of the Operations for the Suppression of Human Sacrifice and Female Infanticide in the Hill Tracts of Orissa, Calcutta, 1854.*

ORISTANO, a town, and inferior river port on the west coast of Sardinia, 56 miles north-west of Cagliari. It stands in a fruitful, well-cultivated plain, about a mile from the left bank of the Tirso or Oristano, and 3 miles from its mouth in the Gulf of Oristano, which is about 10 miles in length, with a breadth of 5 miles. It is surrounded by ancient walls flanked with towers; contains a cathedral with a great clock tower, the most conspicuous object in the town; an archbishop's palace, college, and several churches and convents. It carries on manufactures of ironware, cutlery, and agricultural implements, and a number of its inhabitants are engaged in the tunny fishery on the coast. Corn, salt fish, and the wine of Vernaccia are exported. In winter the town is busy and lively; but in summer it is unhealthy, and during that season all who can afford to do so, leave it. Pop. 5750.

ORIZABA, a town of Mexico, in the state of Vera Cruz, 70 miles west-south-west of the town of that name, and 25 miles south of the volcano of Orizaba. The vicinity is unusually fertile, and is covered with forests. The town contains numerous churches, a high school, and an extensive cotton spinning-factory. Coarse cloths and tobacco are largely manufactured, and there is much general industry. Pop. 15,000.

ORKNEY ISLANDS, which, with Shetland, form one county, separated from Caithness by the Pentland Firth (q. v.), lie between 58° 41' 24" and 59° 23' 2" N. lat., and between 2° 22' 2" and 3° 25' 10" W. long.; and are 73 in number at low-water, of which 28, besides Pomona, or the Mainland, are inhabited. The area of the O. I. is 2448 square miles, or 156,872 imperial acres. The surface is very irregular, and the land is indented by numerous arms of the sea. Previous to the middle of last century, the agriculture of Orkney was, in more than an ordinary degree for the time, in a primitive state. There was little communication then with the mainland, and improvements were slowly adopted. The spinning-wheel, for instance, was not introduced there for half a century after it was in use elsewhere. Until towards the end of last century, little advance seems to have been made in the management of the land, the inhabitants deeming it more important and profitable to direct their attention to the manufacture of kelp. They used to suffer periodically from bad seasons and violent storms, when less help could be afforded to them from without. In 1778, a great hurricane of four hours' duration drove the sea-spray over the islands. The grain crop was in consequence sea-gusted, and rendered almost worthless, and there required to be imported 18,000

bolts of meal and bere, besides other articles, costing £15,000, or nearly twice the gross rental of the country. Orkney was formerly divided into 32 parishes, having 8 parish ministers. It now contains 22 parishes, forming 3 presbyteries and 1 synod. There are also about 30 congregations belonging to the Free and United Presbyterian Churches, besides 3 Independent, and one or two others.

The temperature of Orkney is comparatively mild, considering its northern latitude. This arises partly from its being surrounded by the sea, but chiefly from the neighbourhood of the Gulf Stream to the western shores. The mean temperature in February, the coldest month, taking a series of 33 years from 1826, was 38°, and in July 55° 14'. Only twice during that period did the mean monthly temperature fall below the freezing-point, in February 1838 and 1855, when it fell to 31° and 31° 64'; and during the same period it was never so high as 60°, except in 1852, when it reached 60° 64'. The rain-fall during these 33 years averaged 36½ inches.

The carrying-trade and merchandise of Orkney have greatly increased of late years. The exports rose from £49,308 in 1848 to £181,433 in 1861. The exports are chiefly of fish and agricultural produce, of which cattle are the principal.

The number of acres in 1857 under grass and hay was 11,309, and under tillage 38,293; the chief crops being—wheat, 58 acres, averaging 22 bushels per acre; barley, 143 acres, averaging 30 bushels per acre; bere, 5533 acres, averaging 29 bushels ¾ pecks per acre; oats, 13,280 acres, averaging 31 bushels per acre; turnips, 4946 acres, averaging 11 tons 17 cwt. per acre; potatoes, 2329 acres, averaging 4 tons 3 cwt. per acre. The number of horses was 3741; cattle, 14,887; sheep, 13,586; swine, 2749; total stock, 34,963. The number of occupants was 891.

The chief towns are, Kirkwall (q. v.), the capital, and Stromness, in which there are 3 distilleries, producing upwards of 20,000 gallons of whisky annually. The old valued rent of Orkney and Shetland was £57,786 Scots, of which about two-thirds, or £38,500, were attributed to Orkney. The valuation of Orkney, exclusive of Kirkwall, for the year 1864, was £47,132, 3s. Inhabited houses, 6064; pop. (1861) 32,395. Constituency returning a member of parliament, with Shetland, 433.

The Orkneys, under the name *Orcades* [whence the modern adjective, *Orcadian*], are mentioned by the ancient geographers, Pliny, Ptolemy, Mela, and by other classical writers, but of their inhabitants we know almost nothing till the dawn of the Middle Ages. They were most probably of the same stock as the British Celts. From an early period, however, the Norsemen resorted to these islands, as a convenient spot from which to make a descent on the Scotch and English coasts. In 876, Harald Haarfager conquered both them and the Hebrides. During the greater part of the 10th c., they were ruled by independent Scandinavian jarls (earls), but in 1098 they became formally subject to the Norwegian crown. Thus they remained till 1468, when they were given to James III. of Scotland as a security for the dowry of his wife, Margaret of Denmark. The islands were never redeemed from this pledge; and in 1590, on the marriage of James I. with the Danish Princess Anne, Denmark formally resigned all pretensions to the sovereignty of the Orkneys. During their long connection, however, with Norway and Denmark, all traces of the primitive Celtic population disappeared, and the present inhabitants are of the pure Scandinavian stock.

**ORLE**, in Heraldry, one of the charges known under the name of sub-ordinaries, said to be the diminutive of a Bordure (q. v.), but differing from it in being detached from the sides of the shield. It may be the sole charge in a shield. Or, an orle gules was the coat borne by John Baliol. An orle



Orle.

of heraldic charges of any kind denotes a certain number (generally eight) of these charges placed in orle, as in the coat of the old Scottish family of Gladstones of that Ilk; argent, a savage's head coupé, distilling drops of blood proper, thereon a bonnet composed of bay and holly leaves all proper, within an orle of eight martlets sable.

**ORLEANS**, an important commercial town of France, capital of the department of Loiret, and formerly capital of the old province of Orleannais, which now forms the greater part of the departments of Loiret, Eure-et-Loir, and Loir-et-Cher, is situated on the right bank of the Loire, here crossed by a bridge of 9 arches, and is  $75\frac{1}{4}$  miles south-south-west of Paris by railway. Close to the city is the Forest of O., one of the largest in the country, consisting of 94,000 acres, planted with oak and other valuable trees. O. stands on the verge of a magnificent plain sloping toward the Loire, and watered by the Loire and Loiret, and is surrounded on the land-side by a wall and dry ditches, on either side of which there are pleasantly shaded boulevards. Around it are eight prosperous and populous suburbs. Among its principal buildings are the cathedral, with two lofty and elegant towers, one of the finest Gothic edifices in the country; the tower; bishop's residence; the houses of Joan of Arc, of Agnes Sorrel, of Diane de Poitiers, of François I., of Pothier; the churches and hospitals, which are numerous; the *musée*, theatre, &c. The town contains three statues of Joan of Arc, of which the equestrian one was inaugurated in 1855. The situation of the town has many commercial advantages, arising from its position on a navigable river, on lines of railway which connect it with Paris and the great trading towns in the south of France, and on the canal which connects the Loire with the Seine. Manufactures of hosiery, cotton and linen goods, refined sugar, vinegar, bleached wax, leather, &c., are carried on, and the trade is chiefly in stockings, sheepskins, wine, brandy, corn, and sugar. Pop. 50,798.

O., originally called *Genabum*, afterwards *Aureliani* (probably from the Emperor Aurelian), of which the modern name is only a corruption, was besieged by Attila in 451, but relieved by the Romans, who here defeated Attila. It afterwards passed into the hands of the Franks, was taken by the Northmen in 855, and again in 865. In 1428, it was besieged by the English under the Duke of Bedford, but was delivered from the besiegers by the inspiring exertions of Joan of Arc (q. v.), who on this account is also named the Maid of Orleans. During the religious wars of the 16th c., O. suffered severely.

**ORLEANS, HOUSE OF.** See **BOURBON**.

**ORLEANS, JEAN BAPTISTE GASTON, DUC D'**, third son of Henry IV. of France and Mary de Medici; was born at Fontainebleau, 25th April 1608.

He possessed tolerable abilities, but his education was neglected. On his marriage with Marie of Bourbon, Duchess of Montpensier, in 1626, he received the duchy of Orleans as appanage. His wife soon died, leaving one daughter, the celebrated Mademoiselle de Montpensier. His brother, Louis XIII., regarded him with dislike as heir-presumptive to the throne, the queen having no children; and the treatment which he received at the hands of the king and of Richelieu, led him to join with his mother in attempting the overthrow of that minister. He left the court with a number of other great nobles in February 1631; sought the support of the Duke of Lorraine, whose sister he married; and raised in the Spanish Netherlands a corps of 2000 men, at the head of which he crossed the French frontier, assuming the title of Lieutenant-general of the Kingdom; but was completely defeated by Marshal Schomberg at Castelnaudary, and fled to the Duke of Lorraine, whom he thereby involved in ruin. In 1634, however, he returned to the French court. Richelieu sought to have his marriage with Marguerite of Lorraine declared invalid, but after a long struggle, and much disputing among jurists and theologians, its validity was sustained. The duke was, however, again obliged to leave France in consequence of fresh intrigues against Richelieu. After Richelieu's death, a reconciliation was effected between him and his brother, the king, by the ministers Mazarin and Chavigny; and Louis XIII. appointed him Lieutenant-general of the kingdom during the minority of Louis XIV. Mazarin and the queen-mother, Anne of Austria, attempting to assume all power to themselves, the duke placed himself at the head of the Fronde (q. v.); but with his usual vacillating weakness and selfish sacrifice of his friends, soon made terms again with the court. Yet, when Mazarin returned from banishment in 1652, the duke again assembled troops for the Prince of Condé, upon which account, after the disturbances were ended, he was confined to his castle of Blois, where he died on 2d February 1660. He left three daughters by his second marriage.

**ORLEANS, NEW.** See **NEW ORLEANS**.

**ORLEANS, PHILIPPE, DUC D'**, regent of France during the minority of Louis XV., was the son of Philippe, Duc d'Orleans, and the grandson of Louis XIII., and was born 4th August 1674. He possessed excellent talents, and made unusual attainments both in science and belles lettres; but his tutor, Cardinal Dubois (q. v.), did not scruple to minister to the strong passions of the young prince, and exercised a most pernicious influence over him. He gave himself up to debauchery. The king compelled him to marry Mademoiselle de Blois, his daughter by Madame de Montespan. He astonished and alarmed the court by protesting against his exclusion by the testament of Charles II. from all right of succession to the throne of Spain, and by the attention which he immediately began to give to military and political affairs. His military talents, however, led to his employment in the wars in Italy and in Spain; but his presence in Madrid after his victories was regarded with apprehension both by Philip V. and by Louis XIV. He had, indeed, formed the design of taking possession of the Spanish throne for himself. In consequence of this, he lived for some years in complete exile from the court, and much dreaded by it; spending his time both in vicious excesses, and in the cultivation of the fine arts and the study of chemistry. This study afforded a pretext to Madame de Maintenon and her party for accusing him of poisoning the dauphin and others of the royal family, who died suddenly, and in rapid succession, of malignant fever, in 1711.

The king refused an investigation which the duke demanded. Louis, having legitimised his sons, the Duke of Maine and the Count of Toulouse, appointed the Duke of Orleans only president of the regency and not regent, giving the guardianship of his youthful heir and the command of the household troops to the Duke of Maine; but all this was set aside at his death, and the Duke of Orleans became sole regent. He was popular, and his first measures increased his popularity; but the financial affairs of the kingdom were perplexing, and the regent's adoption of the schemes of Law (q. v.) led to disastrous results. Meanwhile, on the 26th August 1718, he held the celebrated *Lit de justice*, in which he prohibited the parliament of Paris from meddling with financial or political affairs, and declared the legitimised sons of Louis XIV. incapable of succeeding to the throne. Dubois, who still possessed an unhappy influence over his former pupil, became prime-minister, and eventually ruler of France; the regent, who was really a man of far higher abilities, neglecting all duties, and pursuing a course of profligacy almost unequalled in the worst instances of antiquity. His eldest daughter, the Duchess de Berry, followed his example, and brought herself to an early grave. Dubois, wishing to be made a cardinal, persuaded the regent to sacrifice the Jansenists, and to compel the parliament in 1722 to recognise the bull *Unigenitus* (q. v.). After the king's coronation, 15th February 1723, and the death of Dubois in August, the Duke of Orleans, although disliking public affairs, consented to become prime-minister; but died on the 2d December of the same year, physically exhausted by his incessant debauchery. The influence of his religious and other opinions, and the example of his immoralities, powerfully tended to promote that state of things which eventually produced the horrors of the French Revolution.

**ORLEANS, LOUIS PHILIPPE JOSEPH, DUC D'**, born April 13, 1747, was the great-grandson of the preceding. He possessed very good abilities; but early fell into the grossest debaucheries, in which he continued to the end of his career. Louis XVI. disliked him on account of his debased character, and the queen for his obtrusiveness. He became gradually estranged from the court, sought popularity and obtained it, and embraced the cause of American independence. In the Assembly of Notables in 1787 he declared against the ministerial proposals; and when the king sought to overcome the resistance of the parliament by a *Lit de justice*, he protested against the proceeding. On the assembly of the States-General, he took the popular side, and voted with the extreme left in the National Assembly; seeking at the same time to please the populace by profuse expenditure, with the hope of being made Lieutenant-general of the Kingdom, or perhaps of opening for himself a way to the throne. When the insurrectionary movements began in Paris in 1789, he promoted them by secret agents and money. The court sent him on an ostensibly diplomatic mission to England, from which he returned after more than six months' absence, in July 1790, and unscrupulously engaged in new intrigues hostile to the king. But he began to find that he himself was made the mere tool of a party, who availed themselves of his influence and wealth for their own purposes, and this discovery cooled his revolutionary fervour. He withdrew from the Jacobin Club, was reconciled to the king, and appeared at court; but was treated with such disrespect by the courtiers, that he turned away, and from that time followed in blind rage the stream of the revolution. He joined Danton's party, was concerned in insurrections, disclaimed all pretensions

to the throne, renounced his titles, assumed the name of Philippe Egalité, was addressed as Citizen Egalité, and was returned by the department of Seine and Marne to the National Convention, in which he took his place among the Mountain party. He voted for the death of the king, being, it is said, himself threatened with death by the Jacobins if he should do otherwise, but alleging his sense of duty and his belief that every one who did anything contrary to the sovereignty of the people deserved death. The vote was received with a cry of disgust, and by no means increased the safety of his own position. The Mountain party were dissatisfied with him, because he did not give up the whole of his immense wealth for party purposes. After the desertion of his son, the Duke de Chartres (see LOUIS PHILIPPE), the decree for the imprisonment of all the Bourbons was applied to him. He was thrown into prison with his family in Marseille, and was brought before the tribunal of the department of Bouches de Rhône on a charge of high treason. He was acquitted, but the Committee of Public Safety immediately brought him before the Revolutionary Tribunal in Paris; and on the 6th of November 1793 he was condemned, and on the same day executed amidst the execrations of the multitude which had so often applauded him.

**ORLEANS CLOTH**, a kind of stuff made for ladies' dresses, in which the warp is of cotton and the weft of worsted. It is so called from having been first made at Orleans in France, but it is now extensively manufactured at Bradford in Yorkshire.

**ORLOFF**, or **ORLOV**, a Russian family that first rose to eminence during the reign of Paul III., when one of its members, Count Gregori O., attracted the notice of the Grand Duchess Catherine, afterwards the Empress Catherine II., and succeeded Poniatowski as her favourite. It was Gregori who planned the murder of Peter III., and his brother Alexis who committed the deed, and both received high honours and rich rewards for this and other services. The flourishing family of the Counts Bobrinski resulted from Gregori's intercourse with the empress. The legitimate line of O. soon became extinct; but Feodor, a brother of Gregori and Alexei, left four illegitimate sons, one of whom, Mikail, distinguished himself in the campaign of 1814; and another is Count Alexei O., the celebrated diplomatist. Count Alexei was born in 1787, signalled himself by courage and military talents during the French wars, negotiated the treaties of Adrianople (1829) and Unkiar-Skelessi (1833), and represented Russia at the London conference of 1832 on the affairs of Belgium and Holland. In 1844, he was placed at the head of the secret police; and the ability and energy with which he directed its vast machinery, rendered him the most dreaded official in Russia. He was high in the favour of the Emperor Nicholas, who employed him in the negotiations with Austria previous to the Crimean war. In 1856, he sat in the congress of Paris as the representative of Russia, and on his return was made president of the grand council of the empire. He died at St Petersburg, 20th May 1861.

**ORLOP** (Dutch, *overloop*, that which runs over, or covers), in ships of war, is the lowest deck, immediately above the hold. It contains the magazine, bread-room, and various store-rooms; and is used in time of action for the reception and treatment of the wounded, as, from being below the water-line, it is the safest part of the ship.

**ORME'S HEAD, GREAT**, a headland in the north-east of Caernarvonshire, North Wales, five miles north-north-west of Conway, is an enormous mass of limestone rock, surmounted by a

light-house, and forming the extreme point of the western shore of Orme's Bay. Lat. 53° 20' N., long. 3° 51' W.—Little Orme's Head forms the eastern extremity of the same bay.

**ORMOLU** is a variety of brass, consisting of zinc 25 parts, and copper 75 parts, which has a nearer resemblance in colour to gold than ordinary Brass (q. v.). It is extensively used for castings of ornaments for furniture, candelabras, and such articles. When the casting is made, its colour is brought out by a *pickle* of dilute sulphuric acid, after which the acid is removed by water, and a liquor varnish is put on to keep it from tarnishing.

**ORMOND, JAMES BUTLER, DUKE OF**, was the first of the ancient Anglo-Irish family of Butler on whom the ducal title was conferred. The family was of illustrious antiquity. Genealogical legend carried it back to the dukes of Normandy before the Conquest, and it is certain that at the dawn of the 13th c., it held the hereditary office of royal cup-bearer or *butler*, whence the family name.—The subject of the present article was born in London in 1610. His father, the son of the celebrated Walter, Earl of Ormond, was drowned in crossing the Channel; and the old earl having incurred the displeasure of the king, James I., and being thrown into prison, James, who on his father's death became, as Viscount Thurles, the heir of the title, was seized as a royal ward, and placed under the guardianship of the Archbishop of Canterbury. On the restoration of his grandfather to liberty, he also was released; and in his twentieth year he married his cousin, Lady Elizabeth Preston, and in 1632 succeeded, upon his grandfather's death, to the earldom and estates of Ormond. During the Strafford administration in Ireland, O. distinguished himself so much, that on Strafford's recall he recommended O. to the king; and in the rebellion of 1640, O. was appointed to the chief command of the army. During the troubled times which followed, he conducted himself with undoubted ability, although, as a necessary consequence of the numberless divisions and subdivisions of party which then prevailed in Ireland, he failed to satisfy any one of the conflicting sections; and when, in 1643, he concluded an armistice, his policy was loudly condemned as well by the friends as by the enemies of the royalist party in England. During the long contest of Charles with the parliament, O. continued to uphold the royal interest in his Irish government; and when the last crisis of the king's fortunes came, he resigned his Irish command, and retired to France, from which country he again returned to Ireland with the all but desperate design of restoring the royal authority, and after a gallant but unequal struggle, was compelled, in 1650, to return once more to France. His services to the royal cause continued unremitting during his exile; and at the restoration he accompanied Charles II. on his return, and was rewarded for his fidelity by the ducal title of Ormond. His after-life was less eventful, although he twice again returned to the government of Ireland. It was in 1679 that the well-known attempt was made by the notorious Colonel Blood (q. v.) upon the life of Ormond. As he was returning from a civic festival, he was attacked by Blood and a party of ruffians, and was dragged from his coach with the intention of his being hanged at Tyburn. The attempt drew additional interest from its being commonly supposed to have been instigated by the profligate Duke of Buckingham, O.'s inveterate foe. He escaped uninjured, and lived until the year 1688. His letters and other papers are full of deep historical interest. See *Carte's Life of Ormond*.

**ORMSKIRK**, a market town of England, in Lancashire, in the centre of a rich and populous agricultural district, 12 miles north of Liverpool by the Lancashire and Yorkshire railway. The parish church has both a tower and spire. Its grammar-school has an annual income from endowment of £150. Silk-weaving, rope-making, basket-making, and brewing are the principal branches of industry. There are large collieries in the vicinity. Pop. (1861) 6423.

**ORMUZ**, or **HORMUZ**, a small island in the strait of the same name, at the entrance of the Persian Gulf, and within ten miles of the Persian coast. It is about twelve miles in circumference, and belongs to the Imaum of Muscat, who derives an income from the salt exported from the island. In the 16th c. it was taken by the Portuguese, and being made by them an entrepôt for goods from India, Persia, and Turkistan, it became important, and the town of the same name rose in population until it had 40,000 inhabitants. The town was demolished, in 1622, by Shah Abbās, assisted by the English, and its trade was removed to Gombroon (q. v.).

**ORMUZD** (Ahuramazd, Auramazda, Hormazd, Ormazd), corrupted from Ahurō-Mazdā, i. e., that Ahura (Vedic Asura) or 'Spiritual Being,' who is called Mazdā (i. e. Vedic Medhās) = 'Creator of all things;' the name of the supreme deity of the ancient Persians, and of their descendants the Guebres and Parsees. It was at first emphatically employed in this sense by Zoroaster, or Zarathustra Spitama. O. is, according to Zoroaster's original doctrine, the creator of the earthly and spiritual life, the lord of the whole universe, in whose hands are all creatures. He is the light and the source of light, the wisdom and the intellect, and is in the possession of all good things, such as 'the good mind,' 'immortality,' 'wholesomeness,' 'the best truth,' 'abundance,' &c.; which gifts he bestows upon the pure in thoughts, deeds, and words, while the wicked are punished by him according to their wickedness. ('For thou art through purity, the holy over the wicked, the ruler over all, the heavenly, the friend of both worlds, Mazda! . . . Father of the pure creatures at the beginning, who hath created the way of the sun, of the stars, who causeth the moon to wax and to wane. . . . He holdeth the earth and the unsupported [heavenly bodies?], the waters and the trees, and giveth swiftness to the wind and the clouds. . . . The creator of the good mind, the working good, hath made light as well as darkness, sleep and waking, the morning dawns, the noons, the nights,' &c.—*Yazna*, 43.) Sprung from Zervan-Akarana (the boundless time), i. e., being from eternity, self-existing, neither born nor created, he unites within himself—as does man and everything else existing—the two primeval principles of good and evil, the Çento-mainyus—i. e., the white, holy spirit; and the Angrō-mainyus (corrupted into Ahriman) = the dark spirit. This Zoroastrian conception of the two sides of the divine being—itsself one and indivisible—has, however, in the course of time, partly through misunderstandings and wilfully false interpretations, undergone important changes. While the Zervan-Akarana was transformed by the Magi—in opposition to the Zendiks—into the Supreme Being itself, the philosophical notion of a duality in O. became the theological dogma of god and devil, jealous of each other's power, bent upon the destruction of each other's works, and consequently in constant war with each other, they and their armies. Both are—according to this corrupted view of later times, by means of which the genuine one has been forgotten up to our day—supreme rulers; both have their fixed number of councillors (sprung from

an egg, *Plut. Isis and Osiris*), who are the actual governors of the whole universe, each in his special province; which counsellors, however, are neither more nor less than certain abstract ideas of Zoroaster. One personal archangel alone is assumed by the latter, viz., Sraocaha (Sesrah, cf. Sanscr. Shruti), i. e., hearing, tradition. He is vested with very high powers, and stands between O. and man; he is the teacher of good religion; he shews the way to heaven, and pronounces judgment over human actions after death. He is the personification of the whole divine worship and its outward manifestations, the symbols, prayers, sacrifices, rites, &c., and the chief combatant of the influence of the Devas; who stand symbolically for the Brahmanic religion. O. is represented as sitting upon a throne of light, as a venerable man, or seated upon a bull, &c.—For further particulars about the seasons and the manner of his worship, as well as the general relations between his and the Brahmanic religion (both the result of a prehistoric conflict between the Iranians and those Arian brother-tribes who immigrated into Hindustan Proper), we must refer to PARSSES, PERSIA, and ZOROASTER.

**ORNAMENTATION, or DECORATION**, in Architecture, applies to something which is added to the simple constructive features, or to the form given to those features, for the purpose of making them beautiful or elegant. Thus, the Doric shaft, while answering the constructive purposes of a simple square or round pier, is ornamented with fluting; and its capital, with its beautifully proportioned echinus and abacus, supports as a plain slab would do the weight of the entablature. The other classic orders illustrate this in a richer manner. Thus, the Corinthian column, with its fluted and elegant shaft, resting on an ornamented base, and crowned by an ornamented capital, takes the place of what might have been, had utility alone been consulted, a plain pier of rubble-work, with a rough stone to rest upon, and another on the top to receive the load.

In classic architecture, as in every good style, the same principle pervades all the ornamental features—viz., that they are constructive features ornamented in a manner suitable to their use; for instance, a column being a member for support, should be of such a form as to denote this—the constructive use of a cornice being to protect the top of the wall, and to shield the front of it from the rain and sun, it should be made of such a form as to do this, and also to look as if it did it—to express its purpose. In classic architecture, the cornice consists of several members, in which the constructive decoration is well seen; the mutules and modillions beautifully indicating in an ornamental manner their original use, while the leaf enrichments of the small mouldings give life and animation to the building. In medieval art the same principle prevails in a much greater degree, and over a more complex system of construction. The shafts, with their elegant and purpose-like bases and caps, are arranged so that each supports a separate member of the vaulting. The arch mouldings are divided so as to indicate the rings of their constructive formation. The buttresses, so elegant in outline, express the part they serve in supporting the vaulting; the pinnacles, with their ornamental finials, are the decorated dead-weights which steady the buttresses. The foliage and smaller ornament is also beautifully and suitably applied, as the growth and vigour of the supporting capitals and corbels, and the running foliage of the string-courses, arch-mouldings, &c., fully illustrate.

There are, no doubt, many styles of art to which these remarks can hardly be said to apply; as, for

example, the Assyrian, Egyptian, and Hindu styles, where we find many features applied in a manner meant to be ornamental, although actually contrary to their constructive use. In these styles (and also in Greek architecture), human figures, bulls, and other animals are placed as columns to carry the weight of a superincumbent mass. This is evidently wrong in principle, except when the figure is placed in an attitude to indicate that he is supporting a weight, as the Greek Atlantes do; but in the former cases religious notions seem to have overcome true artistic feeling. There are also many forms of ornament used in all styles, the origin of which is obscure, and their advantage doubtful; such are the zigzag, chevron, billet, &c., so common in early medieval art, and the scrolls of Ionic and Indian art, and the complications of the interlacing work of the North in the middle ages. Such things may be admissible in coloured decoration, such as the confused patterns of Saracenic art, and the shell-patterns of Indian art; but where ornamental form is wanted, unless the requirements of the construction are carefully followed as the guide to the decoration, all principle is lost, and the ornament runs wild. This has frequently occurred in the history of art, and in no case more markedly than in the art of the Renaissance.

The material in use must also have an influence on the form and style of the ornament. Thus, stone-carving and metal-work must evidently require different treatment. Fac-simile leaves might be formed in iron, but could not be so carved in stone. This constructive element should be carefully attended to in designing. All imitative art must be to some extent conventional. Natural objects, such as leaves, flowers, &c., cannot be copied absolutely literally; and in suiting the conventional treatment to the nature of the material used, lies the great skill of the artist.

**ORNE**, a department of France formed out of the old provinces of Normandy and Perche, is separated on the north from the English Channel (La Manche) by the department of Calvados. Area, 1,506,727 acres, more than one-half of which is cultivable land; pop. (1862) 423,350. A range of wooded hills, nowhere rising above 1370 feet, extends across the south of the department from east to west. North of this range the surface slopes toward the English Channel; south of it, toward the Atlantic. The principal rivers are the Orne (which gives name to the department), the Rille, the Sarthe, and Huisme. The climate is damp, though in general temperate, and the winters are severe. The soil is fertile, but agriculture is not in an advanced state. The inhabitants consume one-third more grain produce than is grown on the land. There are several millions of apple and pear trees planted along the roads, &c., and cider is extensively made. Cattle, and horses of the purest Norman breed, are reared. Mining is an important branch of industry; the chief products are iron and copper; marble, granite, and other stones for building are quarried. The department is divided into four arrondissements, Alençon, Argentau, Domfront, and Mortagne; capital, Alençon.

**ORNITHOLOGY** (Gr. *ornis*, a bird, and *logos*, a discourse), that branch of zoology of which the subject is birds. By Aristotle, Pliny, and others of the ancients, this study was prosecuted to some extent, along with other parts of natural history; but it is only in modern times that ornithology has assumed the rank of a distinct branch of science. The first modern author to attempt a scientific classification of birds seems to have been Pierre Belon, noted also as an ichthyologist, whose *Historia*

ORNITHORHYNCHUS—OROBUS.

*Avium* was published about the middle of the 16th century. Some of his classes are very heterogeneous assemblages; but the first three, viz., Birds of Prey, Web-footed Birds, and *Grallæ*, are so natural as to have been acknowledged, with some modification of their limits, in all subsequent systems. In the 17th c. much progress was made in the observation and description of species, not only of the birds of Europe, but of other parts of the world. In the latter part of the century, attention began to be given to the anatomy of birds. An ornithological system, more perfect than that of Belon, was proposed by Willughby about 1676, and afterwards matured and improved by Ray. On this system that of Linné was founded. During the 18th c., the progress of ornithology was very rapid. The birds of many countries were described in works specially devoted to them, and the habits of birds began to be carefully observed; but the system of Linné, as framed by him before the middle of the century, continued to prevail almost unmodified till the publication of Cuvier's *Régne Animal* in 1817. Latham, Lacépède, Illiger, Temminck, and others, had indeed previously proposed systems more or less different from it; and systems have since been proposed by others, particularly by Mr Vigors and Mr Swainson, who have endeavoured to accommodate the classification to certain first principles which they supposed to pervade nature, but which other naturalists in general regard as fanciful. The system of Cuvier is now generally received by ornithologists, as that of Linné formerly was; not, however, without modifications, by which it has been sought to accommodate it to the progress of science, and some of the names introduced by other authors have obtained very general acceptance. The system of Linné divided birds into six orders—*Accipitres*, *Picæ*, *Anseres*, *Grallæ*, *Gallinæ*, and *Passeres*. That of Cuvier also divided them into six orders—*Birds of Prey* (the *Accipitres* of Linné, now often called *Raptores*), *Passerine Birds* (*Passerina*, now more generally called *Inesores*, or *Perching Birds*, including most of the Linnean *Passeres*, and part of *Picæ*), *Climbers* (*Scansores*, part of the Linnean *Picæ*, and often designated *Zygodactyli* or *Zygodactylous Birds*), *Gallinaceous Birds* (now often called *Rasores*, the Linnean *Gallinæ*, but including also the pigeons or *Columbidæ*, which Linné placed among *Passeres*), *Stilt-birds*, often called *Waders* (*Grallatores*, the Linnean *Grallæ*), and *Web-footed Birds* (*Palmipedes*, now also known as *Natatores* or *Swimmers*). These orders are noticed in separate articles. Perhaps the most important modification of Cuvier's system which has been proposed, is the separation of the *Brevipennes* or *Siruthious Birds* from *Grallæ*, and their formation into a distinct order, sometimes called *Cursores* or *Runners*; and next to this may be mentioned the proposed separation of *Columbidæ* from Gallinaceous Birds.—The progress of ornithology since the commencement of the 19th c. has been very rapid; every department of it has been assiduously cultivated, and many of the works published have been not only of great merit, but very sumptuous and beautiful. The works of Audubon and Gould perhaps merit particular notice.

ORNITHORHYNCHUS. See DUCK-BILL.

OROBAN'CHEÆ, or OROBANCHA'CEÆ, a natural order of exogenous plants, all herbaceous, and destitute of true leaves, but having their stems covered with brown or colourless scales. They all grow parasitically upon the roots of other plants. The calyx is divided, persistent, inferior; the corolla monopetalous, hypogynous, and irregular. The stamens are four, two long and two short; the ovary 1-celled, seated in a fleshy disc, composed of

two carpels, with one style. The fruit is capsular, enclosed within the withered corolla, 1-celled, 2-valved. The seeds are numerous, and very minute,



Broom-rape (*Orobanche rubra*):

a, the top of the stem, with bracts and flowers; b, the base of the stem, with scales; c, the corolla, cut open, shewing stamens; d, the middle segment of the lower lip of the corolla, magnified, shewing the beautiful fringe of gland-bearing hairs; e, capsule.

There are about 120 known species, natives chiefly of temperate climates, and generally characterised by astringency and bitterness, upon account of which some of them have been used in medicine (see CANCER ROOT). Eleven species are natives of Britain, chiefly belonging to the genus *Orobanche*, or BROOM-RAPE; to some of which important medicinal virtues were once erroneously ascribed. The enlarged base or rootstock of a species of *Orobanche* is cooked or dried, and eaten by the Indians of the north-western parts of America.

O'ROBUS, a genus of plants of the natural



Bitter Vetch (*Orobuchus tuberosus*):

a, standard of the corolla.

order *Leguminosæ*, suborder *Papilionaceæ*, allied to Vetches, and sometimes called BITTER VETCH; the

style linear, downy beneath the stigma; the calyx obtuse at the base and oblique at the mouth; its upper segments deeper and shorter; the pod 1-celled, 2-valved; the leaves pinnate, without tendrils. The species are perennial herbaceous plants, chiefly natives of Europe. They afford good food for cattle. Two are natives of Britain, of which the most common is *O. tuberosus*, whose racemes of purple flowers often adorn heaths and bushy places, especially in hilly districts. The stem is unbranched, erect, about a foot high, with narrow membranous wings; the leaflets in 2-4 pairs; the pods long, cylindrical, black; the root creeping and swelling out into tubers at irregular intervals. The tubers have a sweet taste, resembling that of liquorice, and are sought after by children; they are also bruised and steeped in water in some parts of the Highlands of Scotland to make a fermented liquor, and a kind of liquor is made by steeping them in whisky; they are well-flavoured and nutritious when boiled or roasted, and are used in this way in the Highlands of Scotland, in Holland, Belgium, and other countries.

ORONTÉS, the ancient name of a river in Syria, now called *Nahr-el-Asi*. It rises in the highest part of Coele-Syria, near Baalbek, flows northward between the mountains of Libanus and Anti-Libanus, as far as the city of Antioch, and then westward to the Mediterranean Sea, after a course of 240 miles, passing by a cross valley, through the mountains of the Syrian coast. Its lower course is remarkably beautiful, surpassing everything else that can be seen in Syria. Its rocky banks are 300 feet high, and the windings of the river shew them off to the greatest advantage. Myrtle-bushes, laurels, figs, wild vines, arbutus, dwarf-oaks, and sycamores (*Acer pseudo-platanus*) are scattered about in picturesque confusion. Here and there the eye catches a glimpse of some cavern mouth or ivy-matted precipice, while from the abyss beneath ascends for ever the roar of the impatient stream. The country through which it flows is of great fertility, and in many parts is richly cultivated.

OROSIUS, PAULUS, a Spanish presbyter and historian, was born at Tarragona, and flourished in the early part of the 5th century. He went to Africa about 413 A. D., where he made the acquaintance of St Augustine, and thence to Palestine, to study under St Jerome, then living at Bethlehem. He finally settled in Africa, but the date of his death is unknown. His chief work, the *Historiarum adversus Paganos Libri 7*, begins with the creation and goes down to 417 A. D. It is apologetic in design, being intended to refute the notion then current among the pagans, that the misfortunes of the Roman Empire and the wretchedness of the great masses were owing to the anger of the gods at the abandonment of their worship, and the profanation of their altars. The work is a trivial, inaccurate, uncritical miscellany of facts, culled from such second-rate authorities as Justin and Eutropius; the style is elegant, but also, as Bacon says, 'watery.' Yet it has obtained a place in literature from being a favourite text-book of universal history during the middle ages, and had the honour of being translated into Anglo-Saxon by our own Alfred. Some manuscripts bear the puzzling title of *Hormesta* or *Ormistia*, conjectured by some to be a corruption of Or. M. ist.; that is, *Orosii Mundi Historia* (Orosius's History of the World). The editio princeps of the work appeared at Vienna in 1471; the best edition is that of Haver-camp (Lag. Bat. 4to, 1738). Other writings of O.'s are *Liber Apologeticus de Arbitrii Libertate*, an anti-Pelagian treatise, *Commonitorium ad Augustinum*,

an explanation of the state of religious parties in Spain in his time. See Möner's *De Orosii Vita etque Historiarum Libri Septem adversus Paganos* (Berl. 1844).

OROTAVA, a town on the north coast of Teneriffe, one of the Canary Islands, is situated below the Peak, in one of the most fertile, pleasant, and healthy districts in the world. It contains several beautiful churches, the residence of the governor and the citadel. Fishing is carried on to some extent, and there is a trade in wine. Pop. 8628.

ORPHEUS (supposed to be the Vedic Ribhu or Arbhu, an epithet both of Indra and the Sun), a semi-mythic name of frequent occurrence in ancient Greek lore. The early legends call him a son of Apollo and the muse Calliope, or of Oleagrus and Clio, or Polymnia. His native country is Thracia, where many different localities were pointed out as his birthplace—such as the Mounts of Olympus, and Pangæus, the river Enipeus, the promontory of Serrhium, and several cities. Apollo bestows upon him the lyre, which Hermes invented, and by its aid O. moves men and beasts, the birds in the air, the fishes in the deep, the trees, and the rocks. He accompanies the Argonauts in their expedition, and the power of his music wards off all mishaps and disasters, rocking monsters to sleep and stopping cliffs in their downward rush. His wife, Eurydice (? = Sanscr. Uru, Dawn), is bitten by a serpent (? = Night), and dies. O. follows her into the infernal regions; and so powerful are his 'golden tones,' that even stern Pluto and Proserpina are moved to pity; while Tantalus forgets his thirst, Ixion's wheel ceases to revolve, and the Danaïdes stop in their wearisome task. He is allowed to take her back into the 'light of heaven,' but he must not look around while they ascend. Love or doubt, however, draw his eyes towards her, and she is lost to him for ever (? = first rays of the sun gleaming at the dawn make it disappear or melt into day). His death is sudden and violent. According to some accounts, it is the thunderbolt of Zeus that cuts him off, because he reveals the divine mysteries; according to others, it is Dionysius, who, angry at his refusing to worship him, causes the Menades to tear him to pieces, which pieces are collected and buried by the Muses in tearful piety at Leibethra, at the foot of Olympus, where a nightingale sings over his grave. Others, again, make the Thracian women divide his limbs between them, either from excessive madness of unrequited love, or from anger at his drawing their husbands away from them. Thus far legend and art, in manifold hues and varieties and shapes, treat of O. the fabulous. The faint glimmer of historical truth hidden beneath these myths becomes clearer in those records which speak of O. as a divine bard or priest in the service of Zagreus, the Thracian Dionysius, and founder of the Mysteries (q. v.); as the first musician, the first inaugurator of the rites of expiation and of the Mantic art, the inventor of letters and the heroic metre; of everything, in fact, that was supposed to have contributed to the civilisation and initiation into a more humane worship of the deity among the primitive inhabitants of Thracia and all Greece: a task to which O. was supposed to have devoted his life after his return with the Argonauts. A kind of monastic order sprang up in later times, calling itself after him, which combined with a sort of enthusiastic creed about the migration of souls and other mystic doctrines a semi-ascetic life. Abstinence from meat (not from wine), frequent purifications and other expiatory rites, incantations, the



wearing of white garments and similar things—not unlike some of the Esenic manners and customs—were among their fundamental rules and ceremonies. But after a brief duration, the brotherhood, having first, during the last days of the Roman empire, passed through the stage of conscious and very profitable jugglery, sank into oblivion, together with their 'orphanistic' formulas and sacrifices, and together with the joys of the upper, and the never-ending punishments of the infernal regions which they held out to their rich dupes: according to the sums they grudged or bestowed upon them.

O. has also given the name to a special literature called the Orphic, the real origin of which, however, is (according to Ottfried Müller), like Orpheus's own history, 'unquestionably the darkest point in the entire history of early Greek poetry.' Like Olen, Linus, Philammon, Eumolpus, Musæus, and other legendary singers of prehistoric Greece, O. is supposed to have been 'the pupil of Apollo and the Muses,' and to have first composed certain hymns and songs used in the worship of a Dionysius, dwelling in the infernal regions, and in the initiations into the Eleusinian mysteries. A mere 'abstraction,' as it were, he was called the first poet of the heroic age, and though not mentioned before Ibycus, Pindar, Hellenicus, and the Athenian tragedians, he was yet placed anterior to both Homer and Hesiod. The fragments current under his name were first collected at the time of the Pisistratids, chiefly by Onomacritus, and these fragments grew under the hands of the Orphic brotherhood, aided by the Pythagoreans, to a vast literature of sacred mythological songs sung at the public games, chanted by the priests at their service, worked out for dramatic and pantomimic purposes by the dramatists, commented upon, philosophised upon, and 'improved' by grammarians, philosophers, and theologians. Although authorities like Herodotus and Aristotle had already combated the supposed antiquity of the so-called Orphic myths and songs of their day, yet the entire enormous Orphic literature which had grown out of them retained its 'ancient' authority, not only with both the Hellenists and the church fathers of the 3d and 4th centuries A. D. (who, for their individual, albeit opposite purposes, referred to it as the most authentic primitive source of Greek religion, from which Pythagoras, Heraclitus, Plato had drawn their theological philosophy), but down almost to the last generation, when it was irrefutably proved to be in its main bulk, as far as it has survived, the production of those very third and fourth centuries A. D., raised upon a few scanty, primitive snatches. The most remarkable part of the Orphic literature is its Theogony, which is based mainly on that of Hesiod, with allegorising and symbolising tendencies, and with a desire to simplify the huge Olympio population by compressing several deities into a single one. See THEOGONY. Yet there is one figure which stands out here prominently—viz., Zagreus, the horned child of Zeus by his own daughter Persephone, who, killed by the Titans at the bidding of Here, is reborn by Semele as Dionysius.

Besides the fragments of the Theogony which have survived, imbedded chiefly in the writings of the Neoplatonists, are to be mentioned the *Argonautica*, a poem of the Byzantine period, consisting of 1384 hexameters; further, a collection of 87 or 88 liturgical hymns; a work on the virtues of stones, called *Lytica*, &c. Other poems belonging to the Orphic Cycle, of which, however, only names have survived in most instances, are *Sacred Legends*, ascribed to Cerops; a Poem on Nature, called *Physica*, probably by Brontinus; *Bacchica*, supposed to be written by Avignote, the daughter

of Pythagoras; *Minyas*, or Orpheus's descent into the Hades; and other poetical productions by Zopyrus, Timocles, Nicias, Persinus, Prodicus, &c. The best edition of the Orphic fragments is that of G. Herrmann (Leipzig, 1805). The hymns have repeatedly been translated into English by T. Taylor and others. The chief authority on the Orphic literature still remains Lobeck's *Aglaophamus*.

**O'RPIMENT.** See ARSENIC.

**O'RRERY,** a machine constructed for the purpose of exhibiting the motions of the planets round the sun, and of the satellites round their primaries, which was in high repute during the 18th and beginning of the 19th centuries, though now regarded as a mere toy. It was a combination of the old *Planetarium* (q. v.), with other machines which shewed the motions of the earth, moon, and planetary satellites. Though the construction of a machine which would exhibit accurately the motions, distances, and magnitudes of the planets is impossible, yet an orrery is in some degree useful as giving a general notion of the way in which the planetary motions are performed. As it was a favourite machine at one time, a description of it may not be uninteresting. A number of iron tubes equal in number to the planets, and of different dimensions, are placed one within the other; their lengths being arranged so that the innermost tube projects at both ends beyond the one next to it, that one similarly projects beyond the third, and so on. At one end of each tube a rod is fixed at right angles, and a ball or lamp attached to its end; the lengths of the rods being proportional (or at least supposed to be so) to the radii of the planetary orbits. The other ends of the tubes form the axes of toothed wheels, which are connected either directly, or by means of combinations of toothed wheels, with a winch. The several combinations of wheels are so adjusted that the velocity of revolution of the rods is proportional to the times of revolution of the planets. On turning the winch the whole apparatus is set in motion, and the balls or lamps (representing the planets) revolve round the centre, which is a fixed lamp (representing the sun), at different distances, and with varying velocities. There are many nice arrangements, such as for producing elliptic motion, but these need not be described.

**O'RRIS ROOT** (probably a corruption of *Iris* Root), the rootstock (*rhizome*) of certain species of *Iris* (q. v.), natives of the south of Europe, belonging to the division of the genus having bearded flowers, sword-shaped leaves, and scapes taller than the leaves; viz. *I. Florentina*, a species with white flowers; *I. pallida*, which has pale flowers; and *I. Germanica*, which has deep purple flowers. The flowers of all these species are fragrant. *I. Germanica* extends further north than the other species, and its root is sometimes said to be more acrid. O. R. was formerly used in many medicinal preparations as a stimulant, but is now almost entirely disused. It is sometimes chewed to sweeten an offensive breath. Its chief use is in perfumery. It has a pleasant smell of violets, which it acquires in drying. Hair and tooth powders, and oils, are often scented with it. A tincture of it is also used as a scent, and is often sold as *Essence of Violets*.

**ORSINI, FELICE**, an Italian revolutionist, who is destined to be remembered for his atrocious attempt on the life of the French emperor, Napoleon III., was born at Meldola, in the States of the Church, in 1819. The son of a conspirator, O. at an early age was initiated into secret societies, and before he had reached his twentieth year, he

was thrown into prison, and condemned to the galleys for life. The amnesty of Pius IX. (1846) restored him to liberty, but he was soon after again imprisoned for participation in political plots. When the revolution of 1848 broke out, O. was elected as a deputy to the Roman Constituent Assembly. He was invested with extraordinary powers, and sent to Ancona and Ascoli to suppress brigandage. He signalled himself by the violence with which he executed his commission. He also took part in the defence of Rome and Venice; agitated in Genoa and the Duchy of Modena; and in 1853 was shipped for England by the Sardinian government, where he formed close relations with Mazzini. Furnished with money by the leaders of the revolutionary party, he appeared at Parma in 1854, and afterwards at Milan, Trieste, Vienna, everywhere agitating in the interest of insurrection; until at last he was arrested and confined in the fortress of Mantua. In 1856 he succeeded in making his escape, and found refuge in England, where he supported himself by public lecturing, and wrote a book entitled *The Austrian Dungeons in Italy* (Lond. 1856). Towards the end of 1857 he repaired to Paris, with the intention of assassinating Louis Napoleon, whom he reckoned the great obstacle to the progress of revolution in Italy. His associates in this diabolical design were persons named Pieri, Rubio, and Gomez. Providing themselves with bombs, they took up their station in a house close by the opera, and on the evening of the 14th January 1858, just as the carriage containing the emperor and empress were drawing up, they threw three of the deadly missiles under the carriage. An explosion took place, and several people were wounded, one or two mortally, but their majesties remained unhurt. The assassins were arrested, tried, and sentenced; Orsini, Pieri, and Rubio to capital punishment, Gomez to hard labour for life. Rubio's life was spared at the intercession of the empress, but Pieri and Orsini were beheaded on the 13th of March.

#### ORSOVA, New. See DANUBE.

ORTHEZ, a small town of France in the department of Basses-Pyrénées, on the right bank of the Gave de Pau, 37 miles east of Bayonne. Pop. 4885. The Castle of Moncada, now reduced to a few ruined walls, overtopped by one stately tower, was built here in 1240 by Gaston de Foix. In the immediate vicinity of the town, the British, under Wellington, gained a grand and decisive victory over the French under Soult, February 27, 1814. In this engagement the French lost 3900 men and six guns on the field, and the spirit of Soult's army was thoroughly broken.

ORTHIS (Gr. *straight*), a large genus of fossil brachiopodous mollusca, found in the Palæozoic rocks, most abundantly in the Silurian rocks, but ranging upwards to the Permian series. The genus contains upwards of 100 species.

ORTHO'CERAS (Gr. *straight horn*), an extensive genus of cephalopodous mollusca, found in the palæozoic rocks, from the Lower Silurian to the Trias. It is nearly allied to the Nautilus, and is indeed, in its simplest forms, nothing more than an unrolled and straightened nautilus. The shell is straight, the siphuncle central, and the body chamber small. The members of the genus are the most widely distributed, and the most abundant of any of the palæozoic fossils. Nearly 200 species have been described, but a considerable number of these have been separated into sub-genera, characterised chiefly by the form and size of the siphuncle.

ORTHODOXY (Gr. *orthos*, right, and *doxa*, an opinion), a name given by theologians to religious

opinions in agreement with Scripture, or rather with the view of Scripture entertained either by the church in general, or by the Established Church of any particular nation. Its antithesis is HETERO-DOXY (Gr. *heteros*, another, meaning 'wrong,' and *doxa*, opinion).

ORTHOEPEY (Gr. *correctness or propriety of speech*), a branch of grammar that treats of the right pronunciation of the words of a language.

ORTHOGRAPHY (Gr. *correct writing*), a branch of grammar that treats of the elementary sounds of a language, the signs or letters by which they are represented in writing, and the combinations of these signs to represent words; it also includes the right dividing of words into syllables (as when a word has to be divided at the end of a line), and punctuation. In a more restricted sense, orthography is synonymous with the art of correct spelling. No part of grammar is less satisfactory than this. All alphabets were from the first both defective and redundant, and therefore inadequate to represent exactly the elementary sounds of the languages to which they were applied (see ALPHABET, LETTERS AND ARTICULATE SOUNDS). The first attempts then at writing any language must have exhibited great diversity of spelling. Wherever an extensive literature has sprung up among a people, and language been made a study of itself, there a greater or less uniformity of spelling has, by tacit convention or otherwise, become established for a time. Such was the case with Latin in the time of the Cæsars, with High German about the 12th and 13th centuries, and with English (Anglo-Saxon) in and for some time after the days of Alfred. But although language, as depicted to the eye, may be fixed for a time, the spoken tongue, being a living organism, cannot be thus petrified. A written literature may modify, and in some degree retard, but cannot altogether arrest that incessant change and evolution to which all spoken tongues are subject. The breaking up of the Anglo-Saxon in its transition into modern English, brought necessarily a period of orthographic chaos. Never was the lawlessness greater than during one of the brightest periods of the literature, namely, the Elizabethan period. Then, and for a long time after, all perception of the real powers of the letters seems to have been lost, and nothing but caprice ruled. Not only were words spelled differently by different persons, but even among the best educated classes the same person would spell the same word (even his or her own name) half-a-dozen ways in the same page. Among the classic writers of the Queen-Anne period, some degree of uniformity began to establish itself, and this was afterwards further confirmed and fixed by the publication of Johnson's Dictionary, since which time the alterations have been comparatively trifling. The modern spelling thus established, conformed itself only partially to the changes the spoken language had undergone. Of the letters that had become silent through the wearing away and collapse of the spoken words, some were omitted and others retained, with little attention to consistency, or to any principle now discernible. Hence, in the English language as now written and spoken, there is in general so imperfect a correspondence between the sound of a word, and the sounds of the several letters that are written to represent it, that the spelling of each individual word has, in a manner, to be learned by itself. By no possible rules can a learner be taught when he sees the groups of letters *n-o-w*, *p-l-o-u-g-h*, *e-n-o-u-g-h*, to make out the sounds or spoken words that these groups actually represent; or, conversely, when he hears

the words spoken, to find out what letters they are to be represented by. This circumstance presents great difficulty to foreigners in the acquisition of English; which, in other respects, is one of the simplest and most easily learned languages in the world. The orthography of English is only to be acquired by observation and practice. There are no *rules* in the proper sense of the word; the only effective assistance that can be given in this matter is to bring together, under some kind of classification, the words that are most frequently misspelled. See PHONETIC WRITING.

**ORTHOPTERA** (Gr. straight-winged), an order of mandibulate insects, in many respects resembling the *Coleoptera* (q. v.), but having the wing-covers softer and generally leathery and flexible. The wing-covers also often overlap on the back when at rest, or meet at an angle like the roof of a house. The wings are broader than the wing-covers, and fold in a fan-like manner. A few species are wingless. The body is generally elongated. The antennæ are almost always filiform and many-jointed. The eyes are usually very large, and there are also in most species two or three stemmatic eyes. The mouth much resembles that of the *Coleoptera*, but the maxillæ are terminated by a horny denticulated piece, and covered by a *galea*; and the interior of the mouth exhibits a distinct fleshy piece, which some regard as a kind of tongue. The *O.* undergo only a semi-complete metamorphosis, the larva and pupa much resembling the perfect insect, except in the want of wings; which, however, begin to be developed in the pupa. The Earwig family differs so much from the other *O.* as to have been constituted by some entomologists into a distinct order. See **EARWIG**. The *O.* are divided into two sections, *Cursoria* and *Saltatoria*; the first with legs adapted for running, as the Mantis family, Spectre Insects, Walking Sticks, Leaf Insects, &c.; the second having the hinder legs very large and strong, generally adapted for leaping, as Grasshoppers, Locusts, Crickets, &c.

**ORTOLAN** (*Emberiza hortulana*), a species of Bunting (q. v.), much resembling the Yellow Hammer, and not quite equal to it in size. The



Ortolan (*Emberiza hortulana*).

adult male has the back reddish brown, the wings dusky black and rufous brown; the tail dusky black, some of the outer tail-feathers with a patch of white on the broad inner web; the chin, throat, and upper part of the breast yellowish-green; the other under parts reddish buff-colour. The plumage of the female is of less vivid hues. The *O.* occurs in great flocks in the south of Europe and north of Africa. Even in the south of Europe it is a summer bird of passage, but its migrations extend as far north as Lapland, although in Britain it is a very rare bird, and only of accidental occurrence. It has no song, but merely a monotonous chirping note.

It frequents bushy places, but often makes its nest on the ground in cornfields, particularly where the soil is sandy. No bird is so highly esteemed by epicures, and vast numbers are used for the table. It is taken chiefly by nets, with the aid of decoy-birds, and after being taken is fattened on millet and oats, in rooms dimly lighted by lamps. Thus treated, it becomes excessively fat, sometimes so as to die of obesity; and attains a weight of three ounces. Great numbers of ortolans, potted and pickled, are exported from Cyprus.

**ORTONA**, a town of Naples on the Adriatic, in the province of Chieti (Abruzzo Citra), and 14 miles east of the town of that name. It gives title to a bishop, and contains a cathedral and other religious edifices. Its port has ceased to exist, and vessels are now obliged to anchor about a mile from the town in unsheltered roads, where, however, the water is deep and the bottom good. Wine is extensively grown, and has a local reputation as the best in this part of Italy. Pop. about 7000.

**ORTYX**. See **VIRGINIAN QUAIL**.

**ORVIETO**, a city of Central Italy, capital of the delegation of the same name, which was formerly included in the Papal States, but now forms part of the Kingdom of Italy, stands on the right bank of the Paglia, 8 miles north-east of Lake Bolsena, and 60 miles north-north-west of Rome. It occupies a strong position on a steep hill, is well built, and is surrounded with walls. It has been the seat of a bishop since 509 A. D. The cathedral, a beautiful specimen of the Italian Gothic, and one of the most richly-decorated edifices in Italy, is built of black and white marble, was begun in 1290, and completed about the middle of the 14th century. The façade is unsurpassed in richness of material, and in the beauty of its mosaics, sculptures, and elaborate ornamentation. The interior is also magnificently decorated with sculptures and paintings. The other chief buildings are St Patrick's Well, and several palaces. Pop. 6336, who trade in corn, cattle, and silk, and a delicate white wine, which is highly esteemed at Rome.

*O.*, called in the time of the Longobards *Urbs Vetus*—of which its present name is a corruption—has been the place of residence and retreat in turbulent times of upwards of 30 popes. The city is evidently of Etruscan origin, but of its early history nothing is known.

**ORYX**, the name given by the ancients to a species of antelope, a native of the north of Africa.



Oryx.

It is often represented on the monuments of Egypt and as these representations are almost always in profile, it is generally made to appear as having

only one horn, thus probably contributing to the fable of the unicorn; and, indeed, all the older figures of the unicorn exhibit a considerable resemblance to this kind of antelope. The name *Antilope oryx* was given by Pallas to the Gems-boc (q. v.), an antelope certainly much resembling the O., but found only in South Africa; and it is now generally believed that the true O. of the ancients is a species also known as the ALGAZEL (*Antilope Gazella*, or *Oryx bezoartica*), common in the north of Africa. It is about three feet six inches high, of a stout figure; with sheep-like muzzle; long ears; horns of the male from two to three feet long, slender, gradually attenuated, directed backwards and gently curved, annulated for about half their length; the female also having horns.

#### ORYZA. See RICE.

OSA'CA, an imperial city of Japan, in N. lat. 35° 5', about 30 miles from its seaport of Hiogo, is situated on a large river on the south-east coast of the island of Nipon, in the most central and populous part of the empire, and surrounded by the great tea districts. It is the great emporium of trade and luxury; bearing much about the same relation to Japan that Soo-chow once did to China. By the treaty of 1858, British subjects were to be allowed to reside in O. for the purpose of trade from January 1, 1863. The population of O. has been estimated at about 80,000.

OSA'GE, a river of Missouri, U.S., rises in the eastern part of Kansas, and flowing easterly in a very circuitous course about 400 miles, empties into the Missouri River near Jefferson City.

OSAGE ORANGE (*Machura aurantiaca*), a tree of the natural order *Moraceæ*, a native of North America. It attains a height varying, according to soil and situation, from twenty to sixty feet. It is of the same genus with Fustic (q. v.), and its wood, which is bright yellow, might probably be used for dyeing. The wood is fine-grained and very elastic, and is much used by the North American Indians for making bows. The O. O. has been successfully introduced into Britain as a hedge plant. Its fruit is about the size of a large orange, has a tuberculated surface of a golden colour, and is filled internally with radiating somewhat woody fibres, and with a yellow milky juice, the odour of which is generally disliked, so that the fruit, although not unwholesome, is seldom eaten.

O'SBORNE or ST HELEN'S BEDS are a series of strata of the Middle Eocene period, occurring in the Isle of Wight. They have been divided into two groups: 1. The St Helen's Sands, consisting of layers of white, green, and yellow sands, interstratified with blue, white, and yellowish clays and marls, with a maximum thickness of 50 feet; and, 2, the Nettlestone Grita, composed of yellow limestone and marl, and a shelly freestone, which is much used for building, having a maximum thickness of 20 feet. The fossils of the Osborne Beds are species of *Paludina* and *Cypris*, and the spirally sculptured spore-cases of *Chara*. The group is of fresh and brackish water origin, and is very variable in mineral character and thickness.

OSCAR L., JOSEPH-FRANÇOIS, king of Sweden and Norway, was born at Paris, July 4, 1799, and was the only issue of the marriage of Charles XIV. (q. v.), formerly Marshal Bernadotte, with Desirée Clary, the daughter of a Marseillais merchant, and sister of Madame Joseph Bonaparte. After the election of his father as crown-prince of Sweden, O. received the title of Duke of Sudermania, and was placed

under the tutelage of the poet Atterbom, for the purpose of acquiring the Swedish language. In 1818, he entered the university of Upsala, where his education was completed. The effects of the thorough training he received were seen in his remarkable proficiency in science, literature, and especially the fine arts. For some time he gave himself up almost entirely to the study of music, and composed various pieces, including an opera, and several waltzes, marches, &c.; he is also the author of several songs and hymns, some of which are still popular in Sweden. What is of more consequence, however, he became thoroughly imbued with the national sentiments, and after his admission to a share in the administration, vigorously opposed, though with becoming filial respect, the pro-Russian policy of his father. This course of conduct rendered him immensely popular, and on March 8, 1844, his accession to the throne was hailed with rapture by the great majority of his subjects. His rule was distinguished for its liberality and justice; and many liberal measures, such as those for the removal of Jewish disabilities, freedom of manufactures and commerce, and parliamentary reform (the last mentioned being vigorously opposed by the nobility), were laid before the *Riksdag* by his orders. He introduced these changes with caution and gentleness, and had the gratification of seeing, in most cases, his prudence crowned with success. His foreign policy was of an independent and anti-Russian character, and during the Crimean war he joined (November 21, 1855) the king of Denmark in a declaration of armed neutrality, which gradually assumed a more hostile attitude to Russia, and would have inevitably led to war, had not the Paris treaty so rapidly succeeded. His attitude at this time gained him general favour and respect throughout Europe. On July 19, 1823, he married Josephine Beauharnais, the granddaughter of the Empress Josephine, by whom he had five children, the eldest of whom, on account of his father's failing health, was appointed regent, September 25, 1857, and succeeded to the throne as Charles XV. on the death of O., July 8, 1859. While crown-prince, O. published two works, a *Memoir on the Education of the People*, and an *Essay on Punishments and Penal Establishments*.

OSCEOLA (Seminole, *As-se-ho-lar*), a chief of the tribe of Seminole Indians in Florida, U.S., was born about 1803. He was the son of an English trader, named Powell, and the daughter of a Seminole chief. In 1835 the wife of O., a chief's daughter, was claimed and seized as a slave by the owner of her mother. The outraged husband threatened revenge, and for his threats was imprisoned six days in irons by General Thompson. Lying in wait, a few days afterwards he killed the general and four others. This was the beginning of the second Seminole war. Laying an ambush soon after, he killed Major Dale and a small detachment of soldiers, and taking to the almost impenetrable Everglades, with two or three hundred followers, he fought for a year with great energy and skill the superior numbers sent against him. He was taken prisoner at last by General Jessup, while holding a conference under a flag of truce, an act of inexcusable treachery, though represented as one of retaliation, and confined in Fort Moultrie until his death in January 1838.

O'SCI, originally OPSCI (rendered by Mommsén, 'labourers,' from *opus*, a work), in Greek always OPIKOI, the name of an Italian people, who at an early period occupied Campania, and were either closely allied to, or the same race as the Ausones. Subsequently (about 423 B. C.)

Samnites from the hilly districts to the north overran the country, and amalgamated with the inhabitants whom they had subjugated. It is conjectured that the conquerors were few in numbers, as (like the Normans in English history) they adopted in time the language of the conquered, but whether they modified the original Oscan language, and if so, to what extent, cannot now be ascertained. As it was these Samnitic Oscans or Campanians who formed that Samnitic people with whom both the Greeks of Lower Italy and the Romans first came into contact, the names *Osci* and *Oscan language* were subsequently applied to all the other races and dialects whose origin was nearly or wholly the same. The Oscan language was not substantially different from the Latin, but only a ruder and more primitive form of the same central Italic tongue. The territory where it was spoken comprised the countries of the Samnites, Frentani, Northern Apulians, Hirpini, Campani, Lucani, Bruttii, and Mamertini, whose dialects only slightly differed from each other; besides the entire Samnitic races, whence the language is sometimes called Samnitic or Safinic. The races situated north of the Silarus were purely Samnitic; those south of it, and even of the region round the Gulf of Naples, were Græco-Samnitic. The use of the national Samnitic alphabet was confined to the former. By the victories of the Romans over the Samnites, and the conferring of the *civitas* on all the Italians (88 B.C.), an end was put to the official use of the Oscan tongue; nevertheless, in the time of Varro (1st c. B.C.) it was still used by the people, and as late as the destruction of Herculaneum and Pompeii was spoken by a few individuals. During its most flourishing period it was something more than a country *patois*; it is even possible that the Oscans had a literature and art of their own, which may not have been without influence on the early Calabrian poets, Ennius and Pacuvius, and the Campanian Lucilius. At any rate, we certainly know of a poetic creation peculiar to the Campanians, a kind of unwritten, regular, probably improvised farce, with fixed parts and changing situations, which was transplanted to Rome about 304 B.C., but was imitated there not in Oscan but in Latin. See ATELLANÆ. Besides a considerable number of coins with Oscan legends, there are still extant a number of inscriptions in the Oscan tongue, among which the most important for linguistic purposes are, 1st, the *Tabula Bantina*, a bronze tablet found in the neighbourhood of Bantia (on the borders of Lucania and Apulia), referring to the municipal affairs of that town; 2d, the *Cippus Abellanus*, or Stone of Abella (in Campania); and 3d, a bronze tablet found near Agnone, in Northern Samnium. See Mommsen's *Oskische Studien* (Berlin, 1845), and *Die Unteritalischen Dialekte* (Leip. 1850); also Friedländer's *Die Oskischen Münzen* (Leip. 1850), Kirchoff's *Das Stadtrecht von Bantia* (Berl. 1853), and Donaldson's *Varronianus* (pp. 104-138).

**OSCUATION AND OSCULATING CIRCLE** (Lat. *osculari*, to kiss). One curve is said to osculate another when several points are common to it with the other, and the degree of osculation is said to be high or low according as the number of points in contact are many or few. The number of possible points of contact is determined by the number of constants contained in the equation to the tangent curve (supposing the number of constants in the equation to the curve which is touched to be greater). The same is true of a straight line and a curve. The equation to a straight line being of the form  $ax + b$ , contains two constants,  $a$  and  $b$ , hence a straight line can coincide with a curve in two contiguous points, and the contact is said to

be of the *first* order. This straight line is the tangent at the point of contact. When a straight line, not a tangent, meets a curve, there is no 'contact' but 'section,' as in that case only one point is common to the straight line and the curve. The equation to a circle contains three constants, and therefore a circle can have three consecutive points in common with a curve, and the contact is then of the *second* order. This circle is known as the 'circle of curvature,' or the osculating circle (see Fig. of article CURVATURE), and has for its radius the radius of curvature of that portion of the curve with which the circle is in contact. No other circle can have so high a degree of contact with a curve at any point as the osculating circle at that point.

**O'SHKOSH**, a town in Wisconsin, U.S., on both sides of the Fox River, at its entrance to Lake Winnebago, 90 miles north-north-east of Madison. It has a large lumber trade, saw-mills, planing-mills, steam-boats, &c. Pop. (1860) 6086.

**OSIANDER, ANDREAS**, one of the most learned and zealous of the German reformers, was born in 1498, at Gunzenhausen, near Nürnberg. His father was a blacksmith, called Hosemann, out of which name his son, after the fashion of his time, manufactured the classic-looking Osiander. O. was educated at Ingolstadt and Wittenberg; and after completing his course of study, became a preacher at Nürnberg, where he was conspicuously active in introducing the Reformation (1522). He ardently advocated the views of Luther in his controversy with the Swiss reformer Zwingli, on the question of the Lord's Supper. He took part in the conference held at Marburg (1529), and was present at the diet of Augsburg (1530). In 1548 he was deprived of his office as preacher at Nürnberg, because he would not agree to the Augsburg Interim; but was immediately afterwards invited by Albrecht, Duke of Prussia, to become the head of the theological faculty in the newly-established university of Königsberg. He was hardly settled here when he became entangled in a theological strife that embittered his naturally imperious and arrogant temper. In a treatise, *De Lege et Evangelio* ('On the Law and the Gospel'), O. asserted that the righteousness by which sinners are justified, is not to be conceived as a mere justificatory or imputative act on the part of God, but as something inward and subjective, as the impartation of a real righteousness, springing in a mystical way from the union of Christ with man. The most notable of his opponents was Martin Chemnitz (q. v.). A seemingly amicable arrangement between the disputants was brought about by Duke Albrecht in 1551; but the strife was soon recommenced, by O. publishing some new writings in which he attacked Melancthon; nor did his death in the following year put a stop to the war of words. It was continued by his followers, called *Osiandrians*, who were finally extinguished by the *Corpus Doctrinæ Prutenicum* (in 1567), which caused their banishment from all parts of Prussia. See Wilken, *Andr. Osiander's Leben, Lehre und Schriften* (Strals. 1844).

**O'SIER** (Fr. probably of Celtic origin), the popular name of those species of Willow (q. v.), which are chiefly used for basket-making and other wicker-work. They are of low bushy growth, few of them ever becoming trees, their branches long and slender; and they are the more valuable in proportion to the length, slenderness, suppleness, and toughness of their branches. Their leaves are long and narrow, lanceolate, or nearly so, obscurely notched on the margin, almost always smooth on the upper side, but generally white and downy beneath. The

COMMON O. (*Salix viminalis*), a common native of wet alluvial grounds in Britain and many parts of Europe, is one of those which sometimes become trees, although when cultivated for basket-making, it is not permitted to do so. It has two distinct stamens in the flowers of the male catkins; and the stigmas of the female catkins are long and slender. It is often planted to prevent the banks of rivers from being washed away. Its branches are used for making hoops and coarse baskets. There are several varieties in cultivation, not easily distinguished except by a very practised eye, but much more useful than the original or wild kind, which is apt to break, and therefore of little value. More suitable for the finer kinds of basket-making are *Salix Forbyana*, sometimes called the FINE BASKET O., and *S. rubra*, known near London as the GREEN-LEAVED O. or ORNARD; *S. triandra*, a triandrous species, known to English osier-cultivators and basket-makers as the SPANIARD ROD; whilst *S. vitellina*, a pentandrous species, sometimes becoming a tree, is the GOLDEN O. or Golden Willow, remarkable for the bright-yellow colour of its branches, as well as for their pliancy and toughness. There are other species, not natives of Britain, which are also valuable; but the osiers chiefly cultivated belong to those which have been named, or are very nearly allied to them.

Osiers are very extensively cultivated in Holland, Belgium, and France, on alluvial soils, especially near the mouths of rivers; and from these countries great quantities of 'rods' are imported into Britain. They are cultivated also to a considerable extent in some parts of England, particularly on the banks of the Thames and the Severn, and in the level districts of Cambridgeshire, Huntingdonshire, &c. They are nowhere extensively cultivated in Scotland. Islets in the Thames and other rivers, entirely planted with osiers, are called *O. holts*. Osiers grow particularly well on grounds flooded by the tide. Much depends on the closeness of planting of O. grounds; as when space is too abundant, the shoots of many of the kinds do not grow up so long, slender, and unbranched as is desirable. The French cultivators, when they wish osiers for the finest kinds of basket-work, cut branches into little bits with a bud or eye in each, and plant these pretty close together, so as to obtain weak but fine shoots; but generally cuttings of fifteen or sixteen inches in length are used, and of tolerably thick branches; and these are placed in rows, from 18 inches to 2 feet apart, and at distances of 15 to 18 inches in the row. O. plantations in light soils continue productive for 15 or 20 years, and much longer in rich alluvial soils. Osiers succeed best in rich soils, but not in clays. No cultivation is required after planting; but the shoots are cut once a year, at any time between the fall of the leaf and the rising of the sap in spring. After cutting, they are sorted; and those intended for brown baskets are carefully dried and stacked, care being taken that they do not *heat*, to which they are liable, like hay, and by which they would be rotted and rendered worthless. The stacks must be carefully protected from rain. The osiers intended for white baskets cannot at once be peeled; but after being sorted, they are placed upright in wide shallow trenches, in which there is water to the depth of about four inches, or in rivulets, being kept secure in their upright position by posts and rails; and thus they remain till they begin to bud and blossom in spring, which they do as if they remained on the parent plant, sending forth small roots at the same time into the water. They are then, in ordinary seasons, easily peeled by

drawing them through an instrument called a *break* but in cold springs it is sometimes necessary to lay them for a while under a quantity of litter. After being peeled, they are stacked, preparatory to sale.

It is impossible to form an estimate of the quantity produced in Great Britain, but our imports amount annually to about 200,000 bundles; nearly one-half are from Holland, and the remainder from the Hanse Towns, Belgium, and France.

OSIRIS, according to others, *Astris*, or *Hysiris* ('Many-eyed'), a celebrated Egyptian deity, whose worship was universal throughout Egypt. This name appears in the hieroglyphic texts as early as the 4th dynasty, and is expressed by a throne and eye; at a later period, that of the 19th, a palanquin is substituted for a throne; and under the Romans, the pupil of the eye for the eye itself. O. does not indeed appear to have been universally honoured till the time of the 11th and 12th dynasties, or about 1800 B.C., when Abydos, which was reputed to be his burial-place, rose into importance. In the monuments of this age he is called great god, eternal ruler, dwelling in the west, and lord of Abut or Abydos. Even at the most remote period, individuals after death were supposed to become an Osiris; and all the prayers and ceremonies performed addressed to them were in this character, referring to their future life and resurrection. At the time of the 18th dynasty, this title of Osiris was prefixed to their names, and continued to be so till the time of the Romans and fall of paganism.

In the Ritual, and other inscriptions, O. is said to be the son of Seb or Saturn, and born of Nu or Rhea; to be the father of Horus by Isis, of Anubis, and of the four geni of the dead. Many mystic notions were connected with O.; he was sometimes thought to be the son of Ra, the Sun, or of Atum, the setting Sun, and the Benu or Phoenix; also to be uncreate, or self-engendered, and he is identified in some instances with the Sun or the Creator, and the Pluto or Judge of Hades. O. was born on the first of the Epagomenæ, or five additional days of the year. When born, Chronos or Saturn is said to have given him in charge to Pamytes; having become king of Egypt, he is stated to have civilised the Egyptians, and especially to have taught them agriculture, the culture of the vine, and the art of making beer; he afterwards travelled over the earth, and conquered the people everywhere by his persuasion. During his absence, his kingdom was confided to Isia, who guarded it strictly, and Set or Typhon, the brother of O. (who was born on the 3d of the Epagomenæ), was unable to revolt against him. Typhon had, however, persuaded 72 other persons, and Aso, the queen of Ethiopia, to join him in a conspiracy; and having taken the measure of O., he had a chest made of the same dimensions, richly ornamented and carved, and produced it at a banquet, where he promised to give it to whomsoever it should fit; and when all had lain down and tried it, and it suited none, O. at last laid himself down in it, and was immediately covered over by the conspirators, who placed the lid upon it, and fastened it with nails and molten lead. The chest was then hurled into the Nile, and floated down the Tanaitic mouth into the sea. This happened on the 17th of the month Athyr, in the 28th year of the reign or age of Osiris. Khem or Pan, and his attendant deities, discovered the loss of the god; Isis immediately cut off a lock of hair and went into mourning, and proceeded in search of Anubis, the child of her sister Nephthys by O.; and having found him, brought him up. The chest having floated to Byblos, had lodged in a tamarisk, and became enclosed in the

tree, which was cut down by the king, and the trunk, containing the chest and the body of the god, converted into a pillar to support the roof of the palace. The goddess proceeded to Byblos, and ingratiated herself with the queen's women by plaiting their hair and imparting to it an ambrosial smell, so that the monarch, whose name was Melcarthus, and his wife, Saosis or Nemanoun, invited her to court to take care of the royal child. She endeavoured to confer immortality upon him by placing him on a fire, and changing herself into a swallow, flew round the pillar and bemoaned her fate. The queen became alarmed at the danger of her child; Isis revealed herself, and asked for the pillar of tamarisk wood, which was given her. She then cut it open, and took out the chest, making great lamentations, and subsequently sailed for Egypt, with the eldest of the king's sons. The goddess, intending to visit Horus her son at Buto, deposited the chest in an unfrequented spot; but Typhon discovered it by the light of the moon, tore it into 14 pieces, and distributed each to a nome or district. Isis recovered all by passing the marshes in a boat of papyrus; all except the phallus, which had been eaten by the Lepidotus, the Phagrus, and Oxyrhynchus fish. Subsequently, a battle took place between Horus and Typhon or Set, which lasted three days, and ended by Typhon having fetters placed upon him. Isis, however, liberated Typhon, which so enraged Horus that he tore off her diadem, but Teti or Thoth placed on her the head of a cow instead. Typhon finally accused Horus of illegitimacy; but the question was decided between them by Teti or Thoth and the gods. From O., after his death, and Isis sprung Harpocrates. See HARPOCRATES. O. seems to have been finally revived, and to have become the judge of the Karneter or Hades, presiding at the final judgment of souls in the Hall of the two Truths, with the 42 demons who presided over the capital sins, and awarding to the soul its final destiny. Thoth or Hermes recorded the judgment, and justified the deceased against his accusers, as he had formerly done for Osiris.

Considerable diversity of opinion existed amongst the ancients themselves as to the meaning of the myth of Osiris. He represented, according to Plutarch, the inundation of the Nile; Isis, the irrigated land; Horus, the vapours; Buto, the marshes; Nephthys, the edge of the desert; Anubis, the barren soil; Typhon, was the sea; the conspirators, the drought; the chest, the river's banks. The Tanaitic branch was the one which overflowed unprofitably; the 28 years, the number of cubits which the Nile rose at Elephantine; Harpocrates, the first shootings of the corn. Such are the naturalistic interpretations of Plutarch; but there appears in it the dualistic principle of good and evil, represented by O. and Set or Typhon, or again paralleled by the contest of Ra or the Sun, and Aponhis or Darkness. The difficulty of interpretation increased from the form of O. having become blended or identified with that of other deities, especially Ptah-Socharis, the pigmy of Memphis, and the bull Hapis or Apis, the avatar of Ptah. Osiris was the head of a tetrad of deities, whose local worship was at Abydos, but who were the last repetition of the gods of the other nomes of Egypt, and who had assumed an heroic or mortal type. In form, O. is always represented swathed or mummied in allusion to his embalment; a net-work, suggestive of the net by which his remains were fished out of the Nile, covers this dress; on his head he wears the cap *atf*, having at each side the feather of truth, of which he was the lord. This is placed on the

horns of a goat. His hands hold the crook and whip, to indicate his governing and directing power; and his feet are based on the cubit of truth; a panther's skin on a pole is often placed before him, and festoons of grapes hang over his shrine, connecting him with Dionysos. As 'the good being,' or Onnophris the meek hearted, the celestial or king of heaven, he wears the white or upper crown. Another and rarer type of him represents him as the *Tat*, or emblem of stability, wearing the crown of the two Truths upon his head. His worship, at a later time, was extended over Asia Minor, Greece, and Rome, and at an early age had penetrated into Phœnicia, traces of it being found on the coins of Malta and other places. He became introduced along with the Isiac worship into Rome, and had votaries under the Roman empire. But the attacks of the philosophers, and the rise of Christianity, overthrew these exotic deities, who were never popular with the more cultivated portion of the Roman world.

Herodotus, ii. 40–42; Plutarch, *De Iside*; Tibullus, i. 7; Diodorus, i. 25; Prichard, *Mythology*, p. 208; Wilkinson, *Man. and Cust.* iv. 314; Bunsen, *Egypt's Place*, i. 414.

O'SMAZOME, a name given by Thenard to the spirit-extract of flesh, on which, as he supposed, its agreeable taste, when cooked, depended. The term is now abandoned by chemists.

O'SMIUM (symb. Os; equiv. 100; spec. grav. 10) is one of the noble metals which occurs in association with platinum in the form of an alloy with iridium. It may be obtained in the metallic condition by several processes which yield it either in thin, dark-gray glistening scales, or as a dense iron-black mass. It is the least fusible of all the metals; the oxyhydrogen jet volatilising, but not fusing it.

Five oxides of O. are known—viz., the *protioxide* (OsO), which is of a dark-green colour, and forms green salts when dissolved in acids; the *sesquioxide* (Os<sub>2</sub>O<sub>3</sub>), which has not been isolated; the *binioxide* (OsO<sub>2</sub>), which is black; the *teroxide* (OsO<sub>3</sub>), which possesses the characters of a weak acid, but has not been isolated; and *osmic acid* (OsO<sub>4</sub>), which occurs in colourless, glistening, acicular crystals, freely soluble in water, and very volatile. At about 220°, this compound gives off an extremely irritating and irrespirable vapour; and hence the name of the metal (from the Greek word *osmē*, odour). It produces a permanent black stain upon the skin, and gives a blue precipitate with tincture of galls. O. also forms four chlorides, which correspond in composition to the first four oxides. This metal was discovered by Tennant in 1803.

O'SMOSE; DIALYSIS. The earlier discoveries of Dulong and Graham have been briefly described in the article on DIFFUSION (q. v.). The subject has, however, been much extended recently, principally by the investigations of Graham; and as the whole phenomena are exceedingly interesting and important, since secretion, absorption, and various other organic processes are to a great extent dependent on them, some further detail, especially of these later facts, may here be given.

When two different liquids are separated by a bladder or other membrane, or a piece of calico coated with coagulated albumen, there is always a more or less rapid transference of the two liquids in opposite directions through the diaphragm. In certain cases, the explanation given in the article referred to is complete, but in others it appears to be insufficient. Graham has made an extensive series of experiments upon osmose, where distilled

water was on one side of the diaphragm, and various liquids and solutions on the other, and has arrived at many general results, of which the following are the more important. The osmose is considered as *positive* when more of the water passes through the diaphragm than of the other liquid. Such substances as gum, gelatine, &c., produce scarcely any effect. Solutions of neutral salts, such as common salt, Epsom salts, &c., follow the ordinary law of diffusion, as if no diaphragm had been interposed. Acid salts in solution, and dilute acids, pass rapidly into the water—or the osmose is *negative*; while alkaline solutions give, in general, a strong *positive* effect.

In all the cases in which an osmotic action occurs which cannot be explained by capillary forces, there is chemical action on the diaphragm; and conversely, such osmose cannot be produced if the material of the diaphragm be not acted on by the liquids in contact with it.

But the most remarkable results of Graham's later investigations are those relating to Dialysis—i. e., to the separation of the constituents of mixtures, and even the decomposition of chemical compounds, by osmose. The results of his earlier investigations, above given, shew a remarkable difference between two classes of bodies; gum, gelatine, &c., which form viscous solutions, on the one hand; and salts, acids, and alkalies, on the other. The first class he has called *Colloids*; the second, *Crystalloids*. The former are extremely sluggish, the latter comparatively rapid in their action. Thus, of common salt and albumen, under precisely similar circumstances, there pass through the diaphragm in a given time quantities which are as 25 to 1 by weight. Hence, if a solution containing both classes of substances be opposed to pure water, the crystalloids will pass rapidly through the diaphragm, and the colloids slowly. This process promises to be of very great value in medical jurisprudence, as, without introducing any new substance (except the diaphragm and distilled water), we have the means of separating from the generally colloidal contents of animal viscera such poisonous crystalloids as white arsenic, vegetable alkaloids, &c., which by the old methods was in general attended with great difficulty, and often uncertainty. These methods are still in their infancy, but enough is already known to shew how valuable they must soon become to the chemist and the toxicologist. One economical application has been proposed, and shewn to be practicable. When a bladder is filled with the brine of salt beef, and suspended in fresh water, the salt after a time nearly all disappears, and there remains in the bladder a rich extract of meat fit for making soup.

For a brief notice of the speculations which Graham's researches have led him to form as to the nature of *Matter*, we refer to the article on that subject.

**OSMUNDA**, a genus of Ferns, distinguished by spore-cases in branched, stalked masses. The **OSMUND-ROYAL**, **ROYAL**, or **FLOWERING FERN** (*O. regalis*), is the noblest and most striking of British ferns. It is very frequent in the districts of Scotland and Ireland most remarkable for the moisture of their climate, growing in boggy places and the wet margins of woods. It has bipinnate fronds, and panicled spore-cases upon altered fronds, which appear as stalks distinct from the fronds, and assimilate the general appearance to that of a phanerogamous plant. It sometimes rises to 11 feet in height. It is found in many parts of Europe, and in North America. It possesses tonic and styptic properties, and its root-stocks were formerly

employed in scrofula. The root-stocks abound in a mucilaginous substance, which, being extracted by



Royal Fern (*Osmunda regalis*):

a, pinnate of a barren frond; b, branchlet of fertile frond; c, spore-case; d, the same, shewing how it opens by two valves.

boiling them in water, is used in the north of Europe instead of starch.

**OSNABRÜCK**, or **OSNABURG**, a territory occupying the western portion of the kingdom of Hanover, and embracing the principality of O., the countships of Lingen and of Bentheim, and the duchy of Arensburg-Meppen and the lordship of Papenburg. Area, 2388 square miles; pop. 262,316 at the close of 1861.

**OSNABRÜCK**, the chief town of the territory, lies in the midst of the extended and fruitful valley of the Hase, 80 miles west-south-west of Hanover by railway. It still ranks as the third commercial city of Hanover, although it cannot boast of the important trade which it enjoyed before the establishment of the existing system of the Prussian Zollverein. Pop. 16,180. O. has thriving manufactories of cigars and tobacco, paper-hangings, and cotton and woollen goods, and extensive works for the preparation of mineral dyes and cement, besides iron, machinery, and carriage manufactories. According to the opinion of antiquarians, O. stands on the site of the ancient Wittekindsburg, which was raised to a bishopric in 783 by Charlemagne, some relics of whom, together with the pretended bones of the martyrs Crispinus and Crispinianus, are preserved in the cathedral—a fine specimen of the Byzantine style of architecture of the 12th century. The Church of St Mary, a noble Gothic building, was erected by the burghers of O. in the 14th c. during their contentions with their haughty ecclesiastical rulers, and contains the grave of Möser, in whose honour a statue was placed in the square of the cathedral in 1836. The signing of the peace of Westphalia in 1648, in an apartment of the town-hall, is commemorated by the preservation of the portraits of all the ambassadors who took part in the treaty. It was decreed in this treaty that the ancient bishopric of O. should thenceforth be occupied alternately by a Roman Catholic prelate and a Protestant secular prince of the House of Brunswick-Lüneburg; and after having been last held by Frederick, Duke of York, the district of O. was ceded to Hanover in 1803, and the chapter finally dissolved.



**O'SPREY** (*Pandion*), a genus of *Falconidae*, of which only one species is known (*P. haliaëtus*), also called the **FISHING HAWK** or **FISHING EAGLE**, and sometimes the **BALD BUZZARD**. It is singular among the *Falconidae* in preying *exclusively* on fish; and to this its whole structure and habits are adapted. Its whole length is about twenty-two inches: it is of a dark-brown colour, variegated with black, gray, and white. The under parts are white, except a light-brown band across the chest.



Osprey (*Pandion haliaëtus*).

The bill is short, strong, rounded, and broad. The tail is rather long, the wings are very long, extending beyond the tail; the under surface of the toes remarkably rough, covered with small pointed scales, suited for the securing of slippery prey; the claws not grooved beneath, as in most of the *Falconidae*. The feathers are destitute of the supplementary plume, which is considerably developed in most of the *Falconidae*. The intestine differs from that of the other *Falconidae* in being very slender and of great length.

The O. is chiefly to be seen near the sea, lakes, and large rivers. No bird is more widely diffused; it is found in all quarters of the world; its geographical range including Europe, Asia, Africa, North and South America, and Australia, and both very warm and very cold climates. It is everywhere a bird of passage, retiring from high northern latitudes on the appearance of frost. It occurs on many parts of the British coasts, and is sometimes found in inland districts, but is nowhere abundant in Britain. In some places in Scotland, it still breeds year after year, on the highest summit of a ruined building, or the top of an old tree. It is very plentiful in some parts of North America; and its return in the beginning of spring is hailed with joy by fishermen, as indicative of the appearance of fish. The nest is a huge structure of rotten sticks, in the outer interstices of which smaller birds sometimes make their nests; for the O. never preys on birds, and is not dreaded by them. It is, indeed, of a pacific and timorous disposition, and readily abandons its prey to the White-headed Eagle (or Erne, q. v.). In the days of falconry, the O., being very docile, was sometimes trained and used for catching fish.

**O'SSA**, the ancient name of a mountain on the east side of Thessaly, near Pelion, and separated from Olympus by the vale of Tempe. It is now called Kissavo. The conical summit is covered

with snow during the greater part of the year. The ancients placed the seat of the Centaurs and Giants in the neighbourhood of Pelion and Ossa.

**O'SSEIN**. This term is applied by chemists to the substance in the tissue of the bones which yields gluten. It is obtained by the prolonged action of dilute hydrochloric acid on bone, which dissolves all the earthy matter. The material thus procured retains the form of the bone without its hardness, and must be repeatedly washed with water, and treated with alcohol and ether to remove traces of salts, fat, &c. It is insoluble in water, but is converted into gluten (one of the forms of gelatine) by the action of boiling water—a transformation which is much facilitated if a little acid be present. The ossein yielded by different kinds of animals requires different times for its conversion into gluten; and that of young animals changes more rapidly than that of adults of the same species. It appears to exist in the bones in a state of freedom—that is to say, not in combination with any of the salts of lime. Fremy's analyses shew that the amount of gluten is precisely the same as that of the ossein which yields it, and that the two substances are isomeric.

**O'SSIAN**, **POEMS OF**. Ossian, or Oisín (a word which is interpreted the 'little fawn'), a Celtic warrior-poet, is said to have lived in the 3d c., and to have been the son of Fingal or Finn MacCumhail. The poems which are ascribed to him in manuscripts of any antiquity, are few and short, and of no remarkable merit. But in 1760—1763, a Highland schoolmaster, James Macpherson (q. v.), published two epics, *Fingal* and *Temora*, and several smaller pieces and fragments, which he affirmed to be translations into English prose of Gaelic poems written by O., and preserved by oral tradition in the Scottish Highlands. Their success was wonderful. They were received with admiration in almost every country of Europe, and were translated not only into French and Italian, but into Danish and Polish. But their authenticity was challenged almost as soon as they saw the light, and a long and angry controversy followed. That they were what they claimed to be, was maintained by Dr Blair, Lord Kames, the poet Gray, and Sir John Sinclair. That they were more or less the fabrication of Macpherson himself, was maintained by Dr Johnson, David Hume, Malcolm Laing, and John Pinkerton. While this controversy still raged, another sprang up scarcely less angry or protracted. Macpherson made O. a Scotch Highlander, but the Irish claimed him as an Irishman. Both controversies may be said to have now worn themselves out, leaving as their several result a conviction which can scarcely be better stated than in the words of Lord Neaves: 1. 'The poems published by Macpherson as the compositions of Ossian, whether in their English or their Gaelic form, are not genuine compositions as they stand, and are not entitled to any weight or authority in themselves, being partly fictitious, but partly at the same time, and to a considerable extent, copies or adaptations of Ossianic poetry current in the Highlands, and which also, for the most part, is well known in Ireland, and is preserved there in ancient manuscripts. 2. Upon fairly weighing the evidence, I feel bound to express my opinion that the Ossianic poems, so far as original, ought to be considered generally as Irish compositions relating to Irish personages, real or imaginary, and to Irish events, historical or legendary; but they indicate also a free communication between the two countries, and may be legitimately regarded by the Scottish Celts as a literature in which they have a direct interest; written in their ancient tongue, recording

## OSSIFICATION.

traditions common to the Gaelic tribes, and having been long preserved and diffused in the Scottish Highlands; while if the date, or first commencement of any of these compositions, is of great antiquity, they belong as much to the ancestors of the Scottish as of the Irish Celts.' Poems ascribed to O., committed to writing in the Scotch Highlands in the first half of the 16th c., are printed in the *Dean of Lismore's Book* (Edin. 1862), with translations as well into English as into modern Gaelic. The poems ascribed to O., preserved in Ireland, have been published by the Ossianic Society in six volumes (Dublin, 1854—1861).

**OSSIFICATION**, or the formation of bone, is a process to which physiologists have paid much attention, but regarding which there is still considerable difference of opinion. On one point, however, there is a general agreement—viz., that the bones are not in any instance a primary formation, but always result from the transformation and earthy impregnation of some pre-existing tissue, which is most commonly either cartilage or a membrane containing cell-nuclei. At a very early period of embryonic life, as soon, indeed, as any structural differences can be detected, the material from which the bones are to be formed becomes mapped out as a soft gelatinous substance, which may be distinguished from the other tissues by being rather less transparent, and soon becoming decidedly opaque. From this beginning the bones are formed in two ways: either the tissue just described becomes converted into cartilage, which is afterwards replaced by bone, or a germinal membrane is formed, in which the ossifying process takes place. The latter is the most simple and rapid mode of forming bone. When ossification commences, the membrane becomes more opaque, and exhibits a decided fibrous character, the fibres being arranged more or less in a reticulated manner. These fibres become more distinct and granular from impregnation with lime salts, and are converted into incipient bone, while the cells which are scattered among them shoot out into the bone corpuscles, from which the canaliculi are extended probably by resorption. The facial and cranial bones, with the exception of those at the base of the skull, are thus formed without the intervention of any cartilage.

The process of ossification in Cartilage (q. v.) is too complex and difficult to follow in these pages. Some physiologists hold that when ossification is carried on in cartilage, a complete molecular replacement of one substance by the other takes place; while others believe that more or less of the cartilaginous matrix remains, and becomes impregnated with earthy matter, at the same time that gluten is substituted for chondrine (chondrine being the variety of gelatine that is yielded by ossein or bone-cartilage before ossification, while gluten is yielded after that process is established). All the bones of the body, excepting those of the head and face already mentioned, are at first formed, in part at all events, from cartilage.

The time at which ossification commences does not at all follow the order in which the primordial cartilage is laid down. Thus the cartilage of the vertebræ appears before there is any trace of that of the clavicle, yet at birth the ossification of the latter is almost complete, while that of the former is very imperfect for many years. We will briefly trace the process of ossification as it occurs in the human femur or thigh-bone. Ossification commences in the interior of the cartilage at determinate points, which are hence termed *points* or *centres of ossification*. From these points the process advances into the surrounding substance. In the second month of foetal life, one of these centres shews itself

about the middle of the shaft, and from this point ossification rapidly extends upwards and downwards along the whole length of the shaft. The upper and lower ends remain cartilaginous, and it is not till the last month of foetal life that a second centre appears at the lower end. The third centre, from which the upper end of the bone is ossified, does not appear till about a year after birth. The bone now consists of two extremities or *epiphyses*, with an intermediate shaft or *diaphysis*; and the superior epiphysis is not ossified to the shaft until about the eighteenth, and the inferior until after the twentieth year. At about the fifth year, a fourth ossific centre is developed in the cartilage of the greater trochanter, and a fifth centre appears in the lesser trochanter at about the fourteenth year. These osseous processes, thus developed from special ossific centres, are termed *apophyses*. Most of the long bones are developed in a corresponding way. It is a curious fact (which is of such general occurrence that it may be regarded as a law) that in the skeletons both of man and of the lower animals, the union of the various apophyses to the epiphyses, and of the epiphyses to the diaphysis or shaft, takes place in the inverse order to that in which their ossification began. The advantages derived from this subdivision of the long bones into segments, with interposed cartilaginous plates, are obvious. Besides the greater facilities for growth thus afforded, the flexibility of the bony framework is thereby greatly increased, and its escape from injury during the many falls incidental to this period of life is in no small degree attributable to this cause. See Humphry *On the Human Skeleton*, pp. 33—45.

*True Ossification* sometimes occurs as a morbid process; but in many cases, the term is incorrectly used (especially in the case of blood-vessels) to designate a hard calcareous deposit, in which the characteristic microscopic appearances of true bone are altogether absent.

In one sense, the osseous tissue that is formed in regeneration of destroyed or fractured bones, may be regarded as due to a morbid, although a restorative action. Hypertrophy of bone is by no means rare, being sometimes local, forming a protuberance on the external surface, in which case it is termed an *exostosis*; and sometimes extending over the whole bone or over several bones, giving rise to the condition known as *hyperostosis*. Again, true osseous tissue occasionally occurs in parts in which, in the normal condition, no bone existed, as in the dura mater, in the so-called permanent cartilages (as those of the larynx, ribs, &c.), in the tendons of certain muscles, and in certain tumours. The peculiar causes of the osseous formations which are unconnected with bone, are not known.

Calcareous deposits or concretions not exhibiting the microscopical character of bone, but often falsely termed ossifications, are of no unfrequent occurrence. Analyses of such concretions occurring in pus, in the valves of the heart, in the muscles, and in the lungs, are given by Vogel in his *Pathological Anatomy of the Human Body*; and in some of these concretions, the phosphate and carbonate of lime occur in nearly the same percentages as those in which they are found in bone. The diseased condition usually but incorrectly called ossification of the arteries, is of sufficient importance to require a brief notice. In consequence of the deposition of earthy or calcareous matter in the middle coat of the artery, the vessel loses all its elasticity, and becomes a rigid, unyielding tube. All parts of the arterial system are liable to this change; but it is more frequently met with in the ascending portion and arch of the aorta, than in any other part of

that vessel, and is more common in the lower extremities than the upper. The affection is usually partial, but occasionally it appears to be almost universal. Thus, Dr Adams has recorded a case, in the Dublin Hospital Reports, in which no pulsation could be felt in any part of the body, and even the heart offered no other sign of action than a slight undulating sound. Old age strongly predisposes to this diseased condition, and probably few very aged persons are altogether exempt from it. There is also reason to believe that gout and rheumatism favour these calcareous deposits. This condition of the arteries may give rise to aneurism, to gangrene of the extremities in aged persons, and to atrophy, and consequent feebleness of the brain and heart. (The coronary arteries, which supply the heart with the arterial blood necessary for its own nutrition, are very often, although not always, ossified in angina pectoria.) Moreover, this condition of the vessels very materially increases the risk from severe accidents and surgical operations.

**OSTADÉ, ADRIAN VAN**, a celebrated painter and engraver of the Dutch school, was born at Lübeck, in North Germany, in 1610. His teachers were Franz Hals and Rembrandt. He followed his art at Haarlem, till the French army of Louis XIV. threatened Holland, when he removed to Amsterdam, where he spent the remainder of his life. He died in 1685. Country dancing-greens, farm-yards, stables, the interiors of rustic hovels and beer-shops, are the places which he loves to paint; and his persons are for the most part coarse peasant carls, drunken tobacco-smokers, or peasant women employed in country work. In everything he did there is a bright and vivid naturalness. Not equal to Teniers in originality and quiet humour, he surpasses him in the force and fineness of his execution, though he is not free from triviality and repetitions, and inaccuracies in drawing. He was a prolific painter, and his works are to be found in all the museums and collections of the Netherlands, Germany, France, and England. They have been well engraved by Vischer, Suyderoef, and himself.—**ISAAC VAN OSTADE**, brother of Adrian, also a painter, was born at Lübeck in 1612, and died at Amsterdam in 1671. He did not equal his brother whose style he laboured to imitate.

**OSTASHKOFF**, a manufacturing district town of Great Russia, in the government of Twer, stands on the south-east shore of Lake Seliguer; lat. 57° 10' N., long. 33° 6' E. The first settlements on this site are said to have taken place in 1230. Pop. 10,827. Skin-dressing, boot-making, and fishing in the neighbouring lakes are the principal employments of the inhabitants. The woods in the vicinity furnish bark for tanning purposes, and charcoal for the blacksmiths' shops. There are in O. 37 tanyards, in which skins are dressed, and Russian leather prepared to the amount of £90,000 annually. The leather prepared at Savine's tanyard is known in England, Austria, Italy, and North America. 280,000 pairs of boots are made annually, and 400 men and 1000 women are engaged in the manufacture. Manufactures of hatchets and scythes are also carried on. The commerce of O. is small, however, owing to its remote distance from important lines of communication.

**OSTENDE**, a strongly fortified town of the Belgian province of West Flanders, on the German Ocean, at the opening of the Ostende and Bruges Canal, in 51° 14' N. lat., and 2° 55' E. long. Pop. 16,000. Notwithstanding its proximity to the sea,

the shallowness of the harbour prevents large ships from entering the port except at high tide. It ranks, however, as the second seaport of the kingdom, Antwerp being the first, and is fortified with walls and broad ditches. It has some good manufactories for linens, sailcloths, and tobacco, and several sugar, salt, and candle works. From its position as a station for the steamers plying daily between London, Dover, and the continent, and as the terminus of various branches of railway in connection with the great French and German lines, it is a lively and active place of transport traffic, and is resorted to in the summer as a bathing-place by persons from all parts of the continent. It is, moreover, an important station for oyster, cod, and herring fishing; has a good naval school, some ship-yards, an efficient staff of pilots, and is the seat of a commercial tribunal and a chamber of customs. The harbour is furnished with a light-house, and is provided with an admirably-constructed stone dyke or promenade for the accommodation of the public. O. is memorable for the protracted siege which it underwent from 1601 to 1604, and which terminated in the surrender of the Dutch and Flemish garrison to the Spanish commander, Spinola.

**OSTEOC'OLA**, a kind of size or glue made by removing the mineral matter from bones, and dissolving the gelatine. Its more common name is bone-glué.

**OSTEOLEPIS** (Gr. bone-scale), a genus of fossil ganoid fish peculiar to the Old Red Sandstone. It is

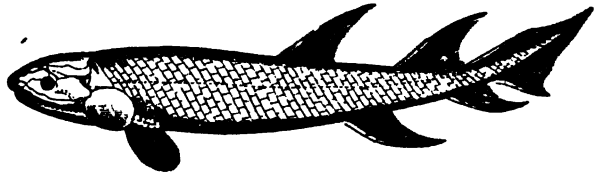

Osteolepis.

separated from its allies by having the two anal and two dorsal fins alternating with each other. Seven species have been described.

**OSTEO'LOGY** (Gr. *ostea*, the bones) is that department of anatomy which treats of the chemical and physical properties of the osseous tissue, and of the shape, development and growth, articulations, &c., of the various bones of which the skeleton is composed. See **BONE**, **OSRIFICATION**, **SKELETON**, &c.

**O'STERODÉ**, a small town of Hanover, in the principality of Grubenhagen, situated at the western base of the Harz Mountains, on the Söse, an affluent of the Leine, 20 miles north-east of Göttingen. It contains large grain stores, from which the miners of the neighbourhood and their families are supplied with grain at a low and fixed rate. Cotton, woollen, and linen fabrics and hosiery are extensively manufactured. Pop. 6000.

**O'STIA**, a city of Latium, at the mouth of the Tiber, about 16 miles from Rome. It is said to have been founded by Ancus Martius, and was regarded as the oldest Roman colony. It first acquired importance from its salt-works, the establishment of which is attributed to Ancus Martius, and afterwards as the port where the Sicilian, Sardinian, and African corn shipped for Rome was landed; yet its name first occurs during the second Punic war. It was long, too, the principal station of the Roman navy; but its harbour was exceedingly bad, and gradually the entrance became silted up with alluvial deposits, so that vessels could no longer approach

it, but were compelled to ride at anchor in the open roadstead, and to disembark their cargoes there. At length the Emperor Claudius dug a new harbour or basin two miles north of O., and connected it with the Tiber by a canal. It was named the *Portus Augusti*, and around it soon sprung up a new town called *Portus Ostiensis*, *Portus Urbis*, *Portus Romæ*, and often simply *Portus*. Yet it was not till nearly the close of the Roman empire that the prosperity of O. as a city began to decline. Its decay, however, was rapid, and in the 8th c. it was a mere ruin. During the middle ages, a village—the modern O.—was built about half a mile above the ancient one; but it has not more than 100 permanent inhabitants, who still carry on the manufacture of salt, established in the pre-historic times of ancient Rome. The ruins of O. extend for a mile and a half along the banks of the Tiber, and are nearly a mile in breadth. See Nibby's *Dintorni di Roma* (vol. ii.).

**OSTRA'CION**, a genus, and **OSTRACIONIDÆ**, a family of fishes of the order *Plectognathi*. They are remarkably distinguished by having the whole body covered with an inflexible tuberculated coat of mail, formed of six-sided bony scales or plates combined in a tessellated quincuncial manner; the fleshy lips, the fins, and the tail protruding through holes in the armour. The gill-opening appears in the armour as a mere slit, bordered with a skinny edge, but there is a true gill-cover within. There are no ventral fins. The vertebrae are generally coalescent. There is little muscular substance, and in some species it is reputed poisonous; but the liver is large, and yields much oil. Some of the species are known by the names of **TRUNK-FISH** and **COFFER-FISH**. They are mostly found in the Indian and American seas. None are British.

**O'STRACISM**, a right exercised by the people of Athens of banishing for a time any person whose services, rank, or wealth appeared to be dangerous to the liberty of his fellow-citizens, or inconsistent with their political equality. It was not a punishment for any particular crime, but rather, as has been observed, a precautionary measure to remove such leaders as were obviously exercising a dangerous ascendancy in the state. Ostracism was introduced by Cleisthenes about the beginning of the 6th c. a.c., after the expulsion of the Peisistratida. The people were annually asked by the Prytanes if they wished to exercise this right, and if they did, a public assembly was held, and each citizen had opportunity of depositing, in a place appointed for the purpose, a potsherd (*ostrakon*) or small earthen tablet, on which was written the name of the person for whose banishment he voted. Six thousand votes were necessary for the banishment of any person; but the greatest men of Athens—Miltiades, Themistocles, Cimon, Alcibiades, &c.—were subjected to this treatment. The banishment was at first for ten years, but the period was afterwards restricted to five. Property and civil rights or honours remained unaffected by it. Alcibiades succeeded in obtaining the final abolition of ostracism, of which, however, Plutarch and Aristotle speak as a necessary political expedient, and its utility has been very ably defended in modern times by Mr Grote (*History of Greece*, vol. iv. pp. 200 *et seq.*).

**O'STRICH** (*Struthio*), a genus of birds of the order *Grallatores*, and tribe *Brevipennes* (q. v.), in Cuvier's system—the order *Cursores* (or Runners) of some ornithologists. In this genus the bill is of moderate length, broad, flattened, rounded at the tip, the mandibles flexible; the head small; the neck long; the legs long (both tibia and tarsus) and very robust, the lower part of the tibia, as well as

the tarsus, naked; the feet have only two toes, of which the inner is the largest, and has a short claw, the outer has no claw; the wings are too short to be used for flight, but are useful to aid in running; the plumage is lax and flexible; the wings and tail have long soft drooping plumes. Only one species is known (*S. camelus*), a native of the sandy deserts of Africa and Arabia; the South American ostriches, or *Nandus* (q. v.), constituting a distinct genus. The O. is the largest of all birds now existing, being from six to eight feet in height to the top of its head, and an adult male weighing from two to three hundred pounds. The male is rather larger than the female. The head and upper part of the neck are scantily covered with a thin down, through which the skin is visible. The young have the



Ostrich (*Struthio camelus*).

head and neck clothed with feathers. The general plumage is glossy black in the adult male, dark gray in the female and young, with a slight sprinkling of white feathers; the long plumes of the wings and tail are white, occasionally marked with black. On each wing are two plumeless shafts, not unlike porcupine's quills. The inner toe is very large, about seven inches long, and its claw hoof-like. Whilst the sternum is destitute of a keel, and the muscles which move the wings are comparatively weak, those which move the legs are of prodigious strength, so that the O. is not only capable of running with great speed, but of striking such a blow with its foot as to make it too formidable for the leopard and other large beasts of prey to assail it. It has been often known to rip open a dog by a single stroke, and a man is recorded to have suffered the same fate. The eyes of the O. are large, and the lids are furnished with lashes. Its sight is keen, so that it descries objects at a great distance in the open desert.

The O. shuns the presence of man, but is often to be seen in near proximity to herds of zebras, quaggas, giraffes, antelopes, and other quadrupeds. It is gregarious, although the flocks of ostriches are not generally very large. It is polygamous, one male usually appropriating to himself, when he can, from two to seven females, which seem to make their nest in common, scooping a mere hole in the sand for this purpose. Each female is supposed to lay about ten eggs. The eggs are all placed on end in the nest, which often contains a large number, whilst around it eggs are generally to be found scattered on the sand. Concerning these, it has been supposed that they are intended for the food of the young birds before they are able to go in quest of other food; an improbable notion, not supported by evidence. It seems at least as likely that these scattered eggs are laid by females waiting whilst the nest is occupied by another, and that they are lost to the ostriches, and no more.

regarded. Contrary to a very generally received opinion, the O. does not leave her eggs to be hatched entirely by the heat of the sun; or, if this be the case in the warmest regions, it is otherwise in the more northern and southern countries in which this bird is found, and by a remarkable instinct, the O. sits upon the eggs by night, when the cold would be too great for them, and leaves them to the sun's heat during the day.

The O. feeds exclusively on vegetable substances, its food consisting in great part of grasses and their seeds; so that its visits are much dreaded by the cultivators of the soil in the vicinity of its haunts, a flock of ostriches soon making terrible devastation of a field of corn. The O. has a very large crop, a strong gizzard, and a pretty large *proventriculus* between the crop and the gizzard: the intestines are voluminous, and the *cæca* long, with a remarkable spiral valve. There is a receptacle in which the urine accumulates, as in a bladder, a thing very uncommon in birds.

The O. swallows large stones, as small birds swallow grains of sand, to aid the gizzard in the trituration of the food; and in confinement, has often been known to swallow very indiscriminately whatever came in the way, pieces of iron, bricks, glass, old shoes, copper coins, &c. Its instincts do not suffice to prevent it from swallowing very unsuitable things; copper coins were fatal in one instance, and a piece of a parasol in another.

The O. is very patient of thirst, or is capable of subsisting for a long time without water. It often supplies the want of water by eating the gourds or melons of the desert, to which even the lion is said to resort on the same account.

The speed of the O., when it first sets out, is supposed to be not less than 60 miles an hour; but it does not seem to be capable of keeping up this speed for a long time. It is successfully hunted by men on horseback, who take advantage of its habit of running in a curve, instead of a straight line, so that the hunter knows how to proceed in order to meet it and get within shot. It is often killed in South Africa by men who envelop themselves in ostrich skins, and admirably imitating the manners of the O., approach it near enough for their purpose, without exciting its alarm, and sometimes kill one after another with their poisoned arrows.

The strength of the O. is such that it can easily carry two men on its back.

The voice of the O. is deep and hollow, not easily distinguished, except by a practised ear, from the roar of the lion. It also more frequently makes a kind of cackling; and when enraged and striking violently at an adversary, hisses very loudly.

The flesh of the O. is not unpalatable when it is young, but rank and tough when old. It is generally believed to have been prohibited as unclean to the Jews (Lev. xi. 16), although the name is translated *owl* in the English Bible. There are frequent references to it in the Old Testament.

The eggs of the O. are much esteemed as an article of food by the rude natives of Africa, and are acceptable even to European travellers and colonists. Each egg weighs about three pounds, and is thus equal to about two dozen ordinary hen's eggs. The egg is usually dressed by being set upright on a fire, and stirred about with a forked stick, inserted through a hole in the upper end. The thick and strong shell is applied to many uses, but particularly is much employed by the South African tribes for water-vessels. The reader will probably recollect the interesting plate in Livingstone's *Travels* of women filling ostrich shells with water. In taking ostrich eggs from the nest, the South African is careful not to touch any with the

hand, but uses a long stick to draw them out, that the birds may not detect the smell of the intruder, in which case they would forsake the nest; whilst otherwise, they will return, and lay more eggs.

The long plumes of the O. have been highly valued for ornamental purposes from very early times, and continue to be a considerable article of commerce, for the sake of which the O. is pursued in its native wilds.

The O. is often to be seen in Britain in confinement, and readily becomes quite tame and familiar, although still apt to be violent towards strangers. Great numbers were exhibited in the public spectacles by some of the Roman emperors; and the brains of many ostriches were sometimes presented in a single dish, as at the table of Heliogabalus.

OSTRICH FEATHERS are occasionally borne as a heraldic charge, and always represented drooping. Three white ostrich feathers are the well-known badge of the Prince of Wales. According to common tradition, they were assumed in consequence of Edward the Black Prince having plucked a plume of ostrich feathers from the casque of John of Luxemburg, king of Bohemia, who fell by his hand at Crecy. There is, however, no doubt that ostrich feathers were previous to that time a cognizance of the Plantagenets. Prince Henry, eldest son of James I., first established the present arrangement of the three ostrich feathers within a prince's coronet.

OSTRO'G, a small district town of West Russia, in the government of Volhynia, 100 miles west of Jitomir. Here, in the reign of Constantine of Ostrog, a school and typography were established, and the first Slavonic Bible printed in 1558. Pop. 8926.

O'STROGOTHS. See GOTHs.

OSUNA, a town of Spain in the province of Seville, and 48 miles east-south-east of the city of that name, stands in a fertile plain, and on a triangular hill crowned by a castle and the collegiate church. It stands in the midst of a highly fertile plain, productive in grain, olives, almonds, &c. An extensive panoramic view is obtained from the castle. The collegiate church, in the mixed Gothic and cinque-cento style, was built in 1534. It was pillaged by Soutl of 5 cwt. of ancient church plate, and was converted by him into a citadel and magazine. Pop. 15,500, who are engaged in agriculture and in the manufacture of linen goods, and iron and earthenware.

OSWEGO, a city and port of entry, in New York, U.S., is situated at the mouth of Oswego River, on Lake Ontario, at the extremity of the Oswego Canal, a branch of the Erie, and also the terminus of the Syracuse and Oswego Railway. It is a handsome city, with streets 100 feet wide, crossing at right angles, with costly government buildings, custom-house, court-house, post-office, city hall, hospital, orphan asylum, library, 13 churches, 2 daily and 2 weekly newspapers, schools, &c. It has a large trade with the lake country and Canada, and exports 12,000,000 dollars per annum. On the falls of the river are 18 flour-mills, making 10,000 barrels of flour a day, with elevators for unloading vessels for 37,000 bushels an hour. Among the manufactures is that of 12,000,000 lbs. of starch from Indian corn per annum. This material, very commonly called Oswego Flour, or Oswego, is now largely used in cookery instead of arrow-root, to which it bears a close resemblance. There is a fort and navy-yard. Pop. in 1860, 16,817.

OSWEGO TEA, a name given to several species of *Monarda*, particularly *M. purpurea*, *M. didyma*,

and *M. kalmiana*, natives of North America, because of the occasional use of an infusion of the dried leaves as a beverage. They belong to the natural order *Labiata*, somewhat resemble mints in appearance, and have an agreeable odour. The infusion is said to be useful in intermittents, and as a stomachic. Some other species of *Monarda* are used in the same way.

OSWESTRY, a small market town and municipal borough of England, in the county of Salop, and 18 miles north-west of Shrewsbury. Portions of the old wall with which Edward I. ordered it to be surrounded in 1277 are still standing. There are also the remains of an ancient castle, said to have been the ancestral seat of Walter Fitzallan, progenitor of the royal House of Stuart, and who, during the troubles of the reign of King Stephen, fled hence to Scotland, and became steward to David I. king of Scotland. O. is the centre of an extensive agricultural district; it has a handsome new market-place, and its market for agricultural produce is very largely attended. Corn and paper mills and coal-mines are worked in the vicinity. It is favourably situated as the centre of extensive railway communication. Pop. (1861) of municipal borough, 5414.

O. is said to derive its name from Oswald, king of Northumbria, slain here in 642. Near the town is Oswald's Well, a fine spring of water.

OSYMANDYAS, the name of a great king of Egypt, mentioned by Diodorus and Strabo, who reigned, according to these authors, as the 27th successor of Sesostria. He distinguished himself, according to these authors, by his victories, and invaded Asia with an army of 400,000 men and 20,000 cavalry, and conquered the Bactrians, who had been rendered tributary to Egypt by Sesostria. In honour of this exploit, he is said by Hecataeus to have erected a monument which was at once a palace and a tomb, and which, under the name of *Osymandion*, was renowned for its size and splendour in later times. It was said to be situated in the necropolis of Thebes, or at Gournah, and close to the sepulchres of the concubines of the god Amen Ra. The *Osymandeion* is generally believed to be represented by the extant ruins of the palace of Rameses III. at Medinet Haboo, though great difficulty has been felt in reconciling the descriptions of its magnificence in ancient writers with the dimensions of the modern relic; and Letronne, in his *Tombeau d'Osymandyas* (Par. 1831), has even ventured to suppose that it was an imaginary edifice invented by the Greeks from their acquaintance with the great palaces of Thebes, but this scepticism is considered extreme. The name of O. is difficult to recognise amongst the Egyptian kings, the nearest approach to it being one of the Setis, either the 1st or 2d, called after death, Asiri-Manepthah. Others consider O. the Ismendes of Strabo, or the Mendes of Herodotus. The name of Amenophis may also lie concealed in his name, so much ambiguity pervades the subject.

Diodorus, l. 46 to 50; Strabo, xvii. p. 8, 11—16; Juvenal, xv. 38; Letronne, *Mem. de l'Inst.* ix. p. 321; Champollion, *Lettres Ecrites*, p. 260, 303; Champollion-Figeac, *L'Egypte*, 69, 291, 313—315.

OTAGO, the most populous and prosperous of the provinces of New Zealand, forms the most southern portion of Middle Island (see NEW ZEALAND). It is bounded on the north by the province of Canterbury, and on the west, east, and south by the Pacific Ocean. A considerable tract of country, naturally forming a portion of the south of this province, and formerly included with it, now forms the province of Southland (q. v.).

The province of O. is 150 miles in length, and 180 miles in breadth; area, 26,000 square miles, or about 17 million acres; pop. in 1863 (including diggers), 50,000, of whom 37,000 were males and 13,000 females; the natives number in this province about 500. The coast-line is about 400 miles in extent; the chief rivers are the Waitaki, the Clutha, and the Mataura, all of which flow south-south-east, and are navigable to a greater or less extent. The western regions of O. remain unsurveyed, but are known to be covered with high, and in many cases snow-capped mountains, stretching along the whole line of coast, and extending inland for upwards of 60 miles. East and north-east from the Mataura River to the shore the surface is well known, and consists of mountain-ranges alternating with valleys, and extending parallel to the sea and to each other as far inland as the valley of the Manuhirikia, one of the first affluents of the Clutha. The climate of O. is exceedingly healthy and invigorating; frost and snow are unknown except in the higher ranges, and rain, though sufficiently abundant to answer the demands of agriculture, does not interfere with outdoor occupations. All the English fruits and flowers, with some trifling exceptions, are grown here to perfection. The northern and interior districts of the province are eminently adapted, as regards both soil and climate, for agriculture as well as cattle-breeding. The western districts are rugged, and covered with forests; but in the eastern regions are many fertile and well-watered tracts, admirably suited for the production of corn, and the rearing of cattle and sheep. In mineral wealth the province of O. is remarkably rich. Coal, iron, copper, silver, lead, &c., have been found, and useful earths and clays are abundant. Gold has been found in small quantities in other provinces of New Zealand, as in Auckland and Nelson Province; but by far the most important gold-fields of the colony are in the province of Otago. Gold was first discovered here by Mr Gabriel Read in June 1861, in a gully, since called Gabriel's Gully, on the Tuapeka, an affluent of the Clutha, in a direct line 37 miles west of Dunedin. Read placed his discovery in the hands of government, and was presented by the Provincial Council with £500 as a reward. In less than two months from the discovery of gold, 3000 people were at work in the Tuapeka valley, and were obtaining 6000 oz. a week. From this time gold-mining became a staple employment. A 'rush' was made from Australia; Dunedin, formerly the village-capital of the province, now rapidly increased in size and trade, new fields were discovered, and the immigration-lists were immensely swelled. From June 1861 to June 1863, 700,000 oz., worth nearly £3,000,000, were obtained. The most productive gold-producing district of which, up to the present time (May 1864), we have had any notice, is the Arrow River District, in the vicinity of Lake Wakatipu. This district was made known in November 1862, and from that time to the end of October 1863, 237,655 oz.—value, £955,620—were forwarded to Dunedin by escort. In 1863, the imports amounted to £1,463,834 in value; the exports to £1,307,756; and the revenue, for the first quarter only of the same year, amounted to £113,665. The revenue for the year 1862 was close upon £400,000. In the same year there were 100,000 acres in farm-land, and the province possessed 800,000 sheep, 40,000 cattle, 7000 horses, and 3000 pigs. At the commencement of 1862, there were 8,307,200 acres occupied by sheep or cattle runs, and 968,320 acres occupied as hundreds. Gold, wool, timber, potatoes, and grain are the principal articles of export. The first band

of settlers reached the shores of O. in the spring of 1848. Capital, Dunedin (q. v.), with a pop. (in December 1861) of 6000, but which now (May 1864) must be vastly increased. O. was originally a class colony connected with the Free Church of Scotland; but the influx of immigrants consequent on the discovery of gold has obliterated its distinctive character.

OTAHEITE. See TAHITI.

OTALGIA (Gr. *ot-*, the ear, and *algos*, pain) is neuralgia of the ear. It occurs in fits of excruciating pain, shooting over the head and face, but it is not accompanied by fever, nor usually by any sensation of throbbing. Its causes and treatment are those of neuralgia generally, but it is particularly caused by caries of the teeth, which should always be carefully examined by a dentist in these cases. When patients complain of *earache*, the pain is far more commonly due to *otitis*, or inflammation of the tympanic portion of the ear, a much more serious affection.

- O'TARY (*Otaria*), a genus of the Seal family (*Phocidae*), distinguished from the rest of the family by a projecting auricle or auditory conch (often popularly called 'external ear'), and by a very remarkable character, a double cutting edge in the four middle upper incisors. The membrane which unites the toes of the hind-feet is prolonged into a flap beyond each toe. The fore-legs, as if intended exclusively for swimming, are placed further back in the body than in the true seals, giving the otaries the appearance of having a longer neck. The hind-legs are more like the fore-legs than in the true seals.—The SEA LION (*O. jubata* or *O. Stelleri*) of the northern seas is about 15 feet in

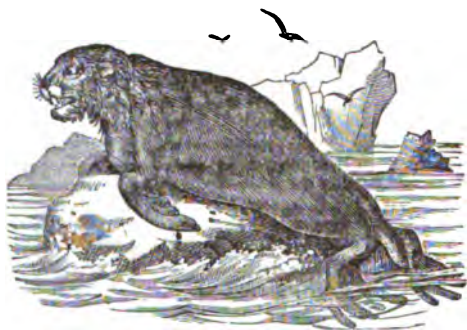

Sea Lion (*Otaria jubata*).

length, and weighs about 16 cwt. It inhabits the eastern shores of Kamchatka, the Kurile Islands, &c., and is in some places extremely abundant. It is partially migratory, removing from its most northern quarters on the approach of winter. It is to be found chiefly on rocky coasts and islet rocks, on the ledges of which it climbs, and its roaring is sometimes useful in warning sailors of danger. It is much addicted to roaring, which, as much as the mane of the old males, has obtained for it the name of sea lion. The head of this animal is large; the eyes very large; the eyebrows bushy; the hide thick; the hair coarse, and reddish; a heavy mass of stiff, curly, crisp hair on the neck and shoulders. The old males have a fierce aspect, yet they flee in great precipitation from man; but if driven to extremities, they fight furiously. Sea lions are capable of being tamed, and become very familiar with man. They are polygamous, but a male generally appropriates to himself only two or

three females. They feed on fish and the smaller seals.—The sea lion of the southern seas, once supposed to be the same, is now generally believed to be a distinct species, and, indeed, more than one species are supposed to inhabit the southern seas.—The URSINE SEAL, URSINE O., or SEA BEAR (*O. ursina*), is an inhabitant of the Northern Pacific. It is scarcely 8 feet long. The hinder limbs being better developed than in most of the seals, it can stand and walk almost like a land quadruped. The muzzle is prominent, the mouth small, the lips tumid, the whiskers long; the tip of the tongue is bifurcated, the eyes are large, the skin is thick, the hair long, erect, and thick, with a soft underclothing of wool. The food consists of sea otters, small seals, and fish. The ursine seal is polygamous, a strong male appropriating to himself from eight to fifty females. It swims with great swiftness. It is fierce and courageous. Its skin is much prized for clothing in the regions in which it abounds. As in the case of the sea lion, it is doubtful if the geographical range of the sea bear extends to the southern seas, or if it is represented there by a similar species. Several other species of *O.* are inhabitants of the Pacific and Southern Oceans. The FUR SEAL (*O. Falklandica*) is one of these. It is found on the Falkland Islands, South Shetland, &c. It is of a long and slender form, with broad head, and clothed with soft, compact, grayish-brown hair, amongst which is a very soft, brownish fur. It is gregarious and polygamous. When South Shetland was first visited, its seals had no apprehension of danger, and unsuspectingly remained whilst their fellows were slain and skinned; but they have since learned to be upon their guard. The skin of the fur seal is in great demand, chiefly for ladies' mantles, and was much used for making a kind of soft fur cap, which was very common thirty or forty years ago.

OTCHAKO'W, a small town and seaport of South Russia, in the government of Kherson, surrounded on all sides by a barren steppe, stands at the western extremity, and on the north shore, of the estuary of the Dnieper, 40 miles east-north-east of Odessa. It traces its foundation to the very earliest times, and is supposed by some to be the spot where stood the Grecian colony Olbia; by others, to be Tomi, the scene of Ovid's banishment. At the end of the 15th c., the khan of the Crimea built here a strong fortress. Its present name occurs, for the first time, in 1557. During the Russian wars with Turkey in the 18th c., O. was alternately the property of each, until it was taken by Potemkin in 1788, and definitively annexed to the Russian dominions. The vicinity of Odessa is fatal to the development of foreign commerce at its port. Pop. 5426, the greater part of whom are Jews, and are employed in salting fish for transport to Little Russia.

OTHMAN IBN AFFAN, third calif of the Moslems, was born about 574. He belonged to the family of the prophet, and was cousin-german of Abu Sofian. One of the early converts to Islam, he was one of its most zealous supporters, and linked himself still more strongly to Mohammed by becoming his son-in-law and private secretary. He was elected to succeed Omar in the califate in December 644, and a most unworthy successor he proved to be. The Moslem empire, however, continued to extend itself on all sides till the insane nepotism of O. gave its progress a sudden check. The able and energetic leaders who had been appointed by Omar were superseded by members of his own family, and of that of Abu Sofian; and the consequences were what might have been

expected. Egypt revolted, and the calif was compelled to reinstate Amru in the government of that country, and several other rebellions were only quelled by a similar restoration of the previous governors. Zealous Moslems deeply deplored the folly of their chief, and were indignant at seeing the chair of the prophet occupied by O., while Abu-bekr, and even Omar, were accustomed to seat themselves two steps below it. Emboldened by the knowledge of his vacillating and cowardly disposition, they showered upon him reproaches and menaces; but the bearer of their remonstrances having been bastinadoed by O.'s order, a general revolt ensued. O. averted the crisis by unconditional submission; but having soon after attempted to put to death Mohammed, the son of the Calif Abu-bekr, the latter made his appearance at Medina at the head of a troop of malcontents, and forcing his way to the presence of O., stabbed him to the heart. O. was of a mild and pacific disposition, but he was at the same time most ambitious of power, though after his accession to supreme authority, he shewed himself to be, either from age or natural imbecility, deplorably deficient in those energetic virtues, without which the control of a warlike people and the management of a mighty empire such as that of the Moslems, were utterly impossible. O. was the first to cause an authentic copy of the Koran to be composed.

**OTHMAN, OTHOMAN, or OSMAN I.**, surnamed *Al-ghazi* ('the conqueror'), the founder of the Turkish power, was born in Bithynia in 1259. His father, Orthogrul, the chief of a small tribe of Ogúzian Turks, had entered the service of Alladed-din Kaikobad, the Seljuk sultan of Iconium, and had rendered important services to that monarch and his successors in their wars with the Byzantines and Mongols. Orthogrul dying in 1289, after a rule of more than half a century, his tribe chose his son Osman (i. e., the 'young bastard,') as his successor. O. trod in his father's footsteps; and on the destruction of the sultanate of Iconium in 1299 by the Mongols, succeeded in obtaining possession of a portion of Bithynia. He had previously subjugated many of the neighbouring Oguzian chiefs, and this new accession of territory rendered him powerful enough to attack the Byzantines with success. In July 1299, he forced the passes of Olympus, and took possession of the whole territory of Nicaea, with the sole exception of the town of that name, which resisted his efforts for five years longer. In 1301, he defeated the Emperor Andronicus II. at Baphaeon; in 1307, he incorporated the province of Marmara in his dominions; and continued till his death, in 1326, steadily to pursue his plans of conquest. 'Othman,' says Knolles, 'was wise, politic, valiant, and fortunate, but full of dissimulation, and ambitious above measure; not rash in his attempts, and yet very resolute; to all men he was bountiful and liberal, especially to his men of war and to the poor. Of a poor lordship, he left a great kingdom (Phrygia, Bithynia, and the neighbouring districts), having subdued a great part of Asia Minor, and is worthily accounted the first founder of the Turks' great kingdom and empire.' O. assumed the title of sultan (though this is denied by many historians) on the extinction of the Iconium sultanate in 1299, held his court at Kara-Hissar, and struck money in his own name. From him are derived the terms Ottomans, Othomans, and Osmanli or Osmanlı, which are employed as synonymous with Turks. See OTTOMAN EMPIRE.

**OTHO, MARCUS SALVIUS**, Roman emperor, was descended of an ancient Etruscan family, and was born 32 A. D. He was a favourite companion of

Nero, who appointed him governor of Lusitania, in which office he acquitted himself creditably. On the revolt of Galba against Nero, O. joined himself to the former; but being disappointed in his hope of being proclaimed Galba's successor, he marched at the head of a small band of soldiers to the forum, where he was proclaimed emperor, and Galba was slain, 69 A. D. O. was recognised as emperor over all the Roman possessions, with the exception of Germany, where a large army was stationed under Vitellius. The first few weeks of his reign were marked by an indulgence towards his personal enemies, and a devotion to business, which, though at total variance with his usual habits, excited in the minds of his subjects the most favourable hopes. But the tide of rebellion raised in Germany by Valens and Cæcina during the reign of Galba had by this time gathered strength, and these commanders having prevailed upon Vitellius, who had become a mere good-humoured glutton, to join his forces to theirs, the combined army poured into Italy. O. fortunately possessed several able generals, who repeatedly defeated the rebels; but the prudence of some among them in restraining the enthusiasm of their troops, who wished further to follow up their victories, was unfortunately considered as cowardice or treason, and produced dissensions in O.'s camp. This state of matters becoming known to the generals of Vitellius, encouraged them to unite their armies, and fall upon the forces of Otho. An obstinate engagement took place near the junction of the Adda and the Po, in which the army of O. was completely routed, and the relics of it went over on the following day to the side of the victor. O., though by no means reduced to extremity, resolved to make no further resistance; settled his affairs with the utmost deliberation; and then stabbed himself, on the 15th of April 69 A. D.

**OTHO I.**, or the Great, son of the Emperor Henry I. of Germany, was born in 912, and after having been early recognised as his successor, was, on the death of his father in 936, formally crowned king of the Germans. His reign was one succession of eventful and generally triumphant wars, in the course of which he brought many turbulent tribes under subjection, acquired and maintained almost supreme power in Italy, where he imposed laws with equal success on the kings of Lombardy and the popes at Rome, consolidated the disjointed power of the German emperors, and established Christianity at many different points in the Scandinavian and Slavonic lands, which lay beyond the circuit of his own jurisdiction. His earliest achievement was a successful war against the Bohemian Duke Boleslas, whom he reduced to subjection, and forcibly converted to Christianity; next, the Dukes of Bavaria and Franconia were compelled to succumb to his power; the former paying the penalty of his opposition to O. by defeat and death in battle, and the latter by the confiscation of his territories, which, together with the other lapsed and recovered fiefs of the empire, were bestowed on near and devoted relatives of the conqueror. After subduing the Slavi of the Oder and Spree, for whose Christian regeneration he founded the bishoprics of Havelburg and Brandenburg, driving the Danes beyond the Eyder, compelling their defeated king to return to the Christian faith and do homage to himself; and after founding, at the suggestion of his mother's former chaplain, Adeldag, the bishoprics of Aarhus, Ribe, and Slesvig, which he decreed were for ever to be free from all burdens and imposts, he turned his attention to the affairs of Italy. Here he presented himself as the champion of the beautiful Adelheid, the widow of the murdered King Lothaire; and having defeated her unfortunate suitor, Berengar II. (q. v.),



married her, and assumed supreme power over the north of Italy in 951. The wars to which this measure gave rise, obliged O. frequently to cross the Alps; but at length, after a great victory gained over the Huns in 955, and the defeat and capture of Berengar, O. was acknowledged king of Italy by a diet held at Milan; and after being crowned with the iron crown of Lombardy, was, in 962, recognised by Pope John XII. as the successor of Charlemagne, and crowned Emperor of the West at Rome. O. lost no time in asserting his imperial prerogatives; and having called a council, effected the deposition of John, whose licentiousness had become a burden to Italy and a scandal to Christendom, and caused Leo VIII. to be elected in his place. Fresh wars were the result of this step. Popes and anti-popes distracted the peace of Rome; but through all these disorders, O. maintained the supremacy which he claimed as Emperor of the West, in regard to the election of popes and the temporal concerns of the Roman territories. His later years were disturbed by domestic differences; for his elder son, Ludolph, and his son-in-law, Konrad of Lorraine, having risen in rebellion against him, through jealousy of his younger son and intended successor, Otho, the empire was distracted by civil war. Although the war terminated in the defeat of the rebels, and the recognition of young Otho as king of the Germans, and his coronation at Rome, in 967, as joint-emperor with his father, O.'s favourite scheme of uniting the richly-dowried Greek princess, Theophania, with the young prince, met with such contempt from the Greek emperor, that his outraged pride soon again plunged him into war. His inroads into Apulia and Calabria, however, proved convincing arguments in favour of the marriage, and Theophania became the wife of young Otho, with Calabria and Apulia for her dowry. O. died at Minleben, in Thuringia, in 973, and was buried at Magdeburg, leaving the character of a great and just ruler, who had extended the limits of the empire, and restored the prestige of the imperial power more nearly to the stand which it occupied under Charlemagne than any other emperor. He created the duchy of Carinthia, and the margravdoms of East and North Saxony; appointed counts-palatine; founded cities and bishoprics; and did good service to the empire, in reorganising the shaken foundations of its power in Europe. See *Vehse's Leben Kaiser O.'s des Grossen* (Dresd. 1827).

OTHO II., surnamed *Rufus*, 'the Red,' son of Otho I., was born in 955, and succeeded his father in 973. For a time, O. was content to rule under the regency of his mother, the Empress Adelheid; but differences having arisen between them, through the headstrong and ambitious inclinations of the young monarch, his mother withdrew from all share in the administration, and left him to the exercise of his own will, which soon brought him into collision with the great vassals of the crown. Civil war broke out under the leadership of Henry II. of Bavaria, who formed a secret alliance against the young emperor with Harald, king of Denmark, and Miciaslav of Poland, and for a time fortune inclined to the side of the rebels; but O.'s astuteness circumvented their designs, and after defeating Henry, and depriving him of his duchy, he marched against the Danish king, who had been making successful incursions into Saxony. O.'s first attack on the Dannevirke having proved of no avail, he retired, vowing that he would return before another year, and force every Dane to forswear paganism. O. kept his promise, returning to the attack the following year, when, according to the old chroniclers, acting by the advice of his ally, Olaf Trygvesson of

Norway, he caused large quantities of trees, brushwood, and stubble to be piled up against the Dannevirke, and set on fire, and this drove away the defenders, and destroyed their fortifications. The defeated Harold was soon overpowered by the superior numbers of the Germans, and compelled to receive baptism, as the badge of his defeat. The next scene of war was Lorraine, which the French king, Lothaire, had seized as a former appanage of his crown; but here, after a partial defeat, O. succeeded in reasserting his power; and not content with this advantage, devastated Champagne, pursued and captured Lothaire, and advanced upon Paris, one of the suburbs of which he burned. Scarcely was this war ended, when the disturbed condition of Italy called O. across the Alps. His presence put a stop to the insurrection at Milan and Rome, where he re-established order; and having advanced into Lower Italy, he defeated the Saracens, drove back the Greeks, and having re-established his supremacy in Apulia and Calabria, which he claimed in right of his wife, Theophania, made himself master of Naples and Salerno, and finally of Tarentum, in 982. The Greek emperor, alarmed at the successful ambition of O., called the Saracens again into Italy, who gave him battle with overwhelming numbers. The result was the total defeat of the emperor, who only escaped from the hands of the victors by plunging with his horse into the sea, and swimming, at the risk of his life, to a ship. Unluckily, it was a Greek ship, and O. was virtually a prisoner; but as the vessel neared Rossano, a friendly port, he contrived to escape by a cunning stratagem. O. now hastened to Verona, where a diet was held, which was numerously attended by the princes of Germany and Italy, and at which his infant son, Otho, was recognised as his successor. This diet is chiefly memorable for the confirmation by O. of the franchises and privileges of the republic of Venice, and the enactment of many new laws, which were added to the celebrated Longobard code. O.'s death at Rome, at the close of the same year, 983, arrested the execution of the vast preparations against the Greeks and Saracens, which had been planned at the diet of Verona, and left the empire embroiled in wars and internal disturbances. See Giesebrecht's *Jahrbücher des Deutschen Reichs unter der Herrschaft, Kaiser O.'s II.* (Berl. 1840).

OTHO III., who was only three years old at his father's death, was at once crowned king of the Germans at Aix-la-Chapelle in 983, from which period till 996, when he received the imperial crown at Rome, the government was administered with extraordinary skill and discretion by three female relatives of the boy-king—viz, his mother, Theophania; his grandmother, Adelheid; and his aunt, Matilda, Abbess of Quedlingburg, who, in conjunction with the learned Willgis, Archbishop of Mainz, directed his education. The princes of the imperial family disputed the right of these royal ladies to the custody of the young king; and Henry of Bavaria, the nearest agnate, having seized the person of O., tried to usurp the supreme power; but opposed by the majority of the other princes of the empire, he was compelled to release him, in consideration of receiving back his forfeited duchy. O. early shewed that he had inherited the great qualities of his forefathers, and when scarcely fifteen years of age, at the head of his army, defeated the troops of the patrician Crescentius, the self-styled consul of Rome, and thus restored order in the Roman territories. In 996, he was crowned emperor by his relative, Gregory V.; and having settled the affairs of Italy, returned to Germany, where he defeated the Slaves, who had long carried on war against the empire;

and having forced Miciślav, Duke of Poland, to do him homage, he subsequently raised the Polish territories to the rank of a kingdom, in favour of Miciślav's successor, Boleslas. The renewed rebellion of Crescentius, who drove Gregory from the papal throne, compelled O. to return to Italy, where success, as usual, attended his measures. Crescentius, who had thrown himself into St Angelo, was seized and beheaded, together with twelve of his chief adherents; the anti-pope, John XVI., imprisoned; Gregory restored; and on the speedy death of the latter, O.'s old tutor, Gherbert, Archbishop of Ravenna, raised to the papacy under the title of Sylvester II. O., elated with his success, took up his residence in Rome, where he organised the government, erected new buildings, and shewed every disposition, notwithstanding the ill-concealed dissatisfaction of the Romans, to convert their city into the capital of the western empire. The near approach of the year 1000, to which so many alarming prophecies were then believed to point as the end of the world, induced O. to undertake a pilgrimage to the Holy Land, where he founded an archbishopric. On his return, after visiting Charlemagne's grave at Aix-la-Chapelle, and removing the consecrated cross, suspended from the emperor's neck, he again repaired to Rome, to consolidate his schemes of establishing a Roman empire. The insurrection of the Romans frustrated his plans, and escaping from Rome at the risk of his life, he withdrew to Ravenna, to await the arrival of powerful reinforcements from Germany; but before they had crossed the Alps, O. died in 1002, at the age of 22, apparently from poison, which was said to have been administered to him by the widow of Crescentius, who, it is said, had deliberately set herself to win his affections that she might have an opportunity of avenging the death of her husband; and with him the male branch of the Saxon imperial House became extinct. See Wilman's *Jahrbücher des Deutschen Reichs unter Kaiser Otto III.* (Berl. 1840).

OTHO I., second son of Ludwig, king of Bavaria, was born at Salzburg, 1st June 1815, and on the erection of Greece into a kingdom in 1832, was appointed by the protecting powers king of Greece. Till he attained his majority, the government was intrusted to a regency, which was unable to suppress internal disorder, or counteract the diplomatic intrigues of foreign powers. On assuming the government in 1835, O. transferred the court from Nauplia to Athens, and passed into law several important measures, which afforded the most lively satisfaction to his subjects. During a visit to Germany in 1836, he married the Princess Amalie of Oldenburg. A monetary crisis, provoked partly by false administrative measures, and partly by too prompt demands for repayment on the part of the protecting powers, threw the affairs of Greece into confusion, and materially weakened the king's popularity. A national reaction against the Germanising tendencies of the court followed, and resulted in 1843 in a military revolution, which was suppressed. O. now attempted to soothe the general discontent by taking the oath to the new constitution of March 30, 1844, but his efforts were only partially successful. Though the Bavarian ministers were dismissed, the king and his Greek advisers shewed the most reactionary tendencies, and attempted in various ways to curtail the privileges which the new constitution had conferred on the people. The equivocal position in which he was placed, in 1853, between the allied powers on the one hand, and his subjects, whose sympathies were strongly in favour of Russia, on the other, greatly increased the difficulties of his situation. The occupation of the Piræus by Anglo-French

troops enabled him to restrain the enthusiasm of his subjects; but after their withdrawal in 1857, he was obliged to adopt severe measures against the frontier brigands. His council, too, was composed of men unable or unwilling to support him, and his position became year by year more and more difficult. The strong pro-Russianism of the queen rendered her for some time a favourite; but the belief that O.'s absolute measures were due to her instigation, turned the tide of popular hatred so strongly against her, that attempts were made on her life. The general discontent at last found vent in insurrections at Nauplia and Syra in 1862, which were soon suppressed. A more formidable insurrection in the districts of Missolonghi, Acarnania, Elis, and Messenia, having for its object the expulsion of the reigning dynasty, broke out in October of the same year, and in a few days extended to the whole of Greece. O. and his queen fled to Salamis, from which place he issued a proclamation declaring that he quitted Greece to avoid the effusion of blood, and a provisional government was then established. This government, in February 1863, resigned its executive power to the National Assembly, which confirmed its acts, and decreed that Prince Alfred of England had been duly elected king of Greece. On the refusal of this prince to accept the throne, their choice fell on Prince William of Slesvig-Holstein-Sonderburg-Glücksburg, the second son of Christian IX., king of Denmark, who, under the title of George I., King of the Hellenes, in September 1863, assumed the functions of royalty. O. is at present living at Munich.

OTITIS, or inflammation of the tympanic cavity of the ear, may be either acute or chronic, and it may come on during the course of certain febrile affections, especially scarlatina, or in consequence of a scrofulous, rheumatic, or gouty constitution; or it may be excited by direct causes, as exposure to currents of cold air, violent syringing or probing, &c. The symptoms of the acute form are sudden and intense pain in the ear, increased by coughing, sneezing, or swallowing, *tinnitus aurium*, or singing or buzzing noises heard by the patient, and more or less deafness. If the disease goes on unchecked, suppuration takes place, and the membrane of the tympanum ulcerates, and allows of the discharge of pus, or inflammation of the dura mater and abscesses in the brain may be established. In less severe cases there is usually a considerable amount of persistent damage, and an obstinate discharge of matter (*otorrhœa*) is a frequent sequæ of the disease.

The treatment of so serious an affection must be left solely in the hands of the medical practitioner.

The symptoms of the chronic and less acute varieties of otitis are unfortunately so slight, that they are often neglected, until the patient finds the sense of hearing in one or both ears almost completely gone. In these milder forms of otitis, the general indications of treatment are to combat the diathesis on which they frequently depend, and to improve the general health. Very small doses of mercury continued for a considerable time (such as one grain of gray powder night and morning), and small blisters occasionally applied to the nape of the neck or to the mastoid process, are often of service in very chronic cases. If there is any discharge, the ear should be gently syringed once or twice a day with warm water, after which a tepid solution of sulphate of zinc (one grain to an ounce of water) may be dropped into the meatus, and allowed to remain there two or three minutes.

OTLEY, a small market town of England, in the West Riding of Yorkshire, on the right bank of

the Wearie 29 miles west-south-west of York. Its parish church, built in 1507, has a plain Norman arch over the north door. Extensive cattle and grain markets are held here. There is a worsted, a paper, and a flour mill in the town. Pop. (1864) 4973.

OTORRHŒA signifies a purulent or mucopurulent discharge from the external ear. It may be due to various causes, of which the most frequent is catarrhal inflammation of the lining membrane of the meatus, and the next in frequency is Otitis (q. v.) in its various forms. If the discharge is very fetid, a weak solution of chloride of lime, or of Condy's Disinfectant Fluid, may be used, in place of the solution of sulphate of zinc recommended in article OTITIS; and in obstinate cases of catarrhal inflammation of the lining membrane, the discharge may often be checked by pencilling the whole interior of the meatus with a solution of five grains of nitrate of silver in an ounce of water.

OTRANTO, TERRA DI, the extreme south-eastern province of Italy, forming the heel of the Italian boot, is bounded on the north-west by the provinces of Bari and Basilicata, and surrounded on all other sides by the sea. Area, 3293 square miles; pop. (1862) 447,982. It occupies the ancient Iapygian or Messapian peninsula, and is 102 miles in length, and from 25 to 35 miles in breadth. Three parts of its surface are covered with hills, offsets from the Apennines of Basilicata. All the rivers are short, many of them being lost in the marshes of the interior; but abundant springs and heavy dews render the soil surprisingly fertile. Good pasturelands and dense forests occur. The climate is pleasant and healthy, except along the shores, both on the east and west coasts, and in the vicinity of the marshes, which in summer generate malaria. An abundance of the best wine, with corn and olive-oil, are produced; tobacco (the best grown in Italy), cotton, and figs, almonds, oranges, &c., are also produced. The capital is Lecce (q. v.).

OTRANTO (the ancient *Hydruntum*), a small town on the south-east coast of the province of the same name, 24 miles south-east of Lecce. During the latter period of the Roman empire, and all through the middle ages, it was the chief port of Italy on the Adriatic, whence passengers took ship for Greece—having in this respect supplanted the famous Brundisium of earlier times. In 1480, it was taken by the Turks, and at that time it was a flourishing city of 20,000 inhabitants; but it has long been in a decaying condition, principally on account of malaria. O. possesses a castle and a cathedral. Its harbour is unsafe. In clear weather, the coast of Albania is visible from Otranto. Pop. about 2000.

O'TTAWA, one of the largest rivers of British North America, rises in lat. 48° 30' N., long. 76° W., in the watershed on the opposite side of which rise the St Maurice and Saguenay. After a course of above 600 miles, it falls into the St Lawrence by two mouths, which form the island of Montreal; and the entire region, drained by it and its tributaries, measures about 80,000 square miles (*Geol. Rep.* for 1845—1846, p. 13). During its course, it widens into numerous lakes of considerable size, and is fed by many important tributaries, such as the Mattawa, Mississippi, Madawasca, and Rideau on the right, the Gatineau and the Rivières du Moine and du Lièvre on the left side. These, with the O. itself, form the means of transit for perhaps the largest lumber-trade in the world, while the clearances of the lumberer have opened the country for several thriving agricultural settlements. The navigation has been greatly improved,

especially for timber, by the construction of dams and slides, to facilitate its passage over falls and rapids. The O. is already connected with Lake Ontario at Kingston by the Rideau Canal; and there is every prospect of its becoming, before many years, the great highway from the north-western states to the ocean by being connected with the Georgian Bay in Lake Huron through the French River, Lake Nipissing, and the Mattawa. This great engineering achievement, for which capital will undoubtedly be soon forthcoming, would place the western lake-ports by water 760 miles nearer to Liverpool by Montreal than by New York through the Erie Canal, and would save nearly a week in time, while it would lessen considerably insurance and freight charges.—The O. possesses one of the few literary associations of Canada. At St Ann's, a few miles above its mouth, the house is pointed out where Moore wrote the Canadian Boat-song—

'Soon as the woods on shore look dim,  
We'll sing at St Ann's our parting hymn.

Ottawa's tide, this trembling moon  
Shall see us afloat on thy waters soon.'

OTTAWA, the capital of the United Canada, is situated 87 miles above the confluence of the river Ottawa with the St Lawrence, 128 miles from Montreal, 95 from Kingston, and 450 from New York. Originally called Bytown, after Colonel By, who in 1827 was commissioned to construct the Rideau Canal, it was incorporated as a city, and received the name which it now bears in 1854. At the west end of the city, the Ottawa rushes over the magnificent cataract known as the Chaudière Falls; and at the north-east end there are other two cataracts, over which the Rideau tumbles into the Ottawa. The scenery around O. also is scarcely surpassed by any in Canada. The immense water-power at the city is made use of in several saw-mills, which give O. its principal trade, and issue almost incalculable quantities of sawn timber. A suspension-bridge hangs over the Chaudière Falls, connecting Upper and Lower Canada. The city is in communication by steamer on the Ottawa with Montreal; on the Rideau Canal with Lake Ontario at Kingston; and with the Grand Trunk Railway by a branch line from Prescott. As yet, there is nothing in the city remarkable for architecture; but the provincial Parliament Houses, which are approaching completion, will probably be the finest buildings on the American continent. The population, which is rapidly increasing, in 1861 reached 14,669. O. returns one member to the provincial parliament.

OTTER (*Lutra*), a genus of quadrupeds of the Weasel family (*Mustelidae*), differing widely from the rest of the family in their aquatic habits, and in a conformation adapted to these habits, and in some respects approaching to that of seals. The body, which is long and flexible, as in the other *Mustelidae*, is considerably flattened; the head is broad and flat; the eyes are small, and furnished with a *nictitating membrane*; the ears are very small; the legs are short and powerful; the feet, which have each five toes, are completely webbed; the claws are not retractile; the tail is stout and muscular at its base, long, tapering, and horizontally flattened; the dentition is very similar to that of weasels; six incisors and two canine teeth in each jaw, with five molars on each side in the upper, and five or six in the lower jaw; the teeth very strong, and the tubercles of the molars very pointed, an evident adaptation for seizing and holding slippery prey. The tongue is rough, but not so much so as in the weasels. The fur is very smooth, and consists of two kinds of hair—an inner fur very dense and soft,

intermixed with longer, coarser, and glossy hair. The species are numerous, and are found both in warm and cold climates.—The COMMON O. (*L. vulgaris*) is a well-known British animal, rarer than it once was in most districts, but still found in almost every part of the British Islands, and common also throughout the continent of Europe, and in some parts of Asia. It often attains a weight of 20 to 24 lbs. Its length is fully 2 feet, exclusive of the tail, which is about 16 inches long. The colour is a bright rich brown on the upper parts and the outside of the legs, being the colour of the tips of the long hairs, which are gray at the base; the tips of the hairs in the soft inner fur are also brown, the base whitish-gray; the throat, cheeks, breast, belly, and inner parts of the legs are brownish-gray, sometimes whitish, and individuals sometimes, but rarely, occur with whitish spots over the whole body; the whiskers are very thick and strong; the eyes are black. The O. frequents rivers and lakes, inhabiting some hole in their banks, generally choosing one which already exists, and seldom, if ever, burrowing for itself. It also inhabits the sea-shore in many places, and swims to a considerable distance from the shore in pursuit of prey. Its movements in the water are extremely graceful; it swims with great rapidity in a nearly horizontal position, and turns and dives with wonderful agility. Its prey consists chiefly of fish, and, like the other *Mustelida*, it seems to take pleasure in pursuing and killing far more than it is able to eat; and in this case it daintily feeds on the choicest part, beginning behind the head of the fish, and leaving the head and often much of the tail part. The O., however, when fish cannot readily be obtained, satisfies the cravings of hunger with other food, even snails and worms, and attacks

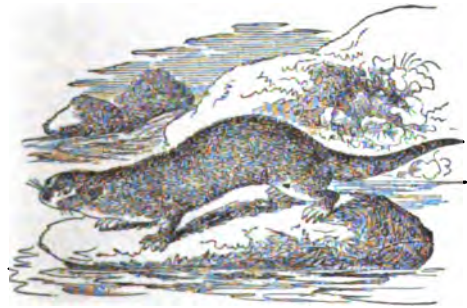

Otter (*Lutra vulgaris*).

small animals of any kind, sometimes making depredations in places far from any considerable stream. The O. produces from two to five young ones at a birth. The flesh of the O. has a rank fishy taste, on which account, perhaps, it is sometimes used in the Roman Catholic Church, as fish, by those whose rules forbid them the use of flesh.—O. hunting has long been a favourite sport in Britain, although now chiefly confined to Wales and Scotland. Hounds of a particular breed—O. Hounds—are preferred for it.—The O. defends itself with great vigour against assailants. The O. can be easily domesticated, and trained to catch fish for its master. In India, tame otters—probably, however, of another species to be afterwards noticed—are not unfrequently used both for catching fish, which they bring ashore in their teeth, and for driving shoals of fish into nets.—The fur of the O. is in some request, but more on the continent of Europe than in Britain.—The AMERICAN O. or CANADA O. (*L. Canadensis*) is very like the Common

O., but considerably larger. The tail is also shorter, and the fur of the belly is almost of the same shining brown colour with that of the back. This species is plentiful in the northern parts of North America. Its skin is a considerable article of commerce, and after being imported into England, is often exported again to the continent of Europe. It is usually taken by a steel-trap, placed at the mouth of its burrow. Its habits are very similar to those of the O. of Europe.—The INDIAN O. (*L. Nair*), has a deep chestnut-coloured fur, and yellowish-white spots above the eyes.—The Brazilian O. (*L. Braziliensis*) is said to be gregarious.—Somewhat different from the true otters is the SEA O. or KALAN (*L. marina*, or *Enhydra lutris*), an animal twice the size of the Common O., a native of Behring's Straits and the neighbouring regions, frequenting sea-washed rocks. There are, at least in the adult, only four incisors in the lower jaw, and the ears are set lower in the head than in the true otters, below, not above, the eyes. The tail is also much shorter. The molar teeth are broad, and well adapted for breaking the shells of molluscs and crustaceans. The hind-feet have a membrane skirting the outside of the exterior toes. The sea O. is much valued for its fur, the general hue of which is a rich black, tinged with brown above, and passing into lighter colours below. The head is sometimes almost white. The skins of sea otters were formerly in very great request in China, so that a price of from £35 to £50 could be obtained for each; but the attention of European traders and hunters having been directed to them—in consequence chiefly of a passage in *Cook's Voyages*—they were carried to China in such numbers as greatly to reduce the price.

O'TTERBURN, BATTLE OF. See CHEVY CHASE.  
OTTO or ATTAR OF ROSES. See PERFUMES and ROSE.

OTTOMAN EMPIRE, or 'Empire of the Osmanlis,' comprehends all the countries which are more or less under the authority of the Turkish sultan, and includes, besides Turkey in Asia, and that part of Turkey in Europe which is under his immediate sovereignty, the vassal principalities of Moldavia and Walachia, Servia, and Montenegro, in Europe; Egypt with Nubia, Tripoli, and Tunis, in Africa; and a part of Arabia, including the holy cities of Mecca and Medina, in Asia. The special description, topography, history, &c., of these countries will be found under their own heads, and this article will consist solely of a brief sketch of the origin, growth, and present state of the Ottoman Empire.

The Ottomans, or Osmanlis, to whom the generic epithet of *Turks* is by common usage now confined, are the descendants of the Ogūzian Turks, a tribe of the great Turkish nation, which in the 13th c. inhabited the steppes east of the Caspian Sea. The tide of Mongol invasion which was then setting in from the north-east, swept the Ogūzes before it, and they, to the number of 50,000, under their chief, Suliman, fled westward to the mountainous region of Armenia. After the chief's death, the majority of the tribe became scattered over Mesopotamia; but a few thousands under Orthoguel, his youngest son, marched westward to aid the Seljuk sultan of Konieh against the Khaurezmians and Mongols, and received from the grateful monarch a grant of land in Phrygia.—His son, ORTHMAN (q. v.) (1289—1326), laid the foundation of the independent power of the Turks; and Othman's son and successor, ORKHAN (1326—1359) continued the same aggressive policy, and gained a footing in Europe by the taking of Gallipoli, Koiridicastron, and other

fortresses on the coast. The Greeks, with the usual contempt of civilisation for barbarism, made light of these losses, saying that the Turks had only taken from them a 'hog's sty' and a 'pottle of wine,' in allusion to the magazines and cellars built by Justinian at Gallipoli; but, as the historian Knolles quaintly remarks, 'by taking of such hogsties and pottles of wine, the Turks had gone so far into Thracia, that Amurath, a few years later, placed his royal seat at Adrianople.' Sultan Orkhan, perceiving the advantage of possessing a force trained exclusively for war, organised the body of troops known as Janizaries (q. v.), and to these his successor added the Spahis (q. v.) and the Zanis.—AMURATH I. (1359—1390), the successor of Orkhan, rapidly reduced the Byzantine empire within the limits of Constantinople and some neighbouring districts in Thrace and Bulgaria. A formidable confederacy of the Slavonian tribes of the Upper Danube was formed against him, and, supported by multitudes of warriors from Hungary and Italy, they advanced into Servia to give him battle; but their army, amounting, it is said, to 500,000 men, was defeated with dreadful slaughter at Kosova (1390); and though the sultan was assassinated on the eve of the battle, his son, BAJAZET I. (q. v.) (1390—1402), followed up this victory by ravaging Servia and Walachia. Moldavia was also overrun, and a second crusading army, under the king of Hungary, totally routed at Nicopolis (1396); but the defeat and capture of the sultan by Timur (q. v.), gave Constantinople a respite for half a century, by raising up numerous claimants for the Turkish throne; and it was not till 1413 that Bajazet's youngest son, MOHAMMED I. (1413—1422), established his claim to the sceptre. A war which broke out with the Venetian republic at this time produced the most disastrous consequences to the mercantile and maritime interests of the Turks, and internal disorders prevented any aggressions on their neighbours.—AMURATH II. (1422—1450), a prince of considerable ability, completed the conquest of the Greek empire by reducing Macedonia and Greece Proper; and finding that the Hungarians had concluded a secret treaty of offence and defence with the Turkish sultan of Caramania against him, he attacked the former, but was defeated by Hunyady (q. v.), and compelled to retreat. Disheartened at his ill success, he resigned the throne; but on receiving news of a formidable invasion by the army of the papal crusade, resumed the direction of affairs, and totally defeated the invaders, with whom were Hunyady (q. v.) and Scanderbeg (q. v.), at Varna (1444).—MOHAMMED II. (q. v.) (1450—1481), the sworn foe of Christianity, greatly enlarged the Turkish territories. It was he who stormed Constantinople in 1453, and destroyed the last relic of the empire of the Cæsars.—His son, BAJAZET II. (1481—1512), extended his dominions to the present limits of the Turkish empire in Asia and Europe, including, however, also the country to the north of the Black Sea, as far east as the mouth of the Don, portions of Dalmatia, and Otranto in Italy. Bajazet was the first to feel the evil effects of the military organisation of Sultan Orkhan, but all his attempts to get rid of his formidable soldiery were unsuccessful. He attempted the invasion of Egypt, but was totally defeated by the Mameluke sultan at Arbela (1493).—His successors, SELIM I. (q. v.) (1512—1520), and SOLYMAN I. (q. v.), (1520—1566), raised the O. E. to the height of its power and splendour. During their reigns, no ship belonging to a nation hostile to the Turks dared then navigate the Mediterranean, so completely did their fleets command that sea.—SELIM II. (1566—1574), a pacific prince, put an

end to a war with Austria, which had been commenced in the previous reign, by a peace in which it was stipulated that the Emperor Maximilian II. should pay a tribute of 30,000 ducats annually for the possession of Hungary, and that each nation should retain its conquests. During his reign, occurred the first collision of the Turks with the Russians. It had occurred to Selim, that the connection of the Don and Volga by a canal would, by allowing the passage of ships from the Black Sea into the Caspian, be a valuable aid to both military and commercial enterprise, and accordingly he sent 5000 workmen to cut the canal, and an army of 80,000 men to aid and protect them. But, unluckily, the possession of Astrakhan formed part of the programme, and the attack of this town brought down on the Turks the vengeance of the Russians, a people till then unknown in Southern Europe, and the projected canal-scheme was nipped in the bud. The rest of this sultan's reign was occupied in petty wars with Venice, Spain, and his rebellious feudatory of Moldavia.—His son, AMURATH III. (1574—1595), such was then the prestige of the Turks, dictated to the Poles that they should choose as their king, Stephen Batory, Waivode of Transylvania; and received the first English embassy to Turkey in 1589, the object of the embassy being to conclude an alliance against Philip II. of Spain. To this the sultan agreed; but the destruction of the Spanish Armada soon after rendered his interference unnecessary. After an exhausting, though successful war with Persia, succeeded a long contest with Austria, in which the Turks at first obtained the most brilliant success, penetrating to within 40 miles of Vienna, but afterwards suffered such terrible reverses, that they were compelled to evacuate all Hungary and Transylvania (hitherto a feudatory), and were only saved from destruction by the Poles, who entered Moldavia, and drove out the Transylvanians and Hungarians, thus affording the Turks an opportunity of rallying, and even recovering some of their losses. The latter part of this war happened during the reign of MOHAMMED III. (1595—1604), and afforded unmistakable symptoms of the decline of Turkish prowess; and a rebellion of the Pasha of Caramania, in Asia, which was quelled not as a Mohammed II. or a Bajazet I. would have quelled it, but by yielding to the pasha's demands, afforded an equally convincing proof of the growing weakness of the central administration, and set an example to all ambitious subjects in future. During the reigns of ACHMET I. (1604—1617), MUSTAFA (1617—1617, 1622—1623), OTHMAN II. (1617—1622), and AMURATH IV. (1623—1640), Turkey was convulsed by internal dissensions, nevertheless, a successful war was waged with Austria for the possession of Hungary; but this success was more than counterbalanced in the East, where Shah Abbas the Great conquered Mesopotamia, Kurdistan, and Armenia; and in the north, where the Poles took possession of some of the frontier fortresses. While Amurath was recovering his lost provinces in the East, the Khan of the Crimea, countenanced by the Poles and Russians, threw off his allegiance. Mustafa, the grand vizier, a man of great ability and integrity, continued to direct the helm of government under IBRAHIM (1640—1648); took from the Poles their conquests; and in a war with the Venetians (1645), obtained Candia and almost all the Venetian strongholds in the Ægean Sea, though with the loss of some towns in Dalmatia.—MOHAMMED IV. (1648—1687) commenced his reign under the most unfavourable auspices; he was only seven years of age, and the whole power was vested in the Janizaries and their partisans, who

used it to accomplish their own ends; but luckily for Turkey, an individual of obscure birth, named Mohammed Köprili, supposed to be of French descent, was, when over seventy years of age, appointed vizier; and the extraordinary talents of this man proved to be the salvation of Turkey at this critical juncture. He was succeeded (1661) in office by his son, Achmet, who, to equal ability, added the fiery and thorough-going energy of manhood in its prime; and under his guidance the central administration recovered its control over even the most distant provinces; a formidable war with Germany, though unsuccessfully carried on (1663), was concluded by a peace advantageous to the Turks; Crete was wholly subdued, and Podolia wrested from the Poles, together with the strong fortress of Kaminiac; though, shortly afterwards, much of this last acquisition was reconquered by John Sobieski (q. v.). Achmet's successor as vizier was Kara Mustafa, a man of little ability, who, however, overran the Austrian territories at the head of a large army and laid siege to Vienna; but the siege was raised, and his army defeated, by a combined German and Polish army under the Duke Charles of Lorraine, and John Sobieski, king of Poland. The Austrians followed up this victory by repossessing themselves of Hungary, inflicting upon the Turks a bloody defeat at Mohacz (1687); but their extravagant demands prevented the sultan from concluding a treaty, and the fortunate appointment of a third Köprili as grand vizier by SOLTMAN II. (1687—1691), was the means of restoring glory and fortune to the Turkish arms.—The reigns of ACHMET II. (1691—1695), and MUSTAFA II. (1695—1702), were occupied with wars against Austria; but with the death of Köprili (1691) at Salankement in the moment of victory, fortune deserted the Turks, and the war was closed by the peace of Carlowitz (q. v.) (1699), which for ever put an end to Turkish domination in Hungary.—ACHMET III. (1702—1730) wisely avoided involving himself in the war of the Spanish Succession; but the intrigues of Charles XII. (q. v.) of Sweden, while residing at Bender, forced him into a war with Russia; a step which was immediately followed by an invasion of Moldavia by the Czar Peter, at the head of 80,000 men. The Czar, however, relying on the aid of the Voivode of Moldavia to supply him with provisions, found himself in a dangerous strait with the Pruth behind him, an entrenched army of 150,000 Turks in his front, and 40,000 irregular Tartar cavalry harassing his flanks; while the promised provisions had been seized by the Moldavians, who preferred to supply the Turks with them. From this dilemma, he was rescued by the genius of his queen, afterwards Catharine I., and the folly of the grand vizier, who allowed him to retire on extremely easy terms—terms which the Czar, who was no observer of treaties, did not attempt to fulfil. The recovery of the Morea from the Venetians, and the loss of Belgrade and parts of Servia and Walachia, which were, however, recovered during the subsequent reign of MAHMUD I. (1730—1754), and the commencement of a long war with Persia (see NADIR SHAN), were the other prominent occurrences of Achmet's reign. In 1738, the career of Russian aggression commenced with the seizing of Azof, Oczakof, and other important fortresses; but a scheme for the partition of Turkey between Austria and Russia, was foiled by the continued series of disgraceful defeats inflicted upon the Austrian armies by the Turks; the Russians, on the other hand, were uniformly successful; but the Czarina becoming very desirous of peace, resigned her conquests in Moldavia, and concluded a treaty at Belgrade. Among the benefits conferred by Sultan

Mahmud on his subjects, not the least was the introduction of the art of printing, and the great encouragement otherwise given to literature and science.—His successor, OTHMAN III. (1754—1757), soon gave place to MUSTAFA III. (1757—1774), under whom, or rather under whose vizier, Raghib Köprili, the ablest statesman, after Achmet, that the Turks ever possessed, the empire enjoyed profound tranquillity; but after his death, the Russians, in violation of the treaty of Belgrade, invaded Moldavia, and took Choczim (1769), their fleet, in the following year, destroying the Turkish navy off Chios. Bender next fell, and the country to the mouth of the Danube, whilst the provinces in Asia Minor were also attacked; and, to crown these misfortunes, Egypt revolted.—The war with Russia continued during the succeeding reign of ABDUL-HAMID (1774—1789); the fortresses on the Danube fell into the hands of Romanzof, Suwarof, and Kaminski, the Russian generals; and the main army of the Turks was totally defeated at Shumla. The campaign was ended 10th July 1774, by the celebrated treaty of Kutahuk-Kainardji.\* The ink with which this document was written was scarcely dried before its provisions were infringed by the Czarina, who, after carrying on intrigues with the Crim-Tartars, took possession of the Crimea and the whole country eastward to the Caspian, and compelled the sultan to agree, in 1784, to this arrangement. These successes were accompanied by proceedings extremely insulting to the Turks (such as the placing on the gates of Kherson the inscription, 'This is the way to Byzantium'), and calculated to provoke, in the highest degree, a proud people, already deeply injured by unprovoked aggressions, and the perfidious violation of solemn engagements. The sultan was compelled, by his indignant subjects, to take up arms in 1787; and this was followed, in 1788, by another foolish attempt on the part of Austria to arrange with Russia a partition of Turkey; but, as before, the Austrian forces were completely routed, and she was compelled to agree to a treaty at Sistow. The Russians, however, with their usual success, had overrun the northern provinces, taking all the principal fortresses, and captured or destroyed the Turkish fleet.—The accession of SELIM III. (q. v.) (1789—1807) was inaugurated by renewed vigour in the prosecution of the war; but the Austrians had again joined the Russians, and both armies poured down with desolating fury upon the devoted Turks. Belgrade surrendered to the Austrians, while the Russians took Bucharest, Bender, Akerman, and Ismail (see SUWAROF); but the critical aspect of affairs in Western Europe made it advisable for Russia to terminate the war, and a treaty of peace was accordingly signed at Jassy, 9th January 1792. By this treaty the provisions of that of Kainardji were confirmed; the Dniester was made the boundary-line, the cession of the Crimea and the Kuban was confirmed, and Turkey made to pay 12,000,000 piastres (£109,000) for the expenses of the war. Belgrade was restored to the sultan. Up to

\* In this treaty, the third article stipulates for the entire independence of the Tartars of the Crimea, Kuban, &c., and neither Russia nor Turkey is to interfere in their domestic, political, civil, and internal affairs, under any pretext whatever. The 16th article restores Bessarabia, Moldavia, and Walachia, with the fortress of Bender, on certain conditions, some of which are, that the Christians are not to be obstructed in the free exercise of their religion; that, when occasion may require, the Russian minister at Constantinople may remonstrate in their favour; and the Porte promises to listen to such remonstrances with all the attention which is due to friendly and respected powers. The 23d article restores Georgia and Mingrelia to Turkey.

this period, the Turks had lagged far behind in the march of civilisation; but now, when tranquillity was established, numberless reforms were projected for the better administration of the empire. The people were, however, hardly prepared for so many changes, and the sultan's projects cost him his throne and life. The occupation of Egypt by the French brought on a war between them and the Turks, in which the latter, by the aid of the British, were successful in regaining their lost territories. In revenge for the defeat of his Egyptian expedition, Napoleon contrived to entrap the sultan into a war with Russia and Britain, which was confined to a struggle in Egypt, in which the British were worsted.—After the ephemeral reign of MUSTAFA III. (1807—1808), the able and energetic MAHMUD II. (q. v.) (1808—1839) ascended the throne; and though his dominions were curtailed by the loss of Greece, which established its independence, and of the country between the Dniester and the Pruth, which, by the treaty of Bucharest in 1812, was surrendered to Russia, the thorough reformation he effected in all departments of the administration checked the decline of the O. E., and produced a healthy reaction, which has been attended with the most favourable results. Egypt, during his reign, threw off the authority of the sultan (see MEHEMET ALI, IBRAHIM PASHA), and is now merely a nominal dependency.—His son, ABDUL-MEDJID (1839—1861), a mild and generous prince, continued the reforms commenced in the previous reign; but the Czar, thinking, from the losses of territory which the Turks had lately sustained, and regardless of the changes which the last thirty years had wrought, that the dissolution of the O. E. was at hand, constantly interfered with its internal administration; and by a strained interpretation of former treaties (none of which, it may be remarked, Russia herself had ever faithfully observed, although she stringently enforced their observance on the part of the Porte), tried to wring from the sultan some acknowledgment of a right of interference with the internal affairs of the country. It was an attempt of this sort to obtain the exclusive protectorate of the members of the Greek Church in Turkey, that brought on the 'Crimean War' of 1853—1855, in which, for the first time after a long lapse of years, the Turks were victorious over the Russians. (See OMAH PASHA and other articles.) By the peace of Paris, Turkey regained a portion of territory north of the Danube, between Moldavia and the Black Sea, and extending along the coast to within 23 miles of the mouth of the Dniester; and was, to some extent, emancipated from the subservience to Russia into which she had been forced by previous treaties.—In 1861, ABDUL-AZIZ succeeded to the throne, and gives promise of an energetic and liberal administration. In 1862, Montenegro was reduced to the condition of a dependent principality.

OTWAY, THOMAS, an English dramatist of the 17th c., was the son of a clergyman of the Church of England, and was born March 3, 1651, at Trotton, near Medhurst, Sussex. He was educated at Winchester and at Christchurch College, Oxford, but left the university without taking a degree, and proceeded to London in search of fortune in 1671. He appeared on the stage in Sir William Davenant's company as the *king* in Mrs Behn's *Forced Marriage*; but his failure was signal, and he forsook the profession. For some time afterwards, he led a gay and dissolute life, but subsequently applied himself to dramatic composition. In 1675, *Alcibiades*, his first tragedy, was printed; and in the following year he produced *Don Carlos*, a play which was extremely popular, and, according to Downes (*Roscius Anglicanus*), 'got more money than any

preceding modern tragedy.' Its popularity was due, however, as much to the patronage of Lord Rochester as to its intrinsic merits. His first comedy, *Friendship in Fashion*, appeared in 1678, and, being sufficiently immoral to please the taste of the age, met with general appreciation. In 1677, O. having received a cornet's commission from the Earl of Plymouth, went with his regiment to Flanders. The regiment, however, was disbanded in 1678, and O. resuming his former occupation, produced the tragedy of *Caius Marius* in 1680; and in the same year *The Orphan*, a play which met with an extraordinary, and, in some respects, a deserved measure of success. In 1681, *The Soldier of Fortune*, and in the following year, the finest of all his plays, *Venice Preserved*, were produced. From this time till his death, the poet had much to endure from poverty and neglect. Debts accumulating upon him, he retired to an obscure public-house on Tower Hill, for the purpose of avoiding his creditors, and here, at the premature age of 34, he died, April 14, 1685. The immediate cause of his death was a fever incurred by a hurried and fatiguing journey to Dover in pursuit of the assassin of one of his intimate friends, who had been murdered in the street. Another account of his death is that, after a long fast, he was choked by eating a morsel of bread; but this account rests upon no sufficient authority.

Although O. achieved a brilliant reputation during his lifetime, although he is described by Dryden as possessing a power of moving the passions which he himself did not possess, and later by Sir Walter Scott, as being Shakspeare's equal, if not his superior, in depicting the power of affection; yet his plots are artificial, and his language is without fancy, melody, or polish. The best edition of O.'s works was published in 1813.

OUDE, or OUDH, a province of British India, separated on the north from Nepal by the lower ranges of the Himalaya, whence it gradually slopes to the Ganges, which forms its boundary on the south and south-west. Lat. 25° 34'—29° 6' N., long. 79° 45'—83° 11' E. Extreme length from north-west to south-east, 270 miles; breadth, 160; area, 27,890 square miles, or rather less than that of Scotland. Pop. (1859—1860) estimated at 8,071,000, or about 289 to the square mile. O. is one great plain, the slope of which from north-west to south-east indicates also the direction of the principal rivers. These are the Gumti, the Ghagra (Ghogra), and the Rapti, which swarm with alligators. The northern part, on the edge of the Himalaya, is not very well known. It forms a portion of the Terai, a vast unhealthy tract stretching along the borders of Nepal, and covered with impassable forests. The climate of O. is cool and pleasant from November to March; during the next four months it is hot and sultry, after which follows the long rainy season, but in general it is considered the healthiest along the whole valley of the Ganges. The soil is light, and except small nodules of chalk and oolite called *kankars*, there is hardly a loose stone to be seen. O. was formerly more copiously watered than it is now, the clearing of the jungles having greatly decreased the moisture of the land. The chief crops are wheat, barley, gram, masure, mustard, rice (of the finest quality), millet, maize, joar, bajra, various kinds of pulse and oil-seeds, sugar-cane, tobacco, indigo, hemp, and cotton. The manufacturing industry of O. is not important; soda, saltpetre, and salt are the only articles of which more is produced than is requisite for home-consumption. Gunpowder, and all kinds of military weapons, guns, swords, spears, shields, and bows of bamboo, or Lucknow steel, are, however, also made, besides some woollen goods,

paper, &c. Bridges are few, if any, and the roads in general bad. The principal is the famous military road from Cawnpore to Lucknow, which runs in a north-easterly direction.

The people are of a decidedly warlike disposition. The bulk of the inhabitants are Hindus, though the dominant race for centuries has been Mohammedan. The Brahmans are the most numerous class, but there are 29 different Rajput tribes. It is these two classes that mainly supplied the famous (or infamous) sepoy of the Bengal army. The language spoken is Hindustani.

The most characteristic feature in the social economy of O. is its *village-system*, for a description of which see INDIA. The *ryots*, or cultivators of the soil, cling to the land which their fathers have tilled for ages, with extraordinary affection, and thoroughly believe that they have a right of property in it; and, in general, we believe they are *actually* the owners of their farms, but in many cases they have been dispossessed by a class of tax-gatherers (resembling the Roman *publicani*) called *talukdars*, who farmed from the Mogul, and afterwards from the king of O., the revenues of a collection of villages called a *talukah*, and by their extortions so impoverished the ryots, or peasant-proprietors, that the latter were often forced to execute deeds transferring their property to the talukdars. Many of the more spirited would not submit to become *tenants*, and taking to the jungles, waged war on the new occupants of their ancestral lands, until gradually they sank into *dacoits*, or professional robbers. The extortions of the talukdars continued till the annexation of the country in 1856, and the country suffered severely from the retaliatory raids of the dispossessed ryots. The East India Company reinstated the ryots in their property, where the talukdars could not shew undisputed possession for 12 years—a proceeding which gave great offence to the latter, who, in consequence, assumed a coldly hostile attitude to the British during the great mutiny of the following year.

The principal towns are Lucknow (q. v.), Fyzabad, Oude, or Ayodha, Roy Bareilly, and Shahabad.

O. is believed, by Sanscrit scholars, to be the ancient *Kosala*, the oldest seat of civilisation in India. The country was conquered by a Mohammedan army in 1195, and made a province of the Mogul empire. In 1753, the vizier of O., Saifdar Jung, rebelled against his imperial master, Ahmed Shah, and forced the latter to make the governorship hereditary in his family. His son, Sujah-ud-Dowlah, became entirely independent, and founded a dynasty which ruled the country, generally in a most deplorable manner, until, in the interests of the wretched inhabitants, the East India Company was forced to adopt the extreme measure of annexation, February 7, 1856. The necessity for this high-handed but most beneficent act will be better understood if we read the statistics of crime in O. during the last years of its independence: one item will suffice—from 1848 to 1854, there were, on an average, no fewer than 78 villages burned and plundered every year, while murders, robberies, abductions, and extortions were everyday occurrences. A feeble king, a blackguard soldiery, and a lawless peasantry had brought about a most helpless and ruinous anarchy. When the mutiny of 1857 broke out, O. became one of the great centres of rebellion. Upon this, the confiscation of all the estates of the talukdars was proclaimed by Lord Canning; but when the country was subdued by force of British arms, the estates of all such as laid down their arms and swore fealty to the British government were restored. The forts of the petty chiefs, however, were dismantled, and the inhabitants

disarmed. The province is now administered by a chief commissioner. The chief feature of the present condition of affairs in O. is the preservation in their integrity of the estates of the talukdars. The amount of government revenue paid by the talukdars is £656,495 a year.

OUDE, or AWADH, one of the principal towns of the province Oude (q. v.), stands amid ruins on a hilly site on the right bank of the Sarayū or Goggra River, 80 miles east of Lucknow. It is also called *Hanumangā'dhi*, on account of a temple erected there in honour of Hanumat (q. v.), the fabled monkey-ally of Rāma, an incarnation of the god Vish'nu. The name O. is a corruption of the Sanskrit *Ayodhyā* (from *a*, not, and *yodhya*, conquerable, hence 'the invincible' city); but the ancient city of that name was situated opposite the modern O., where its ruins may still be seen. Ayodhyā was one of the oldest seats of civilisation in India; it was the residence of the solar dynasty, or one of the two oldest dynasties of India, deriving its descent from the sun, but it obtained special renown through Rāma, the son of Das'aratha, a king of that dynasty. Its great beauty and immense size are dwelt upon in several of the Purānas and modern poems, but more especially in the *Rāmāyana* (q. v.), the first and last books of which contain a description of it. According to some Purānas (q. v.), Ayodhyā was one of the seven sacred cities, the living at which was supposed to free a man from all sin, and the dying at which, to secure eternal bliss. It was also called Sāketa, Kos'ala, and Uttara-kos'ala. See Goldstücker's *Sanskrit Dictionary*, under AYODHYĀ.

OUDENARDE, a town in the province of East Flanders, Belgium, is situated chiefly on the east bank of the Scheldt, 16 miles south-by-east from Ghent. It has a population of 8000, and possesses a fine Gothic council-house, important manufactories of linen and cotton fabrics, and many extensive tanneries. The town was taken by the French, aided by an English force, in 1658; it was again besieged in 1674, by the stadtholder, William (III. of England) of Orange; and in 1706, it was taken by Marlborough. An attempt made by the French to retake it, brought on the famous battle of Oudenarde, one of Marlborough's most celebrated victories, which was gained, on the 11th July 1708, with the aid of Prince Eugene, over a French army under the Duke of Burgundy and Marshal Villars. After this battle, the French king made offers of peace, which were not accepted.

OUDINOT, CHARLES NICOLAS, Duke of Reggio, and Marshal of France, was born at Bar-le-Duc, in the department of Meuse, France, 25th April 1767. At the age of 17, he entered the army, but returned home after three years' service. Having distinguished himself in 1790 by suppressing a popular insurrection in his native district, he was, after some volunteer service, November 1793, raised to the rank of chief of brigade, in the fourth regiment of the line, and distinguished himself in various actions with the Prussians and Austrians. He was wounded and taken prisoner before Mannheim, by the Austrians, but was soon exchanged, and served in the armies of the Rhine under Moreau, and in that of Switzerland under Massena. He was promoted to be general of division (12th April 1799), and for a daring capture of a battery at Pozzola, was presented by the First Consul with a sabre of honour and the cannon which he had taken. In 1805, he received the Grand Cross of the Legion of Honour, and about the same time received the command of ten battalions of the reserve, afterwards known as the 'grenadiers Oudinot.' At the head of this corps, he did good service in the Austrian campaign. He was present



at Austerlitz and Jena, and gained the battle of Ostrolinka (16th February 1807), for which he was rewarded with the title of Count, and a large sum of money. He greatly contributed to the success of the French at Friedland, and was presented by Napoleon to the Czar Alexander as the 'Bayard of the French army, the knight *sans peur et sans reproche*.' He sustained his now brilliant reputation in the second Austrian campaign of 1809, and on the 12th of July was created Marshal of France, and on 15th of August, Duke of Reggio. In 1810, he was charged with the occupation of Holland, and by his unswerving probity and attractive personal qualities, drew the esteem of all classes. He was engaged in the disastrous Russian campaign, and subsequently took part in the various battles of 1813 between the French and the Russians and Austrians. He was one of the last to abandon Napoleon, but he did so for ever, and spent the period known as the 'Hundred Days' on his own estates. At the second restoration he became a minister of state, commander-in-chief of the royal guard and of the national guard, and was created a peer of France, Grand Cross of St Louis, &c. In 1823, he commanded the first division of the army of Spain, and was for some time governor of Madrid. After the revolution of July 1830, O. retired to his estates, and only at rare intervals presented himself in the Chamber of Peers. He became Grand Chancellor of the Legion of Honour in May 1839, succeeded Marshal Moncey as governor of the Invalides in October 1842, and died at Paris 13th September 1847. A statue was erected in his honour at Bar, 29th September 1850.—His son, CHARLES NICOLAS-VICTOR OUDINOT, Duke of Reggio (born 3d November 1791), was a general in the French army. He first distinguished himself in Algeria, and in the Revolution of 1848—having previously distinguished himself as a deputy (1842—1846) by his admirable talent for dealing with questions affecting the comfort and discipline of the soldiery—he was chosen commander-in-chief of the army of the Alps. In April 1849, he was appointed general of the French expedition against Rome, and forced the city to surrender unconditionally on the 1st of July, in spite of the heroic resistance of the republican triumvirs—Garibaldi, Mazzini, and Saffi. He was, however, not a Napoleonist, and at the *coup d'état*, 2d December 1851, shared the fate of every eminent general who would not violate his oath to obey the constitution—i. e., he was arrested and imprisoned. After some days he was set at liberty, and has since lived in retirement. O. has written several books of military matters.

**QUISTITI.** See MARMOSER.

**OUNCE.** The Latin *uncia* (derived by Varro from *unus*) was the name of the twelfth part of the *as* or *libra* (pound), and also was applied to the twelfth part of any magnitude, whether of length, surface, or capacity. Hence *inch*, the twelfth part of a foot. The modern ounce is a division of the pound-weight. See POUND.

**OUNCE** (*Felis Uncia*, or *Leopardus Uncia*), a large feline animal, nearly resembling the leopard, but having much rougher and longer hair, a longer and much more bushy tail; the general colour is also paler, the rosette-like spots are less sharply defined, and there is a black spot behind the ears. Little is known of the O.; it is described by Buffon, but naturalists were for some time generally inclined to regard it as identical with the leopard, and its name has been transferred in South America to the Jaguar. It is a native of Asia, and probably of mountainous districts.

**OU'RARI.** See CURARI.

**OURATEPE.** See URATEPE.

**OU'RO PRE'TO**, a city of Brazil, capital of the province of Minas Geraes, stands among barren mountains, at an elevation of 4000 feet above sea-level, and 200 miles north-north-west of Rio Janeiro. It contains the governor's residence and a college, and consists mainly of narrow and irregular streets. In the vicinity is one of the most valuable gold mines in the province, which has been worked by an English mining company for upwards of 20 years. A good trade in coffee, &c. is carried on with Rio Janeiro, but is retarded by the want of good roads. The journey from O. P. to the capital of the empire is performed by horses and mules only, and ordinarily requires 15 days. Pop. about 12,000.

**OUSE**, called also, for the sake of distinction, the **NORTHERN** or **YORKSHIRE OUSE**, a river of England, is formed by the union of the Swale and the Ure in the immediate vicinity of the village of Boroughbridge, and flows south-east past York, Selby, and Goole. About eight miles below the last town, it joins the Trent, and forms the estuary of the Humber. The length of its course from Boroughbridge is 60 miles, for the last 45 of which (from the city of York) it is navigable for large vessels. Its principal affluents are the Wharf and the Aire from the west, and the Derwent from the north-east. The basin of the O., or the Vale of York, commences from the northern boundary of the county near the river Tees, from whose basin it is separated by a low ridge of hills, and extends southward, including almost the whole of the county. See **YORKSHIRE**.

**OUSE, GREAT**, a river of England, rises close to the town of Brackley, in the south of Northamptonshire, and flows north-east through the counties of Buckingham, Bedford, Huntingdon, Cambridge, and Norfolk, and falls into the Wash 2½ miles below King's Lynn. It is 160 miles in entire length, and is navigable for about 50 miles. It receives from the east and south the Ivel, Cam, Lark, and Little Ouse.

**OUTCROP**, a term applied in Geology to the edge of an inclined bed at the place where it rises to the surface. The line of the outcrop is called the **strike**, which is always at right angles to the dip.

**OUTER HOUSE.** See COURT OF SESSION.

**OUTFIT ALLOWANCE**, in the British Army, is a sum of £150 for the cavalry, and £100 for the infantry, granted to non-commissioned officers promoted to commissions, to enable them to meet the heavy charges for uniform and equipments. The larger sum is given in the cavalry, because the newly-commissioned officer has to purchase his charger.

**OUTLAWRY**, in English Law, means putting one out of the protection of the law, for contempt in wilfully avoiding execution of legal process. Formerly, in the common law courts, if the defender would not enter an appearance, certain proceedings were taken to outlaw him, so as to allow the action to go on without his appearance. These proceedings, however, are now abolished, and, in the majority of cases, it is immaterial as regards the action whether the defendant appear or not, provided he was properly served with the original writ of summons. After judgment, he may still be outlawed, as a preliminary to seizing and selling his property. In criminal proceedings, outlawry still exists as part of the ordinary practice to compel a person against whom a bill of indictment for felony or misdemeanour has been found, but who will not come forward to take his trial, and who has not been arrested. In such a case, process of outlawry against him is

awarded, which is a kind of temporary judgment; and while this process exists, he is out of the protection of the law, and forfeits all his property. The courts will not listen to any complaint or attend to his suit till he reverse the outlawry, which is generally done as a matter of course.—In Scotland, outlawry or fugitation is a similar process, and the defender must first be reponed against the sentence of outlawry before his trial can take place.

**OUTPOSTS** are bodies, commonly small, of troops stationed at a greater or less distance beyond the limits of a camp or main army, for the purpose of preventing an enemy approaching without notice, and also to offer opposition to his progress, while the main force prepares for resistance. Outguards march off to their position silently, and pay no compliments of any kind to officers or others. As soon as the officer commanding an outpost arrives on his ground, he proceeds to carefully examine the environs, noting all heights within rifle-range, roads and paths by which an enemy may approach, &c. He also takes such impromptu means of strengthening his position as occur to him—felling a tree here, cutting brushwood there, blocking a path in another place, and resorting to any expedient which may serve to delay the foe at point-blank range—an object of importance, as a stoppage at such a point is known to act as a great discouragement to advancing troops.

**OUTRAM, SIR JAMES, LIEUTENANT-GENERAL, G.C.B.**, Indian soldier and statesman, was born, 1803, at Butterley Hall, Derbyshire, the residence of his father, Mr Benjamin Outram, a civil-engineer of note. His mother, the daughter of James Anderson of Mounie, Aberdeenshire, was descended from Sir W. Seton, Lord Pitmedden. O. was educated at Udny, Aberdeenshire, under the Rev. Dr Bisset, and afterwards went to Marischal College, Aberdeen. He was sent to India as a cadet in 1819, and was made lieutenant and adjutant of the 23d Bombay Native Infantry. He then took command of and disciplined the wild Bheels of Candeish, and successfully led them against the Daung tribes. From 1835 to 1838, he was engaged in re-establishing order in the Mahi Kants. He went with the invading army under Lord Keane into Afghanistan as aide-de-camp; and his ride from Khelat, through the dangers of the Bolan Pass, will long be famous in Indian annals. He became political agent at Guzerat, and commissioner in Sinde, where he made a bold and earnest defence of the Ameers against the aggressive policy of General Sir Charles James Napier. He was afterwards resident at Sattara and Baroda, and upon the annexation of Oude, was made resident and commissioner by Lord Dalhousie. His health failing, he returned to England in 1856; but when the war with Persia broke out, and it became necessary to send an expedition to the Persian Gulf, O. accompanied the forces, with diplomatic powers as commissioner. He conducted several brilliant and successful operations; the campaign was short and decisive; and the objects of the expedition having been triumphantly attained, he returned to India. Landing at Bombay in July 1857, he went to Calcutta to receive Lord Canning's instructions, and was commissioned to take charge of the forces advancing to the relief of Lucknow. He chivalrously waived the command in favour of his old lieutenant, Havelock (q. v.), who had fought eight victorious battles with the rebels, and, taking up only his civil appointment, as chief-commissioner of Oude, tendered his military services to Havelock as a volunteer. Lucknow was relieved, and O. took the command, but only to be in turn besieged.

He held the Alumbagh against almost overwhelming forces, until Lord Clyde advanced to his relief. He then made a skilful movement up the left bank of the Gumti, which led to a final and complete victory over the insurgents. He was made chief-commissioner of Oude; and though he had strongly opposed its annexation, he was the man who did most to restore British rule, and attach the people to it. For his eminent services, he was promoted to the rank of lieutenant-general in 1858, and received the thanks of parliament in 1860. He took his seat as a member of the Supreme Council of India, in Calcutta, but sank under the climate, and returned to England in 1860, already stricken by the hand of death. The communities of India voted him a statue at Calcutta, founded an institution to his honour, and presented him with commemorative gifts. A banquet was given to him and his chief and companion-in-arms, Lord Clyde, by the city of London. His English admirers determined to erect a statue to his honour in London, and gave him a valuable dessert-service in silver. He spent the winter of 1861—1862 in Egypt; and after a short residence in the south of France, expired at Paris, March 11, 1863. O. was styled by Sir Charles Napier the 'Bayard of India.' Than his, there is no more gallant name in the whole list of distinguished Indian soldiers. His services in the East as a soldier and a diplomatist extended over the period of forty years. He was ever the generous protector of the dark-skinned races among whom his lot was thrown, and set a bright example to all future administrators of moderation, conciliation, humanity, and practical Christianity in all his dealings with the natives of India.

**OUTRIGGER**, in its proper sense, is a beam or spar fastened horizontally to the cross-trees or



Fig. 1.

otherwise, for the purpose of extending further from the mast or topmast the backstay or other rope by which that mast or topmast is supported. The power of the stay is thus increased. The term is also used improperly—because no 'rigging' is in question—to denote the apparatus for increasing the leverage of an oar, by removing the resistance, as represented by the side of the boat (see OAR), further from the power represented by the rower's hand. This is effected by fixing an iron bracket to the boat's side, the row-lock being at the bracket's extremity. The necessary leverage is thus obtained without adding to the width of the boat itself.

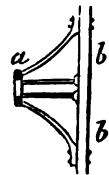

Fig. 2.

a, outrigger; b, side of boat.

**OUTWORKS**, in Fortification, are minor defences constructed beyond the main body of a work, for the purpose of keeping the enemy at a distance, or commanding certain salient points which it is undesirable that he should occupy. Such works are ravelins, lunettes, hornworks, crown-works, demi-lunes, tenailles, &c. They occur in certain necessary order, as a ravelin before the curtain and tenaille a hornwork before a ravelin, and so on.

**OUZEL**, or **OUSEL** (Old Fr. *ousel*, bird), an old name of the black-bird, as is evident from the descriptive lines of Bottom's song in *Midsommer Night's Dream*:

'The ousel oock, so black of hua,  
With orange tawny bill.'

It is also applied to other birds, chiefly of the thrush family. Thus, one British thrush is called the Ring Ouzel. The Dipper (q. v.) is very generally known as the Water Ouzel; and the Rose-coloured Pastor is also called the Rose-coloured Ouzel.

**OVAL**, the name given to the figure presented by a longitudinal section of an egg through its centre. The oval has a general resemblance to the ellipse; unlike the latter, however, it is not symmetrical, but is thicker at one end than the other, and at the thin end, narrows almost to a point. The term 'oval' is also used indiscriminately with 'nodus,' 'loop,' to denote the figure formed by a curve which either returns upon itself, as the lemniscata, &c., or the loops of the cubical and semi-cubical parabolas and other curves. In scientific language, it is specially distinguished from the term 'elliptical,' with which, in common parlance, it is usually confounded.

**OVA'MPOS AND OVAMPOLAND.** The Ovampos or Otjherero are a tribe, seemingly a connecting link between the Kaffir and Negro races, who inhabit the region north of Great Namaqualand, in South Africa, extending north to the Cuanene River, and south to the parallel of 23° S. lat. The Ovampo tribes are described by Andersson as of a very dark complexion, tall and robust, but remarkably ugly. He found them, however, honest, industrious, and hospitable. They are not entirely pastoral, but cultivate much corn. Living in the same country are the Cattle Damaras, with still more of the Negro type, a stout, athletic people, very dirty in their habits, and generally armed with the bow and arrow. They live in a state of constant warfare with the Ghondannup, or Hill Damaras, a nearly pure Negro race, on the one hand, and the Namaqua Hottentots, who live south of them, on the other.

Ovampoland is a more fertile region than Namaqualand, from which it is separated by a wide belt of densely-bushed country. It has but few rivers, and these not of a perennial nature. About 50 miles from the coast, the country rises to a tableland about 6000 feet above the sea-level, and then declines to the south and east into the deserts of the Kalihari, and the region of Lake Ngami. Many strong indications of copper-ore are found in various places. The principal rivers, or rather water-courses, are the Swakop, Kusip, and their branches, which enter the Atlantic a few miles north of Walfish Bay. The other rivers in the interior seem to lose themselves in the sands. The climate is healthy, except near the coast, where fever in some seasons prevails. It seldom rains in the coast region, which is a very desolate one, and almost devoid of water. Thunder-storms are very violent in the summer season. All the large mammalia are found, more or less plentiful, according as water may be found at the different drinking-places. Elephants, rhinoceroses, elands, and other large animals driven from the south by the march of civilisation, take refuge in the desert region lying east of Ovampoland, where sportsmen like Green and Andersson have been known to kill as many as twelve elephants in a day. The country was first described by Sir J. Alexander, who visited its south border. Mr Galton afterwards penetrated much further north; and Mr C. J. Andersson has since fully explored it nearly as far

north as the Cuanene. Large numbers of horned cattle are annually collected by traders from the Cape in these regions, and whales abound on the coast. The trade in ostrich-feathers and ivory is of increasing importance, and several trading-stations are established for the collection of native products. Some elementary works have been printed in the Otjherero dialect by the German missionaries; two appear in Sir G. Grey's catalogue.

**OVARIES** are organs peculiar to the female, and are analogous to the testes in the male. They are two oblong flattened bodies (about an inch and a half in length, three-quarters of an inch in width, and nearly half an inch thick in the human subject), situated on either side of the uterus, to which they are connected by ligaments and by the Fallopian tube. On making sections of an ovary, numerous vesicles are seen. These are the ovisacs of the future ova or germs, and are termed the *Graafian vesicles*. Before impregnation, they vary in number from ten to twenty, and from the size of a pin's head to that of a pea; but microscopic examination reveals the presence of young vesicles in large numbers. At each monthly period, a ripe Graafian vesicle bursts, and the ovum contained in it makes its way by ciliary motion along the Fallopian tube to the uterus, where, if it is not impregnated, it is disintegrated and absorbed.

Solid tumours or cysts, containing hair and teeth, are developed in these organs, but their principal disease is that to which the name of *Ovarian Tumour* is applied. This tumour may be described as consisting of an enormous enlargement of one or more of the Graafian vesicles into a mass which may weigh 80 or 100 pounds, or even more; and it may be either simple (that is to say, composed of natural structures much hypertrophied) or cancerous. The walls of the cysts (or enlarged Graafian vesicles) may be thin and flexible, or thick and cartilaginous; and the fluid they contain may be clear and limpid, or thick and ropy, or grumous and opaque. The only disease with which it can be confounded is ordinary abdominal dropsy, or *Ascites*, and when its nature is clearly determined, three modes of treatment are open for adoption: these are (1) tapping, (2) various surgical and medical means of producing atrophy of the tumour, and (3) extirpation of the organ, or ovariectomy.

1. Tapping is the simplest mode of relieving the patient; but the cyst soon refills, and the operation must be often repeated. 'Cases are extant in one of which the patient lived to be tapped 66 times at intervals of about a month, and in another, 128 times at intervals of six weeks; but, taken as a general rule, it may be affirmed that few patients survive more than four years after the first tapping, a period passed in the greatest misery and suffering.'—Druet's *Surgeon's Vade-mecum*, p. 498.

2. Under this head are included both numerous operations for causing the tumour to waste, and its internal walls to adhere, and the internal administration of absorbent medicines, with the view of producing atrophy and absorption of the tumour. The injection of tincture of iodine into the previously emptied cyst, is sometimes followed with good results, as in the case of Hydrocele (q. v.).

3. Ovariectomy, or total extirpation of the morbid mass, is an operation regarding which there has of late years been much discussion. Its opponents urge (1) the difficulty of diagnosis; (2) the frequency of adhesion of the tumour to adjacent parts—a point which can often not be ascertained till the abdomen has been opened; and (3) the great mortality that follows it: while in favour of the operation it is urged (1) that the mortality is not greater than from

some other surgical operations which are regarded as justifiable; (2) that no other plan of treatment can effect a radical cure; (3) that if the surgeon, in order to complete his diagnosis, first makes a small incision, to enable him to ascertain the existence of adhesions, and closes it again with suture, if he finds this to be the case, no great harm is likely to result; and (4) that considering the miserable lives these patients lead during a course of tapping, &c., it is the most merciful course to adopt in patients who are young and otherwise healthy. For a description of the mode of performing the operation, and of the cautions to be observed, we may refer to a series of papers on Ovariectomy by Mr Spencer Wells in *The Medical Times and Gazette* for 1858 and 1859.

OVARY, in Botany. See GERMEN.

OVATION. See TRIUMPH.

OVEN, FIELD OR BARRACK, is a necessary apparatus in military economy to preserve the health of troops, by enabling them, at a comparatively small expenditure of fuel, to cook many rations together. In the British army, little attention was paid to such subjects, until, in 1858, the inquiries of Mr Sidney Herbert (afterwards Lord Herbert) brought to light the excessive mortality among soldiers, which was partly—and, as the event has shewn, justly—attributed to the bad cookery of their food. Captain Grant has bestowed much attention to army cookery, and has invented ovens for barrack use and for the field. While great improvements on the system—or want of system—which preceded them, these ovens are still admitted to be far from perfect in their arrangements.

Fig. 1 shews his barrack-stove for baking and

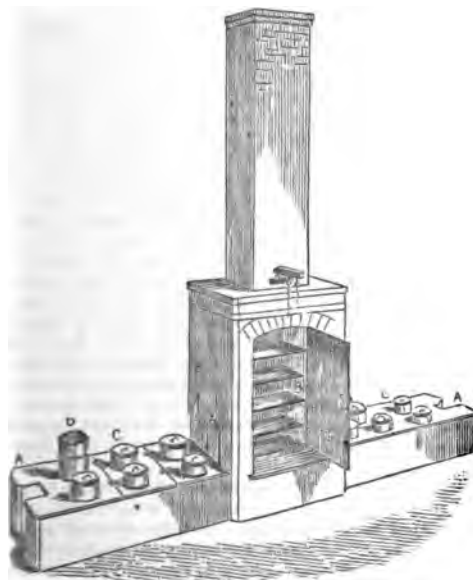

Fig. 1.—Barrack-stove.

A, boiler over fire; B, oven; C, movable boilers for meat; D, potato-steamer.

boiling; fig. 2, his boiler-wagon for the field, its functions being the manufacture of soup and boiling of potatoes in nets in it. For boiling meat, &c., in the field, he employs detached cylinders, which, when empty, he proposes to join and floor over for use as pontoons; when in use they are united crosswise, as in fig. 3, one in the middle serving for a

chimney. One or more empty barrels can be



Fig. 2.—Field cooking-wagon.  
(Drawing the Soup.)

attached for steaming potatoes, and the roasting of

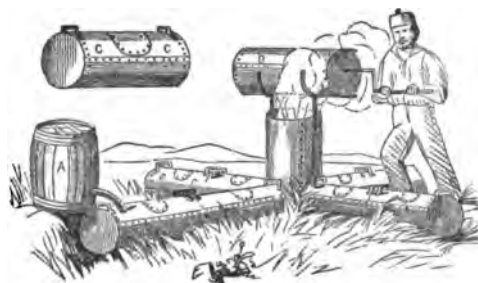
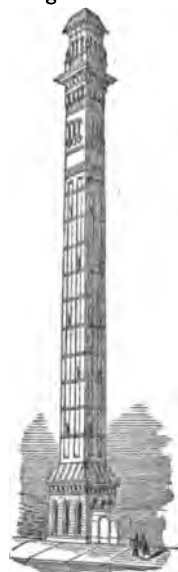

Fig. 3.—Field-oven.

A, empty cask used as a potato-steamer; B, coffee-roaster; C, detached boiler.

coffee is performed, though not altogether successfully, in another cylinder made to revolve over the chimney.

O'VER DARWEN is a very flourishing town of Lancashire, situated amid moorland hills, 3½ miles south of Blackburn, and 19½ miles north-west of Manchester, with which towns it is connected by the Lancashire and Yorkshire Railway. It has risen into wealth principally by a trade with India in calicoes. At present there are about 200,000 spindles and 12,000 looms at work in it, and on the completion of the 'India Mill,' 100,000 additional spindles will be set to work. This mill, now (June 1864) three parts erected, will be in many respects the finest in the country. It is a first-class stone building in the Italian style, with engine-house, chimney, &c., highly ornamented, is 100 feet high, and covers an area of 31,000 square feet. (See illustration of chimney.) The town also contains 5 paper



manufactories, the most extensive paper-staining works in England, 2 calico printing establishments, as well as works for iron founding, bleaching, machine and reed making, &c. There is an abundance of coal and stone in the neighbourhood, and the mines and quarries find employment for a considerable number of the inhabitants. The places of worship are—3 churches, 3 Independent chapels, a Baptist and a Wesleyan Methodist chapel, a Roman Catholic chapel, and 3 other dissenting chapels. There is also a Mechanics' Institution, a market house, and public baths; and a large public hall is contemplated, to accommodate 2000 people. Pop. (1851), 7020; (1864), 15,300.

**OVERBECK, FRIEDRICH**, born at Lübeck, July 3, 1789, a distinguished painter, to whom is justly awarded a large share of the merit of the movement in the early part of this century, from which arose the modern German school of art. He commenced his studies as an artist at Vienna in 1806; but having adopted, and continued to persist in carrying out certain notions on art, and the mode of studying it, essentially different from those inculcated in the academy, he was expelled along with certain other students who entertained the same views, and in 1809 set out for Rome. Here he was soon afterwards joined by Cornelius and Schadow; and these three, animated with similar ideas, and mutually encouraging one another, laid the foundation of a school that now holds a high rank, and has in no small degree influenced the taste for art in Europe at the present time. A picture of the Madonna, which O. painted at Rome in 1811, brought him into marked notice. He was next employed along with Cornelius and others, by the Prussian consul, General Bartholdi, to execute certain frescoes illustrating the history of Joseph, the 'Selling of Joseph' and the 'Seven lean Years,' being the subjects assigned to him. After completing these, he painted in fresco, in the villa of the Marchese Mas-simi, five large compositions from Tasso's *Jerusalem Delivered*. In 1814, along with some of his artistic brethren, he abjured Lutheranism, and embraced the Roman Catholic religion. O.'s chief work is a fresco at Assisi, 'The Miracle of Roses of St Francis.' His oil pictures are inferior to his frescoes, being dry and weak in colour. His great picture, 'The Influence of Religion on Art,' preserved in the Stadel Institute at Frankfurt, and well known from the engraving, is an admirable composition, and is indeed the most favourable specimen of his powers as a painter in oil colours. He has executed a great many drawings remarkable for high feeling, most of which have been engraved. One of his last undertakings, a series of designs from the Evangelists, delicately engraved in the line manner, is a work of high excellence. O. has adhered closely to those ideas of art which he started with—namely, entire devotion to the style of the Italian artists prior to the period of the renaissance, particularly Fra Angelico (b. 1387—d. 1455), and a strong impression that form or drawing in the style of Greek or classic art is inadmissible in works embodying religious subjects; although many of his compatriots—Cornelius, for instance—have modified, or perhaps enlarged these ideas, and study the works of Michael Angelo and those of Raffael's larger style executed under the influence of classic art. O. resides in Rome, and has made it the place of his abode since the time he went there as a student.

**OVERBURY, SIR THOMAS**, an English author and courtier, whose mysterious death has given a peculiar interest to his history, was the son of Nicholas Overbury, a Gloucestershire squire, and was born at Compton Scorfen, Warwickshire, the

residence of his maternal grandfather in 1581. At the age of fourteen he entered Queen's College, Oxford, where he highly distinguished himself in logic and philosophy, and where he took the degree of B.A. in 1598. He then joined the Middle Temple, but soon after set out for the continent, from which he returned with the reputation of being a finished gentleman. While on a visit to Scotland in 1601, he met for the first time with his future murderer, Robert Carr (properly Ker), then a page in the service of the Earl of Dunbar. An intimacy unfortunately sprung up between the two, and Carr—a handsome ignoramus, sensual and unprincipled—followed his scholarly friend to London. On the accession of James to the English throne (1603), Carr rose rapidly into royal favour, and was created Viscount Rochester. Through his influence, O. was knighted in 1608, and his father appointed a judge for Wales. In return, O. gave his patron the benefit of his wit and judgment, both of which were singularly excellent; and, according to Hume, it was owing to O. that Carr enjoyed for a time the highest favour of the prince without being hated by the people. The circumstances that led to a rupture of their intimacy, and turned the earl into O.'s secret and relentless enemy, form one of the most flagrant scandals in the history of the English court. A brief outline of these circumstances is all that can be given here.

At the age of thirteen, Frances Howard, daughter of the Earl of Suffolk, was married (1606) to the Earl of Essex, himself only a year older. On account of their youth, it was reckoned advisable by their friends that they should not live together for some time. The boy-husband went away on his travels, and the wedded girl to her mother. After the lapse of nearly five years, Essex came home, and found his wife, now a splendid beauty of eighteen, the idol of all the court gallants. But there was not a touch of virtue or goodness in her whole soul. She had the disposition of a Messalina (q. v.) or a Brinvilliers (q. v.). For her husband she shewed the greatest aversion, and only consented to live in his house at the command of the king. It was well known that she had had intrigues with more than one lover, but in particular to Rochester, for whom she now cherished a fierce passion. O. had been instrumental in bringing about their guilty intercourse, and was now to reap the reward due to a pander. Rochester having told him that he purposed to get Lady Essex divorced from her husband, and then to marry her, O. strongly deprecated the idea, and declared that it would be disgraceful to form a union with so depraved a creature—she might do for a mistress, but not for a wife! The earl told Lady Essex what O. had said of her; she became furious for revenge, and offered Sir David Wood (between whom and O. there was a standing quarrel) £1000 to assassinate him, which that canny Scot declined to do. Rochester himself was now persuaded by his mistress to join privately in a plot against O., who on a most trivial and illegal pretext was thrown into the Tower, April 21, 1613. It was some time before he could bring himself to believe that his friend and patron was the cause of his imprisonment; but when he had assured himself of Rochester's treachery, he threatened to divulge certain secrets in his possession, whereupon it was determined by the earl and his mistress that he should be poisoned. This, after several trials, was successfully accomplished, and O. expired on the 15th of September. Rochester (now created Earl of Somerset), and his paramour were married on the 26th of December with great pomp, the brazen-faced beauty wearing her hair 'as a virgin,' and the whole

## OVERLAND ROUTE—OVERSEERS.

affair was soon to appear forgotten; but after George Villiers had supplanted the earl in the royal favour, an inquiry was instituted; Somerset and his wife were tried and found guilty of poisoning, but were, by an amazing and infamous stretch of the royal prerogative, pardoned. The motive for James's extraordinary clemency has never been ascertained; but the prevailing opinion is, that it was to prevent the disclosure of some discreditable, if not criminal, incidents in the private life of that monarch.

O. wrote several works, all of which were posthumously published. The principal are, *The Wife* (1614), a didactic poem; *Characters* (1614), the wit, ingenuity, precision, and force of which have long been admitted; *Crumbs Fallen from King James's Table* (1715). The latest edition of O.'s works is that by E. F. Rimbault with Life (1856).

**OVERLAND ROUTE** to India, the route generally chosen by those to whom time is a more important consideration than expense. The management of the route is in the hands of the Peninsular and Oriental Steam Company, who present the traveller with a choice of lines of route to Alexandria in Egypt. He may sail from Southampton via Gibraltar and Malta, reaching Alexandria in 13 days, a very convenient route for those who have much luggage, as no shifting is required till Alexandria is reached; or he may travel overland by railway and steamer to either of the ports of Marseille or Trieste. The shortest route from London to the former is via Dover, Calais, and Paris, Alexandria being reached in 11 days (including the necessary stoppages at different points on the route); and to the latter, via Dover, Calais, Paris, Turin, and Venice. The total length of journey to Alexandria from London by this route is 14 days; but as there are only 5 days of sailing, it is for that reason frequently preferred.

From Alexandria, passengers are conveyed by rail to Suez, where they again embark on board the Peninsular and Oriental Company's steamers, and are conveyed to Bombay, Madras, Calcutta, &c. The time occupied in travelling from Alexandria to Bombay is 13 days, to Madras 24 days, and to Calcutta 29 days. Thus a traveller can reach Calcutta from London in 40 days; at an expense, however, of more than £100. The long sea-route round by the Cape of Good Hope cannot be accomplished by steamer in less than 94 days, and by sailing vessels it takes more than four months, but the cost is much less.

**OVERSEERS** are officers appointed annually in all the parishes in England and Wales, whose primary duty it is to rate the inhabitants to the poor-rate, collect the same, and apply it towards giving relief to the poor. These officers occupy an important position in all English parishes. They were first ordered to be appointed in each parish by the statute of 43 Eliz. c. 2, the leading Poor-law Act, which directed four, three, or two substantial householders in the parish to be nominated yearly, and a later statute fixed the time of nomination to be 25th March, or a fortnight thereafter. The courts have held that not more than four, nor less than two, can be appointed, the object being, probably, that so much responsibility should not be thrown on any one individual. Though it is usual for the vestry of the parish to nominate two persons to be overseers, still those who really appoint them are the justices of the peace, who are not bound to regard the wishes of the vestry in this respect. It is only householders in the parish who are qualified for the office, and though it is not necessary that they should actually reside in the parish, still they must occupy or rent a house there. Several classes

of persons are exempt from serving the office, such as peers, members of parliament, clergymen, dissenting ministers, barristers, attorneys, doctors, officers of the army and navy, &c. But all who are not specially exempted by some statute are liable to serve the office, and even women may be appointed, though they scarcely ever are so in practice. The office is compulsory, and entirely gratuitous; and so necessary is it that some one shall fill the office, that it is an indictable misdemeanour to refuse, without cause, to serve when duly appointed. Though overseers are the proper managers of the poor for each parish, yet some parishes, especially in large overgrown towns, have been regulated by local acts, and guardians of the poor provided; and other parishes are under what is called a select vestry. In such cases, the overseers, though still appointed, are only allowed to give relief to paupers in certain urgent and exceptional cases, the ordinary regulation of poor-law affairs being confined to the guardians or the select vestry. The primary duty of the overseers consists in making, collecting, and applying the poor-rate for the relief of the poor of the parish, but, as will be seen, advantage has been taken by the legislature of the existence of these officers always representing the parish, to throw upon them various miscellaneous duties which are not directly connected with poor-law affairs.

1. Of the duties connected with the management of the poor. The overseers along with the churchwardens are to make a rate once or twice a year; i. e., a list of all the occupiers of lands and houses in the parish, specifying their names and the property occupied by each, and the ratable value and amount due by each. The next thing to be done is to go before two justices of the peace, and get the rate allowed—i. e., signed by them—and then it is published on the church-door on the following Sunday. The overseers must collect the rate also; but in all large parishes there is a collector of poor-rates who is specially appointed and paid for the purpose of collecting it. If a party refuses to pay the rate, the overseers must take proceedings before justices to compel payment, which is done by distraining the goods of the party, or, if there are no sufficient goods, by getting a warrant to imprison him. The party may, however, appeal against the rate to the Court of Quarter Sessions. When the money is collected, the overseers have to apply it towards the relief of the poor, and many other purposes of a kindred nature. Relief must be given to all the poor in the parish who are in a destitute state; but it is the duty of the overseers, when the pauper has not a settlement in the parish, to obtain an order of removal, i. e., to get an order of justices, under which the pauper is taken by force, and sent to the parish where he has a settlement. See **REMOVAL OF THE POOR**. Relief is given, in general, only in the workhouse, and according to certain rules and conditions. Where the parish is included in a poor-law union, as is now generally the case, then the duty of overseers in giving relief is entirely confined to certain urgent cases; for the guardians of the union administer the ordinary business of the workhouse, and of relief generally. Another duty incident to overseers of a parish in a union is the duty of making out valuation lists—i. e., a new valuation of the property in the parish—which list is ordered by the guardians with a view to produce some uniformity in assessing the burdens on the various occupiers. Formerly, the mode of valuing property for the purposes of the poor-rate was not subject to any uniform rule, and in some parishes the valuers made a larger deduction from the actual value than in others; but in 1862, a statute passed, called the Union Assessment Act,

the object of which was to enable new valuations to be made on a uniform plan, till the occupiers in all the parishes are treated alike. At the end of the year of office, the accounts of the overseers of parishes in unions are audited by a poor-law auditor, who is a paid officer, and who examines the vouchers, and sees that no illegal payments have been made.

2. The miscellaneous duties now imposed by statute on overseers, over and above their original duty of relieving the poor, are numerous. The most prominent, perhaps, is that of making out the list of voters for members of parliament. This duty is done in obedience to certain precepts issued by the clerk of the peace each year, who gives the overseers full instructions how to make out the lists, and what claims and objections to receive, and how to deal with them. The overseers must also attend the court of the revising barrister, when he revises the lists, and disposes of legal objections. Another duty of the overseers is to make out the list of persons in the parish qualified to serve as jurors. So they must make out the burgess lists when the parish is situated within a borough. They must also make out the list of persons qualified to serve as parish constables. They are also bound to appoint persons to enforce the Vaccination Acts; they must give notice to justices of all lunatics within the parish, and pauper lunatics are removed to the county asylum, or in some cases, if it is safe in the opinion of the medical officer, may be kept in the workhouse. The overseers must also perform certain duties as to the election of guardians for the union. They must also bury the dead bodies of persons cast on shore, and of all paupers who die in the parish. They also are the proper parties to protect village greens from nuisances; and in general, where there is no local Board of Health, the overseers are the parties bound to act in carrying out the Nuisances Removal Acts (see *NUISANCE*) within the parish, which of itself is an onerous duty. In general, whenever overseers are bound to do miscellaneous duties of this kind, they are authorised to pay the necessary expenses and disbursements out of the poor-rate; but, as already stated, their services are gratuitous. The duties which in England are performed by overseers, devolve, in Scotland, upon the parochial board, the sheriff-clerk of the county, session-clerk, and others.

**OVERSEER, ASSISTANT.** An assistant overseer is a paid officer, whose services have generally been found necessary in the larger parishes, in order to relieve the annual overseers of their burdensome office to some extent. Accordingly, the ratepayers, in vestry assembled, appoint a person as assistant overseer with a salary, who performs most of the same duties as the overseers. In many cases, however, a collector of poor-rates has been appointed, who is also paid by salary, and in such a case he discharges like duties. Both the assistant overseer and the collector of poor-rates are bound to find security for the faithful discharge of their duties, and for duly accounting for moneys in their hands.

**OVERSTONE, SAMUEL JONES LOYD, LORD,** one of the most skilful political economists, and the ablest writer on banking and financial subjects that this country has produced. He was born in 1796, being the only son of Mr Lewis Loyd, descended from a respectable Welsh family, and a leading partner in the eminent banking house of Jones, Loyd, and Co. of London and Manchester. Having gone through a regular course of instruction at Eton, young Loyd was sent to Trinity College, Cambridge, where he had Dr Blomfield, late Bishop of London, for tutor, and where he acquired a very

extensive acquaintance with classical literature, and with the history and literature of his own country and of Europe generally. On leaving Cambridge, Loyd entered the banking-house as a partner along with his father, and on the retirement of the latter, he became its head. He distinguished himself highly in his capacity of banker. He had a profound knowledge of the principles of banking, and these he applied on all occasions in conducting the business in which he was engaged. Far-sighted and sagacious, he was seldom deceived by appearances or pretensions, however specious. Perhaps, if anything, he was too cautious; but he was neither timid nor irresolute. He was eminently successful in the employment of the very large deposits at his command, and while he eschewed hazardous transactions, he did not shrink from engaging in very extensive operations when he believed they could be undertaken with a due regard to that safety which should always be the first consideration in the estimation of a banker.

Loyd entered parliament in 1819 as member for Hythe, which he continued to represent till 1826. He made several good speeches in the House; and was one of a small minority that voted for the proposal to make bankers issuing notes give security for their payment. Though opposed to all changes of a dangerous or revolutionary character, Loyd has been always a consistent liberal. Having either withdrawn, or being on the eve of withdrawing from business, Loyd was raised to the peerage in 1850, by the title of Baron Overstone and Fotheringhay, county Northampton; and if great wealth, consummate intelligence in regard to matters of great public importance, and the highest degree of integrity and independence, be qualifications for a seat in the Lords, few peers have had a better title to be enrolled in that august assembly.

The first of Lord O.'s famous tracts on the management of the Bank of England and the state of the currency was published in 1837, and was followed by others between that period and 1857. The proposal for making a complete separation between the banking and issue departments of the Bank of England, introduced by Sir Robert Peel into the act of 1844, was first brought forward in these tracts, and its adoption has been the greatest improvement hitherto effected in our banking system. Having been collected, these tracts were published in 1857, with extracts from evidence given by Lord O. before committees of the Lords and Commons. And it would not be easy to exaggerate the value of this volume. Lord O. has also reprinted, at his own expense, four volumes of scarce and valuable tracts on metallic and paper money, commerce, the funding system, &c., which he has extensively distributed.

An inquiry took place before a committee of the House of Commons in 1857 into the practical working of the act of 1844, and Lord O. was the principal witness who came forward in defence of the act; but several leading members of the committee being hostile to it, exerted themselves to overthrow his lordship's theories and opinions, and subjected him to a severe cross-examination; which gave Lord O. the opportunity of successfully vindicating the principles and practical working of the act. This evidence was published in a separate volume in 1857.

Lord O. does not often speak in the House of Lords. His speech on the late commercial treaty with France is probably the best of his parliamentary appearances. He has also been a zealous opponent of the principle of limited liability. He was a leading member of the commission appointed to inquire into the proposal for the introduction of

## OVERTURE—OVID.

a decimal system of arithmetic, and powerfully advocated the opinion that it would be injurious rather than beneficial.

All who have the privilege of knowing Lord O. regard him as one of the most honourable, high-minded, and upright men in the empire. But his rigid adherence to principle in his writings, his dealings, and his conversation, and his undisguised contempt for twaddle and pretension of all sorts, have made him be generally looked upon as austere and without sympathy. Such, however, is not the fact. When proper cases for the display of sympathetic and generous feelings are brought before him, none evince them more strongly. We may add that his conversational talents are of the highest order.

**OVERTURE** (from Fr. *ouverture*, opening), a musical composition for a full instrumental band, introductory to an opera, oratorio, cantata, or ballet. It originated in France, and received its settled form at the hands of Lulli. Being of the nature of a prologue, it ought to be in keeping with the piece which it ushers in, so as to prepare the audience for the sort of emotions which the author wishes to excite. Such is to a great extent the character of the beautiful overtures by Mozart to *Zauberflöte* and *Don Giovanni*, by Weber to *Freischütz*, and by Mendelssohn to his *Midsummer Night's Dream*, which are enriched by snatches of the more prominent airs in these operas. In the end of last century, overtures were written by Haydn, Pleyel, and other composers, as independent pieces to be played in the concert room; this sort of overture being, in fact, the early form of what was afterwards developed into the SYMPHONY (q. v.). The overture, as well as the symphony, is designated by the name *sinfonia* in Italian.

**OVERYSSEL**, a province of the Netherlands, is bounded on the N. by Friesland and Drenthe; E. by Hanover and Westphalia; S. and S.-W. by Gelderland; and W. by the Zuider Zee. It has an area of 1274 square miles; and (1863) a population of 241,333. The soil is sandy, with clay lands by the Yssel, rich pastures along the Zuider Zee and rivers, tracts of peat-land in various parts, and extensive heaths which are gradually being brought into cultivation. From south to north the province is intersected by an unbroken chain of sand-hills. The chief cities are Zwolle, Deventer, and Kampen; important manufacturing towns of less note being Almelo, Avereest, Dalfsen, Haaksbergen, Hardenberg, Hellendorp, Lonneker, Losser, Raalte, Staphorst, Steenwykerswold, Tubbergen, Weerselo, Wierden, Zwollerkerpel, &c. The principal employments are—agriculture, manufactures of various kinds, fishing, making peat, shipping, and merchandise. In 1862, of 128,709½ acres under cultivation, 65,526 were in rye, 24,453 in potatoes, 18,367 in buckwheat, 7630½ in oats, 4460 in barley; wheat, colza, beans, flax, carrots, &c., occupying smaller breadths. The stock consisted of 16,582 horses, 117,067 horned cattle, 30,352 sheep, 22,318 swine, and 8265 goats.

At the five leading markets, Zwolle, Deventer, Kampen, Almelo, and Steenwyk, besides the ground produce, were sold 3,007,981½ lbs. of butter, of 17½ oz. avoirdupois per lb. In O., 331,114 acres are still waste lands, 261,926 are in pasture, and 7338½ in wood.

Carpets are manufactured at Deventer and Kampen, leather at Blokzyl, calicoes and other cotton fabrics at Kampen, Almelo, Dalfsen, Ommen, and many other towns. There are extensive brick-works at Ryssen, Zwollerkerpel, Markeio, and Dispenveen, producing (1862) a yearly aggregate

of 43,760,000. Ship-building is carried on at Zwartsluis, Vollenhove, Steenwykerwold, Avereest, &c.

There are 74 Dutch Reformed clergymen, 98 Roman Catholic priests, and a few churches belonging to smaller Protestant sects. The attendance at school is about 1 to 9 of the population. In 1862, the births amounted to 7318, of which 206 were illegitimate, or about 1 to 35½; the deaths were 5673, or about 42 to the 1000 of the population.

The principal rivers are the Yssel, into which the Schipbeek runs, and the Overyselsche Vecht, which falls into the Black Water. Other important water-ways are the Dedems-Vaart and the Willems-Vaart canals. The island of Schokland, in the Zuider Zee, belongs to Overysel.

**O'VID** (PUBLIUS OVIDIUS NASO), the descendant of an old equestrian family, was born on the 20th March 43 B. C., at Sulmo, in the country of the Peligni. He was educated for the bar, and under his masters, Arellius Fuscus and Porcius Latro, he became highly proficient in the art of declamation. His genius, however, was essentially that of the poet, and the writing of verses began to absorb the time that should have been spent in the study of jurisprudence. His father, having but a scanty patrimony to divide between two sons, discouraged this tendency in the younger, but in vain. By the death of his elder brother, O. inherited all his father's property, and went, for the completion of his education, to Athens, where he acquired a perfect mastery of the Greek language. He afterwards made a tour in Asia and Sicily along with the poet Macer. It is uncertain whether, on his return to Rome, he ever practised as advocate. Although by birth entitled to aspire to the dignity, he never entered the senate; his weakness of body and indolence of habit prevented him from ever rising higher than from the position of triumvir capitalis to that of a decemvir, who convened and presided over the court of the centumviri. While his public life was unimportant, his private was that of a gay and licentious man of letters. The restraint of the matrimonial tie was always distasteful to him; twice married in early life, he soon divorced each of his wives; while he carried on an intrigue with a lady whom he celebrated as Corinna, and who is believed to have been no other than Julia, the accomplished daughter of Augustus. Before his thirtieth year, he married a third time, and became the father of Perilla, of whom he was tenderly fond. Up till his fiftieth year, he resided chiefly at Rome, in a house near the Capitol, and occasionally visited his Pelignian estate. His society was much courted, and his large circle of distinguished friends included Augustus and the imperial family. By an edict of the emperor, however, he was, in 9 A. D., commanded to leave Rome for Tomi, a town near the delta of the Danube, and on the very limit of the empire. The sentence did not condemn him to an *exilium*, but to a *relegatio*—or in other words, he did not lose his citizenship, nor was he cut off from all hope of return. The cause of this sudden banishment has long divided the opinion of scholars, since the one mentioned in the edict—the publication of his *Ars Amatoria*—was a mere pretext, the poem having been in circulation for ten years before. His intrigue with Julia, or with Julia's daughter, and the consequent displeasure of Augustus or of Livia, have been adduced with various degrees of plausibility, as the cause of a sentence to which O. himself only mysteriously refers. The misery of his life on the inhospitable and barbarous shore of the Euxine is commemorated by the poems in the composition of which he found his solace. He became a favourite with the Tomites, whose language he learned, and before



whom he publicly recited some poems in honour of Augustus. But his devotion to the emperor, and the entreaties addressed to the imperial court by himself and his friends, failed to shorten the term, or to change the scene of his banishment; so he died, an honoured citizen of Tomi, 18 A. D., in his sixtieth year. His works which have come down to us, either in whole or in part, appeared in the following order: 1. *Amorum Libri III.*, a revised and abridged edition of an early series. 2. *Twenty-one Epistolæ Heroidum*. 3. *The Ars Amatoria*. 4. *Remedia Amoris*. 5. *Nux*, the remonstrance of a nut-tree against the ill-treatment it receives from the wayfarer, and even from its owner. 6. *Metamorphoseon Libri XV*. This is deservedly O.'s best-known work. It seems to have been written between the poet's fortieth and fiftieth years, and consists of all the transformations recorded in legend from the creation down to the time of Julius Cæsar, whose change into a star forms the last of the series. 7. *Fastorum Libri XII.*, the first six of which are all that remain. The poem is a Roman calendar versified, and describes the appropriate festivals and mythic legends from materials supplied by the old annalists. 8. *Tristium Libri V.*, written in elegiac metre, during the first four years of the poet's banishment. They are mainly descriptive of his miserable fate, and are full of appeals to the clemency of Augustus. 9. *Epistolarum ex Ponto Libri IV.*, also written in elegiac metre, and similar in substance to the *Tristia*. 10. *Ibis*, a short satire against some traducer of the poet's. 11. *Consolatio ad Liviam Augustam*, held spurious by some critics. 12. *Melicamina Faciei* and *Haliecticon*, dubiously genuine, and of which we possess but fragments. Several of his works are entirely lost, the one best known to antiquity being *Medea*, a tragedy.

The poetical genius of O. has always been admired. A masterly facility of composition, a fancy vigorous and rarely at fault, a fine eye for colour, and a versification very musical in its flow, are the merits which have made him a favourite of poets from Milton downwards, in spite of his occasional slovenliness and falsity of thought. The best editions of O.'s entire works are Burmann's (Amsterdam, 1727), and the recent one of Merkel; while excellent commentaries on one or other of his poems have been published by Haupt, Ramsay, and Paley. A good translation of his *Metamorphoses* is that edited by Garth, with the assistance of Dryden, Addison, Congreve, and others; while special passages of the same poem have been admirably rendered by Mr D'Arcy Thompson.

OVIEDO, a pleasant and healthy city of Spain, capital of the modern province of the same name (the ancient Asturias, q. v.), stands on a plain between the rivers Nalon and Nora, 61 miles north-north-west of Leon, and 22 miles south-south-west of Gijon, on the Bay of Biscay. In the centre of the city is a handsome square, from which four principal streets, terminating in alamedas or promenades, branch off toward the north, south, east, and west, respectively. These main streets are connected by others, and all are clean and well-paved. Pure water is abundantly supplied by means of a long aqueduct, and is delivered in the city by eleven public fountains. The cathedral, a beautiful cruciform specimen of Gothic, the ornamentation of which is as rich as it is elegant, contains (in the Chapel of the Virgin) the remains of many of the early kings and princes of Asturias, and has a fine old library. Some curious, but eminently questionable relics, are to be found in the church of *San Miguel*, which is the second oldest Christian building after the Moorish

invasion. In the immediate vicinity of the city there are other churches in the early Saxon style, which are among the oldest churches in the peninsula. The convent of San Vincente, founded in 1281, has been secularized, and is now occupied by government offices, &c. Linens, woollens, hats, and firearms are manufactured. Pop. about 10,000.

O. was known during the middle ages as *Civitas Episcoporum*, because many of the Spanish prelates who had been dispossessed of their sees by the Moors, took refuge here. This city, which is the see of a bishop, was twice plundered of its ecclesiastical and other treasures during the war of independence; first by Soult, and subsequently by Bonnet.

OVIEDO Y VALDES, GONZALO FER. DE, a Spanish chronicler, born at Madrid in 1478, was sent by Ferdinand to St Domingo, in the West Indies, in 1514, as intendant and inspector-general of the trade of the New World. During his long residence in St Domingo, he spent his leisure in acquiring an extensive knowledge of the West Indies; and after his return to Spain published at Toledo, in 1526, a *Summario de la Historia General y Natural de las Indias Occidentales*, which he dedicated to Charles V. He afterwards made some additions to the work, which was republished at Seville in 1535, in 21 vols., under the title of *La Historia General y Natural de las Indias Occidentales*. He left other 29 books in manuscript. A complete edition is now being prepared at Madrid. O. died at Valladolid in 1557. Besides his *History of the West Indies*, he wrote *Las Quinquagenas*, a valuable, gossiping, and anecdotal account of all the principal personages of Spain in his time, which still remains in MS. in the royal library at Madrid; and chronicles of Ferdinand, Isabella, and Charles V. A life of Cardinal Ximenes is also attributed to him.

OVIPAROUS, a term applied to animals in which reproduction takes place by eggs (*ova*). Except the mammalia, all animals are either Oviparous or Ovoviviparous (q. v.); the latter mode—which is not essentially different from the former—being comparatively rare. Even those invertebrate animals which multiply by gemmation and division, have also a true reproduction by *ova*. See EGG and REPRODUCTION.

O'VOLO, a convex moulding much used in classic architecture. See MOULDING. In Roman architecture, the ovolo is an exact quarter of a circle; in Greek architecture, the curve is sharper at the top and quirked. It is sometimes used in *Decorated Gothic*.

OVOVIVIPAROUS, a term applied to animals of which the egg is hatched within the body of the mother, so that the young is excluded alive, although the fœtus has been enclosed in an egg almost to the time of parturition. It is probable that the egg is often broken in parturition itself. Some fishes are ovoviviparous, and some reptiles; also the *Mono-tremata*. The Common Lizard and the Viviparous Lizard, both natives of Britain, are illustrations of the near resemblance which may subsist between oviparous and ovoviviparous animals. The distinction is much less important than might be supposed.

O'VULE (Lat. a little egg), in Botany, the rudimentary seed. The Germen (q. v.) or ovary sometimes contains only one ovule, sometimes a small definite number, sometimes a large indefinite number. Ovules are to be regarded as metamorphosed buds. The single ovule contained in the ovaries of Compositæ and Grasses may be called a terminal bud, surrounded by a whorl of adhering leaves or

carpels, in the axil of one of which it is produced.—Balfour, *Manual of Botany*. The ovule is not always contained in an ovary. In *Gymnogens* (q. v.) it is wanting, and the ovule is naked; but the plants possessing this character are comparatively few. The ovule is attached to the *Placenta* (q. v.), and by it to the *Carpel* (q. v.), from which it is developed. The attachment to the placenta is either immediate, when the ovule is said to be *sessile*, or by means of an umbilical cord (*funiculus*), which sometimes elongates very much after fecundation. The ovule is, in general, essentially formed of a cellular *nucleus* enclosed by two membranes, the outer of which is called the *primine*, and the inner the *secundine*. At one end of the nucleus there is an opening of both membranes—the *foramen*—through which the access of the pollen in Fecundation (q. v.) takes place. The *Chalaza* (q. v.) unites the nucleus and these membranes at the base. When the ovule is so developed that the chalaza is at the base, and the foramen at the apex, it is said to be *orthotropal* (Gr. *orthos*, straight, *tropos*, a mode). When the ovule is bent, so that the foramen is brought near to the base, it is called *campylotropal* (Gr. *kampylos*, curved). When by increasing on one side more rapidly than on the other, the ovule has its foramen close to the base, the chalaza being carried round to the opposite extremity, the ovule is *anatropal* (Gr. *anatrepo*, to turn upside down). Anatropal ovules are very common. When the ovule is attached to the placenta, so that the foramen and chalaza are at opposite ends, the base being in the middle, it is called *amphitropal* (Gr. *amphi*, around).—When the ovule arises from the base of the germen, it is said to be *erect*; when it hangs from the apex of the cavity of the germen, it is *pendulous*; when it arises from the side of the germen above the base, it is *ascending*; when it hangs from the side of the germen below the apex, it is *suspended*. When two or more ovules are found, not only in the same ovary, but in the same cell, they generally exhibit different modes of attachment. See CHALAZA, EMBRYO, FECUNDATION, GERMEN, PLACENTA, SEED.

OWEN, DR JOHN, an eminent Nonconformist divine, descended from an ancient Welsh family, was the son of the Rev. Henry Owen, vicar of Stadham, in Oxfordshire, and was born at the vicarage in 1616. In his 12th year he was entered of Queen's College, Oxford, where he worked with amazing diligence; for years taking no more than four hours' sleep a night. In 1635 he 'commenced' M.A. At this period (if his own statement does not exaggerate) his great ambition was to acquire celebrity either in church or state, he didn't particularly care which; and he affirms the irreligiosity and worldliness of his motives with entire frankness. Yet he appears, for all that, to have been agitated even during his student-life by the *questiones vexate* of ecclesiastical politics, and made himself so conspicuous by his Anti-Laudianism, that he was forced to leave Oxford. In fact, his Puritanism had become so decided, that most of his former friends had abandoned his society. The next five or six years of his life were spent, speaking generally, in a state of anxious and melancholy introspection. When the civil war finally broke out, O. was living as chaplain with Lord Lovelace of Hurley, in Berkshire. His lordship was a royalist, and went to join the king's army, whither O., who had warmly espoused the cause of the parliament, could not accompany him. About the same time, his uncle, a gentleman of property in Wales, who, having no children of his own, meant to have made O. his heir, indignant at the zeal of Puritanism of his nephew, settled his estate upon another, and died without leaving him a farthing. The almost friendless

scholar now removed to London, where a casual sermon, preached by a stranger in Calamy's church, had the effect of imparting to his soul the peace he so ardently desired. In 1642, he published his *Display of Arminianism*, a work that proved very acceptable to the Puritan party, and drew upon him the favourable regards of the House of Commons. Soon after, the 'Committee for Purging the Church of Scandalous Ministers' presented him with the living of Fordham, in Essex. His ministrations were exceedingly popular, people coming from great distances to hear him preach. While residing at Fordham he married a lady named Rooke, by whom he had several children. Not long after he removed to Coggeshall, where his views of church government underwent a modification. Up to this point he had been a Presbyterian, but he now became a moderate Independent or Congregationalist. It is almost superfluous to add that the Presbyterian ministers—intolerant, dogmatical, and acrimonious to a degree that is scarcely credible—fell upon him at once for his apostasy, but failed to perturb his sober temper. At Coggeshall he wrote his *Salus Electorum, Sanguis Jesu* ('The Blood of Jesus, the Salvation of the Elect'), a work the result of seven years' study, and of which he himself said that 'he did not believe he should live to see a solid answer given to it.' His fame still increasing, he was sent for in 1646 to preach before the parliament. To his discourse, entitled *A Vision of Free Mercy*, he added an Appendix, in which he pleads for liberty of conscience in matters of religion. He was again chosen to preach before the House of Commons the day after the execution of King Charles I. (January 31, 1649), but discreetly avoided a vindication of the act. About this time Cromwell made his acquaintance, and thought so highly both of his preaching and character, that he insisted on O. accompanying him to Ireland, where the latter remained about half a year. In 1650, he went with Cromwell to Scotland, and resided in Edinburgh for several months; in 1651, the House of Commons appointed him dean of Christ Church, Oxford; and in 1652, when only in his 36th year, he was admitted vice-chancellor of the university. The manner in which he discharged his duties reflects the highest credit on the impartiality of his disposition. Though himself an Independent, and owing his honours directly to the Independent party, O. never shewed himself a partisan. Most of the vacant livings in his patronage were bestowed on Presbyterians; and Episcopalians were allowed to celebrate divine worship in their own way, nor could the vice-chancellor ever be induced to offer them the slightest molestation. While at Oxford, the 'Atlas of Independency,' as Wood grandiloquently dubs O., wrote his *Diatriba de Divina Justitia, his Doctrine of the Saints Perseverance, his Vindiciae Evangelicae*—against Biddle (q. v.) and the Socinians—and his *Mortification of Sin in Believers*. He was one of the well-known 'tryers' appointed to 'purge' the church of 'scandalous' (i.e., royalist) 'ministers,' and in this capacity signalled himself by his friendly offices on behalf of men of learning and merit, among whom may be mentioned the celebrated Dr Edward Pococke, professor of Arabic. A coldness now appears to have sprung up between him and Cromwell. O. is said to have been opposed to what many people call the 'ambitious' designs of the Protector, and in 1657 he was succeeded as vice-chancellor of the university by Dr Conant. The year after Cromwell's death, he was ejected from his deanery, and retired to Stadham, in Oxfordshire, where he had purchased an estate, and where he formed a congregation, to which he ministered until his removal to London shortly after the Restoration.

The writings belonging to this period of retirement, if we may so call it, are, *Communion with God*; *On the Divine Original, Authority, Self-Evidencing Light and Power of the Scriptures*; *Theologoumena, or De Natura, Ortu, Progressu, et Studio veræ Theologiæ*; and an uncritical, irreflexive, and unscholarly diatribe against Walton's *Polyglott*, in which the different readings of Scripture were learnedly set forth. In 1662, he published *Animadversions to Fiat Lux*, a treatise written by a Franciscan friar in the interests of Roman Catholicism. It was followed by works on *Indwelling Sin*, on the 130th Psalm, and on 'The Epistle to the Hebrews,' the last of which began to appear in 1668, and is usually reckoned O.'s *Magnum Opus*. In 1669 he published *Truth and Innocence Vindicated*, a reply to Samuel (afterwards Bishop) Parker's *Discourse on Ecclesiastical Polity*, and in 1673 became pastor of a large congregation in Leadenhall Street. His last publications of importance were a *Discourse Concerning the Holy Spirit* (1674); *Doctrine of Justification by Faith* (1677), a treatise still much admired by many; and *Christologia, or Glorious Mystery of the Person of Christ*.

O. in his later years was held in the highest esteem by many of the most influential personages in the land, such as the Earl of Orrery, the Earl of Anglesea, Lord Willoughby, Lord Berkley, Sir John Trevor. When drinking the waters at Tunbridge, even the Duke of York and Charles II. paid him particular attention, and had long conversations with him on the subject of Nonconformity. O. died at Ealing, 24th August 1683, and was buried in Bunhill Fields. His funeral was attended by no less than sixty noblemen. O. was the most voluminous, but by no means the most powerful writer among the Puritan divines. His prolix and passionless disquisitions, his dull, tedious, and exhausting argumentations, his lack of subtle spiritual perception, his ponderous and lumbering style, make his writings the reverse of interesting; and one can almost pardon the irreverent criticism of Robert Hall, who is said to have pronounced them 'a continent of mud.' Yet O. deserves respect for his learning and moderation. The best edition of his works was published at Edinburgh (1856, *et seq.*).

OWEN, RICHARD, was born at Lancaster, July 20, 1804. Having received his elementary education at the grammar-school of that town, he became, at the age of twenty, a student in Edinburgh University. Under the guidance of the third Monro, Alison, Jameson, and Hope in the university, and of Barclay in the outdoor school, his natural talents early developed themselves. He was an active student, and with others of kindred spirit, formed the Hunterian Society, of which he was chosen president in 1825. In 1826, he removed to London, joining the medical school of St Bartholomew's Hospital; and to the Medical Society of this institution he communicated his earliest published paper: 'An Account of the Dissection of the Parts concerned in the Aneurism, for the Cure of which Dr Stevens tied the Internal Iliac Artery,' which appeared in the *Medico-Chirurgical Transactions* for 1830. It was doubted whether so deep-seated an artery could have been reached, but he shewed that the ligature had been applied to the internal iliac, and the aneurism had in this way been obliterated.

It had been his intention to enter the navy; but when he finished his education, he accepted an appointment as assistant to Mr Clift, the Curator of the Museum of the Royal College of Surgeons, and helped him in the preparation of his catalogues of 'Pathological Specimens' (1830), 'Monsters and Malformations' (1831), but chiefly of the 'Specimens of Natural History in Spirits' (1830). He had,

about this time, the fortune to obtain a specimen of *Nautilus pompilius*, an animal almost unknown, and of great importance not only in itself, but also and chiefly because of its numerous fossil allies. The results of his careful dissection of this specimen were published in an elaborate Memoir, which at once gave him a high position amongst naturalists, for the advanced views on structure and affinities it contained.

The continued examination of Hunter's extensive collections in the College of Surgeons' Museum was his great work. This resulted in the enlargement and arrangement of the collections, and in the publication of his *Descriptive and Illustrated Catalogue of the Physiological Series of Comparative Anatomy*, which was issued in sections during 1833-1840; of his *Palæontological Catalogue*, of which the Mammals and Birds were published in 1845, and the Reptiles and Fishes in 1854; and of his *Catalogue of Recent Osteology* (1854), in which he describes 5906 specimens. The collections, which in 1828 were contained in one small badly-lighted room, in 1856, when O.'s connection with them terminated, filled ten times the original space—three large galleries having been specially erected to contain them.

O.'s position as curator of the Hunterian Museum, to which he succeeded on the death of Clift, awakened in him a special interest in its famous founder. In 1837, he published a new edition of Hunter's *Animal Economy*, adding to it all the known published papers of its author; and giving in the preface, for the first time, a descriptive narrative of Hunter's real discoveries. He afterwards edited two volumes of *Essays and Observations on Natural History, Anatomy, &c.*, by John Hunter (1861), which had been saved from Home's unprincipled and barbarous destruction of Hunter's manuscripts, by having been transcribed by Clift, who was the last articulated apprentice of Hunter. In the preface to these volumes, O. shewed the advanced views which Hunter entertained in Geology and Palæontology.

The first appointment of O. as public lecturer was to the chair of Comparative Anatomy in St Bartholomew's Hospital in 1834. Two years afterwards, he succeeded Sir Charles Bell as Professor of Anatomy and Physiology in the College of Surgeons, and was in the same year appointed by the College as first 'Hunterian Professor.' For twenty years he continued to illustrate the recent and fossil treasures of the museum, until, in 1856, he was appointed Superintendent of the Natural History Department of the British Museum, when his connection with the College of Surgeons ceased.

We have not space to record even the principal of O.'s numerous published papers. His earliest communications to the Royal Society were papers on the generation of the ornithorhynchus and of the kangaroo. In numerous Memoirs between 1835 and 1862, he expounded the structure and affinities of the higher quadrumana; and in these and other papers, he proposed the use of the brain-structure, as an important element in classification. It has been objected, that the particular parts to which he referred in characterising his highest class, are found in the lower classes; but the objectors forget that he does not use the existence of the parts as his characters, but only their remarkable development. A similar objection may be urged against every system of classification, for no decided line can be drawn around any group, the whole animal world being united by a gradation of structure.

His exposition of the recent and fossil birds of New Zealand is well known. He first published two elaborate papers on the anatomy of the Apteryx,

and then followed at intervals seven or eight monographs on the gigantic struthious Birds which once existed in these distant islands. His descriptions and restorations of extinct animals are perhaps the most important of all his labours. He has published a monograph of the British Fossil Mammalia and Birds, and six parts of an elaborate systematic history of British fossil Reptiles. In describing the fragmentary fossil relics brought home by Darwin from South America, he established many remarkable forms from very scanty materials, and shewed that there existed in America, during the Tertiary period, a mammalian Fauna, the individuals of which were, for the most part, of gigantic size, yet similar in type to the existing animals of that continent. Subsequently, he clearly expounded the various genera of huge sloths from the same region, whose remains were previously confounded or misunderstood. A series of fossils from Australia revealed to him a remarkable group of gigantic marsupials, resembling in type the present tenants of that island-continent. His latest palaeontological paper is his elaborate Memoir on the singular long-tailed bird from Solenhofen, in which he for the first time expounded the structure and affinities of that anomalous creature. But we cannot even record the titles of his multitudinous researches on extinct animals, and must refer our readers, for a summary of them, to his recent work, *Palaeontology* (Edin. Black, 1861).

His great work on the microscopic structure of the teeth must be named. The *Odontography*, published in 1840—1845, contains descriptions and exquisite drawings of the minute structure of a very extensive series of the teeth of every class of animals, and forms an immense store-house of information alike to the anatomist and the geologist.

He has published original papers on every branch of the animal kingdom, living and fossil; and it has been justly said of him, that 'from the sponge to man, he has thrown light over every subject he has touched.' Some idea of the magnitude of his labours may be formed from the fact, that his published productions amount to more than 300 different papers and works, many of them being of the most voluminous and laborious character.

O., in 1835, married the only daughter of Clift, his colleague at the College of Surgeons. In 1858, he resumed his position as Fullerian Professor of Physiology in the Royal Institution of Britain, which, some 20 years before, he had filled for two sessions; and in the following year, he was appointed Reade Lecturer by the University of Cambridge. He is a Fellow and active member of most of the metropolitan scientific societies, and an honorary member of many foreign societies. In 1858, he was elected one of the eight foreign Associates of the Institute of France, in the room of the great botanist, Robert Brown. From France he also received the order of the Legion of Honour; from Prussia, the *Ordre pour le Mérite*; and from Italy, the Order of St Maurice and St Lazare.

OWEN, ROBERT, a social theorist and schemer, was born on the 14th of May 1771, at Newton, in Montgomeryshire. He does not appear to have had any more than a merely commercial education to fit him for common business. The point from which his peculiar destiny in life may be said to have started, was his marriage in 1799 to the daughter of Oavid Dale, the owner of the celebrated cotton mills at New Lanark, on the Clyde. This establishment was very successful as a money speculation, and it is curious that Jeremy Bentham made a small fortune by investing in it. Mr Dale was known to be a thorough man of business, but whether O., by his peculiar faculties for organisation, contributed to

the prosperity of the establishment in its early stages, is a doubtful question. It is certain that as his larger schemes developed themselves, he was felt to be a dangerous partner in a good business, and he was gradually elbowed out of any voice in the management, and he finally disposed of his share in the property.

It should be remembered, however, of a man whose life will go down to posterity as one long absurdity, that in his connection with New Lanark Mills he did real practical good on a scale by no means limited. He was naturally active and interfering, and being a humane man, it struck him that much degradation, vice, and suffering arose from the disorganised manner in which the progress of machinery and manufactures was huddling the manufacturing population together. He introduced into the New Lanark community education, sanitary reform, and various civilising agencies, which philanthropists at the present day are but imperfectly accomplishing in the great manufacturing districts. The mills became a centre of attraction. They were daily visited by every illustrious traveller in Britain, from crowned heads downwards, and it was delightful not only to see the decency and order of everything, but to hear the bland persuasive eloquence of the garrulous and benevolent organiser.

A factory was, however, far too limited a sphere for his ambition. He wanted to organise the world; and that there might be no want of an excuse for his intervention, he set about proving that it was in all its institutions—the prevailing religion included—in as wretched a condition as any dirty demoralised manufacturing village. Such was the scheme with which he came out on the astonished world in 1816, in his *New Views of Society, or Essays on the Formation of the Human Character*; and he continued, in books, pamphlets, lectures, and other available forms, to keep up the stream of excitement till it was stopped by his death. He had at least three grand opportunities of setting up limited communities on his own principles—one at Romney, in America; a second at Orbiston, in Lanarkshire; the third at Harmony Hall, in Hampshire, so lately as the year 1844. They were, of course, all failures, and O. attributed their failure to their not being sufficiently perfected on his principles. His life was a remarkable phenomenon, from the preternatural sanguineness of temperament which, in the face of failures, and a world ever growing more hostile, made him believe to the last that all his projects were just on the eve of success. In the revolution of 1848 he went to Paris, with hopes of course on the highest stretch; but his voice was not loud enough to be heard in that great turmoil. He appeared at the meeting of the Social Science Association at Liverpool in the autumn of 1858, with all his schemes as fresh and complete as ever, but it was their last resuscitation. He died a few weeks afterwards, on 17th November 1858.

OWL, a numerous and extremely well-defined group of birds, constituting the Linnæan genus *Strix*, now the family *Strigidae*, the whole of the nocturnal section of Birds of Prey. The aspect of the owls at once distinguishes them from all other birds, being rendered very peculiar by the large size of their heads, and by their great eyes, directed forwards, and surrounded with more or less perfect discs of feathers radiating outwards, whilst the small hooked bill is half concealed by the feathers of these discs, and by bristly feathers which grow at its base. The bill is curved almost from its base; the upper mandible not notched, but much hooked at the tip. The claws are sharp and curved, but, like the bill, less powerful than in the *Falconidae*. The outer toe is generally reversible at

## OWL.

placare, so that the toes can be opposed two and two, to give greater security of grasp. The wings, although generally long, are less adapted for rapid and sustained flight than those of the diurnal birds of prey, and the bony framework by which they are supported, and the muscles which move them, are less powerful; the owls in general taking their prey, not by pursuit, but by surprise, to which there is a beautiful adaptation in the softness of their plumage, and their consequently noiseless flight; the feathers even of the wings being downy, and not offering a firm resisting surface to the air, as in falcons. The soft and loose plumage adds much to the apparent size of the body, and also of the head; but the head owes its really large size to large cavities in the skull between its outer and inner tables or bony layers, which cavities communicate with the ear, and are supposed to add to the acuteness of the sense of hearing. This sense is certainly very acute, and the ear is, in many of the species, very large. It is furnished with an external conch, which is found in no other birds. It is, however, concealed by the feathers, being situated on the outside of the disc which surrounds the eye; but the feathers immediately surrounding the ear are arranged in a kind of cone, serving a purpose like that of an ear-trumpet. In some species, the ear is furnished with a remarkable lid or operculum, which the bird has the power of opening and shutting at pleasure. The disc which surrounds the eye serves to collect rays of light and throw them on the pupil; and owls can see well in twilight or moonlight, but are generally incapable of sustaining the glare of day, many of them becoming quite bewildered when exposed to it, and evidently suffering pain, which they instinctively seek to relieve by frequent motion of the third eyelid or nictitating membrane of the eye. The legs and feet of owls are feathered to the toes, and in many species even to the claws.

The digestive organs much resemble those of the Falconidæ, but there is no crop, and the stomach is more muscular. The gullet is very wide throughout, and owls swallow their prey either entire or in very large morsels. The largest species feed on hares, fawns, the largest gallinaceous birds, &c.; others on small mammalia, reptiles, birds, and sometimes fishes; some feed partly or chiefly on large insects.

The owl has from early times been deemed a bird of evil omen, and has been an object of dislike and dread to the superstitious. This is perhaps partly to be ascribed to the manner with which it is often seen suddenly and unexpectedly to flit by when the twilight is deepening into night; partly to the fact, that some of the best-known species frequent ruined buildings, whilst others haunt the deepest solitudes of woods; but, no doubt, chiefly to the cry of some of the species, hollow and lugubrious, but loud and startling, heard during the hours of darkness, and often by the lonely wanderer. It is evidently from this cry that the name owl is derived, as well as many of its synonymes in other languages, and of the names appropriated in different countries to particular species, in most of which the sound *Oo* or *Ow* is predominant, with great variety of accompanying consonants. Many of the owls have also another and very different cry, which has gained for one of them the appellation screech owl, and to which, probably, the Latin name *strix* and some other names are to be referred.

Some of the owls have the discs of the face imperfect above the eyes, the whole aspect somewhat approaching to that of falcons; the conchs of the ears small, and the habits less nocturnal than the rest of this family. These constitute one of the three generally received divisions in which the species are

arranged. Another division, with more perfect discs around the eyes, is characterised by the presence of two feathery tufts on the head, popularly called horns, or ears, and sometimes egrets or aigrettes. The third division is destitute of these tufts, the discs of the face are perfect, and the ears are very large. On these distinctions, and on the feathered or unfeathered toes, and other points not of great importance, are founded the genera into which the Linnæan genus *Strix* has been broken down by recent ornithologists. See, for example, the characters of *Bubo* in the article EAGLE OWL.

Owls are found in all parts of the world, and in all climates. Ten species are reckoned as natives of the British Islands, some of which, however, are very rare, and about fifteen are natives of Europe. Some of the species have a very wide geographical range. One of the most plentiful British species is the WHITE OWL, or BARN OWL, or SCREECH OWL (*Strix flammea*), one of those having perfect discs around the eyes, and no aigrettes. It is about fourteen inches in its whole length. The tail is, as in most of the owls, rather short and rounded; the



1. Great or Eagle Owl (*Bubo maximus*); 2. Snowy Owl (*Nyctea nyctea*); 3. Virginian Kestrel Owl (*Bubo virginianus*); 4. White or Barn Owl (*Strix flammea*); 5. Long-eared Owl (*Otus vulgaris*); 6. Foot of Snowy Owl.

wings reach rather beyond the tail. The toes are not feathered. The head and upper parts are of a pale orange colour, marked by a multitude of small, scattered chestnut-coloured spots, and gray and brown zig-zag lines; the face and throat white. This owl very generally frequents old buildings and outhouses. It destroys great numbers of rats and mice, and deserves the protection of the farmer. The voracity of owls is wonderful, and they kill, if possible, more than they need, storing it up for future use. The barn owl is easily tamed if taken young. When irritated, it has, like some other—perhaps all—owls, a habit of hissing and snapping its mandibles together. It almost never leaves its retreat by day, unless driven out; and when this is the case, all the little birds of the neighbourhood congregate about it as an enemy which may then be safely annoyed, and the grimaces of the poor owl, blinded by the too strong light, are very grotesque and amusing. This species has been said to be an inhabitant of almost all parts of the world, but there is reason to think that similar species have been confounded.—The TAWNY OWL, BROWN OWL, or IVY OWL (*Strix*, or *Syrnium, atritula* or *aluco*) is another of the most common British owls.

a species about the size of the barn owl, or rather larger, with rather longer tail, and comparatively short wings, the feet feathered to the claws; the upper parts mostly ash-gray mottled with brown, the under parts grayish-white and mottled.—The LONG-EARED OWL (*Strix otus*, or *Otus vulgaris*) and the SHORT-EARED OWL (*S.* or *O. brachyotos*), species with aigrettes, are not unfrequent British birds. The EAGLE OWL (q. v.) occurs, but is rare.—Of the species with imperfect discs around the eyes and more falcon-like aspect, the most interesting in the British fauna is the SNOWY OWL (*Strix*, or *Surnia, nyctea*), the *Harfang* of the Swedes, a species occasionally seen in the Shetland Islands, and very rarely in more southern regions in winter, but well known in all the very northern parts of the world. It is from 22 to 27 inches in length, feeds on every kind of animal food which it can obtain, and has white plumage spotted and barred with brown, the legs densely feathered to the claws.—Of owls not natives of Britain, one of the most interesting is the BURROWING OWL (*Strix*, or *Athene, cucularia*), a North American species, which, when necessary, excavates a burrow for itself, but prefers to take possession of those of the marmot, called the Prairie Dog (q. v.). It is not the only species of owl which inhabits holes in the ground.—The BOOBOOK or BOOKBOOK of Australia (*Strix*, or *Noctua, Doo-book*) is a species of owl, which frequently repeats during the night the cry represented by its name, as if it were a nocturnal cuckoo. Some of the species of owl are small birds; among the rarer British species are one of 8½ inches, and one scarcely more than 7 inches long. Some owls are at least partially birds of passage, of which, among British species, the short-eared owl is an example.

OWLGLASS (Ger. EULENSPIEGEL), TYLL, the prototype of all the knavish 'fools' of later time, is said to have been born in the village of Kneitlingen, in Brunswick. His father was called Klaus Eulenspiegel, and his mother Anna Wortbeck. In youth, we are told, he wandered out into the world, and played all manner of tricks on the people whom he met with. His tomb is shewn at Mölln, about four leagues from Lübeck, where tradition makes him die about 1350; but the inhabitants of Damme, in Belgium, also boast of having his bones in their churchyard, and place his death in 1301, so that several critics regard Eulenspiegel as an altogether imaginary person, a mere *nominis umbra* affixed to a cycle of medieval tricks and adventures. The opinion, however, considered most probable is that Eulenspiegel is not a myth, but that there were two historical individuals of that name, father and son, of whom the former died at Damme, and the latter at Mölln. The stories that circulate in Germany under Eulenspiegel's name were not collected, as the book containing them itself informs us, till after Eulenspiegel's death, and without doubt were originally written in the Low German tongue; from Low German, they were translated into High German by the Franciscan Thom. Murner, and this translation was followed in all the old High German editions of the work. At a later period, it underwent considerable alterations, at the hands of both Protestants and Catholics, who made it a vehicle for the expression of their own likings and dislikings. The oldest known edition is that printed at Strasburg in 1519. The verdict of modern times has been unfavourable, not only to the æsthetic, but to the moral value of the book; yet although indecencies may be found abundantly in it, they may perhaps in large measure be attributed to the age in which Eulenspiegel or the author of Eulenspiegel lived. For centuries it has been a favourite people's book, not only in Germany, but in many other countries.

Translations of it exist in Bohemian, Polish, Italian, English (as a *Miracle Play*), Dutch, Danish, French, and Latin; it has been frequently imitated, and reprinted times without number down to the most recent years. Max Müller, in his *Lectures on the Science of Language* points out that Eulenspiegel is the origin of the French word *espigole*, waggish. When the stories about Eulenspiegel were translated into French, he was called Ulespiègle, 'which name contracted afterwards into *Espigle*, became a general name for every wag.'

OWNERSHIP is not a legal term, though it is used frequently in law to denote the highest degree or kind of property which one can have in anything. Owner is often used in this sense as contradistinguished from an occupier, who has only a temporary interest in the property. Thus a freeholder, or one who holds a freehold estate in land, is an owner; though, in common parlance, it is not unusual also to describe as owner any one who has a long lease of the property. When a person is owner in fee of land, he has certain rights more or less absolute as incidental thereto; for example, he may build on his land as high as he pleases, subject only to doing no direct injury to his neighbour, such as darkening his windows; and he may dig as deep as he pleases, or, as it is said, to the centre of the earth. There are certain things which are said to be incapable of ownership, such as the air, the sea, and the water of navigable rivers, as to each of which every individual member of the public has the right merely of using it, but no one has the ownership—i. e., the exclusive right of property as well as possession thereof. As to things wild, such as birds, beasts, fishes, the rule is that he who first catches the animal becomes the owner thereof, and acquires such a property in it, that any one who takes it from him against his will commits larceny. But though the person who first catches a wild animal is entitled to it, penalties are sometimes imposed upon the person catching it, as to which see GAME, POACHING. In regard to lost property—i. e., property which had once been appropriated and possessed by some one, but who has casually lost or abandoned it—the rule is that he who finds it is entitled to keep it, provided at the time of finding it he had no means of ascertaining the owner. But the true owner, if he discover and can identify the property, can always in general reclaim it from the finder. See LOST PROPERTY.

OX (*Bos taurus*), a ruminant quadruped of the family *Bovide* (q. v.), the most useful to man of all domesticated animals. The species is distinguished by a flat forehead, longer than broad; and by smooth and round tapering horns, rising from the extremities of the frontal ridge. But among the many varieties or breeds which exist, there are great diversities in the length and curvature of the horns, and some are hornless. It is probable that the ox is a native both of Asia and of Europe, perhaps also of Africa; and not improbable that it may have been domesticated at different times and in different countries. It cannot be confidently asserted that it now exists anywhere in a truly wild state; wild oxen are nowhere so abundant as on the pampas or great grassy plains of South America, where it is certain that they are not indigenous; and it is not impossible that the wild oxen still existing in the parks of a few noblemen in Britain may be also descended from domesticated animals. Whether or not the URUS, described by ancient authors as an inhabitant of Central Europe, was the original of the domestic ox, will be considered in the article URUS. The very early domestication of the ox is attested by the mention made of it in the writings of Moses,

and by the worship of it in Egypt, which the Israelites imitated in making their golden calf at Mount Sinai. Yet oxen do not appear to have formed any part of the wealth of the patriarchs. The ox was probably used as a beast of burden or draught before it was valued for its milk. It is mentioned by Cæsar as a principal part of the wealth of the Britons at the time of the Roman invasion.

The ox is more frequently employed as a beast of burden and of draught in some parts of the continent of Europe than in Britain. From the earliest historic times, the horse has been more generally thus employed in Britain, and has now almost entirely superseded the ox. The gait of the ox is slow and plodding, but its strength enables it to perform a great amount of work, and it is not easily exhausted. It needs, however, intervals of rest inconvenient for the farmer; and it is not capable of exertion at all equal to that of the horse on any occasion of emergency.—The ox is chiefly valuable for its flesh and its milk; but almost every part of the animal is useful—the fat, skin, hair, horns, intestines.

The period of gestation of the ox is nine months, or 270 days. It rarely produces more than one calf at a birth. It attains maturity in two or three years, becomes evidently aged at ten, and seldom lives more than fourteen. Cows are seldom kept for the dairy after they are seven or eight years old, as after that age they yield less milk and of inferior quality. Modern husbandry has also found means to fatten cattle for the market at an earlier age than was formerly usual; and although the beef is not quite so good in quality, the profit is great, both to the farmer and to the community, through the increased productiveness of the land.

The ox is gregarious, and where circumstances permit, as in the South American plains, associates in very large herds. Herds of oxen defend themselves with great vigour against the large feline animals and other assailants, the younger and weaker animals being placed in the middle, whilst the bulls in the outer rank confront the adversary with their horns.

The varieties or breeds differ very much in size. Among those which occur in the British Islands, the Shetland breed is not much larger than a calf of some of the others. Some of the breeds of the torrid zone are also very small; but the fatty hump on the back may probably be regarded as indicating a connection with the Indian ox or Zebu (q. v.), which, although it has been generally regarded as a variety of the common ox, is perhaps a distinct species.—The 'wild ox,' now existing only in a few parks, as at Chillingham and Hamilton, seems, whatever its origin, to have been formerly an inhabitant of many forest districts in Britain, particularly in the north of England and south of Scotland. The Chillingham wild oxen are of a creamy white colour, much smaller than many of the domestic breeds, of a graceful form, with sharp horns, which are not very long, and not very much curved. The uniform white colour is to be ascribed to the care taken to destroy every calf which is not perfect in this respect. The habits of these wild oxen are very similar to those of the domestic races.

—The *West Highland* breed, or *Kyloe*, differs very little from the Chillingham or Hamilton wild ox, except in being generally black. It has short muscular limbs, a wide and deep chest, well-arched ribs, and a straight back; the horns are often somewhat long; the muzzle is short but not broad; the skin is closely covered with shaggy hair. The milk is very rich, but the quantity is so small, that this breed is very unsuitable for dairy farming. The beef,

however, is of the finest quality; and great numbers of cattle, reared in the Highlands and Hebrides, are annually conveyed to other parts of the country, to be fattened on rich pastures. The breed is a very hardy one, and peculiarly suited to the region in which it prevails.—The *Galloway* breed is very like the preceding, but larger and destitute of horns; and many cattle reared in the hilly parts of Galloway are fattened on English pastures for the London market.—The *Pembroke* and other Welsh breeds are not unlike the West Highland; but the cows yield milk more abundantly.—The diminutive *Shetland* breed is very hardy, and is celebrated for the fine quality of its beef. The Shetland ox is easily fattened, even on scanty pasturage. The milk which the cows yield is also remarkably abundant in proportion to their small size.—The *Ayrshire* breed is particularly celebrated for the abundance and excellence of its milk, but the beef is of inferior quality, and the animal is not easily fattened. Great care has been bestowed on this breed in Ayrshire and neighbouring counties, where dairy farming is much practised. The horns are smaller than those of the West Highland breed, the hair much smoother, and the colour chiefly brownish-red, with large patches of white.—The *Alderney* breed much resembles the Ayrshire, but the milk is comparatively small in quantity, and remarkable for the richness of the cream, on which account Alderney cows are often kept for the supply of private dairies. The milk of an Alderney cow, mixed with that of a dozen other cows, will sensibly improve the quality of the butter. But this breed is worthless for the purposes of the grazier.—The *Suffolk Dun* is a *polled* or hornless breed, of clumsy form, and of little value to the grazier, but yielding a very large quantity of milk, on which account Suffolk has long been celebrated for its dairy produce.—The *North Devon* is a pretty large breed, with rather short horns, very muscular and powerful, and also very gentle and docile, so that it is particularly adapted for draught; and much agricultural labour is still performed in Devonshire by teams of oxen of this breed. The North Devon breed, however, is surpassed by others, both for the purposes of the dairy farmer and of the grazier.—The *Hereford* breed, of stouter form than the Ayrshire, but



Bull (short-horn).

in some respects not unlike it, has long been in great repute both for its beef and its milk; but in the districts where it once prevailed, it is now giving place to the *Short-horn* breed, one of the new breeds which are the result of care and attention. The Short-horn breed, so called because the horns are shorter than in almost any other, originated about the beginning of the 19th c. on the banks of the Tees, and has spread very widely both

in England and in Scotland, in the districts of richest pasturage. The colour varies from pure white to bright red; the head is short and very broad; the chest is wide, deep, and projecting; the fore-legs are short, the back straight, and not very long, the 'barrel' full. The ease with which oxen of this breed are fattened is one of its great recommendations. The beef is also of excellent quality. For dairy purposes, the Short-horn is surpassed by some other breeds; but a cross between a Short-horn bull and an Ayrshire cow is found useful both for beef and milk. The Short-horn breed is now cherished in Britain with peculiar care; genealogies are registered, and prodigious prices are given for first-rate animals. It is also in great esteem in many parts of the continent of Europe, and in America.—The *Long-horn* breed, long prevalent in the midland counties of England, and still prevalent in Ireland, was brought to great perfection by Bakewell, one of the first to shew what could be done in the improvement of cattle; but is rapidly giving place to the Short-horn, by which it is much excelled. The length of the horns in this breed is very remarkable.

Of foreign races of oxen, one of the most notable, on account of its large size, is that in possession of the Kalmuck Tartars; another is that prevalent in the Roman states, generally of a bluish-ash colour, with remarkably large and spreading horns. A large white breed was long kept in Egypt; and a similar breed, without the hump characteristic of the Indian Ox, is found in South Africa, where, however, it has become partially intermixed with European breeds. Oxen are much employed by the Kaffirs as beasts of burden; they were also formerly trained by the Hottentots to aid them in battle. Peter Kolben, in his account of the Cape of Good Hope, written in 1705, gives an interesting description of these trained fighting oxen, which, he says, are called *Backeleyers*. 'In the wars of the Hottentots with one another,' he says, 'these backeleyers make very terrible impressions. They gore, and kick, and trample to death with incredible fury.' He ascribes to them also great docility, and states that they know every inhabitant of the kraal, and are perfectly inoffensive towards them, but ready to run with fury at strangers. The readiness with which the draught oxen of South Africa observe the words of the driver, is said to be almost, if not quite, equal to that of the dog. In the training of them, however, severe measures are often requisite, and particularly by a hooked stick inserted through the cartilage which separates the nostrils, as bulls are *ringed* when sent to exhibitions of cattle in Britain. Trained oxen are also employed in the training of their younger fellows. In some parts of Africa the ox is used for riding as well as for draught. The horns, which are very long, are split into ribbons, or curved in various directions, to prevent their points from coming in contact, by any accident, with the person of the rider. The pace of the ox scarcely exceeds four or five miles an hour.

A very remarkable conformation of skull occurs in some of the herds of South American oxen, the bones of the nose and the jaw-bones being very much shortened; yet there is no question that this is a mere accidental variation, which has become perpetuated as one of race. Importance has been attached to it in the discussions regarding *species*.

The cow has been for ages tended by man on account of the agreeable and highly nutritious fluid which is obtained from it. Milk is manufactured into cheese and butter, which are capable of being preserved for a considerable time. The processes by which these are obtained are

described under the article DAIRY. Cows, under our modern systems of agriculture, are selected either for their properties of giving large quantities of milk, or for raising stock which are well suited for grazing and fattening. For milking properties, the Ayrshire breed stands undoubtedly at the head of the list. In comparison with some of the other breeds, the Ayrshire is rather deficient in size, with the flesh spread thinly over its body. In the male animals these characteristics are all the more prominent, and for this reason the breed is not much liked by graziers. It is capable, however, of thriving on secondary or even inferior pastures. Wherever, therefore, it is found most profitable to follow dairy husbandry in Scotland, the Ayrshire cow is preferred. A considerable variety of breeds are cultivated both for milking and grazing in the western parts of England, the principal of which are the Herefords and Devons. In the eastern counties, again, where arable culture and the rearing and feeding of cattle are chiefly followed, the Ayrshire gives place to the Aberdeen, the Angus, and the Teeswater. The cow is there selected for its massive and square-built frame, soft skin, and meat-producing qualities. For more than a century vast care has been bestowed on the improvement of the short-horns. In this breed the pedigrees of the sire and the dam are traced back for many generations, and purity of blood is quite essential in herds of any pretensions. The large sums which particular cows and bulls of this breed realise, attest the value which modern breeders set upon animals which are considered to approach perfection in their form and style. In no department of British agriculture are the results of care and attention more strongly marked than in the noble figure of the short-horned cow or bull.

The rearing and fattening of the ox is one of the most important branches of agriculture. Since the prices of butcher-meat have become so much higher relatively to corn in this country, the breeding and feeding of cattle have received a great impetus. Fifty years ago, many of our old breeds of cattle were kept till they were four or five years old before they were sent fat to the butcher. The demand for meat was so limited then in the north, that most of the cattle were sent south lean, to be fattened on the pastures and turnips of the eastern counties of England. The introduction of steam-shipping, followed by railways, has given the Scotch breeder and feeder great facilities for disposing of fatted cattle, and now there are no lean cattle sent to the south. Indeed, the extension of green crops in Scotland has been so great, that large numbers of lean cattle are imported from England, as well as Ireland, to be fed in the stalls and courts during winter. This applies to the arable districts, where the land does not remain more than one year in grass. In Aberdeenshire, where the land rests from three to four years in grass, more cattle are bred and turned out fat, which is by far the most profitable system, seeing the breeder often gets a larger share of the profits than the feeder. The short-horned blood is in great request to cross with the native breeds, rendering the progeny much easier fattened, as well as causing them to grow to a larger size. It is now the most approved method to feed the calf from the time it is dropped till it is sent to the butcher. Oil-cake is generally considered the best and most healthy auxiliary food for stock, whether old or young. In the pastoral districts of England, where little of the land is cultivated, the rearing of cattle to be sent into the arable districts is carried out. The young animals are fed with hay in winter instead of straw and turnips. Large numbers of cattle are fattened on turnips and



## OXALIC ACID—OXALIDEÆ

mangold in winter in Norfolk and eastern counties. Large allowances of cake and corn are there given in addition to the roots.

**OXALIC ACID** ( $C_2O_3, 2HO + 4Aq$ ) occurs in colourless, transparent, oblique, rhombic prisms, which have an intensely sour taste, and are soluble in nine parts of cold water, and much more freely in boiling water. When heated to  $212^\circ$ , the crystals lose their four equivalents (or 28.5 per cent.) of water, and the residue, consisting of the hydrated acid ( $C_2O_3, 2HO$ ), becomes opaque; these two equivalents of water contained in the hydrated acid, cannot be expelled by mere heat, although they can be displaced by an equivalent amount of a metallic oxide. When the crystallised acid is rapidly heated to about  $300^\circ$ , it is decomposed into a final mixture of carbonic acid, carbonic oxide, and water; formic acid being produced and again decomposed in the process.

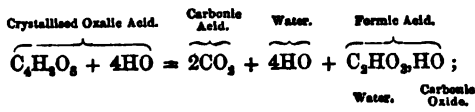

and formic acid when heated yields  $2HO + 2CO$ . When warmed with strong sulphuric acid, it is decomposed into equal volumes of carbonic acid and carbonic oxide gases, and into water; according to the equation:

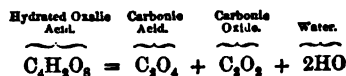

This reaction affords one of the best means of obtaining carbonic oxide for use in the laboratory. Oxidising agents, such as binoxide of manganese, peroxide of lead, nitric acid, &c., convert oxalic into carbonic acid, and on this property is based a good method of determining the commercial value of the black oxide of manganese.

Oxalic acid is one of the most powerful of the organic acids, and expels carbonic acid and many other acids from their salts. The acid itself, and its soluble salts, are poisonous. This acid is very widely diffused throughout the vegetable kingdom. Sometimes it occurs in a free state (as in *Boletus sulphureus*), but much more frequently as a salt, either of potash, as in the different species of *Oxalis* (from which genus the acid was originally obtained and derives its name), and of *Rumex*; or of soda, as in various species of *Salicornia* and *Salsola*; or of lime, as in Rhubarb and many Lichens. In the animal kingdom, it never occurs except in minute quantity and in combination with lime. Oxalate of lime is found in a crystalline shape, both in healthy and morbid urine. In the latter, it constitutes the leading symptom of the affection termed **OXALURIA** (q. v.), while in the former it occurs after the use of wines and beer containing much carbonic acid, of sorrel, rhubarb-stalks, &c., and after the administration of the alkaline bicarbonates. It is the constituent of the urinary calculus, known from its rough exterior as the mulberry calculus. Crystals of oxalate of lime have also been found in the mucus of the gall-bladder, on the mucous membrane of the impregnated uterus, and in morbid blood. They have likewise been detected in the biliary vessels and excrements of caterpillars. In the mineral kingdom these crystals have been detected in association with crystals of calcareous spar.

Oxalic acid is produced by the action of either hydrate of potash or of nitric acid upon most organic compounds of natural occurrence. Its most

common mode of preparation is by the oxidation of starch or sugar by nitric acid. The organic compound and the nitric acid are heated in a flask till all effervescence has ceased, after which the solution is evaporated, and the oxalic acid separates in crystals on cooling.

This acid forms three series of salts, viz., neutral, acid, and super-acid, which, if M represents the metal entering into the salt, may be represented by the formulæ:

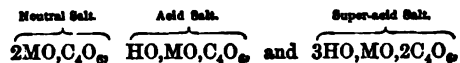

the last being a compound of the acid salt and the acid. Oxalate of lime ( $2CaO, C_2O_3 + 4Aq$ ) and ordinary (neutral) oxalate of ammonia ( $2NH_3O, C_2O_3 + 2Aq$ ) are examples of the first; binoxalate of potash, or salt of sorrel ( $KO, HO, C_2O_3 + 2Aq$ ), is an example of the second; while the salt usually termed quadroxalate of potash ( $KO, 3HO, 2C_2O_3 + 4Aq$ ) is an example of the third class. Of the numerous oxalates, the most important are the oxalate of lime (in consequence of its physiological and pathological relations); the neutral oxalate of ammonia, which is the best test for the detection of lime in solution (in consequence of the extreme insolubility of the resulting oxalate of lime); and the acid oxalate of potash, which is contained in the juices of *oxalis* and *rumex*, and is employed in various manufacturing processes.

The best test for this acid is the production of a white precipitate (of oxalate of lime), on the addition of any soluble salt of calcium. The precipitate is insoluble in water, in solution of potash, and in acetic acid, but dissolves in the mineral acids. A solution of nitrate of silver also gives a white precipitate of oxalate of silver, which explodes when heated.

In consequence of its employment in cotton printing, bleaching straw, &c., oxalic acid is more accessible to the general public than many other poisons; and on this account instances of suicide from the swallowing of this acid are by no means uncommon. Cases of accidental poisoning, moreover, sometimes occur by its being sold by mistake for Epsom salts. Large doses destroy life very rapidly. Dr A. Taylor mentions a case in which a man died in 20 minutes after taking two ounces of the acid. Dr Christison records a case in which an ounce killed a girl in 30 minutes, and another case in which the same quantity destroyed life in ten minutes; and, as a general rule (liable to exceptions), when the dose is half an ounce or upwards, death commonly takes place within the hour. The symptoms are a hot or burning acid taste, with a sense of constriction or suffocation; vomiting, great pain in the region of the stomach, convulsions, cold perspirations and general collapse speedily follow; and respiration shortly before death becomes slow and spasmodic. With the view of converting the free acid in the stomach into an insoluble and inert salt, chalk, whiting, or lime-water, with full draughts of milk, should be administered with the least possible delay. Salt of sorrel is almost as poisonous as the pure acid.

**OXALIDEÆ**, or **OXALIDEÆ**, a natural order of exogenous plants, allied to *Geraniaceæ*; including herbaceous plants, shrubs, and trees; with generally compound alternate leaves; calyx of five equal persistent sepals; corolla of five equal unguiculate petals, spirally twisted in bud; ten stamens, usually more or less united by the filaments, in two rows; the ovary usually 5-celled, with five styles; the fruit a capsule opening by as many or twice as many valves as it has cells, or

OXALIDÆ—OXENSTIERNA.

more rarely a berry; the seeds few, attached to the axis. There are upwards of 300 known species, natives of warm and temperate climates. They are particularly abundant in North America and at the Cape of Good Hope. The flora of Britain includes only two small species of *Oxalis*. An acid juice is very characteristic of this order. Some of the tropical species produce agreeable acid fruits, as the Carambola (q. v.).—The genus *Oxalis* has a capsular fruit, and the seeds have an elastic integument, which at last bursts open and projects the seed to a distance. The species are mostly herbaceous plants with ternate or digitate—rarely simple or pinnate—leaves; a few are shrubs. The stems and leaves generally contain a notable quantity of *Binocalate of Potash*, and have therefore a sour taste.—The COMMON WOOD-SORREL (*O. acetosella*), very abundant in shady woods and groves in Britain and most parts of Europe, a native also of North America, is a beautiful little plant, often covering the ground with its green leaves, amidst which the white or slightly roseate flowers appear. Its leaves all grow from the root, a long leaf-stalk bearing three obovate leaflets; the scape bears a single flower. There is a subterranean scaly root-stock. On account of their grateful acid taste, the leaves are used in salads and sauces. The plant is extremely abundant in Lapland, and is much used by the Laplanders. It is antiscorbutic and refrigerant, and an infusion of it is a grateful drink in fevers. *Binocalate of potash* is obtained from the leaves by expressing the juice, and crystallising; and is sold not only under the name of *Salt of Sorrel*, but also of *Essential Salt of Lemons*, and is used for extracting spots, and particularly iron-marks, from linen, and for other purposes. Much of it is now, however, obtained from a very different source. See OXALIC ACID.—*O. corniculata*, rare in Britain, and almost confined to the south of England, but a plant of very extensive distribution, being found in Europe, North America, India, Japan, and some of the African islands, has a branched stem, with decumbent branches, leaves very similar to those of the common wood-sorrel, and yellow flowers. Its properties agree with those of the common wood-sorrel. Many other species much resemble these in their general appearance and properties. Some of the species exhibit an irritability like that of the Sensitive Plant; generally, as in the two British species, in a slight degree, and notably only in hot sunshine, but *O. sensitiva*, an East Indian species, with pinnate leaves, possesses this property in a high degree. Some species of *Oxalis*, as *O. cernua*, a native of South Africa, are remarkable for producing large bulbils in the axils of the lower leaves. Several species have tuberous roots, and are cultivated on account of their tubers; as *O. crenata* and *O. tuberosa*, natives of Peru and Bolivia, where they are much esteemed, and both receive the name OCA. The tubers, when cooked, become mealy like potatoes. They have a slightly acid taste. *O. crenata* has been cultivated in gardens in Britain for about thirty years, but continues to be almost exclusively an object of curiosity, being too tender for the climate, and its produce very inconsiderable in quantity. Its tubers are yellow, in size and shape like small potatoes. The succulent stalks of the leaves abound in a pleasant acid juice, and make excellent tarts and preserves. *O. tuberosa* produces numerous small tubers. The Bolivians often expose them for a long time to the sun, by which they lose their acidity, become saccharine, and acquire a taste and consistence like dried figs. *O. Deppi* is a Mexican species, with a root somewhat like a small parsnip, quite free of acidity. It is much cultivated in its native country, and succeeds well in the

southern parts of England. *O. tetraphylla* and *O. crassicaulis*, natives of Mexico, and *O. enneaphylla*, a native of the Falkland Islands, also have eatable roots. Many species of *Oxalis* are much esteemed as ornaments of gardens and green-houses.

OXALU'RIA, or THE OXALIC ACID DIA'THESIS, is a morbid condition of the system, in which one of the most prominent symptoms is the persistent occurrence of crystals of oxalate of lime in the urine. These crystals most commonly occur as very minute transparent octohedra, but sometimes in the form of dumb-bells; in order to detect them, the urine, which usually in these cases presents a mucous cloud, should be allowed to stand for some hours in a conical glass, and after the crystals have gradually subsided, the greater part of the fluid should be poured away, and the drops remaining at the bottom examined with a power of not less than 200 diameters. These crystals, which are insoluble in acetic acid, may occur either in acid or in alkaline urine. Persons who secrete this form of urine are usually dyspeptic, hypochondriacal, and liable to attacks of boils, cutaneous eruptions, and neuralgia. The oxalic acid, in these cases, is not introduced into the system with the food, but is a product of the disintegration of the tissues, and is due to the imperfect oxidation of compounds, which should normally have been converted into carbonic acid. (Anhydrous oxalic acid,  $C_2O_6$ , obviously requires 2 equivalents of oxygen to be converted into carbonic acid,  $C_2O_2$ , or  $4CO_2$ . Hence, if these two equivalents of oxygen are wanting in the system, in consequence of imperfect oxygenation of the blood, oxalic acid, in combination with lime, appears as a final excretion in place of carbonic acid.) The occurrence of oxalic acid as a persistent sediment in the urine, is not only an indication of an existing morbid condition of the system, but may give rise to two perfectly distinct dangerous complications; (1) a concretion of oxalate of lime (mulberry calculus) may be formed either in the kidney or the bladder; and (2) bad consequences may arise from the poisonous action of the oxalic acid on the digestive organs, on the heart, and on the nervous system.

The treatment is simple. Care must be taken that the patient should avoid articles of diet containing oxalic acid (such as sorrel, rhtbarb, tomatoes, &c.), or readily converted into it (such as sugar), and all drinks containing much carbonic acid; while he should take plenty of exercise in the open air, without fatiguing himself; should use the shower-bath, unless he feels chilled and depressed after its application, in which case he should rub the body all over daily with a horse-hair glove; and should employ as a tonic medicine either a little nitromuriatic acid in a bitter infusion (20 minims of the acid in an ounce and a half of Infusion of Chyretta), or five grains of citrate of iron and quinine three times daily. Under this treatment, the oxalates usually almost entirely disappear from the urine in two or three weeks.

OXENSTIERNA, AXEL, COUNT, an illustrious Swedish statesman, was born at Fåuö, in Uppland, 16th June 1583. He was originally educated for the church, and studied theology as well as jurisprudence at Rostock, Jena, and Wittenberg, in the last of which universities he took his degrees. Although he afterwards devoted himself to public affairs, he continued all his life to take a deep personal interest in religious questions, and laboured zealously for the extension of the Protestant doctrine. After leaving the university, he visited most of the German courts, but returned to Sweden in 1603, and soon afterwards entered the service

of Charles IX., who, in 1606, despatched him as ambassador to the court of Mecklenburg. He became a senator in 1608—a dignity which had been enjoyed by thirteen of his predecessors in uninterrupted succession. Having displayed great prudence and wisdom in the settlement of certain disputes between the Livonian nobles and the town of Reval, he was appointed by Charles—now infirm from age—guardian of the royal family, and head of the regency. On the accession of Gustavus Adolphus (q. v.), in 1611, O. was made chancellor; and in 1613, acted as minister-plenipotentiary in the negotiations for peace between Sweden and Denmark. In the following year he accompanied his sovereign to Poland, and by the peace of Stolbova, in 1617, terminated hostilities between Sweden and Russia. His political sagacity was not less conspicuously shewn in his successful efforts to prevent Gustavus from marrying Ebba Brahe, a Swedish beauty, and in bringing about a match between his master and the Princess Maria-Eleonora of Brandenburg. In 1621, on the departure of the king for the Polish war, he was charged with the administration of affairs at home, which he conducted with his invariable felicity; subsequently, he was appointed governor-general of the conquered districts; and in 1629, concluded peace with the Poles on highly favourable conditions. For a while O. strongly opposed the desire of Gustavus to take part in the 'Thirty Years' War,' his hope being to see the latter arbiter of the north of Europe; but when he found that the Protestant sympathies of the king were irrepensible, he set about collecting money and troops for the perilous enterprise, with all the quiet but wonderful activity and persistency that so remarkably characterised him. After Gustavus had fairly entered on the bloody struggle, O. joined him, and conducted most of the extensive and complicated diplomacy which the course of events entailed on Sweden. The death of Gustavus for a moment paralysed him, but he instantly recovered, and heroically resolved to continue the contest with the imperialists, in spite of the visible disaffection of many of the German Protestant princes, among others, of the Elector of Saxony. The will of the dead monarch was sent to Stockholm; according to its conditions, the government—during the minority of Christina (q. v.)—was intrusted to five nobles, who empowered the chancellor to prosecute the war. His difficulties were enormous, yet by indefatigable efforts he managed partly to allay the discontents, jealousies, and rivalries of the Protestant leaders. The disastrous defeat of the Swedes at Nordlingen in 1634, and the perplexities which followed it, would have stupified most men in the position of O., but it only called out more energetically his splendid diplomatic genius. Transferring the leadership of the Protestant forces to Duke Bernhard (q. v.) of Weimar, he proceeded, in 1635, to France and Holland, and formed alliances with these countries. Returning to Germany, he assisted in quelling a mutiny among the Swedish troops at Magdeburg; put Pomerania in a state of defence, to resist the meditated attack of the Elector of Brandenburg; renewed the treaty with Poland; and leaving Baner in command of the Swedes, returned to Stockholm in 1636, where he was received with the liveliest enthusiasm. He still continued, however, to direct ably the policy of the Protestants in Germany, till the peace of Westphalia, in 1648, put an end to the war. O.'s son was one of the Swedish envoys who signed the treaty, and it is in a letter to him that the famous sentence of the statesman occurs, *Necis, mi fili, quantilla prudentia homines regantur*—('You do not yet know, my son, with how little wisdom men are governed'). Christina, who

had been declared of age in 1644, did not shew a proper respect for the advice of O.; and after she had—through mere feminine wilfulness—abdicated in spite of all his protestations, he withdrew from public life, and died 28th August 1654, shortly after she had left Sweden. He entertained a genuine affection for the daughter of his noble master, and in his last moments her name was upon his lips. Some treatises and historical fragments are attributed to him, and his 'Journal' has been published in the 'Stockholm Magazine.' See Lundblad's *Svensk Plutarch* (2 vols. Stock. 1824); Fryxell's *History of Gustavus Adolphus*; and Geijer's *History of Sweden*.

**OX-EYE.** See **CHRYSANTHEMUM**.

**O'XFORD**, an ancient and famous city and seat of learning in England, the chief town of the county of Oxford, is situated on the north-east bank of the Isis, a tributary of the Thames, a little above the point where it is met by the Cherwell. Both streams are crossed by numerous bridges, of which the finest are Folly Bridge over the Isis, and Magdalen Bridge over the Cherwell. Lat. of the city, 51° 45' 55" N., long. 1° 15' 29" W. Distance from London, 55 miles west-north-west. Pop. (1861) 27,560. O. occupies an undulating site, is surrounded by rich and wooded meadows, and presents to the eye of the approaching visitor a scene of unequalled architectural magnificence—spires, and towers and domes rising as thickly as chimney-stalks in the manufacturing towns of Lancashire or Yorkshire. The four main streets of O. meet at right angles near the centre of the town, at a place still called Carfax, a corruption of *Quatre voies*, and which appears in Agas's map (*temp.* Elizabeth) as *Cater voys*. These are—Cornmarket Street, leading into St Giles's, and running due north; Queen Street, leading to the railway-stations, and running west; St Aldate's Street, leading to the Isis, and running due south; and High Street, which is the chief street of the city, gracefully curving in an easterly direction, and conducting to the river Cherwell, a smaller river joining the Isis soon after it has passed Oxford.

The western half of the town is the most uninteresting; and it is a misfortune that the railway-stations are placed here, as travellers, on arriving, are introduced to the meanest parts of the city first. The county courts and jail, and the remains of the castle, from which the Empress Maud escaped while it was besieged by King Stephen, will be observed in passing. There is one good street in this part—viz., Beaumont Street, built on the site of the ancient Beaumont Palace, in which Richard I. was born. At the end of this street stands Worcester College. Passing to the north from Carfax, along the Cornmarket, the old tower of St Michael's Church is seen, against which stood formerly the north gate of the city; next St Mary Magdalen Church; then the Martyr's Memorial, with the Taylor and Randolph Buildings on the left, and part of Balliol College and St John's College on the right. St Giles's Church is at the north end of this street, which is very wide, and has a row of elm-trees on each side, forming a picturesque avenue like a foreign *boulevard*. Beyond this, to the north, is the Radcliffe Observatory and Infirmary. The High Street is about 1000 yards in length; it is reckoned one of the noblest streets—architecturally considered—in Europe, and contains, among other edifices, part of the buildings of Magdalen College, Queen's College, All-Souls' College, University College, and St Mary's and All-Saints' Churches. Parallel to it is Broad Street, in which are situated Balliol, Trinity, and Exeter

Colleges, the Ashmolean Museum, the Clarendon Rooms, the Sheldonian Theatre, and close by are the Academical Schools, the Bodleian Library, and the Picture Gallery. In St Aldate's Street, which forms the southern part of the series of streets already mentioned as forming one line, and running north and south, is Christ Church College (the entrance tower of which contains the great bell 'Tom of Oxford,' weighing upwards of 17,000 lbs.) and St Aldate's Church. The other colleges and important buildings connected with the University of O. lie back from the principal streets. To attempt particularising the architectural characteristics of each of these edifices is impossible within our limits. It may suffice to say, that though there is nothing extraordinarily fine about the architecture of the colleges, regarded individually, yet the vast number of the structures and variety of styles present a *tout-ensemble* that is altogether sublime. The effect is wonderfully heightened by the interspersation of gardens, meadows, and venerable trees—old as the buildings that tower above them. Christ Church is celebrated for its magnificent hall, picture gallery, and library, as well as for its extensive grounds; its chapel, the cathedral church of O., is Norman in style, but is inferior, both in size and beauty, to most English cathedrals. Merton College is situated a little to the south of the High Street, and still retains the original chapel and part of the other buildings erected by Walter de Merton in the 13th century. Magdalen College retains its celebrated cloister and tower of the 16th c., and the buildings here are the most complete of any college in Oxford. Oriel College, a comparatively modern structure, is very picturesque, but far from chaste in its design; New College ranks among the noblest buildings in the city—the chapel, the hall, the cloisters, the groined gateways, and even some original doors and windows remain, in their exterior at least, as they came from the hand of their master architect, William of Wykeham, 600 years ago; Queen's College is built in the Grecian style of architecture, with a spacious and handsome chapel and a fine library; so is Trinity College; University College is a not unpleasing mixture of Gothic and Italian; Exeter College has a splendid frontage on the west, and its chapel (built 1857—1858), in the Gothic style, is the finest modern building in the city; it has also an excellent hall, and a beautiful library; Balliol College has a remarkably fine chapel, built only a few years ago. Among the other churches in O., besides the cathedral church and the college chapels, are—St Mary's, which is attended by the members of the university; St Martin's, the church of the corporation of O.; St Peter's-in-the-East, with a Norman crypt; St Michael's, with a Saxon tower; and St Aldate's. The chief buildings connected with the university, besides the Bodleian and the Ashmolean Museum already mentioned, are the Radcliffe Library, a circular structure, adorned with Corinthian columns and surmounted by a dome; the Radcliffe Observatory, crowned by an octagonal tower, in imitation of the Temple of the Winds at Athens; the University Printing-Office, and the Taylor and Randolph Institution, founded 'for the teaching the European languages,' a very handsome and extensive range of buildings. The Botanic Gardens are not far from the Cherwell, and nearly opposite Magdalen College. Other notable buildings, not connected with the university, are—the Town Hall, the Radcliffe Infirmary, the County Gaol, and one or two dissenting places of worship, such as the Wesleyan Chapel in New Inn Hall Lane, and the Independent Chapel in George Lane.—The city of

O. is a mart for the disposal of the agricultural produce of the neighbouring country, but has little trade of its own, and is dependent for its prosperity chiefly on the university. It is a municipal and parliamentary borough, and governed by a mayor, nine aldermen, and thirty councillors, whose jurisdiction, however, does not embrace the university. Both the city and the university send two members to parliament.

O., by the Saxons called Oxnaford, and in the *Domesday Book*, Oxeneford (probably from its having been originally a ford for the passage of oxen), is a place of great antiquity. The date of its origin is unknown, but as early as the 8th c. there was a nunnery established here; and in 802, an act of confirmation by Pope Martin II. describes it as an ancient seat of learning. It is said to have been a residence of King Alfred, and also of Canute, who held several parliaments within its walls. The townsmen closed their gates against William the Conqueror, who stormed the town in 1067, and gave it to one of his followers, Robert d'Oyley, who built a castle here to overawe the disaffected Saxons, some ruins of which are still to be seen. The paction that terminated the strife between Stephen and Henry II. was drawn up at Oxford. In the reign of Edward III., the preaching of Wickliffe excited great commotion among the students, and threatened well-nigh the dissolution of the university. In the reign of the 'Bloody Mary,' it witnessed the martyrdoms of Ridley, Latimer, and Cranmer; and during the great civil war of the 17th c., it was for a while the head-quarters of the Royalist forces, and was conspicuous for its adherence to Charles I. Ever since that period the city—or, at any rate, the university—has been in general characterised by an extreme devotion to the 'church' and the 'king.'

OXFORD UNIVERSITY is said to have been founded by King Alfred. Without claiming for it an origin quite so ancient, it is certain that from very early times students resorted to Oxford in order to attend lectures there delivered by learned men, and that they lived in the houses of the townspeople. In some cases they combined together, so as to secure the service of a common teacher, with whom they lived in a large tenement called an inn, hostel, or hall. For a long time, however, the great majority of the students lodged in rooms hired from the citizens; and as late as the year 1512, regulations were made for the governance of such students. As their numbers increased, the halls were multiplied. Anthony Wood states that he could shew the names and places of more than a hundred. A great diminution in the numbers of the students took place about the middle of the 15th century. This, among other causes, led to the gradual disappearance of the halls, which were bought up by the wealthier colleges. Only five of the halls now exist, which differ from the colleges only in that they are unincorporated, and have little or no endowments. Residence in private lodgings had also fallen into disuse; and by the time of Queen Elizabeth, it had become a compulsory rule that all undergraduates should reside in some college or hall, at least for the first twelve terms of residence.

The colleges were founded at various periods, from the end of the 13th c. to the beginning of the 18th. Fourteen out of the 19 were founded before the Reformation. Their object originally was to support limited societies of students, who were to devote their lives to study—by no means, as at present, to educate large classes of the community. Students, other than those on the foundation, seem not to have been regarded by the founders as an essential part of the college. The colleges

arose, as has been already said, partly instead of the old halls, and were partly at first connected with the monasteries, it being by means of these institutions that benevolent persons were enabled to give permanent support to poor secular scholars. University and Balliol, which now rank as the oldest colleges, were in point of fact halls supported by endowments held in trust for the maintenance of their students. The originator of the collegiate system, in anything like its present form, was Walter de Merton, who, besides having founded Merton College, is entitled to the honour of having mainly contributed to fix the university in its present site. All those on the foundation of the colleges before the Reformation were called Clerici. The great majority of the fellows were required to take priest's orders within a certain period after their election. This requirement of course involved celibacy, which, besides, was expressly imposed in some colleges; and practically, in old times as now, was enforced by the rule of life and the obligation of residence. The colleges are now, and for long have been, the university. All students must belong to some college or hall; and the members of these societies furnish the governors and teachers, and learned men of the university. With a few exceptions, the professors, even since the recent extension of the professoriate, are, or have been, fellows of colleges.

Previous to the statute 17 and 18 Vict. c. 81, the constitution of the university was as follows: 1. The Hebdomadal Board, or Weekly Meeting, consisting of the Heads of Houses and the two Proctors, which body exercised the chief share of the administration of the university, and possessed the exclusive power of initiating legislation; 2. Congregation, consisting of certain university dignitaries, which met merely for the purpose of conferring degrees; 3. Convocation, consisting of all Masters of Arts, a body whose consent was necessary before any of the measures proposed by the Hebdomadal Board could become law, which elected the chancellor, the two representatives of the university in parliament, several of the professors, and dispensed the ecclesiastical patronage of the university. The statute referred to introduced important changes. The Hebdomadal Board has been changed into the Hebdomadal Council, consisting of the chancellor, the vice-chancellor, the proctors, six heads of houses, six professors, and six members of convocation of not less than five years' standing—such heads, professors, and members of convocation, being elected by congregation, and holding office for six years. Congregation, again, now consists of all the great officers of the university, the professors, the public examiners, and all residents; and on this body is now bestowed the power of accepting or rejecting, and of amending any statute framed by the Hebdomadal Council. The composition and powers of Convocation remain unchanged. The students not on the foundation are, or rather were divided, according to their rank or wealth, into Peers and the eldest sons of Peers, Fellow-Commoners, Commoners, and Servitors. The latter, properly so-called, have disappeared from every college but Christ Church, though at several of the other colleges there is an inferior class nearly resembling them, called 'clerks,' 'Bible-clerks,' &c. The distinction between commoners and fellow-commoners, resting merely upon money, has been long disapproved of by those best able to judge of its effects, and is gradually disappearing. The privileges of Peers, &c., may be waived at pleasure, and some colleges will only receive men of rank, on condition that these privileges are to be waived.

Indeed, the best colleges, such as Balliol, have long refused to recognise any of the above distinctions. It is very difficult to ascertain the actual number of students at any one time in Oxford, but now it is probably seldom above 1400.

There are four terms in each year—viz., Michaelmas Term, which begins on the 10th of October and ends on the 17th of December; Hilary Term, which begins on the 14th of January and ends the day before Palm Sunday; Easter Term, which begins on the 10th day after Easter Sunday and ends on the day before Whitsunday; Trinity Term, which begins on the Wednesday after Whitsunday and ends on the first Tuesday in July. Full Term, as it is called, does not begin till the first day of the week after the first congregation is held. By undergraduates, Michaelmas and Hilary Terms are kept by six weeks' residence, and Easter and Trinity Terms by three weeks each; but more than this is required by most of the colleges. Twenty-six weeks may be taken as the ordinary length of the academic year. Twelve terms of residence are required for the degree of B.A. from all except peers, baronets, knights, &c.; and their eldest sons, if *matriculated as such*, who are allowed to go up for their degree after eight terms' residence, but not until their twelfth term from matriculation. The degree of M.A. is obtainable in the twenty-seventh term after matriculation; in the privileged cases, in the twenty-third. By a statute passed in 1850, the following examinations were made necessary for a degree in arts. 1. Responsions, called 'Little Go' or 'Small's' in the familiar language of undergraduates, to be passed previous to the 6th term. Subjects: one Latin and one Greek author—or portions of them, as five books of Homer, five of Virgil, two Greek plays, &c.—with a paper of grammatical questions; a piece of English to be translated into Latin; two books of Euclid, or algebra up to simple equations inclusive; and arithmetic. 2. The First Public Examination, or Moderations, to be passed between the 7th and 10th terms. Subjects: the Four Gospels in Greek (except in the case of persons not members of the Church of England, when some one Greek author is to be substituted); one Greek and one Latin author, not the same as those offered for responsions, and one must be a poet, the other an orator; a piece of English into Latin, and a paper of grammatical questions; logic, or three books of Euclid, and algebra. Honours are awarded at this examination both in classics and pure mathematics. Candidates are recommended to take up especially poets and orators. Verses, as well as Greek and Latin prose-writing, are required, and a paper of grammatical and philological questions is set. In the mathematical school, which in this examination exists as a separate school for honours only, candidates are examined in pure mathematics up to the Integral Calculus and the Calculus of Finite Differences inclusive. The main design of this examination was to improve pure scholarship in Oxford, but it is understood not to have answered its purpose very successfully. 3. The Public Examination, held twice a year, to be passed as early as the 12th; and for honours, not later than the 18th term of standing. There are Four Schools, in Oxford phraseology, at this examination, two of which must be passed to obtain the degree of B.A. The First School, to be passed first, and by all, is called the School of Literæ Humaniores. Subjects: the Four Gospels and the Acts of the Apostles in Greek; the subjects of the Books of the Old and New Testaments; the evidences and the Thirty-nine Articles with Scripture proofs (in the case of persons not members of the Church of England, an

## OXFORD UNIVERSITY.

extra author, Greek or Latin, may be substituted for divinity); one Greek and one Latin book, a philosopher and a historian, not the same as had been brought up at responsions. Candidates for honours in this school—which are, *par excellence*, the honours of the university—take up ‘the Greek and Latin languages, Greek and Roman history, chronology, geography, antiquities, rhetoric and poetics, moral and political philosophy.’ These subjects may be illustrated by modern authors. Butler and Bacon are the favourite modern books taken up. The poets and orators having been taken up at moderations, the ancient historians and philosophers form the bulk of the books in this school. Plato has of late years been much taken up. ‘Questions to be answered, passages to be translated, and subjects to be treated in Greek, Latin, and English will be proposed by the examiners.’ Second School—Mathematics. For ‘a pass,’ the first six books of Euclid, or the first part of algebra; for honours, mixed as well as pure mathematics. Third School—of Natural Science. For ‘a pass,’ an acquaintance with the principles of two of the following branches of science—mechanical philosophy, chemistry, physiology; for honours, an acquaintance with the principles of the three branches of science named above, and an accurate knowledge of some one branch of science. Fourth School—Law and Modern History. For ‘a pass,’ either (first period) History of England from the Conquest to the accession of Henry VIII., with the first volume of Stephen’s *Blackstone*; or (second period) History of England from the accession of Henry VIII. to that of Queen Anne, with the second volume of Stephen’s *Blackstone*. *Justinian* may be taken up instead of *Blackstone*. Candidates for honours are expected to add, for the first part, appropriate parts of Gibbon, Guizot, Sismondi, William of Malmesbury, and Milman’s *Latin Christianity*; for the second part, portions of Clarendon, Robertson, Ranke, and Sismondi. In law, candidates for honours are expected to add Wheaton, Vattel, or Grotius. In 1864, a statute was passed introducing a slight but important modification. Candidates for degree, instead of being required to pass through *two* schools at the final examination, will now be allowed their degree after passing through *one* school only; provided, 1, that they shall have obtained a third class in some one school; and 2, that they shall have taken up at least three books at moderations. The beneficial effects anticipated from this change are twofold: 1, at the end of a year and a half any man whose tastes lead him to a special line of study, may give up classics if he will read for honours in something else; and 2, a far greater number of men will, it is hoped, be induced to read for honours than at present, and reading for honours is a totally different thing from reading for a pass. Examinations also take place for degrees in law, medicine, divinity, and music; but these are in great measure formal. The examinations for degrees in arts are the proper work of the university.

Besides these honours, various distinctions are conferred by the university. There are several university scholarships, more particularly the Vinerian law fellowships and scholarships; the Eldon Law scholarship; two Sanscrit and five Hebrew scholarships; two mathematical scholarships; the Hertford scholarship, for the encouragement of the study of Latin, and the Ireland scholarship, for the encouragement of the study of Greek. There is also the Newdigate prize for the best composition in English verse; and the three chancellor’s prizes for the best compositions in Latin verse, Latin prose, and English prose; the Gaisford prizes for Greek

composition; and the Arnold and Stanhope prizes for the best essays on an historical subject. But the great prizes are the scholarships and the fellowships. By the commissioners under 17 and 18 Vict. c. 81, these have been for the most part thrown open, and are now awarded after examination without restrictions as to kin or place of birth. At All-Souls, and also at St John’s College, since the labours of the commissioners, an attempt has been made to keep up the former exclusiveness. The scholarships, which are so numerous as to be within the reach of any young man of ability, range from £60 to £80 a year, with rooms free, which, together with an exhibition from school, would go a considerable way towards defraying the expense of a university education. At the close of this education come the fellowships; and it has been calculated that when the arrangements of the commissioners are complete, there will be between 20 and 30 fellowships, varying from £200 to £300 per annum, open yearly to competition.

Oxford is, of course, chiefly fed from the great English schools—of late years, perhaps, more especially from Eton and Rugby. A close connection subsists, by the terms of the foundation, between Winchester and New College, between Westminster and Christ Church, and between Merchant Taylor’s and St John’s. For the nature of this connection, see under these colleges. A student desirous of going to Oxford, must apply to the Head of the College to which he wishes to belong. Application should be made early, as all the good colleges are filled up for several years in advance. But the Heads are understood to reserve to themselves the power of giving rooms at once to any young men who may have distinguished themselves at the yearly examination for scholarships, even though their names may not have been before on the list. There is no university examination at matriculation; but all the good colleges have such an examination before they receive any one—the standard of the examination, of course, varying with the college. After being received into the college, each undergraduate is assigned to a college tutor, who exercises a special control over his reading; but he also attends the instruction of the other college tutors or lecturers, as the course of his studies may require. The cost of tuition varies at different colleges, but an average of £65 may be given as paid by the undergraduate during his whole career. This payment is at some colleges distributed over three, at others over four years. Besides this, almost every undergraduate finds it necessary, at some period before taking his degree, to read with a private tutor, whom he chooses for himself. Private tuition has grown to be quite an institution in Oxford, though not formally recognised. Many of the ablest young men, after taking their degree, remain in Oxford for a year or two, taking private pupils. Much discussion has taken place on the merits and faults of this system; but, on the whole, it must be allowed to be useful for the tutor, as clearing up and concentrating his knowledge, while, at least to undergraduates who read for honours (with a few rare exceptions), it may be considered as absolutely necessary. Private tutors usually charge £10 a term for three hours a week. Previous to 1852, the professoriate of Oxford was strictly ornamental. A great effort was then made to stir it into life, which has been partially successful. New professorships were created, and the endowments of old ones were increased by the commissioners, under 17 and 18 Vict. c. 81. But the former of these measures, at least, whatever it may have done for the interests of science, has produced but little effect on the undergraduates. They still limit their

range of studies by the requirements of the examinations of the schools, and it were hard to expect them to do otherwise. But professorial teaching has undoubtedly become more popular in the ordinary branches of study. Lectures by the professors of Law and Modern History, of Moral Philosophy, Logic, Greek, and Latin are felt to be useful, and are therefore well attended. With regard to the expenses of Oxford, it is difficult to say anything very definite. They vary at different colleges, not only indirectly from the tone of the society, but even directly from the charges made for necessaries. A man should be exceedingly comfortable at Oxford with £300 a year; on £200, he can manage with economy. Very few young men could, with prudence, be exposed to the difficulties of living in Oxford on less than the latter sum. There have indeed been instances of men passing creditably through the university course on £100 a year; but these are exceptional cases, and require great firmness to resist temptations. The necessary expenses, however, do not exceed that sum; the habits of the young men themselves cause a great part of the expenses. Discipline inside the college is maintained by the head of the house and the tutors; in the town and its neighbourhood, by the proctors, who are university officers invested with great authority. The former cannot be very strict without a system of espionage, and of giving weight to what are called 'privileged communications'—unworthy means too often resorted to even in good colleges. Men have been often punished without being heard in defence—the names of their accusers being kept from them, the very nature of their offence not being mentioned. Such injustice often gives rise to great and well-founded discontent. Doubtless the matter is attended with difficulty; but anything like unfairness or secrecy should be always avoided in dealing with young men. Perhaps the tutors at Oxford interfere too much with the private life of the undergraduates. Such matters are best regulated by the general tone of the place, which is, on the whole, good. At the best colleges, a young man may perhaps be led into folly; very seldom into vice or meanness. As a rule, the proctorial authority is openly and wisely exercised. The aggregate revenue of the colleges and the university must considerably exceed £200,000 a year.

The following is a list of the colleges and halls as they rank in the university; an account of each will be found in its alphabetical place: University, Balliol, Merton, Exeter, Oriol, Queen's, New College, Lincoln, All Souls, Magdalen, Brasenose, Corpus Christi, Christ Church, Trinity, St John's, Jesus, Wadham, Pembroke, Worcester, St Mary Hall, Magdalen Hall, New Inn Hall, St Alban Hall, St Edmund Hall. To these may be added Litton's Hall, being a private hall under the mastership of the Rev. Edward Arthur Litton, in virtue of a statute passed in 1855, empowering any M.A. of a certain standing to open a private hall on his obtaining a licence from the vice-chancellor. The idea has not proved popular; neither this hall, nor one which was some time ago opened by the Rev. George Butler can be said to have succeeded.

Among the books which may be consulted with regard to Oxford are—Ayliffe's *History of Oxford*, Wood's *Annals*, the *University Calendar*, and above all, the *Report of the Royal Commissioners for 1852*. The ordinances issued by the commissioners under 16 and 17 Vict. c. 11, have been lately published by Macmillan & Co., in an accessible form, and will be found to contain the latest information as to the government of the colleges.

**OXFORD BLUES.** See **HORSE GUARDS,**

**ROYAL**  
174

**OXFORD CLAY,** the principal member of the Middle Oolite series, is a bed of stiff dark-blue or blackish clay, sometimes reaching a thickness of 600 feet. There occur in its lower portion in some places layers of tough calcareous sandstone, called Kelloway Rock, from a place in Wiltshire, where it is quarried. The O. C. lies beneath the plain on which Oxford is built, and extends south-west and north-east from the shore at Weymouth to the fen lands south of the Wash, thence it may be traced through Lincoln into Yorkshire, until it disappears under the sea at Scarborough. The close packing of the fossils in the fine compact clay has caused them to be beautifully preserved; the shells frequently retain their iridescence, and even the softer parts of the cephalopods have sometimes left with tolerably clear definition their form in the clay. The fossils are, however, often filled with iron pyrites, which, on exposure to the atmosphere, readily decomposes and destroys all traces of the beautiful organism. The remains of chambered shells of the genera belemnites and ammonites are very abundant, and with them are associated other shells, interesting crustacea, and the species of fishes and reptiles which are characteristic of the oolite.

**OXFORDSHIRE,** an inland county of England, bounded on the S. by the river Thames, on the E. by Bucks, and on the W. by Gloucestershire. Area, 472,717 acres. Pop. (1861) 171,233. The surface, where it is not level, is undulating. In the north-west the hills rise in Broom Hill to 836 feet above sea-level, and in the south-east of the county are the Chiltern Hills (q. v.), rising near Nutfield to 820 feet in height. It is watered along its southern border by the Thames, and the other chief rivers are the Windrush, Evenlode, Cherwell, and Thame, affluents of the Thames. By means of the Oxford Canal, which joins the Thames at Oxford, the towns and districts lower down the river (Abingdon, Wallingford, &c.), are supplied with coal from the Leicestershire coal-fields. The soil is fertile; the state of agriculture is advanced, about 400,000 acres are either under crop or in pasture; and the county may be considered one of the most productive in the country. Three members are returned to the House of Commons for the county.

**OXIDATION** is the term applied to the union of any body with oxygen, the body being then said to be *oxidised*, and the resulting compound being termed an *oxide*. Many bodies possess the property of entering into several distinct combinations with oxygen. For example, manganese (Mn) forms no less than six such compounds—viz., MnO, Mn<sub>2</sub>O<sub>3</sub>, Mn<sub>3</sub>O<sub>4</sub>, MnO<sub>2</sub>, Mn<sub>2</sub>O<sub>3</sub>, Mn<sub>2</sub>O<sub>7</sub>, which represent different stages of oxidation.

**OXIDES, METALLIC,** are the most important of all the compounds of the metals, and in many cases occur naturally as abundant and valuable ores. They are divided by chemists into three classes—viz., (1) basic oxides or bases, (2) saline or indifferent oxides, and (3) acid oxides or metallic acids. The different oxides of the same metal usually afford illustrations of two, and not unfrequently of all three of these classes. Thus (to take the case of manganese referred to in the last article) the protoxide (MnO) is a powerful base, the red oxide (Mn<sub>2</sub>O<sub>3</sub>) is a saline or indifferent oxide, shewing little tendency to combine either with acids or alkalis, while permanganic acid (Mn<sub>2</sub>O<sub>7</sub>) presents all the properties of an acid. 'As a general rule, the greater the number of atoms of oxygen which an oxide contains, the less is it disposed to unite with the acids; on the contrary, it frequently possesses acid properties, and then unites with bases

to form salts. Protoxides generally are strong salifiable bases; they require one equivalent of a monobasic acid to form neutral salts. Sesquioxides are weaker bases; their salts are usually unstable; they require three atoms or equivalents of a monobasic acid to form a salt which is neutral in composition, though it may not be neutral to test-paper; and in general, all oxides require as many equivalents of acid as they contain atoms of oxygen in their composition. Some of the metallic acids, like the stannic and titanio, contain two atoms of oxygen to one atom of metal, but most of them contain three atoms of oxygen—such, for example, as the manganic, ferric, chromic, tungstic, molybdic, and vanadic acids; whilst in a few cases, such as the arsenic, antimonio, and permanganic, the proportion of oxygen is still higher.—Miller's *Inorganic Chemistry*, 2d edit. p. 314.

Of the basic oxides, which form by far the most important class, it may be observed that they are devoid of all metallic appearance, and present the characters of earthy matters, and that six only of them are soluble in water to any considerable extent—viz., the three alkalis, and baryta, strontia, and lime. All the oxides are solid at ordinary temperatures, and as a general rule, the addition of oxygen to a metal renders it much less fusible and soluble; the protoxide of iron, the sesquioxide of chromium, and molybdic acid being the only oxides that melt more readily than the metal from which they are produced.

**OXLEYA**, a genus of trees of the natural order *Cedrelaceae*, of which one species, *O. xanthoxyla*, the **YELLOW WOOD** of Eastern Australia, is a very large tree, 100 feet high, valuable for its timber, which is yellow, and is used for building boats, and for various kinds of carpentry.

**O'XPECKER**. See **BREF-EATER**.

**O'XUS**, the ancient name of a great river in Central Asia, which is called by the Turks and Persians **JHON**, and **AMU** or **AMU-DARIA** by the natives of the country through which it flows. The **O.** rises in Lake Sari-kol, in or near the Bolar Mountains; flows first west, and then in a general north-westerly direction through the countries of Buddukshan, Bokhara, and Khiva, and empties itself by several mouths into the Sea of Aral at its southern extremity. In the first part of its course, its volume is increased by numerous affluents, but it receives no tributaries after entering Khiva, from which point its course is wholly through a dry sandy desert. Its total length is about 1150 miles, and it drains an area estimated at 221,250 English square miles. A very remarkable fact in connection with this river is the unanimous testimony of antiquity (with the exception of Pomponius Mela) to the fact of its flowing into the Caspian Sea. Strabo and Ptolemy, the two great geographers of ancient times, distinctly assert this; and the former states that merchandise from the interior of Eastern Asia was brought down by this river to the Caspian Sea, and thence to the Euxine by land-transit; and others state that they have discovered traces of the debouchure of a large river (which could be no other than the **O.**) in the Bay of Balkan, an inlet on the east side of the Caspian Sea. The supposed course of the **O.** coincides with its present one as far as lat. 40° 30' N., and long. 61° 30' E., near Hazarasp, from which point it took a west-south-west direction, and joined the Caspian by three mouths, the most northerly and largest of which skirted the south of the great Balkan range, and fell into the Bay of Balkan; while the most southerly fell into the Bay of Adji Bojar, 70 miles south of

the former. The **O.** was the boundary of the empires of Cyrus and Alexander.

**OXYACIDS**. When Lavoisier, in 1789, gave the name of oxygen to the *Dephlogisticated Air* discovered, in 1774, by Priestley, he believed that the presence of that body was essential to the existence of an acid, and this view was supported by the composition of the principal acids which were then known, such as sulphuric, nitric, carbonic, and phosphoric acids. But, by degrees, acids were discovered into which no oxygen entered, but which always contained hydrogen, and hence acids were divided into two great classes, the *oxyacids* and the *hydracids*; oxygen being supposed to be the acidifying principle in the former, and hydrogen in the latter. At the present day, scientific chemists usually restrict the term *acid* to compounds into which hydrogen enters, and the acids are regarded as salts of the last-named element; thus, sulphuric acid ( $\text{HO}, \text{SO}_2$ ) and nitric acid ( $\text{HO}, \text{NO}_3$ ) are the sulphate and nitrate of oxide of hydrogen; hydrochloric acid ( $\text{HCl}$ ) is chloride of hydrogen, &c.

**OXYCHLORIDES**, chemical compounds containing both chlorine and oxygen in combination with some other element or radical. Chloride of lime ( $\text{CaOCl}$ ), chloride of potash ( $\text{KOC}$ ), oxychloride of lead or Turner's yellow ( $\text{PbCl}, 7\text{PbO}$ ) belong to this class.

**O'XYGEN** (symbol **O**, equivalent 8, specific gravity 1.1056) is a colourless, inodorous, tasteless gas, which has never been reduced by cold and pressure to a liquid or solid condition. Its chemical affinities for other elementary substances are very powerful; with most of them, it is found in combination, or may be made to combine, in more than one proportion; with several in four, five, or six proportions; and there is only one element (fluorine) with which it does not enter into any combination. Owing to the intensity with which many of these combinations take place, this gas has the power of supporting Combustion (q. v.) in an eminent degree. Of all known substances, it exerts the smallest refracting power on the rays of light. It possesses weak but decided magnetic properties, like those of iron, and like this substance, its susceptibility to magnetisation is diminished or even suspended by a certain elevation of temperature. It is only slightly soluble in water; 100 cubic inches of that liquid dissolving 4.11 cubic inches of gas at 32°, and only 2.99 inches at 59°.

Oxygen gas is not only respirable, but is essential to the support of animal life; and hence it was termed *vital air* by some of the older chemists. A small animal placed in a bell-glass containing pure oxygen will not be suffocated so soon as if it were placed in the same glass filled with atmospheric air. For further details on this property of oxygen, the reader is referred to the article **RESPIRATION**.

Oxygen is the most abundant and the most widely distributed of all the elements. In its free state (*mixed* but not *combined* with nitrogen), it constitutes about a fifth of the bulk, and considerably more than a fifth of the weight of the atmosphere. In combination with hydrogen, it forms eight-ninths of all the water on the globe; and in combination with silicon, calcium, aluminium, &c., it enters largely into all the solid constituents of the earth's crust; silica in its various forms of sand, common quartz, flint, &c.—chalk, limestone, and marble—and all the varieties of clay, containing about half their weight of oxygen. It is, moreover, found in the tissues and fluids of all forms of animal and vegetable life, none of which can support existence independently of this element.

There are various modes of obtaining oxygen, the



simplest of which consists in the exposure of certain metallic oxides to a high temperature. It was originally obtained by its discoverer, Dr Priestley, from the red oxide of mercury, which, when heated to about 750°, resolves itself into metallic mercury and oxygen gas. It may be similarly obtained from red oxide and peroxide of lead, the resulting products in these cases being protoxide of lead and oxygen. The following are the chief methods now employed: (1.) The black oxide (or binoxide) of manganese ( $MnO_2$ ) is much employed as a source of this gas. The mineral is reduced to small pieces of about the size of a pea, and introduced into an iron bottle, with a pipe through which the gas may escape. When the bottle is placed in a furnace, and attains a red heat, the mineral parts with one-third of its oxygen, and the red oxide of manganese ( $MnO, Mn_2O_3$ ) remains behind; the reaction being explained by the equation:

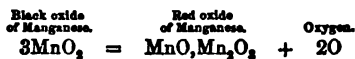

(2.) A very pure and abundant supply of oxygen may be obtained by heating chlorate of potash ( $KO, ClO_3$ ), which yields up all its oxygen (amounting to 39.16 per cent.), and leaves a residue of chloride of potassium. One ounce of this salt yields nearly two gallons of oxygen gas. It is found by experiment, that if the chlorate of potash is mixed with about a fourth of its weight of black oxide of copper, or of binoxide of manganese, the evolution of the gas is greatly facilitated, although the oxides do not seem to undergo any change during the process. (3.) Oxygen is readily obtained by heating strong sulphuric acid with about half its weight of powdered black oxide of manganese, or chlorate of potash, in a glass retort; the reaction in the former case being expressed by the equation:

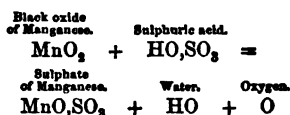

and in the latter case, being of a more complicated character. (4.) Various processes have been proposed for obtaining the gas on a large scale, of which the following, recommended by St Claire Deville and Debray, is perhaps the best: The vapour of hydrated sulphuric acid is passed over red-hot platinum, by which it is decomposed into oxygen and sulphurous acid, the latter of which may easily be separated (and made available for the formation of sulphites) by its solubility in water or alkaline solutions. It has been calculated that a cubic metre (35.375 cubic feet) of oxygen costs 8s. 4d. when obtained from chlorate of potash; nearly 4s. 1d. when obtained from manganese; and only 10d. when obtained from sulphuric acid.

Of the compounds of oxygen, it is unnecessary to speak here, as they are described in the articles on the other chemical elements.

Oxygen was discovered almost simultaneously, in the year 1774, by Priestley and by Scheele, the English chemist having the precedence by a few weeks. Priestley gave it the name of *Dephlogisticated Air*; Scheele termed it *Empyreal Air*; Condorcet shortly afterwards suggested *Vital Air*, as its most appropriate designation; and in 1789, Lavoisier, who, by a series of carefully conducted and very ingenious experiments, proved that the combustion of bodies in the air consisted essentially in their chemical combination with oxygen, and thus overthrew the *Phlogiston* (q. v.) theory, gave it the name which it now retains, in consequence of his (erroneously)

believing that it possessed a certain property which is described in the article OXYACIDS.

**OXYHYDROGEN MICROSCOPE.** See SOLAR MICROSCOPE.

**OXYRHYNCHUS**, the name of a celebrated Egyptian fish, said to be revered throughout Egypt, and sacred to the goddess Athor. Its name in Egyptian is *kha*, and the fish in the hieroglyphs was used for this syllable, and particularly expressed the idea of the body. In the ritual, the deceased particularly stated that he had not caught this fish. The name appears to have comprised the genus *Mormorus*, distinguished by its pointed nose and long dorsal fin. The fish was worshipped in one of the nomes, which was called after it, and the inhabitants held it in such reverence that they would not touch any fish captured by a hook. When the portions of the body of Osiris were flung into the Nile, this fish alone ate one portion of his body. The O. was not eaten in Egypt, except by the natives of the Cynopolites Nomos. Its modern name is *Mizeh*, which seems retained in the Coptic Peme, the name of the city of Oxyrhynchus. It is represented both in the sculptures and on the coins of the Nome, and was anciently embalmed.—The city of Oxyrhynchus is the modern Bahneseh, lying on the west bank of the Nile, in Lower Egypt, near the Bahr-el-Jusuf.

**OXYURIS VERMICULARIS** is the name now assigned by most zoologists to the intestinal worm described as *Acaris* (q. v.) *vermicularis*, yet it is the original and true *Ascaris*. For the mode of recognising the presence of this worm, and treating patients suffering from its presence, the reader is referred to the articles VERMIFUGES and WORMS.

**O'YER AND TERMINER** (Fr. *outr*, to hear; *terminer*, to determine). A commission of oyer and terminer is granted by the crown to the judges and others to hear and determine all treasons, felonies, and trespasses; and it is by virtue of this commission that the judges on circuit dispose of criminal cases in the various circuits. Sometimes a special commission of the same kind is issued, authorising the judges to go and try prisoners at other than the ordinary times.

**O'YSTER** (*Ostrea*), a genus of lamellibranchiate mollusca, of the section with a single adductor muscle. See LAMELLIBRANCHIATA. The shell consists of two unequal and somewhat irregularly shaped valves, of laminated and coarsely foliated structure; and the hinge is without tooth or ridge, the valves being held together by a ligament lodged in a little cavity in each. The animal is, in its organisation, among the lowest and simplest of lamellibranchiate mollusca. It has no foot; and, except when very young, no power of locomotion, or organ of any kind adapted to that purpose. Its food consists of animalcules, and also of minute vegetable particles, brought to it by the water, a continual current of which is directed towards the mouth by the action of the gills. The gills are seen in four rows when the valves of the shell are separated, a little within the fringed edge of the mantle. In the most central part is the adductor muscle; towards the hinge is the liver, which is large; and between the adductor muscle and the liver is the heart, which may be recognised by the brown colour of its auricle. The mouth—for, as in the other lamellibranchiata, there is no head—is situated beneath a kind of hood, formed by the union of the two edges of the mantle near the hinge. It is jawless and toothless. The ovaries are very large during the season of reproduction, which extends over certain months in summer, when oysters are out of season for the

## OYSTER.

table. Oysters are hermaphrodite. They produce vast numbers of young. L<sup>euwenhoek</sup> calculated that from 3000 to 4000 exist within an O. at once when 'sick,' 'milky' or full of spawn; and according to *Poli*, one O. produces about 1,200,000 eggs. The eggs are hatched within the shell and mantle of the parent, and the young are to be seen swimming slowly in a whitish and mucous or creamy fluid surrounding the gills, which becomes darker and of a muddy appearance when they are about to be expelled. Each young-O. is then about  $\frac{1}{16}$ th of an inch in length, and about two millions are capable of being closely packed in the space of a cubic inch. When the parent O. expels the young, and this is done simultaneously by multitudes on an oyster-bank, the water becomes filled as with a thick cloud, and the spawn—called *spat* by fishermen—is wafted away by currents; the greater part, of course, to be generally lost, by being driven to unsuitable situations, as exposed rocks, muddy ground, or sand to which it cannot adhere, or to be devoured by fishes and other marine animals, but some to find an object to which it can attach itself for life. The young come forth furnished with a temporary organ for swimming, ciliated, and provided with powerful muscles for extending it beyond the valves and withdrawing it at pleasure; and when the O. has become fixed in its permanent place of abode, this organ, being no longer of any use, has been supposed to drop off, or gradually to dwindle away and disappear. But Dr F. *Buckland* has recently expressed the opinion, that the swimming organ of the young oyster is the 'lungs,' and remains as the 'lungs'

The species of O. are numerous, and are found in the seas of all warm and temperate climates. None have been found in the coldest parts of the world. The COMMON O. (*O. edulis*) is the only British species. Like it, the other species are generally found where the water is of no great depth; and some of them, also like it, are very abundant in estuaries, where the water is not very salt. The mangrove swamps of warm climates often abound in oysters of excellent flavour (*O. parasitica*, &c.) adhering to the roots and branches of the trees, within the reach of the tide. Some of the species differ from the Common O. not a little in form, as the LONG-HINGED O. (*O. Canadensis*) of North America, which is very elongated; and some of them far exceed it in size. Sir J. E. *Tennent* states that he measured the shell of an edible O. in Ceylon, and found it a little more than 11 inches in length by half as many in breadth; 'thus unexpectedly attesting the correctness of one of the stories related by the historians of Alexander's expedition, that in India they had found oysters a foot long.' Some species of O. have the valves plaited with strong longitudinal plaits.—For the illustrations here given, we are indebted to the kindness of the editor of the *Field*.

Young oysters readily attach themselves to the shells of old ones, and thus, in favourable circumstances, oyster-banks increase rapidly, so as to fill up shallow parts of the sea, and to form walls which effectually resist the waves and tide. This is very remarkably the case on the alluvial shores of Georgia and some other parts of North America, where these banks are called *Raccoon Banks*, because the racoon, among other animals, visits them to feed upon the oysters. Marshy land extends inwards from 12 to 18 miles from the sea, with tidal rivers meandering through it, and these rivers are kept pretty constant to their channels by the walls of living oysters on both sides. Large bunches of oysters may even be found among the long grass. It is not unusual for the inhabitants of the neighbourhood to light a fire, and roast a bunch of oysters on the spot. So abundant are the oysters in many places, that a vessel of 100 tons might be loaded within three times her own length. American oysters, which are of excellent flavour, are an important article of commerce in America, and have begun to be imported (alive) into Britain.

in the mature oyster. The four figures here given represent the young oyster much magnified. Figs. 1, 3, 4 are views of the upper and under side; fig. 2 is an edge view. In very favourable situations, oysters grow rapidly, so that the Com-

Notwithstanding the prodigious fecundity of the O., however, the beds or banks which yield it for the markets of Britain and other European countries are not sufficiently productive to satisfy the demand, and it is not so much an article of ordinary food for all classes, as a luxury of the wealthy. The usual mode of taking oysters by dredging is destructive, although, for oyster-beds, which are at all states of the tide covered with a considerable depth of water, nothing better has been devised, and the anxiety of fishermen to make the most of the present opportunity has caused many beds to be almost ruined by over-dredging. But the artificial formation of oyster-beds has been resorted to with great promise of success. It is indeed no novelty, having been practised by the Romans. *Pliny* says that 'the first person who formed artificial oyster-beds was *Sergius Orata*, who established them at *Baia*. . . . This was done by him, not for the gratification of gluttony, but for the sake of gain, as he contrived

to make a large income by the exercise of his ingenuity.' *Sergius Orata* lived in the time of Augustus. Among the *vivaria* of later emperors and other wealthy Romans were *ostrearia*, specially

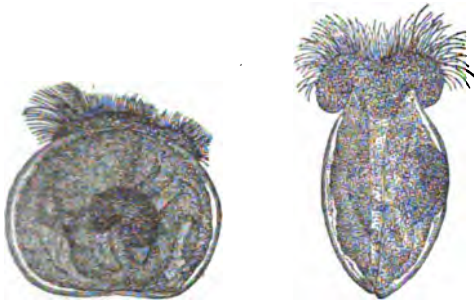

Fig. 1.

Fig. 2.

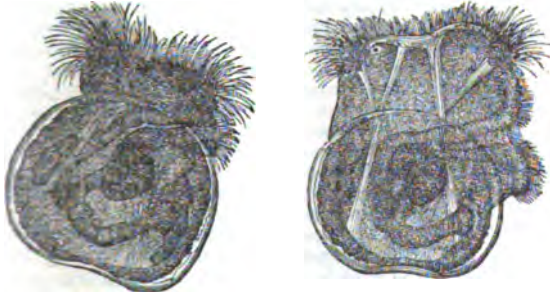

Fig. 3.

Fig. 4.

mon O. is ready for the table in a year and a half or two years; but in other places, a longer time is required, often about five years.

## OYSTER.

devoted to oysters; and oyster-culture has never ceased to be practised in Italy, although to an inconsiderable extent, and particularly in Lake Fusaro, the Acheron of Virgil, a muddy salt-water pond nowhere more than two yards deep. In Britain, it has also long been practised to some extent, particularly on the coasts of Kent and Essex, for the supply of the London market. There can be no doubt, however, that this branch of industry is capable of vast development, and that many thousands of acres along the British coasts might be profitably occupied in the production of oysters, which might become, far more than hitherto, a common article of food. The subject has recently received much attention from the French government, and most successful experiments have been made, not only by the government, but also by private individuals. The shores of the Isle of Ré have within these few years been in great part converted into oyster-beds, the successful enterprise of an old soldier having led many of his neighbours to follow his example, so that now more than 3000 men are employed in oyster-culture in that island alone.

left dry by the retiring tide. In the latter kind of situations, they instinctively keep their valves closed when the water deserts them. It is in such situations that oyster-culture can be most easily and profitably carried on. Our space will not admit of details, which we would gladly give. Various methods are adopted of preparing the artificial oyster-bed, by providing suitable solid objects for the oysters to attach themselves to. Stones are piled together, and in such a way that there are many open spaces among them; stakes are driven into the mud or sand; bundles of small sticks are fastened to stones or stakes; floors of planks are formed, at a little height above the bottom, with alleys between them, the under surface of the planks being roughened by the adze; and tiles are arranged in various ways, so as to turn to account the whole space at the disposal of the oyster-cultivator as high as the ordinary tides reach. The method must be varied in accordance with the situation, and the probable violence of winds and waves; but sheltered situations are best in all respects; and experience in France seems to prove, that tiles covered with cement are preferable to

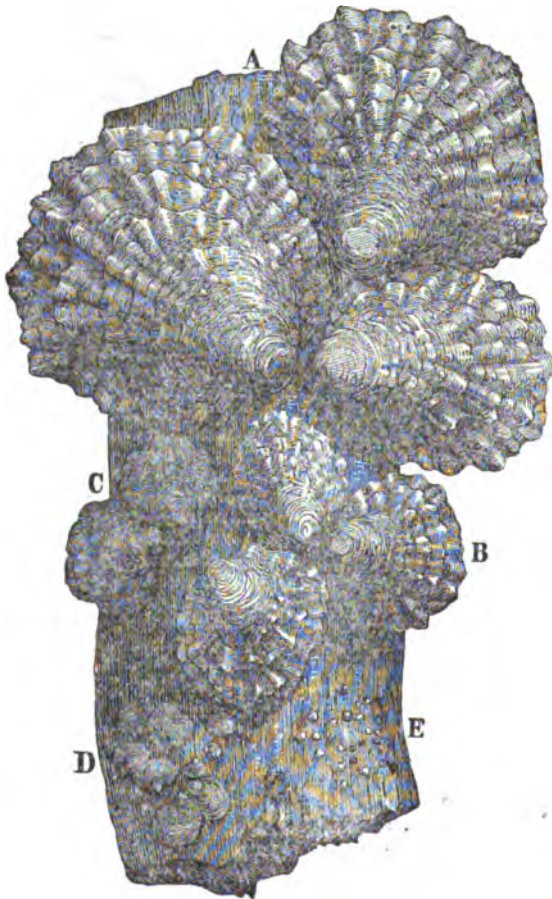

The accompanying figure represents a piece of wood with oysters attached to it of different ages. Those marked A, are from twelve to fourteen months old; those marked B, are five or six months; those marked C, are three or four months; those marked D, are one or two months; those marked E, from fifteen to twenty days.

Oysters live equally well in situations where they are constantly under water, and in those which are

everything that has yet been tried as convenient for the cultivator, presenting a surface to which oysters readily attach themselves, and from which they can easily be removed, whilst the larger seaweeds do not grow on it so readily as on stones or wood. By the use of tiles, covered with cement, the cultivator is also able easily to remove young oysters from breeding-grounds to feeding-grounds; the best breeding-grounds being by no means those in which the oyster most rapidly attains its greatest size, and that greenish tinge which Parisian epicures so much desire to see, and which is owing to the abundant confervæ and green monads of quiet muddy waters.—It has been long known that the oysters of particular localities are finer than those produced elsewhere. Nowhere, perhaps, are finer oysters produced than on some parts of the British coasts. Those of Rutupiceæ, now Richborough, in Kent, were highly esteemed by the Romans, whose epicurism in oysters exceeded that of modern nations.

Of the culinary uses of oysters, it is unnecessary to say anything. Raw oysters, however, are generally believed to be more nutritious and more easily digested, as to many they are more delicious, than oysters cooked in any way; and it does not appear that any such evil consequences ever ensue from eating them as are known to ensue from eating other kinds of uncooked food. Probably no parasite capable of developing into any form injurious to the human being exists in the oyster.

The genus *Ostrea* gives its name in some zoological systems to a family *Ostreada*. The fossil species are more numerous than the recent.

The name *O.* is popularly extended to many molluscs not included among the *Ostreada*, as the Pearl-oyster (q. v.).

Oysters raised in artificial beds are called 'natives,' and are considered very superior to those which are dredged from the natural beds; although to these last the name of 'native' would seem more appropriate than to the other. From 30,000 to 40,000 bushels

## OYSTERS—OZÆNA.

of 'natives' are consumed annually in London alone, and in addition to these fully 120,000 bushels of the sea-oyster are also sold in that city. It has been computed that this enormous bulk contains more than 500,000,000 individuals, and represents a value of nearly £100,000 sterling. A large trade in oysters has sprung up in the United States, and in New York alone it is stated that the oyster-trade exceeds that of all Europe, and amounts in value to £1,250,000 per annum.

**Fossil Oysters.**—A single species occurs in the Carboniferous Limestone, and as we rise in the crust of the earth, the genus becomes more and more common, no less than 200 species having been recorded, many of them scarcely distinguishable from the living species. The sub-genus *Gryphæa* was a free shell, with a large thick left valve and small concave right valve. Thirty species have been found in beds of the Oolite and Chalk periods. In the same beds there occurs another form of *Ostrea* with subspiral reversed umbones, to which the sub-generic name *Exogyra* has been given. Forty species of this form have been described.

**OYSTERS, LAW AS TO.** The rule is, that he who has the right of property in the soil or sea-shore is entitled to catch or keep and breed oysters there. But the shore below the medium line of the tides belongs to the crown, and not to any individual; and it is only by virtue of some grant from the crown that an individual or a corporation can establish an exclusive title to the sea-shore, and in such a case is exclusively entitled to any oyster-beds there. It is thus always by virtue of a grant from the crown that oyster-fisheries are claimed as the property of an individual or of a corporation. Some of these fisheries are regulated by local acts, and if so, then they are governed by the particular rules laid down by these acts. But the general law, so far as not qualified by any local statute, is as follows: Whoever steals oysters or oyster-brood from an oyster-bed which is private property, is guilty of felony; and whoever unlawfully or wilfully uses any dredge net or instrument within the limits of a private oyster-bed, for the purpose of taking oysters, though none are actually taken, is guilty of a misdemeanour, and is liable to be imprisoned for three months. But persons are not prevented from fishing for floating fish within the limits of an oyster-fishery, if they use nets adapted for floating fish. Certain statutes as old as the time of Richard II. were passed to protect oyster-brood, but these were recently repealed by the Salmon Fishery Act (*Paterson's Fishery Laws of the United Kingdom*). Under the convention between England and France, confirmed by the statute 6 and 7 Vict. c. 79, a close season is prescribed for oyster-fishing, and the open season commences on 1st September, and ends on the 30th April following. During the close season, all oyster fishing-boats may be boarded by officers of the coast-guard service or navy; and oysters illegally caught may be seized and destroyed, and the master is liable to a penalty. No oysters taken in the seas between the United Kingdom and France can be imported into the United Kingdom during the above close season; but as regards the part of the sea not governed by the convention with France, there is no close season. The law as to oysters in Scotland is substantially the same as in England. As to Ireland, the Irish Fishery Acts give power to the Irish Fishery Commissioners to grant a licence to owners or occupiers of land bounded by the sea-shore, to appropriate a certain tract of the shore for the purpose of forming oyster-beds, and thereupon the beds become private property (*Paterson's Fishery Laws*, p. 257). There

is also a close season in Ireland for oysters, the same as is established under the convention with France.

**OYSTER BAY**, a favourite watering-place on the north coast of Long Island, New York, U. S., on a deep sheltered bay, opening into Long Island Sound, 25 miles north-east of New York city. It abounds in handsome residences and fine scenery, and offers facilities for fishing, bathing, &c. Pop. in 1860, 9168.

**OYSTER-CATCHER** (*Hæmatopus*), a genus of birds of the family *Charadriadæ* (q. v.), chiefly inhabiting sea-coasts, where they feed on molluscs, crustaceans, annelids, and other marine animals—sometimes even on small fishes. Their legs are of moderate length, like those of the plovers, and, like them, they have no hind-toe. The most remarkable generic distinction is found in the bill, which is long, strong, straight, much compressed and wedge-like towards the point. They are generally said to make use of the bill for opening the shells of oysters and other molluscs; but the late Mr James Wilson expresses a very reasonable doubt on this point. The habits of the British species (*H. ostralegus*), so far as they have been accurately observed, agree with those of the American. It is the only European

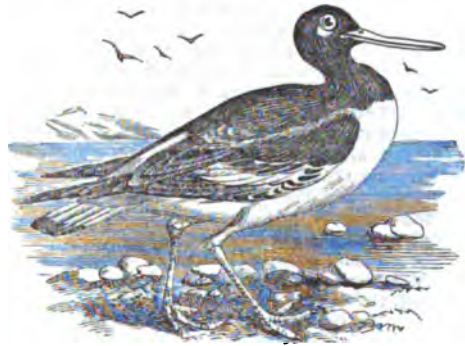

Oyster-catcher (*Hæmatopus ostralegus*).

species, and is common on all parts of the British coasts, on those of continental Europe, the north of Africa, and of the north of Asia. Its whole length is about 16 inches. Its finely-contrasted black and white colours have gained it the name of SEA PIP. It is most abundant on the sea-coast, but often visits inland regions, and sometimes breeds in them. It does not make a nest, but lays its eggs—usually four—on the shingly beach or bare ground. On some of the sandy flat coasts of Lincolnshire, the O. is so abundant, that a bushel of the eggs have been collected in a morning by a single fisherman. The American O. is a bird of passage, deserting the northern regions in winter. It is rather larger than the European species, and differs from it in colour, and in greater length and slenderness of bill.

**OZÆNA** (from the Gr. *ozo*, I smell) signifies a discharge of fetid, purulent, or sanious matter from the nostrils. It is a symptom rather than a disease, and may arise from ulceration of the membrane lining the nostrils, or from caries of the adjacent bones, and may accompany syphilitic, scorbutic, scrofulous, or cancerous affections of these or adjacent parts. A slighter form of ozæna sometimes follows chronic coryza (or cold in the head), malignant scarlatina, and erysipelas of the face. The discharge is seldom accompanied by acute pain, unless when caused by cancer;

sometimes, however, an aching is complained of. The prognosis must depend upon the nature of the disease, of which the discharge is a symptom. The treatment may be divided into the general or constitutional, and the local. The *general treatment* should consist of tonics combined with alteratives, as the preparations of bark with the alkalies, or with the mineral acids; a dry, bracing air, or a temporary removal to the seaside, is also usually of service. If the discharge arises from syphilis or scurvy, the treatment suitable to those diseases should be prescribed. The *local treatment* consists in the inhalation, once or twice a day, of the steam of boiling water, to which a little creosote or carbolic acid has been added; and in more severe cases, in the thorough syringing of the nostrils, so as to wash away all collections of matter with a copious stream of warm water, to which a little chloride of zinc has been added (about 30 minims of Burnett's solution to half a pint of water).

**O'ZONE** (Gr. *ozo*, I smell). It was remarked long ago that a peculiar odour was produced by the working of an electrical machine. Van-Marum found that, when electric sparks were passed through a tube containing oxygen, the gas became powerfully impregnated with this odour—which he therefore called the 'smell of electricity.' Subsequent writers attributed the phenomenon to the formation of nitric acid, due to a trace of nitrogen mixed with the oxygen; especially as the gas was found to act energetically upon mercury. Thus supposed to be explained, these curious results were soon forgotten. But in 1840, Schönbein (q. v.) with remarkable acuteness, made a closer investigation of the question, and arrived at many most curious results, which have not even yet been satisfactorily accounted for. The problem remains, in fact, one of the most perplexing, as well as interesting, questions unsolved in chemistry.

The earlier results of Schönbein were as follow: (1.) When water is decomposed by the voltaic current, the electrodes being of gold or platinum, the oxygen (which appears at the positive pole) possesses in a high degree the smell and the oxidising power developed by Van-Marum by means of friction-electricity. (2.) When the positive electrode is formed of an oxidisable metal, these results are not observed, but the electrode is rapidly oxidised. (3.) The oxygen collected at a platinum electrode retains these properties for an indefinite period, if kept in a closed vessel; but loses them by heating, by the contact of an oxidisable substance, and even by contact with such bodies as charcoal and oxide of manganese. To the substance, whatever it may be, which possesses such powerful chemical affinities, Schönbein gave the name ozone, from its peculiar smell.

In 1845, he shewed that the same substance can be produced by the action of phosphorus on moist air; and suggested that it might be a higher oxide of hydrogen.

De la Rive and Marignac shortly afterwards, repeating the experiments of Van-Marum, shewed that electric sparks produce ozone even in *pure* and *dry* oxygen; and came to the conclusion, that ozone is oxygen in an *allotropic* state, as diamond is a form of coke or charcoal.

Baumert, in 1853, endeavoured to shew that there are two kinds of ozone—one formed from pure oxygen by electric sparks, which he allowed to be allotropic oxygen; the other formed in the voltaic decomposition of water, which he endeavoured to prove to be a *teroxide* of hydrogen ( $\text{HO}_3$ ). But Andrews, in 1856, completely refuted this view, by shewing that no such oxide of hydrogen (at least

in a gaseous form) is produced in the electrolysis of water; and that ozone, from whatever source obtained, is the same body; and is not a compound, but an allotropic form of oxygen.

Schönbein has more recently tried to shew that whenever ozone is produced, *another* remarkable body (called antozone) is also produced; and that these are simply oxygen in different electrical states. The facts on which these ideas are founded are, however, capable of other explanations.

In 1860, Andrews and Tait published the results of a series of *volumetric* experiments on this subject, which led to some remarkable conclusions—among which are the following: When the electric discharge is passed through pure oxygen, it *contracts*. If ozone be oxygen in an allotropic form, it must therefore be denser than oxygen. It was found also that a much greater amount of contraction, and a correspondingly greater quantity of ozone, were produced by a silent discharge of electricity between fine points, than by a brilliant series of sparks. The contraction due to the formation of the ozone is entirely removed by the destruction of the ozone by heat; and this process can be repeated indefinitely on the same portion of oxygen.

In attempting to determine the density of ozone, they used various bodies to take up the ozone from the oxygen containing it; and met with many very curious results. Thus, if mercury be introduced, it is immediately attacked and oxidised, and yet the oxygen *increases* in volume. If iodine be employed, it is immediately oxidised, and *no change* of volume is observed, though the apparatus would have at once rendered visible a change to the amount of  $\frac{1}{1000}$ th of the bulk of the oxygen. By measuring the contraction produced by electricity in the oxygen, then the effect of introducing a solution of iodide of potassium, and determining the amount of oxygen taken up from the quantity of iodine set free, Andrews and Tait shewed that the density of ozone, if it be allotropic oxygen, must be practically *infinite*—i. e., that ozone must have the density of a *liquid* or a *solid* at least, although existing in the gaseous form. This conclusion is inevitable, unless we make the very improbable assumption, that when iodine, &c., are exposed to ozone, *exactly* one half of the ozone combines with the iodine, and the other half is restored to the form of oxygen. The paper from whose statements we have quoted concludes with a suggestion that it is *possible* that, in the formation of ozone, oxygen may be decomposed. This is, of course, contrary to all the received notions of chemistry—but such a supposition would at once reconcile all the apparently contradictory facts connected with this singular body. Soret and Von Babo have recently repeated and verified a few of these results; but in spite of the wonderful sagacity of Schönbein, and the laborious experimental inquiries of many chemists, the nature of ozone is still utterly unknown.

It is not even proved that ozone exists in the atmosphere, except as the immediate result of electricity, though of late years the attention of meteorologists has been directed to the effect which is (almost invariably, and sometimes in fine weather powerfully) produced by the air on what are called ozone-test-papers—papers steeped in iodide of potassium (and generally spoiled by the addition of starch) which are rendered brown (or blue) by the liberation of iodine. No doubt, ozone, if present, would produce this effect; but there are many other substances which we *know* are generally present in the atmosphere, which are perfectly competent to produce all the effects observed. This, like the nature of ozone, is still an open question.

# P



THE sixteenth letter of the English and other western European alphabets, was in Hebrew called *Pe*, i. e., mouth, and was most likely, in its original form, a rude sketch of a mouth. *P* is the thin letter of the labial series (*p*, *b*, *f*, *v*) and is interchangeable with the other letters of the series. *P*, in Sanscrit, Greek, and Latin, is replaced by *f* in the Teutonic tongues.

See *F*. Words beginning with *p* in English, and its kindred Teutonic tongues, are almost all of foreign origin (Slavic, Celtic, Latin), as *pain* (Fr. *peine*, Lat. *pena*), *plough* (Pol. *plug*), *pit* (Lat. *puteus*, a well). The Greek prep. *apo* (Sans. *apa*) became in Lat. *ab*; Gr. *kupo*, Lat. *sub*; Sans. *upa*, Lat. *ob*; but before sharp letters, as *t* and *s*, the original *p* was retained in pronunciation, as is shewn by inscriptions (*apstulit*, *optinui*). There are remarkable interchanges of *p* with the sharp guttural *k* or *g*. Thus, for Lat. *quis*, *quod*, *quam*, the Oscan dialect had *pis*, *pod*, *pam*; Lat. *equus*, *coquo*, corresponded to Gr. *hippos* (Æol. *hikkos*), *pepo*; similarly, Gaelic *mac* (son), *ceathair* (Lat. *quatuor*, four), *coig* (Lat. *quinque*, five), correspond to Welsh *maig*, *pedwar* (Gr. *pettores*), *pump* (Gr. *penite* or *pempe*). In Gr., *p* is sometimes replaced by *t*, as *tis*, *tessares*, for *pis*, *pettores*. In such words as *redemption*, *consumption*, *p* has been introduced as an intermediary between the incompatible sounds *m* and *t*. The initial *p* of Latin words has for the most part passed into French unaltered; in other positions, *p* has become *v*; thus, Fr. *évêque*, *cheveu*, *décevoir*, *pauvre*, from Lat. *episcopus*, *capillus*, *decipere*, *pauper*.

*PA'CA* (*Coelogenys*), a genus of rodent quadrupeds, allied to the agoutis, cavies, and capybara, and inhabiting Brazil, Guiana, and some of the West India Islands. The dentition very nearly resembles that of the agoutis. The cheek-bones are prodigiously developed, in a way of which no example exists in any other mammalian animal, so that the zygomatic arches enclose a large hollow space, whilst the bone also descends to an unusual depth from the arch, even below the lower jawbone. Within this structure, which gives an extraordinary breadth and peculiar aspect to the face, is a sac in each cheek, opening in front, and lined with a fold of the skin of the face. The whole of this seems to be intended to preserve the true cheek-pouches from external shocks. The cheek-pouches open from the mouth in the usual way, and are capable of very great distention. The lip is cleft; the ears are small; the eyes are large and full; the neck is short; the tail is a mere tubercle; the feet have each five toes; the legs are thick; the back is rounded. The form and gait are clumsy, yet the *P.* (*C. paca*) is very quick and active. It lives in moist grounds, burrowing like the rabbit, but not so deeply; its burrow, however, is always provided with three openings. It feeds on vegetable substances, and often does great damage to plantations of sugarcane. It is one of the largest rodents, being about two feet long. It is generally of a dark brown

colour, with four rows of white spots along the sides, the throat and belly white. A lighter-coloured species has been described, but is perhaps a mere variety. The flesh of the *P.* is much esteemed, and is very fat.

*PACAY* (*Prosopis dulcis*), a tree of the natural order *Leguminosæ*, sub-order *Mimosææ*; a native of Peru, of rather large size, with a broad head; producing pods from twenty inches to two feet long, which contain black seeds imbedded in a sweet flaky substance as white as snow. This flaky substance is used as an article of food and much relished by the Peruvians.

*PACE* (Lat. *passus*), in its modern acceptation, is the distance, when the legs are extended in walking, between the heel of one foot and that of the other. Among disciplined men the pace becomes of constant length, and as such is of the utmost value in determining military movements, the relative distances of corps and men being fixed by the number of paces marched, and so on. The pace in the British army is  $2\frac{1}{2}$  feet for ordinary marching, and 3 feet for 'double-quick' or running time.—With the Romans, the pace had a different signification, and it is important to bear the distinction in mind, when reading of distances in Latin works; the single extension of the legs was not with them a pace, (*passus*), but a step (*gradus*); their pace (*passus*) being the interval between the mark of a heel and the next mark of the same heel, or a double step. This pace was equivalent to 4·84 English feet. The pace was the Roman unit in itinerary measure; the mile being 1000 paces, or 5000 Roman feet, equal to 917 of an English mile. See *MILE*. Whether measurements were effected by actually counting the paces, or by the time occupied, is not clear; but either method would, with disciplined troops, give a safe result.

In the middle ages, writers confuse accounts of distances by allusion to a geometrical pace, a measure which varied with different authors.

*PACHO'MIUS*, an Egyptian monk of the 4th c., is held in high estimation by the Roman Catholic church, as being the first to substitute for the free asceticism of the solitary recluse, a regular cœnobitic system. He was born towards the close of the 3d c., was brought up as a pagan, but converted to Christianity by the kindness of certain Christians whom he encountered at Thebes. About 340 A. D., at Tabenna, an island in the Nile, he founded the first monastic institution. The members agreed to follow certain rules of life and conduct drawn up by *P.*, and to subject themselves to his control and visitation. He also established the first convent for nuns, which was under the presidency of his sister, and laboured with so much diligence and zeal, that at his death, according to Palladius, not fewer than 7000 monks and nuns were under his inspection. The various writings extant under the name of *P.* are—*Regula Monastica* (of doubtful genuineness), *Monita*, *SS. P.P. Pachonii et Theodori*,

*Epistola et Verba Mystica* (a farrago of unintelligible allegory), and *Præcepta S. Pachomii*. See *Acta Sanctorum*, vol. iii.

**PACHYDERMATA** (Gr. thick-skins), in the system of Cuvier, an order of Mammalia, including part of the *Bruta* (Rhinoceros, Elephant), and all the *Bellua* (Horse, Hippopotamus, Tapir, Hog, &c.) of Linnæus, besides one genus (*Hyrax* or Daman) of the Linnæan *Glires*. It has been often described as less natural than any other of Cuvier's mammalian orders, as it consists of animals among which there are wide diversities, and the associating characters are rather negative than positive; but it is now universally received by naturalists as indicating a real, though not a close affinity; and when we extend our view from existing to fossil species, numerous connecting links present themselves. As defined by Cuvier, the order consists of those hoofed mammalia (*Ungulata*) which are not ruminants; all of which possess, as a more positive character, a remarkable thickness of skin. This order he divides into three sections—(1.) *Proboscidea*, having a prolonged snout or proboscis, through which the nostrils pass as elongated tubes, a powerful organ of prehension, and a delicate organ of touch, and having also five toes on each foot, enclosed in a very firm horny skin; (2.) *Ordinaria*, destitute of proboscis, although in some (Tapirs), there is such an elongation of the upper lip and nostrils as approximates to it; and the nose is employed by hogs, &c., in seeking their food, not only as an organ of smell, but as an instrument for turning up the ground, and as an organ of touch; the number of toes varies, four, three, or two on each foot; those with an even number of toes, having in the cleft foot a resemblance to the *Ruminantia*; and (3.) *Solidungula*, in which the foot has but one apparent toe, enclosed in a hoof. Some naturalists have thought it better to separate the *Solidungula* or *Equidae* (q. v.) from the P., as a distinct order; whilst others have enlarged instead of restricting the limits of the order, by adding, as a fourth section, the *Herbivorus Cetacea*.

Those P. which have a number of toes differ completely from the mammalia having claws (*Unguiculata*) in their inability to bend their toes in order to seize any object. Some of the *Edentata* have very large hoof-like claws, but this difference still subsists. The fore-limbs of the P. are also incapable of any rotatory motion, serving for support and locomotion only, not at all for prehension; the metatarsal and metacarpal bones being consolidated as in the *Ruminantia*, and they have no clavicles.

The largest terrestrial mammalia belong to this order. Most of the P. are of large size, although the damans are a remarkable exception, and some of the hog family are also comparatively small. Most of them have a clumsy form, with a slow and awkward gait; but they are capable of activity beyond what might be supposed, and sometimes move at a pretty rapid pace. Gracefulness and fleetness are characteristics of the otherwise exceptional *Solidungula*. The *P. Ordinaria* have generally great strength, and the larger ones push their way through the entangled thickets of tropical forests, bending or breaking the lianas, small trees, and branches which oppose their progress, their thick hides resisting the spines and broken branches by which the skins of other animals would be pierced. The horse and other *Solidungula* are not inhabitants of forests and jungles, but generally of grassy plains, and their hides are much less thick and hard than those of most of the *Pachydermata*.

The physiognomy of the P. in general is rather dull and unexpressive, the eyes being small, and having that character of which a familiar example

is found in the common hog. When enraged, however, they manifest their fierceness in their eyes; and although, in general, mild and gentle, they are capable of being aroused to great fury.

The skeleton of the *P. Ordinaria* and *Proboscidea* is strong and massive; the neck short, the processes of its vertebrae strongly developed; the skull affording a large surface for the muscles which support and move it.

The P. generally feed on vegetable substances. Some are omnivorous. The digestive organs are more simple than in the *Ruminantia*, but exhibit considerable diversity. The stomach is simple in some, and in others is more or less completely divided into sacs, approaching to one of the most remarkable characters of the *Ruminantia*. The intestines are generally longer than in the *Ruminantia*. The dentition exhibits considerable diversity; the adaptation to vegetable food being the most prevalent character. The most important peculiarities of the dentition and digestive organs are noticed in the articles on particular families and genera.

**PACIFIC OCEAN**, the largest of the five great Oceans (see OCEAN), lies between America on the east, and Asia, Malaisia, and Australasia on the west. The name 'Pacific,' given to it by Magellan, the first European navigator who traversed its wide expanse, is doubtless very appropriate to certain portions of this ocean; but, as a whole, its special claims to the epithet are at the least doubtful, though the name has by long usage become too well established to be easily supplanted by any other.

The greatest length of the P. O. from the Arctic (at Behring's Strait) to the Antarctic circles is 9200 miles, and its greatest breadth, along the parallel of latitude 5° N., about 10,300 miles; while its area may be roughly estimated at 80,000,000 English square miles, or about  $\frac{1}{4}$ ths of the whole surface of the earth. Its form is rhomboidal, with one corner incomplete (at the south), and its surface is studded with numberless islands, either scattered or in groups; these, however, are chiefly confined to the western side, and to the limits of 30° N. lat. and 30° S. lat., where the depth of the ocean is not great. Along the whole eastern side, from Behring's Strait to Cape Horn, there is a belt of sea of varying width, which, with a very few exceptions, is wholly free from islands.

The coasts of the P. O. present a general resemblance to those of the Atlantic, and the similarity in the outline of the western coasts of each is even striking, especially north of the equator; but the shores of the former, unlike those of the latter, are sinuous, and, excepting the north-east coast of Asia, little indented with inlets. The shore on the American side is bold and rocky, while that of Asia varies much in character.

Though the P. O. is by far the largest of the five great oceans, being about equal to the other four in extent, the proportion of land drained into it is comparatively insignificant. Its basin includes only the narrow strip of the American continent to the west of the Andes and Rocky Mountains; Melanesia (with the exception of almost the whole of Australia), which contains few rivers, and none of them of large size; the Indo-Chinese states, China Proper, with the east part of Mongolia, and Manchuria in the Asiatic continent.

**Winds.**—The trade-winds of the Pacific have certain peculiarities, which have only lately been discovered. In general, they are not found to preserve their peculiar characteristics except within certain limits, thus, the south-east trades are found to blow steadily only between 92° and 140° of west longitude; while the north-east trades

are similarly fluctuating, except between long. 115° W. and 214° W. Beyond these limits, their action is in whole or in part neutralised by the monsoons and other periodical winds peculiar to the tropical regions of the Pacific. In Polynesia, especially near the New Hebrides group, hurricanes are of frequent occurrence from November to April, but they exhibit few of the terrible characteristics which distinguish the hurricanes of the West Indies and Indian Ocean. North and south of the tropical zone, the winds exhibit little periodicity, being found to blow from all parts of the compass at any given season of the year, though a general westerly direction is most frequent among them. On the coast of Patagonia and at Cape Horn, west winds prevail during the greater part of the year, while in the Sea of Okhotsk they are of rare occurrence. The frightful Typhoon (q. v.) is the terror of mariners in the Chinese seas, and may occur at all seasons of the year. There are many other winds and storms, such as white squalls, cyclones, 'tempestades,' &c., which are confined to particular localities, and will be found noticed under other heads, and also under STORMS.

*Currents.*—The currents of the P. O., though less marked in character and effects than those of the Atlantic, are yet of sufficient importance to require a brief notice. The *Southern Pacific current* takes its rise south of Van Diemen's Land, and flows eastward at the rate of half a mile per hour, dividing into two branches about long. 98° W., the northern branch or *Current of Mentor* turning northward, and gradually losing itself in the counter equatorial current; the southern branch continuing its eastward course till it is subdivided by the opposition of Cape Horn into two branches, one of which, the *cold Current of Peru* or *Humboldt's current*, advances northward along the west coast of South America, becoming finally absorbed in the equatorial current; the other washing the coast of Brazil, and becoming an Atlantic current. The P. O., like the Atlantic, also possesses its equatorial current, separated into a northern and southern current by the equatorial counter-current. It sweeps across the whole ocean from east to west. Two subdivisions of the southern current, called respectively the 'current of Rossel' and the 'warm current of Australia,' flow, the one through the Polynesian Archipelago to New Guinea, and the other along the east coast of Australia. The northern equatorial current, after reaching the coast of Asia, turns northeast, washing the shores of China and Japan, under the name of the *Black* or *Japan current*; it then sends off a branch along the coast of Kamtschatka, and advances eastward till it becomes lost on the northwest coast of North America. There are other minor currents, the most remarkable of which is that of Fleuriu, which describes a kind of irregular circle with a radius of about 240 miles. It is situated in lat. 25°–40° N., and long. 133°–155° W. All these currents have their corresponding counter-currents.

There are two 'sargassos' or weedy seas of considerable extent in the P. O., one lying 15° east-south-east of New Zealand; the other, and by far the larger, about 15° west of San Francisco in California. There is also a large region lying nearly half-way between Cape Horn and New Zealand, which seems to correspond to the deserts on land, as mariners report it almost wholly destitute of any signs of life either in sea or air.

*History.*—The existence of this ocean first became known to Europeans through Columbus, who had received accounts of it from some of the natives of America, though it was first seen by Balboa, September 29, 1513, and first traversed by Magellan

eight years afterwards; but its size, limits, and the number and position of its islands, &c., were little known till long afterwards, and even now it presents a rich field for the labours of discoverers. Captain Cook deserves the first place among those who have devoted themselves to the investigation of the P. O.; and after him come Anson, the two Bougainvilles, La Perouse, D'Entrecasteaux, Carteret, Vancouver, Krusenstern, Kotzebue, &c.

**PACINIAN CORPUSCLES** are very remarkable structures appended to the nerves. In the human subject, they are found in great numbers in connection with the nerves of the hand and foot, and sparingly on other spinal nerves, and on the plexuses of the sympathetic, but never on nerves of motion. They always present a *proximal end*, attached to the nerves by a stalk of fibrous tissue prolonged from the neurilemma, and occasionally one-tenth of an inch long; and a *distal end*, lying free in the connective or areolar tissue. In the human subject, the corpuscles vary in length from one-twentieth to one-tenth of an inch. They are usually seen very readily in the mesentery of the cat, appearing as pellucid oval grains, rather smaller than hemp-seed. The microscopic examination of these bodies discloses an internal structure of a very remarkable kind. They consist, first, of a series of membranous capsules, from thirty to sixty or more in number, enclosed one within the other; and secondly, of a single nervous fibre, of the tubular kind, enclosed in the stalk, and advancing to the central capsule, which it traverses from beginning to end, and where it finally terminates in a fixed swollen extremity. The ten or fifteen innermost capsules are in contact with one another, while the rest are separated by a clear space containing fluid, which is so abundant as to constitute far the largest portion of the bulk of the entire corpuscle. Such are the views of Pacini (as given in his *Nuovi Organi Scoperte nel Corpo Umano*, 1840), who is usually regarded as their discoverer, although they had been noticed and roughly described nearly a century before by Vater, of Henle, and of Todd and Bowman; but later observations made by Huxley, Leydig, Külliker, and others, shew that the question of their true nature is still an open one. Huxley asserts that their central portion is solid, and not hollow; that in birds, and in the human hand, there is no fluid between the laminae—and indeed, that the laminae themselves have no real existence—the Pacinian corpuscle being merely a solid mass of connective tissue (a thickened process of the neurilemma of the nerve to which it is attached), whose *apparent lamination* depends on the regular disposition of its elastic elements. If Pacini's view of these structures be correct, there is probably some general analogy between the electric organs of the torpedo and these corpuscles; at present, we know nothing with certainty regarding their office.

**PACKFONG**, or **PETONG**, a Chinese alloy or white metal, consisting of arsenic and copper. It is formed by putting two parts of arsenic in a crucible with five parts of copper turnings, or finely divided copper; the arsenic and copper require to be placed in alternate layers, and the whole is covered with a layer of common salt, and pressed down. When melted, the alloy contains nearly the whole of the arsenic, and is yellowish-white in colour when in the rough state, but takes a fine white polish resembling silver. It is not very ductile, and cannot be fused without decomposition, as the arsenic is easily dissipated. It was formerly much used in this country, as well as China and India, for making the pans of small scales, dial-plates, and a variety of other articles requiring nicety of make, such as



graduated scales for philosophical instruments. It is probably never imported now, the nickel alloys of Europe having quite superseded its use; in China, however, it is still extensively employed.

**PACKHORSE**, a horse employed in the carriage of goods, which are either fastened on its back in bundles, or, if weighty, are placed in panniers, slung one on each side across the horse's back. The saddle to which the bundles were fastened consisted of two pieces of wood, curved so as to fit the horse's back, and joined together at the ends by other two straight pieces. This frame was well padded underneath, to prevent injury to the horse's back, and was firmly fastened by a girth. To each side of the saddle, a strong hook was attached, for the purpose of carrying packages, panniers, &c. Panniers were sometimes simply slung across the horse's back with



Packhorse and Panniers.

a pad under the band. The panniers were wicker baskets, and of various shapes, according to the nature of their usual contents, being sometimes long and narrow, but most generally having a length of three feet or upwards, a depth of about two-thirds of the length, and a width of from one to two feet (see fig.). The packhorse with panniers was at one time in general use for carrying merchandise, and for those agricultural operations for which the horse and cart are now employed; and in the mountainous regions of Spain and Austria, and in other parts of the world, it still forms the sole medium for transport; though the mule has, especially in Europe, been substituted for the horse.

An army requires to be accompanied by several thousand pack-animals, sometimes horses, but preferably mules; and in Asia, commonly camels, or even elephants. Pack-saddles are variously fitted, according to the objects to be carried: some for provisions or ammunition; others for carrying wounded men, tents, and, in mountain-warfare, even small cannon. In battle, the immediate reserves of small-arm ammunition are borne in the rear of divisions by pack-animals; the heavy reserves being in wagons between the army and its base of operations.

**PACOURY-UVA**, a sweet and delicious Brazilian fruit, a large berry, produced by the *Platonia insignis*, a tree of the natural order *Clusiaceae*. The seeds have the taste of almonds.

**PACTOLUS**, anciently the name of a small brook of Lydia, in Asia Minor, which rises on the northern slope of Mount Tmolus (modern *Buz Dagh*), flows north past Sardis, and empties itself into the Hermus (modern *Kodus*). It is never more than ten feet broad, and one foot deep. The sands or mud of P. were long famous in antiquity for the particles of gold dust which they contained, and which are supposed to have been carried down by

its waters from the bosom of Tmolus—a hill rich in metals. The collection of these particles, according to legend, was the source of Croesus's vast wealth. But as early even as the time of Strabo, P. had ceased to yield any of the precious dust. The brook is now called *Sarabat*.

**PACTUM ILLICITUM** is, in the law of Scotland, a contract or agreement for some illegal purpose, i. e., a purpose either expressly prohibited by statute, or by the general policy of the law. Thus, an immoral contract between a man and woman would be held void on the ground, that the law discountenances practices *contra bonos mores*. A contract between a client and agent, called a *pactum de quota litis*, whereby a share of the property which is the subject of litigation is given to the agent instead of his usual fees, is void in most cases; though it is often difficult to determine what contracts fall within this rule. The courts, however, have construed very jealously every contract which tends to corrupt the administration of the law, and hence an agreement between a town and country agent to divide the profits has been held a *pactum illicitum*. So agreements by a client to give an excessive sum to his law-agent as a gift have been often set aside.—In England, similar doctrines prevail, though the phrase *pactum illicitum*, which was borrowed from the Roman law, is not used, contracts of this description being technically described as illegal contracts.

**PADANG**, the capital of the Dutch government of the west coast of Sumatra, is situated in 1° S. lat., and 100° 22' E. long., and has about 12,000 inhabitants. The river Padang flows through the town, but is only navigable for small vessels, the larger requiring to anchor in the roadstead, about three miles distant. On the left bank, stand the houses of the natives, unsightly bamboo erections, elevated about eight feet from the ground by posts of the cocoa-nut tree, and covered with leaves. The government buildings, houses of the Europeans and Chinese, &c., are on the right, and mostly built of wood or stone, and roofed with tile. P. is picturesquely enclosed by a semicircle of mountains, behind which rises a loftier chain, two being volcanoes. There are a Protestant church, a Roman Catholic church, flourishing schools, a fort, military hospital, government workshops, large warehouses, &c. An agent of the Netherlands Trading Company (q. v.) resides at Padang. Being the centre of the exports and imports of Sumatra's west coast, P. has a lively trade, not only with Java, the other islands of the Eastern Archipelago, and Europe, but also with the interior of the island.

The climate is considered healthy, although the heat is great. Colonel Nahuys found the thermometer range from 70° to 80° at 6 A. M., from 82° to 88° at noon, 84° to 90° at 2 P. M., 78° to 84° at 6 P. M., and from 72° to 80° at 10 in the evening.

The governor resides at a country-house about two and a half miles above P., and rules over a territory stretching, from the Residency of Bencoolen, which has a population of 112,000 souls, and stands immediately under the government at Batavia, north-west over seven degrees of latitude. It is divided into the residencies of Lower Padang, Upper Padang, and Tapanoeeli; the population, in 1858, being 1,551,251, of whom 1557 were Europeans, and 2859 Chinese.

Lower Padang was the first district of the west coast of Sumatra which submitted to the Dutch, who had formed a settlement at Padang as early as 1660, and by repeated wars, gradually extended their territory.

Upper Padang lies to the north-west of the lower

## PADDLE—PADDLE-WHEEL.

province, from which it is separated by a chain of lofty mountains, some of which, as the Singalang, Merapie, and Sago, attain to nearly 10,000 feet in height; Merapie being an active volcano, the last eruptions of which were in 1845 and 1855, though it sent forth volumes of smoke in 1861. This residency possesses the most lovely districts of the island, or of any tropic land, the mountain slopes being studded with villages, rice-fields, cocoa-nut and coffee trees, of which last, it is calculated that there are 32,000,000 in Upper Padang. In addition to the coffee-culture, gambier, cassia, pepper, ratans, indigo, caoutchouc, &c., are largely produced, and gold, iron, copper, lead, and quicksilver are found. In the district of Tanah Datar is the town of Paggeroejong, formerly the capital of the powerful kingdom of Menangkabo, and the residence of the king.

Tapanoeli, the remaining residency under the government of Sumatra's west coast, lies north-west from Upper Padang. The independent spirit of the inland natives has caused the Netherlanders much trouble, but each fresh outbreak only extends their territory and power further into the interior, and towards the north-west of the island.

**PADDLE**, probably the precursor of the OAR (q. v.), and still its substitute among barbarous nations, is a wooden implement, consisting of a wide

flat blade with a short handle, by means of which the operator spoons the water towards him. In canoes for only one sitter, a double paddle is generally used, which is dipped alternately on either side: the inhabitants of Greenland are especially skilful in this operation. The action of the paddle is the same as that of the oar. The paddle has, however, one advantage

—viz., that the rower faces the bow of his boat, and therefore sees what is before him. In threading narrow streams, &c., this is an appreciable gain.

**PADDLE-WHEEL**—one of the appliances in steam-vessels by which the power of the engine is made to act upon the water and produce locomotion—is a skeleton wheel of iron, on the outer portion of whose radii flat boards, called floats or paddles, are fixed, which beat upon the water, and produce, continuously, the same effect as is given, in an intermittent manner, by the blades of oars. The use of paddle-wheels in conjunction with steam as a motive-power dates from about the commencement of the present century, but the employment of the paddle-wheel itself is as ancient as the time of the Egyptians. A specimen is also known to have been tried in Spain in the 16th century.

The fig. shews the usual form of paddle-wheel, that called the radial, in which the floats are fixed. It will be seen that a certain loss of power is involved, as the full force of the engine on the water is only experienced when the float is vertical, and as on entering and leaving the water the power is mainly devoted to respectively lifting and drawing down the vessel. This objection has great force at the moment of starting, or when progress is very slow, as is illustrated by the small power a paddle-steamer evinces when trying to tug a stranded vessel off a sandbank; but when in full progress, the action is less impeded by this circumstance, the water in front of the wheel being depressed, and

that abaft being thrown into the form of a wave, so as in each case to offer a nearly vertical resistance to the float. The extent of the immersion much

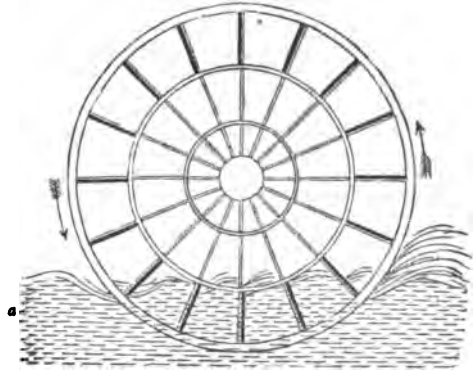

Ordinary Paddle-wheel.

influences the economy of power, as when the water reaches to the centre of the wheel or above it, it is obvious that the greatest waste must take place. From this it is advantageous to give the wheel as large a diameter as possible, and to place the axis at the highest available point in the vessel.

To overcome the drawbacks to the radial wheel, Elijah Galloway patented, in 1829, the *Feathered Paddle-wheel*, in which the floats are mounted

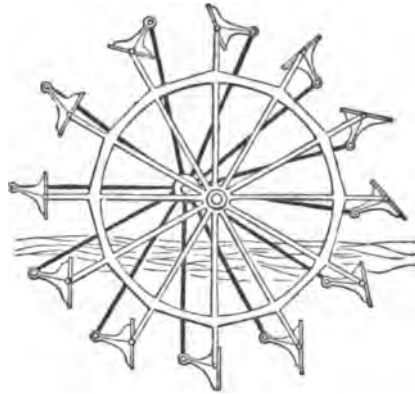

Feathered Paddle-wheel.

on axes, and are connected by rods with a common centre, which is made to revolve eccentrically to the axis of the paddle-wheel. By this method, the floats are kept, while immersed, at right angles to the surface of the water. So long as the water is smooth, and the immersion constant, the gain is great; consequently, feathered floats are much used in river-steainers; but for ocean-steainers, the liability to derangement, perhaps at a critical period, and the variable depth of immersion, prevent them from becoming favourites.

A recent wheel, called the *Cycloidal*, has the floats divided into smaller sections, in order that the action on the water may reach the maximum of uniformity.

From various causes, the wheel slips somewhat in the water—i. e., revolves more rapidly than the ship makes way. The difference between the two speeds is called the *slip*, and amounts sometimes to one-fifth of the actual speed.

**PADDY**, or **PADDIE**, the name commonly applied in India to rice in the husk. It is the Tamil and the Malay name. See **RICE**.

**PADELLA** (Ital. a frying-pan; plur. *padelle*), a shallow vessel of metal or earthenware used in illuminations. The illumination of St Peter's at Rome, and other large buildings in Italy, is effected by the tasteful arrangement of large numbers of these little pans, which are converted into lamps by partly filling them with tallow or other grease, and placing a wick in the centre. This mode of illumination was first adopted on a large scale in Great Britain on the occasion of the marriage of the Prince of Wales with the Princess Alexandra, when the inhabitants of Edinburgh produced by this means a most magnificent illumination of their city.

**PADERBORN**, the chief town of a district in the Prussian province of Westphalia, situated in 51° 43' N. lat., and 8° 45' E. long., in a pleasant and fruitful district, is built at the source of the Pader, which bursts forth from below the cathedral with sufficient force to drive mills within 20 paces of its point of exit. Pop. 11,279. P. has narrow, dark, old-fashioned streets, presenting no special attractions, although it has some interesting buildings, as, for instance, the fine old cathedral, completed in 1143, with its two magnificent façades, and containing the silver coffin in which are deposited the remains of St Liborius. It is the seat of a bishop and chapter, and of an administrative court. The manufactures of P., which are not very considerable, include tobacco, starch, hats, and wax-cloths, and there are several breweries, distilleries, and sugar-refineries in the town, which carries on a considerable trade in cattle, corn, and oils. P. is one of the important stations on the Great Westphalia Railway. P., which ranked till 1803 as a free imperial bishopric, owes its foundation to Charlemagne, who nominated the first bishop in 795. Several diets were held during the middle ages at P., which at that period ranked as one of the most flourishing of the Hanseatic Cities, while it was also numbered among the Free Imperial Cities. In 1604, it was forcibly deprived by the prince-bishop, Theodor of Fürstenburg, of many of the special rights and prerogatives which it had enjoyed since its foundation, and compelled to acknowledge the Roman Catholic as the predominant church, in the place of Protestantism, which had been established during the time of Luther. In 1803, P. was, in accordance with a decree of the imperial commissioners, attached as an hereditary principality to Prussia, which had taken forcible possession of the territory of Paderborn; and after being for a time incorporated in the kingdom of Westphalia, it was restored to Prussia in 1813, and incorporated in the Westphalian circle of Minden.

**PADIHAM**, a rising manufacturing town in Lancashire, near the Calder, 3 miles west-north-west of Burnley, and 17 miles east-north-east of Preston. The older portion is ill-built, and has a mean appearance, but the more modern quarter contains a number of good buildings. P. is the seat of active cotton manufactures. Population of the town, within the lighting district (1861), 5675.

**PADILLA**, **JUAN DE**, one of the most popular heroes in Spanish history, was a scion of a Toledan family, one of the most ancient and illustrious in Spain, and was appointed by the Emperor Charles V. military commandant of Saragossa. While he was so employed, a formidable rebellion, caused by the excessive taxes which the emperor imposed on the Spaniards, to defray the cost of his various wars in Italy, Germany, and the Low Countries, broke out

among the towns (*comunidades*) of Castile, and the rebels, who were known as *comuneros*, called upon P. to put himself at their head. The introduction of the religious element into the quarrel tended greatly to strengthen the insurgents, and for an instant P. was the ruler of Spain, and formed a new junta to carry on the government. He was successful in a number of enterprises undertaken against the royalist party; but on 23d April 1521, was completely beaten by the royalists at Villalca. This conflict decided the fate of the rebellion and of P. himself, who was taken prisoner, and next day beheaded.

His wife, **DONA MARIA DE PACHECO**, rallied the wrecks of the rebel army, and for a long time held Toledo against the royalist besieging army, and after its fall, retired to Portugal, where she died soon afterwards. With P. and his wife expired the last remnant of the ancient freedom of Spain. Numerous poems and dramas celebrate their deeds.

**PADI'SHAH**, in Turkish **PADISHAH** (Persian *padi*, protector or throne, *shah*, prince), one of the titles of the Sultan of the Ottoman Empire, and of the Shah of Persia. Formerly, this title was accorded only to the kings of France among European monarchs, the others being called *Kral*, king. It was subsequently allowed to the Emperor of Austria, and still later, by a special article in the treaty of Kutshuk-Kainardji (10th January 1775), to the autocrat of All the Russias. Padishah was the title assumed by Baber and his successors on the throne of Delhi.

**PAD'UA** (Ital. *Padova*), capital of the province of the same name in Austrian Italy, stands on a beautiful plain on the Bacchiglione, 23 miles by railway west-south-west of Venice. It is surrounded by walls and ditches, and is fortified by bastions. Its houses are lofty, supported for the most part on long rows of arches, generally pointed; and most of its streets, especially in the older quarters, are narrow, dark, dirty, and ill-paved. There are, however, several handsome gates, as those of San Giovanni, Savonarolo, and Falconetto; a number of fine squares, of which the Prato della Valle is the largest and the finest, and is surrounded by a stream, and planted with trees; and several magnificent buildings. Of these, the Café Pedrocchi is esteemed the finest edifice of the kind in Italy. Portions of a Roman edifice were discovered while the foundations of this building were being made, and the marbles found now adorn the pavement, &c., of the *salone*. The Palazzo della Municipalità, built 1172—1219, is the most peculiar and most national in the city. It is an immense building, forming one side of the market-place, rests wholly on arches, and is surrounded by a loggia (q. v.). Its east end is covered with shields and armorial bearings, and its roof is said to be the largest unsupported by pillars in the world. Its hall is 267½ feet long, and 89 feet wide, is covered with mystical and metaphorical paintings, and contains a monument of Livy, the Roman historian, and a bust of Belzoni, the traveller, both natives of this city. The other chief edifices are the cathedral, the church of Sant' Antonio, a beautiful building in the Pointed style, with several Byzantine features, and remarkably rich and splendid in its internal decorations; and the churches of San Giorgio and of Santa Giustina; all of them richly decorated with paintings, sculptures, &c. The university of P., the most famous establishment in the city, was celebrated as early as the year 1221. It embraces 46 professorships, and is attended by from 1500 to 2000 students. Connected with the university are an anatomical theatre and

a botanic garden, both dating from the 16th c., and each the first of its kind in Europe. There is also a museum of natural history, an observatory, a chemical laboratory, and a library of 100,000 volumes, and 1500 manuscripts. There are also numerous palaces, theatres, and hospitals. Pop. 54,000.

**P.**, the Roman *Patavium*, is one of the most ancient towns of Italy. According to a wide-spread belief of antiquity, alluded to by Virgil, it was founded by the Trojan chief Antenor, but we really know nothing of its history until it became a Roman town. During the first centuries of the empire, it was the most flourishing city in the north of Italy, on account of its great woollen manufactures, and could return to the census more persons wealthy enough to be ranked as *equites* than any other place except Rome. But in 452 Attila utterly razed it to the ground. It was, however, rebuilt by Narses, again destroyed by the Lombards, but once again rose from its ashes, and became a very famous city in the middle ages. It fell into the hands of the Carrara family in 1318, and in 1405 it was conquered by Venice, the fortunes of which it has since shared.

**PADUCAH**, a city of Kentucky, U. S., on the south bank of the Ohio River, just below the mouth of the Tennessee River, 347 miles below Louisville. It is the entrepôt of a fertile country, and has a large trade by the rivers, and the New Orleans and Ohio Railway, of which it is the northern terminus. It contains county buildings, three banks, three shipyards, steam saw-mills, extensive manufacturing establishments, and ten churches. Pop. about 7000.

**PÆAN** (of doubtful etymology), the name given by the ancient Greeks to a kind of lyric poetry originally connected with the worship of Apollo. The oldest pæans, as we learn from Homer, appear to have been either hymns, addressed to that deity for the purpose of appeasing his wrath (*Iliad*, i. 473), or thanksgiving odes, sung after danger was over and glory won (*Iliad*, xxiii. 391). Nevertheless, at a later period, they were addressed to other deities also. Thus, according to Xenophon, the Lacedæmonians sung a pæan to Poseidon after an earthquake, and the Greek army in Asia one to *Zens*.

**PÆDO-BAPTISM.** See **BAPTISM, INFANT.**

**PÆ'ONY** (*Pæonia*), a genus of plants of the natural order *Ranunculaceæ*; having large flowers, with five persistent, unequal, leafy, and somewhat leathery sepals, 5—10 petals, many stamens, and 2—5 germens, which are crowned with a fleshy recurved stigma. The leaves are compound, the leaflets often variously and irregularly divided. The fibres of the root are often thickened into tubers. The species are large herbaceous perennials, or rarely half-shrubby; natives of Europe, Asia, and the north-west of America. None of them are truly indigenous in Britain, although one (*P. corallina*) has found admittance into the English flora. On account of the beauty of their flowers, some of them are much cultivated in gardens, particularly the COMMON P. (*P. officinalis*), a native of the mountain-woods of the south of Europe, with carmine or blood-red flowers. A variety with double flowers is common.—The WHITE P. (*P. albiflora*) is another favourite species. It is a native of the central parts of Asia. Its flowers are fragrant.—The TREE P., CHINESE P., or MOUTAN (*P. Moutan*), is a half-shrubby plant, a native of China and Japan. In favourable circumstances, it attains a very large size, and a height of twelve feet or more. It has been long cultivated in China and Japan; and is

now also a favourite ornamental plant in the south of Europe, and in the south of England and Ireland; but the late spring-frosts of most parts of Britain are injurious to it, although it can bear severe frost in winter, when vegetation is at a stand. It flowers in spring. The varieties in cultivation are numerous. It is propagated by cuttings, and also by grafting. Its germens are surrounded by a cup-shaped lacinated membrane.—The roots of most of the pæonies have a nauseous smell when fresh, and those of the Common P. were in high repute among the ancients as an antispasmodic—hence the name *l'æony*, from *Paion*, a Greek name of Apollo, the god of medicine—but their medicinal properties are now utterly disregarded. The globose, shining black seeds of pæonies were formerly, in some countries, strung into necklaces, and hung round the necks of children, as *anodyne necklaces*, to facilitate dentition. The Daurians and Mongolians use the root of *P. albiflora* in their soups, and grind the seeds to mix with their tea.

**PÆSTUM**, anciently a Greek city of Lucania, in the present Neapolitan province of Principato Citeriore, on the *Sinus Pæstanus*, now the Gulf of Salerno, and not far from Mount Alburnus. It was founded by the Trezenians and the Sybarites, some time between 650 and 610 B.C., and was originally called Poseidonia (of which *Pæstum* is believed to be a Latin corruption), in honour of Poseidon (Neptune). It was subdued by the Samnites of Lucania, and slowly declined in prosperity after it fell into the hands of the Romans, who established a colony here about 273 B.C. The Latin poets celebrate the beauty and fragrance of its flowers, and particularly of its roses, which bloomed twice a year. Wild roses, it is said, still grow among its ruins, which retain their ancient property, and flower regularly both in May and November. P. was burned by the Saracens in the 10th c., and there is now only a small village called Pesto, in a marshy, unhealthy, and desolate district; but the ancient greatness of the city is indicated by the ruins of temples and other buildings. These appear to have been first noticed in the early part of the 18th c., by a certain Count Gazola, in the service of the king of Naples; they were next described by Antonini, in a work on the topography of Lucania (1745), and have since been visited by travellers from all parts of Europe.

**PAGANINI, NICOLÒ**, a famous violinist, son of a commission-broker at Genoa, where he was born in 1784. His musical talent shewed itself in his childhood; in his ninth year, he had instructions from Costa at Genoa, and afterwards from Rolla at Parma, and from Ghiretti. In 1801, he began his professional tours in Italy; in 1828, he created a great sensation on appearing for the first time in the principal towns of Germany; and in 1831, his violin-playing created an equal *furor* in Paris and London. His mastery over the violin has never been equalled, but he was too much addicted to using it in mere feats of musical legerdemain, such as his celebrated performance on a single string. His execution on the guitar was also very remarkable; for four years he made that instrument his constant study. P. died at Nice in 1840, leaving a large fortune.

**PAGANISM**, another name for Heathenism or Polytheism. The word is derived from the Latin *paganus*, a designation of the inhabitants of the country (*pagnus*), in contradistinction to the inhabitants of towns, the more educated and civilised inhabitants of towns having been the first generally to embrace Christianity, whilst the old polytheism lingered more in remote rural districts.

**PAGE** (derivation variously assigned to Gr. *pais*, a boy, and Lat. *pagus*, a village), a youth employed in the service of a royal or noble personage. The practice of employing youths of noble birth in personal attendance on the sovereign, existed in early times among the Persians, and was revived in the middle ages under feudal and chivalric usages. The young nobleman passed in courts and castles through the degree of page, preparatory to being admitted to the further degrees of esquire and knight. The practice of educating the higher nobility as pages at court, began to decline after the 15th c., till pages became what they are now, mere relics of feudal usages. Four pages of honour, who are personal attendants of the sovereign, form part of the state of the British court. They receive a salary of £200 a year each, and on attaining a suitable age, receive from her Majesty a commission in the Foot Guards without purchase.

**PAGET, FAMILY OF.** This noble family, though said to be of Norman extraction, do not trace their descent further back than the reign of Henry VII., in whose time, one William P. held the office of one of the sergeants-at-mace of the city of London. His son William, who was educated at St Paul's School, and at Cambridge, was introduced into public life by Stephen Gardiner, Bishop of Winchester, early in the reign of Henry VIII., who sent him abroad to obtain the opinions of foreign doctors as to his contemplated divorce from Catharine of Aragon. From this time forth his rise was rapid, and he was constantly employed in diplomatic missions until the death of the king, who appointed him one of his executors. He now adhered to the party of the Protector Somerset, and was raised to the peerage in 1552, as Lord Paget of Beaudesert. He shared in the power, and also in the fall, of the Protector, and was heavily fined by the Star Chamber, who also deprived him of the insignia of the Order of the Garter. His disgrace, however, was not of long continuance, and a change taking place in the councils of his opponents, he soon obtained his pardon. On the accession of Queen Mary, he was sworn a member of the privy council, and obtained several large grants of lands. He retired from public life on the accession of Elizabeth, who regarded him with much favour, though he was a strict Roman Catholic. The representative of the family adhered to the cause of Mary Queen of Scots, and suffered, in consequence, the confiscation of his property. The fifth Lord P. so far departed from the traditionary policy of the family as to accept from the parliament the lord-lieutenancy of Buckinghamshire; but he returned to his allegiance shortly afterwards, and held the command of a regiment under the royal standard at the battle of Edgehill. His grandson was advanced to the earldom of Uxbridge, but this title becoming extinct, the representation of the family devolved on a female, who carried the barony of Paget by marriage into the house of Bayly. The son of this marriage, however, having assumed the name of Paget, obtained a renewal of the earldom of Uxbridge, and the second earl, for his gallantry at Waterloo, was advanced to the marquise of Anglesey. Of late years, the P. family have usually held three or four seats in every parliament, and they have constantly supported the liberal party.

**PAGING-MACHINE.** Several machines have been made for paging books and numbering bank-notes, cheques, railway-tickets, and other similar papers. The great object of these machines is to prevent the chance of error or fraud by making it impossible that a page, cheque, &c. can be abstracted or lost without detection. Messrs

Waterlow and Sons of London perfected an ingenious machine, by which pages of books, such as ledgers and other commercial books, and bank-notes, &c., are numbered in regular succession. The numbers are engraved on metal rowels, usually of steel or brass. A series of these rowels are so arranged, that when the machine is worked, the numbers must be impressed on the paper in regular succession from 1 to 99,999; and it is impossible to produce a duplicate number until the whole series has been printed. The instrument is made to supply ink to the types, so that it may be locked in such a manner as to admit of being worked without the chance of its being tampered with.

An extremely ingenious modification of this machine has been perfected by M. Auguste Tronillet of Paris, under the name of 'Numérateur Mécanique,' which is not only more simple, but admits of wider application; for it not only pages books and numbers notes, tickets, &c., but can also be used for numbering bales and other packages of merchandise. The instrument has six rowels, on each of which is a set of engraved numbers, so arranged, that their revolutions produce in regular succession the required numbers, by the action of a lever which moves horizontally, and supplies the type with ink as it moves backwards and forwards.

**PAGO**, an island belonging to the Austrian crownland of Dalmatia, separated from Croatia by the Morlaeca Canal, a channel from two to three miles in width. It is long and narrow, runs parallel to the Croatian Coast, and has an area of 84 square miles. Pop. 4910, who are most industrious, and support themselves by vine-culture, the manufacture of salt and fishing.

**PAGODA** (according to some, a corruption of the Sanscrit word *bhāgavata*, from *bhagavati*, sacred; but according to others, a corruption of *put-gala*, from the Persian *put*, idol, and *gada*, house) is the name of certain Hindu temples, which are amongst the most remarkable monuments of Hindu architecture. Though the word itself designates but the temple where the deity—especially Siva, and his consort Durgā or Pārvati—was worshipped, a pagoda is in reality an aggregate of various monuments, which, in their totality, constitute the holy place sacred to the god. Sanctuaries, porches, colonnades, gateways, walls, tanks, &c., are generally combined for this purpose, according to a plan, which is more or less uniform. Several series of walls form an enclosure; between them are alleys, habitations for the priests, &c., and the interior is occupied by the temple itself, with buildings for the pilgrims, tanks, porticos, and open colonnades. The walls have, at their openings, *gopuras*, or large pyramidal gateways, higher than themselves, and so constructed that the gopura of the outer wall is always higher than that of the succeeding inner wall, the pagoda itself being smaller than the smallest gopura. The extent of the enclosing walls is generally considerable; in most instances, they consist of hewn stones of colossal dimensions, placed upon one another without mortar or cement, but with such admirable accuracy, that their joints are scarcely visible. The gateways are pyramidal buildings of the most elaborate workmanship; they consist of several, sometimes as many as fifteen stories. The pagodas themselves, too, are of a pyramidal shape, various layers of stones having been piled upon one another in successive recession; in some pagodas, however, the pyramidal form begins only with the higher stories, the broad basis extending to about a third of the height of the whole building. The sides of the different terraces are vertical; but the transition from one to the

other is effected by a vault surmounted by a series of small cupolas, which hide the vault itself. A single cupola, hewn out of the stone, and surmounted by a globe, generally crowns the whole structure; but sometimes the latter also ends in fantastical spires of a fanlike shape or concave roofs. The pagodas are covered all over with the richest ornamentation. The pilasters and columns, which take a prominent rank in the ornamental portion of these temples, shew the greatest variety of forms; some pagodas are also overlaid with strips of copper, having the appearance of gold. The most celebrated pagodas on the mainland of India are those of Mathura, Trichinopoli, Chalambron, Konjeveram, Jaggernaut, and Deogur, near Ellora.—That of Mathura consists of four stories, and is about 63 feet high; its base comprises about 40 square feet. Its first story is made of hewn stones, copper, and covered with gilt; the others of brick. A great number of figures, especially representing deities, tigers, and elephants, cover the building.—The pagoda of Tanjore is the most beautiful monument of this kind in the south of India; its height is 200 feet, and the width of its basis is equal to two-thirds of its height.—The pagoda of Trichinopoli is erected on a hill, elevated about 300 feet over the plain; it differs in style from other pagodas dedicated to Brahminical worship, and exhibits great similarity with the Buddhistic monuments of Tibet.—The great pagoda of Chalambron, in Tanjore, is one of the most celebrated and one of the most sacred of India. It is dedicated to S'iva and Párvati, and filled with representations belonging to the mythical history of these gods. The buildings of which this pagoda is composed cover an oblong square, 360 feet long, and 210 feet wide.—At Konjeveram, there are two pagodas—the one dedicated to S'iva, and the other to Párvati.—The pagodas of Jaggernaut, on the north end of the coast of Coromandel, are three; they are erected likewise in honour of S'iva, and are surrounded by a wall of black stones—whence they are called by Europeans the Black Pagodas—measuring 1122 feet in length, 696 feet in width, and 24 feet in height. The height of the principal of these three pagodas is said to be 344 feet; according to some, however, it does not exceed 120—123 feet.—The pagoda of Deogur, near Ellora, consists also of three pagodas, sacred to S'iva; they have no sculptures, however, except a trident, the weapon of S'iva, which is visible on the top of one of these temples.—The monuments of Mavalipura, on the coast of Coromandel, are generally called the Seven Pagodas; but as these monuments—which are rather a whole city, than merely temples—are buildings cut out of the living rock, they belong more properly to the rock-cut monuments of India, than to the special class of Indian architecture comprised under the term pagoda.

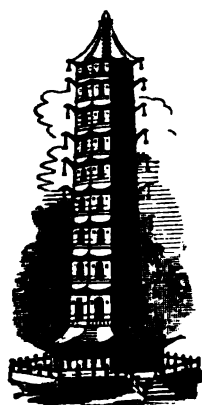

Porcelain Tower of Nanking.

buildings, however, differ materially from the Hindu pagodas, not only so far as their style and exterior appearance are concerned, but inasmuch

as they are buildings intended for other than religious purposes. The Chinese call them *Ta*, and they are generally erected in commemoration of a celebrated personage, or some remarkable event; and for this reason, too, on some elevated spot, where they may be conspicuous, and add to the charms of the scenery. Some of these buildings have a height of 160 feet; the finest known specimen of them is the famous Porcelain Tower of Nanking (q. v.). The application of the name pagoda to a Chinese temple should be discountenanced, for, as a rule, a Chinese temple is an insignificant building, seldom more than two stories high, and built of wood; the exceptions are rare, and where they occur, as at Peking, such temples, however magnificent, have no architectural affinity with a Hindu pagoda.

**PAGURUS AND PAGURIDÆ.** See HERMIT CRAB.

**PAHLANPUR,** a town of India, capital of the state of the same name, 260 miles east-south-east of Hyderabad. It is a walled town, is the seat of extensive trade and of several manufactures. Pop. estimated at 30,000, many of whom are artificers and shopkeepers. The state of which P. is capital lies between lat. 23° 57'—24° 41' N., and long. 71° 51'—72° 45' E. One-seventh of the population are Moslem, and the remainder Hindus. The state, out of a revenue of £30,000, pays an annual tribute of £5000 to the Guicowar, and £600 per annum for the maintenance of a British political agent. The exact area of the state is not known; the state, however, contains 300 villages; pop. 130,000. The products are wheat, rice, sugar-cane, and cotton. In the north and west, the soil yields only one crop annually; but in the south and east, three crops are obtained in the year.

**PAILA** is, according to the Purán's (q. v.), one of the disciples of Vyása (q. v.), the reputed arranger of the Vedas (q. v.); he was taught by the latter the R'igveda, and, on his part, communicated this knowledge to Bâhkali and Indrapramati. This tradition, therefore, implies that P. was one of the earliest compilers of the R'igveda.

**PAIN** is an undefinable sensation, of the nature of which all persons are conscious. It resides exclusively in the nervous system, but may originate from various sources. Irritation, or excessive excitement of the nervous system, may produce it; it frequently precedes and accompanies inflammation; while it sometimes occurs in, and seems to be favoured by, a state of positive depression, as is seen in the intense pain which is often experienced in a limb benumbed with cold, in the pain which not unfrequently accompanies palsy, and in the well-known fact, that neuralgia is a common result of general debility. Hence, pain must on no account be regarded as a certain indication of inflammation, although it rarely happens that pain is not felt at some period or other in inflammatory diseases. Moreover, the pain that belongs to inflammation, differs very much, according to the organ or tissue affected; the pain, for example, in inflammation of the lungs, differs altogether in character from that which occurs in inflammation of the bowels, and both these pains from that occurring in inflammation of the kidneys.

Pain differs not only in its character, which may be dull, sharp, aching, tearing, gnawing, stabbing, &c., but in its mode of occurrence; for example, it may be flying or persistent, intermittent, remittent, or continued. It is not always that the pain is felt in the spot where the cause of it exists. Thus, inflammation of the liver or diaphragm may cause pain in the right shoulder, the irritation

caused by stone in the bladder produces pain at the outlet of the urinary passage; disease of the hip-joint occasions pain in the knee, disease of the heart is often accompanied with pain in the left arm, and irritation of the stomach often gives rise to headache. Pain is differently felt by persons of different constitutions and temperaments, some persons being little sensitive to painful impressions of any kind, while others suffer greatly from slight causes. There even seem to be national differences in this respect; and before the introduction of chloroform, it was a matter of common observation that Irishmen were always more troublesome subjects for surgical operations than either Englishmen or Scotchmen; and the negro is probably less sensitive to pain than any of the white races.

Although in most cases we are to regard pain merely as a symptom to be removed only by means which remove the lesion which occasions it, there are cases in which, although it is only a symptom, it constitutes a chief element of disease, and one against which remedies must be specially directed. As examples of these cases, may be mentioned neuralgia, gastralgia, colic, dysmenorrhœa, and perforation of the intestines; and in a less degree, the stitch of pleurisy, which, if not relieved, impedes the respiration, and the pain of tetanus, which often causes such efforts to empty the lower bowel, as seriously to disturb the functions of the intestine, and to exhaust the strength.

For the methods of relieving pain, the reader is referred to the articles on the different diseases in which it specially occurs (as COLIC, NEURALGIA, PLEURISY, &c.), and to those on CHLOROFORM, ETHER, INDIAN HEMP, MORPHIA, NARCOTICS, OPIUM, &c.

**PAINÉ, THOMAS**, an author famous for his connection with the American and French revolutions, and for his advocacy of infidel opinions, was born 29th January 1737, at Thetford, in the county of Norfolk in England. He was trained to the business of his father, who was a staymaker, but afterwards obtained a situation in the Customs, and the management of a tobacco-manufactory. His income, however, was small, and he fell into debt, and was dismissed in 1774, upon which he went to America, was favourably received by a bookseller in Philadelphia, and in 1776 published a pamphlet entitled *Common Sense*, written in a popular style, in which he maintained the cause of the colonies against the mother-country. The success and influence of this publication were extraordinary, and it won him the friendship of Washington, Franklin, and other distinguished American leaders. He was rewarded by Congress with the appointment of Secretary to the Committee of Foreign Affairs, visited France in the summer of 1787, where he made the acquaintance of Buffon, Malesherbes, La Rochefoucauld, and other eminent men; and in the autumn following, went to England, where, in 1791, he published *The Rights of Man*, the most famous of all the replies to Burke's *Reflections upon the French Revolution*. The work has gone through innumerable editions, and has been translated into almost all the languages of Europe. His defence of the principles of the French Revolution against the magnificent assault of Burke and the outcry of the English aristocracy is vigorous, and by no means unsuccessful. But the value or at least the popularity of the work has been injured by its advocacy of extreme liberal opinions. His assaults on the British constitution exposed him to a government prosecution, and he fled to France, where he was admitted to citizenship; and in 1792, the department of Pas-de-Calais elected him a deputy to the National Convention, where he voted with the Girondists. At the trial of Louis XVI., says Madame de Staël, 'Thomas Paine alone

proposed what would have done honour to France if it had been accepted—the offer to the king of an asylum in America;' by which he offended the Mountain party; and in 1793, Robespierre caused him to be ejected from the Convention, on the ground of his being a foreigner, and thrown into prison. During his imprisonment, he wrote *The Age of Reason*, against Atheism, and against Christianity, and in favour of Deism. After an imprisonment of fourteen months, he was released, on the intercession of the American government, and restored to his seat in the Convention. He was chosen by Napoleon to introduce a popular form of government into Britain, after he should have invaded and conquered the island. But as Napoleon did not carry out his design, P. was deprived of an opportunity of playing the part of legislator for his conquered countrymen. He then retired into private life, and occupied himself with the study of finance. In 1802, he returned to the United States, and died there 6th June 1809. The most complete edition of his works is that by J. P. Mendum (Bost. 1856); the most noted of his numerous biographers is William Cobbett (1796).

**PAINS AND PENALTIES.** When a person has committed some crime of peculiar enormity, and for which no adequate punishment is provided by the ordinary law, the mode of proceeding is by introducing a bill of pains and penalties, the object of which, therefore, is to inflict a punishment of an extraordinary and anomalous kind. These bills are now seldom resorted to, and the last instance of an attempt to revive such a form of punishment was by the ministers of George IV. against Queen Caroline, an attempt which was signally defeated. When a bill of this kind is resolved upon, it is introduced, and passes through all the stages like any other bill in parliament, except that the party proceeded against is allowed to defend himself or herself by counsel and witnesses. The proceeding is substantially an indictment, though in form a bill.

**PAINTER**, in naval matters, is the rope by which a boat is fastened to a ship or pier.

**PAINTERS' CREAM**, a composition used by artists to cover oil-paintings in progress, when they leave off their work; it prevents drying, and the consequent shewing of lines where new work is begun. It consists of six parts of fine nut oil, and one part of gum-mastic. The mastic is dissolved in the oil, and then is added a quarter part of acetate, or sugar of lead, finely triturated with a few drops of the oil. When well incorporated with the dissolved mastic, water must be added, and thoroughly mixed, until the whole has the consistency of cream. It is applied with a soft brush, and can easily be removed with water and a sponge.

**PAINTING**, the art of representing objects to the eye on a flat surface by means of lines and colour, with a view to convey ideas and awaken emotions. See ART. As one of the fine arts, painting occupies a prominent place; some claim for it the first place, as combining the chief elements—namely, form, light and shade, and colour. As compared, however, with music and poetry, it lacks the important element of movement, the representation being confined, in a great measure, to one aspect and one instant of time. In its ruder and more elementary forms, in which the primary design was to communicate ideas, painting is perhaps the oldest of the arts, older, at all events, than writing (see ALPHABET, HIEROGLYPHICS); and, as a vehicle of knowledge, it possesses this advantage over writing—that no description, however minute, can convey so

## PAINTING.

accurate and distinct an idea of an object as a pictorial representation, much less make so vivid an impression. Besides this, it is not limited, as writing is, by differences of language, but speaks alike to all nations and all ages.

The great antiquity of painting is proved by remains discovered in Egypt, and by reference to it in ancient writings. It has been ascertained that as early as the 19th c. B.C., the walls and temples of Thebes were decorated by painting and sculpture. Ezekiel, who prophesied about 598 years B.C., refers to paintings in Jerusalem after the manner of the Babylonians and Chaldeans. Though no specimens have come down to us, it is evident that paintings of the highest excellence were executed in Greece. This is proved by what is recorded of them, for the subjects of many of those mentioned required the putting forth in a high degree of all the qualities requisite for the production of the greatest historical works, such as form, grouping, expression, foreshortening. From the immense sums given for paintings, the care with which they were preserved in temples and other public buildings, and from the fact of the high state of sculpture at contemporary periods, as proved by well-known works now extant, it may be deduced that painting, which, like sculpture, is based on design or drawing, must have occupied an equally high position. Even the imperfect specimens of painting discovered in Pompeii, where the style and influence of Greek art may be traced to some extent, lead to conclusions highly favourable to the high position of painting in classic times. The chief schools of painting in Greece were those of Sicily, Corinth, Athens, and Rhodes. The first great artist of whose works there is any authentic description, and from details of which an idea may be formed of his attainments, is Polygnotus of Thasos (flor. 420 B.C.), who painted, among other works, those in the *Præcile*, a celebrated portico at Athens, and the *Lesche*, or public hall at Delphi.

The works of Apollodorus of Athens (flor. 408 B.C.) are described and highly praised by Pliny. Zeuxis, the pupil of Apollodorus, Eupompus, Androcles, Parrhasius (q. v.) the Ephesian, and Timanthes of Sicily, prosecuted painting with distinguished success, and by them it was carried down to the time of Philip the father of Alexander. Of the same period was Pamphilus, celebrated not only for his works, but as the master of the artist universally acknowledged as the greatest of the ancient painters, Apelles (q. v.), who was born probably at Colophon, and flourished in the latter half of the 4th c. B.C. He was highly esteemed by Alexander the Great, and executed many important works for that monarch. Protogenes of Rhodes was a contemporary, and may be styled the rival of Apelles, who greatly admired his works. His picture of Ialysus the hunter and the nymph Rhodos was preserved for many years in the Temple of Peace at Rome. Art in Greece had now reached its highest point; its course afterwards was downwards.

In Italy, art was followed at a very early period by the Etruscans, and, according to Pliny, painting, as well as sculpture, was successfully practised in Ardea and Lanuvium, cities of Latium, perhaps more ancient than Rome. The finest specimens of Etruscan art, however—as the paintings on tombs, and the remains of armour and fictile ware ornamented with figures, evince unmistakably the influence of, or rather are identical with Greek art. According to Pliny, it was introduced from Corinth about 650 B.C. No great national school of painting ever flourished in Rome, for though the names of Romans who were painters are cited, the principal

works of art that adorned the temples and palaces of Rome were obtained from Greece, and it is probable that many of the paintings executed there were by Greek artists. When the seat of empire was transferred to the East, such art as then remained was carried with it, and in a new phase was afterwards recognised as Byzantine art—a conventional style, in which certain typical forms were adopted and continually repeated. This mode has been preserved, and is practised in church-painting in Russia at this present time.

Much discussion has arisen in modern times as to the supposed technical modes or processes of painting employed by the ancients. It seems established that painting in fresco was much practised; but many of the most valuable pictures we read of were removable, and there are accounts of some carried from Greece to Rome. 'The Greeks preferred movable pictures, which could be taken away in case of fire' (*Wilkinson on Egyptian and Greek Paintings*), and Pliny says Apelles never painted on walls; besides fresco paintings on walls, therefore, there can be no doubt that the ancients painted on boards; indeed, the name *Tabula* or *Tabula picta* proves this, and it seems to be now generally acknowledged that these were executed in tempora—that is, with size, and probably fixed or protected by some kind of varnish, in the preparation of which oil was used; or in encaustic, a process in which wax was employed to fix and give brilliancy and depth to the colours, heat being applied in working with it.

Painting was revived in Europe in the 13th c.; previous to that period, Byzantine artists chiefly were employed. On the conquest of Constantinople by the Latins in 1204, the Byzantine school was broken up, and many Greek artists were transplanted to Italy, where art was now destined to flourish, so the works of the Italians who profited by their instructions, were necessarily, at the commencement, composed in the Byzantine style. The first Italian whose name is associated with the revival of Italian art is Guido of Siena; a work by him, a large Madonna, inscribed with his name and the date 1221, is still preserved in that city. The next is Giunto da Pisa (1236). But Giovanni Cimabue (q. v.), (1240—1300), is commonly styled the founder of the Italian school. Several works of considerable importance are ascribed to him; and though he followed the Byzantine arrangement, he ventured occasionally out of the path, introduced the study of nature in his drawing, and imparted a greater degree of softness to his painting than the Byzantine artists. The influence of Byzantine art was not confined to Italy; it operated in Germany, Bohemia, and France; but there also art began to assume a national character early in the 13th c., and paintings are still preserved at Cologne, dated 1224. The Italian school of painting, or that style in which so many of the highest qualities of art have been so successfully carried out, received its chief impetus from Giotto (q. v.), the son of Bordone, born in 1276 at Vespignano, near Florence, where he died in 1336. It is said that he was originally a shepherd-boy, and being discovered by Cimabue drawing a sheep on a slate, was instructed by him in painting. His style is distinguished from that of earlier painters by the introduction of natural incidents and impressions, by greater richness and variety of composition, by the dramatic interest of his groups, and by total disregard of the typical forms and conventional style of his predecessors. His influence was not confined to Florence, but extended over the whole of Italy; and works by this artist may be traced from Padua to Naples. Giotto followed Pope Clement V.



to Avignon, and is said to have executed many important pictures there, and in other cities in France. The most celebrated of his frescoes now extant are those at Assisi; some noted works by him in that class also remain at Padua, Florence, and Naples. Most of the small easel-pictures ascribed to him are of doubtful authenticity, but some preserved in the gallery at Florence are acknowledged to be genuine. His high powers as a sculptor and architect are also exemplified by works in that city. Giotto had numerous scholars and imitators, and several of these have left works which shew that while they profited by his instruction or example, they were also gifted with original talent. Among these may be noticed Taddeo Gaddi, the favourite pupil of Giotto (born 1300, living in 1352); Simone Memmi (1284—1344); and Andrea Orcagna (1329—1389), one of the artists employed in the decoration of the celebrated Campo Santo at Pisa. Painting in Italy continued to be impressed with the feeling and style of Giotto for upwards of a hundred years; but early in the fifteenth century, the frescoes executed by Masaccio (1401—1443) in the Brancacci Chapel in the Carmelite Church at Florence, clearly prove that it had entered on a new phase, and had come forth strengthened by an important element in which it formerly was deficient, viz., correct delineation of form, guided by the study of nature. These celebrated frescoes, twelve in number, were at one time all ascribed to Masaccio; but it seems now to be acknowledged by judges of art that two of these are by Masolino da Panicale (1378—1415), the master of Masaccio; and three, or probably four, and a small portion of one, by Filippino Lippi (1460—1505). The frescoes by Masaccio, however, are superior to those by Masolino and Lippi, and, indeed, for many of the highest qualities in art, have, as compositions, only been surpassed by Raphael in his celebrated cartoons. In about a century from Masaccio's time, painting in Italy attained its highest development; but before referring to those artists who are acknowledged as having carried painting to the highest elevation it has attained since the period of the middle ages, it is right to note the names of some of the painters who aided in raising it to that position. The works of Fra Giovanni da Fiesole (1387—1455) are highly valued and esteemed by many critics as the purest in point of style and feeling, and so the best fitted for devotional purposes. Confining his efforts to simple and graceful action, and sweet and tender expression, he adhered to the traditional types, and ventured on none of the bold innovations which were introduced in his time, and carried so far by Masaccio. His example, as regards feeling and expression, influenced many succeeding artists, particularly Pietro Perugino, the master of Raphael (1446—1524), and Francesco Francia of Bologna (1450 or 1453—1517), by both of whom these qualities, united to greatly improved technical power, were brought to high excellence. Giovanni Bellini, the founder of the early Venetian school (1422—1512), has left many admirable works; he had numerous scholars, among them Titian and Giorgione. Domenico Corradi or Ghirlandajo, under whom Michael Angelo studied, successfully followed out that direction given to art by Masaccio, which involved individuality of character and expression in the figures. Andrea Mantegna, of the school of Padua (1430—1506), along with strong expression, gave an impetus to form, modelled on Greek or classic art. Luca Signorelli of Cortona (about 1440—1521), successfully exemplified powerful action and bold foreshortening, particularly in his frescoes at Orvieto, which, with his other works, are supposed to have strongly influenced

the style of Michael Angelo. Antonello da Messina (1447—1496) is said to have been a pupil of Jan Van Eyck, who imparted to him his secret in the preparation and use of oil-colours, the knowledge of which he spread among the Venetians. The above statement, however, as to the exact period at which oil-painting was first introduced, is one attended with much doubt. Painting with colours mixed in oil is mentioned by Italian writers before the period of Van Eyck; painting in tempora, or size, was continued in Italy, particularly in the Florentine and Roman schools, to the time of Raphael; and the transition from the one method to the other has been so gradual, that many judges of art have expressed inability to determine whether the pictures of Perugino, Francia, and Raphael are in oil or tempora, or in both. The practice of painting on canvas, in place of wooden boards or panels, was introduced and carried on for a considerable time in Venice before it was adopted in other parts of Italy, and canvas is the material best suited for pictures in oil-colours when they are not of small dimensions; so, on the whole, the conclusion seems to be, that though oil-painting was not unknown in Florence and the south of Italy, painting in tempora was longer practised there than in Venice. At the time when the painters above referred to flourished, there were many able artists in Germany, whose works are deservedly very highly prized. Among these, Jan Van Eyck (q. v.), (about 1390—1441), deserves special notice. To him is generally given the credit of being the first painter who used oil in place of size in his colours. His works are remarkable for brilliant and transparent colouring and high finish. He had numerous scholars; among these, Justus of Ghent (flor. 1451), Hugo Vander Goes (died 1480)—supposed to be the painter of the celebrated wings of an altar-piece, now at Holyrood Palace, containing portraits of James III. and his queen—Roger of Bruges (1365—1418), Hans Heunling or Memling (died 1489), the best scholar of the Van Eyck school; Quintin Matsys (1450—1529), Jan Van Mabuse (1470—1532), Albert Dürer (q. v.), (1471—1528), Lucas Van Leyden (q. v.), (1494—1533). The career of the two last-named extended to the best period of art, and for many high qualities their works strongly compete with those of the ablest of the Italians; while portraits by Hans Holbein (q. v.), (1497—1554), and Antonio More (1512—1588) rank with those of any school or period. The leading qualities in German art are invention, individuality of character, clearness of colouring, and high finish; but they are inferior to the Italians in embodying beauty; their representation of the nude is angular in form and deficient in the elegance and grace attained by the painters of Italy; and in their draperies they do not attain the simplicity and grandeur so remarkable in the works of their southern competitors.

Anything like an account of the artists by whom painting was carried to its highest pitch, of sufficient comprehensiveness to exhibit their peculiar æsthetic qualities, cannot be attempted in so short a notice as this; but that deficiency is in some degree supplied by, and reference is made to, the biographical notices of distinguished painters given in this work under their names. Keeping this reference in view, therefore, the next step is to note the relative positions generally assigned to the most distinguished painters of that period, with reference to the estimation in which their works are now held. Leonardo da Vinci (q. v.), (1452—1519), Michael Angelo Buonarrotti (1474—1563), and Raphael or Raffaello Sanzio of Urbino (1483—1520), are universally acknowledged as the three greatest among the Italian artists; but two other

names may be added as worthy to be put in an equally high place—those of Titian (q. v.), (1477—1576), and Antonio Allegri, surnamed Correggio (q. v.), (1494—1534). These five painters exhibit in their works, some of them the whole, others the greater portion of the various elements—which in the earlier periods of art had existed apart, and composed distinct styles—united, and more highly developed; while each of them has taken up one of these elements, and carried it not only further than his predecessors had done, but further than it was by his contemporaries, or by any subsequent artist. Thus we see in Leonardo's celebrated picture of the 'Last Supper,' that though he has adopted the traditional style of composition handed down from Giotto's time, and carried out the religious feeling and dignified expression aimed at by the older masters, the whole is deepened and elevated by the manner in which it is worked out—namely, by a mind and hand possessing mastery over all the elements that are combined in the production, of the highest works of art. Michael Angelo was a proficient in all the qualities that constitute a painter, but he carried several of them—viz, grandeur of design, anatomical knowledge, and power of drawing—far beyond all other artists of his own or of later times. Titian and Correggio, again, with great power over every art-element, have each carried one quality further than all other artists—the former, colour; the latter, light and shade. Raphael is generally allowed the first place among painters, for, though each of the four artists just referred to carried one, or perhaps two, of the qualities of painting further than he did, he excelled them in every other element but the one for which each was particularly distinguished, and in several of the highest qualities of art he attained to greater excellence than any other artist; the expression of dignity of movement by broad masses and grand lines aimed at in the works of Masaccio, is successfully realised in the cartoons at Hampton Court; and the pictures in which Perugino and Francia so earnestly and successfully embodied female beauty, maternal affection, and infantine purity, are as much inferior to pictures of similar subjects by Raphael as they are above those executed during the decadence of Italian art. Besides the five leading masters just referred to, there were many other Italian artists of great talent, who may be ranged in three classes: 1, the contemporaries of those artists; 2, those influenced by their style; 3, their scholars. Among their contemporaries, the works of Fra Bartolommeo (1469—1517) and Andrea Vanucchi, called Andrea del Sarto (1488—1530), both Florentines, deservedly rank very high. Giorgio Barbarelli, called Giorgione (1478—1511), was, under Bellini, a fellow-pupil of, and is generally styled the rival of Titian; and his works, which are of great excellence, prove that he was worthy of that name. In class 2, Correggio himself may rank as being influenced by Leonardo's style, but the great prominence of his other qualities makes his style original and independent. On Bernardino Luini (about 1460, living in 1530), Leonardo's influence is direct; and as he was an able painter, his pictures are very valuable for embodying many of those qualities in art which Leonardo had so much improved. Sebastiano del Piombo, a Venetian (1485—1547), studied under Giovanni Bellini and Giorgione; and after settling in Rome, became intimate with Michael Angelo, who employed him to paint some of his designs, with a view of benefiting by his admirable colouring. His pictures are greatly esteemed, as uniting rich colour to grandeur of design. Class 3. All the five leading artists above referred to had pupils or scholars, particu-

larly such of them as, like Raphael, were much engaged in extensive works in fresco, in the execution of which assistants are generally employed. A complete list of these, however, would occupy too much space here. Among the scholars of Michael Angelo, Daniele da Volterra (1509—1566) was the best; and among Raphael's scholars, the first place is generally accorded to Giulio Pippi or Romano (q. v.), (1492—1546). After the first quarter of the 16th c., painting in Italy, except in the Venetian school, shewed symptoms of rapid decline; that school, however, continued its vitality longer than any other in Italy, having flourished with all the life of originality during the whole 16th century. This is attested by the productions of many able Venetian painters; but among those, the works of Jacopo Robusti, or Tintoretto (q. v.), (1512—1594), and Paolo Caliari, or Veronese (q. v.), (1528—1588), are by far the most important. The pictures of the former exhibit great vigour in composition, and much richness of colour—the former quality evincing the influence of Michael Angelo; the latter, that of Titian. Veronese ranks before even Tintoretto: his compositions are animated and full, and as a colourist he is a powerful rival to Titian, not aiming at the rich glow of that master's tints, but excelling every artist in producing the brilliancy and sparkling effect of mid-daylight on figures gorgeously attired, and seen against backgrounds enriched with landscape and architecture. The other great schools of Italy, however, as already said, had less vitality than the Venetian, and shewed symptoms of decay at the end of the first quarter of the 16th century. Raphael left numerous scholars and assistants; many of these, after his death in 1520, quitted Rome. The pillage of that city by the French under Bourbon in 1527 had also the effect of dispersing them, and this naturally led to the style of Raphael, so far as they could acquire it, being transplanted into other parts of Italy; but Raphael's style was founded on his own peculiar feeling for the beautiful, and on his own peculiar grace; and all that his scholars had acquired or could convey was a mere imitation of his external forms, without the spirit and pure feeling of which these forms are the expression. The imitation of Michael Angelo became the great object with the Florentines; but his scholars and imitators being unable to comprehend his powerful spirit, and not possessing his technical powers and theoretical knowledge, their pictures are merely exaggerated compositions of academic figures. Nor were Correggio's scholars more successful in following his walk, for they exaggerated the peculiarities of his style, which in their hands became affected and insipid. Leonardo's scholars repeated his distinguishing qualities, modified by their own individual peculiarities, and avoided that academic ostentation displayed by the followers of the masters just named. Their reputation therefore stands higher.

The German painters who succeeded Dürer, Van Leyden, and the other celebrated artists of their period, before referred to, endeavoured to improve their national style by the study of Italian art, at first attempting to combine the two styles, and afterwards, to the close of the 16th c., devoting themselves exclusively to the study or imitation of the Italian painters. The works of these artists, the worst productions of any school, form a connecting link between those of the famous old German masters and the vigorous, varied, and attractive works of the painters of the Netherlands in the 17th century.

Towards the end of the 16th, and during the first half of the 17th c., a revival of art in Italy was attempted. This was sought for in two ways by two classes of artists; the larger body were known

by the name of Eclectics, from their having endeavoured to select and unite the best qualities of each of the great masters, combined with the study of nature; the other class were distinguished by the name of Naturalisti, and they aimed at forming an independent style, distinct from that of the earlier masters, based on the indiscriminate imitation of common life, treated in a bold and lively manner. In their development, both classes exercised an influence on each other, particularly the Naturalisti on the Eclectics. Eclectic schools arose in various parts of Italy, but the most celebrated was that at Bologna, founded by Lodovico Carracci (q. v.), (1555—1619), assisted by his two nephews, Agostino Carracci (1558—1602), and Annibale Carracci (1560—1609) the most eminent of the three. Many painters of mark were reared in this school; among those, Domenico Zampieri, called Domenichino (q. v.), (1581—1641), and Guido Reni (q. v.), (1575—1642), were by far the most eminent. The art of the Eclectics has been greatly overrated. Till recently, the leaders of that school were always placed on an equality with the best masters of the early part of the 16th c., and far above any of the painters of the 15th century. These notions have recently undergone a complete change; it is now acknowledged that the attempt of the Eclectics to combine the excellences of various great masters, involves misapprehension with regard to the conception and practice of art, for the greatness of the earlier masters was brought out in their individual and peculiar qualities, the uniting of which implies a contradiction. Michael Angelo Amerighi da Caravaggio (q. v.), (1569—1609) was the founder of the Naturalisti school; he resided principally at Rome, but at a later period went to Naples, Malta, and Sicily. The Naturalisti were in their greatest strength at Naples, where they perseveringly opposed the followers of the Carracci, their leader being Giuseppe Ribera, a Spaniard, hence called Spagnoletto (q. v.), (1593—1656). With much of the force of Caravaggio, he united more delicacy and greater vivacity of colour. The historical or Scriptural subjects of Salvator Rosa (q. v.), (1615—1673) are in the style of the school of the Naturalisti; but on account of his *genre* pieces and landscapes, Salvator is entitled to occupy the place of the originator of a style noted for certain qualities of poetic feeling. The influence of the school of the Naturalisti had more important results than that of the Eclectics, for it affected to some extent the leading masters of the Spanish school. At Rome, contemporaneously with Domenichino, Guido, and other leading masters of the schools of the Eclectics and Naturalisti, the three following artists elevated landscape-painting to a high position—Nicholas Poussin (q. v.), a Frenchman (1594—1665); Claude Gellée, also a native of France (1600—1682), called Claude Lorraine (q. v.); and Gaspre Duchet, named Gaspar Poussin (q. v.), born in Rome, but the son of a Frenchman (1613—1675). Among the great masters who occasionally practised landscape-painting as a distinct branch of art, the earliest were Titian and Giorgione; the Carracci (particularly Annibale) carried out their style with considerable success; the landscapes of Domenichino are esteemed, and other scholars of the Carracci turned their attention in that direction. The reputation of N. Poussin is principally based on his figure-pictures, the subjects of which were mythological and Scriptural. Into these pictures, he endeavoured, with considerable success, to infuse the classical style; but his compositions were generally arranged with a large space of landscape background, which was in many cases not the least important portion of the picture; and these, and the pictures he painted falling strictly

under the class of landscapes, are distinguished for largeness of style and poetic feeling. Claude and Gaspar directed all their efforts to landscape, and attained to high eminence in that department of art.

The earlier specimens of painting in Spain resemble in style the works of the old German painters, who seem to have disposed of many of their pictures in that country, while Spanish art of the 16th c. was modelled on that of Italy, Titian and Raphael being the masters studied; but when works of the Spanish school are spoken of, those executed in the 17th c. are always understood to be referred to, as it was then that Spanish art became entirely national in feeling and style, and that is the period in which the best works of the school were produced. The two most distinguished Spanish painters are Don Diego Velasquez (q. v.), (1599—1660), and Bartholomé Esteban Murillo (q. v.), (1618—1682). The portraits of the former are characterised by truthful and dignified expression, great breadth and vigorous handling, and rank with the best works of that class of any school; while the Scripture subjects of the latter, which are noted for tender expression, rich colour, and powerful light and shade, may be classed with similar works by Rubens and Van Dyck. Spagnoletto, a Spanish painter, has already been referred to as a leading artist of the school of the Naturalisti at Naples. Alonzo Cano (1601—1667), Francisco Zurbaran (1598—1662), and Claudio Coello (born between 1630 and 1640—1693), have a high reputation. No name of a Spanish painter of eminence occurs after the close of the 17th century.

Very soon after the period when the Eclectic and Naturalisti schools arose in Italy, a revival of art also occurred in the Netherlands. This was very different in its effects from the revival in Italy, the only results from which were academical imitation of the older masters, and coarse naturalism, either separately or combined in varied proportions; while the works of the artists of the Netherlands executed about the same period, though they do not exhibit the high qualities found in the compositions of the Italian masters of the best period, possess many new and attractive features—freedom, originality of treatment, attention to the peculiar character of individual life, and the daily intercourse of men with each other in all its variety, and the study of nature, brought out with truth and delicacy of execution. Two important schools of art were established by this movement—the Flemish and the Dutch. The Flemish school flourished in Brabant, where the Roman Catholic faith—then making strenuous efforts to oppose the Reformed religion—still retained and actively employed art in its service. The Dutch school flourished in Protestant and republican Holland, where the artist, having to trust to private encouragement, painted, for the most part, familiar subjects from everyday life; and in place of altar-pieces for churches, produced the subjects then in demand—viz., large historical and allegorical pictures for palaces, portraits, genre pictures, or works in which life and manners are depicted in various phases—landscapes with and without figures, sea-pieces, battle-pieces, compositions representing hunting, animals, game, &c. The catalogue of the names of the able artists of these two schools is long; in the Flemish school, those who stand highest are Peter Paul Rubens (q. v.), (1577—1640), Anthony Van Dyck (q. v.), (1599—1641), David Teniers (q. v.) the Younger (1610—1690), F. Snyders (1579—1657). The following are the most eminent in the long list of artists of the Dutch school: Rembrandt (q. v.), (1608—1669), Vanderhelst (1613—1670), Albert Cuyt (q. v.), (1605—1691), Terburgh (1608—16e1), A. V. Ostade

## PAINTING.

(1610—1685), J. Ruisdaal (q. v.), (1630 or 1636—1681), Hobbima (1629—1670), P. Potter (1625—1654), K. du Jarden (1635—1678), Jan Steen (q. v.), (1636—1689), G. Metz (1615—1658), F. Mieris (1635—1681), W. Van de Velde (q. v.), (1633—1707), A. Van der Neer (1613—1684), P. Wouwermans (q. v.), (1620—1668).

Painting has been practised for a very long period in France; but there, as in Spain and in Britain, the marked preference shown in early times by the sovereigns of the country for the works of foreign artists, their undervaluing native talent, and their directing it into a channel supplied from a foreign source, had the effect of neutralising it as the exponent of national feeling. Francis I. is acknowledged to have been a patron of art; he had a desire to possess fine works, and he liberally rewarded able artists, but his patronage was almost entirely confined to foreigners. Louis XIV. did what he could to place French art above that of every other nation; but he had no knowledge of it himself; he did not comprehend its nature and true intention, and imagined that pictures if painted by Frenchmen must necessarily be national. Nevertheless, his influence was, on the whole, highly beneficial to French national art. He always shewed himself desirous to employ native rather than foreign talent, and he encouraged and enlarged the Academy of Fine Arts, which had been founded at the commencement of his reign, under the direction of Lebrun. Although in many respects the principles and the regulations of the Academy tended rather to the perpetuation of the debased Italian, than to the development of genuine French art; yet the bringing together of a body of influential French artists, was the measure most likely to foster the feeling of nationality and to lead to the foundation of a national school of art. In the 16th c., François Clouet was distinguished as a portrait-painter; and Jean Cousin as a painter, sculptor, and architect. In the 17th c., among many names, those chiefly deserving notice are Simon Vouet, the brothers Le Nain, N. Poussin, Claude Lorraine, Mignard, S. Bourlon, Le Sueur, J. Courtois (called Borgognone), and Coypel. Among these, the works of the brothers Le Nain alone possess national feeling and character, and they are held in very considerable estimation; those of the others were executed under the influence of foreign art; and excepting Claude's splendid landscapes, Poussin's learned compositions, and some of Borgognone's battle-pieces, hold a low position. The works of Anthony Watteau (1684—1721) are truly national, excellent in execution, and very highly valued. This artist may be classed as at the head of the school of the 18th c.—the period in which art in France became really national. Not only did most of the painters of his school—which lasted till the end of the century, when classic art ruled for a time—form their style upon the works of Watteau, but his influence also affected the British school, which arose soon after that of France was developed. Lancret (1690—1742) was the most successful imitator of Watteau; Pater (1696—1736) followed in the same course; Chardin (1699—1779), though influenced by him, had an original style of his own, and his works now stand high. The pictures of Boucher (1704—1770) exhibit the defects of the French school of the 18th c., unredeemed by the delicacy and grace, and high technical execution and truth of Watteau, Chardin, and Greuze (1725—1805), the last of whom sustained the character of French national art, and carried it into the 19th c., when it was re-established, after the classic school of David, founded at the Revolution, and patronised under the empire of the first Napoleon, had in its turn been

laid aside. David (q. v.), (1748—1825), the leader of this school, carried his admiration of classic art to the length of substituting the study of statues, the works by which the art of the ancients is chiefly known, for that of nature. He had numerous able pupils, several of whom, tired with this constant repetition of conventional form, recurred to nature, extended their range of subjects, and infused new vigour into the French school. Among many distinguished French artists, the following names may be mentioned: Géricault, Prud'hon, Leopold Robert, Delaroche (q. v.), Horace Vernet (q. v.), Ary Scheffer (q. v.), and Eugène Delacroix (q. v.), all lately deceased, and Ingres (q. v.), their distinguished contemporary, still living. A number of artists, chiefly pupils of those above mentioned, now sustain the high position of the French school in every department of art; while in that of landscape illustrative of French scenery, a branch of art never much studied in past times, great progress has been made, and the rise of this flourishing branch of French art is acknowledged by the French themselves to be due to the works of the English painter Constable, exhibited in Paris in 1824.

The English school was the latest national school that arose in Europe, for although the modern schools of Germany and Belgium are of still later date, having arisen in the present century, still they can scarcely be classed as new schools, but rather as revivals of former national schools. In England, as in France, foreign artists chiefly were in early times employed by the court and the nobles. Henry VIII. competed with Francis I. for the services of the greatest of the Italian artists, and permanently secured those of Hans Holbein, one of the most distinguished of those of Germany. Charles I. liberally patronised Rubens and Van Dyck; and if he had reigned longer, would in all probability, like Louis XIV., have founded a national school. But referring to the separate notices in this work of the foreign artists under their names respectively who were employed in this country, and to the article **MINIATURE PAINTING** for notice of several eminent native artists in that branch of art, it is only necessary here to touch on the subject of painting in this country from the time it acquired a truly national character. At the beginning of the 18th c., art in Britain was at the lowest ebb; the career of Sir Godfrey Kneller (q. v.), (1648—1725 or 1726), the last of the foreigners, was drawing to a close; Sir James Thornhill (1676—1734), an Englishman, followed out the decorative kind of art on which Verrio, La Guerre, and others were so much employed; but after his death, that debased style finally went down. The time had now arrived for native artists, if there were any entitled to the name, to assert their independence; and accordingly, in 1734—1735, as many as from thirty to forty artists combined together in London, and instituted an academy for studying the human figure. About the same time a similar movement was going on in Edinburgh; the contract or indenture for establishing a school of art, dated 18th October 1729, and signed by seventeen artists, besides amateurs, is in the possession of the Royal Scottish Academy. The effort above referred to, of artists combining to found a Life Academy, was mainly due to William Hogarth (1697—1764), who, on this account, and from his first having developed, in a very high degree of excellence in his works, the leading characteristics of the English school, is justly entitled to be considered its founder. This combination led to these important results—it shewed the artists their strength, and enabled them, after a probation of thirty-four years, to found the Royal Academy, an institution managed by artists,

## PAINTING.

and intended to support and encourage a national school of art. The means by which the Royal Academy proposed to attain its purpose were the following: 1, by founding a school where artists may learn their profession; and 2, by instituting an exhibition where, independently of private patronage and support, artists may bring their works directly before the public. Hogarth died four years before the Royal Academy was organised; but he powerfully contributed to its establishment by his exertions in bringing the artists together in 1734, by supporting the modern exhibitions at Spring Gardens, and by ridiculing by his pencil and pen the passion of the cognoscenti of the day for crying up as superior to the modern the doubtful specimens of old art which were largely imported and disposed of at great prices in numerous salerooms established for the purpose in London. As regards technical execution, and indeed in style generally, the English artists were at first indebted to the French school, which, in the commencement of the 18th c., was in great vigour. Hogarth himself, in these respects, looked closely at the works of Watteau, engravings from which were well known in this country in his time; indeed, Watteau's pictures were so greatly admired here that he came over and spent the year 1720 painting in London. But Hogarth, though alive to the qualities in art produced by others, ranks among painters as one of the most original, for he greatly extended the dramatic element in painting, and imparted an originality and vigour to it never before attained; and his example has led to that element being one of the leading features of the English school, as is exemplified in the works of Wilkie (q. v.), Leslie (q. v.), Stuart Newton, Bonington, and others; and those of many distinguished artists of the present day. In the department of portrait-painting, many of the works of the British school rank with those of Titian, Van Dyck, and Velasquez, such, for instance, as Reynolds's portraits of Nelly O'Brien and Lady Hamilton, Gainsborough's Mrs Graham and Mrs Siddons, and some of Raeburn's heads, &c. While in that of landscape, the position of the English school is acknowledged to be very high, its influence now strongly affecting the French school—this is proved by the works of R. Wilson, Gainsborough (q. v.), and Turner (q. v.), the last of whom, for wide range of subject, and rendering of atmospheric effect, stands alone; Constable, whose powerful grasp of nature has excited the emulation of the French artists; Calcott (q. v.), Collins (q. v.), Nasmyth, J. Thomson, Muller, and others; and their successors, the artists of the day, who ably represent the English school. Animal-painting has also been elevated to a high position. And an important department, that of painting in water-colours, originated in England, and has there attained far higher excellence than in any other country.

Painting is cultivated with success and receives much encouragement in America, but there the features that mark a national school have not yet had time for development. From the close connection between Britain and America, the art of the latter country was naturally influenced by and became assimilated to that of the former. America may, however, justly take credit for having contributed in no small degree to strengthen the British school of art, as several very able members of the Royal Academy were Americans. Benjamin West (1738—1820) was one of the original members, and elected President of the Royal Academy in 1806. J. S. Copley (1737—1815), elected R.A. in 1799; his 'Death of Chatham,' and 'Defence of St Heliers, Jersey, against the French, and Death of Major

Pierson at the moment of Victory,' are excellent works, and as such were conserved in the National Gallery, London. C. R. Leslie (1794—1859) was born in London of American parents; but in 1799, went to Philadelphia, where he was educated. Returning to London in 1811, he entered the schools of the Royal Academy; was elected academician in 1826, and professor of painting in 1848. G. S. Newton (1794—1835)—he was admitted a student of the Royal Academy in 1821, and elected academician in 1832. Washington Allston (1780—1843) was elected an associate in 1818; but afterwards returned to America, where he died. With the exception of the last named, the feeling evinced in the works of all these artists, influenced by study and continued residence, was essentially English; indeed few have equalled Leslie and Newton in their power of embodying the various incidents made national by English poets; and in none of their works can anything be set down as contributing in any degree to the foundation of a national American school. There is every reason to think, however, that such a school is being gradually evolved, and will soon be developed. Already something like originality of a national kind is exhibited in landscape painting, in which some American artists are endeavouring to embody scenes embracing a vast extent of country, or of extraordinary magnitude—such as those met with in the Andes, at Niagara, or exhibited by floating icebergs; and American literature, having now assumed imposing proportions, and great historical events being now in rapid progress, illustrations of American poetry and pictures of stirring national events will be called forth; and able American artists will doubtless be found to embody them and create a school truly national.

A general survey of painting at the present time exhibits the following aspect and arrangement: 1. A school in Germany, which arose during the present century, ostensibly a revival of the old national, but truly modelled on the early Italian school, the religious element being prominent. Its principal works are mural, of large dimension, and mostly executed in fresco, or on a kind of fresco lately invented, called silica or water-glass painting, from a vehicle of that kind being used. Invention, composition, grouping, and powerful and correct drawing, characterise the modern German works; but being of necessity executed from cartoons, they are deficient in that amount of individual expression, and natural colour and effect, that can only be attained by a direct and continued reference to the object represented. 2. A Belgian school, which arose in the present century, and is also a revival of the earlier national schools. Some of the Belgian artists lean to the manner of the very early Flemish school, others to that of which Rubens was the head. The greater portion of the Belgian works are easel-pictures, and many of them rank high for individual expression, colour, and technical execution. 3. A French school, exhibiting in active operation the various styles that have at different periods prevailed in that country, sometimes modified or adapted to the taste and feeling of the times. The works of the French school of the eighteenth century were utterly condemned by French artists at the close of that and commencement of the present century. They would tolerate nothing but what they called classic art. *L'École classique*, as it was styled, was in its turn supplanted by *l'École romantique*. Now, however, all styles are tolerated, even those of foreign schools—for instance, the English school of landscape—and there can be no doubt that, by the extensive range of subject, invention, drawing, and other high qualities the

## PAINTING.

French artists display in their works, they have now raised that school to a very high position. 4. A British school, which has been in existence as a national school nearly as long as that of France, undisturbed by the convulsions that affected it. Vitality in art is maintained by close reference to nature, and this has all along been the leading characteristic of the English school; while the tendency of the artists at present is, taking advantage of the aid of science, which has lately discovered photography, to study nature with still greater earnestness and care. The high claims of the British school, long denied abroad, are now fully admitted. Formerly, foreigners never classed a British school among those of Europe, but now this is invariably done. One of the most popular writers on art in France, Théophile Gautier, in his work, *Les Beaux-Arts en Europe*, divides the art of the world into four strongly defined zones—viz., Great Britain, Belgium, Germany, and France—Britain being distinguished by 'individuality,' a potent element in art; Belgium, by 'skill;' Germany, by 'ideality;' and France, by 'eclecticism,' or a selection and combination of the qualities of all other schools.

Regarding technical modes or processes of painting, reference is made to the separate notices under FRESCO, ENCAUSTIC, MINIATURE PAINTING. The period when the method of mixing up colours with oil was introduced, and the artists to whom the invention is attributed, have been already alluded to. It is necessary, however, to enter on some details touching the mechanical processes in oil-painting, the branch of the art that occupies the most prominent position; and the practice of cleaning and restoring pictures.

The implements used by a painter in oil are charcoal, chalk, or lead pencils, for drawing the outline; hair-pencils or brushes of various sizes, made of hog's bristles or finer hair, such as sable; a knife or spatula to mix the colours, and a palette or small table of thin wood, to be held in the left hand, on which the colours and tints are placed and mixed; an easel or stand for supporting the picture is also required, and a light rod for steadying or resting the hand on. Large pictures are always executed on canvas, stretched tightly on a frame, and primed or coated with paint. Small pictures are often painted on boards or panels, generally of hard wood, such as oak or mahogany, and similarly primed or prepared; but canvas, even for small works, seems at present to be generally preferred. Panels are apt to twist, or warp, or split, and in the event of the surface of a picture chipping or breaking off from the ground, the damage can be more easily remedied, and its progress stopped, when the picture is on canvas, by re-lining. The colour of the ground of the canvas or panel has been the subject of much diversity of opinion among artists in different countries and at various periods; and it is certainly a matter of great importance, as it affects the general colour of the work, or makes it necessary for the artist to adopt a peculiar style of working. The colour of the ground used by the early masters was white, or nearly pure white. This arose from tempera or size being the medium first used in painting, and a pure white ground prepared with size was necessary for that kind of work. This practice, except as regards the Venetian school, continued till the decline of Italian art. Dull red was the universal colour adopted in the eclectic, Naturalist, and late Italian schools, and this is one of the causes of the works of these schools being characterised by blackness and heaviness; at the same time, it is certain that red grounds were also used by many of the best Venetian painters, in whose works these defects are

never found, probably from having used an *impasto* or body of colour sufficiently powerful to bear on on the ground. A dark ground affords a facility for working expeditiously, and that, probably, was the principal cause for its being adopted. The Dutch and Flemish painters generally used light grounds; some of them light-brown, nearly the colour of oak. Van Dyck occasionally used gray, and sometimes, when he painted in Italy, dull-red grounds. In the British school, light grounds are preferred. Some artists use smooth canvas, others prefer it rough, and avail themselves of the texture to increase the richness of the surface of their work. All these varieties in the materials are called for in consequence of the numerous styles or modes adopted by painters in oil colours. Every artist has his peculiar way of working, and in bringing out the colour or effect, or special quality in his picture, by which the feeling or idea of the subject he conceives is expressed. No two artists—imitators and copiers are not referred to—produce their tints by mixing colours in the same proportions, nor, indeed, by using the same colours; and it is difficult to lay down general rules for the execution of works, seeing that depends very much on individual feeling and appreciation. The design or drawing is first outlined on the canvas, if it is light, with charcoal, or with white chalk when it is dark, and these lines are easily dusted off or rubbed out when corrections are made. It is then put in with black chalk or a lead pencil. Not many years ago it was the practice of painters, particularly landscape-painters—Naumy, for instance—to rub in the design with some brown colour, such as a tint composed of burned sienna and black; but this practice is not much adopted now. Some artists make but a slight outline, and paint—or, as it is called technically rub—in the subject in a bold, rough manner, afterwards gradually finishing it up; others draw the design very carefully, and work the picture up in portions, finishing or nearly finishing one portion before commencing another. In arranging the colours, or as it is called, setting the palette, many artists use a great variety of colours, others produce rich tones with few colours; some mix up tints in various gradations, others place the colours on the palette, commencing at the outer edge with white, followed by yellows and burned sienna (a reddish brown), then reds, including lakes, such as pink, madder, next blue, and lastly black, and merely mix up the tint on the centre of the palette with their brush, as they proceed. In laying the colours on the canvas, the painter with his brush mixes or dilutes them with what is called a vehicle or medium. Here, again, the practice of artists is very varied; and this is a matter of importance, as the tone and quality of the picture, as regards texture or surface and transparency, is much affected by the medium employed, and the manner of using it. The durability of the work also depends very much on the medium and the artist's management of it. A medium composed of mastic varnish and drying or boiled linseed oil, named *magilp*, is that most generally used. This mixture coagulates or forms a jelly, and has the advantage, when placed on the palette, of not running off it, or mixing with the colours when the palette is not held level. Some painters prefer using raw linseed oil mixed with a dryer, such as litharge, or drying oil mixed with turpentine, or copal varnish and turpentine, or copal varnish and oil, with mastic varnish added, to make it coagulate. Other ingredients are often mixed with the medium, to give a thick consistency to the paint, such as fat or thickened nut oil, paste, &c.; and various preparations sold by artists' colourmen are much used; for instance, Roberson's medium,

and Siccatif de Harlem, a preparation imported from Paris. The mode of using the medium is of great consequence; some apply it very sparingly, others, particularly those who prefer maglip, or a medium that coagulates, employ it lavishly. By the first method, firmness and decision of touch may be exhibited, by the latter, richness and brilliancy of tone; the excess tends to produce, in the one case, a hard and dry surface, and the want of the protection that varnish mixed with the colour gives against atmospheric action; the other induces a surface having a horny appearance, and a tendency to darken, or crack, or open up.

Arresting the decay of pictures, and repairing, or, as it is styled, restoring them, after they have suffered from age or bad usage are matters which engage much attention. There can be no doubt that many paintings of vast importance have been saved by the care and skill of those who have earnestly devoted themselves to that kind of work; but picture-cleaning is now a trade followed in numerous instances by ignorant pretenders and quacks, who hold out that they possess some means by which they can freshen a picture, and restore it to the state it was in when originally executed. Generally speaking, the great extent to which this business is carried on is owing to the credulity of those who dabble in collecting old pictures, one great incentive to which being the hope of picking up, or discovering, some picture of great value concealed under the dirt and discoloration acquired in a long course of years; but, nevertheless, there can be no doubt that many proprietors of works of art who collect from far higher motives, are remarkably prone to call in the picture-cleaner when his services are anything but necessary or beneficial. Sir Edwin Landseer, R.A., when examined by the Select Committee of the House of Commons appointed to inquire into certain allegations of damage by cleaning, sustained by the pictures in the National Gallery of London (Report and Evidence ordered to be printed, 1858), states, in the following terms, his idea of this rage for picture-cleaning, or rather picture-destroying: 'The first thing, whenever a picture is sold, I think, is, that it goes to a picture-restorer, or a picture-liner, or a picture-cleaner, no matter what its condition is. It is exactly the same thing as when you buy a horse; your groom says he will be all right when he has a dose of physic through him, whether he wants it or not.' The mania for picture-cleaning is not confined to this country; it is extensively carried on with even more ruinous consequences abroad, particularly in Italy, where there is a large traffic in old, and few commissions for modern works, and where in many of the public galleries one or more picture-cleaners, for whom work must be found, are attached as permanent officers.

The process of picture-cleaning, or the removal of the old varnishes or other incrustations by which a painting may be obscured, is effected either by mechanical or chemical means. The first method is accomplished when the varnish on the surface is mastic, by rubbing with the fingers the surface of varnish when in a dry state, by which action it is brought off in a fine white powder; or by scraping or erasing the surface with sharp steel instruments when the surface of the picture is tolerably smooth. The first of these processes is the best that can be employed; but when the surface is rough or unequal, the prominent portions are apt to be over-rubbed; erasing or scraping is often practised in Italy, but rarely in this country. The chemical means consist in the application of solvents, chiefly alkali, or alcohol, to dissolve the old varnish. The danger here is, that the action of these solvents is

not always stopped with sufficient promptness and dexterity, and part of the surface of the picture is taken off; consequently it is by this latter process that most destruction is caused. For the various methods employed in picture-cleaning, the Report and Minutes of Evidence, already referred to, may be consulted, and the *Guide Théorique et Pratique de l'Amateur de Tableaux*, par Théodore Lejeune (Paris, 1864), in which are stated all the most approved methods of cleaning and restoring pictures.

Works on painting and painters: Vasari (Florence, 1568); Borghini (Florence, 1584); Rodolphi (Venice, 1648); Zanetti (Venice, 1771); Lanzi (1792), Bohn's edition of Roscoe's translation; Von Rumohr (Berlin, 1827); Kugler's *Hand-book of Painting, Italian Schools of Painting*, edited by Eastlake (1855); *German, Flemish, and Dutch Schools*, by the same, edited by Sir Edmund Head, Bart. (1846); *Hand-book to Spanish Schools and French Schools* (1848); *Hand-book for Young Painters*, by C. R. Lealie, R.A. (1855).

PAINTING (HOUSE), is one of the useful arts, combining much that is artistic with much that is absolutely necessary. The primary object of painting houses, or parts of them, either internally or externally, is to preserve them from decay—to cover the parts liable to suffer from exposure with a durable composition. That now used is made of ground white-lead mixed with linseed oil. This produces white paint, which forms the basis of all others. The various colours given to it are produced by the grinding of pigments (or *stainers*) along with the white-lead. The commonest of these are ochres (yellow and red earths), lampblack, Venetian red, umber, Prussian blue, chrome, vermilion, &c. Substances called driers are also mixed with the paint, such as spirits of turpentine, boiled oil, litharge and sugar of lead ground in oil. Paint may be laid on any material—stone, wood, iron, and plaster being the most usual in buildings. It has the effect of preserving these, by filling up the pores in them, and forming a coating on which the moisture of the atmosphere does not act. The paint is laid on in several coats or layers, each being allowed to dry before the next is applied. The usual number of coats for new wood or plaster varies from three to six. Five coats form a good and lasting protection from the weather. Plain painting is generally finished with a coat prepared with a mixture of oil of turpentine, which takes off the gloss from the paint, and leaves the surface quite *mat* or dead. This is called *flattening*. A very common form of decoration in all ages has been to imitate the veins or colours of marbles, and the *grains* or marks of growth of various woods. In modern times, these arts form a separate branch of house-painting, some men being *grainers*, others *marblers*, &c. The mode in which these imitations are produced is by forming a *grounding* of several coats of plain paint—usually four—and applying the colouring coat over this. In marbling, the colouring matter is marked and veined with *feathers*, in place of brushes; and in graining, steel combs are used. When the surface is dry, it is protected with one or more coats of copal varnish.

Besides painting, the decorator uses paper-hangings for adorning the walls of houses. These are applied to the walls with paste. Size-colouring is also used; the colouring matter in this case being mixed with strong Size (q. v.) in place of oil; but this has the disadvantage of being easily acted on by moisture. It is often used for the ceilings of common rooms, and for the walls of kitchens and servants' apartments, being much cheaper than oil-paint. In ancient times, in Greece and Rome, wax was used for mixing the colours with; but although

there are many very fine specimens of Roman paintings still preserved on the walls of the houses of Pompeii, the mode in which these decorations were applied is not now known.

**PAINTS, PAINTERS' COLOURS, or PIGMENTS.** These names are applied to the prepared or unprepared compositions by which wood, stone, and other materials are coated with a preservative surface of oil, mixed with an earthy matter, to give it colour and consistency; also to the materials used by artists to produce the coloured surfaces of their pictures. The art of painting, in its primitive state, consisted merely in applying such natural, mineral, and vegetable colours as were spontaneously yielded, without any vehicle to render them permanent; consequently, they had to be renewed as often as they were rubbed or washed off from the surfaces to which they were applied. The paints now in use are nearly all mixed with a liquid vehicle, and are applied in the liquid state. The mixing materials are varied according to the requirements of the work. Thus, for some kinds of decorative work, and for water-colour drawings, gum, glue, size, or other adhesive materials dissolved in water, are employed; whilst for the painting of buildings, &c., and for oil-paintings, oils of various kinds are used for mixing and thinning the colours. Thus, for painted work exposed to the weather, it is found that linseed oil boiled with the sulphates of lead (litharge) or zinc, or with acetate of lead (sugar of lead), is the best. The preparation of boiled oil is one requiring particular care, as it is desirable to have it bright and clear. Hence the proportions of the metallic salts are much varied by different manufacturers, and by some various other ingredients are added. The time of boiling, and the method of filtering, are also much varied. For indoor work, plain linseed oil and oil (spirit) of turpentine are used; if a *glossy surface* is wished, the linseed oil must be in excess; if a *dull or flattened surface*, then the quantity of turpentine, or *turps*, as it is often technically called, must be increased; and it is usual to add a small quantity of ground litharge and sugar of lead, which are prepared for this purpose, and sold under the name of *Driers*. For artists' colours, very fine linseed or nut oil is used, unboiled, and in small quantity, and turpentine is employed to dilute them. Paints for very rough purposes, such as ship-work, stone walls, &c., are often mixed with whale oil boiled with white vitriol (acetate of zinc), litharge, and vinegar, and they are diluted with common linseed oil and turpentine.

Most of the paints used for ordinary purposes are composed first of the colouring matter, then of a quantity of white-lead, with which and the oil they are worked into a paste of the shade required, and afterwards thinned down with oil and turpentine when used. The white-lead which thus forms the basis of most paints, and by itself a colour, is a carbonate and oxide of the metal, produced by exposing pieces of lead to the action of the steam of acetic acid in beds of fermenting tan. It is the principal white paint used, but is liable to discoloration from the gases contained in impure atmospheres. Other white pigments are prepared from the oxide of zinc, and the carbonate and sulphate of barytes. Pale yellow is made with chromate of strontian, orange-yellow with sulphuret of cadmium, whilst several varieties of this colour are produced by chromate of lead, sulphuret of arsenic, or king's yellow, and various native earths in which silica and alumina are combined with oxide of iron. Amongst these are Yellow Ochre, Oxford, Roman, Stone, Orange, Indian, and American Ochres. *Reds* are either purely mineral, or they are

*lakes*, i. e., organic colours precipitated on alumina bases. Of the latter, there are madder-lakes, prepared from madder-roots, and carmine-lakes, prepared from cochineal; of the former, vermilion (bisulphuret of mercury), Indian red (a native oxide of iron), Venetian red (also an oxide of iron), red lead (red oxide of lead or *minium*). A very beautiful red is used by artists called palladium red; it is formed of ammonio-perchloride of palladium. *Blues* consist of the artificial ultramarine, and for artists' purposes, of the real ultramarine, also the silicate of cobalt, and for water-colours, indigo and Prussian blue. *Greens* are either produced by mixtures of *yellows* and *blues*, or they are made directly from the phosphates, carbonates, acetates, and arsenites of copper, also from the sesquioxide of chromium and from *terre verte*, a native mineral, consisting of iron, silica, potassa, and magnesia. The last two are the best for artists. *Browns* are numerous, and various in their composition. Decomposed peat, burned madder, burned Prussian blue, burned *terre verte*, asphalt, manganese brown, catechu, umber (which is an oxide of iron with manganese), and mummy, or the asphalt mixed with other matters taken from Egyptian mummies, are amongst the best known and most used. *Blacks* are made of Lamp-black and Bone-black (q. v.), peroxide of manganese, and blue-black, which is made of the charcoal of burned vine twigs.

In all cases, the colouring materials of paints require to be very finely ground, and as many are very poisonous, great care is required in their preparation, and several forms of mill have been invented for the purpose. The principle upon which all are made is to secure the operator from the poisonous dust and exhalations, and to reduce the colouring material, if ground dry, to an impalpable powder, or if mixed with the oil, to a perfectly smooth paste.

**PAISIELLO, GIOVANNI**, an eminent musician, son of a veterinary surgeon at Taranto, was born in 1741, and received his musical education in the Conservatorio St Onofrio at Naples. Of his earlier operas produced at Naples, the most celebrated was *Dal Finto al Vero*, composed in 1777. Some of his best works, particularly *Il Barbiere de Seviglia*, were written during an eight years' residence at St Petersburg. At Vienna, he composed twelve symphonies for a large orchestra, and the opera buffa, *Il re Teodoro*. Between 1785 and 1799, he produced a number of operas for the Neapolitan theatre, and was appointed by Ferdinand IV. his *maestro di capella*. In consequence of having accepted under the revolutionary government the office of national director of music, he was suspended from his functions for two years after the restoration of royalty, but eventually restored to them. In 1802, he went to Paris to direct the music of the consular chapel; but the indifferent reception shortly after given to his opera of *Proserpine*, led him to return to Naples, where he died in 1816. His compositions are characterised by sweetness and gracefulness of melody, and simplicity of structure. Besides no fewer than ninety operas, P. composed masses, requiems, cantatas, an oratorio, instrumental quartets, harpsichord sonatas, concertos, and a highly-praised funeral march in honour of General Hoche.

**PAISLEY**, a municipal and parliamentary burgh, and an important manufacturing town of Scotland, in the county of Renfrew, on both banks of the White Cart, four miles above its junction with the Clyde, and eight miles west-south-west of Glasgow by railway. It is on the whole a quiet, dull-looking town, dirty in the older quarters, but containing several good streets, as George, Forbes, and Gilmour



Streets; and since the introduction of an abundant supply of water from the Gleniffer Hills, is much improved in its sanitary condition.

By far the most interesting edifice is the Abbey. It was founded by Walter, the High Steward of Scotland, about 1163, for a prior and 13 monks of the Cluniac order of Reformed Benedictines, and was dedicated to St James, St Mirren, and St Milburga. It was the burying-place of the Stewarts before the accession of that family to the throne, and was occasionally used by them afterwards as a place of sepulture. It was raised to the rank of an abbey in 1245, was burned by the English in 1307, but was afterwards restored. What remains of the building is the nave, of six bays, chiefly in the First Pointed style. It is now used as the parish church, and measures 92½ feet by 35 feet. The transept is ruinous, but the north-eastern window, 25 feet high by 18 feet broad, remains. In 1862 a thorough restoration of the Abbey (at a cost of £4000) was made, the happiest feature of which was the removal of the modern and unsightly galleries. St Mirren's, or the 'Sounding Aisle,' so called from its echo, abuts upon the Abbey Church. It has a monument in the shape of a recumbent female figure resting on an altar tomb, in the attitude of prayer, supposed to commemorate Marjory Bruce, daughter of the famous King Robert.

Among the other edifices the principal are, the County Buildings, a quadrangular pile in the castellated style; the Neilson Educational Institution, a noble bequest, built in the form of a Greek cross, and surmounted by a fine dome; the Infirmary; the School of Design; and the Grammar School. This last institution was founded by King James VI., and the present building is (June 1864) just being completed.

In the beginning of the last century, the principal manufactures were coarse linens and chequered cloths. About the middle of that century, the weaving of linen and of silk gauze became the staple manufactures. In 1784 silk gauze was manufactured to the value of £350,000, and employed 5000 looms. Shawls, which used to be a principal and are still an important article of manufacture, began to be made here in the beginning of the present century. Within recent years the annual value of the shawl trade of P. was estimated at about £1,000,000 sterling. Cotton thread is manufactured on a most extensive scale; indeed P. may be considered the seat of the thread manufacture for the home and American markets. Different varieties of tartan cloths, handkerchiefs, carpets, &c. are made; soap, starch, and corn flour are largely manufactured; dyeing is carried on by several firms on an extensive scale; and a number of cotton-thread factories, power-loom factories, print works, machine shops, bleach-fields, &c. are in operation in the town and vicinity. The following is the annual value of some of the principal manufactures of P.: Paisley wove shawls, £300,000; printed shawls, black squares, silk gauzes, &c., £600,000; winceys, silk dresses, scarfs, &c., £100,000; cotton thread (which gives employment to from 3000 to 4000 people), £570,000. At the St James' Day Fair, in August, horse-races, originated by act of the bailies of the burgh in 1608, are held. Pop. (1861), 47,419.

**PALACE**, this title is applied, with few exceptions, in this country to houses occupied by royal personages only. In Italy the name is given to all fine dwellings.

**PALACKY, FRANTISEK**, a Bohemian philologist, critic, and historian, was born 14th June 1798 at Hodslavitz, in Moravia, and studied at Presburg

and Vienna, confining his attention chiefly to philological and historical investigations. In 1831 he was appointed by the states of Bohemia historiographer to that country, and was intrusted with the compilation of a general history of Bohemia. In furtherance of this work, he ransacked all the libraries and archives in Bohemia, and made long visits to Germany and Italy in search of materials. He took part in the political agitation of 1848, and was the leader of the Slav or national party as opposed to the German at the Diet of Kremsier, after the dissolution of which he returned to his literary labours. His great and justly celebrated work, *Geschichte von Böhmen*, 'The History of Bohemia' (Prague, 1836—1860, 8 vols. octavo), distinguished equally by profound research and vigour of style, was received on its publication with the utmost enthusiasm, though the zeal with which the writer defended the cause of the Slavic race drew down upon him the bitter comments of German critics; and the manner in which he spoke of John Huss in the 3d volume of the work greatly offended the Catholics. P. is the author of some other works of considerable merit, such as the *Theorie des Schönen*, 'The Theory of the Beautiful' (1821); *Allgemeine Geschichte der Aesthetik* (1823); *Die ältesten Denkmäler der Böhmisches Sprache*, 'The most Ancient Monuments of the Bohemian Tongue' (Prague, 1840); *Der Mongolen Einfall im Jahre 1241*, 'The Invasion of the Mongols in 1241' (Prague, 1842); and he has also edited some parts of the 'Scriptores rerum Bohemicarum' and 'Fontes rerum Austriacarum.'

**PA'LADIN**, a term originally derived from the Counts Palatine, or of the Palace (see **PALATINE**), who were the highest dignitaries in the Byzantine court, and thence used generally for a lord or chieftain, and by the Italian romantic poets for a knight-errant.

**PALÆASTER** (Gr. ancient star-fish), a genus of star-fish peculiar to the Silurian period, which in general appearance resemble the living brittle stars, but when more minutely examined, present so many anomalies, that they cannot be referred to any existing family. Five or six species have been described.

**PALÆOGRAPHY** (Gr. *palaios*, old, and *graphé*, writing), the science of ancient writings. It comprehends not merely the art of reading them, but such a critical knowledge of all their circumstances as will serve to determine their age, if they happen to be undated, and their genuineness in the absence of any formal authentication. For these purposes, the paleographer needs to be acquainted with the various substances, such as bark, leaves, skins, paper, &c., which have been used for writing; with the various manners of writing which have prevailed, and the changes which they have undergone; with the various forms of authenticating writings, such as seals, signets, cachets, signatures, superscriptions, subscriptions, attestations, &c., which have been employed at different times; with the various phases through which the grammar, vocabulary, and orthography of the language of the writing with which he is dealing, has passed; and with more or less, as the case may be, of the history, laws, institutions, literature, and art of the age and country to which the writing professes to belong.

Paleography may be said to have been founded by the learned French Benedictine, Jean Mabillon, whose *De Re Diplomatica*, first published in 1681 in 1 vol. fol., reprinted in 1709, and again in 1789, in 2 vols. fol., is still, perhaps, the most masterly work on the subject. Along with the *Novæque Traité de Diplomatique* (Par. 1750—1765, 6 vols.

4to) of the Benedictines of St Maur, and the *Éléments de Paléographie* (Par. 1838, 2 vols. 4to) by M. Natalis de Wailly, it is the great authority for French palæography. English palæography is perhaps less favourably represented in Astle's *Origin and Progress of Writing* (Lond. 1803), than Scottish palæography in Anderson's and Ruddiman's *Diplomata Scotie* (Edin. 1739). Muratori treats of Italian palæography in the third volume of his great work, the *Antiquitates Italicae Medii Ævi*; and among later works on the same subject may be mentioned the *Diplomatica Pontificia* (Rome, 1841) of Marino Marini. The palæography of Greece is illustrated in the *Palæographia Græca* (Par. 1708) of Montfaucon. Spanish palæography may be studied in the *Bibliotheca de la Polygraphia Espanola* (Mad. 1738) of Don C. Rodriguez. Of works on German palæography, it may be enough to name Eckard's *Introductio in Rem Diplomaticam* (Jen. 1742), Heumann's *Commentarii de Re Diplomatica* (Norimb. 1745), Walther's *Lexicon Diplomaticum* (Gott. 1745), and Kopp's *Palæographia Critica* (Manh. 1817). Hebrew palæography has been elaborated by Gesenius in his *Geschichte der Hebräischen Sprache und Schrift*, and other works. The great work on palæography generally—one of the most sumptuous works of its class ever published—is the *Paléographie Universelle* (Par. 1839—1845, in 5 vols. fol.) of M. J. B. Silvestre. See BLACK LETTER, CONTRACTIONS, PALIMPSEST, PAPYRL.

**PALÆOLOGUS**, the name of an illustrious Byzantine family, which first appears in history about the 11th c., and attained to imperial dignity in the person of MICHAEL VIII. in 1260. This emperor successfully undertook many expeditions to Greece and the Archipelago, and used his utmost endeavours to heal the schism between the Roman and Greek Churches, though with exceedingly little success. His successor on the throne was his son ANDRONICUS II. (1282—1329), under whose reign the Turks commenced in earnest a series of assaults on the Byzantine dominions. Andronicus attempted to oppose them with a force composed of mercenaries, but his success was very doubtful, as these troops, with perfect impartiality, attacked both his enemies and his subjects. To pay them he was compelled to levy such imposts as went far to destroy Byzantine commerce. He associated his son, MICHAEL IX., with himself in the government, and was dethroned by his grandson, ANDRONICUS III. (1328—1341), an able warrior and wise ruler, who repeatedly defeated the Bulgarians, Tartars of the Golden Horde, and the Servians, and diminished the oppressive imposts of the previous reign. He was, however, unsuccessful against the Catalans in Greece, and the Turks during his reign ravaged Thrace as far as the Balkan. He was greatly esteemed by his subjects, and well merited the title of 'Father of his Country,' which they bestowed upon him. His son, JOHN VI. (1355—1391), a weak and voluptuous prince, attempted in vain both by force and bribery to stop the progress of the Turks; at last the pope, moved by his urgent entreaties, which were backed by a promise to submit the Greek Church to his (the pope's) supremacy, urged the Hungarians and Servians to arm in defence of the Greek emperor, but the result was only an additional triumph to Sultan Amurath. The imbecile emperor was several times deposed, and on his final reinstatement by the sultan, acknowledged himself as his vassal for the capital and a small tract along the Propontis and Black Sea. Indeed, so degraded had the Byzantines become, that they obeyed the Sultan Bajazet's summons to aid him in reducing Philadelphia, the last Greek stronghold in Asia Minor. His son, ANDRONICUS IV. (1356—

1373), who had been associated with him in the government, died in exile. MANUEL II. (1391—1425) pursued the same tactics as his father John VI., and with the same result. The allied army of the Hungarians, Germans, and French, which he had summoned to his aid against the Turks, was totally routed at Nicopolis by Bajazet, and Constantinople itself closely besieged. The invasion of Asia Minor by Timur, however, compelled the sultan to withdraw his whole force, and his subsequent defeat and capture at Angora in 1402, and the contests among his sons for the supremacy, gave the Greek empire a breathing space. Having aided Mohammed I. in his contests with his brothers, Manuel was, by the grateful sultan, presented with some districts in Greece, Thessalonica, and on the Euxine. JOHN VII. (1425—1449), on being pressed by the Turks, again held out to the pope the old bait of the union of the Greek and Western Churches under his sway, and even presented himself at the council of Florence, where, in July 1439, the union of the churches was agreed to. But on his return to Constantinople, the opposition of the Greek ecclesiastics to the union, supported by the people, rendered the agreement of Florence a dead letter. The pope, however, saw that it was for his interest to fulfil his part of the agreement, and accordingly stirred up Wladislas of Hungary to attack the Turks (see JAGELLONS), but this act only hastened the downfall of the Palæologi. John's brother, CONSTANTINE XIII. (1449—1453), a heroic scion of a degenerate race, accepted the crown after much hesitation, knowing his total inability to withstand the Turks, and even then took the precaution of obtaining the sultan's consent before he exercised the imperial authority; but some rebellions in Caramania which now occurred, baffling Sultan Mohammed II.'s efforts to quell them, the emperor was willingly persuaded by his rash advisers that the time had now arrived for rendering himself independent of the Turks. The attempt, however, only brought swifter destruction on the wretched remnant of the Byzantine empire, for Mohammed invested the capital by sea and land, and after a siege, which lasted from 6th April to 29th May 1453, Constantinople was taken by storm, and the last of the Palæologi fell fighting bravely in the breach. A branch of this family ruled Montferrat in Italy from 1306, but became extinct in 1533. The Palæologi were connected by marriage with the ruling families of Hungary, Servia, and the last of the family married Ivan, Czar of Russia—a fact which the Czars of Russia have persisted till lately in bringing forward as a claim in favour of their pretensions to the possession of European Turkey. It is said that direct descendants of the Palæologi exist to the present day in France. (For further information, see the separate articles on some of the emperors, and BYZANTINE EMPIRE.)

**PALÆONISCUS** (Gr. ancient sea-fish), a genus of ganoid fish, with a fusiform body, covered with rhomboid scales, a heterocercal tail, and moderately-sized fins, each furnished with an anterior spine.

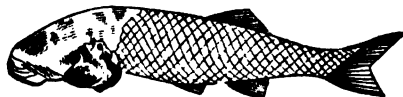

Palæoniscus.

The single dorsal fin is opposite to the interval between the anal and ventral fins. Twenty-eight species have been described from the Carboniferous and Permian measures.

## PALÆONTOLOGY.

**PALÆONTOLOGY** (Gr. science of fossil animals) is that division of Geology (q. v.) whose province it is to inquire into the evidence of organic life on the globe during the different bygone geological periods, whether this evidence arises from the actual remains of the different plants and animals, or from recognisable records of their existence, such as footprints, Coprolites (q. v.), &c.

The metamorphic action which has so remarkably altered the oldest sedimentary rocks, is sufficient to have obliterated all traces of organic remains contained in them. Fossils are consequently extremely rare in these older palæozoic strata, and indeed it is only after long search, and within the last few months, that undoubted remains have been found in the Laurentian rocks. We were unable to record their existence in the article **LAURENTIAN SYSTEM**; but in the article **LIMESTONE**, we referred to the existence of beds of limestone as requiring the presence of animal life for their production. It is true that in 1852 an organic form resembling a coral was found in the limestone of the Ottawa, but much doubt was always entertained regarding this solitary discovery. In 1863, however, there was detected an organism in the serpentine limestone of Grenville, of true Laurentian age, which Dr Dawson describes as that of a Foraminifer, growing in large sessile patches, after the manner of *Carpentaria*, but of much greater dimensions, and presenting minute points, which reveal a structure resembling that of other foraminiferal forms, as, for example, *Calcarina* and *Nummulina*. Large portions of the limestone appear to be made up of these organisms, mixed with other fragments, which suggest comparisons with crinoids and other calcareous fossils, but which have not yet been distinctly determined. Some of the limestones are more or less coloured by carbonaceous matter, exhibiting evidences of organic structure, probably vegetable. In this single Foraminifer, and the supposed coral, we have all that is positively known of the earliest inhabitants of our globe, with which we are yet acquainted. That these are but the smallest fraction of the fauna of the period in which they lived, is evident from the undetermined fragments associated with them, as well as from the extensive deposits of limestone of the same age. And that contemporaneous with them, there existed equally numerous representatives of the vegetable kingdom, cannot be doubted, when it is remembered that the animal can obtain its food only through the vegetable, and not directly from inorganic materials. Besides, their remains apparently exist in the limestone at Grenville, a rock which, from its very nature, rarely contains vegetable fossils.

The Cambrian rocks, though of immense thickness, have hitherto yielded indications of only a very few animals, but these have a special interest, as they are the oldest fossil remains yet detected in Britain. They consist of an impression which Salter considers to be portion of a trilobite, named by him *Palæopyge*, of the burrows and tracks of sea-worms, and of two species of radiated zoophytes called *Oldhamia*—animals which in this case also can be nothing more than the most fragmentary representations of the fauna of the period. No indications of vegetable life have yet been noticed in the Cambrian rocks, for we cannot consider the superficial markings on some of these strata as having anything to do with fungi.

Undoubted representations of the four invertebrate sub-kingdoms early make their appearance in the Silurian strata, and the occurrence before the close of the period of several fish, adds to them the remaining sub-kingdom—the vertebrata. If we except the silicious frustules of Diatomaceæ which

are said to have been detected in these rocks, no satisfactory traces of plants have yet been observed, although extensive layers of anthracitic shales are common. Of the lower forms of the animal kingdom, some sponge-like bodies have been found, and corals are remarkably abundant, chiefly belonging to the order *Rugosa*, a palæozoic type, the members of which have horizontal tabulae, and vertical plates or septa, either four in number, or a multiple of four. Graptolites, another family of zoophytes, flourished in the dark mud of the Silurian sea, and did not survive the period. All the great divisions of the Mollusca are represented by numerous genera, several of which are not very different from some living forms. A few true star-fishes have left their records on the rocks, but the most striking feature in the Echinodermata of the period is the Cystideans, or armless sea-lilies, which, like the Graptolites, did not pass beyond the Silurian seas. Tubes, tracks, and burrows of annelids have been observed; and numerous Crustacea, belonging, with the exception of one or two shrimp-like species, to the characteristic palæozoic Trilobite, of which the number of individuals is as remarkable as the variety of species and genera. It is only in the upper portion of the group (the Ludlow beds) that the fish remains have been found. These have been referred to six different genera, and are chiefly loricated ganoids, of which *Cephalaspis* is the best known.

The rocks of the Old Red Sandstone period supply the earliest satisfactory remains of plants. The Ferns, Sigillaria, Lycopodites, and Calamites, so abundant in the Coal Measures, make their appearance among the newer of these beds, and even fragments of dicotyledonous wood have been observed. The various sections of the invertebrata are well represented, but the remarkable characteristic in the animal life of the period is the abundance of strange forms of heterocercal-tailed fish, whose buckler-shields, hard scales, or bony spines occur in the greatest abundance in some beds. The reptiles and reptile tracks in the Red Sandstone of Moray, originally referred here, are now universally considered as belonging to the New Red measures.

The striking feature in the rocks of the Carboniferous period is the great abundance of plants, the remains of which occur throughout the whole series, the coal-beds being composed entirely of them, the shales being largely charged with them, the sandstones containing a few, and even the limestones not being entirely without them. These plants were specially fitted for preservation, the bulk of them being vascular cryptogams, a class which Lindley and Hutton have shewn by experiment to be capable of long preservation under water. They are chiefly ferns; some are supposed to have been arborescent lycopods, while others (*Sigillaria*, *Calamites*, and *Asterophyllites*) are so different from anything now known, that their position cannot be definitely determined, though it is most probably among the higher cryptogams. Several genera of conifers have been established from fossilised fragments of wood; and some singular impressions, which look like the flowering stems of dicotyledonous plants, have been found. The limestones are chiefly composed of crinoids, corals, and brachiopodous shells. The corals attain a great size, and the crinoids are extremely abundant, their remains making sometimes beds of limestone 1000 feet thick, and hundreds of square miles in extent. Many new genera of shells make their appearance. The trilobites, which were so abundant in the earlier rocks, are reduced to one or two genera, and finally disappear with this period. Fish with polished bony scales are found; and others, like the Port Jackson shark, with pavements of flat teeth over their mouth and gullet,

fitting them to crush and grind the shell-protected animals on which they fed. Strange fish-like reptiles existed in the seas, and air-breathing species have been found on the continent and in America. The wing-cases, and parts of the bodies of insects, have also been found.

The Permian period is remarkable for the paucity of its organic remains, but this may arise from our comparative ignorance of its strata. The plants and animals are on the whole similar to those found in the Carboniferous measures, and a great proportion of them belong to the same genera. Many ancient forms do not pass this period, as the *Sigillaria* among plants, and the *Producta* among animals.

The red sandstones of the Triassic period are remarkably destitute of organic remains—the iron, which has given to them this colour, seems to have been fatal to animal life. In beds, however, on the continent, in which the iron is absent, fossils abound. These fossils present a singular contrast to those met with in the older rocks. The Palæozoic forms had been gradually dying out, and the few that were still found in the Permian strata do not survive that period, while in their place there appear in the Trias many genera which approach more nearly to the living forms. Between the organisms of the Permian and Triassic periods there exist a more striking difference than is to be found between those of any previous periods. Looking at this life-character, the rocks from the Permian downwards have been grouped together under the title Palæozoic; while from the Trias upwards the whole of the strata have received the name of Neozoic.

The extensive genera of Ammonites and Belemnites make their first appearance in the Trias. Several new forms of Cestracient fish occur, and the reptiles increase in number and variety; among them is the huge batrachian Labyrinthodon, and the singular fresh-water tortoise, *Dicynodon*. The bird-tracks on the sandstones of Connecticut are by some referred to this age. Small teeth of mammalia, believed to be those of an insectivorous animal, like the *Myrmecobius* of Australia, have been found in the Keuper beds of Germany and Somerset.

In the Oolitic series we have an abundance of organic remains, in striking contrast to the scanty traces in the Permian and Triassic periods. Many new genera of ferns take the place of the Palæozoic forms, and a considerable variety of Conifers make their appearance, some of which have close affinities with living species, one, indeed, being referred to a still existing genus. The same approximation to living types is to be found in the animal kingdom. Several of the foraminifers are referred to living genera. Among the corals, the representatives of two living families make their appearance. No new genera are found among the Brachiopoda; but the Conchifera and Gasteropoda shew a great addition of new genera, some of which are still represented by living species, while not many new genera were added to the Cephalopoda, though they were individually very abundant. In some places the Lias shale consists of extensive pavements of Belemnites and Ammonites. The Crinoids give place to the increasing variety of sea-urchins and star-fishes. Numbers of insects have been found. The Cestracients continue to be represented in the Oolitic seas, but with them are associated several true sharks and rays; and the homocercal-tailed fish become numerous. Labyrinthodont reptiles abound; the huge *Megalosaurus* and its companions occupied the land; while the seas were tenanted with the remarkable *Ichthyosaurus* and *Plesiosaurus*, and the air with the immense bat-like *Pterodactyle*. Seven

genera of Mammalia have been found, all believed to be small carnivorous or insectivorous marsupials, except the *Stereognathus*, which Owen considers to have been a placental mammal, probably hoofed and herbivorous.

In the Cretaceous beds, which are chiefly deep-sea deposits, the remains of plants and land animals are comparatively rare. The Wealden beds, however, which had a fresh-water origin, contain the remains of several small marsupials, some huge carnivorous and herbivorous reptiles, a few fresh-water shells, and some fragments of drift-wood. The true chalk is remarkably abundant in the remains of foraminifers—indeed, in some places, it is composed almost entirely of the shell of these minute creatures. Of the mollusca, the Brachiopoda are in some beds very abundant; the Conchifera introduce several new forms, the most striking of which is the genus *Hippurites*, which with its allies did not survive this period; the cephalopodous genera which appeared in the Oolite, continue to abound in the chalk, many new forms being introduced; while others disappear with the period, like the Belemnites and Ammonites. Sea-urchins become still more numerous. In some beds the remains of fish are abundant, and while cartilaginous species still exist, the bony fishes become more numerous; and among them the family to which the salmon and cod belong makes its appearance. Reptiles are common in the Wealden, and the flying *Pterodactyles* attained a greater size, and were probably more numerous than in the former period. The remains of a single bird has been obtained from the greensand, but with this exception, birds as well as mammals have left no traces that have yet been found in the Cretaceous beds, though doubtless they existed.

In the Tertiary strata, the genera are either those still living, or forms very closely allied to them, which can be separated only by the careful examination of the accurate scientific observer. The plants of the Eocene beds are represented by dicotyledonous leaves, and palm and other fruits. Foraminifers are remarkably abundant, whole mountain masses being formed of the large genus *Nummulites*. Brachiopoda are rare, but Conchifera, Gasteropoda, and Cephalopoda increase in number; the new forms being generically almost identical with those now living. The principal living orders of fish, reptiles, and birds are represented in the Eocene strata. A considerable variety of pachydermatous mammals, suited apparently to live on marshy grounds and the borders of lakes, have been found in France and England, and associated with them are some carnivorous animals, whose remains are, however, much rarer. An opossum has been found at Colchester. The fragments belonging to the supposed monkey are portions of a small pachyderm, *Hyacotherium* (q. v.).

Little need be said of the invertebrata of the Miocene period, beyond remarking their growing identity in genera with the living forms. Among the mammals, the *Quadrumana* make their first appearance. The true elephant and the allied mastodon are represented by several species; a huge carnivorous whale has been discovered, and several *Carnivora* and deer, with a huge edentate animal, have been described. Owen thus speaks of these animals: 'Our knowledge of the progression of Mammalian life during the Miocene period, teaches us that one or two of the generic forms most frequent in the older Tertiary strata still lingered on the earth, but that the rest of the Eocene Mammalia had been superseded by new forms, some of which present characters intermediate between those of Eocene and those of Pliocene genera.'

In passing upwards through the Tertiary strata, the organic remains become more and more identical with living forms, so that when we reach the Pliocene and Pleistocene periods, the great proportion of the invertebrata are the same species which are found occupying the present seas. Among the higher orders of animals, the life of a species is much shorter than in the lower, and consequently, though the vertebrata approach so nearly to existing forms as for the most part to be placed in the same genera, yet the species differ from any of the living representatives of the different genera.

The Suffolk 'Crag,' which are the only British representatives of the Pliocene period, contain the relics of a marine testacea, that differs little from the present tenants of the European seas, between 60 and 70 per cent. being the same species. The ear-bones of one or more species of Cetacea have been found, and at Antwerp, the remains of a dolphin have been discovered in beds of this age.

The various local deposits which together form the Pleistocene strata, the latest of the geological periods, contain a great variety of organic remains. In the submarine forests, and in beds of peat, the stumps of trees are associated with the remains of underwood and herbaceous plants of species still living. Nearly all the mollusca and other marine invertebrata still survive. It is among the vertebrata that the most remarkable forms appear—forms which in the main differ little from the existing race of animals except in their enormous size. Elephants and rhinoceroses, fitted for a cold climate by their covering of long coarse hair and wool, roamed over the northern regions of both the Old and the New World, and were associated with animals belonging to genera which still exist in the same region, as bears, deer, wolves, foxes, badgers, otters, wolverines, weasels, and beavers, besides others whose representatives are now found further south, as the hippopotamus, tapir, and hyena. Contemporary with these, there lived in South America a group of animals which were types in everything but in size of the peculiar existing fauna of that continent. Among these were gigantic sloth-like animals, fitted to root up and push down the trees, instead of climbing to strip them of their foliage, like the sloth. The armadillo was represented by the huge Glyptodon, whose body was protected by a strong tessellated coat of mail. The species of fossil tapirs and peccaries are more numerous than their living representatives. The lamas were preceded by the large Macrauchenia, and the opossums and platyrhine monkeys were also prefigured by related species. Besides these, there have been found the remains of two mastodons and a horse, none of which are represented by any indigenous living animal in South America. The peculiar group of animals confined to Australia were prefigured by huge marsupials, some having close analogies to the living kangaroos and wombats, while others were related to the carnivorous native tiger. The gigantic wingless birds of New Zealand correspond in type with the anomalous apteryx, now existing only on these islands.

Associated with the remains of elephants, mastodons, cave-bears, and cave-hyenas, there have been found, in England and France, numerous specimens of flint implements, which are undoubtedly the result of human workmanship, and shew at least that man was contemporaneous with these extinct animals. If more certain evidence were needed of this, it has been obtained in the discovery of flint implements, bone implements fashioned and carved by means of the flint knives, the horns of a reindeer, two kinds of extinct deer, *Bos primigenius*, and other animals, associated with numerous bones

of man, included in the breccia of the cave of Bruniquel in France. Owen considers the evidence of the contemporaneity of the various remains as conclusive. The several human skulls which have been obtained shew, according to the same authority, no characters whatever indicative of an inferior or transitional type. There are no certain data to give probability to the guesses which have been made as to the number of years which have elapsed since these deposits in which the relics of man occur were formed. The whole inquiry, moreover, is so recent, and the accumulation of facts is almost every day going on, that it would be premature to speak dogmatically on the subject.

**PALÆOPYGÉ** (Gr. ancient rump), a genus of fossil Crustacea, founded on a single impression from the surface of a bed in the Longmynd, of Cambrian age. Salter believes it to be the cephalic shield of a trilobite, but it may be only an accidental marking. If it be the impression of an organism, it is so distorted and imperfect that little can be made of it; its peculiar interest arises from its being associated with the earliest forms of life that have been observed on the globe.

**PALÆOSAURUS** (Gr. ancient lizard), a genus of fossil saurian reptiles peculiar to the Permian period. The remains of two species occur in the dolomitic conglomerate at Redland, near Bristol. The teeth were more or less compressed, and were furnished with serrated cutting margins. The vertebræ were biconcave, and had a remarkable depression in the centre of each vertebra, into which the spinal canal was sunk. The leg-bones shew that the Palæosaurs were fitted for moving on the land. Owen thus exhibits their affinities: 'In their thecodont type of dentition, biconcave vertebræ, double-jointed ribs, and proportionate size of the bones of the extremities, they are allied to the Teleosaurus, but with these they combine a Dinosaurian femur, a lacertian form of tooth, and a crocodilian structure of pectoral and probably pelvic arch.'

**PALÆOTHERIUM** (Gr. ancient wild beast), a genus of pachydermatous mammalia whose remains occur in the Eocene beds of England and the continent. At least ten species have been described,

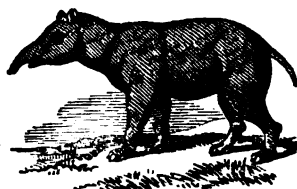

Palæotherium.

ranging in size from that of a sheep to that of a horse. The upper Eocene gypseous quarries of Montmartre supplied the first scanty materials, which Cuvier, by a series of careful and instructive inductions, built up into an animal, whose fidelity to nature was afterwards verified by the discovery of a complete series of fossils. In general appearance the Palæotherium resembled the modern tapir, and especially in having the snout terminating in a short proboscis. It had three toes on each foot, each terminated by a hoof.—The formula of the teeth is the same as that of the Hyracothera, viz.,

$$I \frac{3-3}{2-3}, C. \frac{1-1}{1-1}, P. M. \frac{4-4}{4-4}, M. \frac{3-3}{3-3} = 44;$$

but the structure of the molars approaches nearer to the molars of the rhinoceros. It is supposed that animals of this genus dwelt on the margins of lakes and rivers, and that their habits were similar to those of the tapir.

**PALÆOZO'IC** (Gr. ancient life), the name given to the lowest division of the fossiliferous

rocks, because they contain the earliest forms of life. They were formerly, and are still generally, known as the Primary rocks. The strata included under these titles are the Laurentian, Cambrian, Silurian, Old Red Sandstone, Carboniferous, and Permian systems. Phillips, for the sake of uniformity, introduced Mesozoic as equivalent to Secondary, and Neozoic to Tertiary rocks.

**PALÆSTRA**, a building for gymnastic sports.

**PALAFOX Y MELZI**, Don José DE, Duke of Saragossa, a Spanish patriot, was born in 1780 of a distinguished Aragonese family, and received an excellent education. He accompanied Ferdinand VII to Bayonne, and on seeing him made a prisoner there, fled to Saragossa, where he exerted himself to prevent the invasion of Aragon by the French. His defence of Saragossa (q. v.), 27th July 1808—21st February 1809, which only yielded to the French after a second investment, is one of the most brilliant and heroic incidents in modern history, and has conferred lasting glory on P. and the whole city. The ancient fame of the Spaniards for obstinate valour in the defence of walled cities was rivalled, if not surpassed, and Saragossa could proudly claim to vie with Numantia. P., sick and exhausted, was taken prisoner and conveyed by the ungenerous French to the dungeons of Vincennes, where he was treated with great hardship. Released in 1813, he returned to Spain, and was appointed in the following year captain-general of Aragon. P. was no great politician, but he loved liberty and hated anarchy, and on more than one occasion he supported the former and crushed the latter. After being created Duke of Saragossa, and Grandee of Spain of the first class in 1836, he kept himself apart from politics. He died at Madrid, 16th February 1847.

**PALAIS ROYAL**, a heterogeneous mass of buildings on the eastern side of the Rue Richelieu in Paris, composed of a palace, theatres, public gardens, bazaars, shops, cafés, and restaurants. The old palace was built between 1624 and 1636 on the site of the Hôtel Rambouillet by Cardinal Richelieu, who at his death bequeathed it to Louis XIII., during whose reign it was for a time occupied by Henrietta of France, widow of Charles I. Anne of Austria, the queen mother, resided here with her young son, Louis XIV., till she was driven from it by the intrigues of the Fronde; and after having remained many years unoccupied, it was given to the king's younger brother, Philip Duke of Orleans, and thenceforth was regarded as the town residence of the Orleans branch of the Bourbons, and known by its present name, instead of its original title of Palais Richelieu. During the minority of Louis XV. it acquired a scandalous notoriety as the scene of the wild orgies in which the regent, Duke of Orleans, and his dissolute partisans were wont to indulge; while in the time of his son, Philippe Egalité, it became the focus of revolutionary intrigue, and the rendezvous for political demagogues of every shade of opinion. This prince, partly to repair his impoverished fortune, and partly to persuade the sans-culottes of Paris of the sincerity of his professed sympathy with their striving for equality, converted part of his gardens into a place of public resort, and the pavilions of the great court into bazaars, which were divided into shops and stalls. On the downfall of Egalité, the P. R. was taken possession of by the republican government, and used for the sittings of the tribunes during the Reign of Terror. On the restoration of the Bourbons, it reverted to the Orleans family, and was occupied by Louis Philippe till his election to the throne of France in 1830, when it was incorporated in the general domains of the state, and ceased to be an

appanage of the House of Orleans. The palace was sacked by the mob during the Revolution of 1848, when many of its best paintings and most precious works of art were destroyed; and after having been temporarily appropriated to various public purposes, it was thoroughly repaired and magnificently furnished, and given by the present emperor, in 1855, to his uncle Jerome Bonaparte, whose son Prince Napoleon now resides there. The main entrance, with its elegant façade, is in the Rue St Honoré; and on passing through the first court, the second or Cour Royale is reached, to the left of which stands the Théâtre Français, while immediately facing it is the celebrated Galerie Vitrée, or Glass Gallery, which contains on the ground floor some of the most brilliant shops of Paris, while the upper stories are chiefly occupied by cafés and restaurants. The garden, which is surrounded by this and other galleries, measures 700 feet by 300. With its avenues and parterres, fountains and grass plots, it still constitutes one of the liveliest and most frequented spots in Paris; and although much of their old glory has faded, its cafés, as those De la Rotonde, De Foi, Very, Les Trois Frères Provençaux, &c., yet maintain a world-wide reputation. The high premium paid for the privilege of supplying visitors frequenting certain cafés with seats and refreshments in the garden, and the exorbitant rents demanded for shops and stalls of every class, constitute a profitable source of revenue to the government.

**PALANQUIN**, or **PALKI**, the vehicle commonly used in Hindustan by travellers, is a wooden box, about 8 feet long, 4 feet wide, and 4 feet high, with wooden shutters which can be opened or shut at pleasure, and constructed like Venetian blinds for the purpose of admitting fresh air, while at the same time they exclude the scorching rays of the sun, and the heavy showers of rain so common in that country. The furniture of the interior consists of a cocoa mattress, well stuffed and covered with morocco leather, on which the traveller reclines; two small bolsters are placed under his head, and one under his thighs, to render his position as comfortable as possible. At the upper end is a shelf and drawer, and at the sides are nettings of larger dimensions than the ordinary pockets in carriages, for containing those articles which may be necessary to the traveller during his journey. At each end of the palanquin, on the outside, two iron rings are fixed, and the *hammals*, or palanquin-bearers, of whom there are four, two at each end, support the palanquin by a pole passing through these rings. Travelling in this mode is continued both by day and night. (See **DAWK**.) The palanquin is also used at the present day in Brazil, with the prominent exception of Rio Janeiro.

Similar modes of travelling have been at various times in use in Western Europe, but only for short distances. The Roman 'litter,' the French 'chaise à porteurs,' and the 'sedan-chair' were the forms of vehicle most in use, and the two latter were in general use in towns till they were superseded by hackney coaches. The Roman 'litter' was one of the criteria of its owner's wealth, the rich man generally exhibiting the prosperous condition of his affairs by the multitude of the bearers and other attendants accompanying him.

**PALAPTERYX** (Gr. ancient apteryx), a genus of fossil birds whose remains are found in the river-silt deposits of New Zealand, associated with the gigantic *Dinornis*, and which, like it, resembled in the form of the sternum, and the structure of the pelvis and legs, the living wingless apteryx. Two species have been described.

## PALATE.

**PALATE, THE,** forms the roof of the mouth, and consists of two portions, the hard palate in front and the soft palate behind. The framework of the *hard palate* is formed by the palate process of the superior maxillary bone, and by the horizontal process of the palate bone, and is bounded in front and at the sides by the alveolar arches and gums, and posteriorly it is continuous with the soft palate. It is covered by a dense structure formed by the



The Mouth widely opened so as to shew the Palate :  
1, 1, the upper, and 2, the lower lip; 3, 3, the hard palate;  
4, 4, the soft palate; 5, the uvula; 6, 6, the arches of the  
soft palate; 7, 7, the tonsils; 8, the tongue.

periosteum and mucous membrane of the mouth, which are closely adherent. Along the middle line is a linear ridge or raphe, on either side of which the mucous membrane is thick, pale, and corrugated, while behind it is thin, of a darker tint, and smooth. This membrane is covered with scaly epithelium, and is furnished with numerous follicles (the palatal glands). The *soft palate* is a movable fold of mucous membrane enclosing muscular fibres, and suspended from the posterior border of the hard palate so to form an incomplete septum between the mouth and the pharynx; its sides being blended with the pharynx, while its lower border is free. When occupying its usual position (that is to say, when the muscular fibres contained in it are relaxed), its anterior surface is concave; and when its muscles are called into action, as in swallowing a morsel of food, it is raised and made tense, and the food is thus prevented from passing into the posterior nares, and is at the same time directed obliquely backwards and downwards into the pharynx.

Hanging from the middle of its lower border is a small conical pendulous process, the *uvula*; and passing outwards from the uvula on each side are two curved folds of mucous membrane containing muscular fibres, and called the *arches* or *pillars* of the *soft palate*. The *anterior pillar* is continued down-

wards to the side of the base of the tongue, and is formed by the projection of the palato-glossus muscle. The *posterior pillar* is larger than the anterior, and runs downwards and backwards to the side of the pharynx. The anterior and posterior pillars are closely united above, but are separated below by an angular interval, in which the *tonsil* of either side is lodged. The tonsils (*amygdalæ*) are glandular organs of a rounded form, which vary considerably in size in different individuals. They are composed of an assemblage of mucous follicles, which secrete a thick grayish matter, and open on the surface of the gland by numerous (12 to 15) orifices.

The space left between the arches of the palate on the two sides is called the *isthmus of the fauces*. It is bounded above by the free margin of the palate, below by the tongue, and on each side by the pillars of the soft palate and tonsils.

As the upper lip may be fissured through imperfect development (in which case it presents the condition known as hare-lip), so also may there be more or less decided fissure of the palate. In the slightest form of this affection, the uvula merely is fissured, while in extreme cases the cleft extends through both the soft and hard palate as far forward as the lips, and is then often combined with hare-lip. When the fissure is considerable, it materially interferes with the acts of sucking and swallowing, and the infant runs a great risk of being starved; and if the child grows up, its articulation is painfully indistinct. When the fissure is confined to the soft palate, repeated cauterisation of the angle of the fissure has been found sufficient to effect a cure by means of the contraction that follows each burn. As a general rule, however, the child is allowed to reach the age of puberty when the operation of *staphyloraphy* (or suture of the soft parts) is performed—an operation always difficult, and not always successful. For the method of performing it, the reader is referred to the *Practical Surgery* of Mr Fergusson, who has introduced several most important modifications into the old operation.

Acute inflammation of the tonsils, popularly known as **QUINSY**, is treated of in a separate article.

Chronic enlargement of the tonsils is very frequent in scrofulous children, and is not rare in scrofulous persons of more advanced age, and may give rise to very considerable inconvenience and distress. It may occasion difficulty in swallowing, confused and inarticulate speech, deafness in various degrees from closure of the eustachian tubes (now often termed *throat deafness*), and noisy and laborious respiration, especially during sleep; and it may even cause death by suffocation, induced by the entanglement of viscid mucus between the enlarged glands. Iodide of iron (especially in the form of Blancard's Pills) and cod-liver oil are the medicines upon whose action most reliance should be placed in these cases, while a strong solution of nitrate of silver (a scruple of the salt to an ounce of distilled water), or some preparation of iodine, should be applied once a day to the affected parts. If these measures fail, the tonsils must be more or less removed by the surgeon, either by the knife or scissors, or by a small *guillotine* specially invented for the purpose.

Enlargement or relaxation of the uvula is not uncommon, and gives rise to a constant tickling cough, and to expectoration, by the irritation of the larynx which it occasions. If it will not yield to astringent or stimulating gargles, or to the stronger local applications directed for enlarged tonsils, its extremity must be seized with the forceps, and it

## PALATINATE—PALATINE

must be divided through the middle with a pair of long scissors.

**PALATINATE**, a name applied to two German states, which were united previously to the year 1620. They were distinguished as the Upper and Lower Palatinate. The Upper or Bavarian P., now forming a circle of the kingdom of Bavaria, was a duchy, and was bounded by Baireuth, Bohemia, Neuburg, Bavaria, and the district of Nürnberg. Area, 2730 square miles; pop. (1807) 283,800. Amberg was the chief city, and the seat of government. The Lower P., or the Palatinate on the Rhine, embraced an area of from 3045 to 3150 square miles; and consisted of the electoral P., the principality of Simmern, the duchy of Zweibrücken, the half of the county of Sponheim, and the principalities of Beldenz and Lautern. For the area and population of the modern provinces of the Upper and Lower P., see article **BAVARIA**.

The counts of the electoral or Rhenish P. were established in the hereditary possession of the territory of that name, and of the lands attached to it, as early as the 11th century. After the death of Herman III., the Emperor Friedrich I. assigned the P. to Conrad of Swabia. After Conrad's death, his son-in-law, Duke Henry of Brunswick, came, in 1196, into the possession of these lands, but he, having been outlawed in 1215 by Friedrich II., was succeeded by his son, Otto III., Duke of Bavaria. Ludwig II., or the Strong, succeeded the preceding in the P. in 1253, and was in turn succeeded in 1294 by Rudolf I., who, however, was banished by his brother, the Emperor Ludwig, because he had taken part with Friedrich of Austria. The country was ruled by his three sons. Ruprecht III., who died in 1410, was a German emperor. Of his four sons, Ludwig III. received the electoral or Rhenish P.; Johann, the Upper P.; Stephan, Zweibrücken; and Otto, Mosbach. The second and fourth lines soon died out, as well as also that of Ludwig III., which came to a close in 1559, upon which the possessions of that prince, together with the electorate, passed to Friedrich III. of the Simmern line. He was succeeded by Ludwig IV. in 1576, by Friedrich IV. in 1583, and by Friedrich V. in 1610, who, after he accepted the Bohemian crown, was driven from his possessions by the emperor in 1619, and his office of elector was transferred to Maximilian, Duke of Bavaria. Karl Ludwig, son of Friedrich V., received the Lower P. at the peace of Westphalia, and in his favour a new or eighth electorship was created. With his son Karl, the Simmern line terminated in 1685, upon which the P. fell into the hands of Philipp Wilhelm, count palatine of Neuburg.

The House of Neuburg was descended from Ludwig the Black, count palatine in Zweibrücken, second son of Stephan, count palatine in Simmern. Wolfgang, a descendant of Ludwig's, was the founder of all the other lines of counts palatine. Of his three sons, Johann founded the line of Neu-Zweibrücken, Karl the Birkenfeld line, Philipp Ludwig the Neuburg line. Philipp Ludwig had three sons, Wolfgang Wilhelm, August, and Johann Friedrich. The first founded the Neuburg line, the second the Sulzbach line, the third died childless. The son of Wolfgang Wilhelm died in 1690. His son, Johann Wilhelm, became heir to the Beldenz line in 1694. He was succeeded by his brother, Karl Philipp, who in turn was succeeded in 1742 by Karl Theodor, from the Sulzbach line, who united the Bavarian territories with the Palatinate. Duke Maximilian of Zweibrücken next succeeded in 1799, who at the peace of Luneville (1801) was compelled to cede a portion of the Rhenish P. to France, a part to Baden, a part to Hesse-Darmstadt, and a

part to Nassau. Treaties of Paris of 1814 and 1815 re-assigned the Palatinate lands beyond the Rhine to Germany, Bavaria receiving the largest share, and the remainder being divided between Hesse-Darmstadt and Prussia.

**PALATINE** (from Lat. *palatium*, a palace). A *Comes Palatinus*, or Count Palatine, was, under the Merovingian kings of France, a high judicial officer, who had supreme authority in all causes that came under the immediate cognizance of the sovereign. After the time of Charlemagne, a similar title was given to any powerful feudal lord, to whom a province, generally near the frontier, was made over with *jura regalia*, or judicial powers, similar to what the counts palatine had received in the palace, and the district so governed was called a *palatinate* or *county palatine*. There were three counties palatine in England—Lancaster, Chester, and Durham—which were, no doubt, made separate regalties on account of their respective proximity to the frontier of Wales and to that turbulent Northumbrian province which could neither be accounted a portion of England nor of Scotland. In virtue of their regal rights, the counts palatine had their courts of law, appointed their judges and law officers, and could pardon treasons, murders, and felonies; all writs and judicial process proceeded in their names, and the king's writs were of no avail within the bounds of the palatinate. Lancaster seems to have been made a county palatine by Edward III. Henry, first Duke, and John, second Duke of Lancaster, were both invested by him with the dignity of count palatine. Henry VI. was hereditarily Duke and Count Palatine of Lancaster, and on his attainder, soon after Edward IV.'s accession, the duchy and county were forfeited to the crown, and confirmed on Edward IV.—afterwards on Henry VII. and his heirs for ever. The Queen is now Duchess and Countess Palatine of Lancaster. There is still a chancellor of the duchy and county palatine, whose duties are few and unimportant, but the administration of justice has gradually been assimilated to that of the rest of England. See **LANCASTER**. Chester is supposed to have become a county palatine when made over with regal jurisdiction by William the Conqueror to Hugues d'Avranches. In the reign of Henry III. it was annexed to the crown by letters patent, and since that time the earldom palatine of Chester has been vested in the eldest son of the sovereign, or in the crown, whenever there is no Prince of Wales. Durham seems to have first become a palatinate when William the Conqueror constituted Bishop Walcher Bishop and Duke of Durham, with power (according to William of Malmesbury) to restrain the rebellious people with the sword, and reform their morals with his eloquence. The Palatinate jurisdiction continued united with the bishopric till 1836, when it was separated by act of parliament, and vested in William IV. and his successors as a franchise distinct from the crown, together with all forfeitures, mines, and *jura regalia*. It has since been more completely incorporated with the crown. Pembroke was at one time a county palatine, but ceased to be so in Henry VIII.'s time. The Archbishop of York also exercised the powers of a palatine in the county of Hexham in Northumberland, of which he was deprived in the reign of Elizabeth. In very early times there were a number of similar privileges in Scotland, the most important of which was that of the Earls Palatine of Strathearn. In Germany, the *Pfalzgraf*, or count palatine, exercised a jurisdiction much more extensive than the simple *Graf* or count. A considerable district in Germany was long under the jurisdiction of a count palatine,



who was one of the electors of the empire. See PALATINATE.

**PALATINE HILL** (*Mons Palatinus*), the central hill of the famous seven on which ancient Rome was built, and, according to tradition, the seat of the earliest Roman settlements. In point of historical interest, it ranks next to the Capitol and the Forum. Its summit is about 160 feet above the sea. The form of the hill is irregularly quadrangular. Its north-western slope, towards the Capitoline Hill and the Tiber, was called *Germalus* or *Cermalus*. The origin of the name is uncertain, although several derivations are given connecting it with legendary stories. Romulus is said to have founded the city upon this hill, and on Germalus grew the sacred fig-tree (near to the Lupercal) under which he and his brother, Remus, were found sucking the she-wolf. Upon the P. H. were the temple of Jupiter *Stator*, the temple of Cybele, the sacred square enclosure called *Roma Quadrata*, and other sacred places and edifices, besides many of the finest houses in Rome. Augustus and Tiberius had their residences here, whence Tacitus termed it *spes imperii arx* (the very citadel of government); and at last Nero included it entirely within the precincts of his *aurca domus*, which Vespasian subsequently restricted to the hill. From the time of Alexander Severus it ceased to be the residence of the emperors, but the name *palace* (*palatium*), derived from it, was given to the abodes of sovereigns and great princes, and has been adopted into modern languages. The ruins, or rather the rubbish of the palace, and of numerous ancient edifices, are still strewn over its surface, which is clothed with vineyards and orchards.

**PALAWAN, or PARAGOA**, one of the Philippine Islands (q. v.).

**PALE**, in Heraldry, one of the figures known as ordinaries, consisting of a horizontal band in the middle of the shield, of which it is said to occupy one-third (No. 1). Several charges of any kind are said to be 'in pale' when they stand over each other horizontally, as do the three lions of England. A shield divided through the middle by a horizontal line is said to be 'parted per pale.' The Pallet is the diminutive of the pale, and is most generally not borne singly. No. 2, Or three pallets gules, were the arms of Raymond, Count of Provence. When the field is divided into an even number of parts by perpendicular lines, it is called 'paly of' so many



pieces, as in No. 3, Paly of six argent and gules, the arms of the family of Ruthven. When divided by lines perpendicular and bendways crossing, it is called paly bendy, as in No. 4. An Endorse is a further diminutive of the pallet, and a pale placed between two endorses is said to be endorsed (No. 5).

**PALE**, in Irish history (see IRELAND, HISTORY), means that portion of the kingdom over which the English rule and English law was acknowledged. There is so much vagueness in the meaning of the term, that a few words of explanation appear necessary. The vagueness arises from the great fluctuations which the English authority underwent in Ireland at various periods, and from the consequent fluctuation of the actual territorial limits of the Pale. The designation dates from the reign of John, who distributed the portion of Ireland then nom-

inally subject to England into twelve counties palatine, Dublin, Meath, Kildare, Louth, Carlow, Kilkenny, Wexford, Waterford, Cork, Kerry, Tipperary, and Limerick. To this entire district, in a general way, was afterwards given the designation of the Pale. But as it may be said that the term is commonly applied by the writers of each age to the actual English territory of the period, and as this varied very much, care must be taken to allude to the age of which the name Pale is used. Thus, very soon after the important date of the Statute of Kilkenny, at the close of the reign of Edward III., the English law extended only to the four counties of Dublin, Carlow, Meath, and Louth. In the reign of Henry VI., the limits were still further restricted. In a general way, however, the Pale may be considered as comprising the counties of Dublin, Meath, Carlow, Kilkenny, and Louth. This, although not quite exact, will be sufficient for most purposes.

**PA'LEA** (Lat. chaff), a term employed in Botany to designate the bracts of the *florets* in Grasses (q. v.), called *corolla* by the older botanists; also to designate the small bracts or scales which are attached to the receptacle of the head of flowers in many of the *Compositae* (q. v.). Any part of a plant covered with chafy scales is described as *paleaceous*.

**PALEMBANG**, formerly an independent kingdom on the east coast of Sumatra, now a Netherlands residency, is bounded on the N. by Djambi, N.W. by Bencoolen, S. by the Lampong districts, and S.E. by the Strait of Banca, has an area of 28,140 square miles; and a population amounting, in 1860, to 378,225 souls. Much of the land is low-lying swamp, covered with a wilderness of impenetrable bush; but in the south it rises into mountains, of which Oeloe Moesi is 6180 feet in height. Gold-dust, iron-ore, sulphur with arsenic, lignite, and common coal are found; also clays suited for making coarse pottery, &c. Springs of pure oil occur near the coal-fields of Bali Boekit, and of mineral water in various places. Rice, cotton, sugar, pepper, tobacco, and, in the interior, cocoa-nuts are grown; the forests producing gutta-percha, gum-elastic, ratans, wax, benzoin, satin-wood, &c. The rivers abound with fish; and the elephant, rhinoceros, tiger, panther, and leopard roam the woods, as well as the deer, wild swine, and goats, with many varieties of the monkey.

In the dry season the thermometer ranges from 80° to 92° F., and in the rainy season, 76° to 80°; but the climate is not considered unhealthy, except in the neighbourhood of the swamps. The natives are descended from Javanese, who in the 16th c., or earlier, settled in P., and ruled over the whole land. The race, however, has become mixed with other Malays, and the language has lost its purity. In the north-west interior is a tribe called the Koebos (Kubus), of whose origin nothing is known, but who are probably the remainder of the aborigines. They do not follow after agriculture, go about almost naked, and live chiefly by fishing and hunting. No idea of a Supreme Being seems to be possessed by them, though they believe in existence after death.

**PALEMBANG**, the capital of the kingdom and residency, is 52 miles from the Soensang, or principal mouth of the river Moesi, in 2° 59' S. lat., and 104° 44' E. long. The city is built on both banks of the Moesi, and other streams which fall into it, and is five miles in length by half a mile in breadth. The river is upwards of 1000 feet broad, and from 40 to 50 feet in depth, so that the largest vessels can sail up to the harbour. The native houses are raised on posts, and neatly constructed of planks or bamboos; the Chinese, Arabians, and Europeans, chiefly living in floating

PALENCIA—PALERMO.

houses called rakita, of which there are upwards of 500, and holding communication with one another and with the natives by boats. The fort is built on the left bank of the river, and behind it are an institution for the blind and a splendid mosque. There is a school, where 30 European children are educated, a government elementary school for natives, and several good Chinese schools. Many of the natives can read and write, and in 1856 a native printing-press was erected by Kemas Mohamad Asabel.

The inland trade is considerable, boats from P. exchanging salt, cotton goods, iron, and copper wares, earthenware, provisions, &c., for the produce of the land. In 1855, the number of boats which arrived from the interior amounted to 22,903, about a half fewer than the previous year, bringing 90,830 picols of rice, the picol being nearly 133 lbs.; 32,383 picols of padi; 2344½ of benzoin; 4057½ of gum-elastic; 2245 of gutta-percha; 33,697 of raw cotton; 54,436 bundles of ratans, &c. The foreign trade is large, and chiefly carried on with Java, Banca, Singapore, China, and Siam. In 1859, the imports from Java alone had a value of £172,091 sterling; the exports thither, £75,337. The natives of P. are good ivory carvers, gold and silver smiths, jewellers, cutlers, japanners, painters, boat-builders, bookbinders, &c., and expert at all the ordinary handicrafts. The women, in addition to cotton fabrics, spinning, and dyeing, weave silk stuffs embroidered with gold. Pop. 44,000, of whom 100 are Europeans, 3000 Chinese, and 2000 Arabians.

PALENCIA (the ancient *Pallantia*), a city of Spain, in Old Castile, capital of the modern province of the same name, stands in a treeless, but well-watered and fruitful plain, on the Carrion, 30 miles north-east of Valladolid. It is a bishop's see, and is surrounded by old walls, 36 feet high and 9 feet thick, around which are pleasant promenades. The cathedral, a light and elegant Gothic edifice, was built 1321—1504. The first university founded in Castile was built here in the 10th c., but was removed to Salamanca in 1239. Nearly one-third of the population is employed in the manufacture of blankets and coarse woollen cloths. The position of the town on the Carrion, and on the Castilian Canal, is favourable to the development of commerce. The vine is cultivated, and there is a good trade in wool. Pop. 12,811.

PALENQUÉ, RUINS OF, are on the Rio Chacamas, a branch of the river Usumasinta, in the state of Chiapas, Mexico, 8 miles south-east of the village of Santo Domingo de Palenque, lat. 17° 30' N., long. 92° 25' W. The ruins extend over a large area, covered with a dense tropical forest, and are of difficult exploration. They consist of vast artificial terraces, or terraced truncated pyramids, of cut stone, surmounted by edifices of peculiar and solid architecture, also of cut stone, covered with figures in relief, or figures and hieroglyphics in stucco, with remains of brilliant colours. Most of the buildings are of one story, but a few are two, three, and some may have been four stories. The principal structure, known as the Palace, is 228 feet long, 180 feet deep, and 25 feet high, standing on a terraced truncated pyramid of corresponding dimensions. It was faced with cut stone, cemented with mortar of lime and sand, and the front covered with stucco and painted. A corridor runs around the building, opening into four interior courts, which open into many smaller rooms. On slabs of stone are carved numerous colossal figures, and the remains of statues more resemble Grecian than Egyptian or Hindu art. Other spacious and elaborately ornamented buildings appear to have been temples of

religion. These ruins were in the same condition when Cortez conquered Mexico, as now, overgrown with a forest, and their site forgotten. They were only discovered in 1750. Three explorations were made by the Spanish government, but they were little known until visited by Messrs J. L. Stephens and F. Catherwood, and their account published with plans and drawings. See Stephens's *Incidents of Travel in Central America*, &c., and Catherwood's *Views of Ancient Monuments of Central America*, &c. There are in Mexico dim traditions of the existence, at a remote period, of the capital of a theocratic state, the centre of a long since extinguished civilisation, of which the only traces are these wonderful ruins and unexplained hieroglyphics.

PALE'ERMO, an archiepiscopal city, important seaport, and the capital of the island of Sicily; capital also of the province of the same name, and (according to the latest official statistics) after Naples, the most populous city in the Italian dominions; is situated on the north coast of the island, 135 miles by water west of Messina. Lat. 38° 6' N., long. 13° 20' E. It stands in a highly-cultivated and fertile plain called *La Conca d'Oro* (The Golden Shell), commands a beautiful view of the Gulf of Palermo on which it stands, and is backed toward the interior by ridges of mountains. In shape the town is an oblong parallelogram, the direction of its length being from south-west to north-east. It is divided into four quadrangular parts by two great streets, the beautiful *Via Vittorio Emanuele*, formerly the *Via Toledo* or *Cassaro*, and the *Strada Nuova* or *Macqueda*, which cross each other at right angles in the middle of the city. It is upwards of four miles in circumference, is surrounded by walls pierced with 12 gates and flanked with bastions, and is defended by several batteries. The houses are balconied, flat roofed, and have glass doors instead of windows. The streets, besides the two main thoroughfares already mentioned, are generally well laid out, and there are several fine promenades, of which the famous *Marina*, extending along the shore, on the line of the ancient fortifications, and bordered by the palaces of the nobles, is the most magnificent. P. contains 295 churches, almost all of them rich in decorations and works of art, 38 monasteries, and 25 convents. At the intersection of the two principal streets there is a large octagonal space or *Piazza*, lined with palaces, and adorned with statues and marble fountains. The royal palace is a huge pile of buildings, with a splendid chapel, built in 1129, and contains many pillars of rare workmanship and rich mosaics with Arabic inscriptions. The cathedral is a fine edifice, originally Gothic, but to which incongruous Greek additions have been made, is adorned with marble columns and statues, and contains monuments of the Emperor Frederick II. and of King Roger, the founder of the Norman monarchy in Sicily. Among the principal public institutions of P. are the university, attended in 1861 by 603 students; an academy of arts and sciences, a medical academy, an institution for arts and antiquities, a beautiful and extensive public garden, public libraries, theatres, &c. P. is an archbishop's see, the residence of the governor of the island, and the seat of the supreme courts. Manufactures of silks, cottons, oil-cloth, leather, gloves, &c., are carried on. The harbour is formed by a mole, 1300 feet in length, on which there is a light-house and battery. In 1862, 5559 vessels of 761,702 tons entered and cleared the port, and in the same year the imports amounted to £1,078,840, and the exports to £1,748,480. The climate of P. is one of the most delightful in Europe, being mild

in winter, and pleasantly tempered by sea-breezes in the hot season. Pop. (1864) 187,182.

The environs of P. are interesting as well as picturesque, and embrace many pleasant villas and noble mansions. North-west of the city is Monte Pellegrino, the Eirets of the ancients, an abrupt rocky mass, in which there is a grotto or cave, in which Santa Rosalia, a young Norman princess, lived a life of religious retirement. In P., Santa Rosalia is esteemed more highly than even Santa Maria; the festival in her honour lasts from the 9th to the 13th July, and is the most important festival held on the island. During its celebration the city is illuminated, the streets are gay and brilliant, and there is an immense influx of strangers from the vicinity. But the chief feature of the festival is the procession to the cave. An immense silver image of the saint is borne thither on a wagon, 70 feet long, 30 feet broad, and 80 feet high. Its form resembles that of a Roman galley, with seats for a choir. The wagon is drawn by 56 mules, driven by 28 postillions covered with the gayest trappings.

P., the ancient *Panormus*, was originally a Phœnician colony, but had become a dependency of Carthage before the name occurs in history. With the exception of a short time about 276 B.C., when it fell into the hands of the Greeks, it continued to be the head-quarters of the Carthaginian power in Sicily, until it was taken by the Romans during the First Punic War (254 B.C.), when it became one of the principal naval stations of the Romans. The name Panormus is derived from the excellent anchorage (Gr. *hormos*) in the bay; but the Phœnician name found on coins is *Machanath*, meaning 'a camp.' The Vandals, and afterwards the Arabs, made it the capital of the island, and after the Norman Conquest it continued to be the seat of the king of Sicily. It still remained the royal residence under the Aragonese kings; but the court was removed after Sicily became united to the Kingdom of Naples. See SICILY.

PALESTINE (*Palestina*, *Philistia*), or the HOLY LAND, a country of South-Western Asia, comprising the southern portion of Syria, and bounded on the W. by the Mediterranean, E. by the valley of the Jordan, N. by the mountain-ranges of the Lebanon and the glen of the Litány (Leontes), and S. by the Desert of Sinai; lat. 31° 15'—33° 20' N., long. 34° 30'—35° 30' E. Within these narrow limits, not more than 145 miles in length by 45 in average breadth—an area less than that of the principality of Wales—is comprised the 'Land of Israel' or 'Canaan,' the arena of the greatest events in the world's history. The principal physical features of P. are, (1) a central plateau or table-land, with a mean height of 1600 feet, covered with an agglomeration of hills, which extend from the roots of the Lebanon to the southern extremity of the country; (2) the Jordan valley and its lakes; and (3) the maritime plain, and the plains of Esdrælon and Jericho. On the east, the descent from the central plateau is steep and rugged, from Lake Huleh to the Dead Sea. On the west, it is more gentle, but still well marked, towards the plains of Philistia and Sharon. The ascertained altitudes on this plateau, proceeding from south to north, are Hebron, 3029; Jerusalem, 2610; Mount of Olives, 2724; Mount Gerizim, 2700; Mount Tabor, 1900; Safed, 2775 feet above the sea. Nearly on the parallel of the Sea of Galilee, the range of Carmel extends from the central plateau north-west to the Mediterranean, where it terminates abruptly in a promontory surmounted by a convent. It rises from 600 feet in the west, to 1600 feet in the east, and is composed of a soft white limestone, with many caverns. Beyond the bound-

dary of P. on the north, but visible from the greater part of the country, Mount Hermon rises to 9381 feet, and is always snow-clad. From the formation of the central plateau, the drainage is nearly always east and west, to the Jordan and the Mediterranean. The streams of the plateau are insignificant, and generally dry in summer.

The geological formation of the country consists of jurassic and cretaceous limestone, often covered with chalk, and rich in flints, with occasional interruptions of tertiary, basaltic, and trappean deposits. The upper strata consist of limestone of a white or pale-brown colour, containing few fossils, but abounding in caverns, which form one of the peculiarities of the country. The general features of the landscape exhibit soft rounded hills, separated by narrow gullies or valleys of denudation; the strata are occasionally level, but more frequently violently contorted, as seen on the route from Jerusalem to Jericho, where the fissures are often 1000 feet deep, and only 30 or 40 feet wide. Ironstone occurs in small quantities; rock-salt, asphaltum, and sulphur abound near the Dead Sea, where, as also near the Sea of Galilee, there are many hot springs. Volcanic agency is evident in the obtruded lava of former ages, and in frequent earthquakes of modern times. The vast crevasse through which the Jordan flows, and which cleaves the land from north to south, is one of the most remarkable fissures on the surface of the globe; it is from 5 to 12 miles wide, and of the extraordinary depth of 2630 feet at the bottom of the Dead Sea. Through this the river descends at the rate of 11 feet in a mile, with a course so tortuous that it travels 132 miles in a direct distance of 64, between the Sea of Galilee and the Dead Sea. It is the only perennial river of P., except the Kishon, which is permanent only in its lower course, and the Litány on its northern border. See JORDAN. The only lakes of P. are in the valley of the Jordan. See GENNESARET, SEA OF, and DEAD SEA.

The plain of Philistia extends from the coast to the first rising ground of Judah, about 15 miles in average width; the soil is a rich brown loam, almost without a stone. It is in many parts perfectly level; in others undulating, with mounds or hillocks. The towns of Gaza and Ashdod, near the sea, are surrounded by groves of olives, sycamores, and palms. This plain is still, as it always was, a vast corn-field, an ocean of wheat, without a break or fence; its marvellous fertility has produced the same succession of crops, year after year, for forty centuries without artificial aid. The plain of Sharon is about 10 miles wide in the south, narrowing towards the north, till it is terminated by the buttress of Carmel. Its undulating surface is crossed by several streams; the soil is rich, and capable of producing enormous crops; but only a small portion of it near Jaffa is cultivated, and it is rapidly being encroached on by the sea sand, which, between Jaffa and Cæsarea, extends to a width of 3 miles and a height of 300 feet. The famous ancient cities of this region, Cæsarea, Diospolis, and Antipatria, have vanished. Jaffa (Joppa) alone remains, supported by travellers and pilgrims from the west on the way to Jerusalem. The great plain of Esdrælon, or Jezreel, extends across the centre of the country from the Mediterranean to the Jordan, separating the mountain-ranges of Carmel and Samaria from those of Galilee. Its surface is drained by the Kishon, which flows west to the Mediterranean at Haifa. The plain is surrounded by the hills of Gilboa and Little Hermon; the isolated Mount Tabor rises on its north-east side. It is extremely fertile in grain where cultivated, and covered with gigantic thistles where neglected. It is richest in the

central part, which slopes east to the Jordan—the battle-field where Gideon triumphed, and Saul and Jonathan were overthrown. It is the home of wandering Bedouins, who camp in its fields, and gallop over its green-sward in search of plunder. Many places of deep historical interest are connected with this plain. Shunem, Nain, Endor, Jezreel, Gilboa, Bethshan, Nazareth, and Tabor are all in its vicinity. The plain of Jericho is a vast level expanse, covered with the richest soil, now quite neglected. Around the site of Jericho, 'the city of palm-trees,' there is not now a single palm; but a recent experiment proved its capability of producing in abundance all the crops for which it was formerly famous. The climate of P. is very varied; January is the coldest and July the hottest month. The mean annual temperature of the year at Jerusalem is 65° Fahr., resembling that of Madeira, the Bermudas, and California. The extreme heat of the summer months is modified by sea-breezes from the north-west. In the plain of Jericho and the Jordan valley it is extremely hot and relaxing. The *sirocco*, a south-east wind, is often oppressive in early summer. Snow falls in the uplands in January and February, and thin ice is often found at Jerusalem, where the annual rainfall is 61 inches. Heavy dews fall in summer, and the nights are cold. Violent thunder-storms occur in winter. In the south, Judah and part of Benjamin, is a dry parched land; the bare limestone rock is covered here and there with a scanty soil, and the vast remains of terraces shew how assiduously it must have been cultivated in ancient times to support the teeming population indicated by the ruins of cities with which every eminence is crowned. To the north of Judea the country is more open, the plains are wider, the soil richer, and the produce more varied, till at Nablous the running streams and exuberant vegetation recall to the traveller the scenery of the Tyrol. Even in its desolation, P. is a land flowing with milk and honey. There is no evidence of its climate having changed or deteriorated, nor any reason to suppose that it would fail to support as great a population as ever it did, provided the same means as formerly were used for its cultivation. It has the same bright sun and unclouded sky, as well as the early and latter rain, which, however, is diminished in quantity, owing to the destruction of trees.

The botany of P. is rich and varied, resembling that of Asia Minor. Among its trees are the pine, oak, elder, and hawthorn in the northern and higher districts, and the olive, fig, carob, and sycamore elsewhere. The cultivated fruits are the vine, apple, pear, apricot, quince, plum, orange, lime, banana, almond, and prickly pear. Wheat, barley, peas, potatoes, and European vegetables, cotton, millet, rice, maize, and sugar-cane are among its products. The date now ripens its fruit only in the south and on the sea-board. The brilliant flowers which in spring enamel the surface and tinge the entire landscape, comprise the adonis, ranunculus, mallow, poppy, pink, anemone, and geranium. In the Jordan valley, 900 or 1000 feet below the sea-level, the vegetation is tropical in its character, resembling that of Arabia; the nubk (*Spina Christi*), the oleander, and the small yellow 'apples of Sodom' are conspicuous. The most valuable products of the vegetable kingdom are derived from the vine, fig, olive, and mulberry trees. Wine for home use is made in all the central and southern districts; the best is made at Hebron from the grapes of Eshcol. Olive oil is a valuable export.

The wild animals of P. comprise the Syrian bear in Lebanon, the panther, jackal, fox, hyena, wolf, wild boar, gazelle, and fallow-deer; the lion is now unknown. The domestic animals are the Arabian

camel, ass, mule, horse, buffalo, ox, and broad-tailed sheep. Among the birds are the eagle, vulture, kite, owl, nightingale, jay, and kingfisher—the latter of brilliant plumage—the cuckoo, heron, stork, crow, partridge, and sparrow. Fish swarm in the Sea of Galilee, and bats and lizards abound.

The divisions of P. in Old Testament times were into 9½ tribes in the west, and 2½ tribes in the east of the Jordan. In New Testament times, on the west of the Jordan the provinces of Galilee in the north, Samaria in the middle, and Judea in the south; on the east of the Jordan, Perea and Decapolis. The boundaries of the tribes and provinces are very uncertain. Its modern divisions have changed with every new race and dynasty of conquerors. Under Turkish rule, the whole of P. Proper (west of the Jordan) is comprised in the pashalic of Sidon; the pasha resides at Beyrout, and to him the pasha of Jerusalem is subordinate. The present population is very mixed, comprising Syrians, Mohammedans, Maronites, Druses, Christians, Jews, and Turks. The Jews are all foreigners, almost exclusively inhabiting the four holy cities—Jerusalem, Hebron, Tiberius, and Safed; their whole number was, in 1863, estimated at only 9000. The country is oppressed by Turkish avarice, and over-run by the predatory Arabs. See SYRIA.

PALESTRINA (the ancient *Præneste*), an episcopal city of the States of the Church, Italy, in the Comarca di Roma, and 22 miles east-south-east of Rome, occupies a strong position on the south-west slope of a high hill, an offset of the Apennines. Besides several interesting churches, the town contains a castle, once the chief stronghold of the Colonna, to whom the town belonged; and the palace and garden of the Barberini family. The view across the Campagna and toward the Alban Hills is magnificent. Pop. 4700, who manufacture coarse woollen goods.

P. is built almost entirely upon the site and the gigantic substructions of the Temple of Fortune, one of the great edifices of the former city of Præneste. This city was one of the most ancient as well as powerful and important cities of Latium. It covered the hill (2400 feet above sea-level) on the slope of which the modern town stands, and was overlooked by a citadel of great strength. The site of this citadel on the summit of the hill is now occupied by a castle of the middle ages, called *Castel S. Pietro*; but remains of the ancient walls are still visible. We first hear of Præneste as a member of the Latin League; but in 499 B.C. it quitted the confederacy, and joined the cause of the Romans. In 380 B.C., the Prænestines, having rejoined their ancient allies, opened a war with Rome; but were completely routed on the banks of the Allia by T. Quintius Cincinnatus, and beaten back to their own gates. They took a prominent part in the famous Latin War, 340 B.C. Having given shelter to the younger Marius in the year 82 B.C., this city was besieged by the forces of Sulla, and on its being taken all the inhabitants were put to the sword. A military colony was then established in their place, and soon the city began to flourish anew. Its elevated and healthy situation, at no great distance from the capital, made it a favourite place of resort of the Romans during summer. Augustus frequented it; Horace often found this city a pleasant retreat; and here Hadrian built an extensive villa. The Temple of Fortune is described by Cicero as an edifice of great antiquity as well as splendour, and its oracle was much consulted. The town became the stronghold of the family of Colonna in the middle ages; but was given to the Barberini family by Urban VIII.

**PALESTRINA, GIOVANNI PIERLUIGI DA**, a distinguished musical composer of the 16th century. He derived his surname from the town of Palestrina, in the Roman States, where he was born in 1524. At the age of sixteen, he went to Rome, and studied music under Claude Goudimel, afterwards one of the victims of the St Bartholomew massacre. In 1551 he was made *maestro di capella* of the Julian Chapel, and in 1554 he published a collection of Masses, so highly approved of by Pope Julius III., to whom they were dedicated, that he appointed their author one of the singers of the pontifical chapel. Being a married man, he lost that office on the accession to the pontificate of Paul IV., in whose eyes celibacy was a necessary qualification for its duties. In 1555 he was made choir-master of St Maria Maggiore, and held that position till 1571, when he was restored to his office at St Peter's. In 1563, the council of Trent having undertaken to reform the music of the church, and condemned the profane words and music introduced into masses, some compositions of P. were pointed to as models, and their author was intrusted with the task of remodelling this part of religious worship. He composed three masses on the reformed plan; one of them, known as the Mass of Pope Marcellus (to whose memory it is dedicated), may be considered to have saved music to the church by establishing a type infinitely beyond anything that had preceded it, and, amid all the changes which music has since gone through, continues to attract admiration. During the remaining years of his life, the number and the quality of the works of P. are equally remarkable. His published works consist of 13 books of Masses, 6 books of Motets, 1 book of Lamentations, 1 book of Hymns, 1 book of Offer-tories, 1 book of Magnificats, 1 book of Litanies, 1 book of Spiritual Madrigals, and 3 books of Madrigals. P. must be considered the first musician who reconciled musical science with musical art, and his works form a most important epoch in the history of music. Equally estimable in private life, and talented as a musician, P. struggled through a life of poverty during eight pontificates; his appointments were meagre, and his publications unremunerative. He died in 1594. A memoir of his life and writings has been written by the Abbé Baini.

**PALESTRO**, a village of Piedmont, 8 miles south-east of Vercelli, famous as the scene of a battle between the Sardinians and Austrians in May 1859. On the 30th of that month the Piedmontese drove the Austrians from this village, and on the 31st defended it with great bravery against an Austrian attack. The Piedmontese in the battle of the 31st were assisted by 3000 French Zouaves, and on that occasion the Austrians lost 2100 men killed and wounded, 950 prisoners, and 6 pieces of cannon. On June 1st the allies entered Novara.

**PALETTE**. See PAINTING.

**PALEY, DR WILLIAM**, a celebrated English divine, was born at Peterborough in 1743. His father was a Yorkshireman, and not long after P. was born returned to his native parish of Giggleswick, one of the wildest and most sequestered districts in the West Riding, to become master of the grammar-school there. Young P. was brought up among the shrewd, hard-headed peasantry of Yorkshire; and it is probable that he either naturally possessed, or insensibly acquired their moral and mental characteristics. At all events, he soon became conspicuous in the family for his good sense; and when he left to enter Christ's College, Cambridge, as a sizar, in his sixteenth year, his father said: 'He has by far the clearest head I ever met with.' At Cambridge, P. led for the first

two years a gay, idle, and dissipated life, but thereafter became a severe student, and took his bachelor degree in 1763 with highest honours. He then taught for three years in an academy at Greenwich. In 1765 he obtained the first prize for a prose Latin dissertation—the subject being 'A Comparison between the Stoic and Epicurean Philosophy with respect to the Influence of each on the Morals of a People,' in which he characteristically argued in favour of the latter. Next year he was elected a Fellow and Tutor of Christ's, and also took the degree of M.A. In 1767 he was ordained a priest. His career as a college tutor, which lasted about ten years, was eminently successful; and it appears to have been during this period that he systematised his principles in moral and political philosophy. In 1776, P. married, and was of course obliged to give up his fellowship, but was compensated by a presentation to the livings of Mosgrove and Appleby in Westmoreland and of Dalston in Cumberland. Four years later he was collated to a prebendal stall in the cathedral church of Carlisle, in 1782 he became archdeacon, and in 1785 chancellor of the diocese. The last of these years witnessed the publication of his *Elements of Moral and Political Philosophy*. In this work he propounds his ethical theory, which is commonly called utilitarianism, but is really a mixture of utility and theology. He begins by renouncing the favourite doctrine of the Moral Sense, against which he adduces a series of strong objections. He then takes up the question of the source of obligation, and resolves it into the will of God, enforced by future punishment, admitting candidly that virtue is prudence directed to the next world. The will of God, in so far as it is not rendered explicit by revelation, is to be interpreted by the tendency of actions to promote human happiness; the benevolence of the Deity being supposed. Objection has frequently been taken to the principles on which P. rests his system, but the lucidity and appositeness of his illustrations are beyond all praise. If his treatise cannot be regarded as a profoundly philosophical work, it is at any rate one of the clearest and most sensible ever written, even by an Englishman; and if it failed to sound the depths of 'moral obligation,' it at least brushed off into oblivion the shallow and muddy mysticism that had long enveloped the philosophy of politics. P.'s plain sarcastic view of the 'divine right of kings,' which he puts on a level with the 'divine right of constables,' gave extreme offence to George III., but was nevertheless much admired by not a few of his majesty's subjects, and is now held by everybody to be beyond question. In 1790 appeared his most original and valuable work—the *Horæ Paulinæ, or the Truth of the Scripture History of St Paul evinced by a Comparison of the Epistles which bear his Name with the Acts of the Apostles, and with one another*. The aim of this admirable work is to prove, by a great variety of 'undesigned coincidences,' the improbability, if not impossibility, of the usual infidel hypothesis of his time—viz., that the New Testament is a 'cunningly-devised fable.' It was dedicated to his friend John Law, then Bishop of Killala in Ireland, to whose favour he had been indebted for most of his preferments. P.'s next important work was entitled *A View of the Evidences of Christianity*, published in 1794. It is not equal in originality to its predecessor, but the use which the author has made of the labours of such eminent scholars as Lardner and Bishop Douglas is generally reckoned most dexterous and effective. Later and keener criticism is indeed anything but satisfied with P.'s 'Evidences;' but in P.'s own day he was held to have achieved a splendid triumph over

sceptics, and was handsomely rewarded. The Bishop of London appointed him a prebend of St Pancras; shortly after he was promoted to the subdeanery of Lincoln (worth £700 per annum); Cambridge conferred on him the degree of D.D.; and the Bishop of Durham the rich rectory of Bishop Wearmouth (worth £1200 per annum), in consequence of which he honourably resigned his livings in the diocese of Carlisle. After 1800 he became subject to a painful disease of the kidneys, but notwithstanding he continued to write, and in 1802 published perhaps the most widely popular of all his works, *Natural Theology, or Evidences of the Existence and Attributes of the Deity*, which, however, is based, and to a large extent borrowed from the *Religious Philosopher*, the work of a Dutch philosopher named Nieuwentyt, an English translation of which appeared in 1718—1719. The plagiarisms are most palpable, but have been accounted for on the supposition that the *Natural Theology* was 'made up' from his loose papers and notes written when P. was a college tutor, and that he had forgotten the sources from which he derived them. It is also but fair to state that he has taken nothing which he has not greatly improved; *nihil tetigit, quod non ornavit*. A somewhat noted edition of this work, enriched, or at least expanded by annotations and dissertations, is that by Lord Brougham and Sir Charles Bell (1836—1839). P. died May 25, 1805. He had a family of four sons and three daughters. A complete edition of his works was published in 1838 by one of his sons, the Rev. Edmund Paley. The best biography is that by Meadley (1809).

PALGRAVE, SIR FRANCIS, a distinguished antiquary and historian, was born in London in July 1788, of Jewish parentage, being the son of Mr Meyer Cohen, a member of the Stock Exchange. He was educated at home under a Dr Montuoci, and even when a child shewed extraordinary genius. When only eight years old, he made a translation into French of the *Battle of the Frogs and Mice* from the Latin version of Beauclerc, which was printed by his father in 1797. In 1803 he was articled as a clerk to a legal firm, and at the expiration of his articles, continued with the same firm as managing clerk until 1822, when he took chambers in the Temple, and was employed under the Record Commission. He had previously made himself known as a literary antiquarian, by the publication, in 1818, of some Anglo-Norman Chansons, which he edited with much care. On the occasion of his marriage in 1823, he changed his name of Cohen to P., that being the maiden name of his wife's mother. He was called to the bar in 1827, and had considerable practice for some years in pedigree cases before the House of Lords. In 1831 he published a *History of England*, which formed a part of the *Family Library*; and in 1832 appeared his *Rise and Progress of the English Commonwealth*; also *Observations on the Principles, &c., of New Municipal Corporations*. In that year he received the honour of knighthood, and was subsequently one of the Municipal Corporation Commissioners. In 1835, the Commissioners issued their Report, which was signed, however, by only sixteen of the members—Sir F. P. being one of the four dissentients. In the same year he published a 'Protest' against the Commissioners' Report, in which he called in question several of its statements, views, and arguments. In 1838, on the reconstruction of the Record Service, Sir F. P. was appointed deputy-keeper of Her Majesty's Records, and held that office during the rest of his life. Besides the works already mentioned, Sir F. P. edited for the government the following: *Calendars of the Treasury of the Exchequer, Parliamentary*

*Writs, Ouria Regis Records, and Documents Illustrative of the History of Scotland*. In his private capacity, he produced the *Merchant and the Friar*, an imaginary history of Marco Polo and Friar Bacon; also a *Hand-book for Travellers in Northern Italy*, and a *History of England and Normandy*. Of this last work a volume appeared in 1851, and a second in 1857; and it is understood that there are materials existing in MS. for a third and fourth volume. Sir F. P. also wrote numerous articles for the *Edinburgh* and *Quarterly Reviews*, principally of an antiquarian character, but some of them purely literary or artistic. His great merit, in his historic writings, consists in the extensive use made by him of original documents, by aid of which he not only himself very much enlarged our acquaintance with the history and social aspects of the middle ages, but pointed out to others the advantage to be derived from a careful study of the original sources of information now known to abound among our public records. Sir F. P. died at Hampstead, on the 6th of July 1861.

PĀLI (a corruption of the Sanscrit *Prākṛit*, q. v.) is the name of the sacred language of the Buddhists. Its origin must be sought for in one or several of the popular dialects of ancient India, which are comprised under the general name of *Prākṛit*, and stand in a similar relation to Sanscrit as the Romance languages, in their earlier period, to Latin. It has been formerly assumed that P. arose from the special *Prākṛit* dialect called *Māgadhī*, or the language spoken in Magadha; but, according to the view expressed by Lassen in his *Indische Alterthumskunde*, an hypothesis of this kind is not tenable, since the peculiarities of this dialect are not compatible with those of the P. language. The same distinguished scholar holds that the *Prākṛit* dialects, called the *Sauraseni* and *Māhārāshṭrī*, have a closer relation to the P. than any other, and that the origin of the latter must therefore be traced to the country of Western Hindustan, between the Jumna river and the Vindhya mountain; though he observes, at the same time, that the P. is older than these dialects, and that the latter are therefore more remote from Sanscrit than the former. Whether the oldest works of the Buddhist religion were written in P. may be matter of doubt. It is more probable, on the contrary, that the language in which the founder of the Buddhist religion conveyed his doctrine to the people was not yet that special language, but a mixture of classical and popular Sanscrit, such as it still appears in the Buddhist *Sūtras*. At a later period, however, P. became the classical language in which the Buddhists wrote their sacred, metaphysical, and profane works. The most important historical work written in this language is the *Mahāvansā* (q. v.); other P. works, which have lately become known in Europe, and deserve especial mention, are the *Dhammapada*, on the Buddhist doctrine, and five *Jātakas*, containing a fairy tale, a comical story, and three fables—both works edited and translated by V. Fausbøll (Copen. 1855 and 1861). P. ceased to be a living language of India when Buddhism was rooted out of it; it was carried by the fugitive Buddhists to other countries, especially Ceylon, Burmah, and Siam; but in these countries, too, it had to give way before the native tongues, in which the later Buddhist literature was composed.

PALIMPSEST (Gr. *palimpsestos*, 'rubbed a second time'), the name given to parchment, papyrus, or other writing material, from which, after it had been written upon, the first writing was wholly or in part removed for the purpose of the page being

written upon a second time. When the MS. had been written with one species of ink employed by the ancients, which was merely a fatty pigment, composed chiefly of lampblack, and only colouring the surface, but not producing a chemical change, there was little difficulty in obliterating the writing. It was accomplished by the use of a sponge, and, if necessary, of a scraper and polishing tool; and, where proper pains were taken, the erasure of the first writing was complete. But when the ink was mineral, its effect reached beyond the surface. In that case a scraping-tool or pumice-stone was indispensable; if these were hastily or insufficiently applied, the erasure was necessarily imperfect; and thus it often happens in ancient MSS. that, from the want of proper care on the part of the copyist in preparing the parchment for re-writing, the original writing may still be read without the slightest difficulty.

The practice of re-preparing used parchment for second use existed among the Romans. The material thus re-prepared was of course reserved for the meaner uses. We meet frequent allusions in the classical writers, as Plutarch, Cicero (*Ad Familiares*, vii. 18), Catullus (xxii. 115), and others, to the palimpsest, in the sense of a blotter or first draft-book, on which the rough outline or first copy of a document was written, preparatory to the accurate transcript which was intended for actual use; and it appears equally certain that in many cases whole books were written upon re-prepared parchment or papyrus, not only among the Greeks and Romans, but also among the ancient Egyptians.

Of palimpsests of the classic period, however, it is hardly necessary to say no specimen has ever been discovered. It is to the necessities of the mediæval period that literature owes the unquestionably important advantages which have arisen from the revival of the ancient practice of re-preparing already used material for writing. Under the early emperors, the intercourse with Egypt and the east secured a tolerably cheap and abundant supply of Papyrus (q. v.), which rendered it unnecessary to recur to the expedient of the palimpsest; and this became still more the case in the 5th and 6th centuries, when the tax on papyrus was abolished. But

after the separation of east and west, and still more after the Mohammedan conquest of Egypt, the supply of papyrus almost completely ceased; and from the 7th c. in the west, and the 10th or 11th in the east, the palimpsest is found in comparatively frequent use; and its frequency in the 15th c. may be estimated from the fact that some of the earliest books were printed on palimpsest. Some writers have ascribed the prevalence of its use to the indifference, and even to the hostility of the monks and clergy to classical literature, and have attributed to their reckless destruction of classic MSS., in order to provide material for their own service-books and legends, the deficiencies in the remains of ancient learning which scholars have now to deplore. That some part of the loss may have so arisen, it is impossible to doubt, although it is equally certain that we owe to the mediæval monks and clergy whatever of ancient literature has been preserved to our day. But the condition in which the existing palimpsests are uniformly found—for the most part mere fragments of the ancient writers whose works they originally contained—goes far in itself to shew that the MSS. which were broken up by the mediæval copyists, for the purpose of being re-written, were almost always already imperfect, or otherwise damaged; nor is there anything in the condition of any single palimpsest which has reached our day to justify the belief, that when it was taken up for the purpose of rescription, the original work which it contained was in a state at all approaching to completeness. Fortunately, however, there are many of the relics of ancient learning of which even the mutilated members have an independent value; and this is especially true of Biblical MSS., particularly under the critical aspect, and in a still broader sense, of all the remains of the ancient historians.

It will easily be understood, therefore, that the chief, if not the sole interest of palimpsest MSS. lies in the ancient writing which they had contained, and that their value to literature mainly depends on the degree of legibility which the ancient writing still retains. It is difficult to make this fully intelligible to the reader without an actual inspection, but the facsimile which is annexed will furnish a sufficient idea. The particular passage

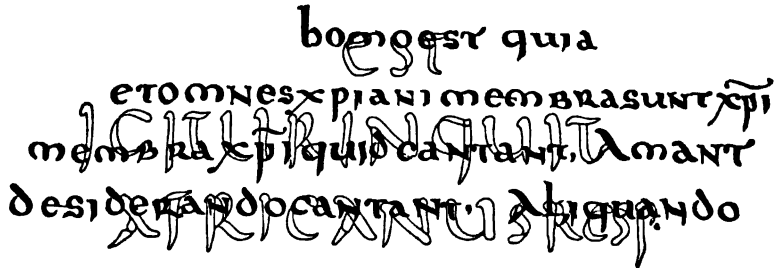

selected for the illustration is from page 62 of the Vatican MS., from which Mai deciphered the fragments of the *De Republica*. The darker letters are those of the modern MS.; the faint lines are, as may be supposed, those of the original codex. Although so much more faint than the modern writing, they can be read with facility on account of their greater size. We shall transcribe both texts in ordinary characters. The original was as follows:

EST  
 IGITUR INQUIT  
 AFRICANUS RESP.

(The ordinary contraction for *Respublica*.)

The corresponding lines of the modern MS., which

is from St Augustine's commentary on the Psalms, are—

homo est quia  
 et omnes xpiani (Christiani) membrasunt xpiani (Christi)  
 membra xpiani. quid cantant. Amant  
 Desiderando cantant. Aliquando

In this specimen, as very commonly occurs, the original writing is much larger than the modern; the modern lines and letters do not cover those of the old MS., but they follow the same order. In other specimens the new writing is transverse; in some, the old page is turned upside down. Sometimes, where the old page is divided into columns, the new writing is carried over them all in a single

line; sometimes the old page is doubled, so as to form two pages in the new MS. Sometimes it is cut into two, or even three pages. The most perplexing case of all for the decipherer is that in which the new letters are of the same size, and are written upon the same lines with those of the original MS. Examples of this are rare, and even when they occur, the difference between the form of the ancient characters, which are ordinarily uncial, and that of the modern, is in itself a great aid to the decipherer. Some variety, also, is found in the language of the palimpsests. In those which are found in the western libraries, the new writing is almost invariably Latin, while the original is sometimes Greek, and sometimes Latin. In the palimpsests discovered in the east, the original is commonly Greek, the new writing being sometimes Greek, sometimes Syriac, sometimes Armenian; and one palimpsest, the material of which is papyrus, is found in which the original was the enchorial Egyptian language, while the modern writing is Greek.

The possibility of turning palimpsest MSS. to account as a means of extending our store of ancient literature, was suggested as far back as the days of Montfaucon; but the idea was not turned to practical account till the latter part of the 18th century. The first palimpsest editor was a German scholar, Dr Paul Bruns, who having discovered that one of the Vatican MSS. was a palimpsest, the effaced matter of which was a fragment of the 91st book of Livy's *Roman History*, printed it at Hamburg in 1773. In the field of discovery thus opened by Bruns but little progress was made until the following c., when Dr Barrett of Trinity College, Dublin, published his palimpsest Fragments of St Matthew, and when palimpsest literature at once rose into interest and importance in the hands of the celebrated Angelo Mai (q. v.). A detailed account of Mai's successes will be given hereafter, when we shall enumerate the principal publications in this curious department of letters; and under his own name will be found the history of his personal labours. The great historian Niebuhr about the same time applied himself to the subject, and was followed by Blume, Pertz, Gaupp, and other German scholars, whose labours, however, were for the most part confined to the department of ancient Roman law. More recently, the discoveries of Dr Tischendorf in Biblical literature, and those of Dr Cureton as well in sacred as in profane literature, have contributed still more to add importance to the palimpsest MSS. which have been supposed to exist in the monasteries of the Levant. Herr Mone has had similar success in the department of liturgical literature, and Dr Frederick Augustus Pertz, son of the scholar already mentioned, may be said to have carried to its highest point the interest which attaches to these curious researches, by editing from a *thrice written palimpsest* a very considerable series of fragments of the Roman annalist, Gaius Granius Licinianus.

It remains to enumerate briefly the most important palimpsest publications which have hitherto appeared, distributed according to the language of the effaced original.

**I. GREEK PALIMPSESTS.**—Among these, the first place of course belongs to the Greek Biblical palimpsests, the earliest of which was (1) *Fragments of the Gospel of St Matthew*, in facsimile as well as in ordinary type, printed from a palimpsest MS. of Trinity College, Dublin, by the Rev. I. Barrett, D.D. (4to, Dublin, 1801). The original writing appears to be of the 6th century. Dr Barrett's transcript of the text has not proved in all respects correct, but the original has since been carefully re-examined, and

the ancient writing fully brought out. It is chiefly, however, to a collection of Syriac MSS. brought from the east that we are indebted for the more recent palimpsest restorations of the ancient Biblical readings. In this line the chief discoverer has been Dr Constantine Tischendorf. From his pen we have (2) the celebrated *Codex Ephremi* or *Codex Regius* of the Royal Library at Paris. This MS. had been early observed to be palimpsest, and the original Greek text was collated in part by Wetstein and by Kuster. It was still more carefully examined by M. Hase in 1835; and finally, in 1840, by Dr Tischendorf, by whom the New Testament was printed in 1843, and the fragments of the Old in 1845. The modern writing of this palimpsest consisted of the works of St Ephrem the Syrian. (3) *Fragmenta Sacra Palimpsesta* (4to, Leipzig, 1855), containing fragments of the Books of Numbers, Deuteronomy, Joshua, Judges, Kings, Isaiah, together with 48 pages of fragments of the New Testament, the Gospels, the Acts, and the Epistles of St Paul to the Corinthians and to Titus. The modern writing of these palimpsests was partly Greek, partly Armenian, and Arabic. (4) *Fragmenta Evangelii Lucae et Libri Genesis* (4to, Leipzig, 1857). The fragments of St Luke's Gospel amount to 95 pages: The volume also contains fragments of St John's Gospel and of Ezekiel and the Third Book of Kings. The modern writing is partly Syriac, partly Coptic. Along with these Biblical palimpsests (5) may be classed another, the original of which, however, contains not only some Greek fragments, but also portions of the ancient Gothic version of the Bible by Ulphilas. The MS. from which this is taken is known from its place in the Wolfenbüttel Library as the *Codex Guelpherbytanus*. It was first noticed in 1755 by Knittel, by whom a portion of the Gothic version was published in 1762. These fragments were reprinted in 1772, and again in 1805. The modern writing of the MS. consisted of the *Origines* of Isidorus Hispalensis. A large addition to the text of Ulphilas was made in 1817 by Mai and Castiglione, from palimpsests discovered in the Ambrosian Library at Milan; and the whole have since been combined into one edition by Dr Gabelentz, and finally by Dr Massmann (4to, Stuttgart, 1855). We may also mention under the same head some interesting Greek liturgical remains edited by F. I. Mone (Frankfort, 1850), from a palimpsest discovered at Carlsruhe.

In Greek classical literature, also, we owe something to the labours of palimpsest editors. From one of the Syriac MSS. already referred to, Dr Cureton has edited large fragments of the *Iliad* of Homer, amounting in all to nearly 4000 lines; and although all these, it need hardly be said, were known before, yet the text is of the utmost value as a source of criticism, being certainly of much greater antiquity than the very earliest known MSS. of the *Iliad*. A still larger and more original contribution to Greek classical literature was made by Mai in the 5th volume of his *Scriptorum Veterum Nova Collectio* (Rome, 1831—1838). From a very large palimpsest discovered in the Vatican Library he has printed in this volume copious fragments of almost all the Greek writers on Roman history—from the lost books of Polybius no less than 100 4to pages; 130 pages of Diodorus Siculus; 64 of Dionysius of Halicarnassus; 100 of Dion Cassius; together with considerable fragments of Appian, Iamblichus, Dexippus, Eunapius, and others. This is, perhaps, after the *De Republica* of Cicero, the most important accession to the existing store of classic learning which the palimpsests have hitherto supplied.

**II. LATIN PALIMPSESTS.**—(1.) The earliest frag-



ment of Latin literature, printed from a palimpsest original, is the portion of the 91st book of *Livy* already referred to, published at Hamburg and also at Rome in 1773. It was re-edited in a more complete form by Niebuhr in 1820. (2.) Of the Latin palimpsests edited by Mai, the earliest were some fragments of lost Orationes of Cicero from two different palimpsests in the Ambrosian Library at Milan, in the latter of which, the second writing consisted of the acts of the council of Chalcedon. These Orationes were published in two successive volumes in 1814. (3.) Eight Orationes of Symmachus (1815). (4.) The Comedies of Plautus, including a fragment of the lost play entitled *Vidularia* (1815). (5.) The works of M. Corn. Fronto, together with the Epistles of Antoninus Pius, Lucius Verus, M. Aurelius, and others (1815). (6.) The celebrated Dialogue of Cicero, *De Republica*, from a palimpsest of the Vatican, the modern writing of which is the commentary of St Augustine on the Psalms. There is none of Mai's publications which presents his critical abilities in so favourable a light as this precious volume, which appeared at Rome in 1821. (7.) Soon after the *De Republica* he published another volume from palimpsest sources, the most important of whose contents were some fragments of ancient Roman law, which prepared the way for the more distinguished success of Niebuhr; who, in a palimpsest of the library of Verona, recognised a portion of (8) the *Institutiones* of Gaius, and procured an accurate transcript for the press, which was printed at Berlin in 1820. The latest considerable Latin publication in this department is (9) *Gaii Gracii Liciniani Annalium quæ supersunt* (Berlin, 1857), edited from a palimpsest of the British Museum by the younger Pertz. This palimpsest, as was already stated, is a thrice written codex, the earliest and original contents being the *Annales* of Gaius Gracianus. The second writing was also in Latin, and the work is a grammatical treatise, of which the chapters *De Verbo* and *De Adverbio* are still legible. The most modern writing is Syriac, written in the cursive character. Gaius Gracianus is a writer named by Macrobius, of whom nothing else is known.

It will be gathered from the above that the ancient works recovered by means of palimpsest MSS. are all fragmentary, and one is naturally led to rate at a low value the result thereby obtained. But it must be remembered that in some of the departments to which these fragments belong, every scrap, no matter how trifling, has an independent value. So it is, for example, in Biblical remains—a single text may present a valuable reading, the mere fragment may throw light on an important critical question. In history, in like manner, a small fragment may disclose an interesting fact, or supply a significant commentary upon facts otherwise ascertained. And as regards critical uses especially, it must not be forgotten that the obliterated text of the palimpsest MSS., for the most part, far exceeds in antiquity the very oldest known codices which we possess, and is, probably, second only in age to the papyri of Herculaneum.

The method of treating palimpsest MSS., with a view to deciphering their contents, has been fully described by different editors. Mai, after having washed the palimpsest with an infusion of galls, exposed it to the light and air, and, generally speaking, found this sufficient for his purpose. Peyron washed the parchment in water, afterwards in dilute muriatic acid, and finally in prussiate of potash. A mixture, compounded on this principle, is called from its inventor, M. Gioberti, *Tinctura Giobertina*. Sometimes the same treatment does not succeed equally well on both sides of the parch-

ment; the inner surface, from its softer texture, sometimes requiring a more active preparation. When the ink contained animal substances, as milk, or the blood of the cuttle-fish, Dr Mone plunged the parchment in a close vessel filled with oil, which he heated to a temperature of 400° R. In the prefaces of Mai's volumes will be found many amusing and interesting facts illustrating the difficulties which attend this curious branch of literary labour.

**PA'LINDROME** (Gr. *palin*, backwards, and *dromos*, a running), the name given to a kind of verse very common in Latin, the peculiarity of which is that it may be read the same backwards as forwards. A few examples will suffice.

*Si bene te tua larva taxat sua larvæ tenebris.  
Et necat eger amor non Roma rege tacente,  
Roma reges una non anus eger amor.*

A Roman lawyer gets the credit of the following :

*Si nummi immunitis,*

which Camden translates :

'Give me my fee, and I warrant you free.'

It is said that in the reign of Queen Elizabeth a certain lady of rank, having been compelled to retire from the court on account of some *fama*, the truth of which she denied, took for her motto :

*Ablata at alba.*

'Retired but pure.'

The English language has few palindromes, but one at least is inimitable. It represents our first parent politely introducing himself to Eve in these words :

'Madam, I'm Adam.'

Compare Henry B. Wheatley's book on *Anagrams* (1862).

**PALINGENE'SIA** (Gr. *palin*, again, and *genesis*, birth) is a term that appears to have originated among the Stoics, who employed it to denote the act of the Demiurgus, or Creator, by which, having absorbed all being into himself, he reproduced it in a new creation. The occurrence of the word in the New Testament (Titus, iii. 5, where it is used to denote regeneration) has given it a place in Christian theology, and divines have variously used it to express the resurrection of men, the new birth of the individual soul, and the restoration of the world to that perfect state that it lost by the Fall—'the new heavens and the new earth wherein dwelleth righteousness.' Savans have also applied the term to designate both the great geological changes which the earth has undergone and the transformations in the insect kingdom, such as of caterpillars into butterflies, &c.

**PA'LNODE**, in the law of Scotland, is a peculiar practice by which, in actions for damages on account of slander or defamation raised in the Commissary Court, and even in the Sheriff Court, the pursuer may conclude not only for damages but for palinode, i. e., a solemn recantation. On a recent case, the question arose whether this ancient practice still existed as part of the law of Scotland, and it was held that it did. In actions, however, in the Court of Session, damages only are given as the remedy.

**PA'LISADE**, a paling of strong timber, used in Fortification. For the mode in which the palisade is employed see **FORTIFICATION**, under the head *Stockade*.

**PALISANDER WOOD**, the continental name for Rosewood (q. v.). By some of the French cabinet-makers the name *bois de Palisandre* is also

applied to violet wood and to a kind of striped ebony.

**PALISSY, BERNARD**, a French potter, famous for his glass paintings and beautiful figured pottery, was born near Agen, now in the department of Lot et Garonne, France, about 1510, and at an early age was apprenticed to a potter. He devoted himself to chemical researches for the improvement of his art, and made many journeys through France and Germany for the same purpose; at the same time carrying on the business of a land-surveyor. An enamelled cup of 'Faience,' which he saw by chance, inspired him with the resolution to discover the mode of producing white enamel. Neglecting all other labours, he devoted himself to investigations and experiments for the long period of 16 years. He had by this time exhausted all his resources, and for want of money to buy fuel was reduced to the necessity of burning his household furniture piece by piece; his neighbours laughed at him, his wife overwhelmed him with reproaches, and his starving family surrounded him crying for food; but in spite of all these discouragements he persisted in the search, and was in the end rewarded by success. A few vessels adorned with figures of animals, coloured to represent nature, sold for high prices, and enabled him to complete his investigations, after which he became famous; and though a Huguenot, was protected and encouraged by the king and the nobility, who employed him to embellish their mansions with specimens of his art. He was lodged in or near the Tuileries, and was specially exempted by Queen Catharine from the massacre of St Bartholomew, more from a regard to her own benefit than from kindness. In March 1575 he commenced a course of lectures on natural history and physics, and was the first in France to substitute positive facts and rigorous demonstrations for the fanciful interpretations of philosophers. In the course of these lectures, he gave (1584) the first right notions of the origin of springs, and the formation of stones and fossil shells, and strongly advocated the importance of marl as a fertilising agent. These, along with his theories regarding the best means of purifying water, have been fully supported by recent discovery and investigation. In 1588 he was arrested and thrown into the Bastille as a heretic, but died in 1590 before his sentence was pronounced.

P. left a collection of objects of natural history, the first that had been formed in France. His works are at the present day almost beyond price, and his ornaments and arabesques are amongst the most beautiful of the 'renaissance.' As a sincere, earnest, and courageous man, he was no less eminent than as an artist.

**PALIURUS**, a genus of trees and shrubs of the natural order *Rhamnaceae*, nearly allied to *Zizyphus* (see **JUJUBE**), but very different in the fruit, which is dry, orbicular, and girded with a broad membranous wing. *P. aculeatus* is often called **CHRIST'S THORN**, and by the Germans, **JEW'S THORN** (*Juden-dorn*), from an imagination that it supplied the crown of thorns with which our Saviour was crowned. It is a deciduous shrub or low tree, with slender, pliant branches and ovate 3-nerved leaves, each of which has two sharp spines at the base, one straight and the other re-curved. It is a native of the countries around the Mediterranean, of India, and many parts of Asia. It is often used for hedges in Italy and other countries; its sharp spines and pliant branches admirably adapting it for this purpose. The fruit has a singular appearance, being flat and thin, attached by the middle to the foot-stalk, the middle being raised like the crown of a hat, whilst the expansion resembles the brim. The

seeds are sold by the druggists of the east, and are used medicinally, but their qualities are doubtful



Christ's Thorn (*Paliurus aculeatus*):  
a, ripe fruit.

This shrub is not uncommon in shrubberies in England, being very ornamental when in flower, but the fruit does not ripen.

**PALK STRAIT**, or **PALK'S PASSAGE**, the northern portion of the passage between the south coast of Hindustan and the island of Ceylon. This passage is continued southward by the Gulf of Manaar (q. v.). It is from 40 to 80 miles in width, and is 80 miles in length. It is so shallow—in some places being no more than two fathoms in depth—that it cannot be navigated in safety by large vessels. In P. S. there are several pearl fisheries.

**PALL** (Lat. *pallium*, also *palla*, a cloak), the name given in English to two very different portions of the vesture employed in the religious use of the Roman and some other churches. One of these is the *funeral pall*, an ample covering of black velvet or other stuff, which is cast over the coffin while being borne to burial. The ends of the pall are held during the funeral procession by the most distinguished among the friends of the deceased, generally selected from among those unconnected by blood. In its second and most strictly liturgical use, the word pall is applied to one of the coverings used at the altar in the celebration of the mass. Primitively, as appears from Optatus and other early writers, the altar was covered with a large linen cloth—called by the Latins *pallium*, and by the Greeks *eiletou*—the extremities of which were folded back so as to cover the bread and wine prepared for the celebration of the eucharist. In later times a separate covering was employed for the sacramental chalice, to which latter the name pall is now reserved in the use of the Roman Church. The modern Roman pall is a square piece of linen cloth—sometimes limber, sometimes made stiff by inserting pasteboard—sufficiently large to cover the upper surface of the chalice. The upper surface is often of silk embroidered, or of cloth of gold. The surface in contact with the chalice must always be of linen.



Pall.

**PALL**, in Heraldry, the upper part of a saltire conjoined to the lower part of a pale. It appears much in the arms of ecclesiastical sees.

## PALL-MALL. See MALL.

**PALLADIO, ANDREA**, a famous Italian architect, was born at Vicenza, 30th November 1518. After having studied with the greatest care the writings of Vitruvius, and the monuments of antiquity at Rome, he settled in his native city, and first acquired a reputation by his restoration of the Basilica of Vicenza. Pope Paul III then invited him to Rome, designing to intrust him with the execution of the works then going on at St Peter's, but his holiness dying before the arrival of P., the latter had to return home. He was employed for many years in the construction of numerous buildings in Vicenza and the neighbourhood, in all of which he displayed the most exquisite taste combined with the most ingenious and imaginative ornamentation. His style, known as the Palladian, is a composite, and is characterised by great splendour of execution and justness of proportion, and it exercised an immense influence on the architecture of Northern Italy. His principal works are the Rotonda Capra, outside Vicenza; the Palazzo Chiericaco and the Palazzo Tiepi, in the city; the Palazzo Barbara, at Maser in the Trevigiano, the Teatro Olympico at Vicenza (his last work), the Palazzo at Montagnana for Francesco Pisana; the churches of San Giorgio Maggiore and Il Santissimo Redemptore at Venice, the atrium and cloister at the convent Della Carità, and the façade of San Francesco della Vigna in the same city. P. died at Vicenza, August 6, 1580. He wrote a work on architecture, which is highly prized. The best edition is that published at Vicenza in 4 vols., 1776.

**PALLADIUM** (symb. Pd, equiv. 53, specific gravity 11.8) is one of the so-called noble metals, which in its colour and ductility closely resembles platinum. It is not fusible in an ordinary wind-furnace, but melts at a somewhat lower temperature than the last-named metal; and when heated beyond its fusing-point, it volatilises in the form of a green vapour. It undergoes no change in the open air at ordinary temperatures; but at a low red heat, it becomes covered with a purple film, owing to superficial oxidation. It is soluble in nitric and iodic acids, and in aqua regia. It combines readily with gold, which it has the property of rendering brittle and white. (When it forms 20 per cent. of the mass, the alloy is perfectly white.) When alloyed with twice its weight of silver, it forms a ductile compound, which has been employed for the construction of small weights; but for this purpose aluminium is superior. Professor Miller states that it 'has been applied in a few cases to the construction of graduated scales for astronomical instruments, for which, by its whiteness, hardness, and unalterability in the air, it is well adapted;' its scarcity must, however, prevent its general use for this purpose.

It was discovered in 1803 by Wollaston in the ore of platinum, of which it seldom forms so much as 1 per cent. Another source of this metal is the native alloy which it forms with gold in certain mines in Brazil, and which is termed *ouro poudre*; and it is from this alloy that the metal is chiefly obtained.

Palladium forms with oxygen a protoxide, PdO, which is the base of the salts of the metal; a binxide, PdO<sub>2</sub>; and according to some chemists, a suboxide, Pd<sub>2</sub>O. On exposure to sufficient heat, these compounds give off their oxygen, and yield the metal. The salts of the protoxide are of a brown or red colour.

**PALLADIUM**, among the ancient Greeks and Romans, an image of Pallas, who was generally identified with Athene, upon the careful keeping of which in a sanctuary the public welfare was believed

to depend. The Palladium of Troy is particularly celebrated. According to the current myth, it was thrown down from heaven by Zeus, and fell on the plain of Troy, where it was picked up by Ilius, the founder of that city, as a favourable omen. In the course of time, the belief spread that the loss of it would be followed by the fall of the city; it was therefore stolen by Odysseus and Diomedes. Several cities afterwards boasted of possessing it, particularly Argos and Athens. Other accounts, however, affirm that it was not stolen by the Greek chiefs, but carried to Italy by Æneas; and the Romans said that it was preserved in the temple of Vesta, but so secretly, that even the Pontifex Maximus might not behold it. All images of this name were somewhat coarsely hewn out of wood.

**PALLADIUS, RUTILIUS TAURUS ÆMILIANUS**, a Roman author, who probably lived in the 4th c. A.D., under Valentinian and Theodosius. He wrote a work, *De Re Rustica* (On Agriculture), in 14 books, the last of which is a poem of 85 elegiac couplets. It is, from a literary and grammatical point of view, full of faults; but as it was a complete calendar of Roman agriculture, it was very useful for its time, and was much read and followed during the middle ages. P. has borrowed largely from his predecessors. The best edition is that by J. G. Schneider in his *Scriptores Rei Rusticæ Veteres Latini* (4 vols., Leip. 1794).

## PALLAS. See MINERVA.

**PALLAS, PETER SIMON**, an eminent traveller and naturalist, was born, 22d September 1741, at Berlin, where his father was a physician. He studied medicine, natural history, and other branches of science, at the universities of Berlin, Göttingen, and Leyden, and was employed in classifying many valuable collections of objects of natural history, both in Holland and England. He gained a high reputation by the publication of his *Blenchus Zophytorum* (Hague, 1766), a work still much valued; *Miscellanea Zoologica* (Hague, 1766), and *Spicilegia Zoologica* (2 vols., Berlin, 1767—1804). The Empress Catharine invited him, in 1768, to St Petersburg, where he was well received, and had honours conferred on him, and he was subsequently appointed naturalist to a scientific expedition bound for Siberia, there to observe the transit of Venus. P. spent six years on this journey (1768—1774), exploring in succession the Ural Mountains, the Kirghiz Steppes, great part of the Altaian range, and the country around Lake Baikal as far as Kiachta, great part of Siberia, and the steppes of the Volga, returning to St Petersburg in 1774, with an extraordinary treasure of specimens in natural history, which form the nucleus of the Museum of the Academy of St Petersburg. His travels (*Reisen durch verschiedene Provinzen des Russ. Reichs*) were published at St Petersburg (1771—1776), in three volumes, and were followed by his *Sammlung historischer Nachrichten über die Mongol. Völkerschaften* (2 vols., St Petersburg, 1776—1802), and his *Neue nordische Beiträge zur physikalischen und geographischen Erd- und Völkerbeschreibung, Naturgeschichte und Oekonomie* (6 vols., St Petersburg, 1781—1793). Without positively neglecting any branch of natural history, he now devoted himself more particularly to botany; and his magnificent *Flora Rossica* (St Petersburg, 1784—1788), a work which, however, he was not able to complete, and his *Species Astragalorum* (14 parts, Leip. 1800—1804), were among the results of his studies. He published also *Icones Insectorum præcipue Rossicæ Sibiricæque Peculiarium* (Erlangen, 1781, 1783, and 1806); and contributed to a glossary of all the languages of the Russian empire, which was published at St Petersburg. As he wished to live

in the Crimea, the Empress Catharine presented him with an estate in the finest part of that peninsula, where he resided generally from 1796. His *Travels in the South of Russia* were published in 1799 (2 vols., Leip., with volume of plates). After the death of his wife, he went to Berlin, where he died, 8th September 1811. A large and valuable work of his, on the Fauna of Russia, has not yet (1862) been published.

**PALLAVICINO, PIETRO SFORZA**, an Italian historian, son of the Marquis Alessandro Pallavicino of Parma, was born at Rome, 20th November 1607. Much to the disgust of his father; he took priest's orders, and held several important ecclesiastical appointments during the pontificate of Urban VIII. In 1637, he became a member of the Jesuit Society, and was created a cardinal in 1657 by Pope Alexander VII. He died at Rome, 5th June 1667. P. was a fine scholar, and often presided in the famous Roman academy of the *Umoristi*. The best known of all his writings is his *Istoria del Concilio de Trento* (Rome, 1656—1657), intended as a reply to the still more celebrated and liberal, although, by Catholics, deeply suspected, work of Paul Sarpi. Among his other works may be mentioned *Vindicationes Soc. Jes.* (Rome, 1649); *Arte della Perfezione Cristiana—I Fasti Sacri* (the unpublished MS. is in the library of Parma); *Ermengilda*, a tragedy (Rome, 1644); *Gli Avvertimenti Grammaticali* (Rome, 1661); *Trattato dello Stilo e del Dialogo* (Rome, 1662), and *Lettere* (Rome, 1668).

**P'ALLI**, a town of Rajputana, in Judpore, stands on the right bank of a branch of the Luni River, in lat. 25° 48' N., long. 73° 24' E. It is an entrepôt for the opium sent from Malwa to Bombay, and is the seat of extensive commerce. It imports European manufactured goods extensively, and is estimated to contain about 50,000 inhabitants.

**PALLIOBRANCHIATA.** See BRANCHIOPODA.

**P'ALLIUM**, the name given in the Roman Catholic Church to one of the ecclesiastical ornaments worn by the pope, by patriarchs, and by archbishops. Its use is held by Roman Catholics to descend from a very early period. It is worn by the pope at all times, as a symbol of his reputed universal and abiding jurisdiction. By archbishops it cannot be worn until it has been solemnly asked for and granted by the pope, and even then only during the solemn service of the great church festivals, and on occasions of the ordination of bishops or of priests, and other similar acts of the archiepiscopal order. The pallium is a narrow annular band of white woollen web, about three inches wide, upon which black crosses are embroidered, which encircle the neck of the archbishop, and from which two narrow bands of the same material depend, one falling over the breast, the other over the back of the wearer. Its material is the subject of much care and ceremonial. It is made wholly or in part from the wool of two lambs, which are blessed annually on the festival, and in the church of St Agnes. During the night of the vigil of the feast of St Peter and St Paul, the *pallia* made of this wool are placed on the altar above the tomb of these apostles, and on the feast of St Peter and St Paul are delivered by the pope to the subdeacon, whose duty it is to keep them in charge. Within three months of his consecration, every new archbishop is obliged to apply to the pope, in person or by proxy, for the pallium; nor is it lawful for him, until he shall have received it, to exercise any act of what is properly archiepiscopal, as contradistinguished from episcopal jurisdiction. Thus, he cannot, for example, call a provincial synod. The pallium cannot be transferred from one archbishop to another, but must be received

direct from the pope. On the archbishop's death, his pallium is interred with him. Its use is held to symbolise the office of the 'good shepherd' bearing the lost sheep on his shoulders, and is connected by some writers with the vesture of the Jewish high-priest in Exod. xxviii. 4. In the medieval church, the granting of the pallium to archbishops was one of the chief occasions of the tribute which was paid by the national churches to the support of the great central office and dignity of the papacy. In some sees, as, for instance, those of the great prince-bishops of the Rhine, the tribute was as much as 20,000 florins. Roman Catholics, however, maintain that this tribute was not a *payment* for the pallium, but an *offering* to the holy see, made on occasion of the grant of that emblem of jurisdiction.

**PALM**, a measure of length, originally taken from the width of the hand, measured across the joints of the four fingers. In Greece, it was known as *palaistē*, and was reckoned at 3 inches, or  $\frac{1}{4}$  of a cubit, which was their standard unit. The Romans adopted two measures of this name—the one was the Greek *palaistē*, and was called *palms minor*; the other, which was not introduced till later times, was called *palms major*, or *palma*, and was taken from the length of the hand, being therefore usually estimated at three times the length of the other. At the present day, this measure varies in a most arbitrary manner, being different in each country, and occasionally varying in the same. The English palm, when used at all, which is seldom, is considered to be the fourth part of an English foot, or 3 inches. The following is a list of the most common measures to which the name palm is given:

	Value in Eng. Inches.
Greek <i>palaistē</i> , . . . . .	3 03775
Roman <i>palms</i> , or lesser palm, . . . . .	2 9124
" <i>palma</i> , or greater palm, . . . . .	3 7372
English palm ( $\frac{1}{4}$ of a foot), . . . . .	3 0000
Hamburg palm ( $\frac{1}{4}$ of a foot), . . . . .	3 7633
Amsterdam 'round' palm, . . . . .	4 1200
" 'diameter' palm, . . . . .	11 9687
Belgian palm, } properly the <i>decimètre</i>	3 9371
Lombard palm, }	
Spanish palm, or <i>palmo major</i> , . . . . .	3 3450
" " " or <i>palmo minor</i> , . . . . .	2 7817
Portuguese palm, or <i>palmo de Craveira</i> , =	3 6616

In Germany and the Low Countries, the palm is generally confined to wood-measurement, while in Portugal it is the standard of linear measure.

**PALM, JOHANN PHILIPP**, a bookseller of Nuremberg, who has acquired an historic celebrity as a victim of Napoleonic justice in Germany. He was born at Schorndorf in 1766, and succeeded his father-in-law, Stein, as a bookseller in Nuremberg, the old name of the firm being retained. In the spring of 1806, a pamphlet, entitled *Deutschland in seiner tiefsten Erniedrigung* (Germany in its Deepest Humiliation), which contained some bitter truths concerning Napoleon, and concerning the conduct of the French troops in Bavaria, was sent by this firm to a bookseller in Augsburg in the ordinary course of trade, and, as P. to the last moment of his life averred, without any regard, on his part, to its contents. Napoleon's police traced it to the shop in Nuremberg, and an investigation was ordered, from which nothing resulted. Palm was in Munich, and perhaps escaped imprisonment there because his name was not the same with that of the firm; but supposing all safe, he returned to Nuremberg, and was there taken prisoner, and examined before Marshal Bernadotte, whose adjutant represented his arrestment as the consequence of direct orders from Paris. An extraordinary court-martial, held at Brunau, to which he was removed, condemned him to death, without any advocate being heard in his defence. All

all so proud of him'—P. entered upon a manly and dignified vindication of his foreign policy; and Mr Roebuck's motion was carried by a majority of 46. In December 1851, the public were startled at the news that P. was no longer a member of the Russell cabinet. He had expressed his approbation of the *coup d'état* of Louis Napoleon, without consulting either the premier or the Queen; and as explanations were refused, her Majesty exercised her constitutional right of dismissing her minister. P. avenged himself, as soon as parliament met, by shattering the Russell administration to pieces on a comparatively trifling question regarding the militia. He refused an offer from the Earl of Derby to join the government which he was commissioned to form, but accepted the post of Home Secretary in the coalition administration of the Earl of Aberdeen in 1852. The fall of this government, on Mr Roebuck's motion for a Sebastopol committee, placed P. in his 71st year in the position of prime minister, to which he was unanimously called by the voice of the nation. He vigorously prosecuted the Russian war until Sebastopol was taken, and peace was made. His government was defeated in March 1857, on Mr Cobden's motion, condemnatory of the Chinese war. Parliament was dissolved, and P. met the House of Commons with a large majority. But his administration fell in February 1858, upon the Conspiracy Bill, intended to protect the French emperor against the machinations of plotting refugees. A short Conservative administration followed; but in June 1859, P. was again called to the post of First Lord of the Treasury, which he has continued to fill to the present moment (June 1864). It has been his ambition to be considered the minister of a nation rather than the minister of a political party; and his opponents have been constrained to admit that he has held office with more general acceptance than any English minister since the time of the great Lord Chatham. As an orator, he is usually homely and unpretending, but always sensible and practical. He is a dexterous tactician, and a ready, witty, and often brilliant debater. He is popular as a minister, because he is thoroughly English in his ends and aims. Even his robust health, manly bearing, and physical vigour, are elements of his popularity, because they are regarded as a glorification of the English sports, which he has never been ashamed to patronise. He desires nothing so ardently as to promote the wealth and grandeur of Great Britain, and his national character and national spirit are thoroughly appreciated by his countrymen. He married, in 1839, the widow of the fifth Earl of Cowper, daughter of the first Viscount Melbourne. As he is without issue, and his only brother, the Honourable W. Temple, many years British minister at Naples, died unmarried, the title becomes extinct on his decease.

**PALMER-WORM**, a name given to many large kinds of grub, the larvæ of coleopterous insects, destructive to vegetable substances of various kinds. It is used in the English version of the Old Testament as the translation of the Hebrew *gazam*, rendered *kampe* by the Septuagint, which modern Hebrew writers and others very generally regard as a kind of locust, although more probably it is either the grub of a coleopterous or the caterpillar of a lepidopterous insect.—See Kitto in *Pictorial Bible*, on Joel i. 4.

*Palmer-flies* are much used by anglers on the English streams, and are at certain seasons excellent lures for trout, &c.

**PALMETTO** (*Sabal palmetto*, or *Chamærops palmetto*), a species of palm, a native of maritime parts of North America, as far north as lat. 35°;

which is further north than any other American species of palm is found. It attains a height of 40—50 feet, and has a crown of large palmated leaves, the blade from one foot to five feet in length and breadth, and the footstalk long. The flowers are small, greenish, and in long racemes; the fruit black, about as long as a pea-pod, and uneatable. The leaves are made into hats. The terminal bud or *cabbage* is eaten. The wood is extremely porous: but is preferred to every other kind of wood in North America for wharfs, as it is very durable, and not liable to be attacked by worms.—The *Chamærops* (q. v.) *humilis* of the south of Europe is also called *Palmetto*.

**PALMETTO-LEAVES**, the leaves of the Palmyra (q. v.) palm, *Borassus flabelliformis*, which grows extensively in India and Polynesia. The leaves have great value as a material for the manufacture of hats, mats, &c., and for this purpose are frequently imported into Europe. In their native country, they are used as thatch, and for a great variety of other useful applications.

**PALMI-PEDÉS**, or **WEB-FOOTED BIRDS**, also called **NATATORS**, or **SWIMMERS**, an order of birds, the *Anseres* of Linnaeus, very natural and universally recognised by ornithologists, having the feet specially formed for swimming, and the toes *webbed*, i. e., connected by a membrane, at least those which are directed forwards. In swimming, the feet are contracted when drawn forwards, the toes being brought together, and expanded to their utmost extent in the backward stroke. In accordance with their aquatic habits, the P. are further characterised by a boat-like form, calculated to move through the water with little resistance; and by a dense and polished plumage, oiled by a secretion from certain glands near the tail, very impervious to water; whilst warmth is further secured by a clothing of down, more or less abundant, beneath the feathers. They are remarkable for the length of the breast-bone (*sternum*), and the neck is often longer than the legs, a thing very unusual in birds, so that they can plunge the head far down in search of food. The length of the wings differs very much in different sections of the order, and with it the power of flying; as does also the power of diving, which some possess in a high degree, and others, even of the same family, in a very inferior degree. To this order belong geese, swans, ducks, divers, grebes, auks, guillemots, puffins, penguins, petrels, albatrosses, gulls, terns, shearwaters, noddies, pelicans, cormorants, frigate-birds, gannets, darters, tropic-birds, &c.

**PALMITIC ACID** ( $\text{HO}, \text{C}_{31}, \text{H}_{61}, \text{O}_2$ ) is one of the most important of the *Fatty Acids*, represented by the general formula  $\text{HO}, \text{C}_n, \text{H}_{2n+1}, \text{O}_2$  (see **OILS AND FATS**). In a pure state, when crystallised from alcohol, it occurs in the form of beautifully white acicular crystals arranged in tuft-like groups. These crystals are devoid of odour or taste, communicate a fatty feeling to the finger, fuse at 143°-6, and solidify on cooling in the form of crystalline scales. This acid is lighter than water, in which it is perfectly insoluble; but it dissolves freely in boiling alcohol and in ether, and the solutions have a distinctly acid reaction. In small quantities it may be distilled without decomposing, if the heat be carefully regulated. The neutral palmitates of the alkalis constitute soaps, and are soluble in water; if, however, their solutions are largely diluted with additional water, they are decomposed, an insoluble acid salt being precipitated, while a portion of the base remains in solution. The addition of chloride of sodium (common salt) to a solution of an alkaline palmitate produces a similar

effect. The other most important compounds of palmitic acid are those which it forms with glycerine and with cetylic ether. With glycerine this acid forms three compounds, viz., a triglyceride or tripalmitate (constituting the ordinary PALMITINE of chemists), a diglyceride, and a monoglyceride. In addition to its existence in the form of palmitine, palmitic acid is found in a free state in old palm oil. In combination with cetylic ether, or of oxide of cetyl, whose composition is represented by the formula  $C_{22}H_{44}O$ , it is the main constituent of Spermaceti (q. v.), which is in fact essentially a palmitate of oxide of cetyl ( $C_{22}H_{44}O, C_{22}H_{42}O_2$ ); and as a palmitate of oxide of melissyl—a substance which will be noticed in the article WAX—it is the chief ingredient of bees-wax.

PALMITINE is a white fat, usually occurring, when crystallised from ether, in the form of a mass of small scaly crystals. According to Duffy, it occurs like the allied fat stearine in three modifications, each of which has a different melting-point—viz.,  $114^{\circ}$ - $8$ ,  $143^{\circ}$ , and  $145^{\circ}$ . On cooling, it solidifies into a wax-like mass, of lower specific gravity than water, and insoluble in that fluid, but readily soluble in ether and in boiling alcohol. It is a constituent of almost every kind of fat, and is the preponderating ingredient in those of a semi-solid consistence, and in many oils. It receives its name from the abundance in which it occurs in palm oil, and it may readily be obtained from this source by removing the liquid portion (the oleine) by pressure, and purifying the remaining palmitine by crystallisation from ether, or a mixture of ether and alcohol. It has been stated in the article on Glycerine (q. v.) that the composition of that substance may be represented by the formula  $C_6H_5O_3 \cdot 3HO$ . When palmitic acid unites with it to form a triglyceride (or the substance usually recognised as palmitine), three atoms of the anhydrous acid expel and replace the three atoms of water in the glycerine, and the resulting compound, palmitine, is consequently represented by the formula  $C_6H_5O_3 + 3(C_{22}H_{41}O_2)$ , or  $C_{102}H_{206}O_{18}$ .

PALMS (*Palme* or *Palmaceae*), a natural order of endogenous plants, not excelled in importance by any order in the vegetable kingdom except Grasses. They are generally tall and slender trees, often of gigantic height, without a branch, and bearing at the summit a magnificent and graceful crown of very large leaves. The stem is sometimes, however, of humble growth, and more rarely it is thick in proportion to its height; sometimes, but rarely, it is branched, as in the Doom (q. v.) Palm; and sometimes, as in Rattans (q. v.), it is flexible, and seeks support from trees and bushes, over which it climbs in jungles and dense forests, clinging to them by means of hooked spines. Some of the species with flexible stem attain a prodigious length, ascending to the tops of the highest trees, and falling down again. Rumphius asserts that they are sometimes 1200, or even 1800 feet long. Whatever the form or magnitude of the stem of a palm, it is always woody, and the root is always fibrous. It is only towards its circumference, however, that the stem is hard, and there in many species it is extremely hard; but the centre is soft, often containing, when young, a great quantity of starch (sago), and sometimes filled, when old, with a mass of fibres which can be separated without difficulty. Concerning the structure of the stem, see ENDOGENOUS PLANTS. The stem is generally marked externally with rings or scars, where former leaves have been attached; sometimes it is rough with the remaining bases of the leaves, and part of it is sometimes covered with their fibrous appendages. No other plants have leaves so large as many of the P.; the largest of all are those of some of the fan-leaved P., but there

are P. with pinnate leaves 50 feet long and 8 feet broad, and undivided leaves are to be seen 30 feet long by 4 or 5 feet broad. There are, however, also small P., and P. with flexible stems, which have small leaves. The number of the large leaves which form the crown of even the most magnificent palm is never great. Whatever the size or form of the leaves, they are always stalked, the stalk being often in dimensions equal to a large bough of a great oak or other such tree. The leaves are commonly pinnate, the number of pinnules or leaflets being often very great; but about one-sixth of the whole number of known species of P. have fan-shaped leaves, and a few species have undivided leaves. The leaves are in all cases persistent, only falling off in succession as the palm advances in growth, and new ones are formed at the summit. The flowers are sometimes hermaphrodite, sometimes unisexual; the same tree having sometimes male, female, and hermaphrodite flowers, whilst other species are monoecious and others dioecious. The perianth has six divisions, three outer and three inner; there are generally six, rarely three stamens; the ovary is composed of three carpels, distinct or united, each with one cell containing one ovule. The flowers are small, but are often produced in dense masses of very striking appearance. Humboldt reckons the number of flowers on a single palm (*Alfonsia amygdalina*) as about 600,000, and every bunch of the Seje Palm of the Orinoco consists of about 8000 fruits. The flowers are produced on scaly spadices, often much branched, and enclosed, before expanding, in leathery or woody spathes, often very large, and sometimes opening by bursting with a loud explosion. The flowers of some P. emit a very powerful odour, which attracts multitudes of insects. The fruit is sometimes a kind of berry, sometimes a drupe, either with a fleshy or a fibrous covering; and sometimes contains a very hard and bony nut. The fruit is sometimes only of the size of a pea or a cherry; sometimes, notwithstanding the smallness of the flowers, it is of very large size, of which the cocoa-nut is a familiar example.

Palms are mostly natives of tropical countries, being found almost everywhere within the tropics, and forming, perhaps, the most striking characteristic of tropical vegetation. The tropical parts of America, however, particularly abound in them, producing a far greater number of species than any other part of the world. A few species are found in temperate regions; one species only, *Chamaerops humilis*, being a native of Europe, and extending as far north as lat.  $44^{\circ}$ , whilst the northern limit of P. in Asia is about lat.  $34^{\circ}$ , and in North America, lat.  $35^{\circ}$ . In South America, the southern limit of P. is lat.  $36^{\circ}$ ; in Australia, it is lat.  $35^{\circ}$ ; in Africa, no native species is found further south than lat.  $30^{\circ}$ ; but in New Zealand, one species extends as far south as lat.  $38^{\circ} 22'$ . Some of the species, however, which are found in tropical America grow in mountain regions bordering upon the limits of perpetual snow. Some P. have very narrow geographical limits; the cocoa-nut palm is by far the most extensively distributed species. Some, like the cocoa-nut, grow in maritime, others in inland districts. Some grow on dry and sandy ground, others in the richest alluvial soil, and some in swampy situations; some in open districts, others in dense forests. Some species are generally found singly, some in groups; some even cover tracts of country in which no other tree appears.

The uses of P. are many and various; there is almost no species which is not capable of being applied to some use. Tribes in the lowest grade of civilisation depend almost entirely on particular species of palm, as the cocoa-nut palm, for the

supply of all their wants. The fruit of some species is eaten; sometimes the fleshy part of the fruit, sometimes the kernel of the nut. The importance of the date and the cocoa-nut needs only to be alluded to; but in this respect they far excel the fruits of all other palms. A grateful beverage is made from the fruit of some P. (see ASSAI), consisting simply of a mixture of the pulp with water; but a kind of wine can be obtained also by fermentation (see DATE). A kind of beverage more generally used is the sap of palm-trees, either fresh or fermented (*palm-wine* or *toddy*), from which also a kind of spirits called Arrack (q. v.) is obtained by distillation; whilst from the fresh sap, boiled down, sugar is obtained—the *jaggery* of the East Indies. The sap of various species of palm is collected and used for these purposes, and that of many others is probably not less suitable. The pulp of the fruit of some species, and the kernel of others, yield bland fixed oil useful for various purposes. See OIL PALM and COCOA-NUT. The soft and starchy centre of the stem of some P. affords a very important and abundant article of food. See SAGO. The terminal bud, or *cabbage*, of some species is boiled for the table; and although the taking of the bud is death to the tree, this is little regarded where vegetation goes on with a rapidity and luxuriance unknown in the colder parts of the world. The young sprouts arising from the seeds of P., when they have begun to vegetate, are another esculent of tropical countries. From the stems of some species of palm, as the Wax Palm (q. v.) of the Andes, and from the leaves of some, as the Carnahuba Palm (q. v.), wax is obtained, which is used for the same purposes as bees-wax. The wood of P. is used in house building, and for many other purposes; some affording very hard and beautiful wood for ornamental work, whilst others are suitable only for coarse purposes. The great leaf-stalks are also used for some of the purposes of timber. The stems of the most slender species are used for walking-sticks, &c., and, split or unsplit, for wicker-work. See RATTAN. The leaves of many P. are used for thatching houses. The spathes of some species are used as vessels or bags. The fibres of the leaf, the fibres connected with the leaf-stalk, the fibres of the rind of the fruit, and the fibres of the stem of different kinds of P. are used for making cordage, mats, nets, cloth, &c. The most important of these fibres are Coir (q. v.) or Cocoa-nut Fibre, Gomuto (q. v.) or Eجو Fibre, and Piassaba (q. v.). The coarsest fibres are employed as bristles for making brushes, &c. Stripes of the delicate epidermis of the young unopened leaves of some South American P. are twisted, and so used for making a kind of thread; hammocks made of which are highly valued. See ASTROCARYUM. The leaves of the Palmyra Palm and Talipot Palm are used in some parts of the east for writing upon, an iron style being employed instead of a pen. One of the kinds of the resinous substance called *Dragon's Blood* is obtained from the fruit of a palm. The Betel (q. v.) Nut, abounding in catechu, is the fruit of a palm. The fruit of many P. is very acrid. The ashes of the fruits of some American species are used by the Indians as a substitute for salt, probably on account of potash, or some salt of potash, which they contain; and much potash may be obtained from the stems and leaves of palms. Vegetable Ivory (q. v.) is the kernel of the fruit of a palm; and somewhat similar to it in quality is the Coquilla Nut (q. v.). But a complete enumeration of the uses to which P. and their products are applied is almost impossible.

Some of the more important species of P. are noticed in separate articles.

About five hundred species are known; but it is

probable that many are still undescribed. The most complete work on P. is the monograph by Martius, *Genera et Species Palmarum* (3 vols., large folio, Munich, 1823—1845), a magnificent work, with 219 coloured plates; but many new species have been discovered since its publication.

The cultivation of P. in hothouses is attended with great expense. Separate houses are devoted to them in a few gardens, of which the greatest is that at Kew. A very fine palm-house has been erected in the Botanic Garden of Edinburgh. P. are cultivated in hothouses merely as objects of interest, and for the gratification of a refined taste, never for the sake of their fruit or any other product.

**PALMYRA**, the name given by the Greeks to a great and splendid city of Upper Syria. Its original Hebrew name was *Tadmor*, which, like the Greek word, means 'city of palms.' It was built, according to the writers of Kings (Book I. chap. ix. verse 18) and Chronicles (Book II. chap. viii. verse 4), by Solomon in the 10th c. B. C.; but it is more probable that he only enlarged it. It occupied a fertile oasis, well watered, and abounding in palm-trees. Barren and naked mountains overlook it from the west, and to the east and south stretches the illimitable sandy desert. P. was, in the Solomonic age, a bulwark of the Hebrew kingdom against the wandering hordes of Beduins; but its early history is obscure and insignificant. After the fall of Selencia, it became a great centre of commercial intercourse between the east and the west of Asia. Its commercial importance, wealth, and magnificence greatly increased after the time of Trajan, who subjected the whole country to the Roman empire. In the 3d c., Odenathus, a Syrian, founded here an empire, which, after his murder, rose to great prosperity under his wife, Zenobia (q. v.), and included both Syria and Mesopotamia; but this was not of long duration, for the Roman Emperor Aurelian conquered it in the year 275, and the city was soon after almost entirely destroyed in revenge for the slaughter of a Roman garrison. It never recovered from this blow, although Justinian fortified it anew. The Saracens destroyed it in 744. A village called Tadmor, inhabited by a few Arab families, now occupies the site. The ruins of the ancient city, white and dazzling in the Syrian sun, excite at a little distance the admiration of all beholders; but when examined in detail, they are said to be far from imposing, though in regard to this latter point opinions differ. They were visited by English merchants resident at Aleppo in 1691, and again by Messrs Wood and Dawkins in 1751, and since then by a vast number of travellers. The ruins of a temple of Baal, the sun god, are, however, confessedly magnificent. The language of ancient Palmyrene appears, from inscriptions which remain, to have been an Aramaic language. See Murray's *Handbook for Syria and Palestine* by Porter (Lond. 1858).

**PALMYRA PALM** (*Borassus flabelliformis*), a species of palm with a magnificent crown of fan-shaped leaves, a native of the East Indies. The stem attains a height of 25—40, or even 60 feet, and tapers slightly upwards. The leaves are about four feet long, with stalks of about the same length, the stalks spiny at the edges; each leaf having 70—80 rays. The fruit is somewhat triangular, about the size of a child's head; having a thick, fibrous, and rather succulent yellowish-brown or glossy black rind, and containing three seeds each as large as a goose's egg. The P. P. is the most common palm of India, growing spontaneously in

PALMYRA WOOD—PALPITATION.

many districts, cultivated in others, and reaching as far north as lat. 30°. It is of slow growth; and the wood near the circumference of the stem in old trees is very hard, black, heavy, durable, susceptible of a high polish, and valuable, easily divided in a longitudinal direction, but very difficult to cut across. The P. P. abounds greatly in the north of Ceylon, forming extensive forests; and the timber is exported to the opposite coast of India, being of superior quality to that which is produced there. It is much used in house building. The stalks of the leaves are used for making fences, &c. The leaves are used for thatching houses; for making baskets, mats, hats, umbrellas, and large fans; and for writing upon. Their fibres are employed for making twine and small rope; they are about two feet long, and very wiry. A fine down found at the base of the leaf-stalks is used for straining liquids, and for stanching wounds. The P. P. yields palm-wine, and of course also arrack and sugar (*jaggery*). It furnishes great part of the palm-wine, sugar, and arrack of India. See ARRACK. The fruit is cooked in a great variety of ways, and used for food. The seeds are jelly-like, and palatable when young. A bland fixed oil is extracted from the fruit. The young plants, when a few inches high, are esteemed as a culinary vegetable, being boiled and eaten generally with a little of the kernel of the cocoa-nut; and sometimes they are dried and pounded into a kind of meal. Multitudes of the inhabitants of the north of Ceylon depend almost entirely on the P. P. for the supply of all their wants. In the 'Palmyra Regions' of the Southern Dekkan vast numbers of the people subsist chiefly on the fruit of this palm.

The Deleb Palm (q. v.), so important to the inhabitants of Central Africa, is believed to be nearly allied to the Palmyra Palm.

**PALMYRA WOOD.** Properly this name applies only to the wood of the Palmyra palm (*Borassus Jabeliformis*), but it is generally used for all kinds of palm-tree wood imported into this country, amongst which very much is the wood of the cocoa-nut palm, *Cocos nucifera*, and the allied species *C. plumosa*. These woods are also called *Speckled Wood* and *Porcupine Wood* by the dealers—the former name being applied to those veneers cut transversely, and shewing the ends of numerous black fibres mixed with the lighter coloured portions; and the latter to longitudinal sections, in which the mixed black and white fibres much resemble porcupines' quills.

**PAL'O BLANCO** (*Flotovia dicanthoides*), a large tree, a native of Chili, the wood of which is white, and very useful and durable. It is remarkable as one of the few large trees belonging to the natural order *Compositae*.

**PALO'LO**, or **BALOLO** (*Palolo viridis*), a dorsi-branchiate annelid, allied to the Lug-worm, extremely abundant at certain seasons in the sea above and near the coral reefs which surround many of the South Sea Islands, as the Samoa Islands and the Fiji Islands. The body is cylindrical, slightly tapering at both ends, divided into nearly equal joints, each joint with a small tuft of gills on each side. In thickness, the P. resembles a very fine straw; it is about three inches long, generally of a greenish colour, with a row of round black spots; but the colour varies to red, brown, and white. These annelids make their appearance in great multitudes, apparently rising out of the coral reefs, and with a periodical regularity which is very remarkable. They are eagerly sought after by the islanders, who are on the watch for their appearance, and go out in canoes early in the morn-

ing to take them by means of nets; but they often occur in such numbers that the water seems to be full of them, and they may be grasped by handfuls.

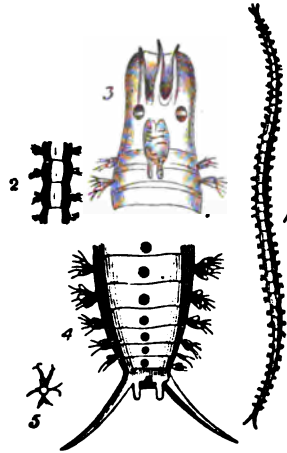

**Palolo Viridis** (copied from Seemann's *Fiti*): 1, the entire animal, half natural size; 2, portion of body, slightly magnified; 3, magnified figure of its head, with its three frontal tentacula and eyes; 4, posterior extremity, dorsal aspect.

They are a delicacy of which the South Sea islanders are very fond. To prepare them for use, they are wrapped in bread-fruit leaves, and cooked for twelve or eighteen hours in an oven.

**PA'LPI** (from the Lat. *palpo*, I touch) are organs occurring in Insects, Crustaceans, and Arachnidans. In Insects, one or two pair of jointed appendages bearing this name are attached to the maxilla, while one pair is attached to the labium; and in the higher Crustaceans, similar appendages are attached to the mandibles and foot-jaws. In both these classes, the palpi probably serve, through the sense of touch, to take cognizance of the qualities of the substances which are employed as food. In the Arachnidans, the palpi are attached to the maxilla only; and vary exceedingly in form and functions. In the scorpions, for instance, they are extremely developed, and terminate in pincers which resemble the chela (or pincers) of crabs and lobsters; while in the spiders, they terminate in a single movable claw in the female, and in the male the last joint is dilated, and acts as an accessory generative organ.

**PALPITATION** is the term used to signify inordinately forcible pulsations of the heart, so as to make themselves felt, and frequently to give rise to a most troublesome and disagreeable sensation. It may be either functional or a symptom of organic disease of the heart. Here we shall merely consider it as a functional disorder. Although it may be persistent, it far more frequently comes on in paroxysms, which usually terminate within half an hour, recurring afterwards quite irregularly, sometimes daily or several times a day, and sometimes not till after a long interval. The attack often comes on under some mental or physical excitement, but sometimes when the patient is quite composed, or even asleep. If the paroxysm is a severe one, the heart feels as if bounding upwards into the throat; and there is a sensation of oppression over the cardiac region, with hurried or even difficult respiration. Excluding organic diseases, the causes of this affection are either (1) an abnormally excitable



condition of the nerves of the heart, or (2) an unhealthy condition of the blood.

1. Amongst the causes of disturbed innervation may be especially noticed the abuse of tea (especially green tea), coffee, spirits, and tobacco. Any irritation of the stomach and intestinal canal may be reflected to the heart; and hence palpitation may frequently be traced to flatulence, undue acidity, and intestinal worms, especially tape-worms. Everything that causes pressure on the heart, such as tight lacing, abdominal dropsy, or an enlarged uterus, is also liable to occasion this affection.

2. If the blood is abnormally rich and stimulating it may give rise to palpitation, as in Plethora (q. v.); but the opposite condition, known as Anæmia (q. v.), is a much more common cause of this affection. In anæmia the blood is watery and deficient in fibrine, and (far more) in red corpuscles; and being thus in an unnatural state, it acts as an unnatural stimulant, and induces frequent, although not usually strong pulsations. In cases of this kind, singular murmurs (not unlike those which are heard when we apply certain shells to the ear) are heard on applying the stethoscope to the neck over the course of the great jugular veins.

The age at which palpitation most usually comes on is from 15 to 25 years; and the affection—especially if it arise from anæmia—is very much more common in the female than in the male sex.

The treatment of palpitation must entirely depend upon its cause. The use of all nervous stimulants (tea, coffee, alcohol, and tobacco) should be suspended or abandoned. If the patient is clearly plethoric, with a full strong pulse, he should take saline cathartics, and live upon comparatively low diet (including little animal food) until this condition is removed. When, on the other hand, the palpitation is due to an anæmic condition, the remedies are preparations of iron, aloetic purgatives, an abundance of animal food, bitter ale, the cold shower-bath, and exercise, short of producing positive fatigue, in a pure bracing air. In the paroxysms, relief will often be afforded by the administration of a diffusible stimulant, such as ammoniated tincture of valerian, aromatic spirit of ammonia, &c.

PALSY. See PARALYSIS.

PALY. See PALE.

PAMLICO SOUND, a large bay on the coast of North Carolina, U.S., separated from the ocean by long, narrow islands of sand, an angle of the largest forming Cape Hatteras, and connected with the ocean by narrow passages, the chief of which is Ocracoke Inlet, and on the north with Albemarle Sound; it is 80 miles long, and from 10 to 30 miles wide, and receives the Neuse and Pamlico Rivers.

PAMPAS (in the Quichua tongue, 'a valley' or 'plain') is a term employed in a general sense as a designation of Southern American plains, in contradistinction to the 'prairies' of North America, and in this sense it is frequently employed by geographers. It is also used in Peru as a general designation of tracts of level land either on the coast or among the mountains, and in this sense occurs as a component of many proper names, being then transformed into *bamba*. The chief pampas in Peru are those of the Sacramento. But in its more special and proper signification, the word pampas is given to the immense and partly undulating plains bounded by the Rio Negro of Patagonia, the La Plata and Paraguay, and the base of the Cordilleras. These plains during the wet season afford abundant pasturage to the many herds of wild oxen and

horses which roam over them, but they become rapidly parched under the burning heat of the sun, except in the low-lying tracts, or along the banks of rivers. The most fertile of the pampas lie westwards towards the Cordilleras. From the rapid alternation of vigorous growth with parching drought, the growth of trees is impossible, and their place is accordingly supplied by sparse groups of stunted shrubs. The soil, which is in general poor, is a diluvium composed of sandy clay, and abounds in the bones of extinct mammals. Strips of waterless desert, known as *travesias*, stretch across the pampas; these *travesias* are destitute of all vegetation with the exception of a few bushes, and are markedly distinct in geological character. The soil of the pampas is more or less impregnated with salt, and saltpetre abounds in many places. The wild animals of the pampas are horses, oxen (both introduced by the Spaniards), mandous, and guanaco. The skins of the horses and oxen, and the flesh of the latter, form a most important item in the trade of this region. The half-white inhabitants of the pampas are called Guachos (q. v.). The whole area of the pampas has been estimated at about 1,500,000 square miles.

PAMPAS GRASS (*Gynerium argenteum*), a grass which covers the *pampas* in the south of Brazil and more southern parts of South America, and has been introduced into Britain as an ornamental plant. It is quite hardy, and its tufts have a splendid appearance. The leaves are six or eight



Pampas Grass (*Gynerium argenteum*).

feet long, the ends hanging gracefully over; the flowering stems ten to fourteen feet high; the panicles of flowers silvery white, and from eighteen inches to two feet long. The herbage is too coarse to be of any agricultural value. The male and female flowers are on separate plants; in panicles; the spikelets 2-flowered, one floret stalked, and the other sessile; the paleæ of the female florets elongated, awn-shaped, and woolly.—Another species

of the same genus, *G. saccharoides*, also a Brazilian grass, yields a considerable quantity of sugar.

**PAMPHLET** (variously derived from Spanish *papelota*, slip of paper on which anything is written, and *pagina filata*, threaded page), a small book consisting of a sheet of paper, or a few sheets stitched together, but not bound. It generally contains a short treatise on some subject, political or otherwise, which is exciting public attention at the time of its appearance. The word is of considerable antiquity, as it is to be met with in Chaucer; but it was not till about the middle of the 16th c. that pamphlets began to be of common use in political and religious controversy in England and France. Under the present French empire, political pamphlets appear from time to time which are generally believed to be written under imperial dictation, and either to speak the sentiments of the emperor, or to be feelers of public opinion.

**PAMPHYLIA**, anciently a country on the south coast of Asia Minor, with Cilicia on the east and Lycia on the west. It was originally bounded on the inland or northern side by Mount Taurus, but afterwards enlarged, so as to reach the confines of Phrygia. P. is mountainous, was formerly well wooded, and had numerous maritime cities. The inhabitants—a mixed race of aborigines, Cilicians, and Greek colonists—spoke a language the basis of which was probably Greek, but which was disfigured and corrupted by the infusion of barbaric elements. Their coins shew that they had adopted to some extent the religion, arts, and games of the Hellenic race. Its political history is unimportant. Along with Phrygia and Lycia it fell to the share of Antigonus on the partition of the Macedonian empire. It afterwards passed successively into the hands of the Græco-Syrian princes, the kings of Pergamus, and the Romans.

**PAMPLONA**, a fortified city of Spain, capital of Navarre, of which it is the key, occupies an eminence not commanded by any neighbouring height, on the left bank of the Arga, a tributary of the Ebro, 111 miles north-north-west of Zaragoza by railway, and 290 miles north-north-east of Madrid. The citadel, overlooking the river and commanding the plain, is a regular pentagon, each side being 1000 feet in extent, and is connected with the city by an esplanade or glacis. Magnificent views of the Pyrenees on the north are obtained from the citadel, and there are several very pleasant promenades. The *Cuenca* (plain) of P. is about 30 miles in circumference; and although the climate is somewhat chilly and damp, the gardens are fruitful and the meadows verdant. The city is well built and clean; water is brought from hills about nine miles distant, by means of an aqueduct built after the solid Roman style by Ventura Rodriguez, and a portion of which, 2300 feet in length, is supported on 97 arches, 35 feet in span, and 65 feet in height. The town contains a number of squares with fountains, a theatre, and the regular *plaza de toros*—bull arena—capable, it is said, of containing 10,000 people. Agriculture, the wine trade, and the manufacture of linens and leather are the only noteworthy branches of industry. Pop., with suburbs, 22,702.

P. was called by the ancients *Pompeiopolis*, from the circumstance of its having been rebuilt by the sons of Pompey in 68 B.C. It was taken by the Goths in 466, by the Franks under Childebert in 542, and again under Charlemagne in 778. It was subsequently for a time in possession of the Moors, who corrupted the name Pompeiopolis into *Bambilonah*, whence the modern Pamplona. In later times it was seized by the French in 1808, and held

by them till 1813, when it fell into the hands of the allies under the Duke of Wellington.

**PAN**, among the Greeks, the chief god of pastures, forests, and flocks. The later rationalising mythologists, misconceiving the meaning of his name, which they confounded with *to pan*, 'the whole,' or 'the universe,' whereas it is more probably connected with *pas* (Lat. *pasco*), 'to feed,' 'to pasture,' represented him as a personification of the universe, but there is absolutely nothing in the myth to warrant such a notion. Pan neither in his genius nor his history figures as one of the great principal deities, and his worship became general only at a comparatively late period. He was, according to the most common belief, a son of Hermes (Mercury) by the daughter of Dryops; or by Penelope, the wife of Ulysses; while other accounts make Penelope the mother, but Ulysses himself the father—though the paternity of the god is also ascribed to the numerous woovers of Penelope in common. The original seat of his worship was the wild hilly and wooded solitudes of Arcadia, whence it gradually spread over the rest of Greece, but was not introduced into Athens until after the battle of Marathon. Homer does not mention him. From his very birth his appearance was peculiar. He came into the world with horns, a goat's beard, a crooked nose, pointed ears, a tail, and goat's feet; and so frightened his mother that she ran off for fear, but his father, Hermes, carried him to Olympus, where all the gods, especially Dionysus (Bacchus), were charmed with the little monster. When he grew up, he had a grim shaggy aspect, and a terrible voice, which bursting abruptly on the ear of the traveller in solitary places—for Pan was fond of making a great noise—inspired him with a sudden fear (whence the word *panic*). It is even related that the alarm excited by his blowing upon a shell decided the victory of the gods over the Titans. He was the patron of all persons occupied in the care of cattle and of bees, in hunting and in fishing. During the heat of the day he used to take a nap in the deep woods or on the lonely hillsides, and was exceedingly wroth if his slumber was disturbed by the halloo of the hunters. He is also represented as fond of music, and of dancing with the forest nymphs, and as the inventor of the syrinx or shepherd's flute, also called Pan's pipe. Cows, goats, lambs, milk, honey, and new wine were offered to him. The fir-tree was sacred to him, and he had sanctuaries and temples in various parts of Arcadia, at Troezen, at Sicyon, at Athens, &c. The Romans identified the Greek Pan with their own Italian god Inuus, and sometimes also with Faunus. See FAUN.

When, after the establishment of Christianity, the heathen deities were degraded by the church into fallen angels, the characteristics of Pan—viz, the horns, the goat's beard, the pointed ears, the crooked nose, the tail, and the goat's feet—were transferred to the Devil himself, and thus the 'Auld Hornie' of popular superstition is simply Pan in disguise.

**PANAMA**, a city and seaport of the Granadian Confederation (New Granada), capital of the 'state' of the same name, at the head of the Bay of Panama, on the southern shore of the isthmus of the same name, in lat. 8° 56' N., long. 79° 31' W. It occupies a tongue of land which extends some distance out to sea in shallow waters. The harbour is safe, but vessels of more than 80 tons burden cannot approach within two miles of the shore. Large vessels anchor at a distance of three miles, near the island of Perico. The important edifices of the city include a beautiful cathedral, a college, and several convents, all of which, however, are falling into decay. There is considerable trade with

## PANAMA—PANCHATANTRA.

Europe in pearls, mother-of-pearl, shells, and gold-dust, obtained in the vicinity. P. is chiefly important, however, as the Pacific terminus of the Panama Railway. This railway was completed in 1855, is about 40 miles in length, and connects P. on the Pacific with Aspinwall colony on the Atlantic. By means of it the route to California is much shortened, and mails from the Pacific are much facilitated. Pop. about 10,000. The former city of P., the seat of the Spanish colonial government established in 1518, stood six miles north-east of the port of P., and is now a heap of ruins.

**PANAMA, ISTHMUS OF**, is that portion of the narrow ridge of mountainous country connecting Central and South America, which is bounded on the W. by the frontier of Costa Rica, and on the E. by the surveyed inter-oceanic route from the Bay of Caledonia on the N. to the Gulf of San Miguel on the S. or Pacific side. It extends in long. from 77° to 83° W. The 'State' of P., one of those which form the Granadian Confederation, is co-extensive with the isthmus of the same name. Area, 29,756; pop. estimated in 1861 at 175,000, exclusive of 8000 independent Indians. The Isthmus is traversed throughout by a chain of mountains forming the barrier between the Atlantic and Pacific Oceans, and of which the highest peak is that of Picacho (7200 feet) in the west. Numerous streams, the largest of which is the Tuira (162 miles long, and navigable for 102 miles), fall into both oceans. On the Pacific shores are numerous beautiful islands, among which Las Perlas, so called from their pearl fisheries, and the island of Coiba, are the chief. On the north coast, the principal harbours are the Chiriqui Lagoon, San Blas, and Caledonia; on the south shore, Damas in the island of Coiba, the Bay of San Miguel, and Golfo Dulce. Gold, which in ancient times was obtained here in great quantities, is still found, and mines of salt, copper, iron, coal, &c., are worked. The climate is unhealthy, except in the interior and on the flanks of the mountains. Almost all the plants of the torrid zone may be raised here, but maize, rice, plantains, &c. (grown for the purpose of supplying the transit), are the chief crops. Cotton of excellent quality is indigenous and perennial; cloth and grass hammocks, grass (Panama) hats, matting, &c., are manufactured. Commerce, however, affords the principal employment.

In 1855 a railway across the Isthmus, from Aspinwall city on the Atlantic to Panama on the Pacific, was opened. See PANAMA. The Isthmus has frequently been surveyed with the object of finding a route for an inter-oceanic canal. As yet the inability of the government of New Granada to provide the requisite funds has stood in the way of the accomplishment of this design. The scheme of an inter-oceanic canal, however, is a practicable one, and in time it will in all probability be carried out.

**PANATHENÆA**, the most famous festival of Attica, celebrated at Athens in honour of Athene, patron goddess of the city, and intended to remind the people of Attica of their union into one community by the mythical Theseus. Before the time of Theseus, or—to speak more critically—before the formation of the Attic confederacy, this festival was only for the citizens of Athens, and was called simply *Athenæa*. According to tradition, the Athenæa owed its origin to King Erichthonius about 1506 or 1521 B. C. The later Panathenæa appears to have been a double festival. All writers who mention it, speak of a Lesser and Greater Panathenæa, the former held annually, the latter every fourth year. Both took place in the month *Hecc-*

*tombæon* (July), and lasted several days. The Lesser Panathenæa was celebrated with gymnastic games, musical competitions, declamations, and a torch race in the evening, the whole concluding with the sacrifice of an ox. The prize of the victors was a vessel filled with oil from the sacred tree on the Acropolis. The Greater Panathenæa only differed from the Lesser in being more solemn and magnificent. Rhapsodists sang the Homeric poems; dramatic representations were given; and a splendid procession took place to the temple of Athene Polias, on the last day of the festival, to present the goddess with a *peplus* or embroidered robe, of crocus colour, woven by the maidens (*ergastinai*) of the city. Not alone the Athenians, but the whole population of Attica poured forth on this occasion. The procession is grandly sculptured on the frieze of the Parthenon by Phidias and his disciples.

**PA'NAX.** See GINSENG.

**PA'NCAKE.** This article of food is prepared by pouring a rich batter of flour, eggs, and milk into a frying-pan, so as to cover it about half an inch in thickness; the pan having been previously heated, and well supplied with butter, lard, or olive oil. A quick fire is necessary to cook it well, and when the under side is done, a dexterous cook by jerking the frying-pan manages to reverse the cake, so as to bring the upper side downward to be cooked in its turn. It is now a common practice to make pancakes rather smaller than the bottom of the pan, and frequently to add minced apples and other materials to vary and flavour them; these are, however, better known under the name of Fritters.

This dish is particularly associated with Shrove Tuesday, but the origin of the connection is by no means clear. Perhaps it is the relic of a heathen custom. The Saxons called February, *Solmonath*, 'which,' says a writer in *Notes and Queries* (First Series, vol. v. p. 491), 'Dr Frank Sayers, in his *Disquisitions*, says is explained by Bede, *Mensis Placentarum*, and rendered by Spelman, in an inedited MS., "Pancake month," because, in the course of it, pancakes were offered by the pagan Saxons to the sun.'

**PANCHATANTRA** (literally, the five books) is the name of the celebrated Sanscrit fable-book of the Hindus whence the *Hitopadesa* (q. v.) was compiled and enlarged. Its authorship is ascribed to a Brahman of the name of Vishn'us'arman, who, as its introduction in a later recension relates, had undertaken to instruct, within six months, the unruly sons of Amaras'akti, a king of Mahilāropya or Mihilāropya, in all branches of knowledge required by a king, and for this purpose composed this work. If the latter part of this story be true, it is more probable, however, as Professor Benfey assumes, that Vishn'us'arman was merely the teacher of the princes, and that the existing work itself was composed by some other personage; for an older recension of the work does not speak of his having brought his tales into the shape of a work. The arrangement of the P. is quite similar to that of the *Hitopadesa*. The fables are narrated in prose, and the morals drawn from or connected with them are interwoven with the narrative in verse; many such verses, if not all, being quotations from older works.—On the history of the P., and its relation to the fable-books and fables of other nations, see the excellent work of Professor Theodor Benfey, *Panchatantra: fünf Bücher indischer Fabeln, Märchen und Erzählungen* (2 vols., Leip. 1859), the first volume containing; his historical and critical researches on, and the latter

## PANCREAS—PANDANACEÆ.

his literal translation into German of, the *Pan-chalantia*.

**PANCREAS** (from the Gr. *pan*, all, and *kreas*, flesh) is a conglomerate gland, lying transversely across the posterior wall of the abdomen, varying in



The under surface of the Stomach and Liver, which are raised to shew the Duodenum and Pancreas :

*s*, stomach; *p*, its pyloric end; *l*, liver; *g*, gall-bladder; *d*, duodenum, extending from the pyloric end of the stomach to the front, where the superior mesenteric artery (*sm*) crosses the intestines; *pa*, pancreas; *sp*, spleen; *a*, abdominal aorta.

length from 6 to 8 inches, having a breadth of about an inch and a half, and a thickness of from half an inch to an inch. As may be seen in the figure, it bears a slight resemblance in shape to a hammer; its right extremity, forming the *head* of the gland, being broad, and bent downwards at a considerable angle from the *body*, which terminates leftwards in a tapering end, termed the *tail*, extending as far as the spleen. Its usual weight is about three ounces. The head of the pancreas lies in the concavity of the duodenum.

The secretion of this gland, or the pancreatic fluid, is conveyed from its various parts by means of the pancreatic duct or canal of Wirsung (its discoverer) to the duodenum, into the descending portion of which it enters by an orifice common to it and to the common biliary duct. In various mammals, and occasionally in man, the pancreatic and biliary ducts open separately into the intestine. This gland is found in all mammals, birds, reptiles, amphibians, and osseous fishes, and in some cartilaginous fishes.

The physical and chemical characters of the pancreatic fluid, and its uses in the animal economy, are sufficiently noticed in the article DIGESTION.

The diseases of the pancreas are few, and do not signify their existence by any very marked symptoms. The presence of undigested fat in the stools has been frequently observed in cases in which after death the pancreas has been found to be diseased; and if Bernard's views regarding the saponifying power of the pancreatic juice on fatty matters (described in the article already referred to) be correct, the reason why the fat should appear in the evacuations in these cases is sufficiently obvious. The most common form of disease is cancerous deposit in the head of the gland, which frequently induces jaundice by obstructing the common biliary duct near its opening. An accurate diagnosis of disease of this organ is extremely difficult, but fortunately is of comparatively little importance, as it cannot lead to efficient treatment; all that can be done in these cases being to palliate the most distressing symptoms.

**PANC SOVA**, an active trading town of Austria, in the Servian military frontier, 70 miles south-south-west of Temesvar, and close to the mouth of the Temes in the Danube, which is here a mile wide. It is a military station, contains several churches, a

high school, and a quarantine establishment. Silk spinning, brandy distilling, and an active trade in cattle, pigs, and corn are carried on. Pop. 11,000.

**PANDA** (*Ailurus fulgens*), a quadruped of the family *Ursidæ* (see BEAR), a native of the Himalaya, the only known species of its genus, which has a very short muzzle, small rounded ears, a moderately long tail, covered with long hair, semi-retractile claws. The P. is about the size of a large cat. It dwells chiefly in trees, preying much on birds, but it also eats small quadrupeds and large insects. It has a thick, fine, woolly covering, adapting it to a cold climate, concealed by long, soft, glistening, and richly coloured hair, mostly chestnut brown, which passes into black on the sides and legs, and into white on the head. The P. is said to excel all other animals in the brilliancy of its fur, which, however, has not yet



Panda (*Ailurus fulgens*).

acquired any commercial value. The soles of the feet are thickly covered with woolly hair. The P. is also called *Wah* and *Chit-wa*, from a peculiar cry which it utters.

**PANDANACEÆ**, a natural order of endogenous plants, constituting a remarkable feature in the scenery of many tropical countries, but unknown in the colder regions of the globe. They are trees or bushes, often sending down adventitious roots, sometimes weak and decumbent, or climbing. There are two sections of the order, one (*Pandaneæ*) including the genera *Pandanus*, *Freyinetia*, &c., having long, simple, imbricated leaves, usually spiny on the back and margin, their base embracing the stem, their spiral arrangement often notably visible; the other (*Cyclanthææ*) containing the genera *Cyclanthus*, *Nipa* (q. v.), *Carludovica*, *Phytelphos*, &c., having pinnate or fan-shaped leaves, and in general appearance much resembling palms, with which they have been often ranked. The two sections, however, are very similar in their flowers and fruit, in which they not a little resemble the humbler *Araceæ* and *Typhaceæ*. The flowers are mostly unisexual, naked, or with only a few scales, arranged on a spadix, and wholly covering it. The stamens are numerous; the ovaries usually clustered, one-celled, each crowned with a stigma; the fruit consists of fibrous, one-seeded drupes, collected or almost combined, or of berries with many seeds.—There are not quite 100 known species. Some are valuable for the fibre of their leaves, some for their edible fruit, &c. See SCREW PINE, KIRKIE, and NIPA. The unexpanded leaves of *Carludovica palmata* furnish the material of which *Panama hats* are made. The tree which

yield; **VEGETABLE IVORY** (q. v.) is another of the palm-like section of this order.

**PĀN'DAVAS**, or the descendants of Pān'd'u (q. v.), is the name of the five princes whose contest for regal supremacy with their cousins, the Kurus (q. v.), the sons of Dhṛitarāshṭra, forms the foundation of the narrative of the great epic poem, the *Mahābhārata* (q. v.). Their names are *Yudhisht'hira*, *Bhīma*, *Arjuna*, *Nakula*, and *Sahadeva*—the former three being the sons of Pān'd'u, by one of his wives, Prithā; and the latter two, by his other wife, Mādrī. But though Pān'd'u is thus the recognised father of these princes, the legend of the *Mahābhārata* looks upon him, in truth, merely as their father by courtesy; for it relates that Yudhisht'hira was the son of Dharma, the god of justice; Bhīma, of Vāyu, the god of wind; Arjuna, of Indra, the god of the firmament; and Nakula and Sahadeva, of the As'wins, the twin-sons of the sun.

**PANDECTS** (Gr. *Pandecton*, all receiving; from *pan*, all, and *dechomai*, I receive), one of the celebrated legislative works of the Emperor Justinian (q. v.), called also by the name *Digestum*, or *Digest*. It was an attempt to form a complete system of law from the authoritative commentaries of the jurists upon the laws of Rome. The compilation of the Pandect was undertaken after that great collection of the laws themselves which is known as the Codex Justinianus. It was intrusted to the celebrated Tribonianus, who had already distinguished himself in the preparation of the Codex. Tribonianus formed a commission consisting of 17 members, who were occupied from the year 530 till 533 in examining, selecting, compressing, and systematising the authorities, consisting of upwards of 2000 treatises, whose interpretation of the ancient laws of Rome was from that time forward to be adopted with the authority of law. A period of ten years had been allowed them for the completion of their work; but so diligently did they prosecute it, that it was completed in less than one-third of the allotted time; and some idea of its extent may be formed from the fact that it contains upwards of 9000 separate extracts, selected according to subjects from the 2000 treatises referred to above.

The Pandects are divided into 50 Books, and also into 7 Parts, which correspond respectively with Books 1—4, 5—11, 12—19, 20—27, 28—35, 36—44, and 45—50. Of these divisions, however, the latter (into Parts) is seldom attended to in citations. Each Book is subdivided into Titles, under which are arranged the extracts from the various jurists, who are 39 in number, and are by some called the classical jurists, although other writers on Roman law confine that appellation to five of the number, Papinian, Paulus, Ulpian, Gaius (q. v.), and Modestinus. The extracts from these indeed constitute the bulk of the collection; those from Ulpian alone making one-third of the whole work, those from Paulus one-sixth, and those from Papinian one-twelfth. Other writers besides these 39 are cited, but only indirectly, i. e., when cited by the jurists whose works form the basis of the collection. The principle upon which the internal arrangement of the extracts from individual writers was made had long been a subject of controversy. The question seems now to be satisfactorily solved; but the details of the discussion would carry us beyond the prescribed limits. Of the execution of the work, it may be said that although not free from repetition (the same extracts occurring under different heads), and from occasional inaptness of citation, and other inconsistencies, yet it deserves the very highest commendation. In its relations to the history and literature of ancient Rome it is invaluable; and

taken along with its necessary complement the Codex, it may justly be regarded (having been the basis of all the medieval legislation) as of the utmost value to the study of the principles not alone of Roman, but of all European law.

**PANDORA** (i. e., the 'All-endowed'), according to Grecian myth, was the first woman on the earth. When Prometheus had stolen fire from Jupiter, Zeus instigated Hephestus to make woman out of earth to bring vexation upon man by her graces. The gods endowed her with every gift necessary for this purpose, beauty, boldness, cunning, &c.; and Zeus sent her to Epimetheus, the brother of Prometheus, who forgot his brother's warning against receiving any gift from Zeus. A later form of the myth represents P. as possessing a vessel or box filled with winged blessings, which mankind would have continued to enjoy if curiosity had not prompted her to open it, when all the blessings flew out, except Hope.

**PANDOURS**, a people of Servian origin who live scattered among the mountains of Hungary, near the village of Pandour in the county of Sohl. The name has been applied to that portion of the light-armed infantry in the Austrian service which is raised in the Slavonian districts on the Turkish frontier. The P. originally fought under the orders of their own proper chief, who was called Harūn-Basha, and rendered essential service to the Austrians during the Spanish War of Succession, and afterwards in the Seven Years' War. They originally fought after the fashion of the 'free lances,' and were a terror to the enemy whom they annoyed incessantly. Their appearance was exceedingly picturesque, being somewhat oriental in character, and their arms consisted of a musket, pistols, a Hungarian sabre, and two Turkish poniards. Their habits of brigandage and cruelty rendered them, however, as much a terror to the people they defended as to the enemy. Since 1750 they have been gradually put under a stricter discipline, and are now incorporated with the Austrian frontier regiments.

**PĀN'D'U**, literally, 'white,' is the name of the father of the Pān'd'avas (q. v.), and the brother of Dhṛitarāshṭra. Although the elder of the two princes, he was rendered by his 'pallor'—implying, perhaps, a kind of disease—incapable of succession, and therefore obliged to relinquish his claim to his brother. He retired to the Himalaya Mountains, where his sons were born, and where he died. His renunciation of the throne became thus the cause of contest between the Pān'd'avas, his sons, and the Kurus, or the sons of Dhṛitarāshṭra.

**PANEL** (through Fr. from Lat. *pannus*, a piece

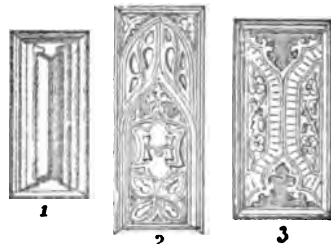

Panels.

of cloth, a patch), a space or compartment of a wall, ceiling, woodwork, &c., enclosed by beams, mouldings, framing, and so forth. It is generally sunk under the plane of the surrounding styles. In

woodwork, panels are thinner parts used to fill in strong framing, as in doors, shutters, &c. These are sometimes highly ornamented with tracery, shields, &c. (as in figs. 2 and 3). In late Gothic architecture, the panel is very often carved into the 'linen pattern' (fig. 1). Panelling is a style of ornament greatly used in Elizabethan architecture. The ceilings and walls are covered with it, and every piece of furniture is cut up into panels of every variety of form. Panels are said to be 'fielded' when the centre of the panel is raised with mouldings, &c.

**PANEL** (properly the slip or 'pane' of parchment on which the names of the jurors are written) is, in the practice of the English law, used to denote the body or set of jurors, consisting of 12 men, who try a cause, civil or criminal. In Scotch criminal law, the prisoner is usually called the panel.

**PANGÉ LINGUA** (Lat. 'Proclaim, O Tongue'), one of the most remarkable of the hymns of the Roman Breviary, and like its kindred hymn, *Lauda Sion*, a most characteristic example as well of the medieval Latin versification as of that union of theology with asceticism, which a large class of these hymns present. The Pangé Lingua is a hymn in honour of the Eucharist, and belongs to the service of the Festival of Corpus Christi. It is from the pen of the great angelic doctor, Thomas Aquinas (q. v.), and consists of six strophes of verses in alternate rhyme. Besides its place in the office of the Breviary, this hymn forms part of the service called Benediction with the Blessed Sacrament, and is sung on all occasions of the exposition, procession, and other public acts of Eucharistic worship.

**PA'NGOLIN**, or **PENGOLIN**, a name sometimes extended to all the species of *Manis* (q. v.), but originally belonging to *M. pentadactyla*, also called **SHORT-TAILED MANIS**, and in some parts of India **BAJJEKKEIT**; this species being a native of most parts of the East Indies, and P., its Malayan name, derived from a word which signifies to roll up; the animal having the habit of rolling itself up, on



Pangolin (*Manis pentadactyla*).

apprehension of danger, into a compact ball, the head in the centre, and its muscular mail-covered tail enfolding all. The food of the P. consists chiefly of ants, and like the rest of the genus, it is entirely destitute of teeth, and has a round, extensible tongue. Its claws are long and strong; it doubles them up like the American ant-eaters when it walks. It resides in burrows, which it excavates to the depth of seven or eight feet in the ground. It is capable of climbing trees, and the tail is prehensile. The whole length of the animal, including the tail, is almost five feet, the tail being not quite half the length of the body.

It is a gentle animal, easily tamed, and of an affectionate disposition.

**PANIC** is where fear, whether arising from an adequate or inadequate cause, obtains the mastery over every other consideration and motive, and urges to dastard extravagance, or hurries into danger, or death. An inexplicable sound causes a rush from a church, a vague report in the marketplace causes a run on a bank, and precipitate the very events that are dreaded. This emotion either differs from natural apprehension, or presents so intense and uncontrollable a form of the feeling, that it is propagable from one person to another, and involves alike the educated and ignorant—those who act from judgment as well as those who act from impulse. There are, besides this feature, several grounds for believing that such manifestations of involuntary terror are of morbid origin, and should be regarded as moral epidemics. They have generally arisen during, or have followed, seasons of scarcity and physical want and disease, the ravages of war, or periods of great religious fervour and superstition. The dancing mania, the retreat of the French army from Moscow, and recent and familiar commercial panics afford illustrations of certain of these relations. The most notable instance of universal panic, and that which demonstrates most aptly the connection here indicated, is the dread of the approaching end of the world which pervaded all minds, and almost broke up human society in the 10th century. The empire of Charlemagne had fallen to pieces; public misfortune and civil discord merged into misery and famine so extreme that cannibalism prevailed even in Paris; superstitious and vague predictions became formalised into a prophecy of the end of all things and universal doom in the year 1000. This expectation suspended even vengeance and war. The 'truce of God' was proclaimed. Enormous riches were placed upon the altars. Worship and praise never ceased. The fields were left uncultivated; serfs were set free; four kings and thousands of nobles retired to the cloister; and all men, according to their tendencies, prepared to die.

It is worthy of note that during all pestilences there have arisen epidemic terrors, not so much of the devastations of disease, as of plots and poisonings directed by the rich against the poor. Even where these epidemic terrors are legitimately traceable to local and physical causes, as in the case of the singular affection tinoria, which occurs in the marshy and unhealthy districts in Sardinia, the tremor and trepidation, and other phenomena, are ascribed to the magical influence of enemies.

**PANICLE**, in Botany, a mode of inflorescence (q. v.) in which the floral axis is not only divided, but also subdivided more or less frequently. The panicle may thus be regarded as a Raceme (q. v.), of which the branches (or flower-stalks) are branched. The panicle is a very common kind of inflorescence. Most of the grasses exhibit it, and many other plants, both endogenous and exogenous. The common lilac affords a good example of it. The panicle, variously modified as to its form, and the arrangement and relative lengths of its branches and branchlets, becomes a Cyme (q. v.), Thyrsus (q. v.), &c.

**PANICUM**. See MILLET.

**PĀNINI**, the greatest known grammarian of ancient India, whose work on the Sanscrit language has up to the present day remained the standard of Sanscrit grammar. Its merits are so great, that P. was ranked among the R'shis (q. v.), or

inspired seers, and at a later period of Sanscrit literature, was supposed to have received the fundamental rules of his work from the god Śiva himself. Of the personal history of P., nothing positive is known, except that he was a native of the village Śālatura, situated north-west of Attock, on the Indus—whence he is also surnamed Śālaturīya—and that his mother was called Dākṣhī, wherefore, on his mother's side, he must have been a descendant of the celebrated family of Dakṣha. A tale-book, the *Kathāsaritāgāra* (i. e., the ocean for the rivers of tales), gives, indeed, some circumstantial account of the life and death of P.; but its narrative is so absurd, and the work itself of no modern a date—it was written in Caahmere, at the beginning of the 12th c.—that no credit whatever can be attached to the facts related by it, or to the inferences which modern scholars have drawn from them. According to the views expressed by Goldstücker (*Pānini, his Place in Sanscrit Literature*: London, 1861), it is probable that P. lived before Śākyamuni, the founder of the Buddhist religion, whose death took place about 543 B.C., but that a more definite date of the great grammarian has but little chance of ascertainment in the actual condition of Sanscrit philology.—The grammar of P. consists of eight *Adhyāyas*, or books, each book comprising four *Pādas*, or chapters, and each chapter a number of *Sūtras* (q. v.), or aphoristical rules. The latter amount in the whole to 3996; but three, perhaps four, of them did not originally belong to the work of Pānini. The arrangement of these rules differs completely from what a European would expect in a grammatical work, for it is based on the principle of tracing linguistic phenomena, and not concerned in the classification of the linguistic material, according to the so-called parts of speech. A chapter, for instance, treating of a prolongation of vowels, will deal with such a fact wherever it occurs, be it in the formation of bases, or in conjugation, declension, composition, &c. The rules of conjugation, declension, &c., are, for the same reason, not to be met with in the same chapter or in the same order in which European grammars would teach them; nor would any single book or chapter, however apparently more systematically arranged—from a European point of view—such as the chapters on affixes or composition, suffice by itself to convey the full linguistic material concerned in it, apart from the rest of the work. In a general manner, P.'s work may therefore be called a natural history of the Sanscrit language, in the sense that it has the strict tendency of giving an accurate description of facts, instead of making such a description subservient to the theories according to which the linguistic material is usually distributed by European grammarians. Whatever objections may be raised against such an arrangement, the very fact of its differing from that in our grammars makes it peculiarly instructive to the European student, as it accustoms his mind to survey language from another point of view than that usually presented to him, and as it must induce him, too, to question the soundness of many linguistic theories now looked upon as axiomatic truths. As the method of P. requires in a student the power of combining many rules scattered all over the work, and of combining, also, many inferences to be drawn from these rules, it exercises, moreover, on the mind of the student an effect analogous to that which is supposed to be the peculiar advantage of the study of mathematics. The rules of P. were criticised and completed by Kātyāyana (q. v.), who, according to all probability, was the teacher, and therefore the contemporary, of Patanjali; and he, in his turn, was criticised by Patanjali (q. v.),

who sides frequently with Pānini. These three authors are the canonical triad of the grammarians of India; and their works are, in truth, so remarkable in their own department, that they exceed in literary merit nearly all, if not all, grammatical productions of other nations, so far as the two classes are comparable. The rules of P. were commented on by many authors. The best existing commentary on them is that called the *Kaśīkāvṛtti*, by Vāmana Jayāditya, which follows these rules in their original order. At a later period, attempts were made to arrange the rules of P. in a manner which approaches more to the European method; the chief work of this category is the *Siddhānta-Kaumudī*, by Bhaṭṭo-ji-dikṣhita. P. mentions, in his *Sūtras*, several grammarians who preceded him, amongst others, Śākatāyana. Manuscripts of a grammar ascribed to a grammarian of this name exist in the Library of the India Office in London, and in the Library of the Board of Examiners at Madras. On the ground of a few pages only of the latter an attempt has been very recently made to prove that this grammar is the one referred to by P., and therefore older than the work of the latter. But the facts adduced in proof of this hypothesis are so ludicrously weak, and the reasoning upon them so feeble and inconclusive, whereas the evidence in favour of the comparatively recent date of this work is so strong, that no value whatever can be attached to this hasty hypothesis. For the present, therefore, P.'s work still remains the oldest existing grammatical work of India, and probably of the human race. The *Sūtras* of P., with a modern commentary by two native pandits, and with extracts from the *Vārttikas* of Kātyāyana and the *Mahābhāṣya* of Patanjali, were edited at Calcutta in 1809. This edition, together with the modern commentary, but with garbled extracts from the extracts mentioned, was reprinted at Bonn in 1839—1840 by Dr O. Boehtlingk, who added to it remarks of his own and some indices.—For the literature connected with P., see Colebrooke's preface to his *Grammar of the Sanscrit Language* (Calc. 1805), and Goldstücker's *Pānini, &c.*, as mentioned above.

PANIPUT, the chief town of a district of the same name in the province of Delhi, is situated 54 miles (by road 78 miles) north by west from Delhi, in a fertile tract, the resources of which are largely developed by artificial irrigation. Pop. (1853) 22,612. Being a station on the great military road between Afghanistan and the Punjab, and to some extent an outpost of Delhi, it has been at various times the scene of strife between the inhabitants of India and invaders. The first great battle of P. was fought in 1526, and gained by Mirza Baber, the ex-ruler of Ferghana, at the head of 12,000 Mongols, over Ibrahim the emperor of Delhi, whose unwarlike array numbered 100,000 men, with 1000 elephants. This victory seated Baber on the throne of Hindustan as the first of the 'Great Mogul' dynasty. The second great battle was fought, in 1556, by the Mongols under Akbar, grandson of Baber, and third of the Mogul emperors, against Hemu, an Indian prince who had usurped the throne of Delhi. Hemu's army was defeated with great slaughter, and himself slain. The third battle was fought on the 14th of January 1761, between Ahmed Abdalli, ruler of Afghanistan, and the till then invincible Mahrattas. The Jats, who had been forced to join the Mahrattas, deserted to the Afghans at a time when victory seemed to be declaring for the former; and this act of treachery, together with the loss of their leaders, threw the Mahrattas into confusion, and in spite of their most resolute valour they suffered a total defeat.

They left 50,000 slain on the field of battle, including all their leaders except Holkar, and 30,000 men were killed in the pursuit, which was continued for four days. The Mahrattas never recovered this crushing blow. It was at Kurnaul, a town a little to the north of P., that Nadir Shah of Persia, in 1739, won the celebrated battle over the Mogul emperor, which placed North-Western India at his feet.

PANIZZI, ANTONIO, principal librarian of the British Museum, was born, on the 16th of September 1797, at Brescello, in the *ci-devant* duchy of Modena. For his education he was sent first to the public school of Reggio, and afterwards to the university of Padua, where, in 1818, he took the degree of Doctor of Laws, with a view to practising at the bar. Early in life his sympathies were enlisted on behalf of the friends of Italy, as opposed to domestic tyranny and foreign intrusion, and when, in 1821, the popular revolution broke out in Piedmont, the young advocate became one of its leaders. The attempt, however, failed; and P., who had been denounced by a pretended friend, was arrested at Cremona. Having by some means contrived to escape, he took refuge in Lugano, and from thence in a short time found his way to Geneva. Meanwhile, during his absence, he was tried at home *per contumaciam*, as it is called, and sentenced to death, with confiscation of property. Nor was he allowed to remain at Geneva. The governments of Austria and Sardinia demanded from the Swiss Confederation the expulsion of all concerned in the recent outbreak, and among these P. was obliged to depart. Forbidden to pass through France, he reached England by way of Germany and the Netherlands. He now resided for about a month in London, whence he proceeded to Liverpool, with an introduction from Ugo Foscolo to Roscoe the historian, who received him with the utmost hospitality. At Liverpool, where he was introduced into the best circles by Mr Roscoe, he taught Italian, and continued to reside in that town until 1828, when he came to London again, and was chosen professor of Italian in the university of London, just then opened for students. In 1831, through the instrumentality of Lord Brougham, he was appointed one of the assistant-librarians in the British Museum; and upon the retirement of the Rev. Mr Baber, in 1837, from the office of Keeper of the Printed Books, Mr P. was appointed his successor. In the previous year there had been a parliamentary committee on the state of the British Museum, before which Mr P. gave valuable evidence, and likewise urged the adoption of measures for the improvement and augmentation of the library, which, upon becoming keeper, he was in a still better position to advocate. In 1838 he superintended the removal of the printed books from the old suite of rooms in Montague House to the new library; and in the same year, in conjunction with some of his assistants, he drew up the well-known 91 rules for the formation of a new catalogue of the library. These rules were approved by the trustees, and the first volume of a catalogue framed after them was printed and published in 1841. No other volume has been since published, and Mr P., before a royal commission of inquiry into the Museum in 1847, justified the suspension of the printing until the whole catalogue should be finished. In 1845, Mr P. drew up an elaborate report of the deficiencies existing in the library, in consequence of which the trustees applied to the Lords of the Treasury for 'an annual grant of £10,000 for some years to come, for the purchase of books of all descriptions.' This grant having been obtained, the library rapidly increased in numbers, to such a degree that in 1849 the books

amounted to 435,000, as compared with 235,000, the ascertained number in 1838. The number of volumes is now estimated at between 600,000 and 700,000. Upon the resignation of Sir H. Ellis, in 1856, Mr P. was appointed to the post of principal librarian of the British Museum, which office he still holds. In a literary capacity, Mr P. is known by an edition of the *Orlando Innamorato di Boiardo*, and *Orlando Furioso di Ariosto: with an Essay on the Romantic Narrative Poetry of the Italians, Memoirs and Notes*, by A. Panizzi (9 vols. Lond. 1830—1834). He has also edited the *Sonetti e Canzoni* of Boiardo (Lond. 1835), and a collection of reprints of the first four editions of the *Divina Commedia*, printed at the expense of Lord Vernon (Lond. 1859). He is also the author of a privately-printed pamphlet, *Chi era Francesco da Bologna*, tending to prove the identity of the type-founder employed by Aldus, and the inventor of the well-known Aldine or Italic type, with the celebrated painter Francesco Francia. Mr P. is also understood to have written some articles of literary or historic character for more than one of the Quarterly Reviews.

PA'NJIM. See GOA.

PA'NNAH, or PU'NNAH, a decayed town of India, in the district of Bundelcund, stands on the north-eastern slope of a plateau, 115 miles south-west of Allahabad. It was formerly a large, thriving, and well-built town; but whole streets are now desolate, or are tenanted only by monkeys, which, posted on the roof or at the windows, view the town's-people without alarm. The palace of the rajah is a beautiful building, surmounted by elegant kiosks, but is in many places ruinous. The source of the former prosperity of P. was its rich diamond mines. Owing to the diminished value of the gem, however, and the increased tax upon the produce of the mines, this branch of industry has much fallen off. The diamonds are generally tinted with colour; very few of them being of first-water, or completely colourless. This town is the chief place of a territory of the same name, which is bounded on the north by the British district of Banda, and on the south by the British district of Nerbudda. See BUNDELCUND.

PANNELS, in Artillery, are the carriages upon which mortars and their beds are conveyed on a march.

PANNO'NIA, a province of the ancient Roman empire, bounded on the N. and E. by the Danube, on the W. by the mountains of Noricum, and on the S. reaching a little way across the Save; and thus including part of modern Hungary, Slavonia, parts of Bosnia, of Croatia, and of Carniola, Styria, and Lower Austria. It received its name from the Pannonians, a race of doubtful origin, but who at first dwelt in the country between the Dalmatian Mountains and the Save, in modern Bosnia, and afterwards more to the south-east in Moesia. The Roman arms were first turned against them and their neighbours, the Iapydes, by Augustus in 35 B.C., and after the conquest of Segestica or Siscia (Siszek) he subdued them. An insurrection took place in 12 B.C., which Tiberius crushed after a long struggle; and a more formidable one of the Dalmatians and Pannonians together in 6 A.D., which was suppressed by Tiberius and Germanicus, but not till 8 A.D. Fifteen legions had to be assembled against the Pannonians, who mustered 200,000 warriors. Hereupon the Pannonians settled in the more northern countries, which received their name, and of which the former inhabitants, the Celtic Boii, had been in great part destroyed in Cæsar's time. The country was now formed into a Roman



provinces, which was secured against the inroads of the Marcomanni and Quadi by the Danube, and on its other frontiers had a line of fortresses. Military roads were constructed by the conquerors, who also planted in the country many colonies and municipia, and thus gave it a rough coating of civilisation. Great numbers of the Pannonian youth were drafted into the Roman legions, and proved, when disciplined, among the bravest and most effective soldiers in the imperial army. P. was subsequently divided into Upper (or Western) and Lower (or Eastern) P., and under Galerius and Constantine underwent other changes. Upper Pannonia was the scene of the Marcomannic war in the 2d century. In the 5th c. it was transferred from the Western to the Eastern Empire, and afterwards given up to the Huns. After Attila's death, in 453, the Ostrogoths obtained possession of it. The Longobards under Alboin made themselves masters of it in 527, and relinquished it to the Avari upon commencing their expedition to Italy. Slavonian tribes also settled in the south. Charlemagne brought it under his sceptre. In the reigns of his successors, the Slavonians spread northward, and the country became a part of the great Moravian kingdom, till the Magyars or Hungarians took it in the end of the 9th century. In the time of the Romans, Siscia (Siszek), Vindobona (Vienna), Carnuntum (near Hamburg), and Arrabo (Raab) were among its principal towns.

**PANORAMA** (Gr. *pan*, all, *orama*, a view), a pictorial representation of the whole surrounding landscape as seen from one point. The invention of the panorama is claimed by the Germans for Professor Breisig of Danzig, but it does not appear that he ever constructed one. The real inventor was Mr Barker, an ingenious artist of Edinburgh, to whom the idea occurred while taking a sketch of the city from the top of Arthur Seat. After surmounting numerous difficulties—one of which was the invention of a new kind of perspective for the horizontal lines—he succeeded in producing an effective panoramic view of Edinburgh, which was exhibited in that city in 1788, and in London in the following year. The next panorama executed by Barker was a view of London from the top of the Albion Mills. A large building was now erected in Leicester Square for the exhibition of such views. On Mr Barker's death in 1806, he was succeeded by his son, in partnership with a pupil, Mr Burford, the painter of the chief modern panoramas. The first step in the construction of a panorama is to obtain sketches of the entire region to be represented; each sketch is a representation of a portion of the landscape in the form of a sector of a circle, with the sketcher's position as a centre, and the horizon for circumference. The canvas to which the sketches are to be transferred is hung round the sides of a circular room, and forms the surface of a cylinder, on the inside of which the panorama is painted. The canvas, brushes, &c., are of the finest description manufactured, and the painting and colouring are elaborated in the most careful manner, in order to render the optical illusion—which every one who has seen a good panorama must have experienced—as complete as possible. The stage from which the picture is viewed is placed in the centre of the room, about 30 feet on every side from the picture; the picture itself is fastened above to a strong circular hoop, and, hanging down, has its lower edge fastened to a similar hoop, which is heavily weighted to keep the picture steady. The light is admitted by an aperture in the roof, which is concealed by an awning from the spectators on the stage. Notwithstanding important defects in the panorama, one of which is

that the light more strongly illumines the upper than the lower parts of the picture—thus throwing the foreground comparatively into shade—many cases are on record of spectators being for the time completely under the influence of mental illusion. One of the best instances of this occurred during the exhibition of the third panorama in London. Part of the view consisted of a representation of the wreck of a ship's boat, with sailors struggling in the waves; and at sight of this, a dog belonging to one of the spectators at once leaped over the handrail to the rescue of the supposed drowning men. Panoramas, though frequently exhibited in France, Germany, and other European countries, have met with little success out of Great Britain. The most popular panorama ever executed was that of the Battle of Waterloo, the exhibition of which brought in ten thousand pounds. There are many modifications of the panorama, but that above described is the most important.

**PANSLAVISM.** This term is applied to the movement lately set on foot, and generally ascribed to Russian influence, for the amalgamation of all races of Slavonic descent into one body, having one language, one literature, and one social polity. The writings of Adam Gurowski and Kollar, and the anonymous pamphlet which appeared at Leipzig in 1837, under the title of *Die Europäische Pentarchie*, have exercised a very widespread influence in this direction among all the Slavonic people of the German states; and although the other nations of Europe have hitherto had no reason to anticipate any practical results from a movement towards Panslavism, the Slavonians of the Austrian empire have always taken occasion to shew that they regarded themselves as standing apart from German interests in times of public disturbance. Thus, in 1848, instead of taking part with their fellow-citizens in the election of representatives to the German parliament at Frankfurt, the leading promoters of Panslavism summoned a Slavonic congress at Prague, which was attended by Slavonians from Bohemia, Moravia, and Silesia, and by Slavonic Poles, Croats, Servians, and Dalmatians, who appeared in their national costumes. The impracticability of the grand schemes promulgated in the manifestoes of the conclave, was sufficiently shewn by the necessity under which the members found themselves of employing German as the only language commonly understood by all. Disunion and dissensions were the speedy result of this incongruous meeting, whose seditious turbulence at last was summarily put down by the bombardment of the city of Prague, and the imprisonment of the leading agitators. Since that period, the striving towards Panslavism, although ever present as the guiding influence of all Slavonic insurrectionary movements, has found no further public expression.

**PANSY.** See **VIOLIN**.

**PANTAGRAPH** (Gr. *panta*, all, *graphein*, to delineate), an instrument by the aid of which any engraving may be copied on paper, though its use is in practice restricted to the copying of maps and plans. The copy can be drawn to any scale. The instrument consists of four rods, AB, AC, DF, and EF, jointed together, as in the figure; the points D and E are so taken that AD is equal to EF, and AE to DF, and consequently ADEF is always a parallelogram. If C be a determinate point near the end of the rod AE, and any line, CHB, be drawn cutting the other three rods, the triangles BAC and BDH are similar; so that when the point B is fixed, the points C and H, which can, from the structure of the instrument,

move in any direction, will describe similar figures different in size; that described by C being to that described by H in the proportion of CB to HB. The practical working of the instrument is as follows: The points H and B are determined by the ratio BH to BC, which is the proportion the scale of the copy bears to that of the original; a socket, which

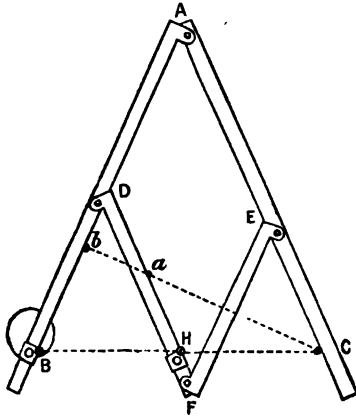

slides along the arm, is fastened exactly at B on the under side; below this is placed a heavy weight, with a stalk fitting into the socket, thus rendering B the centre of motion of the instrument, if the weight be heavy enough. A pencil is fitted into another socket at H, and a rod of metal with a sharp point, called the *tracer*, is fastened at C, and the instrument is fitted with castors at various points underneath, to allow of its being moved freely. The operator then passes the tracer over the outline to be copied, and simultaneously the pencil at H makes the copy on the required scale. If a copy on a scale nearly as large as the original be required, the fulcrum must be placed in DF, and the pencil in DB; while if a magnified copy be required, the pencil and tracer must exchange the positions assigned them in the first case. The defects of this instrument are its weight and the difficulty of rendering it perfectly mobile, both of which prevent that steady motion of the tracer which is necessary for making an accurate copy.

To remedy these defects, the pantagraph has been constructed in a variety of forms, all of which, however, like the one described, depend upon the principle that the two triangles which have for their angular points, the fulcrum the pencil-point and a joint, and the fulcrum the tracer-point and a joint, must always preserve their similarity.

**PANTELLA'RIA**, an island of Italy, in the Mediterranean, 60 miles south-west from the nearest point of land in Sicily, to which it belongs, being included in the province of Girgenti. The island is a volcanic mass, oval in shape, and is 36 miles in circumference. Its surface is diversified by two mountains. The chief products are cotton, pulse, fruits, and pasture. The vine and olive flourish, but corn is not grown in sufficient quantity to supply local consumption. A highly-esteemed breed of asses, of a large size and unusually fine appearance, is reared here. The island contains warm springs and other evidences of its volcanic formation. In the north-west is the town of Oppidolo, with batteries, a castle, and a small port.

**PA'NTHEISM** (Gr. *pan*, all, and *theos*, God), the

name given to that system of speculation which, in its spiritual form, identifies the universe with God, and therefore may be called *akosmism*, and in its more material form, God with the universe. It is only the latter kind of pantheism that is logically open to the accusation of Atheism (q. v.); the former has often been the expression of a profound and mystic religiosity. The antiquity of pantheism is undoubtedly great, for it is prevalent in the oldest known civilisation in the world—the Hindu. Yet it is a later development of thought than Polytheism (q. v.), the natural instinctive creed of primitive races, and most probably originated in the attempt to divest the popular system of its grosser features, and to give it a form that would satisfy the requirements of philosophical speculation. Hindu pantheism as *akosmism* is taught especially by the Upanishads (q. v.), the Vedānta (q. v.), and Yoga (q. v.) philosophies, and by those poetical works which embody the doctrines of these systems; for instance, the Bhagavadgītā, which follows the Yoga doctrine. It is poetical and religious, rather than scientific, at least in its phraseology; but it is substantially similar to the more logical forms developed in Europe. The Hindu thinker regards man as born into a world of illusions and entanglements, from which his great aim should be to deliver himself. Neither sense, nor reason, however, is capable of helping him; only through long continued, rigorous, and holy contemplation of the supreme unity (Brahma) can he become emancipated from the deceptive influence of phenomena, and fit to apprehend that he and they are alike but evanescent modes of existence assumed by that infinite, eternal, and unchangeable Spirit who is all in all. Hindu pantheism is thus purely spiritual in its character; matter and (finite) mind are both alike absorbed in the fathomless abyss of illimitable and absolute being.

Greek pantheism, though it doubtless originated in the same way as that of India, is at once more varied in its form, and more ratiocinative in its method of exposition. The philosophy of Anaximander (q. v.) the Milesian may almost, with equal accuracy, be described as a system of atheistic physics or of materialistic pantheism. Its leading idea is, that from the infinite or indeterminate (*to apeiron*), which is 'one yet all,' proceed the entire phenomena of the universe, and to it they return. Xenophanes (q. v.), however, the founder of the Eleatic school, and author of the famous metaphysical *mot*, *Ex nihilo, nihil fit*, is the first classical thinker who promulgated the higher or idealistic form of pantheism. Denying the possibility of creation, he argued that there exists only an eternal, infinite One or All, of which individual objects and existences are merely illusory modes of representation; but as Aristotle finely expresses it—and it is this last conception which gives to the pantheism of Xenophanes its distinctive character—'casting his eyes wistfully upon the whole heaven, he pronounced that unity to be *God*.' Heraclitus (q. v.), who flourished a century later, reverted to the material pantheism of the Ionic school, and appears to have held that the 'All' first arrives at consciousness in man, whereas Xenophanes attributed to the same universal entity, intelligence, and self-existence, denying it only personality. But it is often extremely difficult, if not impossible, to draw or to see the distinction between the pantheism of the earlier Greek philosophers and sheer atheism. In general, however, we may affirm that the pantheism of the Eleatic school was penetrated by a religious sentiment, and tended to absorb the world in God, while that of the Ionic school was thoroughly materialistic, tended to absorb God in the world,

and differed from atheism rather in name than in fact. But the most decided and the most spiritual representatives of this philosophy among the Greeks were the so-called 'Alexandrian' *Neo-Platonists* (q. v.), in whom we see clearly, for the first time, the influence of the East upon Greek thought. The doctrines of Emanation, of Ecstasy, expounded by Plotinus (q. v.) and Proclus (q. v.), no less than the fantastic Dæmonism of Iamblichus (q. v.), point to Persia and India as their birthplace, and in fact differ from the mystic teaching of the Vedanta only by being presented in a more logical and intelligible form, and divested of the peculiar mythological allusions in which the philosophy of the latter is sometimes dressed up.

During the middle ages, speculation was, for the most part, held in with tight reins by the church, and in consequence we hear little of pantheism. Almost the only philosopher who advocated, or who even seems to have thought about it, is John Scotus Erigena (see ERIGENA), who was probably led to it by his study of the Alexandrians, but his speculations do not appear to have been thought by him incompatible with a Christian faith; and in point of fact there are several profoundly mystical expressions employed in the New Testament, especially in the Epistles of John, in which the soaring spiritualism of Christianity culminates in language that has at least a pantheistic form; e. g., 'God is love; and he that dwelleth in love dwelleth in God, and God in him.' Erigena is regarded as the link that unites ancient and modern pantheism. We find in him now a reflection of the East and of Greece, and now a foreshadowing of the doctrines of Schelling and Hegel. His opinions were, with some scholastic modifications, introduced, in the 12th and 13th centuries, into theology by Amalric or Amaury de Chartres (a disciple also of Abelard), and his pupil David de Dinant, who were condemned as heretics by a council held at Paris.

Modern pantheism first shews itself in Giordano Bruno (q. v.), burned at Rome for his opinions in 1600. In Bruno reappear the speculations of the Eleatics and of the Neo-Platonists, but with a still more definite recognition than we meet with in them of an absolutely perfect supreme spirit. The universe, in the eyes of the unfortunate Italian, is not, properly speaking, a creation, but only an emanation of the Infinite mind—the eternal expression of its infinite activity; and hence the Infinite mind penetrates and fills, with different degrees of consciousness, all the heights and depths of the universe. To see God everywhere, to realise that He alone is, and that all else is but a perishable phenomenon or passing illusion—that there is but *one* intelligence in God, man, beast, and what we call matter—this should be the aim of all true philosophy. Spinoza (q. v.) comes next among pantheists in the order of time, but he is perhaps the greatest, certainly the most rigorous and precise of the whole class that either the ancient or the modern world has seen. His system is based, like the geometry of Euclid, on certain definitions and axioms, and he claims to have given it as conclusive and mathematical a demonstration as the latter. None will deny the keenness and cogency of his ratiocination. But human beings will not be forced into pantheistic convictions by any mere logical good, however sharp; and the system, impregnable as it seems, has never had a formal adherent. The principal result at which, after a long, firm-linked chain of reasoning, Spinoza arrives, is, that there is but one substance, infinite, self-existent, eternal, necessary, simple, and indivisible, of which all else are but the modes. This substance is the self-existent God. To call Spinoza an atheist is ridi-

culous. The extravagant phrase of Schleiermacher, 'a God-intoxicated man' (*ein gott-trunkener mann*), would be greatly nearer the truth, for no human system of philosophy whatever exhibits such an all-controlling and even overwhelming sense of the omnipresent God. Many critics have said that he was far more of an old Hebrew in his system than he dreamed. Although he had no direct followers, he exercised great influence on the development of metaphysical speculation in Germany, where, with the exception of Kant (q. v.), the three greatest philosophers of recent times—Fichte (q. v.), Schelling (q. v.), and Hegel (q. v.)—have all promulgated systems of a thoroughly pantheistic and ideal character. Neither England, France, nor America has produced a single great pantheistic philosopher (unless Mr Emerson be regarded as such); but there is an immense amount of pantheistic sentiment floating about in the poetry, criticism, theology, and even in the speculative thinking, in these and all European countries in the present age. This is attributable to the ravages made by biblical criticism, and the progress of the physical sciences in the region of religious beliefs. Multitudes of men are puzzled what to think and what to believe. They do not like to face the fact that they have actually lost faith in revelation, and are no longer relying for help and guidance on the Spirit of God, but on the laws of nature; so they take refuge from the abhorred aspect of the naked truth that they are 'atheists' in a cloud of rose-coloured poetical phrases, which, if they mean anything, mean pantheism.

PANTHE'ON, a Greek or Roman temple dedicated to all the gods. The 'Pantheon' of Rome

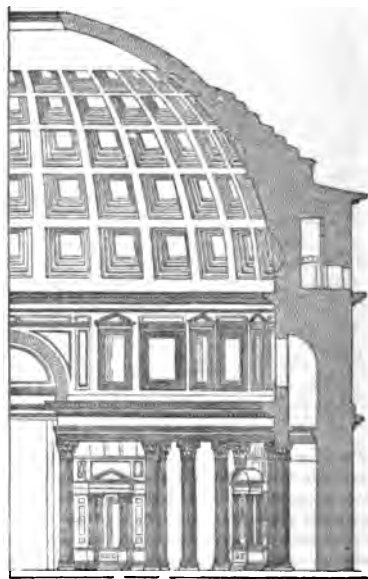

Half Section of Pantheon (from Ferguson).

(now a church) is a building deservedly celebrated for its fine dome. It suggested the idea of the domes of modern times.

PANTHER (*Felis pardus*), one of the largest *Felidae*, now generally supposed to be identical with the Leopard (q. v.), or a mere variety of it, differing only in a somewhat larger size and deeper colour. Cuvier, however, distinguishes

the P. from the Leopard, but without stating any characters other than those of colour. The



Panther (*Felis pardus*).

name P. (vulg. 'Painter') is given to the Puma in America.

PANTHER, in Heraldry, is borne gardant, and incensed, i. e., with fire issuing from his mouth and ears.

PANTOMIME, among the ancient Romans, denoted not a spectacle but a person. The pantomimes were a class of actors who (as the name implies) acted not by speaking, but wholly by mimicry—gesture, movements, and posturings—corresponding therefore pretty closely to the modern ballet-dancers. When they first made their appearance in Rome cannot be ascertained; probably the *histriones* (Etrusc. *hister*, a dancer) brought from Etruria to Rome 364 B. C. were pantomimes; but the name does not once occur during the republic, though it is common enough from the very dawn of the empire. Augustus shewed great favour to this class of performers, and is consequently supposed by some writers to have been himself the inventor of the art of dumb acting. The most celebrated pantomimes of the Augustan age were Bathyllus (a freedman of Mæcenas), Pylades, and Hylas. The class soon spread over all Italy and the provinces, and became so popular with the Roman nobles and knights (who used to invite male and female performers to their houses to entertain their guests), that Tiberius reckoned it necessary to administer a check to their vanity, by issuing a decree forbidding the aristocracy to frequent their houses, or to be seen walking with them in the streets. Under Caligula they were again received into the imperial favour; and Nero, who carried every unworthy weakness and vice to the extremity of caricature, himself acted as a pantomime. From this period they enjoyed uninterrupted popularity as long as paganism held sway in the empire.

As the pantomimes wore masks, no facial mimicry was possible; everything depended on the movements of the body. It was the hands and fingers chiefly that spoke; hence the expressions, *manus larymarissimæ*, *digiti clamosi*, &c. To such perfection was this art carried, that it is said the pantomimes could give a finer and more precise expression to passion and action than the poets themselves. The subjects thus represented in dumb show were always mythological, and consequently pretty well known to the spectators. The dress of the actors was made to reveal, and not to conceal the beauties of their person; and as, after the 2d c., women began to appear in public as pantomimes, the effect, as

may easily be supposed, of the æsthetic costume was injurious to morality. Sometimes these pantomimic actresses even appeared quite naked before an audience—a thing which could never have happened had the Roman communities not become thoroughly base, sensual, and impure. It was quite natural, therefore, that pantomimic exhibitions should have been denounced by the early Christian writers, as they even were by pagan moralists like Juvenal.

Under HARLEQUIN is described the character of the modern pantomimes, which word denotes not the performers, but the pieces performed. A few additional facts are here given to complete that notice. The Christmas Pantomime, or Harlequinade, is, in its present shape, essentially a British entertainment, and was first introduced into this country by a dancing-master of Shrewsbury named Weaver, in 1702. One of his pantomimes, entitled *The Loves of Mars and Venus*, met with great success. The arrival, in the year 1717, in London of a troupe of French pantomimists with performing dogs gave an impetus to this kind of drama, which was further developed in 1758 by the arrival of the Grimaldi family, the head of which was a posture-master and dentist. Under the auspices of this family, the art of producing pantomimes was greatly cultivated, and the entertainment much relished. Joseph Grimaldi, the son of the dentist, was clever at inventing tricks and devising machinery, and *Mother Goose*, and others of his harlequinades, had an extended run. At that time the wit of the clown was the great feature; but by and by, as good clowns became scarce, other adjuncts were supplied, such as panoramas or dioramic views; and now the chief reliance of the manager is on scenic effects, large sums of money being lavished on the *mise en scene*. This is particularly the case as regards the transformation scene—i. e., the scene where the characters are changed into clown, harlequin, &c.—as much as £1000 being frequently spent on this one effort. In London alone, a sum of about £40,000 is annually expended at Christmas time on pantomimes. The *King of the Peacocks*, a pantomime produced at the London Lyceum Theatre during the management of Madame Vestris, cost upwards of £3000. Even provincial theatres, such as those of Manchester or Edinburgh, consider it right to go to considerable expense in the production of their Christmas pantomime.

PA'OLI, PASQUALE DE, a Corsican patriot, was born in 1726, at Morosaglia, in Corsica. His father, having taken a leading part in the unsuccessful insurrection of the islanders against the Genoese and their French allies, was obliged to retire to Naples in 1739, taking his son with him. Here P. received an excellent education. In July 1765, he was summoned by the supreme magistracy to Corsica, and was elected captain-general of the island, and the chief of a democratic government, possessing all the power of a king, but without the title. He energetically and successfully applied himself to the reformation of the barbarous laws and customs of the island, and at the same time to the expulsion of the Genoese, who, notwithstanding the aid they received from an influential section of the islanders, were deprived of nearly all their strongholds, their fleet was defeated, and they were finally obliged to seek help from France. After the withdrawal of the French troops, they were again speedily deprived of the places they had recaptured, and in 1768 they ceded the island to France. P. refused all the advantageous offers by which the French government sought to bribe him, as he had before refused those of the Genoese, and continued to struggle for the independence of his country,

but he was signally defeated by the Comte de Vaux, at the head of the French troops, and the French became masters of the island. After one year's struggle, P. was compelled to take refuge on board of a British frigate, in which he sailed for England, where he was treated with general sympathy. Twenty years afterwards, the French revolution of 1789 recalled him to Corsica, and as a zealous republican he entered into the schemes of the revolutionary party; but during the anarchy of France in 1792—1793, he conceived a scheme for making Corsica an independent republic. Until this time he had been on the best terms with the Bonaparte family, but they now joined the Jacobin party whilst he allied himself with Britain, favoured the landing of 2000 British troops in the island in 1794, and joined them in driving out the French. He then surrendered the island to George III., but becoming dissatisfied with the government, he quarrelled with the British viceroy, whilst many of his countrymen were displeased with the course he had adopted in allying himself with the British. He therefore retired from the island in 1796, and spent the remainder of his life in the neighbourhood of London. P. died near London, February 5, 1807.

PAPA, a large market-town in the west of Hungary, stands in a beautiful district on the Tapolca, an affluent of the Marczal, 60 miles south-south-east of Presburg. It contains a stately castle, with a beautiful garden, handsome Catholic and Lutheran churches, a Catholic gymnasium, Reformed college, and an hospital. Stoneware, cloth, and pipes are manufactured, and a trade in wine is carried on. Pop. 12,400.

PAPA, the Latin form of the title now, in the Western Church, given exclusively to the Bishop of Rome. Originally, however, meaning simply 'father,' it was given indiscriminately to all bishops. Tertullian (*De Pudicitia*, cxiii.) so employs it. Dionysius, a priest of Alexandria, calls his bishop Papa Heraclias. St Cyprian, in the letters of his clergy, is addressed *Beatissimo Papæ Cypriano*. The same form is employed towards him by the clergy of Rome itself. Even Arius so addresses his own bishop Alexander. In the next century, St Jerome addresses the same title to Athanasius, to Epiphanius, and most of all to Augustine. Indeed it would appear certain that down to the time of Gregory of Tours it was used not uncommonly of bishops in the Western Church. And there are evidences of its being occasionally applied to the inferior clergy, for whom, however, some adjunct was employed, in order to distinguish them from bishops. Thus, we sometimes read of *papæ pisinni*, minor popes; and the tonsure was called by the name *papæ letra*. In the Greek Church, as is well known, whether in Greece Proper or in Russia, *papa* is the common appellation of the clergy. The circumstance of its having been originally of general application, is acknowledged by all learned Roman Catholic controversialists and historians.

PAPACY. See POPES.

PAPAL STATES (Italian, *STATI DELLA CHIESA*, or *STATI PONTIFICI*), a territory, or rather group of states in Central Italy, formerly united into one sovereignty, with the pope for its head. It was of an irregular form, resembling the letter Z, the upper portion lying to the east of the Apennines, the lower to the west of that range, these two being connected by a third strip, which crossed the peninsula from east to west. The P. S. were bounded on the N. by the Po, on the S. by Naples, on the E. by the Gulf of Venice and Naples, and on the W. by Modena, Tuscany, and the Tyrrhenian Sea.

Detached portions, as Benevento and Pontecorvo, lay within the Neapolitan territory. The country is traversed by the Apennines, which attain their highest elevation in the Monte della Sibilla, which is about 7402 feet above sea-level. Owing to this range, which traverses the peninsula in the direction of its length, lying so much nearer the east than the west coast, the streams to the east of it have a short course and little volume, being, in fact, mere mountain torrents; while on the west side a few of the rivers are of considerable size. Of the latter, the Tiber (q. v.) is the largest. The eastern coast is bold and rugged, and destitute of proper harbours, that of Ancona alone excepted; towards the north, at the mouth of the Po, it gradually subsides into a low, level, marshy tract, with numerous lagunes. The country west of the Apennines is traversed by ranges of hills parallel to them, and gradually decreasing in elevation as they approach the sea. The coast itself is almost wholly flat, sandy, or marshy, with no deep bays and few good harbours besides Civita Vecchia. There are numerous small lakes, principally in the northern portion of the country, the chief of which are Lake Bolsena, Lake Perugia, and Lake Bracciano, the last an old crater, situated almost 1000 feet above sea-level.

The country was divided for administrative purposes into 20 districts, as follows: 1 Comarca, including Rome and the Agro Romano; 6 Legations, Bologna, Ferrara, Forli, Ravenna, Urbino, Velletri; and 13 Delegations, Ancona, Ascoli, Benevento, Camerino, Civita Vecchia, Fermo, Frosinone, Macerata, Orvieto, Perugia, Spoleto, Rieti, Viterbo; with a total area of 15,774 English square miles, and a population (1853) of 3,124,668. The Legations of Bologna, Ferrara, Forli, and Ravenna constituted the *Romagna*; Spoleto and Perugia were known as *Umbria*; and Ancona, Fermo, Macerata, and Ascoli constituted the *March of Ancona*. The inhabitants, with the exception of 16,000 Jews, are of Italian race, and of the Roman Catholic religion. The only provinces now remaining under the papal rule are, Rome with the Comarca, the legation of Velletri, and the delegations of Civita Vecchia, Frosinone (excepting Pontecorvo), and Viterbo, with a total area of 4493 English square miles, and a population of about 700,000. The chief cities and towns in the present territory are, Rome (the capital), Viterbo, Velletri, Alatri, and Civita Vecchia.

*Climate and Products.*—The climate of the P. S. is one of the finest in the world, and the heat of summer is tempered by the mild and cooling sea-breezes; but in the flats south of the Po and in the Campagna of Rome, the noxious atmosphere produced by the exhalations from the marshes is most destructive of human life. Fever and ague are very prevalent among the inhabitants of the neighbouring districts, and notwithstanding the attempts to remedy the deadly influence of the marshes by drainage and cultivation, it has hitherto been undiminished (see MAREMME). Violent siroccos are occasionally experienced on the west coast. The northern portion, from its elevation, is exposed to severe cold during winter. The soil of the P. S. is in general extremely fertile; but the higher mountain districts are either quite barren, or only adapted for pasture; and not more than one-third of the whole surface is under cultivation. The practice of agriculture is in its most primitive state, notwithstanding the fact that agriculture, as a science, originated here, and was practised for many centuries before it was introduced into the other countries of Europe; but the many political changes and revolutions which have convulsed the country, have acted as a bar to all

## PAPAL STATES.

enterprise. It must, however, be mentioned, that the present pope has, by salutary enactments, and by the establishment of agricultural societies, done much for the improvement of this branch of industry. The products are similar to those of the rest of Italy. The manufactures are comparatively unimportant—silks, woollens, and leather are the chief; but plate-glass, rope, sailcloth, cotton goods, paper, artificial flowers, wax-candles, soap, stoneware, &c., are also manufactured in various places. The fisheries are important. The chief minerals are alum, vitriol, saltpetre, sulphur, coal, rock-salt, marble, and alabaster.

Many of the manufactured goods, and wine, olive oil, wool, hemp, tobacco, bread-stuffs, catgut, &c., are exported, the total exports (1858) amounting to 11,690,258 scudi (£2,528,100); while the imports for the same year reached the value of 13,510,143 scudi (£2,921,662); since this date no reliable statistics of the trade of the districts still remaining under the pontifical rule have been received.

**Government.**—The pope possesses absolute and unlimited power, but the members of the college of cardinals, who elect him, generally keep the chief offices of state in their own hands, and assist the pope in the government of his states, as well as in the affairs of the church. The secretary of state is at the head of political affairs, and is nominated by the pope. He presides over both the ministerial council and the council of state. The former council, which consists of five or more ministers, heads of departments, selected by the pope, has a voice in legislation, and also the right of authoritative interpretation of the laws; the latter, which consists of thirteen members, also nominated by the pope, has, in matters of legislation and finance, only the right of giving advice; but it settles any question of competency that may arise between the various branches of the administration. Since 1850, there has also been a separate *finanz-consulta* for the regulation of financial affairs. The Comarca, which is more directly under the central government, is ruled by a cardinal-president; the Legation is ruled by a cardinal-legate, aided by a provincial chamber of deputies. There are civil and criminal courts in all the provinces, minor courts in the communes, with courts of appeal in all the chief cities, and a central tribunal at Rome. All the proceedings of these courts are public, except trials for political offences. There are loud complaints of abuses in all departments of the administration. Ecclesiastically, the country is divided into archbishoprics and bishoprics.

The papal army, which formerly amounted to 20,000 men, now (June 1863) numbers only 8513 men, infantry, cavalry, artillery, &c. included, and a considerable portion of the present papal territory is garrisoned by French troops, without whose aid the pope's power could not be maintained.

The income and expenditure for 1859, the last year of the entirety of the P. S., were respectively 14,453,325 scudi (£3,126,028), and 15,019,346 scudi (£3,248,038); but the three succeeding years shewed a widely different result; the expenses being largely increased by the cost of the war, while from the rebellious provinces scarcely any taxes were collected. The income and expenditure for these three years were nearly as follows:

	Expenditure.	Income.
1860	£4,720,809	£1,718,658
1861	4,291,644	1,716,658
1862	3,145,922	1,072,911

The finances are still in the same deplorable condition, and the national debt amounts to about £17,000,000. The tax, known as 'Peter's pence,' which was lately collected from all the Roman

Catholic countries, had produced at the beginning of 1863 about £1,080,000.

**History.**—During the rule of the Goths and Lombards in Italy, the inhabitants of Rome and all who desired to live free from the barbarian yoke, feeling that the Greek empire was incapable of protecting them, and at the same time observing the pertinacity and energy with which the pope asserted the importance and dignity of Rome, naturally looked up to him as in some sort a protector; and it is to the gradual growth and spread of this feeling that the important position subsequently taken by the popes as authorities in temporal matters is chiefly due. About 720 A.D., Gregory III., having quarrelled with the Emperor Leo the Isaurian, declared the independence of Rome. In 726, Pepin le Bref compelled the Lombard king to hand over Ravenna, Rimini, Pesaro, Fano, Cesena, Urbino, Forlì, Comacchio and fifteen other towns, to the pope, who now assumed the state of a temporal sovereign. Pepin's example was followed by his son Charlemagne; but, notwithstanding, the pope's sovereignty was more nominal than real, as the towns were not in his possession, and he only obtained a small share of their revenues. In the 11th c., the Normans greatly aided to increase the papal temporal authority, and in 1053 the duchy of Benevento was annexed. In 1102, the Countess Matilda of Tuscany left to the pope her fiefs of Parma, Mantua, Modena, and Tuscany; but these were immediately seized by the German emperor, and of this magnificent bequest only a few estates came into the pope's hands. Between this period and the end of the 13th c., the popes succeeded, often by unscrupulous means, in obtaining from many of the free towns of Italy an acknowledgment of the superiority of the Roman see over them; and in 1278 the Emperor Rodolf I. confirmed the popes in the acquisitions thus obtained, defined authoritatively the boundaries of the P. S., and acknowledged the pope's exclusive authority over them, by absolving their inhabitants from their oath of allegiance to the empire. The P. S. at this time included Perugia, Bologna, Bertinoro, the Duchy of Spoleto, the Exarchy of Ravenna, and the March of Ancona; but many of the towns were either republics or hereditary principalities, and in none did the pope possess real authority. Sixtus IV., in the end of the 15th c., managed to annex the Romagna to his dominions; in effecting which he is accused of having employed intrigue, perjury, and murder. His successors, Alexander VI. and Julius II., increased the P. S. by the addition of Pesaro, Rimini, Faenza, Parma, Placentia, and Reggio. By the victory of the French at Marignan (1515), the very existence of the papal power was threatened; but the able policy of Leo X. averted the threatened danger. In 1545, Paul III. alienated Parma and Placentia, and erected them into a duchy for his son, Pietro Luigi Farnese; but this loss was partly made up by the acquisitions of Gregory XIII. In 1598, the possessions of the House of Este, viz., Ferrara, Comacchio, and a part of the Romagna, were seized by Pope Clement VIII.; and the P. S. received their final additions in Urbino (1623), Ronciglione, and the duchy of Castro (1650). The Romagna was seized by Napoleon in 1797, and incorporated in the Cisalpine Republic; and in the following year, Rome was taken by the French, and the P. S. erected into the *Roman Republic*. Pius VII., in 1800, obtained possession of his states, but they were almost immediately retaken by the French, and finally (1809) incorporated with France, Rome being reckoned the second city of the empire. In 1814, the pope returned to his dominions, and was formally reinstated by the treaty of Vienna, mainly

through the exertions of the *non-Roman Catholic* powers, Russia, Prussia, and Britain; but the clerical misgovernment contrasted so strongly with the liberal administration of France, that in 1830 the people of Ancona and Bologna rose in rebellion. They were put down by the aid of an Austrian army, but the abuses in the administration were so flagrant, that even Austria urged the necessity for reform. Her remonstrances, however, were not attended to, and the Bolognese again rebelled. This second revolt supplied Austria with a pretext for occupying the northern Legations, and the French at the same time garrisoned Ancona. Occasional risings took place from time to time up to 1848, when the present pope, Pius IX., assumed the tiara, and burst upon the astonished world in the new character of a reforming pope. His projects were of a most liberal character, and were put in force with great energy, despite the opposition of Austria; but, alarmed at the spread of revolution in Europe during 1848, he halted in his career, just at the critical moment when to halt was to be lost. The people rose, and Pius IX. fled to Gaeta, whilst Rome was proclaimed a republic. He was restored, and his subjects reduced to submission, by the arms of France, Austria, Naples, and Spain. The Austrians held the Legations in subjection to the pope's authority till 1859; the French still occupy Rome in his behalf. In July 1859, the four northern Legations (the Romagna), taking advantage of the withdrawal of the Austrian troops, quietly threw off the papal authority, and proclaimed their annexation to Sardinia, which was formally acknowledged by Victor Emmanuel in March 1860. The pope now raised a large body of troops, appointing Lamoricière, an eminent French general, to command them, for the purpose of resisting any further encroachments on his dominions; but the news of Garibaldi's success in Sicily and Naples produced revolt in the Legation of Urbino and in the Marches, the people proclaiming Victor Emmanuel. The Sardinians accordingly marched into the P. S., defeated Lamoricière in two encounters, and finally compelled him to retire into Ancona, where, after a siege of seven days, he was compelled to surrender with his whole army. The revolted provinces of Umbria, Urbino, and the Marches were immediately annexed to Sardinia; and the isolated provinces of Benevento and Pontecorvo (a part of Frosinone), which are situated within the kingdom of Naples, shared the same fate. The pope still refuses to recognise the validity of the transfer of his states.

**PAPAVERACEÆ**, a natural order of exogenous plants, herbaceous or half shrubby, usually with a milky or coloured juice. The leaves are alternate, without stipules; the flowers on long one-flowered stalks. The fruit is pod-shaped or capsular; the seeds numerous. The order is distinguished for narcotic properties. Opium (q. v.) is its most important product. The juice of *Celandine* (q. v.) is very acrid. A number of species are used in their native countries for medicinal purposes. The seeds yield fixed oil, which, with the exception of that obtained from *Argemone Mexicana*, is quite bland. See **POPPY**. The flowers of many species are large and showy, most frequently white or yellow, sometimes red. Several kinds of Poppy and *Eschscholtzia* are frequent in our gardens. There are in all about 130 known species, natives of all quarters of the world, and of tropical and temperate climates, but they abound most of all in Europe.

**PAPAW** (*Carica Papaya*), a South American tree of the natural order *Papayaceæ*—of which

order about 30 species are known—which has now been introduced into many tropical and subtropical countries. It grows to the height of 15–30 feet, with leaves only at the top, where also the fruit grows close to the stem. The leaves are 20–30 inches long. The fruit is of a green colour, very similar in appearance to a small melon, and with a somewhat similar flavour. It is eaten either raw or boiled. The seeds are round and black, and when chewed, have in a high degree the pungency of cresses. The powdered seeds and the juice of the unripe fruit are most powerful anthelmintics. A constituent of this juice is *Fibrine*, otherwise unknown in the vegetable kingdom, except in the Fungi. The milky juice of the tree is very acrid. The leaves are used by negroes instead of soap to wash linen. The juice of the fruit and the sap of the tree have the singular property of rendering the toughest meat tender in a short time. Even



Papaw Tree (*Carica Papaya*).

the exhalations from the tree have this property; and joints of meat, fowls, &c., are hung among its branches to prepare them for the table. It is a tree of extremely rapid growth, bears fruit all the year, and is exceedingly prolific. The fruit is often cooked in various ways.—The *Chamburu* (*C. digitata*), another species of the same genus, a native of Brazil, is remarkable for the extremely acrid and poisonous character of its juice, and the disgusting stercoraceous odour of its flowers.—In the middle and southern states of America the name P. is given to the *Uvaria* (or *Asimina*) *triloba*, a small tree of the natural order *Anonaceæ*, the fruit of which, a large oval berry, three inches long, is eaten by negroes, but not generally relished by others. All parts of the plant have a rank smell.

**PAPENBURG**, a small town of Hanover, in the bailiwick of Osabrück, on a canal navigable for sea-going vessels, 27 miles south-south-east of Emden on Dollart Bay, by the Emden and Hanover Railway. It originated in a small colony which sprung up here, and was supported principally by peat-cutting, an employment for which the fens and moors of the vicinity afford abundant facilities. The town is cleanly built, after the Dutch model; its houses stretch along the banks of the canal. It possesses 130 ships, and carries on manufactures of

sail-cloth and ropes. Its commerce is considerable. Pop. 5000.

PAPER. This well-known fabric is usually composed of vegetable fibres in a minute state of division, and recombined into thin sheets, either by simple drying in contact, or with the addition of size or some other adhesive material. Probably the earliest use of paper was for the purpose of writing upon, and its earliest form was the Papyrus (q. v.) of the Egyptians. The stems of the papyrus plant, which are often eight or ten feet long, are soft and green, externally like the common rush; and the interior consists of a compact cellular tissue or pith. At the bottom of each stem the portion immersed in the mud and water is whiter and more compact; and under the outer skin a number of thin pellicles lie one above the other. These were removed, and laid side by side with their edges overlapping each other, and crosswise upon these was placed one or more similar layers, until the sheet was sufficiently thick; pressure was then applied for a time, and afterwards the sheet was dried in the sun. The width of such sheets, of course, depended upon the length of the portion of papyrus stems taken; but they could be made any length by joining a number of the squares end to end by glue or any other adhesive material. The *scapus*, or roll, usually consisted of about 20 of them.

Owing to the fact that the various layers of the papyrus decrease in thickness as they are nearer to the centre of the stem, the makers were enabled to produce papers of different qualities; and in the time of the Romans many varieties were known, which differed as to the quality of the material, and the size of the pieces of which the sheets were composed. The finest quality was made from the innermost layer of membrane, and was called *Hieratica*, or paper of the priests. This was made for the Egyptian priests, who interdicted its sale until covered with sacred writing. In this state it was, however, an article of trade, and the Romans found a means of removing the writing, and sold the palimpsest sheets in Rome under the name of *Augustus* paper, used as a Latin equivalent for its former Greek name of *hieratica*. It was, however, supposed by many that it was named after the Emperor Augustus, and in consequence a second quality was called after his wife, *Lavinia*; and the original name of the first quality came in time to be applied to the third quality. The next quality was called *Amphitheatrica*, it is supposed, from its having been made in the vicinity of the Alexandrian amphitheatre. This last, when imported to Rome, was partly remanufactured by Q. Remmius Fannius Palemon, the schoolmaster and paper-maker, who, by a peculiar process of his own, reduced its thickness, and rendered it equal to the first quality, when it was sold under the name of *Fanniana*. There were other inferior qualities, of which one called *Emporetica* was used as shop-paper.

Pliny, from whom we get these very interesting particulars, tells us that all these kinds were manufactured in Egypt, and required the Nile water for their formation. He says, that 'when it is in a muddy state it has the peculiar qualities of glue, and the various kinds of paper are made on a table where they are moistened with this water. The leaves or sheets of membrane are laid upon it lengthwise, as long indeed as the papyrus will admit of, the jagged edges being cut off at either end; after which a cross layer is placed over: the same way, in fact, that hurdles are made. When this is done, the leaves are pressed together, and dried in the sun.' The idea of the adhesive quality of the Nile water is erroneous, but it is very probable the Egyptian manufacturers encouraged the error.

It is obvious the whole merit consisted in using the membranes fresh, whilst their own natural gum was in proper condition to make them adhere together.

In India and China, the art of writing with a style or sharp point upon dried palm and other leaves, and also some kinds of bark, is common even at the present day, especially in Ceylon, where we find it common to employ the leaves of the talipot and other palms as paper. Perhaps it was from the employment of these materials, or it is even possible from watching the operations of the paper-making wasps and other insects, that the manufacture of larger pieces, by pulping the materials and spreading them out to a greater extent, was suggested. Whatever was the true origin of the art, it is now lost in the vista of time.

It is known that the Chinese were acquainted with the art of making paper from pulp artificially prepared as early as the commencement of the Christian era; and it is thought that they used the bark of various trees, the soft parts of bamboo stems, and cotton. In the 7th c., the Arabians learned the art of making it of cotton from the Chinese, and the first manufactory was established, about 706 A. D., at Samarcand. From thence it was transplanted to Spain, where, under the Moors, paper was made not only of cotton, but it is thought also of hemp and flax. The exact time of the introduction of paper made of linen rags is very uncertain; but the best evidence is offered by the Arabian physician Abdollatiph, who writes, in an account of his visit to Egypt in the year 1200, 'that the cloth found in the catacombs, and used to envelop mummies, was made into garments, or sold to the scribes to make paper for shopkeepers;' and as there is no doubt that these mummy-cloths were linen, it proves that the use of this material is of no mean antiquity. Of the use of linen rags in Europe, the earliest proof is in the celebrated document found by Ichwandner in the monastery of Goss, in Upper Styria, which purports to be a mandate of Frederick II., emperor of the Romans, and is dated 1242. It is written on paper which has been proved to be made of linen. The practice of making a distinctive water-mark on the paper, by means of an impression on the fine sieve of threads or wires upon which the floating pulp is received (fig. 1), was also of very early date, as MSS. as old as the 13th c. bear it. But there is really no satisfactory information respecting the exact time or place of the introduction of paper-making into Europe; by some it is supposed that Spain was the first to receive the art, and that thence it spread to France and Holland, and afterwards to England. It is quite certain that England was a long time behind these countries. As a proof of this, we find that the first patent for paper-making was taken out in 1665, by one Charles Hildeyerd, but it was for 'The way and art of making blew paper used by sugar-bakers and others.' The second was in 1675, by Eustace Barneby, for 'The art and skill of making all sorts of white paper for the use of writing and printing, being a new manufacture, and never practised in any way in any of our kingdoms or dominions.' This, then, was the first commencement of the making of writing and printing paper; but that it did not equal the manufactures of other countries is shewn by the specification of another patent, taken out by John Briscoe in the year 1685, which is thus expressed: 'The true art and way for making English paper for writing, printing, and other uses, both as good and as serviceable in all respects, and especially as white as any French or Dutch paper.' As a general rule, it was the custom of paper-makers to employ linen rags for fine papers, but a great variety of other materials have been in use



from its first introduction; for, as early as 1680, Nathaniel Bladen took out a patent for 'An engine method and mill, whereby hemp, flax, linnen, cotton, cordage, silke, woollen, and all sorts of materials' might be made into paper and paste-board; and from that time innumerable efforts have been made to prepare other materials than cotton and linen rags for the manufacture of paper. The following is a summary of the patents which have been taken out in Britain for making paper from various materials, with the dates, which will shew to those engaged in this investigation in what directions the inquiry has been previously conducted. The arrangement is alphabetical, and consequently not in the order of dates.

Materials.	Names of Inventors, and Dates of Patents.
Aloe Fibre, . . .	Berry, 1838; D'Harcourt, 1838; Small, 1838; May, 1852; Burke, 1855.
Asbestos, . . .	Maniere, 1853.
Bagging or Sacking, . . .	Stiff, 1853; Wheeler and Co., 1854; Rosster and Co., 1854; Smith and Co., 1855.
Banana Fibre, . . .	Berry, 1838; Lilly, 1854; Jullion, 1855; Burke, 1856; Hook, 1857.
Barks of various kinds, . . .	Koops, 1800; Balmano, 1838; Nerot, 1846; Coupler, 1852; Johnson, 1855; Kelk, 1855; Lotteil, 1855; Niven, 1856; Broad, 1857; Hope and Co., 1857.
Bass or Bast, . . .	Ruck and Touche, 1856; Touche, 1857.
Bean-stalks, &c., . . .	D'Harcourt, 1838; Brooman, 1855.
Cane (Sugar), . . .	Berry, 1838; Coupler, 1852; Johnson, 1855; Jullion, 1855; Ruck and Touche, 1856; Hook, 1857.
Cocoa-nut Fibre, . . .	Newton, 1853; Holt and Forster, 1854.
Cocoa-nut Kernel, . . .	Diaper, 1854.
Clover, . . .	Compland, 1854; Holt and Fraser, 1854; Plunkett, 1857.
Cotton, . . .	Bladen, 1682; Williams, 1833; Coupler, 1852; Crossley, 1854; Siblet, 1857.
Dung, . . .	Jones, 1805; Zander, 1839; Lloyd, 1852; Hill, 1854.
Esparto or Alfa, . . .	Rout'edge, 1856.
Flax, . . .	Bladen, 1682; Koops, 1800; Jones, 1805; Ball, 1817; Berry, 1838; Gibbs, 1833; De la Garde, 1825; Coupler, 1852; Collins, 1853; Pownal, 1852; Collins, 1854; Broad, 1857.
Flax, New Zealand, . . .	Berry, 1838; Gibbs, 1833 and 1857; Gillman, 1854.
Fresh-water Weeds, . . .	Archer, 1855.
Fur, . . .	Williams, 1833.
Grasses, . . .	Stiff, 1853; Evans, 1854; Clift, 1854; Compland, 1854; Jeyes, 1854; Crossley, 1854; Jackson, 1854; Johnson, 1855; Fraser, 1855; Gilbee, 1855; Holt and Fraser, 1854; Parivet, 1856.
Gutta-percha, . . .	Hancock, 1846.
Hair, . . .	Williams, 1833.
Hay, . . .	Koops, 1800; Castelain, 1854; Pariaet, 1856.
Heath, . . .	Crossley, 1854.
Hemp, . . .	Bladen, 1682; Hooper, 1790; Koops, 1800; De la Garde, 1825; Gibbs, 1832; Coupler, 1852; Collins, 1853; Bargnano, 1853; Jackson, 1854; Hill, 1854; Broad, 1857; Bull, 1817.
Hops, . . .	De la Garde, 1825; D'Harcourt, 1838; Balmano, 1838; M'Guaran, 1839; Sheldon, 1843; Barling, 1854; Crossley, 1854; Holt and Fraser, 1854; Taylor, 1854; Broad, 1857; Plunkett, 1857.
Husks of Grain, . . .	Wilkinson, 1852.
Jute, . . .	Calvert, 1846; Nerot, 1846; Coupler, 1852; Helin, 1854; Jackson, 1854; Smith and Hollingworth, 1855.
Leather, . . .	Hooper, 1790; Trappes, 1854; Oeka, 1856; Van den Hout, 1856; Lichten-tadt, 1857.
Leaves, . . .	Balmano, 1838; Warner, 1853; Vivien, 1853; Johnson, 1855; Mull, 1855; Ruck and Touche, 1857.

Materials.	Names of Inventors, and Dates of Patents.
Maise, Husk, and Stems, . . .	D'Harcourt, 1838; Balmano, 1838; Ruck and Touche, 1857.
Manilla Hemp or Plan-tain Fibre, . . .	Newton, 1853.
Moss, . . .	Newbitt, 1824; Belford, 1854; Johnson, 1855.
Nettles, . . .	Jones, 1805; De la Garde, 1825; Clift, 1854.
Old Writing Paper, . . .	Koops, 1800.
Pea Stalk, . . .	D'Harcourt, 1838.
Peat or Turf, . . .	Ley, 1852; Clarke, 1853; Lalle-mande, 1853; Crossley, 1854; Hemming, 1857; Westerman, 1852.
Roots of various kinds, . . .	Balmano, 1838; De la Bertoche, 1855; Johnson, 1855; Ackland, 1854; Barlina, 1855; Dubus, 1857.
Sawdust, . . .	Wilkinson, 1852; Johnson, 1855.
Sea-weeds, . . .	Martenoll de Martonol, 1855; Archer, 1855.
Silk, . . .	Bladen, 1682; Bull, 1817; Williams, 1833.
Straw, . . .	Koops, 1800; Lambert, 1824; Zunder, 1839; Cournier, 1852; Stiff, 1853; Poole, 1853; Helin, 1854; Fraser, 1855; Chanchard, 1856; Castelain, 1854; Broad, 1857; Wheeler, 1857.
Tan (Spent Bark), . . .	Crossley, 1854; Jeyes, 1854; Holt and Forster, 1854; Horton, 1855; Rosster and Bishop, 1854.
Thistle-down, . . .	Belford, 1854.
Thistles, . . .	Koops, 1800; Lord Berridale, 1884; Lidle, 1854.
Tobacco-stalks, . . .	Adcock, 1854.
Wood, . . .	Koops, 1801; Desgrand, 1839; Brooman, 1853; Swindella, 1854; Newton, 1852; Johnson, 1853; Kelk, 1855; Martin, 1855; Prede-val, 1855; De Fronter, 1853; Chanchard, 1856; Amyot, 1856; Newton (Votter), 1857; Pogat, 1857; Coupler, 1852.
Wool, . . .	Bladen, 1682; Williams, 1833; Dickenson, 1807; Crossley, 1854.
Wraek Grass or Zoetera, . . .	Spooner, 1857.

But whatever the material employed, the process for nearly all is the same. The rags, bark, fibres, or other substance, have to be reduced with water into a fine smooth pulp. This, in the early stages of the manufacture, was accomplished by macerating and boiling the material, until, in the case of bark, fibres, or other raw material, the fibres could be drawn out from the cellulose matter, after which it was beaten with mallets, or with pestles in mortars, or stampers moved by some power. Water is generally used, but in Holland wind-mills do this work. The beating is continued until the material is reduced to a very smooth pulp. The pulping, in our machine paper-mills, is much more rapidly accomplished by boiling the linen or cotton rags, or other material, in a strong lye of caustic alkali. This effectually cleans the rags, and other vegetable fibres

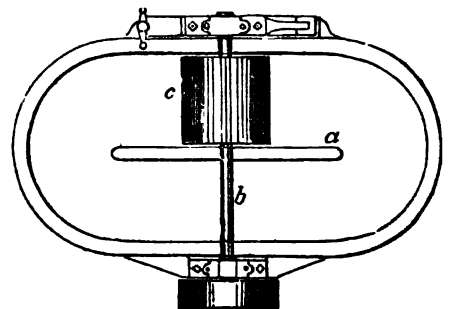

Fig. 1.

are softened and separated in a remarkable manner by it; they are then put into a machine called the washing-machine (fig. 1), which washes out dirt

and everything but the pure vegetable fibre. This machine (figs. 1, 2, and 3) is a large cast-iron vessel, usually about 10 feet in length, 4½ feet in width, and 2½ feet in depth. In the middle, occupying about two-thirds of its length, is a partition, always cast with it, called the mid-feather, *a* (figs. 1 and 2), to support the axle or driving-shaft, *b*

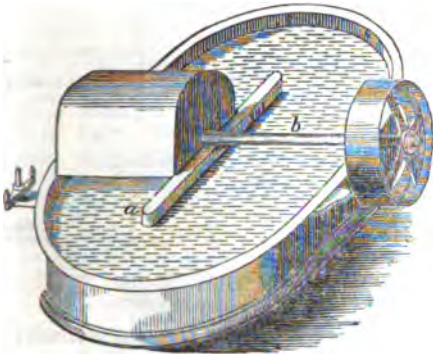

Fig. 2.

(figs. 1 and 2). This turns the cylinder *c* (fig. 1), which has a large number of teeth or ridges running across it, which grip and tear the rags, or other materials, as they are drawn under it by the current formed by its revolutions. In order to facilitate this, a peculiar form is given to the bottom of the part in which the cylinder works, as seen in fig. 3. The rise, *a* (fig. 3), is called the back-fall, and the

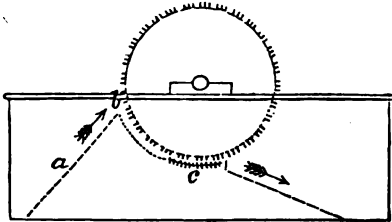

Fig. 3.

materials are drawn up to, and through the narrow space at *b*, by the current; then, as they pass over the ridged surface, *c*, they come in contact with the ridged surface of the cylinder, and are thus violently ground and drawn through, the stream carrying them round and round until they are thoroughly washed and partly pulped; or, as it is technically called, *broken in*. The washing-machine is supplied with a continued flow of clean water, and the soiled water as regularly escapes through a fine gauze screen, in the ends of the cylinders, in which is an ingenious arrangement for raising it and carrying it away through the axis, which is hollow. The contents of the washing-machine are then allowed to flow out through a large valve, opening downwards into the draining-chest. Here the water is drained away, and the *stuff* is then placed in the bleaching vats, which are made of stone, and each calculated to contain a hundredweight of stuff, which is here submitted to the action of a strong solution of chloride of lime for about twenty-four hours, and frequently agitated; after which it is transferred to a hydraulic press, and pressed so as to remove the greater portion of the liquid and chloride of lime. It is then placed in another washing-engine, and for

an hour is submitted to the same process as in the first; by which all vestiges of the bleaching materials are removed, and the stuff so much more broken down as to be called *half-stuff*. From this engine it is let out by a valve, and finds its way into the *beating-engine*, which is placed at a lower level so as to receive it. Here the arrangement is nearly the same as in the washing and intermediate engines; but the ridges on the bars below the cylinder, and on the cylinder itself, are much sharper, and the disintegration of the fibres is carried on with great rapidity until they are quite separated; and the flow of the water in a rapid current, as it passes the cylinder, draws them out and arranges them if the water in much the same way as wool or cotton is laid on the carding-cylinders of a carding-machine. This operation takes about five hours, at the end of which time the materials have been worked up with the water into an almost impalpable pulp. This is then let out into the pulp vat, where it is kept continually agitated by a wooden wheel revolving in it, called a *hog*, and from this the hand-workman or machine is supplied.

We will now suppose the pulp formed and ready for use in the vat, and will first describe the process of hand-making, as formerly practised in all countries, and still in use, more or less, in all paper-making countries. The workman or vatman takes an implement called a

*mould*, which consists of a sheet of very fine network, attached to a frame, as in fig. 4. In Europe, this network was always made of very fine wire; but in India, China, and Japan it is usually made of

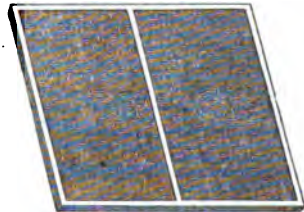

Fig. 4.

fine fibres of bamboo, which the workmen of these countries split and weave with remarkable skill. There are usually two kinds of moulds employed. In one, as in fig. 4, the wires are woven across each other, forming a very fine gauze, and paper made with them is known as *wove*. In the other, there are several cross-bars in the frame, and straight wires are laid from side to side, and about four or five to each half sheet are laid across them lengthwise, to keep them in position; the transverse wires are about twenty to the inch; the longitudinal ones are a little more than an inch apart. Paper made on such moulds is called *laid*, and is easily known by the impression of the wires upon it. Whichever kind of mould is used, another implement called the *deckle* (fig. 5) is required. It is a thin frame, which exactly corresponds to

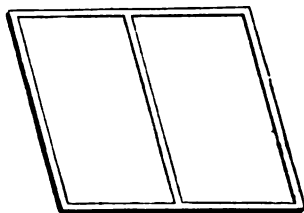

Fig. 5.

the frame of the mould, and the workman first places the deckle on the mould, and then dips them into the pulp; the deckle forms a ridge which retains just enough of the liquid pulp for the sheet of paper. The water of the pulp speedily drains through the wire gauze, and after it has stood in an inclined position for a few minutes, another workman, called the *coucher*, applies the

face of the sheet of pulp to a piece of felt or flannel cloth stretched on a board, called the *couch*, and the sheet thus pressed, leaves the mould, and is left on the *couch*. Every successive sheet is similarly treated, and they are piled one on another, with a sheet of felt between each, until from four to eight quires, or a *post*, as it is called, is formed. Each post is put in a press, and under pressure parts with nearly all the moisture in the sheets of paper. The felts are then removed, and after several pressings, and other minor operations, the paper is hung on hair ropes, called *tribbles*, in the drying-loft; and when dried, resembles blotting-paper, and cannot be written upon. This is remedied by dipping it in a weak solution of hot size, sometimes tinged with colour, after which it is pressed, dried, folded, and made up into quires. Hot pressing and glazing are done by passing the sheets through hot and polished iron rollers.

In Britain very little paper is now made by hand, the wonderful paper-machine having entirely changed the character of the manufacture. It is usually stated that Louis Robert, a Frenchman, invented the paper-machine, and that it was brought to this country by Didot of Paris in an imperfect state, but received improvements from Fourdrinier. This ingenious manufacturer certainly did very much to make the paper-machine useful and perfect, but it must not be overlooked that Bramah took out a previous patent in 1805, rather more than a year before Fourdrinier, for very similar improvements to those described in Fourdrinier's specification. The object of all was to cause an equal and well-regulated supply of the pulp to flow upon an endless wire-gauze apron, which would revolve and carry on the paper until it is received on an endless sheet of felt, passing around and between large couching cylinders. These machines have now been brought to such perfection, that paper can be made in one continuous web of any length; and before leaving the machine, is dried, calendered, hot pressed, and cut into sheets. Different engineers have varied the construction of the paper-machine, but the general principles of all are the same. We therefore select for illustration the machine which was exhibited by Mr George Bertram of Edinburgh, and which was universally acknowledged to be by far the most complete and perfect which was presented in the International Exhibition of 1862.

Fig. 6 is a side view of the machine, and fig. 7 a vertical one. The principle of the machine is very simple; it contains a pulp vat, A (figs. 6 and 7), with a hog or wheel inside to agitate the pulp, and an arrangement for pouring the pulp over the wire-gauze mould, B, B, B, B, which instead of being in single squares, as in the hand-process, is an endless sheet moving round two rollers, *a, b*, which keep it stretched out and revolving when in operation. Under the part which receives the pulp there is a series of small brass rollers, *d* (fig. 6), these, being nearly close together, keep it perfectly level, which is a most necessary condition; besides which, there is a shallow trough, *ee* (fig. 6), called the *scave all*, which catches and retains the water, which always escapes with some pulp in suspension; and an arrangement of suction boxes and tubes, *f, f, f* (fig. 6), worked by air-pumps, which draw much of the water out as the pulp passes over them. The pulp is kept from running over the sides by straps called the *deckles*, which are also endless bands, usually of vulcanised India-rubber, carried round moving rollers, so that they travel with the wire-gauze, and therefore offer no resistance to it. In addition to all this, the framework on which the surface of the wire-gauze rests

has a shogging motion, or side-shake, which has an important effect in working the fibres together before the pulp finally settles down. When it reaches the *couching-rolls*, which press out most of the remaining moisture, and carry it forward to the first and second series of press-rolls by means of an endless web of felt which passes round them, the speed of these rollers and the travelling sheet of felt, CC (figs. 6 and 7), is nicely calculated, so as to prevent a strain upon the still very tender web of paper. Sometimes the upper rollers of these two series are filled with steam, in order to commence drying the web. The paper is now trusted to itself, and passes on, as indicated by the arrows, from the second press-rolls to the first set of *drying cylinders*, DD (figs. 6 and 7), where it again meets with a felt sheet, which keeps it in close contact with the drying cylinders, which are of large size, and filled with steam. Around these it passes, drying as it goes; is then received between the two *smoothing-rolls*, or damp calenders, which press both surfaces, and remove the marks of the wire and felt, which are until then visible on the paper. This is necessarily done before the drying is quite completed; and from the smoothing-rolls it passes to the second series of drying cylinders, E (figs. 6 and 7), where the drying is finished, and thence to the calenders, which are polished rollers of hard cast-iron, so adjusted as to give a considerable pressure to the paper, and at the same time a glossiness of surface. For writing-papers, the paper passes through a shallow trough of size after leaving the drying cylinders, and

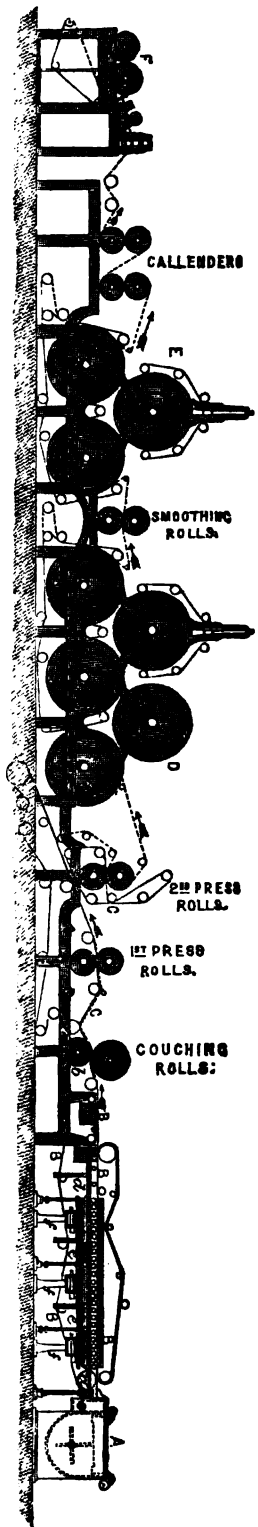

Fig. 6.

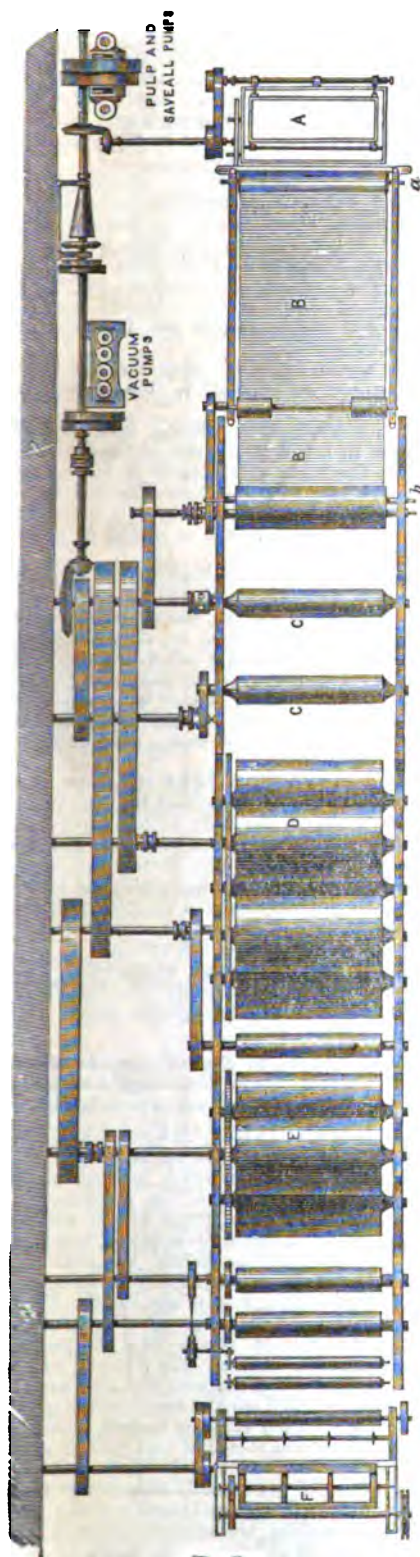

Fig. 7.

then passes over another series of skeleton cylinders with fans moving inside, by which it is again dried without heat, and afterwards passes through the calenders. Printing and other papers are usually sized by mixing the size in the pulp, in which stage the colouring materials—such as ultramarine for the blue tint of foolscap—are also introduced. Still following the paper web in the drawing (fig. 6), it is seen to pass from the calenders to another machine, F; this slits the web into widths, which are again cross cut into sheets, the size of which is regulated at will. The water-mark is impressed on machine-made paper by means of a fine light-wire cylinder with a wire-woven pattern; this is placed over the wire-gauze sheet upon which the pulp is spread, but near the other end of it, so that the light impression of the marker may act upon the paper just when it ceases to be pulp, and this remains all through its course. There are many other interesting points about the paper-machine, but their introduction here would rather tend to confuse the reader. Its productive power is very great; it moves at a rate of from 30 to 70 feet per minute, spreading pulp, couching, drying, and calendering as it goes, so that the stream of pulp flowing in at one end is in two minutes passing out finished paper at the other. It has been computed that an ordinary machine, making webs of paper 54 inches wide, will turn out four miles a day, and that the total production of all the mills in Britain is not less than 6,000,000 of yards, or 3400 miles daily.

For very obvious reasons, the manufacture of paper has been localised on the banks of streams that afford an abundant supply of pure water for washing and pulping. Kent is celebrated for its paper-mills and for the fine quality of its paper, and is the chief county in this respect. Next follow Hertfordshire (where it was first commenced in England in 1490 by John Tate of Stevenage, of whom it is said in a book printed by Caxton,

Which late hathe in England doo make thys paper thynne,  
That now in our Englysh thys booke is printed inne;

and the same John Tate is mentioned in Henry VII.'s Household Book, under dates May 25, 1498 and 1499, 'for a rewarde geven at the paper-mylne,' and 'geven in rewarde to Tate of the mylne, 6s. 8d.'). Buckinghamshire, Oxfordshire, and Lancashire. It was introduced into Scotland in the year 1695, when a company was formed for carrying it on under 'Articles' signed at a general meeting held in Edinburgh, which articles are now in the Library of the British Museum. It has become a very important branch of manufacture; and not only is paper of a very fine quality made from rags and the new material Esparto, Alfa, or Spanish Grass (the *Lygeum Sparteum* of botanists), but also the manufacture of paper-machines is carried on most successfully both for foreign and home use. Both of these manufactures are carried on in the immediate neighbourhood of Edinburgh. Since the introduction of the penny postage, penny papers, and other economical measures, especially the abolition of the excise-duty, an enormous impetus has been given to this branch of our home-manufacture, and considerable difficulty has been found in supplying the makers with raw material: this difficulty has been much increased by the export duties laid by other countries upon the export of rags. The greatest relief has been experienced by improved methods for preparing paper pulp from straw, and from the introduction of the Esparto, which yields half its weight of paper. Of this material our imports have risen to 50,000 tons per annum, which represents 25,000 tons of paper. The imports of

rags, notwithstanding the foreign impediments, have been also very large during the last eight years. They are as follows: 1856, 10,287 tons; 1857, 12,206 tons; 1858, 11,394 tons; 1859, 14,261 tons; 1860, 16,145 tons; 1861, 20,848 tons; 1862, 23,943 tons; and 1863, 45,448 tons. Judging from good data, this manufacture has more than doubled since the abolition of the paper-duty, at which time it was very nearly 100,000 tons—a quantity so vast, that it will remove all surprise at the difficulty of supplying the raw materials.

The following are the principal varieties of ordinary paper, and the sizes of the sheets given in inches:

1. *Writing and Printing Papers*.—*Pot* (so named from its original water-mark, a tankard), 12½ by 15; *Double Pot*, 15 by 25. *Foolscap*, 16½ by 13½; *Sheet-and-third Do.*, 22½ by 13½; *Sheet-and-half Do.*, 22½ by 13½; *Double Do.*, 27 by 17. *Post* (so called from its use in letter-writing; one of its original water-marks was a postman's horn), 18½ by 15½; *Large Do.*, 20½ by 16½; *Medium Do.*, 18 by 22½; *Double Do.*, 30½ by 19. *Copy*, 20 by 16½. *Double Crown*, 20 by 30. *Demy*, 20 by 15; *Printing Do.*, 22½ by 17½; *Medium Do.*, 22 by 17½; *Medium Printing Do.*, 23 by 18½. *Royal*, 24 by 19; *Printing Do.*, 25 by 20; *Super-royal*, 27 by 19; *Super-royal Printing*, 21 by 27. *Imperial*, 30 by 22. *Atlas*, 34 by 26. *Columbier*, 34½ by 23½. *Elephant*, 28 by 23; *Double Do.*, 26½ by 40. *Antiquarian*, 53 by 31: this is generally, if not always, hand-made.

These sizes are somewhat lessened by ploughing and finishing off the edges previous to sale.

2. *Coarse Papers for wrapping and other purposes*.—*Kent-cap*, 21 by 18; *Bay-cap*, 19½ by 24; *Havon-cap*, 21 by 16; *Imperial-cap*, 22½ by 29. *Double 2-lb.*, 17 by 24; *Double 4-lb.*, 21 by 31; *Double 6-lb.*, 19 by 28. *Cartridge*, *Casing*, and *Middle-hand*, &c., 21 by 16. *Lumber-hand*, 19½ by 22½; *Royal-hand*, 20 by 25; *Double Small-hand*, 19 by 29.

Purple papers of a soft texture, unsized, are used in very large quantities by sugar-refiners, of the following sizes: *Copy-loaf*, 16½ by 21½; *Powder-loaf*, 18 by 26; *Double-loaf*, 16½ by 23; *Single-loaf*, 21½ by 27; *Lump*, 23 by 33; *Hambro'*, 16½ by 23; *Tiller*, 29 by 35; *Prussian*, or *Double Lump*, 32 by 42.

*Blotting and Filtering Paper*.—This is unsized paper, made of good quality, and usually coloured pink or red, and of the same size as demy.

Besides these, which are well-known trade definitions, there are very many others, amounting, if we include *paste* and *mill boards*, to at least twelve or fifteen hundred, so that even paper-manufacturers require the aid of a treatise upon the subject of the sizes, qualities, &c., and such a treatise is in common use.

Even as regards materials, varieties are endless. In an old German book by Jacob Christian Schäffers, published at Regensburg in 1772, there are no less than eighty-one samples of different kinds of paper bound up and forming part of the book, and innumerable others have been made since.

Rice paper is a beautiful material imported from China, about which numberless errors have been written. It is now known to be formed of thin slices of the pith of the plant called *Aralia papyrifera*. This pith can be obtained from the stems in beautiful cylinders, from one to two inches in diameter, and several inches in length. The Chinese workmen apply the blade of a sharp, straight knife to these cylinders of pith, and, turning them round dexterously, pare them from the circumference to the centre, making a rolled layer of equal thickness throughout. This is unrolled, and

weights are placed upon it until it is rendered perfectly smooth and flat. Sometimes a number are joined together to increase the size of the sheets. It will be seen that this more nearly resembles the ancient papyrus than modern paper; but it is more beautiful than the former, being a very pure pearly white, and admirably adapted to the peculiar style of painting of the Chinese.

The ordinary papers of the Chinese, Japanese, and East Indians have much resemblance to each other, which arises from the manufacture and material being similar; the bark of the paper mulberry (*Broussonetia papyrifera*) being chiefly used. The Chinese and Japanese are the most skillful paper-makers in the world, and some of the East Indian papers surpass the European manufactures completely.

Some useful kinds of paper are the result of manipulations subsequent to the paper-maker's work. Thus:

*Lithographic Paper* is prepared from good printing-paper by laying on one side of the sheets a preparation consisting of six parts of starch, one of alum, and two of gum-arabic dissolved in warm water, and applied whilst hot with a proper brush. Generally a little gamboge is added, to give it a slight yellow colour.

*Copying Paper*, for manifold-writers, is made by applying a composition of lard and black-lead to one side or both of sheets of writing-paper; and after leaving it on for a day or so, it is carefully and smoothly scraped off and wiped with a soft cloth.

*Tracing Paper* is good printing-paper rendered transparent by brushing it over with a mixture of Canada balsam and oil of turpentine, or nut oil and turpentine. In either case it must be carefully dried before using.

There are two distinct classes of coloured paper. In one, the colour is introduced into the pulp, and is consequently in the body of the paper; in the other, the colours are mixed with size, and applied to the surface. There have been many ingenious and tasteful inventions for decorating the surface of paper, such as by giving it a marbled and even a beautiful iridescent appearance, but they are too numerous for the limits of this article.

Paper is subject to much adulteration. China-clay and gypsum are generally used for the white sorts, and the heavy ferruginous ochres for the coarse and brown kinds.

**PAPER-BOOK**, in English Law, is the name given to the pleadings on both sides in an action at law, when the issue is one, not of fact, but of law.

**PAPER-HANGINGS**. This name is applied to the webs of paper, *papiers peints* of the French, usually decorated, with which interior walls are often covered. Previous to the invention of the paper-machine, sheets of paper of the size called *Elephant*, 22 by 32 inches, were pasted together, to make 12 yard lengths, before the pattern was imprinted; but this is now rendered unnecessary by the facility of making webs of any length. Upon the paper it is usual first to spread a ground-colour, with proper brushes, taking care to produce a perfectly smooth surface. The colours employal are opaque, and are mixed with size, and sometimes also with starch, and most of the ordinary pigments are used. In the early stages of the art, it was usual to have the patterns stencilled (see STENCILLING) on the ground-colour. The stencilling plates were usually pieces of pasteboard, one being required for every differently-coloured portion of the pattern. Afterwards, wooden blocks were adopted, similar to those used in calico-printing made of pear or poplar wood, generally the width of the paper,

forming, indeed, huge woodcuts, on which the pattern is in high relief. As many blocks are required as there are colours in the pattern, each bearing only so much of the pattern as is represented by the colour to which it is assigned. Of course, the whole beauty of the work depends upon the nice adjustment of one portion of the pattern to another; and this is determined by guide-pins in the blocks, which are so managed as not to disfigure the surface with their points. The pattern-block, being coated with its particular colour from the colour-tub, is laid on the paper, which is stretched out for the purpose on a table, and a lever is brought to bear upon it with sufficient pressure to make the whole of the block bear equally upon the paper. When one block has been printed the whole length of the paper by a succession of impressions, the piece is taken to the drying-room, and dried, previous to receiving the next colour; and it often happens that the same operations have to be repeated a dozen different times before the pattern is completed. This process is now being rapidly superseded by the cylinder printing-machines, which are of the same kind as are used in printing textile fabrics. In these machines, the pattern is engraved on a series of copper cylinders, and each part or colour has a separate cylinder, and an arrangement for keeping it constantly supplied with colour when working. The cylinders are so arranged as, by the sum of their revolutions, to make the pattern complete; so that as the web of paper passes the first, it receives the colour for one portion of the pattern, and reaches the second in exact time to have the next colour applied in the right places. In this way the entire piece only occupies a few seconds in receiving the complete decoration.

The polished or glazed papers have the ground prepared with gypsum or plaster of Paris, and the surface dusted with finely-powdered steatite, or French chalk. When perfectly dry, this is rubbed hard with a burnishing-brush, until the whole is evenly polished. This is generally done before the pattern is printed, but in some cases pattern and ground are both polished. In making the *flock-papers*, the printing is done in the same way as in the block-printing, only, instead of coloured material, a composition called *encaustic* is printed on. It consists of linseed-oil, boiled with litharge, and ground up with white-lead; sufficient litharge is used to make it dry quickly, as it is very adhesive. The flock is prepared from the shearings of woollen cloths from the cloth-mills, by washing and dyeing the shearings to the various colours, then stove-drying and grinding them in a peculiar mill, which, in their brittle state, after leaving the stove, breaks them short. After this they are sifted, to obtain various degrees of fineness. By nice management, the prepared flock is so sprinkled over the whole of the printed surface as to coat the encaustic, and adhere evenly and firmly to it. The same adhesive material is used for printing in gold and other metals. The pattern being printed with the encaustic, gold or other metallic leaf is applied, and when it is properly fixed, the loose metal is brushed away with a hare's-foot or other soft brush. Some of the finest French papers have much of the pattern actually painted in by hand, a process which, of course, renders them very costly.

**PAPER MULBERRY.** See MULBERRY.

**PAPER NAUTILUS.** See ARGONAUT.

**PAPHLAGONIA**, anciently a province of Asia Minor, extending along the southern shores of the Black Sea, from the Halys on the east, to the Parthenus on the west (which separates it from Bithynia),

and inland on the south to Galatia. Its limits, however, were somewhat different at different times. The Paphlagonian mountains were covered with forests, and the inhabitants were famous as hunters. Croesus made P. a part of the kingdom of Lydia, and Cyrus united it to Persia; it subsequently became part of the empire of Alexander the Great, and afterwards of the kingdom of Pontus, was included in the Roman province of Galatia, and in the 4th c. of the Christian era was made a separate province by Constantine. Its capital was Sinope. The Paphlagonians are supposed to have been of Syrian, or at least of Semitic origin, like the Cappadocians. They were proverbially rude, coarse, and deficient in understanding, but this probably refers only to the country-people in the interior.

**PAPHOS**, anciently the name of two cities in the isle of Cyprus. The older city, sometimes called *Palaipaphos* (now *Kuklos* or *Kouklia*), was situated in the western part of the island, about 1½ miles from the coast. It was probably founded by the Phœnicians, and was famous, even before Homer's time, for a temple of Venus, who was said to have here risen from the sea close by, whence her epithet *Aphrodite*, 'foam-sprung,' and who was designated the Paphian goddess. This was her chief residence, and hither crowds of pilgrims used to come in ancient times.—The other Paphos, called *Neopaphos* (now *Baffa*), was on the sea-coast, about seven or eight miles north-west of the older city, and was the place in which the apostle Paul proclaimed the gospel before the proconsul Sergius.

**PAPIAS**, Bishop of Hierapolis in Phrygia, was a Christian writer, who flourished in the 2d century. According to Irenæus, he was a disciple of the apostle John; but Eusebius, who quotes (*Historia Ecclesiastica*, chap. 39) the words of Irenæus, immediately subjoins a passage from P. himself, in which the latter distinctly states that he did not receive his doctrines from any of the apostles, but from the 'living voice' of such followers of theirs as 'are still surviving.' He was, however, an 'associate' of Polycarp, a bishop in the same province of proconsular Asia; and as the latter was a disciple of the apostle John, it is probable that Irenæus—a somewhat hasty writer—inferred that his companion must have been the same. The *Paschal or Alexandrian Chronicle* states that he suffered martyrdom at Pergamus, 163 A. D. Eusebius describes P. as 'well skilled in all manner of learning, and well acquainted with the Scriptures;' but a little further on, he speaks of him as a man 'of limited understanding' (*smikrôs en tôn noîn*), and a very credulous chronicler of 'unwritten tradition,' who had collected 'certain strange parables of our Lord and of his doctrine, and some other matters rather too fabulous.' The work in which these were contained was entitled *Logiôn Kuriaîkôn, Exegeseôs Bibliai E'*. (Five Books of Commentaries on the Sayings of our Lord). It is now lost, but certain fragments of it have been preserved by Irenæus, Eusebius, Maximus Confessor, and other writers. These fragments are extremely interesting, because of the light which they throw on the origin of the New Testament Scriptures, and their importance may be estimated from the fact, that they contain the earliest information which we possess on the subject. It is P. who is our authority for the statement, that the evangelist Matthew drew up a collection of our Lord's sayings and doings (*ta logia*) in the Hebrew (probably Syro-Chaldaic or Aramaic) dialect, and that every one translated it as he was able. There can be no doubt that this is a perplexing statement, suggesting as it does the delicate question: 'If Papias is correct, who wrote our present Matthew, which is in Greek,

and not in Hebrew?' (For a consideration of this point, see MATTHEW.) P. also tells us, either on the authority of John the Presbyter, or more probably on that of one of his followers, that the evangelist Mark was the interpreter (Hermeneutes) of Peter, and wrote 'whatsoever he [Peter] recorded, with great accuracy.' But the passage is far from implying that Mark was a mere amanuensis of Peter, as some have asserted, but only, as Valesius has shewn, that Mark listened attentively to Peter's preaching, culled from it such things as most strictly concerned Christ, and so drew up his gospel. P., it remains to be said, was an extreme millenarian. See MILLENNIUM.

**PAPIER-MÂCHÉ** (Fr. mashed or pulped paper). This manufacture has certainly been in use for more than a century in Europe; but it is not improbable that it was first suggested by some of the beautiful productions of Sindh and other parts of India, where it is employed in making boxes, trays, &c., as well as in China and Japan. Its first application, as far as we know, was to the manufacture of snuff-boxes by a German named Martin, in 1740, who learned it of a Frenchman named Lefevre; but the French say that he learned the art in England. Properly speaking, papier-mâché is paper-pulp moulded into shape, and it has been used, not only to make small articles, such as boxes, trays, &c., but in the interior decoration of houses for cornices, ceilings, &c. The ceilings in Chesterfield House, and some other fine Elizabethan structures, are made of this material, which at one time, owing to a combination of the stucco-workers to raise the price of their labour, took the place almost entirely of stucco in house ornamentation. At present, a combination of both stucco and paper is similarly employed under the name of *Carton-pierre*. From the extension of the applications of papier-mâché to the manufacture of a number of light and useful articles, modifications have taken place in its composition, and it is now of three kinds—1st, the true kind, made of paper-pulp; 2d, sheets of paper pasted together after the manner of pasteboard, but submitted to far greater pressure; and 3d, sheets of thick millboard cast from the pulp are also heavily pressed. The term papier-mâché is in trade held to apply rather to the articles made of the pulp than to the pulp itself; and a vast manufacture has sprung up during the present century, particularly in Birmingham, in which a great variety of articles of use and ornament are made of this material. They are coated with successive layers of asphalt varnish, which is acted upon by heat in ovens until its volatile parts are dissipated, and it becomes hard, and capable of receiving a high polish. Mother-of-pearl is much used in their decoration, for which purpose, when several layers of the varnish still remain to be applied, thin flakes of the shell of the form of the pattern are placed on the varnish, and are covered by the succeeding layers, giving rise to elevations where they are hidden by the coats of varnish. The surface is then ground down smooth and polished, and the grinding down brings to light the pieces of mother-of-pearl shell, which thus present the appearance of inlaid patterns. The fine surface which can be given to the asphalt varnish, also permits of burnished gilding and other decorative applications with excellent effect.

**PAPILIO**. See BUTTERFLY.

**PAPILIONACEÆ**, a suborder of the natural order of plants generally called *Leguminosæ* (q. v.).—The plants of this suborder are the only plants known which have flowers of the peculiar structure called *papilionaceous*, and of which the Pea and

Bean afford familiar examples. The name is derived from Lat. *papilio*, a butterfly. Papilionaceous flowers have five petals, imbricated in estivation (bud), one of which, called the  *vexillum*, or *standard*, is superior, turned next to the axis, and in estivation folded over the rest; two, called the *alæ*, or *wings*, are lateral; and two are inferior, which are often united by their lower margins, forming the *carina*, or *keel*. The number of the P. is very great—about 4800 species being known. They are found in all parts of the world, abounding in the tropics. Many have superb and beautiful flowers; many are plants of beautiful form and foliage, trees, shrubs, or herbaceous plants; many possess valuable medicinal properties; and many are of great importance as furnishing food for man and for domestic animals, others as furnishing dyes, fibre, timber, &c. See BROOM, LABURNUM, CLOVER, BEAN, PEA, LUCERNE, LIQUORICE, INDIGO, SANDAL-WOOD, &c.

**PAPILLÆ**. This term is applied by anatomists to minute, elongated, conical processes, projecting from the surface of the true skin into the epidermis, highly vascular and nervous in their character, and taking an active part in the sense of touch. Their form and structure are described in the article SKIN. The mucous membrane of the tongue also contains three varieties of papillæ, which are described in the article TASTE, ORGAN AND SENSE OF.

**PAPIN, DENIS**, a celebrated French physicist, was born at Blois, 22d August 1647, and studied medicine in Paris, where, after receiving his degree, he practised for some time as a physician. He now became acquainted with Huyghens—an incident which strengthened in him an original predilection for physical science; and from this time, he devoted himself almost exclusively to his favourite study. Before P.'s time, the intense force which can be generated in water, air, &c., under the action of heat, was well known, but he was one of the first to indicate the principal features of a machine by which this property could be made of practical utility. He soon acquired a wide reputation; and on visiting England, was received with open arms by the philosophers of that country, and became a member of the Royal Society in 1681. While in England, P. and Boyle (q. v.) together repeated their experiments on the properties of air, &c.; but in 1687, P. was called to the chair of Mathematics in the university of Marburg in Hesse-Cassel, the duties of which office he discharged with zeal and success for many years. He died at Marburg about 1714. The French Academy of Sciences, withholding from P. the honour of 'associate,' enrolled him among its 'correspondents'—a proceeding on the part of the Academy which has, with reason, excited the astonishment of F. Arago. To P. undoubtedly belongs the high honour of having first applied steam to produce motion by raising a piston; he combined with this the simplest means of producing a vacuum beneath the raised piston—viz., by condensation of aqueous vapour; he is also the inventor of the 'safety-valve,' an essential part of his 'Digester' (q. v.). By this latter machine, P. shewed that liquids in a vacuum can be put in a state of ebullition at a much lower temperature than when freely exposed to the air. P.'s sagacity led him to many other discoveries; he discovered the principle of action of the siphon, improved the pneumatic machine of Otto de Guericke (q. v.), and took part against Leibnitz in the discussion concerning 'living' and 'dead' forces. Unfortunately for science, P.'s numerous writings have not yet been collected, but many of them will be found in the *Philosophical Transactions*, *Acta Eruditorum*, and the *Recueil de Diverses Pièces*. He

published two works—one being an explanation of the construction and uses of his 'digester' (Lond. 1681), afterwards (1682) translated into French, and his experiments entitled *Nouvelles Expériences du Vide* (Paris, 1674). It was not till nearly a century after that the great value of P.'s discoveries was perceived.

PAPINIANUS, ÆMILIUS PAULLUS, the most celebrated of Roman jurists, was born towards the middle of the 2d c.; and during the reign of the Emperor Severus (q. v.), whom he succeeded as *Advocatus Fisci*, and whose second wife is said to have been P.'s relative, he held the office of *Libellorum Magister*, and afterwards that of *Præfectus Prætorio*. After the death of Severus, his son and successor, Caracalla, dismissed P. from his office, and soon afterwards caused him to be put to death on various pretexts, the real reason, however, appearing to be that the emperor was afraid the influence of a man so able and upright would be dangerous to his power. P.'s works consist chiefly of 37 books of *Quæstiones*, 19 of *Responsa*, 2 of *Definitiones*, two works, *De Adulteris*, and a Greek fragment; and from these works there are in all 595 excerpts in the Digest (q. v.). The pupils of P. include the most famous names in Roman jurisprudence, such as Ulpian, Paullus, Pomponius, Africanus, Florentinus, and Modestinus, but the master stands superior to them all. The high reputation he enjoyed among his contemporaries and successors may be gathered from the epithets *Prudentissimus*, *Consultissimus*, *Disertissimus*, bestowed upon him by various emperors, and from the first book of the *Codex Theodosii*, *De Responsis Prudentum*, in which, after declaring the works of P., Paullus, Caius, Ulpian, Modestinus, and four others, to be authority for a judge's decision, it is declared that should these jurists be equally divided in opinion, that opinion which was maintained by P. was to be considered right; while his commentator, the celebrated Cujacius (q. v.), goes so far as to declare 'that Papinianus was the first of all lawyers who have been, or are to be,' and that 'no one ever will equal him.' His high reputation as a jurist was much enhanced by the strong moral feeling and stern unbending honesty which were equally characteristic of him, and which have stamped his works with an ineffaceable impress. P.'s works were studied both before and after Justinian's time by Roman legal students of the third year, who were for this reason denominated Papinianistæ. The fragments of P.'s works which now remain are somewhat obscure, and the excerpts from them in the Digest are in general so brief, that the aid of a commentator is required.

PAPIST (Lat. *papista*, an adherent of the pope) is a name applied, generally with some admixture of contempt, to members of the Roman Church. Of itself, it implies nothing more than that they are adherents of the pope; but in its popular use it includes all the distinctive doctrines of Roman Catholics, and especially those which are supposed to be peculiarly cherished by the supporters of the papal authority. It is therefore in many cases held to be synonymous with the profession of the extremest opinions permitted in the Church of Rome, and even those which are popularly regarded as superstitious. Understood literally, no consistent Roman Catholic would disclaim it; but in the imputed signification explained above, it is held to be offensive.

PAPPENHEIM, GOTTFRIED HEINRICH, COUNT VON, an imperial general of great note in the Thirty Years' War, was born at Pappenheim, in Middle Franconia, Bavaria, 29th May 1594, of a very ancient Swabian family, in which the dignity

of Marshal of the Empire became hereditary about the 13th or 14th c., and many of whose members had greatly distinguished themselves in the wars of the middle ages. When about 20 years of age, P. went over to the Roman Catholic Church, and thenceforth signalled himself by his fiery zeal in its cause. After serving under the king of Poland in his wars with the Russians and Turks, P. joined the army of the Catholic League, and in the battle of Prague (1620) stayed the flight of the Austrian cavalry, and by a well-timed and furious charge turned the tide of battle against the Bohemians. In 1623, he received from the emperor the command of a cavalry regiment of the famous 'Pappenheimer Dragoons;' and in 1625, became general of the Spanish horse in Lombardy; but in 1626 re-entered the Austrian service, and after suppressing a dangerous revolt of the peasants of Upper Austria, in which 40,000 of the peasants perished, he joined the army which was opposed to the Protestant league, and, in association with Tilly, carried on many campaigns against the Danes, Swedes, and Saxons. It was P. who urged and induced Tilly to take Magdeburg by assault, and himself led and directed the attack. Moreover, it is he, rather than Tilly, who was to blame for the ferocious massacres which followed. His reckless bravery involved Tilly, against his will, in the disastrous battle of Breitenfeld; but to some extent he retrieved his character by his strenuous efforts to remedy the loss, and protect the retreat of the army. After Tilly's death, he was associated with Wallenstein, who detached him with eight regiments to protect Cologne, but on hearing of the advance of Gustavus, sent an urgent order for his return. P. arrived at Lützen at the moment when Wallenstein's army was on the point of being completely routed, and at the head of his cuirassiers, charged the left wing of the Swedes, throwing it into confusion, and almost changing the fortune of the battle by his extraordinary bravery. He was mortally wounded in the last charge, and died a few hours afterwards at Leipzig, November 7, 1632, with a smile on his countenance, after learning that Gustavus Adolphus had died before him. 'God be praised!' he said; 'I can go in peace, now that that mortal enemy of the Catholic faith has had to die before me.'

PA'PPUS, in Botany, an appendage of the fruit of plants belonging to certain natural orders, of which the great natural order *Compositæ* is the chief.

It consists either of simple (figs. 1 and 4) or feathery (figs. 2 and 5) hairs, sessile or stalked, arising from the summit of the fruit, and is produced by a development of the tube and limb of the persistent calyx. Its object appears to be to waft the ripened seed to the new situation in which it is to grow. *Thistle-down* is the pappus of the thistle. —The pappus is sometimes represented by mere teeth or scales.

PAPPUS of Alexandria, one of the later Greek geometers, of whose history nothing is known; he is said by Suidas to have lived during the reign of Theodosius the Great, emperor of the East (379—395). Some writers are of opinion that he lived two centuries earlier, but the former is much the more probable opinion. The chief work of P.

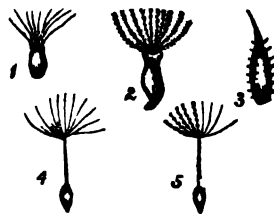

Pappus:  
1 and 2, sessile; 3, scale-like;  
4 and 5, stalked.



is his *Mathematical Collections*, of which the last six, out of eight books, are extant. The *Collections*, as their name implies, are an assemblage into one book of scattered problems and theorems, the work of Apollonius, Archimedes, Euclid, Theodosius, &c., to which he has joined his own discoveries. The first two books are supposed (on insufficient grounds) to have treated of arithmetic and arithmetical problems, but only a small fragment of the second book is extant: the third book is a collection of problems, mostly of solid geometry: the fourth treats of curves other than the circle, according to the method of pure geometry: the fifth contains problems of maxima and minima: the sixth treats of the geometry of the sphere: the seventh, which is by far the most important to modern geometers, as it is almost the sole authority we possess on the subject of the history and methods of the Greek geometrical analysis, treats principally of analysis; it also contains the proposition now known as 'Guldinus' Theorem,' which was plagiarised from P. by Father Guldin: the eighth and last book treats of machines. P. was the author of several other works which are lost, excepting only a fragment of his *Commentary on Four Books of Ptolemy's Syntaxis*. P., as an independent investigator, enjoys a high reputation, and is considered by Des Cartes as one of the most excellent geometers of antiquity. Some of his problems have been looked upon with high interest by all succeeding geometers. The *Mathematical Collections* have been published in whole or part, at various periods, but the only complete editions are the two Latin versions, the first by Commandine (Pisa, 1588), and the second by Manolissius (Bologna, 1660), and the Greek edition of H. J. Eisenmann (Paris, 1824). The portion of the Greek text of the 2d book, which was wanting in Commandine's MS., was published (1688) in London by Dr Wallia.

PAPUA, or NEW GUINEA, if we except Australia, the largest island on our globe, lies in the Australian Archipelago, in  $0^{\circ} 30' - 10^{\circ} 4' S.$  lat., and  $131^{\circ} - 151^{\circ} 30' E.$  long., and is about 1200 miles in length from the Cape of Good Hope on the north-west to South-East Cape. It is bounded on the S. by Torres Strait, W. by the Moluccas Sea, N. and N.E. by the Pacific Ocean. In outline P. is very irregular, the western part being nearly insulated by Geelvink Bay, entering from the north, and the Gulf of M'Clure from the west, whilst in the south it ends in a long and narrow peninsula of lofty mountains. A line passing through the island in  $141^{\circ} E.$  long. is over 300 miles; at the head of Geelvink Bay and the Gulf of M'Clure, not more than twenty. It is indented by numerous gulfs and bays, besides the two already mentioned. Geelvink Bay is 260 miles broad at its mouth, and trends inland 200 miles to within a short distance of the Bay of Lakahia, on the south-west coast. It receives the waters of many rivers, and is studded with islands, of which Jobi is the largest, being 66 miles in length from east to west, lofty, well wooded, and abounding in all sorts of tropical fruits and birds.

The principal capes are, South-East Cape, at the extreme east of the island; King William's Cape, Cape Rigny, Cape Bonpland, Cape Duperre; Cape D'Urville, on the north; the Cape of Good Hope, on the north-west; and Cape Van den Bosch, on the south-west.

Chief rivers are the Ambernon or Rochussen, which has its source in the mountains of the interior, and flowing towards the north-west, falls, by many mouths, through an extensive alluvial delta, into Geelvink Bay; Aird's River, which flows into the Great Bight; the Osta-Nata,

which, by three channels, enters the sea in  $4^{\circ} 30' S.$  lat., and  $136^{\circ} 30' E.$  long.; the Karoefa, to the north of Cape Van den Bosch, which enters Kamrao Bay on the south-west side, in  $3^{\circ} 48' S.$  lat., and  $133^{\circ} 28' E.$  long., and is half a mile wide.

The island is mountainous, except certain tracts of swampy land which have been formed by the river deposits. The southern peninsula is a mountain range with peaks far surpassing those of Australia in altitude, Mount Owen Stanley being 13,205 feet; Obree, 10,200; Yule Mountain, 9700; and many others of the same range approaching similar elevations. Passing in a line towards the north-west, the chain appears at different distances from the north coast, rises to the west of Humboldt's Bay into the Cyclops, the highest peak of which is 7000 feet, leaves its impress on Geelvink Bay, in the lofty island of Jobi, and further to the west shoots up in the Ariak and Amberbakin ranges, mountains of upwards of 9000 feet in height. The south-west coast is chiefly composed of lofty limestone hills, rising in terraces towards the interior till they attain the snow-line, Genofa, to the north of Kaimani Bay, being 5000, the Charles Louis 8852, and the Snow Mountains 15,400 feet above the sea-level.

Along the south-west shore are many coral banks, and the mountains are chiefly composed of white limestone, sometimes approaching to crystallisation. At Argoeni Bay, and other parts of the interior, they are of a brownish-gray sandstone. In the island of Lakahia, the Netherlands Scientific Commission, in 1858, found blue clay mixed with kidneys of ironstone, several croppings out of coal, and also sandstone. Nothing, however, is accurately known either of the mineral or vegetable wealth of the interior, the hostile and retiring nature of the mountaineers having hitherto closed it to the naturalist. On the north coast, near Humboldt's Bay, the earth and clay are of a brownish-red colour, with blocks of quartz here and there imbedded in it, the mountains being schistose, with the crystals of mica very small and compact. It has been said that P. produces gold, but it is as yet unknown, and the natives possess no ornaments or tools, except of wood, stone, and bone, but what are brought to them from Ceram.

P. is everywhere clothed with the most luxuriant vegetation, cocoa-nut, betel, sago, banana, bread-fruit, orange, lemon, and other fruit trees lining the shores; while in the interior are abundance of fine timber trees, as the iron-wood, ebony, canary-wood, the wild nutmeg, and the masooi, the fragrant bark of which is a leading article of export from the south-west coast. In the districts of the Ariak and Amberbakin Mountains the sugar-cane, tobacco, and rice are cultivated. The flower-garlanded and fruit-bearing forests are filled with multitudes of the most beautiful birds, of which are various kinds of birds of paradise, the crown-pigeon, parrots, lories, &c. Fish, of which upwards of 250 sorts have been enumerated, are plentiful, and are either speared or shot with the arrow, except at Humboldt's Bay, where they are caught with nets made from vegetable fibres, with large shells attached as sinkers. The larger animals are unknown, but wild swine, kangaroos, the koesi-koesi (a kind of wood-cat), are plentiful, as also a small kind of domesticated dog used in hunting.

The exports are masooi bark, trepang or becha-demer, tortoise-shell, pearls, nutmegs, birds of paradise, crown-pigeons, ebony, resin, slaves, &c., which are brought to the islands of Sirota, Namatotte, and Adi, on the south-west coast, where they are bartered, to the traders from Ceram, for hatchets, rice, large beads, printed cottons, knives, earthenware,

iron pans, copper, tobacco, sago, and other necessary articles. The produce is carried to Singapore and the Arroo Islands.

Except in the swampy districts, the climate is not unhealthy, though the temperature varies greatly, the thermometer sometimes indicating 95° F. by day, and falling to 75° by night. On the south-west coast, the east monsoon or rainy season begins about the middle of April, and ends in September; the dry season is from September to April; and on the north coast they are just reversed.

The limestone rocks on the south-western shore have many natural caverns, which serve as repositories for the bones of the dead; and within the Bight of Lakahia is a fine mountain-girt bay, which the Scientific Commission, appointed by the Netherlands government in 1858, called, after their steamship, Etna Bay, at the extremity of which is a splendid waterfall, 300 feet in height and 50 in breadth, which, seen in contrast with the bright green foliage, appears like a broad silver ribbon thrown over the forest trees.

P. is surrounded by countless islands, some of which are of considerable size. Towards the south is the Louisiade Archipelago, stretching over several degrees of longitude, out of which Aignan rises to the height of 3000 feet, and South-East Island to 2500. Near the Great Bight is Prince Frederik Hendrik Island, separated from the mainland by the Princess Marianne Strait. Namatotte, a lofty island in Speelman's Bay, in 3° 50' S. lat., and 133° 56' E. long., having good anchorage on the west side, and one of the chief trading-places on the coast; Aidoena, at the entrance of Triton's Bay, in 134° 20' E. long.; and Adi, or Wessels, to the south-east of Cape Van den Bosch, are the principal islands on the south-west coast. On the north, at the mouth of Geelvink Bay, lie the Schouten Islands, in 135°—137° 50' E. long., Mafor, Jobi, and many of less importance. Salawatti is a large and populous island, to the west of P., and further west is Batanta, separated from Salawatti by Pitt's Strait; west and south is the large island of Misool, or Waigamme, in 1° 45'—2° 3' S. lat., and 129° 30'—130° 31' E. long., having an area of 780 square miles, and a large population. It is highly probable that at no very distant geological period the Arroo, Misool, Waigion, Jobi, and other islands, formed part of the mainland of P., banks and soundings, reached by the 100-fathom line, connecting them with it. Only in the trackless wilds of P. and the adjacent islands are found the birds of paradise, with their marvellous development of plumage and incomparable beauty. Mr A. R. Wallace, who recently visited these regions as a naturalist, states that the coast districts of the northern part of P. contain *Paradisaea papuana* and *P. regia* pretty generally distributed; while *P. magnifica*, *P. alba*, and *Sericulus aureus* are scarce and local. The central mountains of the northern peninsula are alone inhabited by *Lophorina superba*, *Parotia seszacea*, *Astrapia nigra*, *Epimachus magnus*, and *Craspedophora magnifica*, the unique *Diphylloides Wilsoni* and *Paradigalla carunculata* probably also existing there. The Arroo Islands contain *P. apoda* and *P. regia*; Misool has *P. papuana*, *P. regia*, and *P. magnifica*; Waigion, *P. rubra*; Salawatti has *P. regia*, *P. magnifica*, *Ep. albus*, and *Sericulus aureus*; Jobi, *P. papuana*, and other species. The Key Islands, Ceram, &c., which are separated by deep sea, have no *Paradisaea*.

The population of P. and the immediately adjacent islands is supposed to be about 800,000; the part claimed by the Netherlands, as having formerly been tributary to the sultans of Tidore, stretching from Cape Bonpland, on the east of Humboldt's Bay, in 140° 47' E. long., to the Cape of Good Hope, and

further west and south-west to 141° E. long., with the islands on the coast, is estimated to have 220,000. The natives of the interior never acknowledged the supremacy of the sultans of Tidore, but the coasts and islands are governed by rajahs and other chiefs appointed by them to certain districts or kingdoms. This power is still exercised by the sultan of Tidore, subject to the approval of the Netherlands' resident at Ternate.

According to the system of Bory de St Vincent, the natives of P. are a race sprung from Neptunians and Oceanians, in character, features, and hair, standing between the Malays and Negroes. Dr Latham places them under the sub-class, Oceanic Mongolidae. See ETHNOLOGY. Those who live on the coast and islands are called Papuans, probably from the Malay word Papoewah or Poewah-Poewah, which signifies curly or woolly; the inhabitants of the interior, Alfoers. The Papuans are of middle stature and well made, have regular features, intelligent black eyes, small white teeth, curly hair, thick lips, and large mouth; the nose is sharp, but flat beneath, the nostrils large, and the skin dark brown. Around Humboldt's Bay the men stain their hair with the red earth which is abundant in that locality. Generally, the men are better-looking than the women, but neither are repulsively ugly, as has been repeatedly said. The Papuans of the coast are divided into small distinct tribes, frequently at war with each other, when they plant the paths to their villages with pointed pieces of bamboo or Nipa palm, called randjoes, which run into the feet of a party approaching to the attack, and make wounds which are difficult to cure. The men build the houses, hollow the trunks of trees into canoes, hunt and fish; while the women do all the heaviest work, cultivating the fields, making mats, pots, and cutting wood. Their food consists of maize, sago, rice, fish, birds, the flesh of wild pigs and fruits.

The Alfoers of the interior do not differ much in appearance from the Papuans, but, lower sunk in the savage life, are independent nomades, warlike, and said to be in some districts cannibals. They are called by the coast-people Woeka, or mountaineers, and bring down from their forest retreats the fragrant Masooi bark, nutmegs, birds of Paradise, and crown-pigeons to the coast, bartering them for other articles. The natives of the Ariak and Amberbakin ranges are more settled in their habits, and also cultivate the sugar-cane and tobacco as articles of commerce, but never build their houses at a lower level than 1000 feet from the base of the mountains. The people of the south-west coast are perfectly honest, open-hearted, and trustworthy. They have no religious worship, though some idea of a Supreme Being, called Awure, according to whose will they live, act, and die, but to whom no reverence is offered. They reckon time by the arrival and departure of the Ceram traders, or the beginning and ending of the dry and rainy seasons, and number only up to ten. Their dead are buried, and after a year or more, the bones taken up, and placed in the family tomb, erected near the house, or selected from the natural caverns in the limestone rocks. The women cover the lower part of the body; the men go all but naked, have their hair plaited or frizzled out, and ornamented with shells and feathers. Marriages are contracted early, and are only dissolved by death, and the women are chaste and modest. At Doreh, on the north coast, the bridegroom leads the bride home, when her father or nearest male relative divides a roasted banana between them, which they eat together with joined hands, and the marriage is completed. They have no religion, but believe that the soul of the father at death returns to the

son, and of the mother to the daughter. The Papuans of Humboldt's Bay are further advanced than those of any other part of the island, carve wood, make fishing-nets, build good houses above the water of the bay, and connect them with the mainland by bridges; each village has also an octagonal temple, ornamented within and without with figures of animals and obscene representations, though nothing is known of their religion. The largest temple, that of Tobaddi, received in 1858 the present of a Netherlands flag, which is flying from its spire, the natives little suspecting it to be a sign of asserted foreign supremacy. They are brave and open enemies, but bold and notorious thieves.

All attempts of the sultans of Tidore to introduce the Mohammedan religion in P. have failed. On the island of Massanama, to the east of Doreh harbour, the Protestant missionaries Ottow and Gieszler have been settled since 1855, and are well treated by the natives. These have formed a pretty complete vocabulary of the Myfore language of that district, which has no resemblance to that of the south-west coast.

P. was discovered by the Portuguese commanders Antonio d'Abreu and Francisco Serram in 1511, in part visited by the Dutch under Schouten in 1615; and in 1828 the Netherlands built a fort, called Du Bus, in Triton's Bay, 3° 42' S. lat., and 133° 51' 5" E. long., which after a few years was abandoned, on account of the deadly climate of the district. In 1845, Captain Blackwood, in H.M.S. *Fly*, surveyed a portion of the Great Eight. Captain Stanley, in the *Rattlesnake*, and Lieutenant Yule of the *Bramble*, surveyed the Louisiade in 1848. Most important knowledge regarding the south-west and north coasts up to 141° E. long. has been obtained through the Scientific Commission sent by the Netherlands government in 1858; but much of the coast, and almost the whole of the interior, are still a terra incognita.

See G. W. Earl, *The Native Races of the Indian Archipelago* (Lond. 1853); *De Zuid-West kust van N. Guinea, door J. Modera* (Haarlem, 1830); *N. Guinea onderzocht en beschreven, door een Nederlandsche Commissie* (Amsterdam, 1862); *Narrative of Search after Birds of Paradise*, by A. R. Wallace, F.Z.S., in *Proceedings of the Zoological Society of London* for 1862; and *De Papoeva's van de Geelvinksbai*, by A. Goudswaard (Schiedam, 1863).

**PAPULÆ AND PAPULAR DISEASES.** Papulæ, or pimples, constitute one of the eight orders of Bateman and Willan's classification of cutaneous diseases. They occur as little elevations of the cuticle, of a red colour, containing neither pus nor any other fluid, and ending usually in a scurf. They are generally supposed to denote inflammation of the papillæ of the skin; but Erasmus Wilson believes that they represent an inflammatory condition of the secretory orifices, whether sudoriferous or sebaceous. The diseases regarded as papular are Strophulus, Lichen, and Prurigo; but there are other diseases in which the first external symptom is a papular eruption, as, for example, small-pox, in which the papula speedily develops itself into a pustule.

**PAPYRI.** Rolls made of the paper of the papyrus plant are commonly known as *papyri*, corresponding to the Greek *biblia*. These rolls are of a very remote antiquity, some of the still remaining Egyptian papyri being certainly as old as the 6th dynasty, and others as old as the 12th, or from about 2000 B.C. This is owing to their mode of preservation, and to the peculiarly dry character of Egypt. These rolls have been found deposited in different ways, those of a religious nature being placed upon the bodies of mummies, at the feet, arms, or even in the hands, sometimes, indeed,

packed or laid between the bandages, or even spread over the whole bandages, like a shroud. At the time of the 19th and 20th dynasties (1320—1200 B.C.), they were often deposited in hollow wooden figures of the god Ptah Socharis Osiris, or of the god Osiris, which were placed near the mummies. Papyri of a civil nature were deposited in jars or boxes, which were placed near the mummies, or have been found in the remains of ancient libraries. The following are the principal kinds of Egyptian papyri: 1. Hieroglyphical papyri, always accompanied by pictures or vignettes, and consisting of three classes: 1. Solar litanies or texts, and pictures relating to and describing the sun's passage through the hours of the night, when that luminary was supposed to enter the Egyptian Hades or Hell. 2. Books of the empyreal gate, or heaven, with vignettes of deities, and other representations referring to the genesis of the cosmos or universe. 3. The so-called Ritual, consisting of a series of sacred or hermetic books, some of a very remote antiquity, accompanied with rubrical titles and directions as to their efficacy and employment, and comprising various formulas ordered to be placed on the coffins, amulets, and other furniture of the dead, for the better preservation of the souls of the dead and of the mummies in the future state. In this book, chapters giving an account of the future judgment, of the *makenu*, or boat of the dead, of the Elysian Fields, and of the Halls through which the dead had to pass, are also found. The work was considered by the Egyptians themselves mystic, and parts were supposed to be written by the god Thoth himself. A copy more or less complete, according to the wealth of the deceased, was deposited with all the principal mummies; and from the blank spaces left for the name, which were afterwards filled up, it is evident they were kept ready made.

—II. Hieratic papyri, written in the hieratic or cursive Egyptian hand, comprising a more extensive literature than the hieroglyphic papyri. This handwriting being used for civil as well as religious purposes, the papyri found in it differ considerably from one another, and comprise rituals of the class already mentioned, principally in use about the 26th dynasty, or the 6th c. B.C., but found also on some few papyri of a remote period; a book called the *Lamentations of Isis*; magical papyri, containing directions for the preparation of charms and amulets, and the adjuration of deities for their protection; civil documents, consisting of the examination of persons charged with criminal offences, the most remarkable of which are that of an offender charged with the practice of magic in the 19th dynasty, another of a criminal charged with robbing the royal storehouses, plunder of public property, violation of women, and other crimes, in the reign of Sethos I., and the *procès-verbal* of an offender charged with violating the sepulchres of the kings in the reign of Rameses IX. Besides these, there are several letters of various scribes upon subjects connected with the administration of the country and private affairs; laudatory poems of Egyptian monarchs, one describing the campaign of Rameses II. against the Khita or Hittites; historical documents, the journeys of official persons in foreign parts; works of fiction, one written by a scribe for a young prince, containing the adventures of two brothers, the death of the younger, owing to the false accusation of the wife of the elder, his revival, and transformation into a bull and a Persea tree. Prophecies or denunciations, and works on plants and medical subjects, books of proverbs, lists of kings, historical accounts—all occur amongst these documents.—III. The last class of Egyptian papyri, those written in the demotic

## PAPYRI—PAPYRUS.

or enchorial character, consist of rituals, contracts for the sale of mummies and lands, accounts and letters, and miscellaneous documents. These papyri are often bilingual, sometimes accompanied with hieratic or Greek versions. Many of these papyri have been translated by M. de Rouge, Chabas, Heath, Goodwin, Birch, and others. Many Greek papyri have been found belonging to the archives of the Serapeion, referring to the administration of that temple, the orations of Hypereides, and some of the books of Homer. At all times in the history of Egypt, libraries of papyri seem to have existed, and, under the Ptolemies, are said to have contained as many as 700,000 rolls.

Another class of ancient papyri, those of Pompeii and Herculaneum, are of considerable interest, as shewing the condition and arrangement of a Roman library. The papyri of Herculaneum are from 8½ to 12½ inches wide, and are rolled up in a cylindrical roll (*volumen*), upon a stick or inner roll (*bacillus*, *umbilicus*), having a stud at the end (*cornu*). They had their titles written on a strip (*lorum*), in red letters, and the writing was either on blind lines, or else on lines ruled with lead. About 1800 papyri were discovered at Herculaneum, in 1753, in the library of a small house, charred to a cinder, and some of these, by the greatest skill and care, have been unrolled by a very laborious process at Naples. Unfortunately, they have not answered the literary expectations formed of them, consisting of the works of philosophers of the Epicurean school, which the proprietor of the library seems to have collected. Some of the papyri were in Latin, and more difficult to unroll. Many of them have been published. They are only written on one side. When a small number were required, they were placed in a cylindrical bronze chest (*ciata*), packed tightly in a perpendicular position, and were taken out single, and read by unrolling from one end. These papyri were of various prices; old ones, like old books, being of immense value, but those containing the works of contemporary authors were not dearer, perhaps, than modern books. Many extensive private and public libraries existed in Greece and Rome, but all have perished except those exhumed from Herculaneum.

Wilkinson, *Man. and Cust.* iii. 62, 147, 188, v. 482; Mabillon, *De Re Diplom.* i. c. 8, p. 38; Winckelmann, ii. Bd. i. l.; Chabas, *Pap. d'Harris* (Chalon, 1860); *Papyrus Hieratiques* (8vo, Chalon, 1863); Birch, *Introduct. to Study of Hieroglyphs* (12mo, Lond. 1857); *Cambridge Essays* (1858), p. 227; De Rouge, *Rev. Contemp.* xxvii. p. 389; Heath, *Exodus Papyri* (Lond. 1855).

**PAPYRUS**, a genus of plants of the natural order *Cyperaceæ*, of which there are several species, the most important being the EGYPTIAN P. or *Papyrus* of the ancients (*P. antiquorum*, *Cyperus papyrus* of Linnæus); a kind of sedge, 8 to 10 feet high; with a very strong, woody, aromatic, creeping root; long, sharp-keeled leaves; and naked, leafless, triangular, soft, and cellular stems, as thick as a man's arm at the lower part, and at their upper extremity bearing a compound umbel of extremely numerous drooping spikelets, with a general involucre of 8 long filiform leaves, each spikelet containing 6—13 florets. By the ancient Egyptians it was called *papu*, from which the Greek *papyrus* is derived, although it was also called by them *tylos* or *deltos*. The Hebrews called it *gomé*, a word resembling the Coptic *gom*, or volume; its modern Arabic name is *Berdi*. So rare is the plant in the present day in Egypt, that it is supposed to have been introduced either from Syria or Abyssinia; but it has been seen till lately in the vicinity of the Lake Menzalah, and specimens sent to England;

and as it formerly was considered the emblem of Northern Egypt, or the Delta, and only grown there if introduced, it must have come from some country



*Papyrus (P. antiquorum).*

lying to the north of Egypt. It has been found in modern times in the neighbourhood of Jaffa, on the banks of the Anapus, in the pools of the Liane, near Syracuse, and in the vicinity of the Lake Thrasymenus. It is represented on the oldest Egyptian monuments, and as reaching the height of about ten feet. It was grown in pools of still water, growing ten feet above the water, and two beneath it, and restricted to the districts of Sais and Sebennytus. The P. was used for many purposes both ornamental and useful, such as crowns for the head, sandals, boxes, boats, and cordage, but principally for a kind of paper called by its name. Its pith was boiled and eaten, and its root dried for fuel. The papyrus or paper of the Egyptians was of the greatest reputation in antiquity, and it appears on the earliest monuments in the shape of long rectangular sheets, which were rolled up at one end, and on which the scribe wrote with a reed called *kash*, with red or black ink made of an animal carbon. The process of making paper from the papyrus is described in the article **PAPER**. When newly prepared, it was white or brownish white and lissom; but in the process of time, those papyri which have reached the present day have become of a light or dark brown colour, and exceedingly brittle, breaking to the touch. While papyrus was commonly used in Egypt for the purposes of writing, and was, in fact, the paper of the period, although mentioned by early Greek authors, it does not appear to have come into general use among the Greeks till after the time of Alexander the Great, when it was extensively exported from the Egyptian ports under the Ptolemies. Fragments, indeed, have been found to have been used by the Greeks centuries before. It was, however, always an expensive article to the Greeks, and a sheet cost more than the value of a dollar. Among the Romans, it does not appear to have been in use at an early period, although the Sibylline books are said to have been written on it, and it was cultivated in Calabria, Apulia, and the marshes of the Tiber. But the staple was no doubt imported from Alexandria, and improved or adapted by the Roman manufacturers. So extensive was the

Alexandrian manufactory, that Hadrian, in his visit to that city, was struck by its extent; and later in the empire, an Egyptian usurper (Firmus, 272 A.D.) is said to have boasted that he could support an army off his materials. It continued to be employed in the Eastern and Western Empire till the 12th c., and was used amongst the Arabs in the 8th; but after that period, it was quite superseded by parchment. At the later periods, it was no longer employed in the shape of rolls, but cut up into square pages, and bound like modern books.

As a matter of scientific interest, experiments on the manufacture of paper from the P. have been made in recent times by Landolina, Seyffarth, and others.—Another species of P. (*P. corymbosus* or *P. Pangorei*) is much used in India for making mats. See INDIAN GRASS MATTING.

PAR, or PARR, a small fish, also called BRANDLING and FINGERLING in different parts of Britain, inhabiting rivers and streams, and at one time believed to be a distinct species of the genus *Salmo*, but now almost universally regarded as the young of the salmon. The question will be noticed in the article SALMON. It may here, however, be mentioned, that it is difficult to discriminate the young of different species of this genus. The par rises with extraordinary readiness to the artificial fly; and until it began to receive protection as the fry of the salmon, vast numbers were killed both by youthful and adult anglers.

PARA', or BELEM, a thriving city and seaport of Brazil, capital of the province of the same name, stands on the east bank of the river Para, 80 miles from its mouth. Lat. 1° 28' S., long. 48° 23' W. The harbour is formed by an abrupt curve or inlet of the channel of the river, which is here 20 miles broad. Vessels of the largest size are admitted; the anchorage is roomy, safe, and easy of access. The streets are paved and macadamised; the houses, like those of most Brazilian towns, have whitened walls and red-tiled roofs. Among the principal buildings are the palace of the president, the cathedral, and the churches, all ample in size, and imposing in structure. There are also numerous public squares, a college, and a beautiful botanic garden. The city is supplied with water by water-carts that perambulate the streets. The 'Amazon Navigation Company,' a Brazilian association, has erected large workshops, coal depôts, and wharfs; and steam-navigation is rapidly extending. In 1859—1860, 228 vessels, of 63,347 tons, entered and cleared the port. In 1857—1858, the exports amounted to £399,333; in 1859—1860, to £665,196. The imports in 1857—1858 amounted to £414,967; in 1859—1860, to £529,863. The imports were principally cotton manufactures, wheat and flour, outlery and hardware, wool, gold and silver wares, coins, and wine. The exports were coffee, sugar, raw cotton, hides, tobacco, diamonds, cocoa, and india-rubber. Pop. 28,000. P. is the mart through which passes the whole commerce of the Amazon and its affluents. The city was the seat of revolution during the whole of the year 1835, when a great number of lives were lost and houses destroyed, and grass grew in streets that previously had been the centre of business. It is only since 1848 that the city can be said to have fairly entered upon the path of orderly commercial progress; and since that period, its advance has been rapid.

PARA', an important province of the empire of Brazil, in the extreme north of the country, is bounded on the N. by Guiana and the Atlantic, on the E. by Maranhão and Goyaz, on the S. by Matto Grosso, and on the W. by Amazonas. Area, 532,000

square miles; pop. (in 1856), 207,400. It is by far the largest province of Brazil—having an area more than twice the extent of Austria—is watered by the Amazon and its great affluents the Tapajós, Xingu, and Tocantins; and forms a portion of a district—the Amazon Valley—which has been described by the most thorough explorer of this region as unequalled for richness of vegetable production and fertility of soil. The surface of the country is level, and consists of great plains, intersected by rivers, and covered with primeval forests, and in some cases with rich pasture. The climate, though warm, is not unhealthy. The precious metals, with diamonds, iron, and coal, are found, but are not worked. The timber is valuable, and the chief crops raised upon the very limited area as yet brought under cultivation are coffee, rice, millet, and cotton.

PARA', the name of the south arm of the Amazon, forming an outlet for that river into the Atlantic, on the southern side of the island of Marajo (q. v.). It is 200 miles in length, is 20 miles broad opposite the city of Para, and is 40 miles broad at its mouth. Its most important affluent, and the source whence it draws, perhaps, the great mass of its volume of waters, is the Tocantins. Formerly, the name Para, which is said to signify 'father of waters,' was applied in a general way to the river Amazon. At the time of the spring-tides, the bore rushes up the river with enormous force, forming a wave 15 feet high.

PARA', a coin of copper, silver, or mixed metal, though most generally of copper, in use in Turkey and Egypt; it is the 40th part of a piastre, is divided into 3 aspers, and varies much in value, owing to the debased and complicated condition of the Turkish coinage. Pieces of 5 paras are also in use. The para is equal to about  $\frac{1}{10}$ th of a penny sterling in Turkey, and  $\frac{1}{15}$ th of a penny sterling in Egypt. See PIASTRE.

PARA GRASS. See PIASSABA.

PARABLE (Gr. *parabolé*, a comparison) was originally the name given by the Greek rhetoricians to an illustration avowedly introduced as such. In Hellenistic and New Testament Greek, it came to signify an independent fictitious narrative, employed for the illustration of a moral rule or principle. This kind of illustration is of Eastern origin, and admirable examples are to be found in the Old and New Testaments, particularly in the discourses of our Lord. It is no less interesting than curious to learn that many of Christ's parables, or at least much of his parabolic imagery, are to be found in the writings of Hillel, Shammai, and other great rabbis, as, for example, the parables of the Pearl of Great Price, the Labourers, the Lost Piece of Money, the Wise and Foolish Virgins, &c. Among modern writers, the German divine Krummacher (q. v.) has greatly distinguished himself in this species of composition. The parable differs from the Fable (q. v.) in the probability or verisimilitude of the story itself, and agrees with it in the essential requisites of simplicity and brevity. In the course of time, the word parable came to lose its significance of figurative speech, and to mean speech generally. From the *parabola* of the Latin Vulgate, came the medieval Latin *parabolare*, whence the modern French *parler* and *parole*. An excellent work on the parables of the New Testament—probably the best in the English language—is that by Archbishop Trench.

PARABOLA, one of the conic sections, is produced by a plane not passing through the vertex, which cuts the cone in a direction parallel to that of a plane touching the convex surface of the cone. A little consideration will shew that

PARABOLANI—PARACELSUS.

a section so produced cannot be a closed curve, but its two branches, though continually widening out from each other, do not diverge so rapidly as in the Hyperbola (q. v.). The nearer the cutting plane is to that which touches the cone, the less do the two branches diverge; and when the two planes coincide, the branches also coincide, forming a straight line, which is therefore the limit of the parabola. It may otherwise be considered as a curve, every point of which is equally distant from a fixed straight line and a given point; the fixed straight line is called the *directrix*, and the given point the *focus*. Thus (see fig.) PAP' is a parabola,

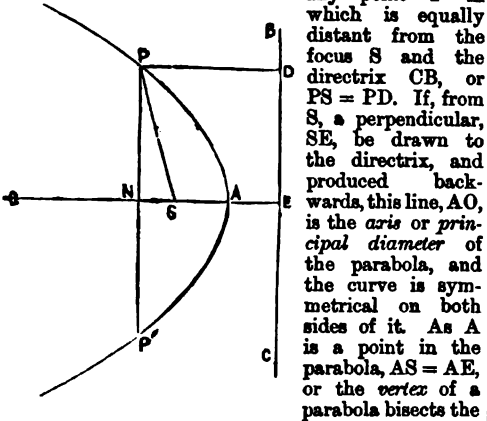

any point P in which is equally distant from the focus S and the directrix CB, or PS = PD. If, from S, a perpendicular, SE, be drawn to the directrix, and produced backwards, this line, AO, is the *axis* or *principal diameter* of the parabola, and the curve is symmetrical on both sides of it. As A is a point in the parabola, AS = AE, or the *vertex* of a parabola bisects the perpendicular from the focus to the directrix. All lines in a parabola which are parallel to the axis cut the curve in only one point, and are called *diameters*. All lines, such as PP', which cut the curve in two points, are ordinates, and the diameter to which they are ordinates, is that one which bisects them; the portion of this diameter which is intercepted between the ordinate and the curve, is the corresponding *abscissa*. From the property of the parabola that PS = PD, the equation to the curve may be at once deduced; for PS = PD = EN, therefore PS<sup>2</sup> (which = PN<sup>2</sup> + NS<sup>2</sup>) = EN<sup>2</sup>; hence PN<sup>2</sup> = EN<sup>2</sup> - NS<sup>2</sup> = (ES + SN)<sup>2</sup> - NS<sup>2</sup> = ES<sup>2</sup> + 2ES . SN = (since ES = 2AS) 4AS<sup>2</sup> + 4AS . SN = 4AS (AS + SN) = 4AS . AN; and calling PN, the semiordinate, y; AN, the abscissa, x; and AS, a; the equation to the parabola becomes y<sup>2</sup> = 4ax, where a (the distance of the vertex from the focus) remains the same for all points in the same curve. It is evident from the equation, as well as from the geometrical derivation of the parabola, that it must have two, and only two branches, and that the further it is extended the nearer its branches approach to the condition of straight lines parallel to the axis, though they never actually become so. The parabola has no asymptotes, like the hyperbola, but it possesses many properties which are common to it with that curve and the ellipse. In fact, the parabola is nothing more than an ellipse, whose major axis is infinitely long.

If parallel rays of light or heat fall upon the concave surface of a paraboloidal (see PARABOLOID) mirror, they are reflected to the focus, and conversely, if a light be placed in the focus of a paraboloidal reflector, its rays will be reflected in parallel directions, and would appear equally bright at all distances did light move without deviation, and unabsorbed. Also, if a body be projected in a direction not vertical, but inclined to the direction of gravity, it would, if undisturbed by the resisting force of the atmosphere describe accurately a

parabola whose axis is vertical, and whose vertex is the highest point reached by the body (see PROJECTILES).

The term parabola is used in analysis in a general sense, to denote that class of curves in which some power of the ordinate is proportional to a lower power of the abscissa. Thus, the curve we have just described, and which is distinguished as the *common* or *Apollonian* parabola, has the square of its ordinate proportional to its abscissa; the *cubical* parabola has the cube of its ordinate proportional to its abscissa; and the *semi-cubical* parabola has the cube of its ordinate proportional to the square of its abscissa.

PARABOLA'NI (Gr. *parabolas*, a desperate person), a class of functionaries in the early church, by some writers reckoned as members of the clergy, and included in the ranks of the minor orders, but more probably religious associations, whose duty it was to assist the clergy, especially in the more laborious and the menial offices of religion or of charity. The etymology of the name is somewhat curious, being derived or applied from that of those desperate adventurers of the arena who hired themselves for the wild-beast fights of the amphitheatre. The chief duty of the parabolani was the tending of the sick, whether in ordinary diseases or in times of pestilence. By some, the association is believed to have originated at Alexandria, and perhaps to have been peculiar to that church; but although the parabolani were certainly very numerous at Alexandria, amounting to some 500 or 600, it is beyond all question that they were also enrolled in other churches. We find them at Ephesus, at the time of the council in 449. They held the same place in regard of ministrations to the living, that the *Fossores* of Rome or the *Kopiatai* of the Greeks did in relation to the burial of the dead. The parabolani are made the subject of formal legislation by Theodosius the younger. At first they were subject to the *Præfectus Augustalis*, but a later decree placed them directly under the authority of the bishop.

The name parabolani must not be confounded with the epithet *parabolarius*, which the pagans applied to the Christian martyrs, from the recklessness with which they gave their lives for their faith.

PARABOLOID, a solid figure traced out by a Parabola (q. v.) revolving round its principal axis. Sections of this solid parallel to the principal axis are parabolas, and those perpendicular to it, circles. The term 'paraboloidal,' for which 'parabolic' is frequently but improperly substituted, is applied either to bodies having the form of a paraboloid, or to concave surfaces which seem to have taken their peculiar hollow shape from the impress of a paraboloidal body.

PARACEL'SUS. About the end of the 15th c. there lived in the small town of Marien-Einsiedeln, near Zurich in Switzerland, William Bombast von Hohenheim, a physician and chemist; he was married to the lady-superintendent of the hospital attached to the convent of Einsiedeln; they had an only son, Philip Aureolus Theophrastus, born, it is thought, about 1493. The name Paracelsus, by which he is now known, is a rude rendering into Greek and Latin of his patronymic. It seems doubtful if he ever attended any regular school, but he received from his father the rudiments of Latin, and whatever else he could teach. He soon took to roaming, and even pursued his travels into Asia and Africa. How he maintained himself during his pilgrimage is unknown; probably by necromancy and quack cures—that is, proclaiming he had certain specifics, and bargaining for the amount he was to

receive if he performed a cure. He was a diligent chemist, investigating the processes of the preparation of metals, and making experiments as to their medicinal virtues; also to discover the philosopher's stone. As a chemist he lived with Sigismund Fugger, one of a family celebrated for its patronage of art and science. His cures, real or pretended, became noised abroad, and he was called to prescribe for all the great men of his day. When he was thirty-three, he boasted of having cured thirteen princes, whose cases had been declared hopeless. He was then at his zenith, and at the recommendation of Ecolampadius was appointed professor of physic and surgery at Basel. He commenced his academic career by publicly burning Galen's works, exclaiming Galen did not know as much as *his* shoe-latchet. 'Reading never made a physician,' he said; 'countries are the leaves of nature's code of laws—patients his only books.' His class-room at first was full to overflowing, but was soon deserted, and he fell into habits of excessive intemperance; indeed his secretary asserts he was drunk every day; never undressed, and went to bed with his famous sword by his side, which he would draw, and flourish about the room. The reason of his departure from Basel was, that a certain dignitary, suffering from gout, in his agony sent for Paracelsus, and promised to give him 100 florins if he cured him. Paracelsus gave him three *laudanum* pills; the canon felt comfortable, and the doctor claimed his fee, but the churchman refused to pay. Paracelsus took him into court, but the judge decided against the professor, who lost his temper, and abused the legal functionary in such a manner that the matter was taken up by the town council, and ended in the expulsion of Paracelsus. He recommenced his wanderings. Wherever he went he excited the regular faculty to a state of violent hatred, not wholly undeserved. At Salzburg he had given offence in the usual way, and the result was, 'he was pitched out of the window at an inn by the doctor's servants, and had his neck broken by the fall.' This took place in 1541.

That a man whose life was such an incoherent medley should exert an influence for centuries after his death, may well be a matter of surprise, but he and the age were fitted for each other. He struck the weak point of the prevailing system of medicine; he appealed to the public as to whether it were not a false system that could only lead to failure, and he proposed a system of his own, which, though shrouded in absurdity and obscurity, inaugurated a new era of medicine. The prominent idea of his system is, that disease does not depend upon an excess or deficiency of bile, phlegm, or blood, but that it is an actual existence, a blight upon the body subject to its own laws, and to be opposed by some specific medicine. See the works of Paracelsus; also of Schulz (1831); Lessing (1839); Rademacher (1848); and Russell (*History and Heroes of Medicine*, 1861).

PARACHUTE (Fr. *chute*, a fall), a machine invented for the purpose of retarding the velocity of descent of any body through the air, and employed by aeronauts as a means of descending from balloons. It is a gigantic umbrella, strongly made, and having the outer extremities of the rods, on which the canvas is stretched, firmly connected by ropes or stays to the lower part of the handle. The handle of the parachute is a hollow iron tube, through which passes a rope connecting the balloon above with the car (in which are the aeronauts and their apparatus) beneath, but so fastened, that when the balloon is cut loose, the car and parachute still remain connected. When the balloon ascends, the parachute collapses like an umbrella; but when the balloon

rope is severed, and the car begins to descend, the parachute is extended by the action of the air, and prevents the car from acquiring a dangerous velocity of descent; the final velocity in those cases where the machine is of a size proportioned to the weight it has to support, being no more than would be acquired by a person leaping from a height of between two and three feet. But the slightest derangement of the parachute's equilibrium, such as might be caused by a breath of wind, or the smallest deviation from perfect symmetry in the parachute itself, immediately produces an oscillatory motion of the car, having the apex of the parachute as a centre, and the oscillations becoming gradually greater and more rapid, the occupants of the car are in most cases either pitched out, or are along with it dashed on the ground with frightful force. This defect in the parachute has been attempted to be remedied in various ways, but hitherto without success. The first successful experiment with the parachute was made by Blanchard at Strasburg in 1787, and the experiment has been often repeated by Garnerin and others; very frequently, however, with fatal results.

The parachute was employed by Captain Boxer, R.N., as an essential part of his patent light-ball, for discovering the movements of an enemy at night, and was so arranged as to open up when the lighted ball had attained its greatest elevation, so as to keep it for a considerable period almost suspended in the air.

PARADE (from *parare*) signified in its original sense a prepared ground, and was applied to the courtyard of a castle, or to any enclosed and level plain. From the practice of reviewing troops at such a spot, the review itself has acquired the name of parade. In its modern military acceptation, a *parade* is the turning out of the garrison, or of a regiment in full equipment, for inspection or evolutions before some superior officer. It is the boast of British troops that their line and discipline are as perfect under an enemy's fire as on the parade ground.

PARADISE. See EDEN.

PARADISE, FIRD OF. See BIRD OF PARADISE.

PARADOS—another name for Traverse—is an intercepting mound, erected in various parts of a fortification for the purpose of protecting the defenders from a rear or ricochet-fire. See FORTIFICATION.

PARADOX (Gr. *para*, beside, or beyond, and *doxa*, an opinion), a term applied to whatever is contrary to the received belief. Cicero, in his book on paradoxes, states that the Stoics called by this name all those unusual opinions which contradict the notions of the vulgar. It follows from this that a paradox is not necessarily an opinion contrary to truth. There have been bold and happy paradoxes whose fortune it has been to overthrow accredited errors, and in the course of time to become universally accepted as truths. It is, perhaps, even one of the prerogatives of genius to bring such into the world, and thereby to alter the character of an art, a science, or a legislation; but this, the highest form of paradox, which is only another name for originality of thought, or for novelty of scientific discovery, is rare. The paradox which springs from a passion for distinction, and which, in its efforts to achieve it, despises good sense and the lessons of experience, is far more frequent. It may not be at bottom a positive error in thought, but it is so exaggerated in expression, that if taken literally it actually does mislead. This is the besetting sin of the brilliant and epigrammatic class of writers,

abundant examples of which are to be found in modern French literature.

PARAFFIN is the name given to several closely-allied substances, which are composed of mixtures of polymeric hydrocarbons, of the olefinic series (that is to say, of the formula  $C_nH_{2n}$ ), and are obtained from the dry distillation of wood, peat, bituminous coal, wax, &c. P. is particularly abundant in beech tar, but according to Reichenbach, to whom its name (which is formed from *parum affinis*, 'little allied,' in consequence of its resisting the action of the strongest acids and alkalis) is due, and who may be regarded as its discoverer; it is also found in the tar of both animal and vegetable substances. At ordinary temperatures paraffin is a hard, white, crystalline substance, devoid of taste or odour, and resembling spermaceti, both to the touch and in appearance. The paraffin obtained from wood fuses at about  $111^\circ$ , but the varieties obtained from other substances have considerably higher boiling-points. When carefully heated, it sublimes unchanged at a little below  $700^\circ$ . It dissolves freely in hot olive oil, in oil of turpentine, in benzol, and in ether, but it is only slightly soluble in boiling alcohol, and is quite insoluble in water. It does not burn readily in the air, unless with the addition of a wick, when it evolves so brilliant and smokeless a flame that it has been applied to the manufacture of candles, which rival those made of the finest wax. The main supply of the paraffin of commerce is obtained in this country from the Boghead cannel-coal. See NAPHTHA. A bituminous shale near Bonn supplies much of the continental demand.

PARAFFIN OIL is the term applied to the oily matter which is given off in large quantity in the distillation of Boghead cannel-coal. By rectification it may be separated into three portions, one of which remains liquid at very low temperatures, boils at about  $420^\circ$ , and is much used under a variety of names for illuminating purposes, while a mixture of the two less volatile portions (which may be regarded as composed of paraffin dissolved in a mixture of hydrocarbons of nearly the same composition as paraffin) is largely employed for the purpose of lubricating machinery, for which it is admirably adapted by its power of resisting the oxidising action of the atmosphere, and by its very slow evaporation. See NAPHTHA.

PARAGUAY', an independent republic of South America. As represented in most maps, it is confined to the peninsula, between the rivers Paraguay and Parana, as far north as about the parallel of  $21^\circ 30'$ ; but by recent treaties with neighbouring states, it now embraces an extensive region called the Chaco, west of the Paraguay, and as far south as the river Vermejo, and west as the meridian of  $61^\circ 20'$ , and a tract lying between the Parana and the Uruguay. The whole area, according to official statistics is, in round numbers, 348,000 square miles, of which 131,000 square miles are comprised between the rivers Paraguay and Parana, 196,000 square miles are on the west of the Paraguay, and upwards of 21,000 square miles are between the Parana and Uruguay. The peninsula between the rivers is still the important part of Paraguay. A mountain-chain called Sierra Anambahy, which traverses it in the general direction of from north to south, and bifurcates to the east and west towards the southern extremity, under the name of Sierra Maracaju, divides the tributaries of the Parana from those of the Paraguay, none of which are very considerable, although they are liable to frequent and destructive overflows. As regards its physical character, the northern portion of the country is mountainous, and in part, especially towards the east,

occupied by native tribes, and little known. The southern portion is one of the most fertile districts of South America, consisting of hills and gentle slopingly wooded, of wide savannas, which afford excellent pasture-ground, and of rich alluvial plains, some of which, indeed, are marshy, or covered with shallow pools of water (only one lake, that of Ypao, deserving special notice), but a large proportion are of extraordinary fertility and highly cultivated. The banks of the rivers Parana and Paraguay are occasionally belted with forest; but, in general, the low lands are destitute of trees. The climate, for a tropical country, is temperate, the temperature occasionally rising to  $100^\circ$  in summer, but in winter being usually about  $45^\circ$ . In geological structure, the southern part belongs generally to the tertiary formation; the north and east presenting greywacke rocks in some districts. The natural productions are very varied, although they do not include the precious metals or other minerals common in South America. Much valuable timber is found in the forests, and the wooded districts situated upon the rivers possess a ready means of transport. Among the trees are several species of dye-wood, several trees which yield valuable juices, as the India-rubber and its cognate trees; and an especially valuable shrub, called the *Matis* (q. v.), or Paraguay tea-tree, which forms one of the chief articles of commerce, being in general use throughout La Plata, Chili, Peru, and other parts of South America. The tree grows wild in the north-eastern districts, and the gathering of its leaves gives employment in the season to a large number of the native population. Many trees also yield valuable gums. Wax and honey are collected in abundance, as is also cochineal, and the medicinal plants are very numerous. The chief cultivated crops are maize, rice, coffee, cocoa, indigo, manioc, tobacco, sugar-cane, and cotton. One-half of the land is national property, consisting partly of the lands formerly held by the Jesuit missions, or by other religious corporations, partly of lands never assigned to individuals, partly of lands confiscated in the course of the revolutionary ordeal through which the country has been passing. The national estates have, for the most part, been let out in small tenements, at moderate rents, the condition of the tenure being that they shall be properly cultivated. Under the dictator Francia, agriculture made considerable progress, but nevertheless it is still far from the standard of European progress. Only about 30,000 square miles of the whole territory is in cultivation. The breed of cattle and of horses also has been much improved, and the stock increased, as well in the public farm establishments instituted by the dictator as in those of private individuals. There are few manufactures—sugar, rum, cotton, and woollen cloths and leather being the only industrial productions. Indeed the commerce of the country is chiefly in the hands of the government, which holds a monopoly of the export of P. tea, and in great part of the timber trade. In 1859 the imports amounted to £36,800, and the exports to £32,000. In the same year 412 vessels, of 16,650 tons, entered and cleared at the river-ports. The population in 1857 amounted to 1,337,431, consisting of whites of Spanish descent, native Indians, negroes, and a mixture of these several races. The established religion is the Roman Catholic, the ecclesiastical head of which is the Bishop of Asuncion. Education is very widely diffused; and it is said that there are but few of the people who are not able to read and write.

The history of P. is highly interesting. It was discovered by Sebastian Cabot in 1526, but the first colony was settled in 1533 by Pedro de Mendoza, who



PARAGUAY—PARALLAX.

founded the city of Assuncion, and established P. as a province of the viceroyalty of Peru. The warlike native tribe of the Guaranis, however, a people who possessed a certain degree of civilisation, and professed a dualistic religion, long successfully resisted the Spanish arms, and refused to receive either the religion or the social usages of the invaders. In the latter half of the 16th c., the Jesuit missionaries were sent to the aid of the first preachers of Christianity in P.; but for a long time they were almost entirely unsuccessful, the effect of their preaching being in a great degree marred by the profligate and cruel conduct of the Spanish adventurers, who formed the staple of the early colonial population. In the 17th c. the home government consented to place in their hands the entire administration, civil as well as religious, of the province; which, from its not possessing any of the precious metals, was of little value as a source of revenue; and in order to guard the natives against the evil influences of the bad example of European Christians, gave to the Jesuits the right to exclude all other Europeans from the colony. From this time forward the progress of civilisation as well as of Christianity was rapid. The legislation, the administration, and the social organisation of the settlement were shaped according to the model of a primitive Christian community, or rather of many communities under one administration; and the accounts which have been preserved of its condition, appear to present a realisation of the ideal of a Christian Utopia. On the expulsion of the Jesuits from P. in 1763, the history of which is involved in much controversy, the province was again made subject to the Spanish viceroyalty. For a time the fruits of the older civilisation maintained themselves; but as the ancient organisation fell to the ground, much of the work of so many years was undone; the communities lapsed into disorganisation, and by degrees much of the old barbarism returned. In 1776, P. was transferred to the newly-formed viceroyalty of Rio de La Plata; and in 1810 it joined with the other states in declaring its independence of the mother kingdom of Spain, which, owing to its isolated position, it was the earliest of them all to establish completely. In 1814, Dr Francia (q. v.), originally a lawyer, and the secretary of the first revolutionary junta, was proclaimed dictator for three years; and in 1817, his term of the office was made perpetual. He continued to hold it till his death in 1840; and although many of his measures tended to improve the condition of the country, and to develop its internal resources, yet his rule was arbitrary and despotic in the highest degree; and his attempt to isolate the territory from commercial intercourse with the rest of the world, was attended with a complete stagnation of commerce and the enterprise to which it leads. On his death, the government was vested in consuls, and in 1844 a new constitution was proclaimed, the head of which is a president, Don Carlos Antonio Lopez, elected in that year for ten years, re-elected in 1854 for three years, and again in 1857 for seven years further. Under Lopez, the restrictions on foreign commerce have been gradually removed, and in 1852 commercial treaties were signed with the Argentine Republic, and with the United States, Great Britain, France, and Sardinia.

The republic is divided into 25 departments. The central department, in which the capital, Assuncion, is situated, contained, in 1857, 398,628, or nearly one-third of the whole inhabitants; and the capital itself, 48,000. The inhabitants of the towns consist chiefly of whites, or of half-breeds (*mestizos*), who closely resemble whites; the language commonly

spoken being Spanish. The native population of the provinces are chiefly Guaranis, among whom are scattered some remnants of other tribes, almost all, however, now speaking the Guaraní language.

**PARAGUAY**, an important river of South America, an affluent of the Parana (q. v.), rises in the Brazilian province of Mato Grosso, on a plateau of red sandstone, in lat. 13° 30' S., long. about 55° 50' W., 9535 feet above sea-level. The sources of the river are a number of deep lakes, and eight miles from its source, the stream already has considerable volume. Pursuing a south-west course, and after flowing through a level country covered with thick forests, the P. is joined from the west by the Jauru, in lat. 16° 30' S. It then continues to flow south through the Marsh of Karayea, which, during the season when the stream rises, is an expansive waste of waters, stretching far on each side of the stream, and extending from north to south over about 200 miles. The river still pursues a circuitous but generally southward course, forming from 20° to 22° S. the boundary-line between Brazil and Bolivia, thence flowing south-south-west through the territories of Paraguay to its junction with the Parana, in lat. 27° 17' S., a few miles above the town of Corrientes. Its chief affluents are the Cuyaba, Tacoary, Mondego, and Apa on the left, and the Jauru, Pilcomayo, and Vermejo on the right. Except in the marshy districts, the country on both banks of the river is rich and fertile, and abounds in excellent timber. The entire length of the river is estimated at 1800 miles; it is on an average about half a mile in width, and is navigable for steamers to the mouth of the Cuyaba, 100 miles above the town of Corumba. The waters of the P., which are quite free from obstructions, were declared open to all nations in 1852; and since 1858 the great water system, of which this river forms such an important part, is regularly traversed by steamers which ply between Buenos Ayres on the Rio de la Plata, and Cuyaba, on the river of the same name, one of the head waters of the Paraguay.

**PARAGUAY TEA.** See *MATRÉ*.

**PARAHÍBA**, one of the most eastern maritime provinces of Brazil, bounded on the N. by Rio Grande do Norte, on the S. by Pernambuco, on the W. by Ceara, and on the E. by the Atlantic. Area, 21,700 square miles; pop. 209,300. It is traversed by a river of the same name, by a number of smaller streams, and by mountainous ridges, between which are valleys, the soils of which are, for the most part, dry and sandy. Cotton of excellent quality, mandioc, and tobacco are grown; and cotton, sugar, and timber are exported. Capital, Parahiba (q. v.).

**PARAHIBA**, a seaport of Brazil, capital of the province, and situated on the river of the same name, about 10 miles from the sea. Besides the cathedral, it contains a number of religious houses, two colleges, and other educational institutions. In 1859—1860, 152 vessels of 51,363 tons entered and cleared the port. Pop. 10,000.

**PARALLAX** is the apparent displacement of an object caused by a change of place in the observer. When an object at M is looked at from P, it



Fig. 1.

appears in line with some object, S; but after the observer has moved to E, M has apparently retro-

## PARALLAX—PARALLEL FORCES.

graded to a position in line with  $S'$ ; this apparent retrogression is denominated *parallax*. The angle  $PME$  is called the 'angle of parallax,' or the 'parallactic angle,' and is the measure of the amount of parallax. To astronomers, the determination of the parallax of the heavenly bodies is of the utmost importance, for two reasons—first, from the necessity of referring all observations to the earth's centre, i. e., so modifying them as to make it appear as if they had been actually made at the earth's centre; and secondly, because parallax is our only means of determining the magnitude and distance of the heavenly bodies. The *geocentric* or *daily* parallax—as the apparent displacement of a heavenly body, due to its being observed from a point on the surface of the earth instead of from its centre, is called—is determined as follows: Let  $P$  and  $P'$  be two stations on the surface of the earth (fig. 2),  $E$  its

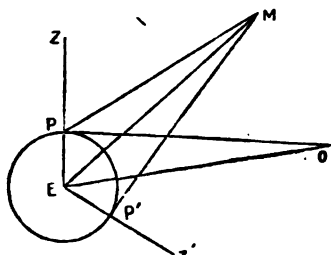

Fig. 2.

centre,  $M$  the object to be observed, and  $Z$  and  $Z'$  the zeniths respectively of the observers at  $P$  and  $P'$  (points which, if possible, should be on the same meridian exactly); then at  $P$  and  $P'$  let the *zenith distances*,  $ZPM$  and  $Z'PM$ , be observed simultaneously, and since the latitudes of  $P$  and  $P'$ , and consequently their difference of latitude, or the angle  $PEP'$ , is known, from these three the angle  $PMP'$  (the sum of the parallaxes at  $P$  and  $P'$ ) is at once found; and then, by a trigonometrical process, the separate angles or parallaxes  $PME$  and  $P'ME$ . When the parallax of  $M$ , as observed from  $P$ , is known, its distance from  $E$ , the centre of the earth, can be at once found. When the heavenly body is on the horizon, as at  $O$ , its parallax is at a maximum, and is known as the *horizontal* parallax. The geocentric parallax is of use only in determining the distances of those heavenly bodies at which the earth's radius subtends a considerable angle; and as the moon and Mars (when in opposition) are the only such bodies, the parallax of the other celestial bodies must be determined in a different manner. The parallax of the sun is found by observation of the *Transit* (q. v.) of Venus across his disk, a much more accurate method than that above described. The parallaxes of the other planets are easily determined from that of Mars.

In the case of the fixed stars, at which the earth's radius subtends an infinitesimal angle, it becomes necessary to make use of a much larger base-line than the earth's radius, and as the largest we can employ is the radius of the earth's orbit, it accordingly is made use of, and the displacement of a star, when observed from a point in the earth's orbit instead of from its centre, the sun, is called the *annual* or *heliocentric* parallax. Here the base-line instead, as in the former case, of being 4000 miles, is about 92,000,000 miles, and the two observations necessary to determine the parallactic angle are made from two points on opposite sides of the earth's orbit, at an interval as nearly as possible of half a year. Yet, notwithstanding the

enormous length of the base-line, it bears so small a proportion to the distances of the stars, that only in three or four cases have they been found to exhibit any parallactic motion whatever, and in no case does the angle of parallax amount to  $1''$  (see STARS). The geocentric horizontal parallax of the moon is about  $57' 4'' 2$ ; that of the sun, about  $8'' 6$ ; and of the double star, 61 *Cygni*, the heliocentric parallax has been determined by Bessel to be  $348''$ , equivalent to about 15 millionths of a second of geocentric horizontal parallax. Parallax affects every observation of angular measurement in the heavens, and all observations must be corrected for parallax, or, in astronomical phrase, referred to the earth's centre before they can be made use of in calculation. The position of a body, when noted from the surface of the earth, is called its *apparent* position; and when referred to the centre, its *real* position.

**PARALLEL FORCES** are those forces which act upon a body in directions parallel to each other. Every body, being an assemblage of separate particles, each of which is acted on by gravity, may thus be considered as impressed upon by a system of parallel forces. The following demonstration will exhibit the mode in which the amount and position of the resultant force are found: Let  $P$  and  $Q$  be two parallel forces acting at the points  $A$  and  $B$  respectively, either in the same (fig. 1) or in opposite (fig. 2) directions; join  $AB$ , and in this line, at the points  $A$  and  $B$ , apply the equal and opposite forces  $S$  and  $S$ , which counterbalance each other, and therefore do not affect the system. Find  $M$  and  $N$  (see COMPOSITION AND RESOLUTION OF FORCES), the resultants of  $P$  and  $S$ , and  $Q$  and  $S$  respectively, and produce their directions till they meet in  $D$ , at which point let the resultants be resolved parallel to their original directions; then there are two equal forces,  $S$  and  $S$ , acting parallel to  $AB$ , but in opposite directions, and thus, as they counterbalance each other, they may be removed. There then remain two forces,  $P$  and  $Q$ , acting at  $D$ , in the line  $DC$ , parallel to their original directions, and their sum (fig. 1) or difference (fig. 2), represented by  $R$ , is accordingly the resultant of the

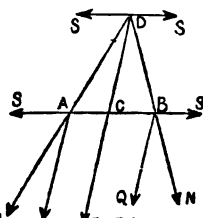

Fig. 1.

original forces at  $A$  and  $B$ . To find the position of  $C$ , the point in  $AB$ , or  $AB$  produced, through which the resultant passes, it is necessary to make use of the well-known property denominated the *Triangle of Forces* (q. v.), according to which the three forces  $S$ ,  $M$ , and  $P$  are proportional to the lengths of  $AC$ ,  $AD$ ,  $DC$ , the sides of the triangle  $ADC$ ; then  $S : P :: AC : DC$ , similarly  $Q : S :: DC : CB$ , therefore  $Q : P :: AC : BC$ ,

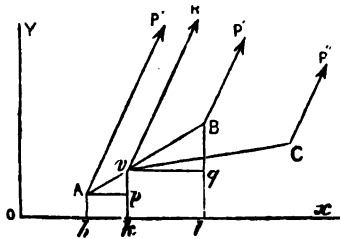

Fig. 2.

original forces at  $A$  and  $B$ . To find the position of  $C$ , the point in  $AB$ , or  $AB$  produced, through which the resultant passes, it is necessary to make use of the well-known property denominated the *Triangle of Forces* (q. v.), according to which the three forces  $S$ ,  $M$ , and  $P$  are proportional to the lengths of  $AC$ ,  $AD$ ,  $DC$ , the sides of the triangle  $ADC$ ; then  $S : P :: AC : DC$ , similarly  $Q : S :: DC : CB$ , therefore  $Q : P :: AC : BC$ ,

## PARALLELEPIPED—PARALYSIS.

and  $Q \perp P$  or  $R : P :: AC \pm BC$  or  $AB : BC$ , from which proportions we derive the principle of the lever,  $P \times AC = Q \times BC$ , and also that  $R \times BC = P \times AB$ , whence  $BC = \frac{P}{R} \times AB$ , and the point  $O$  is found. The failing case of this proposition is when  $P$  and  $Q$  acting in opposite parallel directions at different points are equal, in which case the resultant  $R = Q - P = Q - Q = 0$ . In all other cases there is a progressive motion, such as would be caused by the action of a single force  $R (= Q \pm P)$  acting at the point  $C$  in the direction  $CR$ ; but in the failing case, since  $R = 0$ , there is no progressive motion, but a rotatory movement

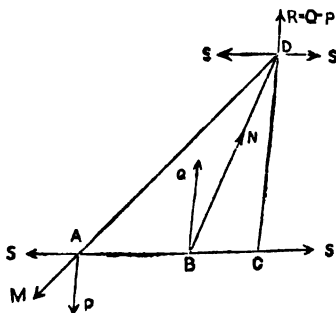

Fig. 3.

round the centre of  $AB$ . See **COUPLE**. It is of no consequence whether  $A$  and  $B$  be the true points of application of the forces  $P$  and  $Q$ , provided their directions when produced pass through these points, and the point of application of the resultant need not be in the line joining the points of application of the component forces, but its direction must when produced pass through  $C$ . If there be more than two parallel forces, the resultant of the whole is found by compounding the resultant of the first two with the third in the way given above, thus obtaining a new resultant, which is similarly combined with the fourth force; and so on till the final resultant is found. The centre of gravity is only a special name for the point of application of the final resultant of a number of parallel forces.

**PARALLELEPIPED** (Gr.), frequently, but improperly written *Paralleloiped*, is a solid figure having six faces, the faces being invariably parallelograms, and any two opposite faces equal, similar, and parallel. If the faces are all squares, and consequently equal, the parallelepiped becomes a cube. The volume of a parallelepiped is found by multiplying the area of one face by its distance from the opposite one.

**PARALLELOGRAM**, in Mathematics, is a quadrilateral rectilinear figure which has its opposite sides parallel; the opposite sides are therefore equal, and so are the opposite angles. If one angle of a parallelogram be a right angle, all its angles are right angles, and the figure is then called a *rectangular parallelogram*, or shortly, a *rectangle*; and if at the same time all the sides are equal, the figure is a *square*, otherwise it is an *oblong*. If the angles are not right angles, but all the sides are equal, it is called a *rhombus*; and if the opposite sides only are equal, a *rhomboid*. The two lines which connect the opposite corners of a parallelogram are called its *diagonals*, each bisects the parallelogram, and they bisect each other; the sum of their squares also is equal to the sum of the squares of the sides of the parallelogram.

All parallelograms which have equal bases and equal altitudes are equal in area, whether they be similar in shape or not, and the area of a parallelogram is found by multiplying its base by the height.

### PARALLELOGRAM OF FORCES. See COMPOSITION OF FORCES.

**PARALLELS**, in Military language, are trenches cut in the ground before a fortress, roughly parallel to its defences, for the purpose of giving cover to the besiegers from the guns of the place. The parallels are usually three, with zigzag trenches leading from one to another. The old rule used to be to dig the first at 600 yards distance, but the improvements in artillery have rendered a greater distance necessary; and at Sebastopol, the allies made their first trench 2000 yards from the walls. The third trench is very near to the besieged works, and from it saws and zigzag approaches are directed to the covert-way.—The bearing of parallels in the general conduct of a **SIEGE** will be found described under that head.

**PARALLELS** or **CIRCLES OF LATITUDE** are circles drawn round the surface of the earth parallel to the equator. They may be supposed to be the intersections with the earth's surface of planes which cut the earth at right angles to its axis. The greatest of these circles is the equator, which has the centre of the earth for its centre, the radius for its radius, and is equally distant at all points from each pole. It is evident that of the others, those next the equator are greater than those more remote, and that they become less and less till at the poles they vanish altogether. The radius of any one circle is evidently equal to the earth's radius multiplied into the cosine of its latitude or distance from the equator. The rotary velocity of the earth's surface, which is about  $17\frac{1}{2}$  miles per minute at the equator, is only  $8\frac{1}{2}$  miles in lat.  $60^\circ$ , in lat.  $82\frac{1}{2}^\circ$  (the most northerly point yet reached) is only  $2\frac{1}{2}$  miles; and in lat.  $89\frac{1}{2}^\circ$  (within 35 miles of the pole) is not more than  $2\frac{1}{2}$  yards per minute.

The most important parallels of latitude are the *Tropics of Cancer* ( $23^\circ 28'$  N. lat.) and *Capricorn* ( $23^\circ 28'$  S. lat.), and the *Arctic* ( $66^\circ 32'$  N. lat.) and *Antarctic Circles* ( $66^\circ 32'$  S. lat.).

**PARALYSIS** (Gr., a loosing or relaxing), or **PALSY**, is a loss, more or less complete, of the power of motion; but by some writers the term is employed to express also loss of sensation. When the upper and lower extremities on both sides, and more or less of the trunk, are involved, the affection is termed *General Paralysis*. Very frequently only one-half of the body laterally is affected, the other side remaining sound; to this condition the term *Hemiplegia* is given. When the palsy is confined to all the parts below an imaginary transverse line drawn through the body, or to the two lower extremities, the condition is termed *Paraplegia*. When one part of the body, as a limb, one side of the face, &c., is exclusively attacked, the affection is known as *local palsy*. In some cases the loss of sensation and the power of motion in the paralysed part is entire, while in others it is not so. In the former the paralysis is said to be *complete*, in the latter, *partial*. In most cases, but not invariably, sensibility and motion are simultaneously lost or impaired. When motion is lost, but sensation remains unimpaired, the affection has received the name of *akinesia* (Gr. *a*, not, and *kinēsis*, motion). More rarely, there is a loss of sensibility while the power of motion is retained; and to such cases the term *anaesthesia* (Gr. *a*, not, and *aisthēsis*, sensation) is applied. This affection occurs most

## PARALYSIS.

frequently in the organs of sense; as in the tongue, for example, in which the sense of taste may be lost, without any defect of movement.

Paralysis is in most cases a mere symptom of disease existing in some other part than that apparently affected; as, for example, in the brain or spinal cord, or in the conducting nerves between either of these organs and the palsied organ. Sometimes, however, it is a purely local affection, depending upon a morbid condition of the terminal extremities of the nerves. The varieties in the condition of the brain and spinal cord which occasion paralysis are somewhat numerous; as, for example, congestion, hemorrhagic and serous effusion, softening, fatty degeneration, fibrinous exudation, suppuration, hydatids, various morbid growths, depressed bone from external violence, &c. It is highly probable, also, that palsy may sometimes result from mere functional disorder of the nervous centres—a view which is confirmed by the fact that a *post mortem* examination of a patient who has suffered from this affection sometimes fails to detect any apparent lesion. Paralysis may originate in a nervous trunk, if it is compressed by a tumour, or otherwise mechanically affected, or if it is the seat of morbid action tending in any way to disorganise it; or it may be due to an abnormal condition of the terminations of the nerves, which may be rendered unfit for receiving impressions either from the external world or from the brain by prolonged disuse, by continuous or severe pressure, by exposure to cold, by disorganisation of their own tissue, or by the depressing action of various metallic poisons, especially lead.

We shall briefly notice the symptoms and causes of the most important forms of paralysis, before offering any remarks on the general principles of treatment. *Hemiplegia* (Gr. *hemi*, half, *plēssō*, I strike) affects one lateral half of the body, and is that form of palsy to which the term *paralytic stroke* is commonly applied. The parts generally affected are the upper and lower extremities, the muscles of mastication, and the muscles of the tongue on one side. In a well-marked case the patient when seized falls to the ground, all power of motion in the affected arm and leg being lost. The palsy of the face which accompanies hemiplegia is usually quite distinct from the affection known as *facial palsy*, which is an affection of the facial nerve or *portio dura*. See NERVOUS SYSTEM. It is the motor branches of the fifth or trifacial nerve going to the muscles of mastication which are generally involved in hemiplegia, and consequently the cheek is flaccid and hangs down, and the angle of the mouth is depressed on the affected side. The tongue when protruded points towards the paralysed side, and there is often imperfect articulation, in consequence of the lesion commonly affecting the hypoglossal nerve. Hemiplegia may arise from lesions of various kinds, as, for example, (1) from hemorrhage, or some other morbid change in the brain, in which case the palsy is on the side of the body opposite to the lesion, in consequence of the decussation or crossing over of nervous fibres from one side to the other that occurs at the upper part of the Spinal Cord (q. v.); (2) from spinal disease below the point of decussation just noticed; in this case the palsy, and the lesion causing it, are on the same side of the body. It is also sometimes associated with hysteria, epilepsy, and chorea, but in these cases it usually disappears in a few hours.

*Paraplegia* (Gr.) is usually confined to the two lower extremities, but the muscles of the lower part of the trunk and of the bladder and rectum are sometimes affected. There are at least two distinct

forms of paraplegia, viz. (1) Paraplegia dependent on primary disease of the spinal cord or its membranes and especially on Myelitis (q. v.); and (2) Reflex Paraplegia, i. e., paraplegia consequent on disease of the kidneys, bladder, urethra, prostate, womb, &c. These two forms of paraplegia differ in many of their phenomena, and the most important of these points of difference have been arranged in a tabular form by Dr Brown Sequard in his *Lectures on Paralysis of the Lower Extremities*, to which we must refer for the best information on this form of palsy. Paraplegia usually comes on slowly, with a gradual increase of its symptoms. The reflex form is, of course, by far the most favourable, as it usually abates spontaneously on the subsidence of the primary disease.

*Facial Palsy*, although locally affecting only a small part of the body, is a disorder of sufficient importance to require a definite notice. In this affection there is a more or less perfect loss of power over all the muscles supplied by the *portio dura*, or facial nerve. The following graphic account of the appearance of the patient is condensed from Dr Watson's *Lectures on the Practice of Physic*. From one-half of the countenance all power of expression is gone; the features are blank, still, and unmeaning; the eyelids apart and motionless. The other half retains its natural cast, except that, in some cases, the angle of the mouth on that side seems drawn a little awry, in consequence of the want of counterpoise from the corresponding muscular fibres of the palsied side. The patient cannot laugh or weep, or frown, or express any feeling or emotion with one side of his face, while the features of the other may be in full play, nor can he spit or whistle properly. One-half of the aspect, with its unwinking eye, its fixed and solemn stare, might be that of a dead person; the other half is alive and merry. To those who do not comprehend the possible extent of the misfortune, the whimsical appearance of the patient is a matter of mirth and laughter; while, on the other hand, his friends imagine that he has had a stroke, and that he is in a very dangerous state. The nerve may be unable to discharge its duties in consequence of disease within the cavity of the skull, and in that case there is very serious danger; but in the great majority of cases the nervous function is interrupted in that part of the *portio dura* which lies encased in the temporal bone, or in the more exposed part which issues in front of the ear; and hence this form of palsy is generally unattended with any danger to life. It may arise from various causes. Sometimes it is the consequence of mechanical violence, sometimes of tumours pressing on it in the region of the parotid gland, and it very frequently arises from the mere exposure of the side of the face for some time to a stream of cold air.

It yet remains to notice certain kinds of paralysis which differ either in their characters, or in their causes, from those which have been already described—viz., *Shaking Palsy*, or *Paralysis Agitans*; and the palsies induced by various poisons. *Shaking Palsy* has been defined as 'involuntary tremulous motion, with lessened muscular power in parts not in action, and even when supported; with a propensity to bend the trunk forwards, and to pass from a walking to a running pace; the senses and intellect being uninjured.' It is chiefly an affection of old age, and often goes no further than to cause an unceasing nodding and wagging of the head in all directions. Somewhat analogous to this form of palsy is that peculiar kind of trembling which is often noticed in persons who are much exposed to the vapour of mercury; *Mercurial Tremor*, as it is termed by the

physicians, and *The Trembles*, as the patient usually calls it. It consists in a convulsive agitation of the voluntary muscles, especially when an attempt is made to cause them to act under the influence of the will; a patient with this affection walks with uncertain steps, his limbs trembling and dancing as if they had been hung upon wires. When sitting down he exhibits little or no indication of his disease, but on rising he cannot hold his legs steady, nor direct them with precision; and in severe cases he falls to the ground if not supported. The arms are similarly agitated, and the tongue is usually so tremulous as to render the articulation hurried and unnatural. The disease is especially common in artisans employed in the gilding of metals, and particularly of silver, by means of heat; it is also frequent among the workers of quicksilver mines, in which the crude metal is purified by heat. The time required for the production of the disease varies extremely in different cases (according to Dr Watson, from two years to five-and-twenty). The duration of the complaint is considerable; it may last two or three months, or longer, but it is seldom fatal.

The palsy arising from the absorption of lead has been already noticed in the article LEAD-POISONING.

A specific form of paralysis of the lower extremities, consequent on the use of flour from the beans of the *Lathyrus sativus*, is common in certain parts of India and in Thibet. The ripe bean is an ordinary article of food when made into flour, but it is generally used with wheat or barley flour; it is only when it exceeds one-twelfth part that it is at all injurious, and when it exceeds one-third that the paralysis sets in. Other species of *Lathyrus* have been known occasionally to induce similar symptoms in European countries.

We shall enter into no details regarding the treatment of hemiplegia and paraplegia, as the management of these serious affections should be exclusively restricted to the physician. When a patient has an attack of hemiplegia (or a *paralytic stroke*) all that should be done before the physician arrives is to place him in a horizontal position, with the head slightly raised, and to remove any impediments presented by the dress to the free circulation of the blood. Should the physician not arrive in an hour or two, it may be expedient to give the patient a sharp purge (half a scruple of calomel, followed in a few hours by a black draught, if he can swallow; and two drops of croton oil, mixed with a little melted butter, and placed on the back of his tongue, if the power of deglutition is lost), and without waiting for its action, to administer an injection (or clyster) consisting of half an ounce of oil of turpentine suspended (by rubbing it with the yolk of an egg) in half a pint of thin gruel; and cold lotions may be applied to the head, especially if its surface be hot. The question of blood-letting—the universal treatment a quarter of a century ago—must be left solely to the physician. It should, however, be generally known, that if the patient be cold and collapsed; if the heart's action be feeble and intermittent; if there be an anæmic state; if the patient be of advanced age; if there is evidence of extensive disease of the heart or arterial system; or lastly, if there is reason, from the symptoms, to believe that a large amount of hemorrhage has already taken place in the brain; these singly, and *a fortiori* conjointly, are reasons why blood should not be abstracted.

Facial palsy, unless the seat of the disease be within the cavity of the cranium, will usually yield in the course of a few weeks to cupping and blistering behind the ear of the affected side, purgatives, and small doses of corrosive sublimate

(one-twelfth of a grain three times a day, combined with a little of the compound tincture of bark), which must be stopped as soon as the gums are at all affected. Exposure to cold air must be carefully avoided during treatment.

Little or nothing can be done to cure *Paralysis Agitans*. In the treatment of *Mercurial Tremor*, the first step is to remove the patient from the further operation of the poison, while the second is to remove the poison already absorbed into the system, which is effected by the administration of iodide of potassium. This salt combines with the metallic poison in the system, and forms a soluble salt (a double iodide of mercury and potassium), which is eliminated through the kidneys. Good food and tonics (steel or quinia, or the two combined) should be at the same time freely given.

The writer of this article has no personal knowledge of the treatment that should be recommended in the paralysis produced by the use of *Lathyrus sativus*, but cases are reported which seem to have been benefited by good diet, tonics, strychnia, and the application of blisters to the loins.

PARAMARIBO, the capital of Dutch Guiana, is situated on the western bank of the river Surinam, about 10 miles from its mouth, in 5° 45' N. lat., and 55° 15' W. long. It forms a rectangle of nearly a mile and a half in length by three-quarters in breadth. The streets are broad, covered with shell-sand, and planted on both sides with orange, lemon, tamarind, and other trees. Near the river, the houses, which are chiefly of wood, stand somewhat closely together, but in the remoter parts each is surrounded by its own garden. The rooms are wainscoted with the choicest woods, and elegantly furnished.

In approaching P. from the sea, Fort Zeelandia is first reached; then the Bureau of Finance and Court of Justice on the Government Plain, which is surrounded by stately cabbage-palms; the governor's house, with shady double avenue of tamarind-trees; and lastly, the business streets stretching along the river side. There are a Dutch Reformed, a Lutheran, Moravian, two Roman Catholic churches, and two synagogues. Fort Zeelandia has a large and beautiful barrack, with several roomy houses for the officers. P. has a neat, pleasant, and picturesque appearance, the white painted houses, with bright-green doors and windows, peeping out from the shady trees, and the river being thronged with the tent-boats and canoes which are constantly arriving and departing.

On 1st January 1861, the population amounted to 17,830, of whom 5073 were slaves. The 27 schools were attended by 1020 boys and 843 girls. By royal decree of 6th February 1851, the flogging of slaves in the Netherlands West Indies was forbidden, except through officers appointed for the purpose, and the number of lashes was limited. This check, however, was frequently evaded, and the greatest barbarities practised, so that the feeling in favour of emancipation increased in the Netherlands, and a bill was passed, 8th August 1862, for emancipating the slaves on the 1st July 1863.

P. being the only port, except Nickerie Point, at the mouth of the Corentyn, enjoys a considerable export and import trade. In 1860 the total arrivals in Dutch Guiana were 219 ships, of which 50 were Netherlands, 31 United States, and 138 of other nations; the outward bound numbered 217. About a fourth part of the shipping cleared at Nickerie, which is the most productive portion of the colony; one estate, the Nursery, producing (in 1860) sugar, 1,500,000 lbs.; molasses, 75,985 gallons; and rum, 37,000 gallons.

The climate of Dutch Guiana is not particularly

healthy. In 1849, the births by slaves were 2·82 per cent, the deaths 3·49; while in Curaçao, the births amounted to 3·86, the deaths to 2·77 per cent, and at Bonaire, to 3·22 and 1·21 respectively. The statistics for 1860 were more favourable for Surinam, the births among whites being 10 in excess of the deaths, and of the slaves 399. Elephantiasis Arabum and Lepra are fearfully prevalent among the black population of P. and neighbourhood.

The maximum fall of rain is in May, the minimum in September and October. By observations made at five different points, during eight successive years, it was found that the quantity varies much, being smallest at Nickerie, in the west, and largest at Montbyou in the east of the colony. The averages of the eight years, from 1847 to 1854, were, Nickerie, 66·70 inches; Groningen, on the river Saramacca, 90·50; Paramaribo, 99·85; Gelderland, on the river Surinam, 108·25; and Montbyou, 127·75. In Georgetown, British Guiana, the average fall is 100·50 inches.

The coast of Dutch Guiana is an alluvial deposit formed by the rivers and equatorial stream which flows eastwards. Further inland, the soil is diluvial loam, bearing the finest timber trees; and south of this line are extensive savannahs of white sand, stretching towards the hills and mountains of the interior, which are chiefly of gneiss and granite.

In 1860, the letters received from foreign countries amounted to 13,764, the newspapers to 17,250; despatched, 23,144 letters and 5435 newspapers.

PARAMATTA is a light worsted twilled fabric for female dress. It was invented at Bradford, in Yorkshire, and has become an important manufacture of that place. The web consists of combed merino wool, and the warp of cotton. It resembles in texture the Coburg and Orleans cloths.

PARAMATTA, a pleasantly situated town of New South Wales, stands near the west extremity of Port Jackson, on a small river of the same name, and is 15 miles by land west-north-west of Sydney, with which it is connected both by steamer and railway. The houses are mostly detached, and the streets are wide and regular, the principal one being about a mile in length. The institutions comprise churches, schools, an orphan and a lunatic asylum, and a prison. There was formerly an observatory here; but it was removed to Sydney in 1858. 'Colonial tweeds,' 'Paramatta cloths,' and salt are manufactured. Pop. 5577.

The town of P., formerly called Rosehill, is, with the exception of Sydney, the oldest in the colony. The first grain raised in the colony was grown here, and the first grants of land made.

PARAMETER, or LATUS RECTUM, a term used in conic sections, denotes, in the case of the parabola, a third proportional to the abscissæ of any diameter and its corresponding ordinate; in the ellipse and hyperbola, a third proportional to a diameter and its conjugate. The parameter of any diameter is, in the case of the parabola, the same as the double ordinate of that diameter which passes through the focus, and is four times as long as the distance between the diameter's vertex and the directrix. The term parameter was also at one time used to denote any straight line about a curve, upon which its form could be made to depend, or any constant in its equation, the value of which determined the individual curve; but its employment in this sense is now discontinued, except in the theory of homogeneous differential equations, where the constants, for the purpose of aiding the solution, are supposed to vary; and the method is consequently denominated the 'Variation of the Parameters.' In the application of this method to

determine the orbital motions of the planets, the 'seven necessary data' (see ORBIT) were called parameters, but for this the term 'elements' is now substituted.

PARANA, a province in the south of Brazil, is bounded on the N. by the province of São Paulo on the E. by the Atlantic, S.E. by Santa Catharina, S. by Rio Grande do Sul, W. by Uruguay and Paraguay. Area stated at 115,000 square miles. Pop. 72,000, one-sixth of whom are slaves. The capital is Curitiba, and previously to 1852 this province formed a territory called the Comarca of Curitiba, included in the province of São Paulo. It fully commenced its provincial career in 1853. The sea coast is indented by several bays, but the chief and almost the only port as yet is Paranagua. A line of mountains runs parallel to the coast at a distance of about 80 miles inland, and throws out spurs and branches westward. The streams flowing east from this water-shed, though numerous, are inconsiderable; while the rivers flowing westward, into the Parana (q. v.), which forms the western boundary of the province, are all about or upwards of 400 miles in length. The principal are the Paranapanema, Ivay, Piquery, and Yguassu. The climate is unusually healthy; the soil is fertile; and agriculture, rearing cattle and swine, and gathering *mâté* or Paraguay tea are the chief employments.

The port of Paranagua, situated in a picturesque district, on a bay of the same name, is about 400 miles south-west of Rio de Janeiro. The town is clean and pretty, and contains about 3000 inhabitants. *Mâté* to the value of 1,000,000 dollars is exported annually from this town.

PARANA, an important river of Brazil, rises in the province of Minas Geraes, about 100 miles north-west of Rio de Janeiro. It flows west for upwards of 500 miles, through the provinces of Minas Geraes and São Paulo. In the latter it is joined by the Parnahiba, after which its course alters, and it flows south-south-west to Candelaria. Passing this town, it flows west for 200 miles to its confluence with the Paraguay (q. v.), and then bending southward, passes Santa Fe, below which its channel frequently divides and encloses numerous islands. After passing Santa Fe, it rolls onward in a south-east direction, and unites with the Uruguay in forming the Rio de la Plata. Entire length about 2400 miles. It draws a number of considerable tributaries from the province of Parana (q. v.); and of the others, the chief are the Paraguay, Uruguay, Pardo, Tiete, and Parnahiba. For vessels drawing 7½ feet it is navigable to Corrientes, upwards of 600 miles from its mouth.

PARAPET (Ital. *para-petto*, from *parare*, to protect, and *petto*, the breast), a wall raised higher than the gutter of a roof for protection; in



Ornamented Gothic Parapet.

military works, for defence against missiles from without (see FORTIFICATION); in domestic buildings, churches, &c., to prevent accident by falling from the roof. Parapets are of very ancient date. The Israelites were commanded to build 'a battlement' round their flat roofs. In classic architecture, balustrades were used as parapets. In Gothic architecture, parapets of all kinds are used. In

early work they are generally plain, but in later buildings they are pierced and ornamented with tracery, which is frequently of elaborate design, especially in French Flamboyant work. Shields and little arcades are also used as ornaments to parapets; and the battlements of castles are imitated in the parapets of religious and domestic buildings.

**PARAPH** (Gr. *para*, and *hapto*, to touch), an addition to the subscription of a name formed by a flourish of the pen, which, during the middle ages, constituted some sort of provision against forgery. Its use is not altogether extinct in diplomacy, and in Spain the paraph is still a usual part of a signature.

**PARAPHERNALIA** (Gr. *para*, beside, or beyond; *pherné*, dower) is a term borrowed from the Roman law to denote certain articles of personal adornment and apparel belonging to a married woman. According to the usual rule in the law of England, all the personal property of a woman becomes the property of her husband when the marriage takes place, unless there is a marriage settlement; but there is an exception as regards the trinkets and dress of the wife so far as suitable to her rank in life, and which she continues to use during the marriage. In such a case the property in these articles does not vest absolutely in the husband. He cannot bequeath them by his will to a third person, but if he gave them to the wife, he may pawn, or sell, or give them away, and they can be seized in execution to pay his debts, except so far as they constitute necessary clothing. And if he were to die insolvent, they may, except that part which is necessary clothing, be taken by the husband's creditors. If the paraphernalia were given, not by the husband but by a third party before or during marriage, then they are presumed to be given for the wife's separate use, and the husband or his creditors cannot in any way interfere with them. In the law of Scotland, the paraphernalia of a married woman include not merely personal clothing and trinkets, but articles of furniture, such as a chest of drawers. The husband there can neither pawn, nor pledge, nor give away the paraphernalia, nor can his creditors attach them either during his life or after his death.

**PARAPHRASE** (Gr. *para*, beside, and *phrazein*, to speak) is the name given to a verbal expansion of the meaning either of a whole book, or of a separate passage in it. A paraphrase consequently differs from Metaphrase, or strictly literal translation, in this, that it aims to make the sense of the text clearer by a lucid circumlocution, without actually passing into commentary. The versified passages of Scripture, forming part of the Psalmody of the Scottish Church, are popularly known as 'the Paraphrases.'

**PARAPLEGIA.** See PARALYSIS.

**PARÁS'ARA** is the name of several celebrated personages of ancient India, met with in the *Mahábhárata* (q. v.), the *Puránas* (q. v.), and other works. Of one personage of this name, the *Mahábhárata* relates that he was the son of S'akti, who was the son of the patriarch Vasiht'ha. King Kalmáshapáda once meeting with S'akti in a narrow path in a thicket, desired him to stand out of the way. The sage refused; on which the Rája beat him with his whip, and S'akti cursed him to become a Rákshasa, or demon. The Rája, in this transformation, killed and ate S'akti, together with the other sons of Vasiht'ha. S'akti, however, had left his wife, Adris'yanti, pregnant, and she gave birth to Parás'ara, who was brought up by his grandfather. When he grew up, and was informed of his father's

death, he instituted a sacrifice for the destruction of all the Rákshasas, but was dissuaded from its completion by Vasiht'ha and other sages. The same legend is referred to by the *Vishn'u-Purán'a*, where P. is introduced as relating, himself, part of this story, and adding, that the saint Pulas'tya, one of the mind-born sons of Brahmá, in reward of the clemency he had shewn even towards such beings as the Rákshasas, bestowed on him the boon of becoming the author of a compendium, or rather the compiler, of the *Purán'as*, and of the *Vishn'u-Purán'a* in particular. 'This tradition,' Professor Wilson observes (*Vishn'u-Purán'a*, ed. Hall, vol. i. p. 10), 'is incompatible with the general attribution of all the *Purán'as* to Vyása;' but it may perhaps point to a later recension when, to the native mind, Vyása would still remain the reputed author of the older *Purán'as*, although, of course, even this assumption has little claim to historical truth.—A P., probably different from the one named, is the author of a celebrated code of laws; he is mentioned by Yájnavalkya in his standard work, and often quoted by the commentaries.—A probably third P. is the reputed author of a *Tantra* (q. v.); and a fourth, the author of an astronomical work.—Parás'aras (in the plural) designates the whole family to which the different Parás'aras belong.

**PARASITE** (Gr. from *para*, beside; *sitos*, food; one who eats with another; hence one who eats at the expense of another), a common character in the Greek comedies; a low fellow, who is ready to submit to any indignity, that he may be permitted to partake of a banquet, and who lives as much as possible at the expense of others.

**PARASITIC ANIMALS** are numerous. Some of them are Entozoa, and some are Epizoa. See these heads. They belong to different classes, and even to different divisions of the animal kingdom; all, however, are invertebrate. Many are of the division *Articulata*, and many of the division *Radiata*. Besides worms of various kinds, there are among parasites not a few crustaceans, as the Lernæans, &c., and not a few insects, as the Louse. These insects constitute the order *Parasita* or *Anoplura*. The characters of the order are noticed in the article LOUSE. It remains, however, to be added, that the order is divided into two sections—in the first of which, *Pediculidea*, the mouth is small and quite suctorial; whilst in the second, *Nirmidea*, it is furnished with mandibles and hooked maxilla. The species of the first section are found only on man and mammals; those of the second section, almost exclusively on birds, although one infests the dog. The *Nirmidea* shew much greater activity than the *Pediculidea*. When a bird dies, the bird-lice congregate near the beak, and seem disquieted, apparently anxious to change their abode. Some of the cirrhopods which live in the skin of large marine animals, as whales, can scarcely be regarded as parasitic animals, but rather bear to them a relation such as *Epiphytes* do to parasitical plants, not deriving their food from the animal on which they live. Tape-worms, ascarides, and other intestinal worms, do not directly draw sustenance from the animal in which they live, by extracting its juices, but they live at its expense, by consuming its food, after the food has undergone, in great part, the process of digestion.

**PARASITIC DISEASES** constitute one of the recognised orders of disease in Dr Farr's classification. See NODOLOGY. In these diseases, certain morbid conditions are induced by the presence of animals or vegetables which have found a place of subsistence within some tissue or organ, or upon some surface of the body of man or of other animals.

PARASITIC DISEASES—PARASITIC PLANTS.

Even plants are not exempt from disorders of this nature (see PARASITIC PLANTS). The forms of animal life giving rise to parasitic diseases are described in the articles ASCARIDES, CESTOIDEA, ENTOZOA, EPIZOA, GUINEA-WORM, INCH-INSECT, LOUSE, NEMATHELMIA, STRONGYLUS, TAPEWORMS, TRICHINA, &c. With the vegetable structures which give rise to special diseases we are less accurately acquainted, in consequence of the limited knowledge of cryptogamic botany possessed by many writers who have recorded their experience of these cases. These parasites are either *fungi* or *algæ*, and are composed of simple sporules, germs, or cells, or of cells arranged in rows or groups, which are so minute as to require the microscope for their recognition. Fungi are the most numerous of all plants in regard to genera and species, and their growth is associated with serious injury both to animal and vegetable life. It is not, however, always easy to determine whether they are the direct cause of disease, or whether the diseased tissue has merely afforded a suitable nidus for their development. 'It is certain,' says Dr Aitken, who has entered more fully into this subject than any other English writer on the practice of medicine, 'that wherever the normal chemical processes of nutrition are impaired, and the incessant changes between solids and fluids slacken, then, if the part can furnish a proper soil, the cryptogamic parasites will appear. The soil they select is, for the most part, composed of epithelium or cuticle, acid mucus or exudation. Acidity, however, though favourable to their growth, is not indispensable, since some of the vegetable parasites grow upon alkaline or neutral ground, as on ulcerations of the trachea, or in fluid in the ventricles of the brain. Certain atmospheric conditions seem favourable to the occurrence of these vegetable parasites. For example, *Tinea tonsurans* may be quite absent for years in places such as workhouses, where it commonly exists, and then for several months every second or third child in the place gets the disease.'

There is undoubted evidence from the observations and experiments of Devergie, Von Bärensprung, and others, that these parasitic diseases may be transmitted by contagion from horses, oxen, and other animals to man; while conversely, Dr Fox mentions an instance of a white cat which contracted the mange from *Tinea tonsurans* (ringworm of the scalp), which affected the children of the family to which it belonged—the fungus of the mange in the cat being the same fungus as that of *Tinea* in the human subject, viz. the *Tricophyton* (*Gr. tric* (tric-), of a hair, and *phyton*, a plant).

The principal vegetable parasites associated in man with special morbid states are arranged by Aitken (*The Science and Practice of Medicine*, 1863, 2d edit. vol. ii. p. 177) as follows: 1. The *Tricophyton tonsurans*, which is present in the three varieties of *Tinea tonsdens*—viz., *T. circinatus* (ringworm of the body), *T. tonsurans* (ringworm of the scalp), and *T. sycosis menti* (ringworm of the beard). 2. The *Tricophyton sporuloides*, which, together with the above, is present in the disease known as *Plica Polonica*. 3. The *Achorion Schönleini* and *Puccinia Javi*, which are present in *T. favosa*, known also as *Favus* (q. v.), and *Porrigio scutulata* (the honeycomb ringworm). 4. The *Microsporon mentagrophyta*, which is present in *Mentagra*. 5. The *Microsporon furfur*, which occurs in *Pityriasis versicolor*. 6. The *Microsporon Audouini*, which is present in *Porrigio decalvans*. 7. The *Mycetoma* or *Chionyphe Carteri*, which gives rise to the disease known as the 'fungus foot of India,' &c. 8. The *Oidium albicans* of diphtheria and aphtha. 9. The *Cryptococcus Cerevisia*, or *Yeast Plant*, occurring in the urine and

contents of the stomach, if there is saccharine fermentation. 10. The *Sarcina Goodserii*, or *Merisporidia ventriculi* (of Robin), found in vomited matters and in the urine. There are strong grounds, based partly on botanical and partly on clinical observation, for believing that the various fungi already described are mere varieties of two or more species in various phases of development.

We shall conclude this article with a brief notice of the most dangerous of all the parasitic diseases—the *Fungus Foot* or *Fungous Disease of India*. It occurs in many parts of India, and the north-east shores of the Persian Gulf. It is a disease which occurs among natives only, so far as has been yet observed, and is undoubtedly due to the presence of a fungus which eats its way into the bones of the foot and the lower ends of the tibia and fibula, penetrating by numerous fistulous canals through the tissue of the entire foot, and tending to cause death by exhaustion, unless amputation is performed in due time. Dr Carter has described three forms of this disease, in which both the symptoms and the fungoid material differ considerably from each other. A few remarks on the first of these forms will suffice as an illustration of parasitic disease. In this form, the bones of the foot and the lower ends of the leg-bones are perforated in every direction with roundish cavities, varying in size from that of a pea to that of a pistol-bullet, the cavities being filled with the fungoid matter. The surrounding muscles, and subsequently the tendinous and fatty structures, are converted into a gelatiniform mass, in consequence of which the foot presents a peculiar turgid appearance. The structure of the globular fungoid masses is shewn in the accompanying figure, which was

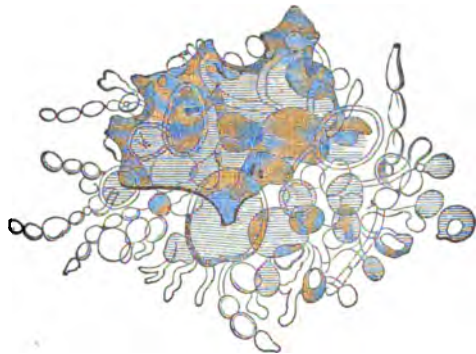

drawn by Dr H. J. Carter from a specimen which he examined immediately after amputation. Examined under the microscope, the fungoid mass is found to consist of short, beaded, tawny threads or filaments, arising from a common centre, and having at their tips large spore-like cells. For further information regarding this remarkable form of disease, the reader is referred to Dr Carter's paper in the fifth volume (new series) of the *Transactions of the Medical and Physical Society of Bombay*, and to the Rev. M. J. Berkeley's account of his examination of the fungus, in the second volume of *The Intellectual Observer*, p. 248.

Further notice of the parasitic diseases of the skin will be found in the articles PITYRIASIS (var. *versicolor*), RINGWORM, SCALD-HEAD, &c.

PARASITIC PLANTS are plants which grow on other plants, and derive subsistence from their juices; the plants which live parasitically on animal tissues being generally called Entophytes (q. v.), although the distinction between these terms is not always preserved. Epiphytes (q. v.) differ



PARASOL—PARCHMENT.

from parasitical plants in not subsisting on the juices of the plant which supports them, but merely on decayed portions of its bark, &c., or drawing all their nourishment from the air. Parasitical plants are numerous and very various; the greater number, however, and the most important, being small fungi, as Rust, Brand, Bunt, Smut, &c., the minute spores of which are supposed, in some cases, to circulate through the juices of the plants which they attack. Concerning some minute fungi, as the Mildews, it is doubted if they are truly parasitical, or if their attacks are not always preceded by some measure of decay. But among parasitic plants are not a few phanerogamous plants, some of which have green leaves; and some are even shrubby, as the Mistletoe, Loranthus, &c.; whilst the greater number have brown scales instead of leaves, as Dodder, Broom-rape, Lathræa, &c., and the whole of that remarkable order or class of plants called *Rhizanthæa* or *Rhizogens*, of which the genus *Rafflesia* is distinguished above all other plants for the magnitude of its flowers. Some parasitic plants, as the species of Dodder, begin their existence by independent growth from the ground; but when they have found suitable plants to take hold of and prey on, the connection with the ground ceases. Not a few, as Broom-rape and Lathræa, are root-parasites, attaching themselves only to the roots of other plants, generally of trees or shrubs; whilst there are some, as the Eyebright (*Euphrasia officinalis*), Yellow Rattle (*Rhinanthus crista galli*), Cow-wheat (*Melampyrum arvense*), &c., which are parasitical only occasionally and partially, preying on the roots of other herbaceous plants in their vicinity. These last are chiefly common on neglected grass lands, and are generally to be regarded as injurious weeds. Root-parasites generally attach themselves by means of little tubercles, which gradually bury themselves under the bark.

**PARASOL** (from the Ital. *parare*, to parry or keep off, and *sole*, the sun), a small umbrella used by ladies to shade themselves from the sun.

**PARBUCKLE** is a mode of drawing up or lowering down an inclined plane any cylindrical object, as a barrel or a heavy gun, without the aid of a crane or tackle. It consists in passing a stout rope round a post or some suitable object at the top of the incline, and then doubling the ends under

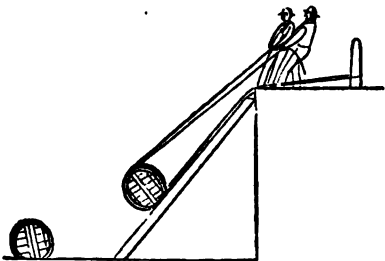

Parbuckle.

and over the object to be moved. This converts the cask or gun into a pulley in its own behalf, and limits the pressure at each end of the rope to one-fourth the weight of the object moved, as felt on the incline. By hauling in the ends equally, the cask ascends, or *vice versa*.

**PARCÆ** (from the root *para*, a part), the name given by the Romans to the goddesses of Fate or Destiny, who assigned to every one his 'part' or lot. The Greek name, *Moiræ*, has the same meaning (from *meros*, a share). They are only once

mentioned by Homer, who in every other instance speaks of Fate (*Moiræ*) in the singular, and whose Fate was not a deity but a mere personification, the destinies of men being made by him to depend upon the will of the gods; whilst, according to the later Greeks and the Romans, the gods themselves were subject to the control of the P. or *Moiræ*. Hesiod, however, who is almost contemporary with Homer, speaks of three Fates, whom he calls daughters of Night—*Clotho*, the spinner of the thread of life; *Lachesis*, who determines the lot of life; and *Atropos*, the inevitable. They were usually represented as young women of serious aspect; *Clotho* with a spindle, *Lachesis* pointing with a staff to the horoscope of man on a globe, and *Atropos* with a pair of scales, or sun-dial, or an instrument to cut the thread of life. In the oldest representations of them, however, they appear as matrons, with staffs or sceptres. They had places consecrated to them throughout all Greece, at Corinth, Sparta, Thebes, Olympia, &c.

**PARCELS**, in the law of England, is the technical word describing the piece of land or premises included in a conveyance.

**PARCENER**. See **COPARCENER**.

**PARCHIM**, a town of the grand-duchy of Mecklenburg-Schwerin, stands on the Elde, which is here divided into two arms, 23 miles south-east of Schwerin. It is very old, is irregularly built, surrounded by beautiful gardens, and has a gymnasium and two churches. Pop. 6672, who are employed in agriculture, in the manufacture of tobacco, cloth, leather, and brandy, and in weaving.

**PARCHMENT**, one of the oldest inventions of writing materials, was known at least as early as 500 years B.C. Herodotus speaks of books written upon skins in his time. Pliny, without good grounds, places the invention as late as 196 B.C., stating that it was made at Pergamos (hence the name *Pergamena*, corrupted into Eng. parchment) in the reign of Eumenius II., in consequence of Ptolemy of Egypt having prohibited the exportation of papyrus. Possibly the Pergamian invention was an improvement in the preparation of skins which had certainly been used centuries before. The manufacture rose to great importance in Rome about a century B.C., and soon became the chief material for writing on; and its use spread all over Europe, and retained its pre-eminence until the invention of paper from rags, which from its great durability proved a fortunate circumstance for literature.

There are several kinds of parchment, prepared from the skins of different animals, according to their intended uses. The ordinary writing parchment is made from those of the sheep and of the she-goat; the finer kind, known as *vellum*, is made from those of very young calves, kids, and lambs; the thick common kinds, for drums, tambourines, battle-dores, &c., from those of old he-goats and she-goats, and in Northern Europe from wolves; and a peculiar kind is made from asses skins, the surface of which is enamelled. It is used for tableta, as blacklead writing can be readily removed from it by moisture. The method of making parchment is at first the same as in dressing skins for leather. The skins are limed in the lime-pit until the hair is easily removed. They are then stretched tightly and equally, and the flesh side is dressed as in currying, until a perfectly smooth surface is obtained. It is next ground by rubbing over it a flat piece of pumice-stone, previously dressing the 2<sup>d</sup>h side only with powdered chalk, and slaked lime sprinkled over it. It is next allowed to dry, still tightly stretched on the frame. The drying process is an

important one, and must be rather slowly carried on, for which purpose it must be in the shade. Sometimes these operations have to be repeated several times, in order to insure an excellent quality, and much depends upon the skill with which the pumice-stone is used, and also upon the fineness of the pumice itself. When quite dried, the lime and chalk are removed by rubbing with a soft lamb-skin with the wool on.

**PARCHMENT, VEGETABLE.** This remarkable substance was made known by Mr. W. E. Gaine in 1854, and again by the Rev. J. Barlow in 1857. It resembles animal parchment so closely, that it is not easy to distinguish the difference. It is made from the water-leaf, or unized paper, by immersing it only for a few seconds in a bath of oil of vitriol, diluted with one-half its volume of water. The exactness of this dilution is of the greatest importance to the success of the results. The dilute acid must not be used immediately after mixing, but must be suffered to cool to the ordinary temperature; without attention to these apparently trifling points, the operator will not succeed.

The alteration which takes place in the paper is of a very remarkable kind. No chemical change is effected, nor is the weight increased, but it appears that a molecular change takes place, and the material is placed in a transition state between the cellulose of woody fibre and dextrin.

Vegetable parchment has become a regular article of trade, and legal and other documents are engrossed upon it. In some respects it is preferable to the old kind, for insects attack it less. It is admirably adapted for engineers' plans, as it can be made so thin as to be used for tracing paper, and it will bear exposure to wet without injury. Messrs De la Rue are entitled to the credit of giving practical effect to the invention.

**PARÉ, AMBROISE**, a renowned French surgeon, and the father of modern surgery, was born about the beginning of the 16th c., at Laval, department of Mayenne, France. His father, who was a trunk-maker, was unable to afford him a literary education, and apprenticed him to a barber and surgeon. P., after a brief term of service, acquired such a fondness for surgery and anatomy, that, abandoning his master, he went to Paris to prosecute his studies. His means for doing so were very limited; he could afford to obtain instruction from only the more obscure teachers; few books were within his reach, yet by dint of perseverance and the exercise of a rare discrimination, combined with the valuable practice in the Hôtel de Dieu of Paris, he laid a solid foundation for future eminence. In 1536, P. was received as a master barber-surgeon, and joined in this capacity the army of Marshal René de Monte-Jean, which was on the point of starting for Italy. During this campaign he improved the mode of treatment of gun-shot wounds, which had up to this time been of the most barbarous kind—namely, cauterisation with boiling oil. His reputation as well as his skill were greatly heightened during this campaign, and as he himself says: 'If four persons were seriously wounded I had always to attend three of them; and if it were a case of broken arm or leg, fractured skull, or fracture with dislocation, I was invariably summoned.' In 1539, he returned to Paris, whither his high renown had preceded him, and was received with distinction by the Royal College of Chirurgery, of which he was subsequently appointed president. On the war being renewed, he was again attached to the army, under the Vicomte de Rohan, afterwards under Antoine de Bourbon, Duke of Vendôme. It was during this

campaign that he cured François, the second Duke of Guise, of the wound which conferred upon him the sobriquet of *Balafré*, and that he substituted ligature of the arteries for cauterisation with a red-hot iron after amputation. The idea of this mode of repressing hemorrhage had long been in existence, but he was the first to shew that it could safely be applied to practice. Many other important improvements in surgery were introduced by him at this time. In September 1552 he was appointed surgeon to King Henry II., and in the following year was taken prisoner at Hesdin; he was however released, in consideration of his having cured Colonel de Vaudeville, after rejecting the brilliant offers made him by the Duke of Savoy to remain in his service. Returning to Paris, honours were showered upon him; and though he was ignorant of Latin, the *conditio sine quâ non* of a liberal education at that time, no hesitation was shewn in conferring upon him learned titles and degrees. He attended Francis II. on his death-bed, and continued to hold the office of king's surgeon to his successors, Charles IX. and Henry III. The former of these monarchs, whose life had been gravely threatened by an injury inflicted by his physician Portail, and who had been preserved by P., testified for him the greatest esteem, and saved him during the massacre of St Bartholomew by locking him up in his own chamber. During the latter part of P.'s life, he was much employed in the publication of his various writings, and suffered considerable annoyance from the envious spirit displayed towards him by his professional brethren, who showered obloquy upon him for having, as they said, 'dishonoured science by writing in the vulgar tongue.' P. died at Paris, December 22, 1590. His writings have exercised a great influence on the practice of surgery in all countries to which they have penetrated, and are held of the highest authority on the subject of gun-shot wounds. The first complete edition of them appeared at Lyon in 1562, and the last, edited by M. Malgaigne, at Paris (1840—1841, 3 vols.). Besides these are 8 Latin editions, and more than 15 translations into English, Dutch, German, &c. As an instance of his great popularity in the army, it may be mentioned that the soldiers of the garrison of Metz, of their own accord, gave him a triumphal reception on his entering that town.

**PAREGORIC, or PAREGORIC ELIXIR** (from the Gr. *paregoricos*, soothing), the *Compound Tincture of Camphor* of the London, and the *Camphorated Tincture of Opium* of the British Pharmacopœia, consists of an alcoholic solution of opium, benzoic acid, camphor, and oil of anise, every fluid ounce containing two grains each of opium and benzoic acid, and a grain and a half of camphor. This preparation is much used both by the profession and the public. In doses of from one to three drachms, it is an excellent remedy for the chronic winter-cough of old people, the opium diminishing the bronchial secretion and the sensibility of the pulmonary mucous membrane, while the benzoic acid and oil of anise act as stimulating expectorants. It has also been found useful in chronic rheumatism.

**PAREIRA-BRAVA.** See CISSAMPELOS.

**PARELLA** (Fr. *parelle* or *perelle*), a name often given to some of those crustaceous lichens which are used to produce Archil, Cudbear, and Litmus; but which more strictly belongs to one species, *Lecanora parella*, resembling the Cudbear Lichen, but with somewhat plaited warty crust, and shields (*apothecia*) having a concave disk of the same colour as the thick tumid even border. Like the Cudbear

Lichen—to which it is far superior in the quality of the dye-stuff obtained from it—it grows on rocks in mountainous districts both in Britain and on the continent of Europe, being particularly abundant in Auvergne and other parts of France.

**PARENCHYMA.** See **CELLULAR TISSUE.**

**PARENT AND CHILD.** The legal relation between parent and child is one of the incidents or consequences of the relation of husband and wife, and flows out of the contract of marriage. The legal is to be distinguished from the natural relation, for two persons may be by the law of nature parent and child, while they are not legally or legitimately so. Hence a radical distinction exists between natural or illegitimate and legitimate children, and their legal rights as against their parents respectively are very different. Legitimate children are the children of two parents who are recognised as married according to the laws of the country in which they are domiciled at the time of the birth; and according to the law of England, if a child is illegitimate at the time of the birth, nothing that can happen afterwards will ever make it legitimate, the maxim being 'once illegitimate always illegitimate'—a maxim which, as will be stated, has some exceptions in Scotland. In treating of the laws affecting the mutual relation of parent and child, the laws of England and Ireland, which differ from the law of Scotland in material respects, will first be stated.

1. *As to Legitimate Children.*—These laws relate first to the liability of the parent to maintain the child, and the rights of the child in the event of the parent's death. As regards the maintenance of the child, it is somewhat singular that, according to the law of England, there is no duty whatever on the parent to support the child, and consequently no mode of enforcing such maintenance. The law of nature was probably considered sufficient to supply the motives which urge a parent to support the child, but the municipal law of England has not made this duty compulsory. This defect was to some extent remedied when what is called the Poor-Law was created by statute in the reign of Elizabeth, by which law parents and children are compellable to a certain small extent, but only when having the pecuniary means to do so, to support each other, or rather to help the parish authorities to do so. But apart from the Poor-Law statutes, there is no legal obligation on the parent to support the child, nor on the child to support the parent. Hence it follows, that if the child is found in a destitute state, and is taken up, fed, clothed, and saved from starvation by a stranger, such stranger cannot sue the parent for the expense, or any part of it, however necessary to the child's existence. In order to make the father liable for maintenance, there must in all cases be made out against him some contract, express or implied, by which he undertook to pay for such expense; in other words, the mere relationship between the parent and child is not of itself a ground of liability. But when the child is living in the father's house, it is always held by a jury or court that slight evidence is sufficient of, at least, an implied promise by the father to pay for such expenses. As, for example, if the child orders clothes or provisions, and the father sees these in use or in process of consumption, it will be taken that he assented to and adopted the contract, and so will be bound to pay for them. So if a parent put a child to a boarding-school, very slight evidence of a contract will be held sufficient to fix him with liability. Nevertheless, in strictness of law, it is as necessary to prove a contract or agreement on the part of the parent to pay for these expenses as it is

to fix him with liability in respect of any other matter. When it is said that a parent is not compellable by the common law to maintain his child, it must, at the same time, be observed that if a child is put under the care and dominion of an adult person, and the latter wilfully neglect or refuse to feed or maintain such child, whereby the child dies or is injured, such adult will incur the penalties of misdemeanour; but this offence does not result from the relationship of parent and child, and may arise between an adult and child in any circumstances, as where a child is an apprentice or servant. The change as to the liability of parents to maintain their children created by the Poor-Laws amounts merely to this, that if a person is chargeable to the parish, which means that such person is utterly destitute, and if the overseers or guardians are bound to support him or her, then the parish authorities may reimburse themselves this outlay, or part of it, by obtaining from justices of the peace an order commanding the parent or child of such pauper to pay a certain sum per week towards the relief. This is, however, only competent when the relative is able to pay such sum, and in all cases the sum is of necessity very small. Not only parents, but grand-parents, are liable under the Poor-Law Act to the extent mentioned. Another provision in the Poor-Law and other kindred acts is, that if a parent runs away and deserts his children, leaving them destitute and a burden on the parish, the overseers are entitled to seize and sell his goods, if any, for the benefit and maintenance of such children; and if the parent, so deserting the children, is able by work or other means to support them, such parent may be committed to prison as a rogue and vagabond. Not only, therefore, is a parent during life not bound to maintain his or her child (with the above exceptions), but also after the parent's death the executors or other representatives of the parent, though in possession of funds, are not bound. It is true that if the parent die intestate, both the real and personal property will go to the children; but the parent is entitled, if he choose, to disinherit the children, and give away all his property to strangers, provided he execute his will in due form, which he may competently do on death-bed if in possession of his faculties.

Another important point of law, affecting the mutual relation of parent and child, is the right of the parent to the custody of the child. At common law it is the father who has the right to the custody of the child until majority at least, as against third parties, and no court will deprive him of such custody except on strong grounds. Whenever the child is entitled to property, the Court of Chancery so far controls his parental right, that if the father is shewn to act with cruelty, or to be guilty of immorality, a guardian will be appointed. A court of common law also has often to decide in cases of children brought before it by *habeas corpus*, when parties have had the custody against the father's will. In such cases, if the child is under fourteen, called the age of nurture, and the father is not shewn to be cruel or immoral, the court will order the child to be delivered up to him; but if the child is above fourteen, or, as some say, above sixteen, the court will allow the child to choose where to go. So the father is entitled by his will to appoint a guardian to his children while they are under age. The mother had, at common law, no right as against the father to the custody of the children, however young; but under Talfourd's Act (2 and 3 Vict. 54), she is entitled to the custody of the child while under seven years of age, or rather she is entitled to apply to the Court of Chancery for leave to keep the children while under that age, provided she is

not acting immorally, or is otherwise unobjectionable in point of character. In all such applications the court has a discretion to grant or refuse her the favour, and is guided by information as to the mother's character. In case of divorce or judicial separation, the Court of Divorce has power to direct who is to have the custody of the children.

2. *Illegitimate Children.*—It has been already stated that, at common law, the parent of a legitimate child is not bound to maintain it, and this is equally true of an illegitimate child—i. e., a child born not in wedlock. In strictness of law, an illegitimate child has no father, which means practically that in case of the death of the father without making a will, the law will not treat such child as entitled to the ordinary legal rights of a legitimate child—i. e., to a share of the father's property. The child is not legally related to the father in this sense. With regard to the mother, she also is not bound to maintain her child according to the common law; but the Poor-Law Acts have made an important qualification of her rights and duties. As between the father and mother of the child, the law is this: The father is not bound even by the Poor-Laws to maintain the child, and the parish officers cannot now institute any proceeding whatever against him for this purpose; but the mother can, to a certain extent, enforce against him not the entire maintenance of the child, but a contribution towards such maintenance. It is entirely discretionary on the mother to take any proceeding against the father, but if she chooses she can do so; and the first step is to go before a justice of the peace, and obtain a summons of affiliation. The father is thus cited before the magistrate, and if the mother swears that he is the father of the child, and is corroborated in some material part of this statement by a third party, the magistrate may make an order against the father to pay the expenses of lying-in, and a weekly sum not exceeding half-a-crown till the child attains the age of thirteen. The mother may make this application either a few months before the birth, or within twelve months after the birth; and even after that time, provided she can prove that the putative father paid her some money on account of the child within such twelve months. The putative father, in these cases, is a competent witness on his own behalf. The utmost, therefore, that the father can be made to contribute towards the child's maintenance is only a portion of the whole, the chief burden being thrown on the mother, who is assumed to be the more blameable party. Though she is not bound by the common law to maintain her child, yet the Poor-Laws make her liable to maintain the child till it attains sixteen; and not only is she bound, but any man who marries her is also by statute bound to support all her illegitimate (and also legitimate) children till they attain sixteen. The result is, that illegitimate children under sixteen are better provided for by the present state of the law than legitimate children, inasmuch as the mother is positively bound to support her illegitimate child, though not bound to support her legitimate child. As regards the custody of illegitimate children, the mother is the party exclusively entitled, for the father is not deemed, in point of law, to be related to such child. Yet if the father has, in point of fact, obtained the custody of such child, and the child is taken away by fraud, the courts will restore the child to his custody, so as to put him in the same position as before. Though illegitimate children will not succeed to the father's property in the event of his dying without a will, there is nothing to prevent him making his will in their favour, provided he expressly name and identify

them, and not leave it to them by the description of 'his children,' which in point of law they are not.

*Scotland.*—The law of parent and child in Scotland differs materially from the law of England and Ireland. In Scotland, a child may be born a bastard, and yet if the parents afterwards marry, this will legitimise the child, and give the child the right to succeed to the father's property. A difficulty sometimes arises where, before the father and mother of a bastard marry, the father has had a legitimate family by another woman, in which case it is held that the bastard, though oldest in point of age, does not take precedence of the legitimate children. The law of Scotland also differs from that of England as regards the obligation of parent and child to maintain each other. There is a legal obligation on both parties to maintain each other if able to do so, and either may sue the other for alimony at common law; but this obligation extends only to what may be called subsistence money, and does not vary according to the rank of the party. Thus an earl is bound to pay no more for the alimony of his son than any other father. As regards all maintenance beyond mere subsistence, the law does not materially differ from that of England, and a contract must be proved against the father before he can be held liable to pay. The legal liability as between parent and child is qualified in this way by the common law, that if a person has both a father and a child living and able to support him, then the child is primarily liable, and next the grandchild, after whom comes the father, and next the grandfather. Not only are parent and child liable to support each other while the party supporting is alive, but if he die, his executors are also liable; and this liability is not limited by the age of majority, but continues during the life of the party supported. Such being the common law of Scotland, it was scarcely necessary, as in England, for the Poor-Law to supply any defect; but the Scotch Poor-Law supplements the common law, by imposing a penalty on a father or mother (though not *vice versa*) who neglects to support a child. Another advantage which a Scotch child has over an English child is, that the father cannot disinherit it—at least so far as concerns his movable property; and even in case of heritable property, the rights of the child are so far protected, that unless the father makes away with his heritable property sixty days before his death, or at least when he is in a sound state of health, he cannot do so on his death-bed, and when seized with his last illness, to the prejudice of his heir-at-law. This is called the Law of Death-bed (q. v.); but as regards the father's movable property, he cannot by any will he can make at any time of his life deprive the children of one-third, or, if their mother is dead, of one-half of such property. This is called the children's right to Legitim (q. v.), a right which they can vindicate, whatever may be their age when the father dies. With regard to the custody of children in Scotland, the rule is, that the father is entitled to the custody as between him and the mother; but the Court of Session has power to regulate the custody in case the children are entitled to property, and the father is of an immoral or cruel character; and the court will also interfere to allow to the mother access to the children at certain times and seasons. Another important difference between a Scotch and English child is this, that whereas in England the father or guardian, or the Court of Chancery, has power to control the custody of the person of the child to a certain extent, until the child attains the age of 21, in Scotland such power entirely ceases when the child attains the age of 14 or 12, according as

such child is male or female. At the age of 14, a boy, and at 12, a girl, in Scotland, is entire master or mistress of his or her movements, and can live where he or she pleases, regardless of any parent or court. They can marry at that age at their own uncontrolled discretion, and act in all respects with the same freedom as adults. As regards the disposition of their property there are some restrictions, but as regards the disposal of their persons there are none, after the ages of 14 and 12 respectively.

2. *Illegitimate Children.*—The law of Scotland as to illegitimate children also differs in some respects from that of England. Both the father and mother of a bastard are bound by law to support such child, and the obligation transmits to the personal representatives of the father or mother. Moreover, by the Poor-Law statute both are liable to a penalty for neglecting to support the child. The mother of illegitimate children is entitled to their custody till the age of ten, if daughters, and if sons, till the age of seven; but the limit is not clearly defined. If the father support the child after the above age, he is entitled to the custody. The mother does not apply to a magistrate for a summons of affiliation in order to fix the paternity; but she may bring an action of filiation and aliment, in which the question of paternity is settled. The father may be judicially examined, and is a competent witness; and it is usual for the court to decree an aliment, varying from £4 per annum against labourers, up to £10 against persons in better circumstances. In Scotland, as in England, the father of a bastard child is not deemed related, in point of law, to such child; and if he desires to provide for such child, it must be done by deed or will, in which the child is identified, and not merely described under the general designation of 'child,' which he is not.

**PARENTHESIS**, a term originally Greek, and signifying *insertion* or *intercalation*, is in composition a clause, or part of a sentence or argument, not absolutely essential to the sense, but generally serving either for explanation or confirmation, sometimes chiefly for rhetorical effect. A parenthesis is usually included between the marks ( ), instead of which the *dash* (—) at the beginning and end of the parenthesis is frequently but improperly employed.

**PARIAH DOG.** See **CUR.**

**PARIAN.** See **POTTERY.**

**PARIAN CHRONICLE.** See **ARUNDEL MARBLES.**

**PARIAS** is the name given to the lowest class of the population of India—to that class which, not belonging to any of the castes of the Brahminical system, is shunned even by the lowest Hindu professing the Brahminical religion, as touching a Paria would render him impure. The P. seem to belong to a negro race, as appears from their short woolly hair, flat nose, and thick lips; they are, besides, of short stature, and their propensities are of the coarsest kind. Despised by the Hindus, and ill used by the conquerors of India, they have, in some parts of India, gradually sunk so low that, to judge from the description which is given of their mode of living by different writers, it is scarcely possible to imagine a more degraded position than that which is occupied by these miserable beings.

**PARIDÆ AND PARUS.** See **TR.**

**PARING AND BURNING** consists in cutting off the surface of the soil in thin slices, which are then dried and burned. This is the most effectual way of reclaiming peat and other waste land, the surface of which is matted with coarse plants, difficult of decay. It is also applied advantageously

to cold clay soils, apt to produce rank weeds and coarse grasses, which are to be broken up after lying for some time in grass. The ashes of the plants, consisting of potash and other salts, act as a powerful manure; while the clay being reduced to the state of brick-dust, both improves the texture of the soil, and acts as an absorbent for retaining moisture and nutritive gases, and giving them out to the roots of growing plants. On thin light soils the operation is rarely advisable, for much of the scanty volatile vegetable matter is dissipated; however if care is taken to make the turfs merely smoulder without flame, so that the plants are rather charred than burned, it is doubtful whether more dissipation takes place than if the plants were ploughed down, and allowed slowly to decay. The plot to be reclaimed should, if necessary, be dried by stone or tile drains; and all large stones grubbed up, and carted or conveyed off upon sledges. The paring is to be done, if possible, in the months of April and May, in order to have the most favourable part of the year for drying the parings well before burning. There are ploughs specially made for paring, with a very flat share; but the best method is to employ the *breast-plough* or *paring-spade*, as the surface is in most cases very irregular, and it is desirable to have the slices very thin. The parings should be burned directly they are sufficiently dry, as, after lying a month or six weeks, they begin to unite with the ground, and imbibe moisture from the young grass vegetating beneath them. Sometimes they can be burned as they lie, without being collected into heaps; and in this way, the fire, in consuming the liny side, which is undermost, chars the surface of the soil at the same time. If burned in heaps, the heaps should be very small, in order to secure a good black ash, instead of the hard lumps of red ash produced by large fires. The weeds or refuse organic matters are thus only charred, instead of being entirely burned away; whilst the mineral matters are left in a soluble state instead of being reduced, as is too apt to be the case where the operation is carelessly conducted, into an insoluble semi-vitrified slag. To attain these desirable results a smouldering fire must be maintained, by keeping the outside layer of sods so close as to prevent the fire from kindling into flame. The ashes should be spread, care being taken to clear the bottoms of the heaps well out, so that the first crop may be free from patches. The cost of thus paring, burning, and spreading is about £1 per acre.

**PARIS**, a genus of plants of the small endogenous or dictyogenous natural order *Trilliaceæ*, of which one species, *P. quadrifolia*, called **HERB PARIS**, is not uncommon in moist shady woods in some parts of Britain. It is rarely more than a foot high, with one whorl of generally four leaves, and a solitary flower on the top of the stem, followed by a berry. The berry is reputed narcotic and poisonous, but its juice has been employed to cure inflammation of the eyes. The root has been used as an emetic.

**PARIS**, also called **ALEXANDER**, was, according to Homer, the second son of Priam and Hecabe, sovereigns of Troy. His mother dreamed during her pregnancy that she gave birth to a firebrand, which set the whole city on fire, a dream interpreted by Æsacus or Cassandra to signify that P. should originate a war which should end in the destruction of his native city. To prevent its realisation, Priam caused the infant to be exposed upon Mount Ida by a shepherd named Agelaus, who found him, five days after, alive and well, a she-bear having given him suck. Agelaus brought him up as his own son, and he became a shepherd on Mount Ida,

distinguishing himself by his valour in protecting the other shepherds from their enemies—whence his name, Alexander, 'the defender of men.' An accident having revealed his parentage, old Priam became reconciled to his son, who married Cœnone, daughter of the river-god Cebren. But his mother's dream was to come true for all that. He was appealed to, as umpire, in a strife which had arisen among the three goddesses, Hera (Juno), Athene (Minerva), and Aphrodite (Venus), as to which of them was the most beautiful, the goddess Eris (Strife) having revengefully flung among them, at a feast to which she had not been invited, a golden apple (of discord) inscribed *To the Most Beautiful*. Each of the three endeavoured to bribe him. Hera promised him dominion over Asia and wealth; Athene, military renown and wisdom; Aphrodite, the fairest of women for his wife—to wit, Helene, the wife of the Lacedæmonian king, Menelaus. P. decided in favour of Aphrodite, hence the animosity which the other two goddesses displayed against the Trojans in the war that followed. P. now proceeded to seek Helene, whom he carried away from Lacedæmon in her husband's absence. 'The rape of Helen' is the legendary cause of the Trojan war, on account of which P. incurred the hatred of his countrymen. He deceitfully slew Achilles in the temple of Apollo. He was himself wounded by a poisoned arrow, and went to Mount Ida to be cured by Cœnone, who possessed great powers of healing; but she avenged herself for his unfaithfulness to her by refusing to assist him, and he returned to Troy, and died. He was often represented in ancient works of art generally as a beardless youth, of somewhat effeminate beauty.

PARIS (the ancient *Lutetia Parisiorum*), the metropolis of France, is situated in 48° 50' N. lat., and 2° 20' E. long., in the valley of the Seine, about 110 miles from its mouth. The population of the city is 1,700,000, and its circumference is upwards of 25 miles. It lies in a hollow, about 200 feet above the level of the sea, and is surrounded by low hills, which in their highest ranges to the north only attain an elevation of 290 or 300 feet, as at Montmartre and Belleville. These hills, which are separated by narrow valleys or plateaux, as those of St Denis to the north, Ivry to the east, Montrouge to the south, and Grenelle to the south-west, are encircled at a distance of from two to five miles by an outer range of heights, including Villejuif, Meudon, St Cloud, and Mont-Valérien, the highest point in the immediate vicinity of the city. The southern parts of the city are built over beds of limestone rich in fossils, which have been so extensively quarried as to have become a mere network of vast caverns, which in some cases scarcely afford sufficient support to the houses above. These quarries were first converted in 1784 into catacombs, in which are deposited the bones of the dead, collected from the ancient cemeteries of Paris. The Seine, which enters Paris in the south-east at Bercy, and leaves it at Passy in the west, divides the city into two parts, and forms the two islands of La Cité and St Louis, which are both covered with buildings; the former, the nucleus of ancient P., containing the cathedral of Notre-Dame, the Palais de Justice, and the Saint Chapelle; and the latter the Hôtel Lambert and the Church of St Louis.

The earliest notice of P. occurs in Julius Cæsar's *Commentaries*, in which it is described under the name of Lutetia, as a collection of mud huts, composing the chief settlement of the Parisii, a Gallic tribe, conquered by the Romans. The ruins of the Palatium Thermarum (Palais des Thermes), ascribed to Constantine Chlorus, is the only evidence

of the presence of the early Roman settlers in ancient Lutetia, which began in the 4th c. to be known as Parisia. In the 6th c. it was chosen by Clovis as the seat of government; and after having fallen into decay under the Carolingian kings, in whose time it suffered severely from frequent invasions of the Northmen, it was formally recognised in the 10th c. as the capital of the Frankish monarchy, being especially favoured by Hugh Capet, who granted it a municipal government, and by his encouragement of learning laid the foundation of the reputation of the P. schools. From this period, P. continued rapidly to increase, until it had doubled in size and population within two centuries. In the middle ages, P. was divided into three distinct parts—La Cité, on the island; the Ville, on the right bank; and the Quartier Latin, or University, on the left bank of the river. Louis XI. did much to enlarge the city, and to efface the disastrous results of its hostile occupation by the English during the wars under Henry V. and Henry VI. of England, but its progress was again checked during the wars of the last of the Valois, when the city had to sustain several sieges. On the accession of Henry IV. of Navarre, in 1589, a new era was opened to Paris. The improvements commenced under his reign were continued under the minority of his son, Louis XIII.; and on the accession of Louis XIV., the completion of several bridges, roads, and quays, and the erection of various public and private palaces, had put a new face on the old city. To the Grand Monarque, P. owed a still greater debt, for in addition to the opening of 80 new streets, and the conversion of the old ramparts into public walks, or *boulevards*, he organised a regular system of police, established drainage and sewerage works, founded hospitals, alms-houses, public schools, scientific societies, dramatic institutions, and learned establishments of various kinds, and thus gave to P. the indisputable right of being regarded as the focus of European civilisation, learning, and elegance. The terrible days of the Revolution caused a temporary reaction; the Parisian mob of that period of anarchy were more intent on destroying historical records of the past than in erecting monuments for the future. It needed all the genius of Napoleon to obliterate the damage done to the French metropolis during the reign of the people. With a strong hand he arrested the further demolition of the old city, and with extraordinary rapidity P. was remodelled on a new and grander scale. New quays, bridges, markets, streets, squares, and public gardens were created. All the treasures of arts and science which his conquests in other lands placed in his power were appropriated and applied to the embellishment of the capital, in the restoration of which he spent more than £4,000,000 sterling in twelve years. The downfall of the emperor arrested all further progress, and deprived P. of many of her ill-gotten treasures.

Under Louis XVIII. and Charles X. little was done towards the improvement of Paris. Renovation of various sorts commenced under Louis-Philippe; but as lately as 1834, much of the old style of things remained; the gutters ran down the middle of the streets, there was little underground drainage from the houses, oil-lamps were suspended on cords over the middle of the thoroughfares, and, except in one or two streets, there were no sidewalk-pavements. Old fantastic costumes were also still seen, and the harness employed for carriage horses was still chiefly of rope. The introduction of a copious supply of water to public fountains, of gas-lighting, and a better kind of street paving, are due to the reign of Louis-Philippe. It was reserved,

however, for Napoleon III. to render P. a thoroughly modern city. Under his rule, P. may be said to have been almost rebuilt. Streets are widened and beautified, and new and spacious thoroughfares are opened up through old and densely-built districts; in which, and numerous other undertakings, the emperor has set an example for the whole of Europe. In the present day, chiefly through his policy, P. excels in comfort and beauty all the cities in the world, and has accordingly become a centre of universal attraction.

Before going into details, it is proper to mention that P. is a city built of a light-coloured kind of limestone, easily wrought and carved ornamentally. With this material, the houses are reared in huge blocks, rising to a height of six or seven stories; each floor constituting a distinct dwelling; access to all the floors in a tenement being gained by a common stair, which is usually placed under the charge of a porter at the entrance. Very frequently, the tenements surround an open quadrangle, to which there is a spacious entry, the gate of which is kept by a porter for the whole inhabitants of the several stairs. In these respects, therefore, P. differs entirely from London; for instead of extending rows of small brick buildings of a temporary kind over vast spaces, the plan consists of piling durable houses on the top of each other, and confining the population to a comparatively limited area. Whether this device, which is adapted to the gregarious character of the French, could be successfully applied in London, remains uncertain.

Of the bridges (about 30 in number) which now span the river, 8 have been constructed since 1852, and several of the others rebuilt or repaired during the reign of the present emperor. The most celebrated and ancient are the Pont Notre-Dame, erected in 1500, and the Pont-Neuf, begun in 1578, completed by Henri IV. in 1604, and thoroughly renovated in 1852. This bridge, which crosses the Seine at the north of the Ile-de-la-Cité, is built on 12 arches, and abuts near the middle on a small peninsula, jutting out into the river, and planted with trees, which form a background to the statue of Henri IV. on horseback, which stands in the central open space on the bridge. Among the other bridges, the handsomest are, the Pont de la Concorde, 160 yards long, built in 1787—1790; the Pont du Carrousel, with its colossal allegorical figures at each end; Pont d'Austerlitz and Pont d'Jéna, both of the time of the First Empire; and the Pont des Invalides, Pont de l'Alma, and Pont de Solférino—all handsome structures, adorned with military and naval trophies, commemorative of events and victories connected with the present dynasty. These bridges all communicate directly with the spacious quays, planted with trees, which line both banks of the Seine, and which, together with the Boulevards, give special characteristic beauty to the city. Although the most ancient quays—as those des Augustins and de la Mégisserie—date from the 14th c., the greater part of these magnificent embankments, measuring 12 miles in extent, is due to the first Napoleon and the present emperor. The Boulevards, of which there are 22, and which extend in a semicircular line on the right side of the Seine, between the nucleus of the city and its surrounding quarters, present the most striking feature of Paris life. In all the better parts of the city they are lined with trees, seats, and little towers called *Vespasiennes*, covered with advertisements. Restaurants, cafés, shops, and various places of amusement succeed one another for miles, their character varying from the height of luxury and elegance in

the western Boulevard des Italiens, to the homely simplicity of the eastern Boulevards Beaumarchais and St Denis, where, however, the old character of squalor and villany, for which the streets and inhabitants were noted, has nearly disappeared under the thorough renovations of the present reign. The Porte St Martin and Porte St Denis, which were erected by Louis XIV. to commemorate his victories in the Low Countries, and are adorned with bas-reliefs representing events of these campaigns, mark the ancient limits of the most turbulent quarters of the Paris of the past, while the Arc de l'Étoile, begun by Napoleon in 1806, and completed in 1836 at a cost of more than £400,000, may be said to form the extreme western boundary of the aristocratic quarters. This arch, which bounds the Champs-Élysées, and has the reputation of being the largest in the world, has a total height of 152 feet and a breadth of 137. It is profusely adorned with bas- and alto-reliefs, representing the career and victories of Napoleon; and from its position, at the end of the noble avenue of the Champs-Élysées, forms a grand terminal vista to the Tuileries. P. has 1300 streets, many of which, in the central parts, are narrow and crooked, without side-pavements, and often dark from the height of the houses, which have from four to seven stories. This is especially the case in the eastern quarters on the left bank of the Seine, where there are labyrinths of dirty, winding streets. In accordance with the plan of the improvements designed during the present reign, wide, long streets are, however, everywhere gradually penetrating through the intricate network of narrow passages which, until recently, were to be met with in the north and east parts of the city, and thus opening direct communication between the centre and extremities of Paris. The finest streets are the Rue de Rivoli, two miles in length, Rue de la Paix, Rue du Faubourg St Honoré, Rue Royale, &c. Among the public squares, or *places*, of which there are upwards of 100, the most noteworthy is the Place de la Concorde, one of the finest squares in Europe, which connects the Gardens of the Tuileries with the Champs-Élysées, and embraces a magnificent view of some of the finest buildings and gardens of Paris. In the centre is the famous obelisk of Luxor, covered over its entire height of 73 feet with hieroglyphics. On the site of this obelisk stood the revolutionary guillotine, at which perished Louis XVI., Marie Antoinette, Philippe Égalité, Danton, Robespierre, and a host of other victims. Of the other squares, the following are some of the most handsome: the Place du Carrousel, between the Tuileries and Louvre; Place Vendôme, with Napoleon's Column of Victory; Place de la Bastille, where once stood that famous prison and fortress; Place Royale, with its two fountains and a statue of Louis XIII.; Place de l'Hôtel de Ville, formerly Place de la Grève, for many ages the scene of public executions, and the spot at which some of the bloodiest deeds of the Revolution were perpetrated.

Among the parish churches of P. (upwards of 60 in number), the grandest and most interesting, in an historical point of view, is the cathedral of Notre-Dame, which stands on a site successively occupied by a pagan temple and a Christian basilica of the time of the Merovingian kings. The present building was constructed between the 12th and 15th centuries, and in its present state of restored magnificence it may rank as one of the noblest specimens of Gothic architecture. It is of a regular cruciform shape, with an octagonal east end, two flanking towers with flying buttresses, and a new central spire, remarkable, like every other part, for its delicate and

elaborate tracery. It is 390 feet long, 102 feet high, with transepts 144 feet wide. Although most of the painted windows are modern, the grand rose-windows, which give a characteristic beauty to the whole building, are of ancient date. St Germain-des-Prés, which is probably the most ancient church in P., was completed in 1163; St Etienne du Mont and St Germain l'Auxerrois, both ancient, are interesting—the former for its picturesque and quaint decorations, and for containing the tomb of St Geneviève, the patron saint of P.; and the latter for its rich decorations and the frescoed portal, restored at the wish of Margaret of Valois. The Sainte Chapelle, built by St Louis in 1245—1248, for the reception of the various relics which he had brought from the Holy Land, is one of the most remarkable buildings in Paris. Surmounted by an elaborately-carved golden spire, 114 feet high, and blazing with a star-bespangled azure ceiling, and walls glittering with golden fleurs-de-lis, and profusely decorated in all parts with brilliantly-coloured materials, it corresponds well with the purpose for which it was often employed, as the scene of royal christenings, marriages, and coronations. During the Revolution it was put to various ignoble uses; and its present beauty is entirely due to the restorations, recently completed at a cost of £50,000. Among modern churches, we may instance the Madeleine, built in imitation of a Greek temple, and gorgeous with gildings, frescoes, carvings, marbles, and statues; the Pantheon, which was begun as a church, but converted by the Constituent Assembly of republican France into a temple, dedicated to the great men of the nation—it has been restored to the church by the present emperor, and dedicated to St Geneviève; Nôtre-Dame de Lorette, erected in 1823, a flagrant specimen of the meretricious taste of the day; and St Vincent de Paul, completed in 1844, somewhat less gaudy and more imposing in style; &c. Among the few Protestant churches, l'Oratoire is the largest and the best known.

Of the many palaces and public buildings with which P. abounds, the following are some of the most noted: the Tuileries with its fine Gardens; the Louvre, with its noble galleries of paintings and sculpture; the Palais Royal (q. v.); the Luxembourg, with its picturesque gardens, where the senate now hold their meetings, and where the works of modern artists are exhibited, built in 1620 for the Regent Marie de Medici, in imitation of the palaces of her native city Florence; the palace of the Corps Legislatif, known as Palais-Bourbon; the Elysée Napoleon, the residence of the present emperor when President of the Republic; the Hôtel de Ville, or municipal palace, a handsome building repaired and enlarged in 1837, containing magnificent suites of apartments for the celebration of civic and other public festivals; the Palais de Justice, on the left bank of the river, of which some parts date from the 14th c., and others are modern, and the seat of some of the courts of law, as the Court of Cassation, the Imperial Court, the Tribunals of the First Appeal and of Police. Within the precincts of this palace are the Saint Chapelle, and the noted old prison of the Conciergerie, in which Marie Antoinette, Danton, and Robespierre were successively confined, and where the present emperor was for a time kept in custody after his enterprise at Boulogne. The Conciergerie, in which prisoners are lodged pending their trial, constitutes one of the eight prisons of P., of which the principal is La Force. The Nouveau Bicêtre is designed for convicts sentenced to penal servitude for life; St Pélagie receives political offenders, St Lazare is exclusively for females, the Madelonnettes for

juvenile criminals, and Clichy for debtors. The number of the institutions of benevolence is enormous; and according to statistical tables, from 6000 to 12,000 persons are wholly maintained by their means, while 90,000 receive partial aid. The charity of P. is administered by the department of Assistance Publique, whose revenues are obtained by a tax on the receipts of theatres and other places of amusement, on burials, and on the Monts de Piété, or government pawning-offices, of which there are 25. The largest of the numerous hospices or alms-houses is La Salpêtrière, probably the largest asylum in the world, extending over 78 acres of land, and appropriated solely to old women, 1300 of its 4500 inmates being insane patients; Bicêtre, with nearly 3600 beds, receives only men. The Hospice des Enfants Trouvés, or Foundling Hospital, provides for the infants brought to it till they reach the age of maturity, and only demands payment in the event of a child being reclaimed. The Crèches, or public nurseries, first established in 1844, of which there are now 18, receive the infants of poor women for the day at the cost of 20 centimes. Besides institutions for the blind, deaf and dumb, convalescents, sick children, &c., P. has 17 general and special hospitals. Of these the oldest and most noted is the Hôtel Dieu, receiving annually 13,000 patients; La Charité, La Pitié, the recently-founded Lariboisière, l'Hôpital Clinique, and others equally worthy of notice, contributing by the excellent medical staff attached to each to the high repute of P. as a school of medicine. P. has one university, which was founded in 1253 by Robert Sorbonne; its head-quarters are at the Sorbonne, where degrees are granted in the faculties of sciences, letters, and theology, and where gratuitous public lectures, delivered by 11 professors, are attended by nearly 2000 students; it has a library of 80,000 volumes, schools of medicine and law, and museums, &c. There are five lycées, several municipal colleges, 419 free public elementary schools, giving education to 44,800 boys and 27,000 girls; an Ecole Polytechnique, trade and normal schools, an Academy of the Fine Arts, Conservatoire of Music, &c. The Jardin des Plantes, a school of natural history, enjoys a world-wide renown. (The Institute of France is noticed in a separate article.) The Observatory, founded in 1667, has a magnificent set of instruments and a library of 40,000 volumes. The principal of the public libraries are l'Impériale (see LIBRARIES), which originated in a small collection of books placed by Louis XI. in the Louvre; St Geneviève, founded in 1610, containing 110,000 volumes; Hôtel de Ville, with 45,000 volumes. The Hôtel des Archives, in which the national records are deposited, contains a unique collection of valuable curiosities, including a deed of gift by Childebert I., in 528, of two villages to the church of Paris; the state seals of France during 1300 years, &c. No city on this side of the Alps is richer than P. in fine-art collections, and among these the 15 museums at the Louvre stand pre-eminent, and would require volumes for their illustration. The Hôtel Cluny, in addition to its being in itself a most interesting monument of mediæval art, contains curious relics of the arts and usages of the French people, from the earliest ages of their history to the renaissance period. The Mint deserves notice for the perfection of its machinery, the ingenuity of the processes employed in coining, and the museum attached to the establishment. The Gobelins, or tapestry manufactory, may be included under the fine arts, as the productions of its looms are all manual, and demand great artistic skill, the larger specimens



requiring from eight to ten years for their completion. The tapestries are retained by the government for the decoration of palaces at home, or are presented to foreign sovereigns. The Bourse or Exchange, built in 1808, and the Bank of France, once a private palace, are both fine buildings. P. abounds in theatres and places of amusement suited to the tastes and means of every class. The leading houses, as the Opéra, Théâtre Français, chiefly devoted to classical French drama, Odéon, Théâtre Italien, &c., receive a subvention from government, and all are under strict police supervision. Cheap concerts, equestrian performances, and public balls, held in the open air in summer, supply a constant round of gaiety to the burgher and working-classes at a moderate cost, and form a characteristic feature of P. life; while in addition to the noble gardens of the various imperial palaces, the most densely-crowded parts of the city have public gardens, shaded by trees, and adorned with fountains and statues, which afford the means of health and recreation to the poor.

Vast improvements, as already stated, have been made in the city from 1853 to the present time (1864). Within these recent years, the Boulevard de Sébastopol—opening up the most populous and most unhealthy district of P., a district formerly the hotbed of disturbance—has been erected at the cost of about £3,000,000. Several central markets have also been constructed; the Rue Rivoli has been prolonged, and a boulevard in commemoration of the visit of Queen Victoria has been erected between the Hôtel de Ville and the Place du Châtelet. A convention between the state and the city of P., ratified 28th May 1858, guarantees that within ten years from that date 9 new boulevards and 10 new streets shall be erected, old streets joined and levelled, and 4 new avenues formed. From the 1st October 1862 to 30th September 1863, 2943 new buildings had been erected in Paris. While the sums spent in the improvement and ornamentation of the city have largely increased, the municipal revenues have also been rapidly enlarged within recent years.

P. has three large and twelve lesser cemeteries, of which the principal one is Père-la-Chaise, extending over 200 acres, and filled in every part with monuments erected to the memory of the countless number of celebrated persons who have been buried here. The Morgue is a building in which the bodies of unknown persons who have met with a violent death are placed, and which, if not claimed within three days, are buried at the public expense.

P. was surrounded under Louis-Philippe with fortifications, extending 30 miles round, and costing £5,500,000 sterling, and in addition to these, 16 detached forts have been erected at definite distances from one another. The 50,000 men usually garrisoned within and around P. are quartered in 30 barracks, within the line of fortifications. Besides these troops, the city has a national guard, numbering about 40,000 men, in which all citizens between 25 and 50 are liable to be called into service. The Arsenal is situated near the site of the old Bastille. The Champ-de-Mars is a vast sandy plain, near the Quai d'Orsay, on which reviews and other military displays and national festivals are held. Close to it stands the Ecole Militaire, founded in 1752, and now used as a military training-school for infantry and cavalry, of which it can accommodate 10,000 men, with space for 800 horses. The Hôtel des Invalides, founded in 1670, for disabled soldiers, is an admirable institution, situated on the left bank of the river. It can receive 8000 men, but the number of the inmates is generally much less, and consists

both of officers and non-commissioned officers; all soldiers who have been seriously wounded, or who have served 30 years, being entitled to admission. The library, museum, and chapel are full of objects of interest, and every part of the building is filled with mementoes of the wars and victories of France. The crypt of the church contains the sarcophagus, hewn from a huge block of Russian granite, in which lie the remains of Napoleon, deposited here in 1840.

P. is divided into 20 *arrondissements*. The prefect of the Seine is the chief of the municipal government, aided by a council of 36 members, appointed, as he is himself, by the government. The civic revenues amount for the present year (1864) to 151,408,942 francs, or £6,002,931, more than one-half of which is drawn from the *octroi* or city dues. Each *arrondissement* has a *maire* and two assistant councillors. The prefect of police is at the head of the civic guard or *gensdarmes*, of 4400 men; the fire-brigade, of 1800 men; and the *sergents de ville*, or city police, numbering 3570 men, who are armed with a sword. According to statistical reports, there are 60,000 persons belonging to the criminal class, of whom one third are women, at large in P., but known to the police. The cleaning, sewerage, and water supplies of P. are under the charge of the prefect. The dirt and sewerage are conveyed to large reservoirs, known as the *Voirie de Bondy*, where, after three years' interval, they are sold for manure, while numerous scavengers are employed in sweeping the great thoroughfares several times daily, although the less frequented or humbler streets are still much neglected. P. is now abundantly supplied with pure and wholesome water; the drainage is also being improved—since 1854, the length of vaulted sewers has been doubled, and now amounts to upwards of 250 miles. The same may be said in regard to the paving of the city, and the street-lighting is now adequately effected by means of some 15,000 gas-lights. In 1818 public slaughter-houses, or *abattoirs*, were established at different suburbs, where alone animals are allowed to be slaughtered. Large cattle-markets are held near the licensed *Abattoirs* (q. v.). There are in the heart of the city numerous *halles*, or wholesale, and *marchés*, or retail markets. The principal of these is the Halles Centrales, near the Church of St Eustache, now in process of completion, and covering nearly 20 acres. According to strictly-enforced police regulations, no carcases or pieces of meat are allowed to be carried openly about and ostentatiously exhibited, as is the very offensive practice about Newgate Street, in London; neither are butchers allowed to shew themselves in the dress of the *abattoirs*. Among the older markets, the Halle aux Vins, in which 500,000 casks of wine can be stowed, and the *Marché aux Fleurs*, are perhaps the most interesting; the latter presenting on a summer's morning one of the most charming sights of Paris. On the whole P., as now constituted and regulated, offers an important subject of study to the social economist, and all generally who are interested in the arrangement of great cities.

PARIS BASIN, the collective name of the beds of Eocene age, which rest in a hollow of the chalk in the district around Paris, where they occupy an oblong area measuring 180 miles in greatest length from north to south, and 90 miles in breadth from east to west. The different sections into which the series has been divided are given under Eocene (q. v.). The beds are chiefly remarkable for the rich harvest of organic remains which they supplied to Cuvier, and which led to the foundation of the modern science of Palæontology. The strata from which

these were principally obtained consist of a series of white and green marls with subordinate beds of gypsum; they are largely developed at Montmartre, where the gypsum has been extensively quarried for the manufacture of plaster of Paris. The fossils consist of land and fluviatile shells, fresh-water fish and crocodiles, and the bones of birds and quadrupeds, besides a few land-plants, among which are some palms. The mammals, of which about 50 species have been described, belong to the order Pachydermata. The Paris Basin has for some time almost ceased to supply the remains of vertebrate animals.

PARIS, MATTHEW, the best Latin chronicler of the 13th c., was born about 1195, and in 1217 entered the Benedictine monastery of St Albans. After the departure of Roger of Wendover, in 1235, P. was chosen to succeed him as annalist of the monastery. He discharged his functions with veracity and boldness, in consequence of which he greatly displeased some of his contemporaries. The principal external incident of his life was his voyage to Norway, whither he was invited by King Hakon, to repair the financial disorders in the Benedictine monastery of Holm. P. landed at Bergen, 10th July 1248, was courteously received by the Norwegian monarch, and settled the business about which he came in a satisfactory manner. After his return to England, he stood high in the favour of Henry III., who used to converse with him in the most familiar manner, and from whose lips he derived not a little of the information that makes his *Chronicle* so valuable. He had also a wide circle of influential friends and acquaintances among the clergy, from whom he obtained materials for his work. His death occurred in 1259. P. had a great reputation in his day for his virtues and abilities. He was considered a universal scholar, and is said by his laudatory biographers to have been versed in mathematics, poetry, oratory, divinity, history, painting, and architecture. One thing about him long kept his memory green in the hearts of his countrymen—he was a patriotic Englishman, and though a sincere Catholic (like all good men of his age), yet he loved his country better than the pope, and wrote so fiercely against the encroachments of the court of Rome in ecclesiastical matters, that his *Chronicle* became, in after times, a great favourite with the Reformers. P.'s principal work is his *Historia Major*, which begins with the Norman Conquest, and extends to the year of the author's death. It was continued by William Rishanger, also a monk of St Albans, till the death of Henry III. in 1272. The first edition was published at London by Archbishop Parker, in 1571, and was reproduced at Zürich in 1606; later and more complete editions are those of London in 1640—1641, and in 1684. The only portion of the *Historia Major*, however, which is properly the work of P., is that extending from 1235 to 1259; the previous part being nearly a transcription from the *Flores Historiarum*, attributed to Roger of Wendover, whence some critics have supposed that P. is really the author of that work too. But this opinion is strenuously contested by the most recent editor of the *Flores Historiarum*, the Rev. H. O. Coxe (4 vols. 1841—1842). Translations both of P.'s *Chronicle* and that of Roger of Wendover have been published by Bohn in his Antiquarian Library. The British Museum, and the library of Corpus Christi College at Cambridge, contain manuscript abridgments of the *Historia Major*, made by P. himself, and entitled *Chronica Majora Sancte Albani*; a second abridgment is known as the *Historia Minor*. Other works of P.'s are *Duorum Cesarum Merciorum Regum Vita*; *Viginti trium*

*Abbatum, S. Albani Vita*; and *Additamenta*, being explanatory additions to his *Historia Major*.

PARISH (Gr. *paroikia*, habitation, from *para*, near, and *oikeomat*, I dwell; Lat. *parochia*), the district assigned to a particular church, where the inhabitants of the district may attend at public worship, and receive the sacramental or other ministrations of the clergy. The name originally seems to have been interchangeable with *diocesis*, 'diocese,' and to have been applied to the district subject to the spiritual jurisdiction of a bishop; and, on the other hand, at a later period, *diocesis* was sometimes used to signify a parochial church or district. The distribution into parishes appears to be comparatively modern. Originally, all the clergy were (in the opinion of the Episcopalian churches) but coadjutors of the bishop, and served in his church, at which all the faithful assembled. At Alexandria, and afterwards at Rome, a number of minor churches were opened (called at Rome *tituli*), which were served by clergy, originally not permanently attached to them, but sent from the principal or bishop's church, but in progress of time fixed permanently in the charge. This, however, was not common; and we find churches, with clergy permanently attached, much earlier in rural districts than in cities. The institution does not appear to have become general till the 9th or 10th century. In England, the first legislation on the subject occurs in the laws of Edgar, about 970. The parochial division of districts seems in great measure to have followed the civil distribution into manors, or other feudal divisions of territory; and it is probable that it is to the same state of things we owe the practice of lay patronage, the priest officiating in a manorial church being chosen, with the bishop's consent, by the lord of the manor. The parochial revenue, however, by no means followed the same rules which now prevail. At first, all ecclesiastical income, from whatever district, was carried into a common fund, which was placed at the disposal of the bishop, and was generally divided into four parts—for the bishop, for the clergy, for the poor, and for the church. By degrees, however, beginning first with the rural parishes, and ultimately extending to those of the cities, the parochial revenues were placed at the disposal of the parish clergy (subject to the same general threefold division, for the clergy, for the poor, and for the church); and in some places an abusive claim, which was early reprobated, arose upon the part of the lord of the manor to a portion of the revenue. Properly, a parish has but one church; but when the district is extensive, one or more minor (*succursal*) churches, sometimes called 'chapels of ease,' are permitted.

In the law of England, a parish is an important subdivision of the country, for purposes of local self-government, most of the local rates and taxes being confined within that area, and to a certain extent self-imposed by the parties who pay them. The origin of the division of England into parishes is not very clearly ascertained by the authorities. Some have asserted that the division had an ecclesiastical origin, and that a parish was merely a district sufficient for one priest to attend to. But others have asserted that parishes had a civil origin long anterior to ecclesiastical distinctions, advantage being merely taken to ingraft these on so convenient an existing subdivision of the country; and that a parish was a subdivision of the ancient hundred, known as a vill or town, and through its machinery the public taxes were anciently collected. Hobart fixes the date of the institution of civil parishes in 1179, and his account has been generally followed. Much

## PARISH.

difficulty has occasionally arisen in fixing the boundaries of parishes. Blackstone says the boundaries of parishes were originally ascertained by those of manors, and that it very seldom happened that a manor extended itself over more parishes than one, though there were often many manors in one parish. Nevertheless, the boundaries of parishes are often intermixed, which Blackstone accounts for by the practice of the lords of adjoining manors obliging their tenants to appropriate their tithes towards the officiating minister of the church, which was built for the whole. Even in the present day, these boundaries often give rise to litigation, and the courts have always decided the question according to the proof of custom. This custom is chiefly established by the ancient practice of perambulating the parish in Rogation-week in each year. See PERAMBULATION. There are some places as to which it is uncertain whether they are parishes or not, and hence it has been usual to call them reputed parishes. There are also places called extra-parochial places, which do not belong to any parish, such as forest and abbey lands. In these cases, the persons inhabiting were not subject to the usual parochial rates and taxes, and other incidents of parochial life. But in 1857, a statute was passed which put extra-parochial places upon a similar footing to parishes, by giving power to justices, and in some cases to the Poor-law Board, to annex them to adjoining parishes, after which they are dealt with in much the same way as other places. One of the chief characteristics of a parish is, that there is a parish church, and an incumbent and churchwardens attached to it, and by this machinery the spiritual wants of the parishioners are attended to. These several parish churches, and the endowments connected therewith, belong in a certain sense to the nation, and the incumbents are members of the Established Church of England, and amenable to the discipline of the bishops and the spiritual courts. The private patronage, or right of presenting a clergyman to an incumbency, is technically called an advowson, and is generally held by an individual as a saleable property, having a market value. The patron has an absolute right (quite irrespective of the wishes of the parishioners) to present a clerk or ordained priest of the church of England to a vacant benefice, and it is for the bishop to see to his qualifications. The bishop is the sole judge of these qualifications, and if he approves of them, the clerk or priest is instituted and inducted into the benefice, which ceremony completes his legal title to the fruits of the benefice. The incumbents of parish churches are called rectors, or vicars, or perpetual curates, the distinction being chiefly founded on the state of the tithes. When the benefice is full, then the freehold of the church vests in the rector or parson, and so does the churchyard; but he holds these only as a trustee for the use of the parishioners. There are certain duties which the incumbent of the parish church is bound by law to perform for the benefit of the parishioners. He is bound, as a general rule, to reside in the parish, so as to be ready to administer the rites of the church to them. See NON-RESIDENCE. The first duty of the incumbent is to perform public worship in the parish church every Sunday, according to the form prescribed by the Book of Common Prayer, which is part of the statute-law of England. He must adhere strictly to the forms and ceremonies, and even to the dress prescribed by the Book of Common Prayer and Canons. The incumbent is also bound to baptise the children of all the parishioners, and to administer the rite of the Lord's Supper to the parishioners not less than three times each

year. The incumbent is also bound to allow the parishioners to be buried in the churchyard of the parish, if there is accommodation, and to read the burial-service at each interment. He is also bound to marry the parishioners on their tendering themselves, and complying with the marriage acts, within the parish church and during canonical hours, and it is said he is liable to an action of damages if he refuse. In respect of burials and marriages, certain fees are frequently payable by custom; but unless such a custom exists, no fee is exigible for performance of these duties. In many cases, where one church had become insufficient for the increased population, the old parish has been subdivided under the Church Building Acts, the first of which was passed in 1818, into two or more ecclesiastical districts or parishes, for each of which a new church was built, and an incumbent appointed. The incumbents in these ecclesiastical parishes have generally been provided for by the incumbent of the mother-parish or by voluntary benefactors, and by the aid of pew-rents. But these ecclesiastical parishes, so far as the poor and other secular purposes are concerned, make no change on the old law. Another incident of the parish church is, that there must be churchwardens appointed annually, who are accordingly leading parochial officers, and whose duty is partly ecclesiastical and partly civil. Their civil duties consist chiefly in this, that they must join the overseers in many of the duties arising out of the management of the poor, and incidental duties imposed by statute. But their primary duty is to attend to the repair and good order of the fabric of the church. The common law requires that there should be two churchwardens, one of whom is appointed by the incumbent, and the other is chosen by the parishioners in vestry assembled, but sometimes this rule is varied by a local custom. This appointment and election take place in Easter-week of each year. In electing the people's churchwarden, there is often much local excitement, and it is common to poll the parish, all those who pay poor-rates being entitled to vote, the number of votes varying according to the rent, but no person having more than six votes. See CHURCHWARDENS; CHURCH RATES.

The next most important business connected with the parish is that which concerns the poor, the leading principle being, that each parish is bound to pay the expense of relieving its own poor. See OVERSEERS; GUARDIAN; POOR.

Another important feature of the parish is, that all the highways within the parish must be kept in repair by the parish, i. e., by the inhabitants who are rated to the poor. For this purpose, the inhabitants of each parish, in vestry assembled, appoint each year a surveyor of highways, whose duty it is to see that the highways are kept in good repair; and he is authorised, by the General Highway Act, to levy a rate on all the property within the parish. The office of a surveyor of highways is, like those of churchwarden, overseer, and guardian, a compulsory and gratuitous office. When a highway is out of repair, the mode of enforcing the repair is by summoning the surveyor of highways before justices, to shew cause why he has not repaired the road; and if the facts are not disputed, the justices either fine him, or order an indictment to be laid against the inhabitants of the parish. This indictment is tried, and the expense of it is defrayed out of the highway-rate, which is subsequently made. The highways of each parish being thus exclusively under the control of the ratepayers and their officers, it happened that great inequality prevailed in the standard of repairs which each parish set up for

## PARISH—PARISH SCHOOL.

itself. This led to the late Highway District Act, 25 and 26 Vict. c. 61, the object of which is to enable the justices of the peace of the district to combine several parishes into one district, and thus secure more uniformity in the repairs of the highways. A way-warden is now appointed to represent each parish at the Highway Board, instead of the old highway surveyor; but the expenses of maintaining the highways is still ultimately paid by the parish in which they are situated, the only change being, that the expenses are ordered to be incurred by the Highway Board, instead of the parochial officer.

The above duties in reference to the parish church, the poor, and the highways, are the leading duties attaching to the parish as a parish; but over and above these, many miscellaneous duties have been imposed on the parish officers, particularly on the overseers and churchwardens, which will be found specified under the head of **OVERSEERS**. In nearly all cases where the parish, as a parish, is required to act, the mode in which it does so is by the machinery of a vestry. A vestry is a meeting of all the inhabitant householders rated to the poor. It is called by the churchwardens, and all questions are put to the vote. Any ratepayer who thinks the majority of those present do not represent the majority of the whole parishioners, is entitled to demand a poll. At these meetings, great excitement often prevails, especially in meetings respecting church-rates. Wherever a parish improvement is found to be desirable, the vestry may meet and decide whether it is to be proceeded with, in which case they have powers of rating themselves for the expense. Such is the case as to the establishment of baths and wash-houses, watching, and lighting. Returns are made of all parish and local rates to parliament every year. The parish property, except the goods of the parish church, which are vested in the churchwardens, is vested in the overseers, who hold and manage the same, requiring the consent of the Poor-law Board in order to sell it. Of late, a statute has authorised benefactors to dedicate greens or playgrounds to the inhabitants of parishes, through the intervention of trustees.

In Scotland, the division into parishes has existed from the most ancient times, and is recognised for certain civil purposes relative to taxation and otherwise, as well as for purposes purely ecclesiastical. The Court of Session, acting as the Commission of Teinds, may unite two or more parishes into one; or may divide a parish, or disjoin part of it, with consent of the heritors (or landholders) of a major part of the valuation; or apart from their consent, if it be shewn that there is within the disjoined part a sufficient place of worship, and if the Titulars of Teinds (q. v.), or others who have to pay no less than three-fourths of the additional stipend, do not object. By Act 7 and 8 Vict. c. 44, any district where there is an endowed church may be erected into a parish *quoad sacra*, for such purposes as are purely ecclesiastical. Endowed Gaelic congregations in the large towns of the Lowlands may similarly be erected into parishes *quoad sacra*.

The principal application of the parochial division for civil purposes relates to the administration of the poor-law. Under the old system the administrators of the poor-law were the kirk-session in county parishes, and the magistrates, or certain managers selected by them, in burghal parishes. The Act 8 and 9 Vict. c. 83, which remodelled the poor-law of Scotland, retained the old administrative body so long as there was no assessment; but, on a parish being assessed, substituted for it a new one, consisting in rural parishes of the owners of

heritable property of £20 yearly value, of the magistrates of any royal burgh within the bounds, of the kirk-session, a certain number of members chosen by the persons assessed; and in burghal parishes of members, not exceeding 30, chosen by the persons assessed, four members named by the magistrates, and not above four by the kirk-session or sessions. The Board of Supervision may unite two or more parishes into a combination for poor-law purposes. There is not the same extensive machinery for parochial self-government that exists in England. The burden of supporting the fabric of the church falls on the heritors, and there are no churchwardens. Highways are not repairable by the parish, and there are no elections of surveyors or way-wardens. The meeting of the inhabitants in vestry, which so often takes place in England, is unknown in Scotland, and hence the ratepayers do not interest themselves so much in local affairs. Many of the duties which in England are discharged by parochial officers, are in Scotland discharged by the sheriff-clerk, a county-officer. In Scotland, there exists in every parish a Parish School (q. v.), which is unknown in England, except as a voluntary institution.

**PARISH CLERK**, in England, is an officer of the parish of some importance, his duty being to lead the responses during the reading of the service in the parish church. He is appointed by the parson, unless some other custom of a peculiar kind exists in the parish. He must be 20 years of age, and has his office for life, but is removable by the parson for sufficient cause. By the statute 7 and 8 Vict. c. 59, a person in holy orders may be elected a parish clerk. Under some of the Church Building Acts governing the new churches built in populous parishes, he is annually appointed by the minister. The salary of the parish clerk is paid out of the church-rate.

**PARISH SCHOOL**. In England, there is no such thing as a parish school—that is, a school existing for the benefit of the parishioners, endowed by the state, or supported by taxes on the parishioners. Every school beyond charity schools is more or less voluntary in its character, and endowed, if at all, by private benefactors. In Scotland, however, it is essential that in every parish there shall be a parish school, for a statute of 1696 made it compulsory on the heritors—i. e., the chief proprietors—to provide a school-house, and to fix a salary for the teacher. If the heritors neglected to supply a school-house, the presbytery was empowered to order one at the expense of the heritors. The schoolmaster's salary was fixed according to a certain proportion, half of the rate or cess being paid by the landlord, and half by the tenant. In 1803, a statute passed to regulate the salaries, and to give a right to the schoolmaster to have a house and garden. The modern statute now regulating the office is 24 and 25 Vict. c. 107. The salary is fixed to be from £35 to £70 per annum, to be varied and fixed by the heritors and minister of the parish, in the case of future vacancies. The qualification of the schoolmaster consists in passing an examination conducted by the examiners of parochial schoolmasters, who are professors of the universities, who make regulations as to the time and mode of examination. For this purpose, Scotland is divided into four districts, each in connection with one of the Scotch universities. When examined, the person obtains a certificate of fitness from these examiners. The schoolmaster is not now required, previous to being admitted to his office, to sign the Confession of Faith, or the formula of the Church of Scotland, or

to profess that he will submit to the government and discipline thereof. But he is required merely to make a declaration that he will not, in his said office, endeavour directly or indirectly to teach or inculcate opinions opposed to the divine authority of the Holy Scriptures, or to the doctrines contained in the Shorter Catechism, agreed upon by the Assembly of Divines at Westminster, and approved by the General Assembly of the Church of Scotland, and that he will not exercise the functions of his office to the prejudice or subversion of the Church of Scotland as by law established. In case of misconduct, the Presbytery may complain to the Secretary of State, who will institute a commission to inquire and report, and to censure, suspend, or deprive such schoolmaster accordingly. Formerly, the Presbytery of the Established Church had jurisdiction to prosecute and try the schoolmaster for immoral conduct, or cruel or improper treatment of the scholars, but now the sheriff of the county is the sole judge of the charge, full opportunity being given to the schoolmaster to prepare his defence. In case of sentence of suspension, the salary is to cease to be payable. The schoolmaster's house is now to consist of at least four apartments; and the heritors and minister may permit or require him to resign, and allow him a retiring allowance. With these improvements, it needs to be added, that the system of parish schools has fallen greatly short of the general requirements of the country—what was well adapted to a state of things at the Revolution, when there was a meagrely-scattered population, being out of date when the population is about three times greater. The deficiency is chiefly felt where populous manufacturing villages and towns have sprung up in rural districts. On this account, the much-boasted parochial school system of Scotland is in various quarters far behind the requirements of modern society, and but for denominational and other schools, vast numbers of children would be left without the rudiments of education.

**PARK** (Fr. *parc*), a term still employed in some parts of Britain, in its original sense, to denote a field or enclosure, but more generally applied to the enclosed grounds around a mansion, designated in Scotland by another term of French origin, *policy*. The park, in this sense, includes not only the lawn, but all that is devoted to the growth of timber, pasturage for deer, sheep, cattle, &c., in connection with the mansion, wherever pleasure-walks or drives extend, or the purpose of enjoyment prevails over that of economical use. *Public parks* are those in the vicinity of towns and cities, open to the public, and intended for their benefit. An increase of public parks is a pleasing feature of the present age, and not a few towns enjoy parks recently bestowed by wealthy persons somehow connected with them.

**PARK, MUNGO**, a celebrated African traveller, was the son of a Scottish farmer, and was born 10th September 1771 at Fowlshields near Selkirk. He studied medicine in Edinburgh, and afterwards went to London, where he obtained the situation of assistant-surgeon in a vessel bound for the East Indies. When he returned in 1793, the *African Association* of London had received intelligence of the death of Major Houghton, who had undertaken a journey to Africa at their expense. P. offered himself for a similar undertaking, was accepted, and sailed from England 22d May 1795. He spent some months at the English factory of Pisania on the Gambia in making preparations for his further travels, and in learning the Mandingo language. Leaving Pisania on the 2d of December, he travelled eastward; but when

he had nearly reached the place where Houghton lost his life, he fell into the hands of a Moorish king, who imprisoned him, and treated him so roughly, that P. seized an opportunity of escaping (1st July 1796). In the third week of his flight, he reached the Niger, the great object of his search, at Sego (in the kingdom of Bambarra), and followed its course downward as far as Silla; but meeting with hindrances that compelled him to retrace his steps, he pursued his way westwards along its banks to Bammakoe, and then crossed a mountainous country till he came to Kamalia, in the kingdom of Mandingo (14th September), where he was taken ill, and lay for seven months. A slave-trader at last conveyed him again to the English factory on the Gambia, where he arrived 10th June 1797, after an absence of nineteen months. He published an account of his travels after his return to Britain, under the title of *Travels in the Interior of Africa* (Lond. 1799), a work which at once acquired a high popularity. He now married and settled as a surgeon at Peebles, where, however, he did not acquire an extensive practice; so that, in 1805, he undertook another journey to Africa, at the expense of the government. When he started from Pisania, he had a company of 45, of whom 36 were European soldiers; but when he reached the Niger in August, his attendants were reduced to seven, so fatal is the rainy season in those regions to Europeans. From Sansanding on the Niger, in the kingdom of Bambarra, he sent back his journals and letters in November 1805 to Gambia; and built a boat, in which he embarked with four European companions, and reached the kingdom of Houssa, where he and they are believed to have been murdered by the natives, or drowned as they attempted to sail through a narrow channel of the river. The fragments of information and other evidence picked up among the natives by Clapperton and Lander (q. v.), strongly confirm this view of the fate of P. and his companions. An account of P.'s second journey was published at London in 1815. P.'s narratives are of no inconsiderable value, particularly for the light which they throw upon the social and domestic life of the negroes, and on the botany and meteorology of the regions through which he passed; but he was unfortunately cut off before he had determined the grand object of his explorations—the discovery of the course of the Niger.

**PARK OF ARTILLERY** is the whole train of great guns with equipment, ammunition, horses, and gunners for an army in the field. It is placed in a situation whence rapid access can be had to the line of the army in any part; and at the same time where the divisions of the force can easily mass for its protection. The horses of the park are picketed in lines in its rear.

**PARKA**, the name given by Fleming to a fossil from the Old Red Sandstone, about which there has been considerable difference of opinion. The quarrymen call them 'berries,' from their resemblance to a compressed raspberry. They were compared by Fleming to the panicles of a *Juncus*, or the globose head of a *Sparganium*. Lyell thinks they resemble the egg-cases of a *Natica*, while Mantell suggested that they were the eggs of a batrachian. The opinion now most generally entertained is that they are the eggs of the *Pterygotus*.

**PARKER**, a family of distinction in the annals of the British navy. The founder of the family was **SIR HUGH PARKER**, an alderman of London, who received a baronetcy in 1681.—His grand-nephew, **SIR HYDE PARKER**, commanded the British fleet in the action off the Dogger Bank, 5th August 1781,

in which three Dutch ships were destroyed, and the rest of the Dutch fleet compelled to retreat into harbour. In 1783, he was appointed to the command of the British fleet in the East Indies; but the ship in which he sailed thither was lost, with all on board.—His second son, SIR HYDE PARKER, distinguished himself in the American war; blockaded the Dutch harbours with a small squadron in 1782; commanded the British fleet in the West Indies in 1795; and in 1801 was appointed to the chief command of the fleet which was sent to the Baltic to act against the armed coalition of the three northern states of Russia, Sweden, and Denmark. He had no share in the battle of Copenhagen, in which Nelson engaged contrary to his orders; but by his appearance before Carlscrona, he compelled the neutrality of Sweden; and he was on the point of sailing for Cronstadt, when the news of Paul's death put an end to hostilities.—His kinsman, SIR WILLIAM PARKER, was also a British admiral of high repute for his skill and bravery, and contributed to some of the great victories of the close of last century.—SIR PETER PARKER, who was born in 1716, and died in 1811, with the rank of admiral of the fleet, served with distinction during the Seven Years' and the American wars; and in 1782 brought the French admiral, De Grasse, a prisoner to England, for which he received a baronetcy.—SIR WILLIAM PARKER, born in 1780, commanded the frigate *Amazon* in 1806, and took, after a hard battle, the French frigate *La Belle Poule*, belonging to the squadron of Admiral Lincolin; and in 1809 captured the citadel of Ferrol. In 1841, he succeeded to Admiral Elliot in the command of the fleet in the Chinese seas during the first Chinese war. He took possession of Chusan, Ningpo, and Shapu; forced the entrance of the Yang-tse-kiang; and arrived under the walls of Nanking, where the treaty of peace was agreed upon. For these services, he received a baronetcy in 1844. He was afterwards appointed to the command of the fleet in the Mediterranean, and exerted himself, although in vain, to mediate between the Neapolitan government and the insurgent Sicilians. In autumn 1849, he sailed to the Dardanelles, at the request of Sir Stratford Canning (now Lord Stratford de Redcliffe), to support the Porte against the threatening demands of Austria and Russia concerning political fugitives; and in January 1850 he compelled the Greek government, by a blockade of their ports, to comply with the demands of Britain. Named in 1851 Admiral of the Blue, he resigned the command of the Mediterranean fleet to Admiral Dundas, was created Admiral of the White in 1853, Admiral of the Red in 1858, and Rear-admiral of the United Kingdom in 1862.

PARKER, MATTHEW, the second Protestant Archbishop of Canterbury, was born at Norwich, August 6, 1504, studied at Corpus Christi College, Cambridge, and was ordained a priest in 1527. At the university, he was a distinguished student, especially of the Scriptures and of the history of the church, even to antiquarian minuteness; yet, in spite of his strong leaning to the past, he was from an early period favourably disposed towards the doctrines of the Reformation, and lived in close intimacy with some of the more ardent reformers. In 1533, he was appointed chaplain to Queen Anne Boleyn, who thought very highly of him, and not long before her death, exhorted her daughter Elizabeth to avail herself of P.'s wise and pious counsel. In 1535, he obtained the deanery of the monastic college of Stoke-Clare in Suffolk—*Roman Catholicism*, it must not be forgotten, being still the professed religion of the land, for Henry had not yet formally broken with the pope—and here the

studious clerk continued his pursuit of classical and ecclesiastical literature, and at the same time set himself to correct the prevailing decay of morals and learning in the church, by founding a school in the locality for the purpose of instructing the youth in the study of grammar and humanity. Here, too, he appears for the first time to have definitely sided with the reforming party in the church and state, the sermons which he preached containing bold attacks on different Catholic tenets and practices. In 1538, P. took the degree of D.D.; and in 1544, after some minor changes, became master of Bene't College, Cambridge, which he ruled admirably. Three years later, he married Margaret Harlstone, the daughter of a Norfolkshire gentleman. It was probably about this time that he drew up his defence of the marriage of priests, entitled *De Conjugio Sacerdotum*. In 1552, he was presented by King Edward VI. to the canonry and prebend of Covingham, in the church of Lincoln. On the accession of Queen Mary, he refused to conform to the re-established order of things, and was (like many others of the new school of divines) deprived of his preferments, and even obliged to conceal himself. It does not appear, however, that he was eagerly sought after by the emissaries of Mary; for he was no fanatic or iconoclast, but, on the contrary, though sincerely attached to the common Protestant doctrines, very unwilling to disturb the framework of the church. P. spent at least some portion of his compulsory seclusion from public life in the enlargement of his *De Conjugio Sacerdotum*, and in translating the Psalms into English metre. The death of Mary, and the accession of Elizabeth, called him from that learned retirement of which he seems to have been sincerely fond. Sir Nicholas Bacon, now Lord-keeper of the Great Seal, and Sir William Cecil, Secretary of State, both old Cambridge friends, knew what a solid and sure judgment, what a moderate and equable spirit, and above all, what a thorough faculty for business, ecclesiastical and secular, P. had, and by their recommendation he was appointed, by the queen, archbishop of Canterbury. The consecration took place in Lambeth chapel, December 17, 1559.

'The subsequent history of Archbishop Parker,' it has been justly remarked, 'is that of the Church of England.' The difficulties that beset him were very great. Elizabeth herself was much addicted to various 'popish' practices, such as the idolatrous use of images, and was strongly, we might even say, violently, in favour of the celibacy of the clergy. She went so far as to insult P.'s wife on one occasion. But his greatest anxiety was in regard to the spirit of sectarian dissension within the bosom of the church itself. Already the germs of *puritanism* were beginning to spring up, and there can be no doubt that their growth was fostered by the despotic caprices of the queen. P. himself was manifestly convinced that if ever Protestantism was to be firmly established in the land at all, some definite ecclesiastical forms and methods must be sanctioned, to secure the triumph of order over anarchy, and so he vigorously set about the repression of what he thought a mutinous individualism incompatible with a catholic spirit. That he always acted wisely or well, cannot be affirmed; he was forced, by virtue of his very attitude, into intolerant and inquisitorial courses, and as he grew older, he grew harsher, the conservative spirit increasing with his years. To forbid 'prophesyings,' or meetings for religious discourse, was something very like persecution, though probably enough something very like treason to the church was talked in these pious conventicles.

Fuller (who must have his pun, however bad) says of him: 'He was a Parker indeed, careful to keep the fences.' Yet it must not be forgotten that it is to P. we owe the *Bishops' Bible*, undertaken at his request, carried on under his inspection, and published at his expense in 1568. He had also the principal share in drawing up the *Book of Common Prayer*, for which his skill in ancient liturgies peculiarly fitted him, and which strikingly bears the impress of his broad, moderate, and unsectarian intellect. It was under his presidency, too, that the *Thirty-nine Articles* were finally reviewed and subscribed by the clergy (1562). P. died May 17, 1575.

Among other literary performances, P. published an old *Saxon Homily on the Sacrament*, by Ælfric of St Albans, to prove that Transubstantiation was not the doctrine of the ancient English church; edited the histories of Matthew of Westminster and Matthew Paris (q. v.); and superintended the publication of a most valuable work, *De Antiquitate Britannicæ Ecclesiæ*, probably printed at Lambeth in 1572, where the archbishop, we are told, had an establishment of printers, engravers, and illuminators. He also founded the 'Society of Antiquaries,' and was its first president; endowed the university of Cambridge, and particularly his own college, with many fellowships and scholarships, and with a magnificent collection of MSS. relating to the civil and ecclesiastical condition of England, and belonging to nine different centuries (from the 8th to the 16th). Of this collection, Fuller said that it was 'the sun of English antiquity before it was eclipsed by that of Sir Robert Cotton.'

PARKER, THEODORE, an American clergyman and scholar, was born at Lexington, Massachusetts, August 24, 1810. His grandfather was captain of a militia company at the battle of Lexington, his father a farmer and mechanic, and his own boyhood was spent at the district school, on the farm, and in the workshop. At the age of 17, he taught a school, and earned money to enter Harvard College in 1830. During his collegiate course, he supported himself by teaching private classes and schools, and studied metaphysics, theology, Anglo-Saxon, Syriac, Arabic, Danish, Swedish, German, French, Spanish, and modern Greek. Entering the divinity class, at the end of his collegiate course, he commenced to preach in 1836, was an editor of the *Scriptural Interpreter*, and settled as Unitarian minister at West Roxbury in 1837. The naturalistic or rationalistic views which separated him from the more conservative portion of the Unitarians, first attracted wide notice, in consequence of an ordination sermon, in 1841, on *The Transient and Permanent in Christianity*. The contest which arose on the anti-supernaturalism of this discourse, led him to further develop his theological views in five lectures, delivered in Boston, and published (1841) under the title of *A Discourse of Matters Pertaining to Religion*, which was followed by *Sermons for the Times*. Failing health induced him to make an extended tour in Europe. In 1845, he returned to Boston, preached to large audiences at the Melodeon, and wrote for the *Dial*, *Christian Register*, *Christian Examiner*, and *Massachusetts Quarterly*. He became also a popular lecturer, and was active and earnest in opposition to slavery, the Mexican war, and the Fugitive Slave Law, for resisting which, by more than words, he was indicted. In the midst of his work, he was attacked, in 1859, with bleeding from the lungs, and made a voyage to Mexico, where he wrote his *Experiences as a Minister*, whence he sailed to Italy, where he died at Florence, May 10, 1860. His works, consisting chiefly of miscellanies,

lectures and sermons, have been collected and published in America and England, in which his peculiar views in theology and politics are sustained with great force of logic and felicity of illustration. His learning was as remarkable as his energy and philanthropy. His library of 13,000 volumes he bequeathed to the Boston Free Library. Few men of his time exerted a more powerful influence.

PARKHURST, JOHN, an English biblical scholar, the second son of John Parkhurst, Esq. of Catesby, in Northamptonshire, was born in June 1728, educated at Rugby and at Clare Hall, Cambridge, where he took his degree of M.A. in 1752, and in 1753 published *A Serious and Friendly Address to the Rev. John Wesley, in Relation to a Principal Doctrine advanced and maintained by him and his Assistants*. The doctrine assailed in P.'s pamphlet was the favourite Wesleyan doctrine of 'Assurance.' In 1762 appeared his principal work—indeed the only thing that has preserved his name—*A Hebrew and English Lexicon, without Points, adapted to the Use of Learners*. P. kept mending this Hebrew lexicon all his life. It was a very creditable performance for its time, and long continued to be the standard work on the subject among biblical students in this country; but it is disfigured by its fanciful etymologies, partly the result of his having (like many other divines of his time) adopted the irrational and presumptuous theories of Hutchinson (q. v.), and is now entirely superseded by the works of Gesenius, Ewald, and other critical scholars. P. also wrote a treatise (1787) against Dr Priestley, to prove the divinity and pre-existence of Jesus Christ. He died at Epsom, in Surrey, March 21, 1797.

PARKINSONIA, a genus of plants of the natural order *Leguminosæ*, suborder *Cæsalpinicæ*.—*P. aculeata* is a West Indian shrub or small tree, which, when in flower, is one of the most splendid objects in the vegetable kingdom. It has pinnated leaves, with winged leaf-stalk, and large yellow flowers spotted with red. It is furnished with strong spines, and is often used for hedges, whence it is called the Barbadoes Flower Fence. It is now common in India. The bark yields a beautiful white fibre, which, however, is not very strong; but it has been suggested that it might be found suitable for paper-making.

PARLEY, in Military Language, is an oral conference with the enemy. It takes place under a flag of truce, and usually at some spot—for the time neutral—between the lines of the two armies.

PARLIAMENT (Fr. *parlement*, from *parler*, to talk), the supreme legislature of the United Kingdom of Great Britain and Ireland. The word was first applied, according to Blackstone, to general assemblies of the states under Louis VII. in France about the middle of the 12th c.; but in that country it came eventually to be the designation of a body which performed certain administrative functions, but whose principal duties were those of a court of justice.

The origin of the Parliament of England has been traced to the Saxon great councils of the nation, called 'Wittena-gemote,' or meeting of wise men. These had, however, little in common with the parliaments of a later date: among other points of difference, they had a right to assemble when they pleased without royal warrant. Even under the Norman kings, the Great Council formed a judicial and ministerial as well as a legislative body, and it was only gradually that the judicial functions were transferred to courts of justice, and the ministerial to the privy council—a remnant of the judicial powers of parliament being still preserved

## PARLIAMENT.

in the appellate jurisdiction of the House of Lords. Under the Norman kings, the council of the sovereign consisted of the tenants-in-chief of the crown, who held their lands *per baroniam*, lay and ecclesiastic. It was the principle of the feudal system that every tenant should attend the court of his immediate superior; and he who held *per baroniam*, having no superior but the crown, was bound to attend his sovereign in the Great Council or Parliament. In the charter of King John, we for the first time trace the germ of a distinction between the peerage and the lesser nobility, the archbishops, bishops, abbots, earls, and greater barons being required to attend by a writ addressed to each, and the other tenants-in-chief by a general summons by the sheriffs and bailiffs. Baronial tenure originally made a man a baron or lord of parliament. When the offices or titles of Earl, Marquis, or Duke were bestowed on a baron, they were conferred by royal writ or patent, and at length barony came also to be conferred by writ instead of by tenure. During the 13th c., the smaller barons were allowed, instead of personally attending the national council, to appear by representatives; but the principle of representation seems first to have been reduced to a system when permission was also given to the municipalities, which, as corporations, were chief tenants of the crown, to appear by representatives. It is not quite clear when the division of parliament into two Houses took place; but when the representatives of the minor barons were joined by those of the municipalities, the term Commons was applied to both. The Lower House was early allowed to deal exclusively with questions of supply; and seems, in the reign of Richard II., to have established the right to assign the supplies to their proper uses. As the Commons became more powerful, they came to insist on the crown redressing their grievances before they would vote the supplies. The influence of parliament was on the increase during the Tudor period, while the reign of the Stewarts was characterised by a struggle for supremacy between the parliament and the crown, each striving to acquire the control of the military force of the country. The powers of the different estates came to be more sharply defined at the Revolution of 1688. Nineteen years later, on the Union with Scotland, the Parliament of England was merged into that of Great Britain.

In its early history, prior to the War of Independence, the Parliament of Scotland had probably not been very unlike that of England; it assembled without warrant, and consisted of bishops, earls, priors, abbots, and barons. At the close of the 13th c., the constitutional history of Scotland diverges from that of England. The addition of the burghs to the national council seems to date from the beginning of the 14th c., but it was not till much later that the lesser barons began to be exempted from attendance. The first act excusing them belongs to the reign of James I., and allows them to choose representatives called Speakers, two for each county, excepting some small counties, which were to have but one, the expenses of the representatives being defrayed by the constituency. The Scottish Parliament was never, like the English, divided into two Houses; all sat in one hall, and though it consisted of three estates, a general numerical majority of members was considered sufficient to carry a measure. The greater part of the business was transacted by the Lords of the Articles, a committee named by the parliament at the beginning of each session, to consider what measures should be passed; and whatever they recommended was generally passed without discussion. It was never held indispensable that the parliament should be summoned

by the crown, and it has even been thought that the royal assent to the measures carried was not absolutely essential. The parliament which carried the Reformation had no royal sanction. The Union was adjusted by commissioners for each country selected by the crown, and passed first, after strong and protracted opposition, in Scotland, and afterwards more easily in England.

By the act of union with Ireland in 1800 (Act 39 and 40 Geo. III. c. 67), the Irish Parliament was united with that of Great Britain as the Parliament of the United Kingdom of Great Britain and Ireland. The Parliament of Ireland had been originally formed on the model of that of England about the close of the 13th c., but it was merely the very small portion of Ireland occupied by the English settlers that was represented, which, as late as the time of Henry VII., hardly extended beyond the counties of Dublin, Louth, Kildare, and Meath, and constituted what was called the Pale. It was only for the last few years of its existence that the Irish Parliament was a supreme legislature; the English Parliament having, down to 1783, had power to legislate for Ireland. By one of the provisions of Poyning's Act, passed in 1495, no legislative proposals could be made to the Irish Parliament until they had received the sanction of the king and council in England. Act 23 Geo. III. c. 28 gave the Irish Parliament exclusive authority to legislate for Ireland, and the abuse of this power so obstructed the machinery of government, as to render the Union of 1800 matter of necessity.

The power of parliament is, according to Sir Edward Coke, so transcendent and absolute, that it cannot be confined either for persons or causes within any bounds. All remedies which transcend the ordinary courts of law are within its reach. It can alter the succession to the throne, the constitution of the kingdom, and the constitution of parliament itself. It has its own law, to be learned from the rolls and records of parliament, and by precedents and experience. One of the most thoroughly established maxims of this law is, that whatever question arises concerning either House of Parliament ought to be discussed and adjudged there, and not elsewhere. The House of Lords will not allow the Commons to interfere in a question regarding an election of a Scotch or Irish peer; the Commons will not allow the Lords to judge of the validity of the election of a member of their House, nor will either House permit courts of law to examine such cases. The authority of parliament extends to British colonies and foreign possessions. In the ordinary course of government, however, parliament does not make laws for the colonies. For some the Queen in Council legislates; others have legislatures of their own, which propound laws for their internal government, subject to the approbation of the Queen in Council; but these may be repealed and amended by parliament.

The constituent parts of parliament are the sovereign, the House of Lords, and the House of Commons. In the sovereign is vested the whole executive power; the crown is also the fountain of justice, from whence the whole judicial authority flows. To the crown is entrusted the permanent duty of government, to be fulfilled in accordance with the law of the realm, and by the advice of ministers responsible to parliament. The sovereign is also invested with the character of the representation of the majesty of the state. The sovereign's share in the legislature includes the summoning, proroguing, and dissolving of parliament. Parliament can only assemble by act of the sovereign; in but two instances have the Lords and Commons met of their own authority—viz., previously to the



## PARLIAMENT.

Restoration of Charles II., and at the Convention Parliament summoned at the Revolution of 1688; and in both instances it was considered necessary afterwards to pass an act declaring the parliament to be a legal one. Though the queen may determine the period for assembling parliament, her prerogative is restrained within certain limits. She is bound by statute (16 Chas. II. c. 1; and 6 and 7 Will. and Mary c. 2) to issue writs within three years after the determination of a parliament; and the practice of voting money for the public service by annual enactments, renders it compulsory for the sovereign to meet parliament every year. Act 43 Geo. III. c. 90 provides that the sovereign shall assemble parliament within fourteen days, whenever the militia shall be drawn out and embodied in case of apprehended invasion and rebellion; and a similar proviso is inserted in Act 15 and 16 Vict. c. 50, in case the present militia force should be raised to 120,000 men, and embodied. The royal assent is necessary before any measure can pass into law. The crown, as the executive power, is charged with the management of the revenues of the state, and with all payments for the public service; it is therefore the crown that makes known to the Commons the pecuniary necessities of the government, without which no supplies can be granted. The sovereign's prerogative also includes the sending and receiving of ambassadors, entering into treaty with foreign powers, and declaring war or peace. All the kings and queens since the Revolution have taken an oath at their coronation 'to govern according to the statutes in parliament agreed on, and the laws and customs of the same.' The sovereign is further bound to an adherence to the Protestant faith, and the maintenance of the Protestant religion as established by law. By the Bill of Rights (1 Will. and Mary c. 2, s. 6), and the Act of Settlement (12 and 13 Will. III. c. 2, s. 2) a person professing the popish religion, or marrying a papist, is incapable of inheriting the crown, and the people are absolved from their allegiance. This exclusion is further confirmed by the Act of Union with Scotland; and in addition to the coronation oath, every king or queen is required to take the declaration against the doctrines of the Roman Catholic Church prescribed by 30 Chas. II. c. 2, either on the throne in the House of Lords in the presence of both Houses, at the first meeting of the first parliament after the accession, or at the coronation, whichever event shall first happen. The sovereign is bound by similar sanctions to maintain the Protestant religion and Presbyterian church government in Scotland.

The province of the Houses of Parliament is to legislate with the crown, to provide supplies, to exercise a supervision over the ministers of the crown and all other functionaries, and to advise the sovereign on matters of public moment. The Upper House, from its hereditary and aristocratic character, is a check on the popular branch of the legislature and on hasty legislation.

The House of Lords may originate legislative measures of all kinds, except money-bills. Acts of grace and all bills affecting the rights of the peers necessarily originate in this House. In its judicial capacity, it forms a court for the trial of causes on appeal from the Court of Chancery, on writs of error to review judgments in the Queen's Bench, and on appeal from the Court of Session. It has a judicature in claims of peerage and offices of honour under reference from the crown. Since the union with Scotland and Ireland, it has had the power of deciding controverted elections of representative peers. It tries such offenders as are impeached by the House of Commons, and members of its own

body on indictment found by a grand jury. The House of Lords is composed of lords spiritual and temporal. According to a declaration of the House in 1672, the lords spiritual are only lords of parliament and not peers, a distinction which seems not to have been known in ancient times. They consist of 2 archbishops and 24 bishops for England, who are said to have seats in virtue of their temporal baronies; and 4 Irish bishops, who represent the clergy of Ireland, according to a rotation established at the Union of 1800. The Bishop of Sodor and Man has no seat in parliament, and on Manchester being made a see in 1847, it was arranged that one other bishop should be in the same position, according to a rotation not including the bishops of London, Durham, and Winchester, so as not to increase the number of the lords spiritual. The lords temporal consist of—1. The peers of England, of Great Britain, and of the United Kingdom, of whom there are at present 23 dukes (3 of whom are royal dukes), 19 marquises, 110 earls, 22 viscounts, and 209 barons. The number of the peers of the United Kingdom may be increased without limit by new creations at the pleasure of the sovereign. 2. Sixteen representatives chosen from their own body by the peers of Scotland for each parliament. As no provision was made at the Union for any subsequent creation of Scottish peers, the peerage of Scotland consists exclusively of the descendants of peers existing before the Union. By order of the House of Lords, an authentic list of the Scottish peers was entered on the roll of peers on 12th February 1708, to which all claims since established have been added; and in order to prevent the assumption of dormant and extinct peerages by persons not having right to them, statute 10 and 11 Vict. c. 52, provides that no title standing in the roll, in right of which no vote has been given since 1800, shall be called over at an election without an order of the House of Lords. A representative peer ceases to be one of the representatives on being created a peer of the United Kingdom. 3. Twenty-eight representatives of the Irish peerage, elected for life. For an account of the different degrees of the peerage, and of those privileges of the peers that are unconnected with their position as members of parliament, see NOBILITY. All peerages are now hereditary. Life peerages were in early times not unknown to the constitution; but in 1856, her Majesty having created Sir James Parke, Baron Wensleydale for and during the term of his natural life, the House of Lords, on the report of a Committee of Privileges, decided that the grantee could not sit or vote in parliament. Lord Wensleydale therefore did not offer to take the oaths, and was soon afterwards created a hereditary baron. The lords are entitled to have the attendance in their House of the judges of the Courts of Queen's Bench and Common Pleas, and such of the Barons of Exchequer as are of the degree of the coif, or have been made serjeants-at-law; as also of the Queen's Counsel being serjeants. The votes of spiritual and temporal lords are intermixed, and the joint majority determine every question; but they sit apart on separate benches—the place assigned to the lords spiritual being the upper part of the House on the right hand of the throne. A lord may, by license from the sovereign, appoint another lord as his proxy to vote for him in his absence; but a lord spiritual can only be proxy for a lord spiritual, and a lord temporal for a lord temporal, and no member of the House can hold more than two proxies at the same time. Proxies cannot vote in judicial questions. Peerages are lost by attainder for high treason. Neither the issue of the body of the person attainted, nor, on their failure,

PARLIAMENT.

the descendants of the person first called to the dignity, will be admitted to it without a removal of the attainder. But where the attained person is tenant in tail-male with a remainder in tail-male to another, the dignity becomes vested in the remainder man on failure of the issue of the person attained. A peerage, whether by patent or writ, is forfeited by attainder for high treason; attainder for felony forfeits a peerage by writ, not one by patent. An attained peerage cannot be restored by the crown, only by an act of parliament.

The House of Commons, besides its general power to introduce legislative measures, has the sole right to originate bills levying taxes, or affecting the public income and expenditure, and to examine into the validity of elections to its own body. The question whether it has any control over the rights of electors was the subject of a memorable contest between the Lords and Commons in 1704, in the cases of Ashby and White, and of the 'Aylesbury men' (*Hatsell's Precedents*, vol. iii.), a contest ended by the queen proroguing parliament. When inquiring into the conflicting claims of candidates for seats in parliament, the Commons have an undoubted power to determine whether electors have the right to vote. The House of Commons has the right to expel or commit to prison its own members, and to commit other persons who offend by breach of its privileges, contempt of its authority, disobedience of its orders, or invasion of its rights; but this power is limited to the duration of the session. Expulsion does not, however, create any disability to serve again in parliament: a resolution passed in 1769, to exclude Mr Wilkes, duly elected for Middlesex, on the ground of his having been previously expelled for a seditious libel, was proved to be illegal and expunged from the Journals of the House in 1782. The House of Commons has also the power of impeaching offenders, who, however, are tried at the bar of the House of Lords.

The number of members of the House of Commons has varied greatly at different times. In the reign of Edward I., it seems to have been 275; in that of Edward III., 250; and of Henry VI., 300. In the reign of Henry VIII., 27 members were added for Wales, and 4 for the county and city of Chester; 4 were added for the county and city of Durham in the reign of Charles II. Between the reign of Henry VIII. and that of Charles II., 180 new members were added by the granting of royal charters to boroughs which had not previously returned representatives. Forty-five members were assigned as her proportion to Scotland at the Union, and 100 to Ireland, making the whole number of members of the Parliament of the United Kingdom 658—a number which was retained unaltered amid the changes effected by the reform of 1832. Two towns in England, Sudbury and St Albans, have since been disfranchised for bribery, and the 4 vacant seats bestowed, two on Yorkshire, one on Lancashire, and the third on the new borough of Birkenhead. The Reform Act, 2 Will. IV. c. 45 for England, 2 and 3 Will. IV. c. 65 (amended by 4 and 5 Will. IV. c. 88, and 5 and 6 Will. IV. c. 78) for Scotland, and 2 and 3 Will. IV. c. 88 for Ireland, remodelled the whole electoral system of the United Kingdom. Fifty-six boroughs in England and Wales were entirely disfranchised; 30 which had previously returned two members were restricted to one; while 42 new boroughs were created, of which 22 were each to return two members, and 20 a single member. Several small burghs in Wales were united to elect one member. Four members were assigned to the city of London, 2 to each of the universities of Oxford and Cambridge, and one to 133 cities

and boroughs. Of counties, one, Lancaster, has 5 members; 25 counties and the West Riding of York, 4; 7 counties have 3 members each; 9 counties, and the East Riding and North Riding of York, 2 members; and 10 counties have 1 member each. The Scotch Reform Act increased the number of members for Scotland from 45 to 53, 30 being county and 23 burgh members, some of the latter representing several combined burghs. By the Irish Reform Act the number of members for Ireland was increased from 100 to 105, 64 representing counties, 34 cities and boroughs, and 2 the University of Dublin. At present, the number of members of the House is 658, who are thus distributed:

	Counties.	Boroughs.	Universities.	Total.
England and Wales,	162	334	4	500
Scotland,	30	23		53
Ireland,	64	39	2	105
	256	396	6	658

In England, the former county franchise had been founded exclusively on the holding of freehold property for life of the clear yearly value of 40s., without respect to occupancy; and persons so qualified at the passing of the Reform Act retain their franchise so long as they continue seized of the same freehold. The necessary qualification is now either—1. A freehold of inheritance of the clear yearly value of 40s. 2. A freehold for life of the same value, if in the *bonâ fide* occupancy of the party claiming to vote, or acquired by marriage, marriage-settlement, devise, or promotion to any benefice or office. If the freeholder for life is not in actual occupancy, or shall have acquired his estate otherwise than in the mode above mentioned, his freehold must be of the clear yearly value of £10. 3. Property not freehold, of inheritance or for life, of the clear annual value of £10. 4. Leasehold of the clear yearly value of £10, if the term was originally not less than 60 years; and of the clear yearly value of £50, if the term was originally not less than 20 years. 5. Occupancy of lands or tenements for which the tenant pays a yearly rent of £50. In boroughs, the old qualification varied much according to local usage. Non-residence was generally no disqualification. Freemen and burgesses, and liverymen in London possessed the franchise. Freeholders to the extent of 40s. had votes in such towns as formed counties in themselves; elsewhere, leaseholders, copyholders, and burghage tenants were admitted. By the remodelled system, the franchise is based chiefly on inhabitancy of premises of the yearly value of £10, former franchises possessed by freeholders and burghage tenants being to a certain extent retained, with a qualification of six months' previous residence. If a person have property which would qualify him as a borough elector, he cannot, instead of becoming a borough elector, choose in respect of that property to qualify as a county elector. In Scotland, the old county qualification consisted in being infeft in lands or superiorities holding directly of the crown of 40s. old extent (see VALUATION), or £400 Scots valued rent; and persons in possession of this franchise before 1831 continued to retain it. The reformed county constituency consists of proprietors of lands and other heritable subjects of the yearly value of £10, tenants whether in occupancy or not, under a long lease where the tenant's interest is £10 yearly, or under a 19 years' lease, where his interest is £50 (sub-tenants must be in occupancy); and tenants in occupancy, paying a yearly rent of £50, or who have paid a grassum of £300. The Scottish burghal franchise was, by the old system, vested in the

members of the town-council and their delegates. A £10 qualification, either as occupant or as proprietor, was substituted by the Reform Act, residence within seven miles of the borough being made necessary in the case of proprietors. By the Irish Reform Act, various classes of freeholders were invested with the county franchise, to whom were added, by 13 and 14 Vict. c. 69, occupiers of land rated for the poor-rate at a net annual value of £12, and persons entitled to estates in fee, or in tail, or for life, of the rated value of £5. The Irish borough qualification introduced by the Reform Act was nearly the same as the English, but the above-mentioned statute of Victoria has added to the constituency the occupiers of lands and premises rated at £8. Certain disqualifications exist from exercising the franchise on the grounds of infamy, alienage, conviction of felony, and the holding of government offices. Peers cannot vote. In the universities of Cambridge and Oxford, the constituency consists of the doctors and masters of arts; and in Dublin, of the fellows, scholars, and graduates of Trinity College.

The several Reform Acts introduced a system of registration of voters for the three divisions of the United Kingdom. In England, lists of voters are prepared by the overseers of each parish, and on certain days courts are held by barristers appointed by the chief justice and the senior judge of each summer circuit to revise these lists, when claims may be made for persons omitted, and objections offered to names standing on the list. If an objection be sustained, the name is struck off the list, there being an appeal from the decision of the revising barrister to the Court of Common Pleas. In Scotland, a register of persons entitled to vote is made up annually in counties and boroughs in terms of the Registration of Voters (Scotland) Act, 24 and 25 Vict. c. 23, which register is printed, and may be had for a small price from the officers charged with making up the roll. By this arrangement, persons eligible as voters are put on the roll without trouble to themselves, and, in point of fact, without their consent. Enrolment, however, may be challenged, in which case objections are heard and determined by the sheriffs. The registration system of Ireland introduced by the Reform Act resembles that of England; and by 16 and 17 Vict. c. 58, provision is made for the annual revision of the list of voters for the city of Dublin.

A property qualification, of £600 a year in candidates for counties, and £300 in candidates for boroughs, which had previously existed in England and Ireland, was left untouched in 1831, but has been abolished by 21 and 22 Vict. c. 26. Scotch peers, though not representative peers, are disqualified from sitting in the House of Commons. Irish peers may represent any constituency in Great Britain, but not in Ireland. A disqualification is also attached to judges (except the Master of the Rolls), clergymen of the Established Church of any of the three kingdoms, Roman Catholic priests, revenue officers, persons convicted of treason and felony, and aliens even when naturalised, unless the right have been conceded in express terms. Sheriffs cannot sit for their own counties, and government contractors are disqualified by 22 Geo. III. c. 45, and 41 Geo. III. c. 52, a disqualification which does not extend to contractors for government loans. A member becoming bankrupt is incapacitated from sitting or voting.

When a new parliament has to be assembled, the Lord Chancellor, by order of the sovereign, directs the Clerk of the Crown to prepare and issue, under the Great Seal, writs to the sheriffs of counties, both for the counties and the boroughs. A sheriff, on

receiving the writ for a county, appoints a day for the election, and on the day fixed proclaims the writ. If no more candidates are then proposed than are to be elected, he declares them duly elected; if there is opposition, a show of hands is asked, and the sheriff declares who has the majority. If a poll is demanded by the opposite party, the election is adjourned. Each county is divided into districts, with a polling-place in each, at which the electors vote; and at the termination of the poll, the return is transmitted to the sheriff, who proclaims the successful candidate. In borough elections in England and Ireland, the sheriff, on receiving the writ, issues his precept to the returning officer of the municipality, who superintends the election; in Scotland, the sheriff himself superintends the borough as well as the county elections. The names of the persons elected both in counties and boroughs are returned by the sheriff to the Clerk of the Crown. Vacancies occurring after a general election are supplied by new writs issued by authority of the House. When it is determined that a writ should be amended, the Clerk of the Crown is ordered to attend the House, and amend it accordingly.

A member of the House of Commons cannot, in theory, resign his seat; but on the acceptance of any office of profit under the crown, his election is, by an act of Queen Anne, declared void, and a new writ issues, he being, however, eligible for re-election. See CHILTERN HUNDREDS. The resignation of office is held not to be complete until the appointment of a successor; and on the resumption of office, the seat is held not to have been vacated. A first commission in the army or navy vacates a seat; subsequent commissions do not do so.

*Privilege.*—Both Houses of Parliament possess extensive privileges for the maintenance of their authority and the protection of individual members. Some of these privileges have well-defined limits; others are so vague in their extent as occasionally to lead to conflicts between parliament and the courts of law. The privilege of speech is claimed of the sovereign by the Speaker of the House of Commons at the opening of every new parliament. At the same time, any member using offensive expressions may be called to the bar to receive a reprimand from the Speaker; or, if the offence be grave, may be committed for contempt, in which case he is sent either to the Tower or to Newgate. Persons not members of the House may also be committed for breach of privilege, and no one committed for contempt can be admitted to bail, nor can the cause of commitment be inquired into by the courts of law. The publication of the debates of either House has repeatedly been declared a breach of privilege; but for a long time back this privilege has been practically waived, except where the reports are false and perverted. Publication of the evidence before a select committee previously to its being reported is punished as a breach of privilege. Libellous reflections on the character and proceedings of parliament or of members of the House come under the same category, as also does assaulting or threatening a member. Wilful disobedience to the orders of the House is punishable as a breach of privilege; but if orders be given beyond the jurisdiction of the House, their enforcement may be questioned in a court of law. The offer of a bribe to, or its acceptance by a member is a breach of privilege; so also is any interference with the officers of the House in the execution of their duty, or tampering with witnesses who are to be examined before the House or a committee of the House. Members of both Houses are free from arrest or imprisonment in civil matters, a privilege

## PARLIAMENT.

which is permanent in the case of peers, extending also to peeresses, whether by creation or marriage (though the latter lose it by subsequently marrying a commoner), and to peers and peeresses of Scotland and Ireland, whether representative or not. It continues in the case of members of the House of Commons during the sitting of parliament, for 40 days after each prorogation, for 40 days prior to the day to which parliament is prorogued, and for a reasonable time after a dissolution. Witnesses summoned to attend before parliament or parliamentary committees, and other persons in attendance on the business of parliament, are also protected from arrest. Protection is not claimable from arrest for any indictable offence. Counsel are protected for any statements that they may make professionally.

*Meeting of a New Parliament.*—On the day appointed for the meeting of a new parliament, the members of the two Houses assemble in their respective chambers. In the Lords, the Lord Chancellor acquaints the House that 'her Majesty, not thinking it fit to be personally present here this day, had been pleased to cause a Commission to be issued under the Great Seal, in order to the opening and holding of the parliament.' The Lords Commissioners, being in their robes, and seated between the throne and woolsack, then command the Gentleman Usher of the Black Rod to let the Commons know that the 'Lords Commissioners desire their immediate attendance in this House to hear the Commission read.' Meantime, in the Lower House, the Clerk of the Crown in Chancery has delivered to the Clerk of the House a list of the members returned to serve; and on receiving the message from Black Rod, the Commons go up to the House of Lords. The commission having been read in presence of the members of both Houses, the Lord Chancellor opens the parliament by stating 'that her Majesty will, as soon as the members of both Houses shall be sworn, declare the causes of her calling this parliament; and it being necessary that a Speaker of the House of Commons should first be chosen, that you, gentlemen of the House of Commons, repair to the place where you are to sit, and there proceed to the appointment of some proper person as your Speaker, and that you present such person whom you shall so choose here to-morrow at o'clock, for her Majesty's royal approbation.' The Commons immediately withdraw, and, returning to their own House, proceed to elect a Speaker.

Till a Speaker be elected, the clerk acts as Speaker, standing and pointing to members as they rise to speak, and then sitting down. If only one candidate be proposed for the office, the motion, after being seconded, is supported by an influential member, generally the leader of the House of Commons; and the member proposed, having expressed his sense of the honour meant to be conferred on him, is called by the House to the chair, to which he is led by his proposer and seconder. If another member be proposed and seconded, a debate ensues; and at its close, the clerk puts the question, that the member first proposed 'do take the chair of the House as Speaker.' If the House divide, he directs one party to go into the right lobby, and the other into the left, and appoints two tellers for each. If the majority be in favour of the member first proposed, he is led to the chair; if not, a similar question being put regarding the other member and answered in the affirmative, he is conducted to the chair. The Speaker-elect expresses his thanks for the honour conferred on him, and takes his seat; on which, the mace is laid on the table, where it is always placed during the sitting of the House with

the Speaker in the chair. He is then congratulated by some leading member, and the House adjourns. The next day, the Speaker-elect, on the arrival of Black Rod, proceeds with the Commons to the House of Lords, where his election is approved by the Lord Chancellor. He then lays claim, on behalf of the Commons, to their ancient rights and privileges, which, being confirmed, he retires with the Commons from the bar. Nearly the same forms are observed on the election of a new Speaker, when a vacancy occurs by death or resignation in the course of the session.

The members of both Houses then take the oath prescribed by law, a proceeding which occupies several days. See OATH; ABJURATION. In the Upper House, the Lord Chancellor first takes the oath singly at the table. The Clerk of the Crown delivers a certificate of the return of the Scottish representative peers, and Garter King-at-arms the roll of the lords temporal, after which the lords present take and subscribe the oath. Peers who have been newly created by letters-patent present their patents to the Lord Chancellor, are introduced in their robes between two other peers of their own dignity, preceded by Black Rod and Garter, and conducted to their places. The same ceremony is observed in the case of peers who have received a writ of summons—a formality necessary when a member of the Lower House succeeds to a peerage; otherwise, his seat does not become vacant. A bishop is introduced by two other bishops, without the formalities observed with temporal lords. Representative bishops of Ireland take their seats without any particular ceremony. Peers by descent have a right to take their seats without introduction; peers by special limitation in remainder have to be introduced. In the Commons, the Speaker first subscribes the oath, standing on the upper step of the chair, and is followed by the other members. Members on taking the oath are introduced by the Clerk of the House to the Speaker. Members returned on new writs in the course of the session, after taking the oath, are introduced between two members. They must bring a certificate of their return from the Clerk of the Crown. The oaths are required to be taken in a full House, with the Speaker in the chair—in the Commons, between the hours of nine and four. The presence of a Commission constitutes a full House. In the Upper House, the oaths may, by 6 and 7 Vict. c. 6, be taken till 5 o'clock. On the demise of the crown, the oaths must be taken anew in both Houses.

When the greater part of the members of both Houses have been sworn, the causes of calling the parliament are declared by the sovereign either in person or by commission. In the former case, the Queen proceeds in state to the House of Lords, and commands Black Rod to let the Commons know 'that it is her Majesty's pleasure that they attend her immediately in this House.' Black Rod proceeds to the House of Commons, and formally commands their attendance, on which the Speaker and the Commons go up to the bar of the House of Lords, and the queen reads her speech, which is delivered to her by the Lord Chancellor kneeling on one knee. When parliament is opened by commission, the sovereign not being personally present, the Lord Chancellor reads the royal speech to both Houses. Immediately after the royal speech is read, the House is adjourned during pleasure; but both Houses are resumed in the afternoon, for the purpose of voting an address in answer to the speech from the throne. In each House, it is common to begin business by reading some bill *pro forma*, in order to assert the right of deliberating without

## PARLIAMENT.

reference to the immediate cause of summons. The royal speech is then read, and an address moved in answer to it. Two members in each House are chosen by the ministry to move and second the address. The preparation of the address is referred to a select committee; it is twice read, may be amended, and when finally agreed on, it is ordered to be presented to her Majesty.

*Adjournment, Prorogation, and Dissolution.*—Adjournment of parliament is but the continuance of the session from one day to another. Either House may adjourn separately on its own authority, with this restriction, introduced by Act 39 and 40 Geo. III. c. 14, that the sovereign, with advice of the privy council, may issue a proclamation appointing parliament to meet within not less than 14 days, notwithstanding an adjournment beyond that period. On reassembling, the House can again take up business which was left unfinished. A prorogation differs from an adjournment in this respect, that it not merely suspends all business, but quashes all proceedings pending at the time, except impeachments by the Commons, and Appeals and Writs of Error in the Lords. William III. prorogued parliament from 21st October to 23d October 1689, in order to renew the Bill of Rights, regarding which a difference had arisen between the two Houses that was fatal to its progress. It being a rule that a bill of the same substance cannot be introduced twice in the same session, a prorogation has sometimes been resorted to, to enable a second bill to be brought in. Parliament can only be prorogued, as already mentioned, by the sovereign; the royal authority is signified either by the Lord Chancellor, or by writ under the great seal, or by a commission from the crown. When parliament stands prorogued to a certain day, the sovereign is empowered by 37 Geo. III. c. 127 to issue a proclamation, giving notice that parliament is to meet on some other day, not less than 14 days distant, to which day parliament then stands prorogued. At the beginning of a new parliament, when it is not intended that it should meet for the despatch of business, it is usually prorogued by a writ of prorogation read by the Lord Chancellor in the House of Lords. A proclamation is issued prior to the prorogation; and when it is intended that parliament shall meet on the day to which it is prorogued for the despatch of business, the proclamation states that parliament will then assemble and be holden for the despatch of divers urgent and important affairs.

Parliament comes to an end by Dissolution, which is its civil death. This dissolution may be by the will of the sovereign, expressed in person or by her representatives. Having been first prorogued, it is dissolved by a royal proclamation under the great seal, and by the same instrument it is declared that the chancellor of Great Britain and chancellor of Ireland have been respectively ordered to issue out writs for calling a new parliament. These writs are immediately issued, and the period to be fixed by the crown for the assembling of the new parliament, formerly 40 days, was by 7 and 8 William IV. reduced to 35 days. At common law, parliament is *ipso facto* dissolved by the demise of the crown; but, by Act 6 Anne, c. 7, it is continued for six months after the demise, unless sooner dissolved by the successor. The same act requires parliament to assemble immediately on the demise of the crown, notwithstanding adjournment or prorogation; and it is provided that in case no parliament is in being at that time, the last preceding parliament shall meet and be a parliament. By Act 37 Geo. III. c. 127, a parliament so revived continues in existence only for six months, if not sooner dissolved. Were the power of

dissolving the parliament not vested in the executive, there would be a danger of its becoming permanent, and encroaching on the royal authority, so as to destroy the balance of the constitution. An example of this danger is shewn in the Long Parliament, to which Charles I. conceded that it should not be dissolved till such time as it dissolved itself. If the Houses of Parliament encroach on the executive, or act factiously or injudiciously, the crown may, by a dissolution, bring their proceedings to an end, and appeal to the people by sending the members of the House of Commons to give an account of their conduct to their constituents.

There was originally no limit to the duration of a parliament except the will of the sovereign. By 6 Will. and Mary, c. 2, the continuance of a parliament was limited to three years, a term afterwards extended by 1 Geo. I. c. 38, to seven years. The same act of William and Mary enacts that parliament shall assemble once in three years at the least; but the practice of granting the Mutiny Act and the Budget for a year only, makes it necessary that it should assemble annually.

*Conduct of Business.*—Each House is presided over by its Speaker. The Speaker of the House of Commons does not take part in a debate, offer his opinion, or vote on ordinary occasions; but, in case of equality, he has a casting vote: his duty is to decide all questions which relate to order, putting the matter at issue in a substantive form for the decision of the House, if his own decision is not assented to. He explains any doubts that may arise on bills. He determines the precedence of members rising to address the House. He examines witnesses at the bar. At the close of the session, he addresses the sovereign on presenting the money-bills passed during the session for the royal assent. He nominates the tellers on a division, and makes known the votes to the House. He may commit members to custody during the pleasure of the House, a confinement which terminates with the close of the session. When a vacancy occurs by death, he signs the warrant to the Clerk of the Crown to make out the writ for the election of a new member. He audits the accounts of the receiver of fees, and directs the printing of the votes and proceedings of the House. The Lord Chancellor, or Lord Keeper of the Great Seal, is the Speaker of the House of Lords; in his absence, the Chairman of the Committee of Ways and Means takes the chair. The Speaker is not, as in the Lower House, charged with the maintenance of order, or the decision who is to be heard, which rest with the House itself. The Chairman of the Committee of Ways and Means of the House of Commons as Deputy-speaker, performs the Speaker's duties in his absence. The chief officers of the House of Lords are the Clerk of the Parliaments, who takes minutes of the proceedings of the House; the Gentleman Usher of the Black Rod, who, with his deputy, the Yeoman Usher, is sent to desire the attendance of the Commons, executes orders for committal, and assists in various ceremonies; the Clerk-assistant; and the Sergeant-at-arms, who attends the Lord Chancellor with the mace, and executes the orders of the House for the attachment of delinquents. The chief officers of the Commons are the Clerk of the House, the Sergeant-at-arms, the Clerk-assistant, and Second Clerk-assistant.

Each House has its *Standing Orders*, or regulations, adopted at different periods, relating partly to internal order, partly to certain preliminaries required in the introduction of bills and promulgation of statutes. A standing order endures till repealed (or 'vacated,' as it is called in the Upper House); but each House is also in the practice of agreeing to certain orders or *resolutions* of uncertain

duration declaratory of its practice, which are considered less formally binding than standing orders.

The House of Lords usually meets at 5 P.M.; the Commons at a quarter before 4, except on Wednesdays and some other days specially appointed, when the hours of sitting are from 12 to 6. In the Lords, the Chancellor, as Speaker, sits on the woolsack. A standing order, which is never enforced, requires the Lords to take place according to precedence. Practically, the bishops sit together on the right hand of the throne; the members of the administration on the front bench on the right hand of the woolsack adjoining the bishops, and the peers who usually vote with them occupy the other benches on that side. The peers in opposition are ranged on the opposite side, and those considered politically neutral occupy the cross benches between the table and the bar. In the House of Commons, the front bench on the right hand of the chair is reserved for the ministry, and called the Treasury Bench, the front bench on the opposite side being occupied by the leaders of the opposition. By ancient custom and orders of both Houses, rarely enforced, strangers are excluded while the Houses are sitting.

Prayers are read before business is begun—in the House of Lords by a bishop; in the House of Commons by the chaplain. Every member is bound to attend the House—in the Lower House, personally; in the Upper personally, or by proxy; but in ordinary circumstances, this obligation is not enforced. The House of Lords may proceed to business when three peers are present; in the Commons, forty members are required to constitute a House for the despatch of business. The Speaker counts the House at four; and if that number be not then present, or if it be noticed, or appear on a division, that fewer than forty members are present, the House is adjourned. A call of the House is an expedient to secure attendance on important occasions; when it is made, members absent without leave may be ordered to be taken into custody. When matters of great interest are to be debated in the Upper House, the Lords are 'summoned.'

To make a motion, or, more properly, to *move the House*, is to propose a question, and notices of motions should be given on a previous day. The Commons are in the practice of setting apart Mondays, Wednesdays, Thursdays, and Fridays for considering *orders of the day*, or matters which the House had already agreed to consider on a particular day, and to reserve Tuesdays for motions. Government orders take precedence of others on all order days except Wednesdays, which are generally reserved for the orders of independent members. Notices of motions are by a standing order not allowed to be given for any period beyond the four days next following on which motions are entitled to precedence. Questions of privilege may be considered without previous notices, and take precedence both of other motions and orders of the day. A motion may be accompanied by a speech, and must in the Lower House be seconded, otherwise there is no question before the House. In purely formal motions this rule is not observed, and an order of the day may be moved without a seconder. A seconder is not required in the House of Lords. A motion in the Commons must be reduced to writing by the mover, and delivered to the Speaker, who, when it has been seconded, puts it to the House; it cannot then be withdrawn without leave of the House. In the Lords, when a motion has been made, a question is proposed 'that the motion be agreed to.' When an amendment is proposed to a question, the original motion cannot be withdrawn till the amendment has been either withdrawn or negatived.

An amendment is properly such an alteration on a motion by striking out or adding words, or both, as may enable members to vote for it who would not have done so otherwise.

A question may be evaded or superseded in four ways: 1. By adjournment. Any member in possession of the House may move 'that the House do now adjourn.' The House may also be adjourned, even while a member is speaking, on its being noticed that there are fewer than forty members present. The motion, 'that the debate be now adjourned,' does not supersede the question, but merely defers the decision of the House. 2. By a motion, that the orders of the day be now read, which may be put and carried on days on which notices of motion have precedence. 3. By what is called *moving the previous question*. The act of the Speaker in putting the question is intercepted by a motion, 'that the question be now put.' The mover and seconder of this motion vote against it; and if it be resolved in the negative, the Speaker is prevented from putting the main question, which, however, may be brought forward on another day. 4. By an amendment substituting words of an entirely different import for those of the motion, so that the sense of the House is taken on a totally different question.

When the question is put by the Speaker in the Lords, the respective parties exclaim 'content' or 'non-content'; in the Commons, the expression used is 'aye' or 'no.' The Speaker signifies his opinion which party have the majority, and if the House acquiesce, the question is said to be resolved in the affirmative or negative; when his decision is disputed, the numbers must be counted by a division. Both Houses now divide by the content or ayes going into the right lobby, and the non-contents or noes into the left, each being counted by tellers appointed by the Speaker. In the House of Commons, two clerks with printed lists of the members put a mark to the name of each as he re-enters the House, so as to secure accuracy in the division-lists. The Speaker of the Commons, who does not otherwise vote or take part in a debate, has a casting-vote in case of equality. In the House of Lords, the Speaker is, on the other hand, not disqualified from taking part in a debate; he votes on divisions, but has no casting vote; and on an equality, the non-contents prevail. The system of pairing commonly practised, though never directly recognised by the House, enables members on opposite sides to absent themselves for a time agreed on, each neutralising the votes of the other. A member of the Upper House may, with leave of the House, by a protest enter his dissent from a vote of the House, and its grounds. Every protest is entered on the Journals of the House, together with the names of all the lords who concur in it.

No question or bill is allowed to be offered in either House substantially the same with one on which the judgment of that House has already been expressed in the current session. A resolution of the House, however, may be rescinded, and an order discharged; and by 13 and 14 Vict. c. 21, it is provided that every act may be altered, amended, or repealed in the same session of parliament.

In debate, a member of the Commons addresses the Speaker; a member of the Upper House the lords generally, in both cases standing and uncovered. No member may speak except when there is a question before the House, or with the view to propose a motion or amendment, the only admitted exceptions being in putting questions to ministers of the crown, or to members concerned in some business which is before the House, and in explaining personal matters. A member is not

allowed to speak twice to the same question except in explanation, and the proposer, in some cases, in reply—a restriction which does not apply in committee. By the rules adopted by both Houses for preserving order in debate, no allusion is allowed to debates of the same session on a question not under discussion, or to debates in the other House of Parliament. All reflections on any determination of the House are prohibited, except when made with a view of moving that the determination be rescinded; so is the mention by a member of her Majesty's name either irreverently, or to influence the debate, and the use of offensive and insulting words against parliament or either House, or a member of the House in which he is speaking. No member is allowed to refer to another by name, or otherwise than by the rank or office which he enjoys, or place which he represents. The Speaker naming a member to the House, is an old established form of censure, which was last used when Mr Feargus O'Connor struck the member beside him.

*Messages.*—It is often found necessary for the Houses to communicate with each other regarding matters occurring in the course of business. Messages from the Lords were formerly sent by Masters in Chancery or judges, while the Commons sent a deputation of their own members. According to a new arrangement adopted in 1855, one of the clerks of either House may be the bearer of a message.

*Committees.*—Parliamentary committees are either 'of the whole House,' or 'select.' A committee of the whole House is the House itself, with a chairman instead of the Speaker presiding. The chair is taken in the Lords by the chairman of committees appointed at the beginning of each session, in the Commons by the chairman of the Committee of Ways and Means. Matters relating to religion, trade, the imposition of taxes, or the granting of public money, are generally considered in committee before legislation, as also are the provisions of any public bill. Proceedings are conducted nearly as when the House is sitting, the Lords being addressed in the Upper House, and in the Lower the chairman, who has the same powers to maintain order as the Speaker, and a casting vote in case of equality. In committees of the Commons, as in the House itself, a quorum of forty members is required; but if that number are not present, the Speaker must resume the chair to adjourn the House. A motion in committee need not be seconded, and there is a more unlimited power of debate than in the House, members being at liberty to speak any number of times on the same question. A motion for 'the previous question' is not allowed. When the business of the committee is not concluded on the day of sitting, the House is resumed, and the chairman moves 'that the House be again put into committee on a future day,' in the Lords, and in the Commons reports progress, and asks leave to sit again.

Select committees are composed of a limited number of members appointed to inquire into any matter, and report. In the Commons, it is usual to give select committees power to send for persons, papers, and records; in the Lords, they may, without any special authority, summon witnesses. In neither House can a committee enforce the attendance of a witness; this must be done, when necessary, by the House itself. The Commons have certain standing orders for insuring the efficiency of committees, and impartiality in their appointment. No committee is to consist of more than fifteen. Members moving for a committee must ascertain whether the members whom they propose to name will attend. Lists of the members serving on each committee are to be affixed in the committee

clerk's office and the lobby. To every question asked of a witness, the name of the member who asks it is to be prefixed in the minutes of evidence laid before the House; and the names of the members present at each sitting, and, in the event of a division, the question proposed, the name of the proposer, and the votes of each member, are to be entered on the minutes, and reported to the House. In the Lords there are no special rules regarding the appointment and constitution of committees; but resolutions containing arrangements similar to those of the Commons regarding questions to witnesses, minutes of proceedings, and divisions, have been adopted since 1852. Select committees have the power of adjournment from time to time, and sometimes from place to place. By an anomaly not easily explained, the Commons have always been considered not to have the power of administering oaths; a power of examining on oath has, however, by statute been granted to election committees, and committees on private bills. In the House of Lords, witnesses had formerly to be sworn at the bar of the House; but the oath may, in terms of a recent act (21 and 22 Vict. c. 78), be administered by any committee of the House. Except where leave of absence has been obtained, no member can excuse himself from serving on committees to which he may have been appointed, or for not attending when his attendance has been made compulsory by order of the House. In committees on private bills in the Commons, the chairman has a deliberative as well as a casting vote.

*Bills.*—The principal business which occupies both Houses is the passing of bills. In early times, laws were enacted in the form of petitions from the Commons, which were entered on the Rolls of Parliament, with the king's answers subjoined; and at the close of the session, these imperfect records were drawn up in the form of a statute, which was entered on the Statute Rolls. It was found that, on undergoing this process, the acts passed by the parliament were often both added to and mutilated, and much of the legislative power practically came into the hands of the judges. Bills in the form of complete statutes were first introduced in the reign of Henry VI. Bills are either public or private; the former affect the general interests of the community, the latter relate to local matters. Public bills are introduced directly by members; private bills by petitions from the parties interested, presented by members. Bills may originate in either House; but the exclusive right of the Commons to deal with all legislation regarding taxes or supplies, makes it necessary and expedient that by far the greater part of both public and private bills, except such as are of a purely personal nature, should originate in the Lower House. Bills regarding restitution of honours originate in the House of Lords. One description of act alone originates with the crown—an act of grace or pardon. It is read only once in each House, and cannot be amended, but must be accepted in the form in which it is received from the crown, or rejected.

*Public Bills.*—In the House of Lords, any member may present a bill. In the Commons, any member may move for leave to bring in a bill, except it be for imposing a tax, when an order of the House is required. When the motion is seconded, and leave given, the mover and seconder are ordered to prepare and bring in the bill. Such bills, however, as relate to religion, trade, grants of public money, or taxation, are required to be introduced by the House itself, on the report of a committee of the whole House. A bill is drawn out on paper, with blanks or italics where any part is doubtful, or

where sums have to be inserted. It is read a first time, and a day fixed for a second reading, allowing a sufficient interval to let it be printed and circulated. When ready, which is often as soon as the motion for leave to bring it in has been agreed to, it is presented at the bar by one of the members who were ordered to prepare and bring it in, and afterwards, on an intimation from the Speaker, brought up to the table. The question is put, 'That the bill be now read a first time,' which is rarely objected to; and in the Commons can only be opposed by a division. The short title of the bill, as entered in the orders of the day and endorsed on the bill, is then read aloud, which is accounted sufficient compliance with the order of the House. A day is then appointed for considering the question, 'that the bill be read a second time,' allowing a sufficient interval to elapse to let it be printed and circulated. At the second reading, the member in charge of the bill moves 'that the bill be now read a second time.' This is the usual time for opposing a bill whose general principle is disapproved. This is done by an amendment to the question, by leaving out the word 'now,' and adding 'this day three months,' 'this day six months,' or some other time beyond the probable duration of the session. Counsel are sometimes allowed to plead at the second reading or other stages. If the bill be approved on the second reading, it is committed, either to a select committee, or to a committee of the whole House, to consider its provisions in detail. When the proceedings in committee are terminated, the bill is reported to the House with amendments, which may be agreed to, amended, or disagreed to. It is then ordered to be read a third time, when the entire measure is reviewed. No amendments, except what are verbal, can then be made, and the question is put to the House, 'That this bill do now pass.' The title of the bill is last settled. The bill, when passed by the Commons, is sent to the Lords, where it goes through the same forms: if rejected, no further notice is taken of it; if passed, a message is sent to the Commons that the bill is agreed to. If amendments have been made, they are sent down along with the bill to be discussed by the Commons; and if they are not agreed to, a conference is demanded by the Commons, to offer reasons for disagreeing to the amendments. A conference is a mode of communicating on important matters between the Houses, in which each House is brought into direct contact with the other by a deputation of its own members—the time and place of meeting being always fixed by the Lords. A conference is conducted, for both Houses, by managers, who, on the part of the House desiring the conference (in the case supposed, the Commons), consist of the members who have drawn up the reasons, with others sometimes added. If the Lords be not satisfied with the reasons offered, a second conference is desired, after which what is called a 'free conference' may be demanded, in which the managers have more discretion vested in them to advance what arguments they please. No free conference has been held since 1740. By resolutions of both Houses, agreed to in 1851, reasons for disagreement from amendments may be communicated by messages without a conference, unless the other House should desire a conference; and since that time, there has been but one instance of a conference where a message would have been available. If the Commons eventually agree to the amendments, the bill is sent back to the Lords; if not, it is dropped. The same forms are gone through when a bill originates in the House of Lords. The official record of the assent of one House to the bills passed,

or amendments made by the other, is an endorsement on the bill in Norman French. Thus, when a bill is passed by the Commons, the Clerk of the House writes on the top of it, 'Soit baillé aux seigneurs.' When the Lords make amendment to a bill, it is returned with the endorsement, 'A ceste bille aveques des amendments les seigneurs sont assentus.' When it is sent back with these amendments agreed to, the Clerk of the House of Commons writes, 'A ces amendments les Communes sont assentus.' When both Houses have agreed to a bill, it is deposited in the House of Lords, to await the royal assent, unless it be a money-bill, which is sent back to the Commons.

*Private Bills.*—In private bills, the functions of parliament partake of the judicial as well as the legislative character, and the difficulties in reconciling the interests of the public and of individuals, often give rise to inquiries too extensive for the House to undertake, which therefore delegates them to committees. The standing orders require certain notices to be given to parties interested by personal service, and to the public by advertisement. The practice in both Houses now is for all petitions for private bills to be referred to four 'examiners,' two from the Lords and two from the Commons, whose duty it is to examine whether certain notices and other forms required by the standing orders of the House have been complied with. If the report be favourable, leave is given to bring in the bill; if unfavourable, it is referred to a committee, called the Committee on Standing Orders, who report on the propriety of relaxing the standing orders in this individual case—should they report unfavourably, it is still in the power of the House to relax the standing orders, though this is rarely done. Three days must elapse between the first and second reading. At the second reading, the principle is considered, as in the case of public bills; and if the bill be carried, it is referred, if not a railway, canal, or divorce bill, to the 'Committee of Selection,' consisting of the chairman of the Standing Orders Committee, and five other members nominated at the beginning of the session, whose functions are to classify the bills, to nominate the Committees on them, and to arrange their time of sitting. A railway or canal bill is referred to the 'General Committee of Railway and Canal Bills.' This committee forms bills of this class into groups, and appoints the chairman of the committee which is to sit on each bill from its own body, the remaining members, four in number, being chosen from the Committee of Selection. Before the sitting of the committee, every private bill, whether opposed or unopposed, must be examined by the chairman of the Committee of Ways and Means and his council. It is also laid before the chairman of the Lords' Committee and his council, and effect is given to their observations, a proceeding which greatly facilitates the after-progress of the bill in the House of Lords. The Board of Trade, the Secretary of State for the Home Department, the Lords Commissioners of the Admiralty, and the Commissioners of Woods and Forests, also exercise a supervision over private bills of various kinds, by which the respective rights of their departments may be supposed to be encroached on. In the House of Lords, estate bills are referred to the judges. Every bill, at the first reading, is referred to the Examiners, before whom compliance with such standing orders, as have not been previously inquired into must be proved. The Standing Orders Committee of the Lords is now assimilated in functions to that of the Commons. The bill is returned to the Commons either with amendments, or with a message that it is agreed to without amendments. In case of



disagreement between the Houses, the same forms are observed as in public bills.

In recent times, the necessity for obtaining private acts has been, in many cases, obviated by general laws adapted to different classes of objects, of which parties are enabled to avail themselves, instead of applying to parliament for special powers.

*Royal Assent.*—A bill becomes a statute or act of parliament on receiving the royal assent, which is given in the House of Lords, the Commons being also present at the bar. It is given in either of two ways: by letters-patent under the Great Seal, signed by the sovereign's own hand, and communicated to the two Houses by commissioners; or by the sovereign present in person in the House of Lords. When the royal assent is given by commission, three or more of the Lords Commissioners command Black Rod to signify to the Commons that their attendance is desired, on which the Commons, with the Speaker, immediately come to the bar. The commission is then read at length; and the titles of all the bills being read by the Clerk of the Crown, the royal assent to each is signified by the Clerk of the Parliaments in Norman-French, and so entered on the Lords' Journals. In assenting to a public bill, the words used are: 'Le roy [la reine] le veult;' to a private bill: 'Soit fait comme il est désiré;' and to a bill of supply (which is presented by the Speaker, and receives the royal assent before all other bills): 'Le roy remercie ses bons sujets, accepte leur benevolence, et ainsi le veult.' In the case of an act of grace, which has originated with the crown, there was, till lately, no further expression of the royal assent; but the Clerk of the Parliaments, having read its title, said: 'Les prélats, seigneurs, et communes, en ce présent parlement assemblés, au nom de tous vos auctres sujets, remercient très-humblement vostre Majesté, et prient à Dieu vous donner en santé bonne vie et longue:' the royal assent, however, has been latterly given to acts of grace in the usual form. The refusal of the royal assent is announced by the words, 'Le roy s'avisera.' But the necessity for such refusal is generally removed by the observance of the constitutional principle, that the queen has no will but that of her ministers, who only continue in office so long as they have the confidence of parliament. The last instance in which the royal assent was refused was by Queen Anne in 1707, regarding a bill for settling the militia in Scotland.

The royal assent is seldom given in person, except at the close of a session, when the queen attends to prorogue parliament, and then signifies her assent to such bills as have been passed since the last commission was issued; but bills providing for the honour and dignity of the crown, and bills for settling the civil lists, have generally been assented to by the sovereign in person, immediately after they have passed both houses. When the royal assent is given in person, the Clerk of the Crown reads the titles of the bills; and the Clerk of the Parliaments, who has previously received her Majesty's commands in the robing room, makes an obeisance to the throne, and signifies her Majesty's assent, as already described, the queen giving a gentle inclination.

*Supplies.*—Prior to 1688, in addition to parliamentary taxation, imposts were sometimes levied by an exercise of the royal prerogative. Since the Revolution, no taxes have been raised otherwise than by parliamentary authority. The Commons have the exclusive right to impose taxes and vote money for the public service. The Lords cannot even make an alteration in a bill of supply, except to correct a clerical error. The Lords are not even entitled to insert in a bill any pecuniary penalties,

or to alter the amount or application of any penalty imposed by the Commons; a rule whose rigid assertion has been found to be attended with so much inconvenience that there has latterly been a disposition to relax it. If a bill containing provisions which make a pecuniary charge on the public originate in the Lords, any such provisions are struck out in the bill as sent to the Commons. In the Commons, these provisions are printed in red ink, and supposed to be blank, and may be agreed to in committee. But though the Commons has the exclusive right to grant supplies, a grant requires the ultimate assent of the queen and the House of Lords.

The public revenue of the crown is derived in part from permanent charges on the consolidated fund, and in part from actual grants for specific public services, which require the yearly sanction of parliament. On the opening of parliament, the queen demands from the Commons the annual provision for the public services, and directs estimates to be laid before them. On agreeing to the address in answer to the royal speech, the Commons order the speech to be taken into consideration on another day. On the arrival of that day, a motion is made: 'That a supply be granted to her Majesty,' and the House resolves into a committee to consider that motion. On the day appointed, the committee sits and agrees that a supply be granted, which, being reported, is agreed to by the House. The House then appoints another day on which it resolves itself into a 'Committee of Supply.' The estimates for the army, navy, and ordnance departments, are first laid before the committee; then the estimates for civil services, known as the miscellaneous estimates. The first business of the Committee of Supply is to elect a chairman, who is known as the Chairman of the Committee of Ways and Means, over which he also presides. When the first report of the Committee of Supply has been received and agreed to, a day is appointed for the House to resolve itself into a 'Committee of Ways and Means.' This committee is not appointed till a sum has been voted by the House, nor is it afterwards allowed to vote in excess of the expenditure voted by the Committee of Supply. It is the function of the Committee of Supply to consider what specific grants are to be voted, and of the Committee of Ways and Means to determine how the funds shall be raised which are voted by the Committee of Supply. Without special parliamentary authority, the consolidated fund could not be applied to meet the supplies voted for the service of the year; but to make it so available, the Committee of Ways and Means votes general grants from time to time out of the consolidated fund 'towards making good the supply granted to her Majesty;' and bills are founded on the resolutions of the committee, by which the treasury receives authority to issue the requisite amount from the consolidated fund for the service of the year. It belongs to the Committee of Ways and Means to determine what sums shall be raised by exchequer bills in anticipation of the annual revenue, to make up the supply granted to her Majesty. When the Committee of Supply has determined the number of men that shall be maintained during the year for the army and sea-service, and its resolutions have been agreed to, the *Mutiny Bill* and *Marine Mutiny Bill* are brought in, providing respectively for the discipline of the troops and marines when on shore. Apart from this annual sanction, the maintenance of a standing army in time of peace would be illegal, and the army and marines would be relieved from all martial discipline. The Committee of Ways and Means receives the annual financial statement from the

## PARLIAMENT.

Chancellor of the Exchequer, popularly called the *Budget*. That minister gives a general view of the resources of the country, and of the financial policy of the government, and presents a probable estimate of income and expenditure for the twelve months ending on the 12th of April of the following year. He states what taxes he intends to reduce, and what new ones he means to impose, and ends by proposing resolutions for the adoption of the committee, which, when reported to the House, form the groundwork of bills for accomplishing the financial objects proposed. The charges for collecting the revenue, have, since 1854, been brought under the supervision of the House of Commons; and estimates are voted for the revenue departments. A new tax cannot be proposed except by a minister of the crown. The resolutions of Committees of Supply and of Ways and Means are reported on a day appointed by the House, and read a first time without a question, and a second time on a question put from the chair, and are agreed to by the House, or may be disagreed to, amended, postponed, or recommitted. When the Committee of Supply is closed, the Committee of Ways and Means authorises the application of money from the consolidated fund, the surplus of ways and means, and sums in the Exchequer, to meet the grant and services of the year, and the resolutions of the committee are carried into effect by the Consolidated Fund Bill, or as it is often called, the *Appropriation Bill*. By a standing order of April 3, 1862, a standing Committee of Public Accounts is appointed at the beginning of each session to examine into the appropriation of the sums granted by parliament to meet the public expenditure. Taxes of a permanent and general character are not now considered in the Committee of Ways and Means.

*Petitions.*—Among the duties of parliament is the receiving of petitions. A petition must be presented by a member of the House to which it is addressed. Petitions from the corporation of London are, however, presented to the House of Commons by the sheriffs at the bar, or by one sheriff, if the other be a member of the House, or unavoidably absent. In 1840, a petition was allowed to be presented by the Lord Mayor and Aldermen, when the sheriffs were in custody of the serjeant-at-arms. The Lord Mayor of Dublin has been allowed to present a petition at the bar of the House, and the same privilege would probably be conceded to the Lord Provost of Edinburgh. Petitions which violate any of the rules of the House, are not brought up, but returned to the petitioners; and if an irregularity be discovered after a petition is brought up, its presentation is not recorded in the votes. In the House of Lords, when a petition is laid on the table, an entry is made in the Lords' minutes, and afterwards in the Journals of the House, which, however, does not describe its nature and substance. A petition may, on presentation, be made a subject of debate, but unless this is done, there remains no public record of its import, or of the parties by whom it was signed. In the House of Commons, according to standing orders adopted in 1842, the member presenting a petition is to confine himself to a statement of who the petitioners are, the number of signatures, the material allegations of the petition and its prayer. In case of urgency, or where questions of privilege are involved, the matter of the petition may be discussed; but in ordinary cases no debate is allowed, and it is referred to the Committee on Public Petitions, and if relating to a subject with regard to which the member presenting it has given notice of a motion, it may be ordered to be printed with the votes. The reports of the Committee on Public Petitions are printed

twice a week, and point out the name, the subject, and the number of signatures of each petition, and the total number of signatures, and petitions relating to each subject; and, in some cases, the petition itself is printed at full length in the appendix.

*Communications with the Crown.*—Besides at the opening and proroguing of parliament, and giving of the royal assent, there are other occasions on which the crown communicates with parliament by a *message*, under the sign-manual, to either House singly, or both Houses separately. Messages are brought by a member of the House, being a minister of the crown, or one of the royal household, and may relate to important public events, the prerogatives or property of the crown, provision for the royal family, &c. An *address* is the mode in which the resolutions of parliament are communicated to the crown. Addresses may be joint, of both Houses, or separate, of either House.

*Returns.*—Each House has the power of ordering returns from all those public departments which are connected with the revenue, under control of the Treasury, or regulated by statute; but returns of matters connected with the exercise of royal prerogative, as from public departments subject to her Majesty's secretaries of state, are obtained by means of addresses to the crown. A return is not allowed to be ordered in one House regarding the proceedings of the other; when such return is wished, it is usual to make an arrangement by which it is moved in the House to whose proceedings it relates, and after it has been presented, a message is sent to request that it may be communicated. Returns cannot be moved from private associations, or persons not exercising public functions; and the papers and correspondence sought from government departments must be of an official, not a private or confidential description. This rule was, under special circumstances, departed from in 1858, in regard to the opinion of the law-officers of the crown in the case of the *Cagliari*. Accounts and papers presented are ordered to lie on the table, and when necessary, ordered to be printed, or in the Commons referred to the Printing Committee appointed at the beginning of each session.

*Election Committees.*—The trial of election petitions is one of the duties of the House of Commons. Until 1770 all questions regarding controverted elections were decided by the whole House; the Grenville Act of that year introduced the practice of appointing committees for their trial. The Act 11 and 12 Vict. c. 98, now regulates the trial of controverted elections. An election petition is defined to be a complaint, either (1) of an undue election; (2) that no return has been made according to the requisition of the writ; or (3) of the special matters contained in the return. It must be signed by some person who voted, or had a right to vote at the election, or by some person who claims to be returned, or alleges himself to have been a candidate. The petition must be lodged within fourteen days after the return objected to. Recognisances must be entered into, according to a form prescribed, by sureties to the extent of £1000, in portions not less than £250 for each individual-surety—the petitioner having it in his option to pay the money, or part of it, into the bank instead of finding security. Six members selected from those who are not themselves parties in controverted elections, are appointed at the beginning of every session by the Speaker's warrant as the 'General Committee of Elections.' To this committee all election-petitions are referred; and it is their duty to choose the select committee which is to try each petition. From a list of the members of the House, who are not excused or disqualified from acting on

election committees, they select six, eight, ten, or twelve members who are called the chairmen's panel, and are liable throughout the session to serve as chairmen of select committees, but are exempted from serving on select committees in any other capacity. The remaining members on the list are then divided into five panels, which being ranged in order by lot, are to take their turn successively in furnishing members for election committees. Each select committee consists of four members, chosen by the general committee from the panel in service, and a chairman appointed by the chairmen's panel. The members are sworn at the table by the clerk, 'well and truly to try the matter of the petition, and a true judgment to give, according to the evidence.' Evidence may be taken on oath, and it is enacted by the Corrupt Practices Act, 1863, that no witness is excused from answering a question on the ground that his answer may criminate himself; but a witness, making an answer which tends to criminate him, may demand a certificate which shall be a protection to him from prosecution for such answer. The decision lies with the majority of the committee, the chairman having both a deliberative and a casting vote. The committee are required to determine whether the sitting member, or any other person, be duly returned, or whether the election be void, or whether a new writ ought to issue; and their determination is final, and is carried into execution by the House. They may also make a special report on some other point, which is not final. The most frequent subjects of special reports are bribery, treating, and the use of undue influence, matters regarding which various acts have been passed, the most important being 17 and 18 Vict. c. 102 (1854), 21 and 22 Vict. c. 87 (1858), and 26 Vict. c. 29 (1863), three statutes known as the 'Corrupt Practices Prevention Acts.' It was formerly required to prove agency, before evidence was allowed to be given of the facts on which a charge of bribery rested, but Act 4 and 5 Vict. c. 57, dispensed with this necessity. By the Corrupt Practices Prevention Act, 1863, when an election petition complains of bribery, treating, or undue influence, the committee is required to report whether they had been extensively practised. The candidate declared by an election committee guilty of bribery, treating, or undue influence by himself or his agents, is declared by the Corrupt Practices Act, 1854, to be incapable of representing the same constituency in the then existing parliament. The new law of evidence affords further facilities for the detection of bribery, in so far as it allows the personal examination of the sitting members and candidates.

By the Act of 1854, the offering of money, office, employment, &c., to a voter to induce him to vote or abstain from voting, or the offering of a similar consideration to any person to induce him to procure the return of a candidate or the vote of an elector, the acceptance of such consideration, and the payment of money in the knowledge that it is to be expended in bribery, or the repayment of money which has been spent in bribery, are all declared to be acts of *bribery* punishable by fine and imprisonment, as well as by the forfeiture of £100 with costs to any person who will sue for the same. Any voter who agrees to receive money, office, or employment for voting or abstaining from voting, and any person who, after an election, receives money or other consideration on account of any person having voted or refrained from voting, is also guilty of bribery, and liable to forfeit £10 with costs to any one who will sue for the same. *Treating*, which is defined as the providing of meat, drink, or other entertainment to any person

in order to be elected, or in consideration for any person voting or abstaining from voting, involves a penalty of £50 similarly recoverable, as also does *undue influence*, or interference by intimidation, abduction, or otherwise, with the freedom of electors. Persons guilty of any of these offences are, by the provisions of the same acts, to be struck off the register, and their names inserted in a separate 'list of persons disqualified for bribery, treatment, and undue influence,' which is to be appended to the register of voters. Cockades are prohibited, as is the furnishing of refreshment on the day of election to a voter in consideration of his being about to vote. By the Corrupt Practices Act, 1854, it is however declared lawful to provide a conveyance for a voter, though not to pay him a sum of money for travelling expenses. By the Act of 1863, no payment is allowed to be made on behalf of a candidate except through his authorised agent, and all claims against a candidate in respect of an election must be settled within a month, otherwise the right to recover them is barred. A detailed account of election expenses with vouchers is required to be delivered within two months of the election to the returning officers, by whom it is published in a local newspaper, and the vouchers are to be open for a month to the inspection of voters.

Act 15 and 16 Vict. c. 57 enacts that upon the joint address of both Houses of Parliament representing to her Majesty that a committee of the House of Commons has reported that corrupt practices have prevailed extensively at any election, her Majesty may appoint commissioners to make inquiry. The Corrupt Practices Prevention Act, 1863, provides that when an election committee has reported that certain persons named have been guilty of bribery or treating, and their report is confirmed by a commission of inquiry, such report, with the evidence taken by the commission, is to be laid before the attorney-general with the view of instituting a prosecution.

*Impeachment.*—In the reign of Henry VIII., an act of attainder was the usual mode of proceeding against state offences. A bill of attainder sometimes followed a regular trial and conviction, as in the case of Empson and Dudley, but was sometimes passed without trial, examination of witnesses, or hearing the accused party, as in the attainder of Fisher and Sir Thomas More. The practice of impeachment of extraordinary offenders before the Lords by the Commons, which had been frequent during the 14th and 15th centuries, was revived in the reign of James I. This proceeding is not like bills of attainder or pains and penalties, the making of a new law *pro re nata*, but a carrying out of the already known and established law. The great representative inquest of the nation first find the crime, and then as prosecutors support the charge before the highest court of criminal jurisdiction. It has always been allowed that a peer may be impeached for any crime whether cognizable by the ordinary courts or not. The right of the Commons to impeach a commoner of a capital offence, which was at one time doubted, has been solemnly affirmed by the House of Lords. The trial is conducted by managers for the Commons. Witnesses are summoned by the Lords at the desire of the Commons, and Westminster Hall has usually been the place of trial, the Lord High Steward presiding. The managers make their charges and adduce evidence; the accused answers, and may defend himself by counsel; and the managers have a right to reply. In giving judgment, the question is put by the Lord High Steward to each peer, beginning with the junior baron, on each article separately, whether the accused be guilty. The

answer is, 'Guilty, on my honour,' or 'Not Guilty, on my honour,' the Lord High Steward giving his opinion the last, and the numbers being cast up, the accused is acquainted with the result. Impeachments have not been common in later times; the latest memorable cases are those of Warren Hastings in 1788, and Lord Melville in 1805.

*Trial of Peers.*—Peers are, in all cases, tried by their peers for treason, misprision of treason, felony, or misprision of felony. During the sitting of parliament, the trial proceeds before the House of Lords, or more properly before the Court of Parliament presided over by the Lord High Steward. When parliament is not sitting, the trial takes place before the Court of the Lord High Steward—a tribunal whose constitution was at one time very objectionable, that officer being allowed to summon what peers he pleased, only with the proviso that the number should amount in all to 23. Act 7 Will. III. c. 3 requires that all the peers who have a right to sit and vote in parliament be summoned. Peers of Scotland and Ireland are, in terms of the Acts of Union, tried in the same way. By 4 and 5 Vict. c. 22, a peer is liable on conviction to the same punishment as any other of the lieges.

The annual expenses of parliament are about £158,369, of which £72,684 is expended in printing, and the remainder in salaries and emoluments, including £5000 salary to the Speaker of the House of Commons. See T. Erskine May's *Laws, Privileges, Proceedings, and Usage of Parliament*, 5th edition, 1863.

**PARLIAMENTARY CHURCH** is a church erected under the authority of an act of parliament. In England such a church is generally called a district church; and the acts of parliament authorising such churches, are known as the Church Building Acts. See **PARISH**. In Scotland similar churches are called *Quoad Sacra* (q. v.) churches.

**PARMA**, a former sovereignty of Upper Italy, having the rank of a duchy, and bounded on the N. by Lombardy and Venice, E. by Modena, S. by Genoa and Tuscany, and W. by Piedmont, consisted of the duchies of Parma and Piacenza, which were subdivided into 5 districts, and contained in all 2268 English square miles, with a population (1861) of 469,435. The Apennines, which cross the southern division of the duchies, send off spurs northwards, and give to the northern part of the country the character of a plain, gently undulating, but sloping uniformly to the Po, which is the recipient of all the rivers of the country. The highest peaks of the Apennines in P. are, Monte Alpe di Succisio, about 7000 feet; and Monte Parma and Monte Orsajo, both more than 5250. The mountain-range is richly clad with oak and chestnut forests. The plain, which is very fertile, produces rich crops of grain (including rice), leguminous plants, fruits of all kinds, olives, and grapes; while marble, alabaster, salt, and petroleum are the chief mineral products. Next to agriculture, the production and manufacture of silk, the rearing of cattle and poultry, cheese-making, and the extraction of the mineral products afford the chief employment. Silk and cheese are the chief exports. The cheese, however, known as Parmesan, is not made here, but in the neighbourhood of Lodi (q. v.).

The form of government was monarchical, and the Roman Catholic religion the only one tolerated, though a few Jews are found here and there through the country. The condition of education, though improved of late, is still very defective. The administrative power was in the hands of a council of state, which was divided into two sections—one for internal administration, which acted as a court

of final appeal in matters of justice, the other for finance and military and foreign affairs. The revenue of P. in 1859 was estimated at 11,566,648 liras (£458,085), and the expenditure at 11,273,883 liras (£446,490). The total debt, funded and redeemable, amounted to 15,558,218 liras (£616,167). The army (1859) before the annexation, according to the statistics of 1863, consisted of 3290 soldiers; the duke had also the occasional loan of an Austrian regiment, and the fortress of Piacenza was garrisoned by the troops of that power.

*History.*—P. and Piacenza belonged in the time of the Roman Empire to Cisalpine Gaul, and after its fall came under the rule of the Lombards, to whose rule succeeded that of the kings of Italy and the German emperors. In the 12th and following centuries, they joined the other territories of Northern Italy which were struggling for liberty and independence, and consequently became involved in the Guelph and Ghibelline contests. Weakened by these strifes, they fell under the domination of the powerful houses of Este, Visconti, and Sforza; but in 1499 they passed under the yoke of the French monarch, Louis XII., from whom they were soon recovered by the Emperor Maximilian, and handed over to Pope Leo X. in 1513. They continued under the sovereignty of the popes till 1543, when they were alienated by Pope Paul III., and with the surrounding territory were erected into a duchy for his natural son Pier-Luigi Farnese, the grandfather of Alessandro Farnese, the celebrated regent of the Low Countries. On the extinction of the male line of Farnese, in 1731, by the death of the eighth duke, Antonio, his niece Elizabeth, the queen of Philip V. of Spain, obtained the duchies for her son Don Carlos, who, however, exchanged them in 1735 with Austria for the throne of the Two Sicilies. In 1748 they were restored along with Guastalla to Spain, and became a duchy for the Infante Don Philip, with a reversion to Austria in case of the failure of his male descendants, or of any of them ascending the Spanish or Neapolitan throne. Philip was succeeded in 1765 by his son Ferdinand, who was an able and enlightened ruler, and expelled the Jesuits in 1768. He died in 1802, and his dominions were immediately taken possession of by the French, and were incorporated with France under the designation of the department of Taro in 1805. In 1814, by the treaty of Paris, P., Piacenza, and Guastalla were presented as a sovereign duchy to the ex-empress Maria Louisa, a proceeding strongly opposed by the king of Spain, who demanded them for his sister, Maria Louisa, the widow of Louis, king of Etruria, the son of Duke Ferdinand. However, in 1817, it was settled that Maria Louisa of Austria should possess the duchies, and that on her death they should descend to Ferdinand Charles, Duke of Lucca, the son of Maria Louisa of Spain, and the rightful heir; and on failure of his heirs, P. should revert to Austria, and Piacenza to Sardinia. The empress governed very much after the Austrian fashion, but with gentleness, though liberal sentiments were looked upon by her with little favour. On her death, in 1847, the Duke of Lucca succeeded as Charles II., and certain exchanges of territory, previously settled by the great powers, took place with Tuscany and Modena—the chief of which being the transfer of Guastalla to Modena in exchange for the districts of Villa-franca, Treschietto, Castevoli, and Melazzo, all in Massa-Carrara, resulting in a loss to P. of about 77 English square miles of territory, and a gain of 193 English square miles. This transfer was not made without great discontent on the part of the inhabitants. The duke's rule was severe and tyrannical, and on an address being presented to him with a view of

obtaining a reform of certain abuses, and a more liberal political constitution, similar to what Tuscany had (February 1848) obtained from its grand-duke, he threw himself into the arms of Austria, and consented to the occupation of his territory by Austrian troops. In March 1848 a revolution broke out, and the duke was compelled to grant the popular demands, but he almost immediately after retired from the country. P. joined with Sardinia in the war of 1848—1849 against Austria, but on the triumph of the latter power was compelled to receive Charles III. (his father, Charles II., having resigned his throne, March 1849) as its ruler. The new duke recalled the constitution which his father had been compelled to grant, and punished with great severity the active agents of the revolutionary movements in his dominions. His arbitrary measures were effectively seconded by his chief minister, an Englishman named Ward, who shared the public obloquy with his master. After Charles III.'s assassination in March 1854, his widow Louise-Marie-Therese de Bourbon, daughter of the last Duke of Berry (q. v.), assumed the government for the behoof of her son Robert I., and made some attempts at political reform; but owing to the excited state of the people they were little effective, and she and her son were compelled to leave the country in 1859, on the outbreak of a new war between Sardinia and Austria. In March 18th of the following year the country was annexed to Sardinia, and now forms a part of the Kingdom of Italy, constituting the two provinces of Parma (area 1251 English square miles, pop. 258,502) and Piacenza (area 965 English square miles, pop. 210,933), a few of the outlying districts, amounting to about 150 square miles, being incorporated with other provinces.—*Official Statistics of the Kingdom of Italy* (Turin, 1861); *Budget of the Emilies*; *Report of the Marquis Pepoli to the Minister of Finances* (Turin, 1860); *idem. Report of General Tozza to the Minister of War* (1863).

PARMA, the chief town of the province of the same name in Italy, and formerly the capital of the duchy of Parma, is situated on both sides of the river Parma, 12 miles south from the Po, 75 miles south-east from Milan, and about the same distance east-north-east from Genoa, with a population (1863) of 47,428.

The town is of a circular form, and is surrounded by walls and ditches flanked by bastions; the streets are straight and wide, and meet at right angles, the chief of them, a part of the Roman Via Emilia, crossing the city from east to west, and dividing it into two nearly equal parts. P. is celebrated for its churches, 10 in number, the chief of which are the *Duomo*, or Cathedral (consecrated 1106 A. D.), built chiefly in the Lombard style, having the interior adorned with magnificent frescoes by Correggio, and paintings by other artists, and surmounted by a beautiful dome; the *Battistero*, or Baptistery, one of the most splendid in Italy, begun in 1196 and completed in 1281; the church of the *Madonna della Steccata*, containing the famous painting of 'Moses breaking the Tables of the Law' by Parmigianino. The other celebrated buildings are, the Farnese Palace, a gloomy and ill-constructed edifice; the Farnese Theatre, built (1618—1628) of wood, and now in a most dilapidated condition. P. has also a library containing 140,000 volumes, mostly well selected, and many of them rare and valuable works; a museum of antiquities; a botanic garden; a theatre (*Teatro Nuovo*); an academy of fine arts, founded in 1752, possessing a collection of 600 pictures, many of which are exceedingly valuable. The pictures

most highly esteemed are the 'Madonnas' of Correggio and Francia, the 'St Jerome' of Correggio, and the 'Jesus Glorified' of Raphael.

The manufactures of P. are stockings, porcelain, sugar, wax-candles, and vessels of crystal, also silk, cotton, and fustian stuffs. The chief exports are cheese and silk goods; and in June there is an annual silk fair.

PARMA, BATTLES OF. An indecisive engagement took place here June 29, 1734, between the confederated armies of England, France, and Spain, and the Austrians; and on June 19, 1799, the French under Macdonald were routed by the Russians under Suwarof, with a loss of 10,000 men and 4 generals.

PARME'LIA, a genus of Lichens, with a leafy horizontal thallus which is lobed and cut; and orbicular shields (*apothecia*) fixed by a central point, concave, and bordered by the inflexed thallus. The species are numerous, and many are found in Britain. Some of them are occasionally employed in dyeing. Various chemical principles have been discovered in lichens of this genus, as *Usnine* or *Usnic Acid* (also found in species of the genus *Umea*), and *Parietin*. Valuable medicinal properties—tonic and febrifugal—have been ascribed to *P. parietina*, the Common Yellow Wall Lichen, or Common Yellow Wall Moss of the herb shops, a bright yellow species with deep orange shields, plentiful on walls and trees in Britain and most parts of Europe.

PARME'NIDÉS, a Greek philosopher of Elea, in Lower Italy, and in the opinion of the ancients the greatest member of the Eleatic school, flourished about the middle of the 5th c. B. C. Nothing is known with certainty regarding his life, but he is said to have visited Athens in his old age, and to have conversed with Socrates, then quite a youth. The story, though it rests on the authority of Plato, has a suspicious air, and seems as if it were intended to account for the influence which the philosophy of P. undoubtedly exercised on that of Socrates and Plato themselves. P., like Xenophanes of Colophon, sometimes regarded as the first of the Eleatics, expounded his philosophy in verse—his only work being a didactic poem *On Nature*. The leading design of this poem is to demonstrate the reality of Absolute Being, the non-existence of which P. declares to be inconceivable, but the nature of which, on the other hand, he admits to be equally inconceivable, inasmuch as it is dissociated from every limitation under which man thinks. P. is not a theologian in speculation, seeking rather to identify his 'Absolute Being' with 'Thought' than with a 'Deity.' Only fragments of his poem remain, which have been separately edited by Fülleborn (Züllichau, 1795); another collection is that by Brandis, in his *Commentationes Eleaticæ* (Altona, 1815); but the best is to be found in Karsten's *Philosophorum Græcorum veterum Reliquiæ* (Amstelod, 1835).

PARMIGIANO, GIROLAMO FRANCESCO MARIA MAZZOLA, called Parmigiano or Parmigianino, born at Parma in 1503, an able painter of the Lombard school, and the most distinguished of those who followed the style of Correggio. His pictures attracted much attention when he was little more than fourteen years of age. In 1523 he went to Rome to follow out his studies, and was soon favourably noticed and employed by Clement VII. He was in that city when it was stormed by the imperialists under Bourbon in 1527, and, it is said, was calmly at work on his picture of 'The Vision of St Jerome' (now in the National Gallery, London) when soldiers, bent on pillage, burst into

his studio. He was, however, protected by their leader. After this event he left Rome for Bologna, where he painted various important works, and returned to Parma in 1531. Having engaged to execute several extensive frescoes in the church of S. Maria Steccata, after repeated delays, he was thrown into prison for breach of contract, and on being released, in place of carrying out his undertaking, he fled to Casal Maggiore, in the territory of Cremona, where he died soon afterwards in 1540. Vasari, in his notice of P., attributes his misfortunes and premature death to his passion for alchemy; but this oft-repeated story has been disproved by the researches of late biographers. He executed several etchings, and some wood-cuts are attributed to him.

**PARNAHIBA**, or **PARANAHYBA**, a river of Brazil, rises in the Sierra dos Coroados, between the provinces of Goyas and Piaui, about 11° S. It flows north-east and north, and enters the Atlantic in long. about 41° 40' W. by five mouths, which enclose a delta about 30 miles wide along the shore. These mouths, however, are only from two to four fathoms deep. It drains the province of Piaui, and forms the boundary-line between it and the province of Maranhão. Total length estimated at 750 miles.—A chief tributary of the Parana also bears the name of Parnahiba.

**PARNA'SSUS**, a mountain greatly celebrated among the ancients, and regarded by the Greeks as the central point of their country. It was in Phocis. It has three steep peaks, almost always covered with snow, and seen from a great distance, the highest being fully 8000 feet above the level of the sea; but as only two of them are visible from Delphi, it was customary among the Greeks to speak of the two-peaked Parnassus. On its southern slope lay Delphi (q. v.), the seat of the famous oracle, and the fountain of Castalia (q. v.). The highest peak was the scene of the orgies of the worship of Dionysus (Bacchus); all the rest of the mountain was sacred to Apollo and the Muses, whence poets were said to 'climb Parnassus,' a phrase still thus employed.

**PAROCHIAL BOARD**, in Scotland, is the board in each parish which manages the relief of the poor. In England, the same duty is performed by overseers, and in some cases by guardians of the poor.

**PAROCHIAL RELIEF** is the relief given to paupers by the parish authorities. See **POOR**.

**PARODY** (Gr. *para*, beside, and *ode*, a song), the name given to a burlesque imitation of a serious poem. Its peculiarity is that it preserves the form, and as far as possible the words of the original, and thereby differs from a Travesty, which is a looser and less literal kind of burlesque. The invention of parodies is commonly ascribed to the Greeks (from whom, at least, we have derived the name); the first parodist, according to Aristotle, being Hegemon of Thasos, who flourished during the Peloponnesian war; according to others, Hipponax. From the fragments that are extant of ancient parody, we infer that Homer was the favourite subject of comic imitation. Thus Hipponax, in his picture of a glutton, ludicrously insinuates a comparison between the feats of his hero in eating and those of Achilles in fighting, by commencing as follows:

Sing, O celestial goddess, Eurymedon, foremost of gluttons,

Whose stomach devours like Charybdis, eater unmatched among mortals.

The *Batrachomyomachia* (Battle of the Frogs and

Mice), erroneously ascribed to Homer, is also a happy and harmless specimen of the parody, which, however, soon began to exchange its jocose and inoffensive raillery for a biting and sarcastic banter, of which numerous specimens may be seen in the comedies of Aristophanes; while the philosopher Timon of Phlius invented, under the name of *Silla*, a new species of satirical parody. Among the Romans we first meet with this form of literature in the period of the decline. All the power of Nero could not prevent his verses from being parodied by Persius. Among modern nations the French—as might naturally be expected from their character—have been most addicted to this literary mimicry. Corneille parodied Chapelain in his *Cid*, and Racine parodied Corneille. The *pot-pourris* of Désangiers are considered by his countrymen models of this ungracious kind of literature. Schiller's famous poem of the *Bell* has been often parodied by German wits. In England, perhaps the best compositions of this nature are the *Rejected Addresses* of the brothers James and Horace Smith. Many will remember, in particular, the parody on Scott's 'Battle of Flodden' in *Marmion*, ending—

'od rot 'em  
Were the last words of Higginbotham.

Barham's *Ingoldsby Legends* contains a felicitous parody on Wolfe's *Lines on the Burial of Sir John Moore*. We quote the first stanza as a specimen:

Not a sou had he got, not a guinea or note,  
And he looked most confoundedly flurried  
As he bolted away without paying his shot,  
And his landlady after him hurried.

Thackeray's *Miscellanies* also contain some very clever and satirical prose parodies upon certain of his brother novelists.

The historical development of the parody has been treated by Moser in Daub's and Creuzer's *Studien* (6th vol.). See also Moser's *Parodiarum Exempla* (Ulm. 1819), and Weland's *De Præcipuis Parodiarum Homericarum Scriptoribus* (Gött. 1833).

**PAROLE** (literally, a word) is the declaration made on honour by an officer, in a case in which there is no more than his sense of honour to restrain him from breaking his word. Thus a prisoner of war may be released from actual prison on his parole that he will not go beyond certain designated limits; or he may even be allowed to return to his own country on his parole not to fight again, during the existing war, against his captors. To break *parole* is accounted infamous in all civilised nations, and an officer who has so far forgotten his position as a gentleman ceases to have any claim to the treatment of an honourable man, nor can he expect quarter should he again fall into the hands of the enemy he has deceived.

**PAROLE EVIDENCE**, in Law, means such evidence as is given by witnesses by word of mouth at a trial or hearing of a cause. Parole Agreement, in English Law, means any agreement made either by word of mouth or by writing not under seal. If the agreement is made by writing under seal, it is called a deed, or indenture, or covenant, according to the nature of its contents.

**PAROPAMISA'N MOUNTAINS**. See **AFGHANISTAN**.

**PA'ROS**, one of the larger islands of the Grecian Archipelago, is situated west of Naxos, from which it is separated by a channel from four to six miles wide. Greatest length, 15 miles; greatest breadth, 9 miles; area, about 77 square miles; pop. 7200. The surface is hilly, the scenery picturesque, and

PAROTID GLAND—PARRAKEET.

the soil naturally fertile, but imperfectly cultivated. The island is especially productive in cotton, wax, honey, partridges, and wild pigeons. Near the middle of the island, the mountain Capresso (ancient *Marpessa*), abounds in the famous Parian marble, which was used by many of the greatest sculptors of antiquity. Parekhia, on the west coast, is the principal town, and Naussa, on the north east, is the chief port.

In ancient times, P., which is said to have been colonised by Cretans, attained great maritime prosperity, and became wealthy and powerful. It submitted to the Persians; and after the battle of Marathon was assailed ineffectually by Miltiades, who received here the wound of which he soon after died. After the defeat of Xerxes, P. came under the supremacy of Athens, and shared the fate of the other Cyclades. Archilochus, the inventor of Iambic verse, was born here.

PAROTID GLAND. See SALIVARY GLANDS.

PARQUETRY, a kind of wood mosaic used only for flooring. The art of making inlaid wood floors has until lately much declined in this country, but on the continent it has been much in use, and has been carried to great perfection. Parquetry floors are usually of oak, but other and more ornamental woods have also been much used for giving variety and beauty to the pattern. In the more elaborate kinds of parquetry, veneers are used, but it is much more generally composed of blocks of wood squared at the sides, and laid down so as to combine and form a geometric pattern. Of late, the taste for this work has revived in Britain, and it is beginning to be extensively employed in the better class of buildings.

PARR, SAMUEL, LL.D., a once notable scholar, was born January 15, 1747, at Harrow-on-the-Hill. He entered Emmanuel College, Cambridge, in 1765; but the death of his father, two years afterwards, necessitated his doing something for himself, and he was, in consequence, induced to accept an assistant-mastership at Harrow, where he remained five years. The head-mastership then becoming vacant, P. applied for it, but was rejected, whereupon he left, and started as an independent schoolmaster. In 1777, he was appointed Master of Colchester School, where he was ordained priest, and obtained the curacies of Hythe and Trinity Church. Next year, he became Master of Norwich School; but in 1786, settled at Hatton in Warwickshire, where he spent the rest of his life. In 1787, he published an edition of Bellenden, to which he prefixed his celebrated preface, which is as remarkable for its uncompromising advocacy of Whig principles as for the scrupulous Ciceronianism of its Latinity. He died March 6, 1825.

It is almost impossible to understand the reputation which P. once had. None of his voluminous writings justify it. That he was in some respects an accomplished, and even a great scholar, is undoubted, for he could write Latin of Ciceronian purity and finish; but it is equally undoubted that he never did anything with his boasted scholarship. P. has left the world absolutely nothing to keep it in remembrance of him, yet his complete works (edited by Dr J. Johnstone in 1828)—exclusive of his contributions to periodicals—form eight enormous tomes, and contain 5734 octavo pages, many of them printed in small type. They relate to matters historical, critical, and metaphysical, but in all of them 'the thread of Parr's verbosity is finer than the staple of his argument.' What, then, gave him the fame that he certainly enjoyed during his life? Beyond all question, it was his conversational powers. He was an amazing, an overwhelming

talker. Bold, dogmatic, arrogant, with a memory profoundly and minutely retentive, and with a genuine gift of ephemeral epigram, he seemed, at the tables of statesmen, and wits, and divines, to be a man of tremendous talent, capable of any literary feat; but the learning and the repartee have left little trace of their existence, and posterity declines to admire the wonders that it has neither seen nor heard. See De Quincey's famous essay on 'Dr Samuel Parr on Whiggism in its Relations to Literature' (Author's edition, vol. 5. Edin. Adam and Charles Black, 1862).

PARRA. See JACANA.

PARRAKEET, or PARROQUET, a name very commonly given to many of the smaller species of the parrot family; generally to species having long tails, and natives of the East Indies, Africa, and Australia, not so frequently to American species; although it is sometimes also applied to some of these, indifferently with the name Parrot.—One of the most beautiful groups of the *Psittacidae*, combining gracefulness of form with splendour of plumage, is that to which the ALEXANDRINA P. or RING P. (*Palaeornis Alexandri*) belongs. It is about the size of a common pigeon, green, with a red collar, whence its name Ring P., and is a native of the



Warbling Grass or Zebra Parrakeet (*Melospittacus undulatus*).

East Indies. It is said to have been brought to Europe by some of the members of Alexander the Great's expedition to India, and to have been the first of the parrot tribe known to the Greeks and Romans, by whom it was highly prized, as it still is, not only for its beauty, but for its docility and its power of imitating human speech. Like many of its tribe, it is gregarious, and immense flocks make their abode in some of the cocoa-nut groves of the western parts of Ceylon, filling the air with the most deafening screams. The Ring P. has many congeners, natives chiefly of the East Indies, exhibiting much variety of splendid plumage.—Somewhat like them in length and form of tail, but with longer and stronger legs, is the GROUND P., or GROUND PARROT (*Pezophaps formosus*), of Australia, a bird

## PARRHASIUS—PARROT.

very common in all the southern parts of New Holland and in Van Diemen's Land, inhabiting *scrubs* or ground covered with very low underwood. Its habits are very unlike those of parrots in general; it runs along the ground, and even seeks to escape from enemies by running, unwillingly takes wing, and then only for a short low flight. It makes no nest, but lays its eggs in a hole in the ground. It is a small bird, not much more than 12 inches in entire length, one half of which is occupied by the tail; its colour, dark green above, yellowish below, less brilliant than in many of the parrot tribe, but finely marked and mottled. Its flesh has a very strong *game* flavour. There are numerous other Australian species, distributed in several genera, some of which, although less exclusively than that just noticed, live and seek their food on the ground. Some of them exhibit the greatest splendour of plumage. The only one we shall notice is the ZEBRA P. (*Melopsittacus undulatus*), a very beautiful little species, which has often been brought to England, and has sometimes bred in it. In the vast inland plains of Australia, this P. is to be seen in flocks of many hundreds feeding on the seeds of the grasses, which afford food also to many other small species.

PARRHASIUS, one of the greatest painters of ancient Greece, was the son of Evenor, himself an artist, and was born at Ephesus in the 5th c. B.C. He practised his profession, however, at Athens, the inhabitants of which held him in high estimation, and conferred on him the rights of citizenship. He was already celebrated in the time of Socrates, with whom, according to Xenophon, he held a conversation (*Mem.* 3, 10), and was also a younger contemporary of Zeuxis. The date of his death is unknown. Seneca, who lived several hundred years after, tells a monstrous story about him. He says that when P. was painting his 'Prometheus Vincuus,' he got hold of one of the prisoners taken at the capture of Olynthus by Philip of Macedon (347 B.C.), and crucified him in his studio that he might copy from life the expression of agony. Fortunately for P.'s memory, the anecdote is almost certainly untrue, as it would require us to suppose that he was still alive and painting when upwards of 100 years old. P. appears to have surpassed all his predecessors in purity of design, accuracy of drawing, force of expression, and what is technically called 'finish.' According to Pliny, he was the first who established a true proportion between the different parts of a picture, and delineated with elegance and precision all the minutiae of the features, even to those evanescent motions that betray the most delicate sentiments of the soul. He painted the extremities, such as the hands and fingers, in so exquisite a style, that the intermediate parts seemed relatively—but only relatively—inferior. Quintilian calls him the legislator of his art, because his canon of proportion for gods and heroes was followed by all contemporary and subsequent painters. Among his works were an apparently symbolical picture of the Athenian *Demos* ('People'), a 'Theseus,' 'Naval Commander in full Armour,' 'Ulysses feigning Madness,' 'Castor and Pollux,' 'Bacchus and Virtue,' a 'Meleager, Hercules, and Perseus' on one canvas, a 'Cretan Nurse with a Child in her Arms,' a 'Priest officiating with a Child bearing Incense,' 'Two Young Children,' an 'Achilles,' an 'Agamemnon,' &c. But his subjects were not always of a pure or lofty character. His 'Archigallus' (high-priest of Cybele) and his 'Meleager and Atalanta' were most licentious representations, and gave such pleasure to the Emperor Tiberius, a man of unbounded sensuality, that he kept them in his

bedroom, and valued the second in particular at more than a million sesterces.

P. was of an excessively proud and arrogant disposition. He called himself the prince of painters, and claimed to be descended from Apollo; he also painted himself as the god Mercury, and then exposed his own portrait for the adoration of the crowd. His vanity was equal to his pride, and shewed itself even in his apparel, which was of the kind called 'gorgeous.' He generally dressed in a purple robe with a golden fringe, sported a gold-headed cane, and wore boots tied with golden clasps.

PARRICIDE (Lat. *paricida*) is rather a popular than a legal term. In the Roman law it comprehended every one who murdered a near relative; but in English the term is usually confined to the murderer of one's father, or of one who is *in loco parentis*. The parricide does not, in any respect, differ in Britain from the murderer of a stranger; in both cases, the punishment is death by hanging. In the Roman law, a parricide was punished in a much more severe manner, being sewed up in a leather sack, along with a live cock, viper, dog, and ape, and cast into the sea to take his fate with these companions.

PARROT (*Psittacus*), a Linnæan genus of birds, now the family *Psittacide*, of the order *Scansores*, or Climbers (q. v.), comprehending a vast number of species, natives of almost all tropical and subtropical regions; a few species extending further north and south, in America, in New Zealand, and in Van Diemen's Land, even to the neighbourhood of Lake Michigan in North America, and to Terra del Fuego in South America. They are mostly birds of splendid plumage; they vary very much in size, from the Great Macaw, more than three feet in length, tail included, to the little Love-birds, not larger than sparrows. They are mostly gregarious, and are often seen in vast flocks, generally inhabiting forests, and making their nests in trees, feeding chiefly on fruits and seeds, partly also on leaves and buds; but some of them dwelling in open plains, feeding on the seeds of grasses and other plants of humble growth, bulbs and succulent parts of vegetables, and living mostly on the ground. The voices of the P. tribe are generally harsh and discordant, although some of the smaller kinds have not unpleasant voices; but many of the larger have a remarkable power of imitating human speech, and in domestication become capable of articulating not only words but sentences. They exhibit a greater degree of intelligence than is usual in birds, with a monkey-like restlessness and love of trick; and although docile and affectionate, are generally of capricious irritable temper. They have a short, stout, hard beak, rounded on all sides, and enveloped at the base in a membrane in which the nostrils are pierced; the upper mandible generally much longer than the lower, much curved, and sharp pointed. The tongue is almost always very large, thick, round, and fleshy; the muscles which move the mandibles are more numerous and powerful than in most other birds. They make use of the powerful hooked bill as well as of the feet in climbing trees; and employ their feet as hands for holding their food, and bringing it up to the mouth. Their feet differ from those of all the other climbers, in being covered with small tubercle-like scales instead of plates. Some have short and some have long tails. Most of them have short wings. Their intestines are very long and slender, and without coeca.

The *Psittacide* are easily distinguished from all other birds; but their division into distinct subordinate groups has not been found so easy.



## PARROT-FISH—PARRY.

Whilst the name *P.* popularly includes all, except that it is seldom given to some of the smallest species, some are known by the names Macaw, Cockatoo, Parrakeet, Lory, Love-bird, &c. See these heads. But some of these names are very vaguely applied. And although the *P.* family is regarded as consisting of a number of very natural groups, the characters and limits of these groups have not yet been very well defined.

The name *P.*, in its most restricted sense, is sometimes applied only to those species which have the upper mandible very distinctly toothed, the lower mandible longer than it is high; and the tail short, and square or rounded; but this use is rather ornithological than popular, the most restricted popular use equally including long-tailed species, such as the Caroline *P.*, which are ornithologically ranked with the macaws.—The CAROLINE *P.* (*Conurus Carolinensis*) is the species of which the northern range extends far beyond all others of its tribe to the shores of Lake Michigan; although by the increase of cultivation, and the war waged against these birds for their depredations on orchards and corn-ricks, their numbers have been greatly diminished in regions where they were once plentiful. Its whole length is about 14 inches, of which about one half is occupied by the tail; the general colour is green, shaded with blue, and diversified with orange, the wing primaries almost black. It is gregarious, prefers to roost in the holes of hollow trees, and in such situations also the females lay their eggs. It seems to love salt, frequenting salt licks like pigeons. It is easily tamed, but does not acquire the power of articulation.—Of the short-tailed parrots, one of the best known is the GRAY *P.* (*Psittacus erythacus*), a West African species, about the size of a small pigeon, of an ash-gray colour, with a crimson tail. It is famous for its docility, its power of articulation and of imitating noises of all kinds, its loquacity, and its mischievousness. It is very often brought to Europe, and often lives to a great age in confinement. Individuals have been known to attain the age of nearly 100 years.—The GREEN PARROTS (*Chrysolis*), natives of the tropical parts of South America, are also among the short-tailed parrots most frequently seen in Britain.

PARROT-FISH (*Scarus*), a genus of fishes of the family *Labridæ* (q. v.) or *Cyclo-Labridæ*, of oblong and massive form, with large scales, and remarkable for the structure of their jaws and

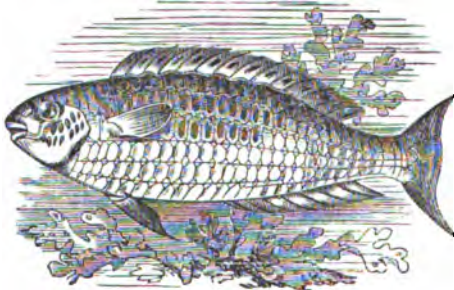

Parrot-fish (*Scarus harid*).

teeth, the jaws being divided into halves by a median suture, the teeth incorporated with the bone in crowded quincuncial order, the surface even and polished in some species and rough in others, the oldest teeth forming the trenchant border of the jaw, and being succeeded by others as they are worn away, whilst new ones are formed behind.

The species are numerous. Some of them feed on fuci, and some on corals, the younger branches of which they crush, so that the animal part affords them nourishment, whilst the calcareous part is rejected. They are fishes generally of brilliant colours, some of them of wonderful splendour, and have received the name parrot-fish partly on this account, and partly on account of a fancied resemblance in their jaws to a parrot's bill. Most of them are natives of tropical seas. One species is found in the Mediterranean (*S. Creticus*), the *Scarus* of the ancients, of which many wonderful stories were told, as to its love, its wisdom, its ruminating, its emitting of sounds, &c., and which was esteemed the most savoury and delicate of all fishes. It is still held in high esteem for the table. The Greeks cook it with a sauce made of its own liver and intestines.

PARRY, SIR WILLIAM EDWARD, commonly known as SIR EDWARD PARRY, a celebrated English navigator, was born at Bath, 19th December 1790. His father, who was a physician of some eminence, destined him for the medical profession; but acting on the advice of a friend, entered him as a first-class volunteer on board the *Ville-de-Paris*, the flag-ship of the Channel fleet, in 1803. After several years' service, he received his commission as lieutenant, January 6, 1810. Though thus early engaged in active service, his education had not been neglected; he had attained at school to considerable eminence in classical knowledge; and for the first five years after entering the navy, he had particularly studied French and mathematics under the chaplain's superintendence, after which he constantly employed his leisure time in nautical and astronomical studies. In February 1810, he was sent to the Arctic regions in command of a ship, for the purpose of protecting the British whale fisheries and improving the admiralty charts of those regions; but in 1813, he was recalled and despatched to join the fleet then blockading the coast of the United States. He remained on the North American station till the spring of 1817, and during this time he wrote and distributed MS. copies of a work entitled *Nautical Astronomy by Night*, in which rules were given for determining accurately the altitude of the pole by observations of the fixed stars. This work he subsequently published in London. Having returned to England too late to take part in the African exploring expedition, he was, at his urgent request, backed by the recommendations of Mr Barrow, secretary to the Admiralty, appointed to the command of the *Alexander*, under the orders of Captain John Ross in the *Isabella*, and despatched in search of the 'North-West Passage' (q. v.) in April 1818. The expedition returned to England, having made no important discoveries. The admiralty were dissatisfied with the report of Captain Ross; and P.'s opinion, though only communicated to his private friends, having become known to them, he was again sent out (May 1819), and this time commenced that career of discovery (see NORTH-WEST PASSAGE) which has immortalised him as the greatest of all Arctic explorers. P. on his return to Britain was hailed with the utmost enthusiasm, and was made commander (4th November 1820) and a member of the Royal Society. He subsequently made a second and a third voyage to the same regions, but effected nothing further of importance. P. now devoted himself to the discharge of his duties as hydrographer, but such labours were too monotonous for one of his temperament, and he accordingly prepared a plan of an expedition for reaching the north pole, which being submitted to the admiralty and approved of

by them, his old ship the *Hecla* was fitted out for a polar expedition, and P. set sail in her, accompanied by Lieutenant J. C. Ross, 4th April 1827. See POLAR VOYAGES. The *Journals* of these voyages were published by order of the admiralty.

P.'s career as an explorer was now closed, and he again returned to his duties as hydrographer, but his health now gave way under this sedentary mode of life, and he exchanged his office for that of commissioner to the Agricultural Company of Australia, for which country he sailed 20th July 1829. He returned to England in November 1834, and filled in succession various government appointments up till December 1846, when he retired from active service, receiving a sinecure office. On 4th June 1852 he was raised to the rank of Rear-admiral of the White, and in the following year was appointed lieutenant-governor of Greenwich Hospital—an office which he held till his death, 7th July 1855, at Ems in Germany, whither he had gone for the benefit of his health. A complete edition of his voyages was published in 1833 (Lond. 5 vols.). His life has been written by his son, the Rev. Edward Parry, M.A. of Balliol College, Oxford, 1857).

PARSEES (People of Pars or Fars, i. e., ancient Persia) is the name of the small remnant of the followers of the ancient Persian religion, as reformed by Zerdusht, or Zoroaster, as he is commonly called. They are also known under the denomination of Guebres, under which head some account will be found respecting their recent history and present numbers. The pre-Zoroastrian phase or phases of their primeval religion will probably for ever remain shrouded in deep obscurity; so much, however, is fully established by recent investigations, that this, and what afterwards became the Brahmanic religion, were originally identical; that in consequence of certain social and political conflicts between the Iranians and the Aryans, who afterwards peopled Hindustan Proper, an undying feud arose, in the course of which the former forswore even the hitherto common faith, and established a counter faith (Ahura), a principal dogma of which was the transformation of the ancient, now hostile, gods into demons, and the branding of the entire Deva religion as the source of all mischief and wickedness. Zerdusht, the prophet, whose era is given very differently by ancient writers and by modern investigators, placed variously between 500 or 600 B.C. (Röth) and 1200 B.C. (Haug), had, like all prophets and reformers, many predecessors, chiefly among the Sohyantos or Fire-priests (Atharvans); yet to him belongs the decisive act of separating for ever the contending parties, and of establishing a new community with a new faith—the Mazdayasna or Parsee religion proper, which absorbed the old Ahura religion of the fire-priests. Referring for a summary of what is known and speculated about the person of the great reformer to the article under his name, we shall here confine ourselves to pointing out, as the characteristics of his leading doctrines, that the principle of his theology was as pure a Monotheism as ever the followers of the Jehovistic faith were enjoined. He taught the existence of but one deity, the Ahura, who is called Mazdaö (see ORMUZD), the creator of all things, to whom all good things, spiritual and worldly, belong. The principle of his speculative philosophy is dualism, i. e., the supposition of two primeval causes of the real and intellectual world; the Vohu Manö, the Good Mind or Reality (Gaya), and the Akem Manö, or the Naught Mind, or Non-reality (Ajyâiti); while the principle of his moral philosophy is the triad of Thought, Word, and Deed. Not long, however, did the pure idea of Monotheism prevail. The two sides

of Ahura Mazdaö's being were taken to be two distinct personages—God and Devil—and they each took their due places in the Parsee pantheon in the course of time:—chiefly through the influence of the sect of the Zendiks, or followers of the Zend, i. e., Interpretation. According to Zerdusht, there are two intellects, as there are two lives—one *menta*, and one *bodily*; and, again, there must be distinguished an *earthly* and a *future* life. The immortality of souls was taught long before the Semites had adopted this belief. There are two abodes for the departed—Heaven (Garö-Demâna, the House of the Angels' Hymns, Yazna, xxviii. 10; xxxiv. 2; cf. Ia. vi., Revelat., &c.) and Hell (Drâjö-Demâna, the residence of devils and the priests of the Deva religion). Between the two there is the Bridge of the Gatherer or Judge, which the souls of the pious alone can pass. There will be a general resurrection, which is to precede the last judgment, to foretell which Sosioah (Soskyans), the son of Zerdusht, spiritually begotten (by later priests divided into three persons), will be sent by Ahuramazdao. The world, which by that time will be utterly steeped in wretchedness, darkness, and sin, will then be renewed; death, the archfiend of creation, will be slain, and life will be everlasting and holy. These are the outlines of the Zoroastrian creed, as it flourished up to the time of Alexander the Great, throughout ancient Irania, including Upper Tibet, Cabulistan, Sogdiana, Bactriana, Media, Persia, &c.; and it is curious to speculate on the consequences which might have followed Marathon and Salamis had the Persians been victorious. The religion of Ormuzd would have dethroned the Olympians, as it dethroned the gods of the Assyrians and Babylonians; and it would certainly have left its traces upon the whole civilised world unto this day in a much more direct and palpable shape than it now does. From the death of Alexander, however, it gradually lost ground, and rapidly declined under his successors, until, in the time of Alexander Severus, Ardshir 'Arianos' (cf. Mirkhond ap. de Sacy, *Mémoires sur div. Aut. de la Perse*, &c., p. 59), the son of Babegan, called by the Greeks and Romans Artaxerxes or Artaxares, who claimed descent from the ancient royal lineage of Persia, took the field against Artabanus, and slew him (225), thus putting an end to the four hundred years' rule of the Parthians, and founded the Sassanide dynasty. This he effected in conjunction with the national Persians, who hated the 'semi-Greek' dynasty of the Arsacide, their leaning to the foreign, and contempt for the Zend religion, and finally for their powerlessness against the spreading conquests of the Romans. The first act of the new king was the general and complete restoration of the partly lost, partly forgotten books of Zerdusht, which he effected, it is related, chiefly through the inspiration of a Magian Sage, chosen out of 40,000 Magians. The sacred volumes were translated out of the original Zend into the vernacular, and disseminated among the people at large, and fire temples were reared throughout the length and the breadth of the land. The Magi or priests were all-powerful, and their hatred was directed principally against the Greeks. 'Far too long,' wrote Ardshir, the king, to all the provinces of the Persian empire, 'for more than five hundred years, has the poison of Aristotle spread.' The fanaticism of the priests often also found vent against Christians and Jews. The latter have left us some account of the tyranny and oppression to which they as unbelievers were exposed—such as the prohibition of fire and light in their houses on Persian fast-days, of the slaughter of animals, the baths of purification, and the burial of the dead according

to the Jewish rites—prohibitions only to be bought off by heavy bribes. In return, the Magi were cordially hated by the Jews, and remain branded in their writings by the title of demons of hell (*Kidushin*, 72 a.). To accept the instruction of a Magian is pronounced by a Jewish sage to be an offence worthy of death (*Shabb*, 75 a.; 156 b.). This mutual animosity does not, however, appear to have long continued, since in subsequent times we frequently find Jewish sages (Samuel *the Arian*, &c.) on terms of friendship and confidence with the later Sassanide kings (cf. *Moed Katan*, 26 a. &c.). From the period of its re-establishment, the Zoroastrian religion flourished uninterrupted for about 400 years, till, in 651 A.D., at the great battle of Nahavand (near Ecbatana), the Persian army, under Yezdezdird, was routed by the Calif Omar. The subsequent fate of those that remained faithful to the creed of their fathers has been described, as we said before, under GUEBRES. At present, some remnants inhabit Yezd and Kirmān, on the ancient soil of their race; others, who preferred emigration to the endless tribulations inflicted upon them by the conquering race, found a resting-place along the western coast of India, chiefly at Bombay, Surat, Nawsari, Achmedābād, and the vicinity, where they now live under English rule, and are recognised as one of the most respectable and thriving sections of the community, being for the most part merchants and landed proprietors. They bear, equally with their poorer brethren in Persia, with whom they have of late renewed some slight intercourse for religious and other purposes—such as their Rivāyets or correspondences on important and obscure doctrinal points—the very highest character for honesty, industry, and peacefulness, while their benevolence, intelligence, and magnificence outvies that of most of their European fellow-subjects. Their general appearance is to a certain degree prepossessing, and many of their women are strikingly beautiful. In all civil matters they are subject to the laws of the country they inhabit; and its language is also theirs, except in the ritual of their religion, when the holy language of Zend is used by the priests, who, as a rule, have no more knowledge of it than the laity.

We have spoken of the leading fundamental doctrines as laid down by their prophet. Respecting the practical side of their religion, we cannot here enter into a detailed description of their very copious rituals, which have partly found their way into other creeds. Suffice it to mention the following few points. They do not eat anything cooked by a person of another religion; they also object to beef, pork, especially to ham. Marriages can only be contracted with persons of their own caste and creed. Polygamy, except after nine years of sterility and divorce, is forbidden. Fornication and adultery are punishable with death. Their dead are not buried, but exposed on an iron grating in the Dokhma, or Tower of Silence, to the fowls of the air, to the dew, and to the sun, until the flesh has disappeared, and the bleaching bones fall through into a pit beneath, from which they are afterwards removed to a subterranean cavern.

Ahuramazdao being the origin of light, his symbol is the sun, with the moon and the planets, and in default of them the fire, and the believer is enjoined to face a luminous object during his prayers. Hence, also, the temples and altars must for ever be fed with the holy fire, brought down, according to tradition, from heaven, and the sullyng of whose flame is punishable with death. The priests themselves approach it only with a half-mask (Penom) over the face, lest their breath should defile it, and never touch it with their

hands, but with holy instruments. The fires are of five kinds; but however great the awe felt by Parsees with respect to fire and light (they are the only eastern nation who abstain from smoking), yet they never consider these, as we said before, as anything but emblems of Divinity. There are also five kinds of 'Sacrifice,' which term, however, is rather to be understood in the sense of a sacred action. These are—the slaughtering of animals for public or private solemnities; prayer; the Daruns sacrament, which, with its consecrated bread and wine in honour of the primeval founder of the law, Hom or Heomoh (the Sanscr. *Soma*), and Dahman, the personified blessing, bears a striking outward resemblance to the sacrament of the Lord's Supper; the sacrifice of Expiation, consisting either in flagellation, or in gifts to the priest; and, lastly, the sacrifice for the souls of the dead. The purification of physical and moral impurities is effected, in the first place, by cleansing with holy water (Nirang), earth, &c.; next, by prayers (of which sixteen, at least, are to be recited every day) and the recitation of the divine word; but other self-castigations, fasting, celibacy, &c., are considered hateful to the Divinity. The ethical code may be summed up in the three words—purity of thought, of word, and of deed: a religion 'that is for all, and not for any particular nation,' as the Zoroastrians say. It need hardly be added, that superstitions of all kinds have, in the course of the tribulations of ages, and the intimacy with neighbouring countries, greatly defiled the original purity of this creed, and that its forms now vary much among the different communities of the present time.

Something like a very serious schism, however, has lately broken out in the Parsee communities, and the modern terms of Conservative and Liberal, or rather bigot and infidel, are almost as freely used with them as in Europe. The sum and substance of these innovations, stoutly advocated by one side, and as stoutly resisted by the other, is the desire to abolish the purification by the Nirang—a filthy substance in itself—to reduce the large number of obligatory prayers, to stop early betrothal and marriage, to suppress the extravagance in funerals and weddings, to educate women, and to admit them into society. Two counter alliances or societies, the 'Guides of the Worshippers of God' and 'the True Guides' respectively, are trying to carry out at this moment, by means of meetings, speeches, tracts, &c., the objects of their different parties.

The literature of the Parsees will be found noticed under PERSIAN LANGUAGE AND LITERATURE, and ZEND-AVESTA. Besides the latter, which is written in ancient Zend, and its Gujarati translation and commentaries, there are to be mentioned, as works specially treating of religious matters, the *Zardusht-Nameh*, or *Legendary History of Zerdusht*; the *Sadder*, or *Summary of Parsee Doctrines*; the *Dabistan*, or *School of Manners*; the *Desatir*, or *Sacred Writings*, &c. All these have been translated into English and other European languages.

On the influence Parsism has had upon Judaism and its later doctrines and ceremonial, and, through it, upon Christianity and Mohammedanism—which besides drew from it directly—we cannot dwell here at any length. So much, however, may be stated, that the most cursory reading of the sacred Parsee books will shew, in a variety of points, their direct influence upon the three Semitic creeds. Of works treating on the subject of this article, we mention principally, Hyde, *Vet. Rel. Pers. Hist.* (Oxon. 1760, 4to); Ousely, *Travels in the East* (Lond. 1819); Anquetil du Perron, *Exposition des Usages des*

*Parsees*; Rhode, *Die heil. Sage der alten Baktrier, Meder u. Perser*, &c. (Frank.-a-M., 1820, 8vo); Dosabhoj Framjee, *The Parsees*, &c. (Lond. 1858); Dadabhai Naoroji, *The Manners and Customs of the Parsees*; and *The Parsee Religion* (Liverpool, 1861, 8vo); and lastly, Haug's *Essays on the Parsee Religion* (Bombay, 1862), and Spiegel's *Erän* (Berl. 1863).

PARSLEY (*Petroselinum*), a genus of plants of the natural order *Umbellifera*. The species are annual or biennial, branching, smooth, herbaceous plants, with variously pinnated leaves.—COMMON P. (*P. sativum*), which has tripinnate shining leaves, one of our best known culinary plants, is a native of the south of Europe, growing chiefly on rocks and old walls, and naturalised in some parts of England. The cultivation of P. is extremely simple, and an annual sowing is generally made, although when cut over and prevented from flowering, the plant lives for several years. A variety with curled leaflets is generally preferred to the common kind with plain leaflets, as finer and more beautiful, being often used as a garnish; it is also safer, as the poisonous Fool's P. (q. v.) is sometimes gathered by mistake instead of the other.—HAMBURG P. is a variety with a large white carrot-like root, cultivated for the sake of its root, and much in the same way as the carrot or parsnip. To produce large roots and of delicate flavour, a very rich soil is required. The foliage of P. is not merely of use for flavouring soups, &c., but is nutritious, at the same time that it is stimulating, a quality which it seems to derive from an essential oil present in every part of the plant. P. contains also a peculiar gelatinous substance called *Apiine*. The bruised leaves of P. are sometimes employed as a stimulating poultice. The seeds are a deadly poison to many birds, and when powdered, they are sometimes used for killing lice.

PARSNIP (*Pastinaca*), a genus of plants of the natural order *Umbellifera*, having compound umbels with neither general nor partial involucre; yellow flowers with roundish, involute, sharp-pointed petals; calyx almost without teeth; fruit dorsally compressed and flat, with a broad border, the ridges very fine. The species are annual, biennial, or perennial herbaceous plants, with carrot-like, often fleshy roots, and pinnate leaves.—THE COMMON P. (*P. sativa*) is a native of England, although not of Scotland, and is abundant in some districts, particularly in chalky and gravelly soils. It is also found in many parts of Europe, and of the north of Asia. It is a biennial, with angular furrowed stem, 2—3 feet high, pinnate leaves with ovate leaflets, rather shining, cut and serrated, and a three-lobed terminal leaflet. The root of the wild plant is white, aromatic, mucilaginous, sweet, but with some acridness; and injurious effects have followed from its use. Cultivation has greatly modified the qualities both of the root and foliage, rendering them much more bland. The P. has long been cultivated for the sake of its root, which in cultivation has greatly increased in size, and become more fleshy. The flavour is disliked by some, as well as the too great sweetness, but highly relished by others; and the root of the P. is more nutritious than that of the carrot. The produce is also, on many soils, of larger quantity; and although the P. delights in a very open rich soil, it will succeed in clayey soils far too stiff for the carrot. It is rather remarkable that it has not been extensively cultivated as a field-crop, and for the feeding of cattle, except in the Channel Islands and in limited districts of continental Europe; more particularly as cattle are very fond of it, and not only the flesh of cattle fed on it is of excellent quality, but the butter of dairy-cows fed on parsnips

in winter is far superior to that produced by almost any other kind of winter-feeding. The mode of cultivation of the P. scarcely differs from that of the carrot. There are several varieties in cultivation. A very large variety, cultivated in the Channel Islands on deep sandy soils, has roots sometimes three or four feet long; but this is fully twice the ordinary length, and there is a smaller turnip-rooted variety sometimes cultivated in gardens where the soil is very shallow. The P. is used chiefly in winter, whether for the table or for feeding cattle. It is improved rather than injured by frost; but is apt to become *rusty*, if allowed to remain too long in the ground; and exhibits acrid qualities after it has begun to grow again in spring. The root of the P. is much used in the north of Ireland for making a fermented liquor, with yeast and hops; and both in England and Ireland, for making P. wine, which has some resemblance to Malmsey wine.—Another species, the CUT-LEAVED P. or SEKAKUL (*P. Sekakul*), having pinnatifid cut leaflets, a native of India, Syria, and Egypt, is cultivated in the Levant, and is very similar in its uses to the common parsnip.

PARSON, in English Ecclesiastical Law, means the incumbent of a benefice in a parish. He is called parson (Lat. *persona*) because he represents the church for several purposes. He requires to be a member of the Established Church of England, and to be duly admitted to holy orders, presented, instituted, and inducted; and requires to be 23 years of age. When he is inducted, and not before, he is said to be in full and complete possession of the incumbency. The theory is, that the freehold of the parish church is vested in him, and as the legal owner, he has various rights of control over the chancel. He is also the owner of the churchyard, and as such is entitled to the grass. As owner of the body of the church, he has a right to control of the church bells, and is entitled to prevent the churchwardens from ringing them against his will. The distinction between a parson and vicar is, that the parson has generally the whole right to the ecclesiastical dues in the parish, whereas the vicar has an appropriator over him, who is the real owner of the dues and tithes, and the vicar has only an inferior portion. The duty of the parson is to perform divine service in the parish church under the control of the bishop, to administer the sacraments to parishioners, to read the burial-service on request of the parishioners, to marry them in the parish church when they tender themselves. He is bound to reside in the parish, and is subject to penalties and forfeiture, if he without cause absent himself from the parish. He is subject to the Clergy Discipline Act, in case of misconduct.

PARSONSTOWN (anciently called BIRR), a considerable inland town on the river Brosna, in King's County, Ireland, 69 miles west-south-west from Dublin, with which city it is connected by a branch-line issuing from the Great Southern and Western Railway at Ballybrophy. Pop. in 1861, 5220; of whom 4154 were Roman Catholics, 866 Protestants of Established Church, and the rest Protestants of other denominations. Birr had its origin at an early period in a monastery founded by St Brendan, and was the scene of many important events, both in the Irish and in the post-Invasion periods. The castle, which was anciently the seat of the O'Carrolls, was granted by Henry II. to Philip de Worcester; but it frequently changed masters, and even alternated between English and Irish hands. By James I. it was granted to Lawrence Parsons, ancestor of the present proprietor, the Earl of Rosse; but through the entire period of

the civil wars, its possession was constantly disputed, until after 1690, when the Parsons family was finally established in possession of the castle and adjoining lands. About this time, Birr returned two members to parliament, but the privilege was a temporary one. The castle has been rebuilt. The modern P. is one of the handsomest and best built and appointed inland towns in Ireland, with two handsome churches, and several meeting-houses, a nunnery, a handsome pillar with a statue of the Duke of Cumberland, a town-hall, a library, literary institute, a model and other schools. But the great attractions of P. are the castle, the observatory, and the laboratory of the Earl of Rosse (q. v.). P. is an important corn-market, a considerable centre of inland commerce; but with the exception of a distillery and brewery, it is almost entirely without manufactures. It is a large military station, and is also the seat of a Union workhouse.

**PĀRSWANĀTHA**, the twenty-third of the deified saints of the Jainas, in the present era. He and *Mahastra*, the twenty-fourth, are held in highest esteem, especially in Hindustan. In a suburb of Benares, called Belupura, there is a temple honoured as the birthplace of Pārs'wanātha. See JAINAS.

**PART**, in Music. When a piece of music consists of several series of sounds performed simultaneously, each series is called a part.

**PARTERRE**, in gardens laid out in the old French style, the open part in front of the house, in which flower-beds and closely-cut lawn were intermingled according to a regular plan.

**PAR'THENOGENESIS** (from the Gr. *parthenos*, a virgin, and *genesis*, the act of production) is a term invented by Professor Owen to indicate propagation by self-splitting or self-dividing, by budding from without or within, and by any mode save by the act of impregnation; the parthenogenetic individuals being sexless or virgin females. See the article GENERATIONS, ALTERNATION OF. For many remarkable facts in relation to parthenogenesis in insects, the reader is referred to Professor Owen's eighteenth lecture, *On the Comparative Anatomy and Physiology of Invertebrate Animals*; and to Siebold, *On Parthenogenesis*, translated by Dallas.

**PAR'THENON**, the temple of Minerva at Athens; one of the most celebrated of the Greek temples, and usually regarded as the most perfect specimen of Greek architecture. Many of the sculptures have been brought to England, and are now in the British Museum. See GRECIAN ARCHITECTURE.

**PARTHENOPE'AN REPUBLIC** (from *Partheneope*, the oldest name of the city of Naples) was the name given to the state into which the kingdom of Naples was transformed by the French Republicans, 23d January 1799, and which only lasted till the following June, when the invading army was forced to retreat.

**PAR'THIA**, anciently a country of Western Asia, lying at the south-east end of the Caspian Sea, from which it was separated by a narrow strip, known as Hyrcania, now forms the northern portion of the province of Khorassan, and is an almost wholly mountainous region. Its rivers are merely mountain torrents, which are supplied by the melting snow on the Elburz range during winter and spring, but are mostly dry in summer and autumn.

The original inhabitants are believed to have been of Scythian race, as shewn by their language as well as by their manners, and to belong to the great Indo-Germanic family. If this be the case, as is very probable, the term Parthian, from its analogy

to the Scythian word *parthe*, banished, seems to indicate that they were a tribe who had been driven to P. out of Scythia (i. e., Central Asia). The Parthians, during the time of the Roman Republic, were distinguished by primitive simplicity of life and extreme bravery, though at the same time much given to bacchanalian and voluptuous pleasures. They neglected agriculture and commerce, devoting their whole time to predatory expeditions and warfare. They fought on horseback, and after a peculiar fashion. Being armed solely with bows and arrows, they were rendered defenceless after the first discharge; and, to gain time for adjusting a second arrow to the bow, turned their horses, and retired, as if in full flight, but an enemy incautiously pursuing, was immediately assailed by a second flight of arrows; a second pretended flight followed, and the conflict was thus carried on till the Parthians gained the victory, or exhausted their quivers. They generally discharged their arrows backwards, holding the bow behind the shoulder; a mode of attack more dangerous to a pursuing enemy than to one in order of battle. The Parthians first appear in history as subject to the great Persian Empire. After the death of Alexander the Great, P. formed part of the Syrian kingdom, but revolted under Antiochus II., and constituted itself into an independent kingdom under the *Arsacidae* (see ARSACIDS), 250 B.C., a race of kings who exercised the most completely despotic authority ever known, treating their subjects as if the vilest of slaves; yet so accustomed did the Parthians become to this odious rule, that some of the later monarchs, who had received a Roman education, and after their accession treated their subjects with ordinary justice and humanity, were completely despised. The capital of the Parthian monarchy was Hecatompylos ('the city of the hundred gates'), now Damgan. The Parthian dominion rapidly extended to the Euphrates on the west and the Indus on the east, and became a most powerful and flourishing empire; Seleucia, Ctesiphon—the capital of the Persian emperors of the Sassanidae—and other celebrated cities date their rise from this period, and soon eclipsed, in size and splendour, the ancient Hecatompylos. In spite of repeated attacks on the part of the Romans, the Parthians maintained their independence (see CRASSUS, SURENA); and though Trajan, in 115—116 A.D., seized certain portions of the country, the Romans were soon compelled to abandon them. In 214 A.D., during the reign of Artabanus IV., the last of the Arsacidae, a revolt, headed by Ardashir, son of Babegan, broke out in Persia, and the Parthian monarch, beaten in three engagements, lost his throne and life, while the victor substituted the Persian dynasty of the SASSANIDÆ (q. v.) for that of the Arsacidae. Some scions of the Parthian royal family continued for several centuries to rule over the mountainous district of Armenia, under the protection of the Romans, and made frequent descents upon Assyria and Babylonia; but their history is obscure and of little importance.

**PARTIAL LOSS**, in the law of Marine Insurance, is a loss which is not total; and therefore the insurer is not entitled to abandon or give up the remains of the ship or cargo, and claim the entire insurance money; but he is bound to keep his ship or goods, and claim only in proportion to his actual loss or damage.

**PARTICIPLE** (Lat. *participium*, part-taking). the name of a class of words which have the meaning of a verb with the form of an adjective. The name is said to have been given from their partaking of the nature both of a verb and of an adjective.

## PARTICK—PARTNERSHIP.

Some grammarians make the participle a distinct part of speech, but it is more commonly classed as a part of the conjugation of the verb. There are in English two participles, one in *ing*, usually called the present, but properly the imperfect, because it expresses continued, unfinished action, e. g., *loving, writing*; and the other expressing past action, and ending either in *ed* (*t*) or in *en*, e. g., *loved, written*. In Ang.-Sax. and Old Eng., the imperfect participle ended in *and*, e. g., *haband* (having), corresponding to the modern Ger. *habend*, Gr. *echont*(os), Lat. *habent*(is). In the sentence, 'He is writing a letter,' *writing* is the imperfect participle; in 'the writing of the letter occupies him,' or '*writing* is a difficult art,' it is a substantive, and had a different origin. In the latter case, *-ing* corresponds to the Ang.-Sax. termination *-ung*, used in forming substantives from a large class of verbs; thus, Ang.-Sax. *halgung* (hallowing) is equivalent in meaning and in etymology to Lat. *consecratio*; similarly, modern Ger. *Vernichtung*, annihilation, from *vernichten*, to annihilate. Such a phrase as, 'while the letter is writing,' seems to be a shortened form of the now antiquated, 'is a-writing,' which was originally, 'is in writing.' Although this mode of expression is liable in some cases to ambiguity, it is terser and more idiomatic than the circumlocution of, 'is being written,' which is often substituted for it. The verbal substantive in *-ing* is often exactly equivalent to the infinitive; thus, '*standing* long in one position is painful' = '*to stand*,' &c. It has this advantage, that while it can be construed as a noun (e. g., with a possessive case), it can retain at the same time the usual adjuncts of a verb; as, 'What are we to infer from the king's dismissing his minister?' The use of this form contributes not a little to the peculiar brevity and strength of the English language.

**PARTICK**, a town of Scotland, in the county of Lanark, prettily situated, chiefly on a rising ground on the Kelvin, immediately above its junction with the Clyde, and about three miles west-north-west of the Cross of Glasgow, of which city it now forms a suburb. Nine-tenths of the workmen of P. are engaged in ship-building, and there are numerous ship-building yards, flour-mills, cotton factories, and bleach-fields. A large proportion of the inhabitants are engaged in business in Glasgow, and for their accommodation extensive ranges of handsome villas have been built here. Pop. 1851, 3131; 1861, 8183.

**PARTINICO, SALA DI**, a post-town of Sicily, in the province of Palermo, and 19 miles south-west of the city of that name, at the foot of a grand precipice of red limestone. The plain in the vicinity is of surpassing fertility; corn, wine, oil, fruit, and sumach are produced in rich abundance; and linen and woollen goods are manufactured. Pop. 15,658. Scattered vestiges of ancient habitations are still to be seen on the summit of the height above the town, and are said to be the ruins of the ancient *Parthemcum* mentioned in the *Itinerary* of Antoninus and there only.

**PARTISAN** is a name for a halberd or pike, or for a marshal's baton. The name is also given to the leader of a detached body of light troops, who make war by harassing the enemy, rather than coming to direct fighting, by cutting off stragglers, interrupting his supplies, and confusing him by rapid strategy. The action of such a corps is known as *Partisan warfare*.

**PARTITION**, a thin interior wall dividing one apartment from another. It is usually of brick-work,  $4\frac{1}{2}$  or 9 inches thick, or of timber with standards about  $4\frac{1}{2}$  inches thick covered with lath

and plaster. Wooden partitions are used when there is no sufficient support for brick. When these have to carry joists or any other weight, they ought to be constructed in the form of a truss (q. v.).

**PARTITION**, or **PARTITURA**, in Music. See **SCORE**.

**PARTITION LINES**, in Heraldry, lines dividing the shield in directions corresponding to the ordinaries. According to the direction of the partition lines, a shield is said to be party or parted per fess, per pale, per bend, per chevron, per saltire;

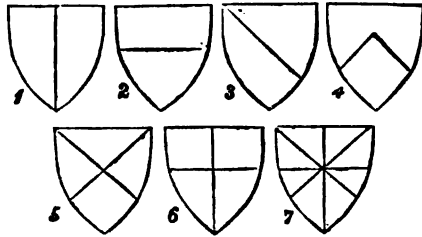

Partition Lines in Heraldry.

a shield divided by lines in the direction of a cross, is said to be quartered; and a shield parted at once per cross and per saltire, is said to Gironné (q. v.) of eight. The partition lines are not always plain; they may be engrailed, invected, embattled, wavy, nebuly, indented, dancetté or raguly—forms which will be found explained under separate articles.

**PARTNERSHIP**, in the law of England, is the union of two or more individuals acting under a contract, whereby they mutually contribute their property or labour for the purpose of making profits jointly. When a partnership is confined to a particular transaction or speculation, it is usually called a joint-adventure, and the parties are joint-adventurers. The usual criterion by which a partnership is ascertained to exist, as distinguished from other arrangements, is that there is a community of profit; it is not essential that both should suffer losses equally or proportionably, for one partner may stipulate that he shall not be liable to loss. This stipulation is binding between the partners, but of course is insufficient to prevent the partners from being all liable to third parties. So one partner may contribute all the capital or all the labour. A dormant partner is one whose name does not generally appear to the world as a partner, but who nevertheless is to all intents and purposes a partner, with equal rights and liabilities to the rest. In order to constitute that kind of community of profit which is the chief ingredient in a partnership, it is necessary that the partner share in the profits as a partner; for in many cases, clerks, servants, or agents receive a commission or remuneration proportioned to profits, and yet are not partners, for this is merely one mode of ascertaining the salary which they are to receive. In all such cases, therefore, the distinction as to whether there is a partnership or not turns on the consideration whether the alleged partner receives a share of the profits, as such, or merely receives a salary proportioned to profits, without having a specific interest in the firm. The contract of partnership may be entered into either by word of mouth or in writing. If no specified term be agreed upon, it is a partnership at will, and may be dissolved by either of the parties at pleasure. Sometimes, also, the Court of Chancery will interfere to dissolve the partnership before the

time appointed; but this only happens when some unforeseen and urgent reason exists, as that one of the partners has become a lunatic, or has proved grossly dishonest, or the object of the partnership cannot be carried out. Mere differences of opinion on minor matters are no ground for seeking a dissolution. The partners may make any kind of arrangement between themselves that they think proper; but if these are unusual and special stipulations, there is no certainty of securing the same being adhered to, without a formal deed or indenture of partnership being executed. Thus, it is common to stipulate as to the capital each is to contribute, and as to the proportion of profits he is to receive, as to what is to be done in case of the death of a partner, &c. Unless a stipulation is made to the contrary, the rule is, that the death of one of the partners dissolves the partnership. So does his bankruptcy. It is also a rule that no new partner can be introduced without the consent of the rest. There is also a peculiarity in the law of England as to the form of remedy—the rule being, that partners cannot sue each other in a court of law in respect of partnership transactions, but the only remedy is by a bill in Chancery. As against third parties, whatever may be the secret arrangements between themselves, the rule is, that any partner can bind the firm in all matters which are within the scope of the partnership, each being by the nature of the contract made the agent of all the rest for business purposes. Thus, any one may accept a bill in the name of the firm, provided such be one of the modes of doing business. It is, however, to be borne in mind, that the firm is only bound by one of the partners in those matters which are strictly within the proper business of the firm, which is an important qualification of the general power. Within the above limits, each partner can bind the rest of his copartners, however imprudent or foolish may be his act, for it is one of the implied conditions, that all have full confidence in each other. It follows from this principle, that the firm is liable for the dealings of each partner on its behalf within the scope of the partnership, that each is liable to the full extent for all the debts of the firm; in short, each is liable to his last shilling for the solvency of the firm. Hence, it is often of importance for a partner, on leaving the firm, to know how to terminate this liability. The rule is, that as regards all strangers, a notice in the *Gazette* is good notice; but as between the firm and those who have had dealings with it, the *Gazette* notice is of no use, unless it can be proved that the party had actual notice given to him—and hence a circular notice sent to customers announcing the fact of retirement, is the only course effectual.

The practice of individuals entering into large associations, now called joint-stock companies, which were originally only extended partnerships, has led to a separate code as to these being framed for the United Kingdom. See JOINT-STOCK COMPANIES. The practice of limiting the liability of partners or shareholders in joint-stock companies had of late years led to the belief, that a similar restriction might well be extended to ordinary partnerships, and accordingly a bill was introduced into parliament in 1864 to enable this to be done. By that bill—which, however, did not extend to Scotland—any person may place a specific sum of money in a firm, and become a partner, with liability limited to such sum. Such limited partner, however, is to refrain from all participation in the conduct of the business, otherwise he will become a general partner. Nor is his name to appear in the title of the firm. But for his own security and satisfaction, he is entitled to examine the books, so as to ascertain

the profits. In this kind of partnership, certain particulars are to be registered with the registrar of joint-stock companies, such as the name and place of business of each partner, describing whether he be a general or limited partner, the nature of the business, and the place of carrying it on, the name of the firm, the amount lent by each limited partner, and the time at which it is to be repaid. This kind of partnership may be renewed from time to time on fresh registration. Any clerk or servant may be allowed to share profits without incurring the liability of partner. The register-books of this class of partnerships are to be open to the registrar. These partnerships may sue in the name of the firm. This step may be considered at present in the light of an experiment, but it is expected to take firm root in modern business, as it enables capitalists and traders to unite on a more rational basis, and combine their several interests and capacities much more effectually than could be done heretofore.

In Scotland, the law of partnership, though in its essential features the same with the law of England, differs in one or two particulars. The partnership is treated as a distinct person in law, the partners being only its sureties or cautioners; and the consequence of this is, that in actions by or against the firm, the individual partners need not be named, though in practice one or two of them generally are named. Each partner may also sue the firm as if it were a distinct person; and the firm may be made bankrupt without any of the partners being sequestrated. See Paterson's *Comp. of E. & S. Law*, p. 214.

PARTRIDGE (*Perdix*), a genus of gallinaceous birds, of the family *Tetraonidae*, having a short, strong bill, naked at the base; the upper mandible convex, bent down at the tip; the wings and tail short, the tarsi as well as the toes naked, the tarsi not spurred.—The COMMON P., or GRAY P. (*P. cinerea*), is the most plentiful of all game-birds in Britain, and becomes increasingly plentiful as cultivation is extended, whilst the range of the moorfowl is restricted. It is not found in the Outer Hebrides. On the continent of Europe, it is abundant in almost all districts suitable to its habits, from Scandinavia to the Mediterranean, and is found also in the north of Africa, and in some parts of the west of Asia. It varies considerably in size; those found in rich lowlands being generally the largest, and about 12½ inches in entire length; whilst those which inhabit poorer and more upland districts are rather smaller. The female is rather smaller than the male. The upper parts of both are ash-gray, finely varied with brown and black; the male has a deep chestnut crescent-shaped spot on the breast, which is almost or altogether wanting in the female. The male has also the throat and sides of the face bright rust-colour, of which there is less in the female. A variety called the Mountain P. has the plumage brown. The P. is seldom found far from cultivated land. It feeds on grain and other seeds, insects and their larvæ and pupæ, and the pupæ of ants are very generally the food sought at first for the young. It pairs early in spring, at which time fierce conflicts take place among the males. The nest is usually on the ground, among brushwood and long grass, or in fields of clover or corn, and generally contains from twelve to twenty eggs. The young run as soon as they are hatched. Both parents shew a very strong attachment to their young, and great courage in repelling assailants; they have also recourse, like many other birds, to stratagem, to draw off the most powerful and dangerous enemies, such as dogs, in another direction, fluttering close before them as if broken-winged, whilst the brood escape. Until the end of autumn, the parent birds and their brood

keep together in a *covey*: late in the season, several coveys often unite into a *prick*, when it becomes much more difficult for the sportsman to approach them. The flight of the P. is strong and rapid for a short distance, but it does not seem to be capable of a long-sustained flight. The eggs of partridges are often hatched, and the young birds reared, by the domestic hen, the chief requisite being a plentiful supply of ants when the birds are very young. Partridges thus reared become very tame, but they seldom breed in the aviary.—The RED-LEGGED P. (*P. rufus*, or *Caccabis rufus*, the genus or sub-genus *Caccabis* being distinguished by a rudimentary blunt spur on the tarsi) is a native of the south of Europe and of the Channel Islands, and is now also plentiful in some parts of England, particularly Norfolk and Suffolk, into which it has been introduced. It is rather larger than the Common P., stronger on the wing, and less easily approached by the sportsman, whilst it is also less esteemed for the table. The upper parts are of a reddish-ash colour; the throat and cheeks white, bounded by a collar of black, which expands in black spots on the breast; and the sides exhibit bars of black. The plumage is smooth.—Two other species, nearly allied to this, are found in some of the southern parts of Europe. India has a number of species. The habits of all the species much resemble those of the Common Partridge.—The name P. is sometimes extended so as to include the species of *Ortyx* (see VIRGINIAN QUAIL), and in South America is sometimes given to the Tinamous.

PARTRIDGE BERRY. See GAULTHERIA.

PARTRIDGE PIGEON (*Geophaps*), an Australian genus of *Columbidae*, approaching more than most of the pigeons, in character and habits, to the true gallinaceous birds, and particularly to partridges. Their plumage is beautiful, and generally with a bronze tinge and lustre on the wings, which causes them to be sometimes called Bronze-wings. There are several species. They live mostly on the ground, and rise with a whirring noise, like the pheasant, when disturbed. They are highly esteemed for the table.—*Geotrygon montana*, a species of another genus of *Columbidae*, bears the name of PARTRIDGE DOVE in the West Indies. It also seeks its food chiefly on the ground, although it affects well-wooded districts.

PARTRIDGES, in Artillery, were very large bombards formerly in use at sieges and in defensive works. They are mentioned in Froissart.

PARTRIDGE-WOOD, a very pretty hard-wood from the West Indies and Brazil; it is usually of a reddish colour, in various shade from light to dark, the shades being mingled in thin streaks; but in some choice sorts they are curled upon one another so as to resemble the feathers of the partridge, whence its name. One variety occurs in which the colours are remarkably bright, and it is consequently called Pheasant-wood. In Brazil, this beautiful wood is so plentiful that it is employed in ship-building, and it is said to be used in our navy-yards under the name of Cabbage-wood, but this is doubtful; many woods are known as partridge, and several as cabbage wood. Among the Brazilians, it is called 'Angelim,' and they describe four sorts—*Angelim de pedra* (the Stone Angelim), *A. vermelho* (Red Angelim), *A. amargoso* (Bitter Angelim), and *A. varzea* (Cultivated Angelim). Its chief use in this country is for cabinet-work, Tunbridge-ware, parasol-sticks, fans, and other small matters for which its beauty recommends it. It is said to be yielded by the leguminous tree (*Andira inermis*), which is found not only in the Brazil, but in other parts of South America and the West Indies.

PARTS OF SPEECH are the several kinds or classes into which the words of a language are divided. There is nothing in the outward form of words that would enable us to divide them into classes. The distinction lies in the offices that the several words perform in a Sentence (q. v.). All words performing the same office in sentences belong to the same class. The essential parts of speech are the Noun, Adjective, Pronoun, Verb, Adverb, Preposition, Conjunction (see these several heads). The Articles (q. v.) are not distinct parts of speech, being essentially pronouns; and Interjections (q. v.) hardly belong to articulate speech. To name the class or part of speech to which each word of a sentence belongs, is called to *parse* it.

PARTURITION. See MIDWIFERY.

PARTY, in Heraldry. See PARTITION LINES.

PARTY-WALL is the wall dividing two houses or tenements, and which is, in a certain sense, one and indivisible, though the property of two or more parties. The question as to who is the owner of any particular part of the party-wall, is solved by ascertaining who is the owner of the soil on which it is built. In the absence of evidence to the contrary, it is presumed that half of the soil belongs to the owner on one side, and the other half to the owner of the other side; and unless the wall has stood twenty years and upwards, each owner can do what he likes with his own half, and can pare it away if he likes. But in general, mutual interest prevents each party from resorting to his strict legal rights. A practice exists for one who builds a house adjoining the wall of a neighbour, to pay for half the expense. In Scotland, a party building close to the wall of another's house, can compel the owner of the first house to give him half of the wall or gable, on paying half the expense; while in England there is no such compulsion. In Scotland, where the practice exists of building houses in flats lying each upon the other, the law is not clearly settled, and requires to be cleared up as to what is the nature of the property or interest which each proprietor of a flat has in that part of the gable bounding his own flat. The better opinion is, that each is the entire owner of his half of the gable, the others having merely cross servitudes; and hence it follows, that if the flats on both sides of a gable belong to one owner, he can make a communication through the gable, provided he do not injure the chimney-flues of the lower flats, or the stability of the structure.

PÂRVATI (from the Sanscrit *parvata*, mountain, literally, mountain-born) is one of the names by which Durgâ, the consort of S'iva, is usually called, she being the daughter of the mountain Himalaya.

PARVISE, a porch or open space in front of the door of a church.

PASCAGOULA, a river, and bay at its mouth, in Mississippi, U. S. The river, formed by the junction of the Leaf, the Chiokahay, with numerous branches, drains the south-eastern portion of the state, and flows into Mississippi Sound through two mouths which form the bay. It is navigable 100 miles through a sandy region of pine-forests, supplying turpentine. The villages on the bay are summer resorts from Mobile and New Orleans; and on the shores at night are heard sounds like the Æolian harp, supposed to be caused by some kind of shell-fish.

PASCAL, BLAISE, one of the most distinguished philosophers and scholars of the 17th c., was born at Clermont, in Auvergne, France, June 19, 1623. His father, Etienne Pascal, was president of the Cour des Aides at Clermont. His mother, Antoinette



Bezou, died while he was little beyond infancy. He had two sisters—the elder, Gilberte, Madame Perier, afterwards his biographer; the younger, Jacqueline, who became a nun of Port Royal, under the celebrated Mère Angelique, sister of Antoine Arnauld. From childhood, Blaise gave evidence of extraordinary abilities; and when he reached his eighth year, his father resigned his office at Clermont, and came to Paris, in order personally to direct the boy's education. For the purpose of concentrating all the boy's efforts upon languages, his father kept out of his reach all books treating the subject of mathematics, for which he had early evinced a decided taste; and it is recorded that by his own unaided speculations, drawing the diagrams with charcoal upon the floor, he made some progress in geometry. One account represents him as having thus mastered the first thirty-two propositions of the first book of Euclid's *Elements*—a statement which carries its own refutation with it. Thenceforward, he was permitted freely to follow the bent of his genius. In his sixteenth year, he produced a treatise on Conic Sections, which extorted the almost incredulous admiration of Descartes. In his nineteenth year, he invented a calculating-machine; and turning his attention to the novel questions as to the nature of fluids, which Torricelli's theories had raised, he produced two essays, which, although not published till after his death, have established his reputation as an experimental physicist. His father having accepted an office at Rouen, P. was there brought much into intercourse with a distinguished preacher, Abbé Guillebert, a member of the Jansenists, but a man of great eloquence, a great master of ascetic theology, from whom and from other members of the same rigid sect, as well as from the writings of Arnauld, St Cyran, and Nicole, P.'s mind received a deeply religious turn; and his health having suffered much from excessive study, he gave himself up in great measure to retirement and theological reading, and to the practice of asceticism. The death of his father, and his sister Jacqueline's withdrawal to Port Royal, confirmed these habits; and it is to this period that we owe his magnificent though unfinished *Pensées*, which have extorted the admiration even of his unbelieving, and therefore unsympathising critics. Having fully identified himself with the Jansenist party, he was induced (1655) to take up his residence at Port Royal, although not as a member of the body, where he resided till his death, entirely given up to prayer and practices of mortification, among which practices may be mentioned that of wearing an iron girdle, studded with sharp points, which he forced into his flesh whenever he felt himself assailed by sinful thoughts. In the controversy to which the condemnation of Arnauld by the Sorbonne (1655) gave rise, P. took a lively interest; and it was to this controversy that he contributed the memorable *Lettres Provinciales*, published under the pseudonym of Louis de Montalt. These famous Letters (eighteen in number, not reckoning the nineteenth, which is a fragment, and the twentieth, which is by Lemaistre), are written, as if to a provincial friend, on the absorbing controversial topic of the day. The first three are devoted to the vindication of Arnauld, and the demonstration of the identity of his doctrine with that of St Augustine. But it was to the later letters that the collection owed both its contemporary popularity and its abiding fame. In these P. addresses himself to the casuistry and to the directorial system of Arnauld's great antagonists, the Jesuits; and in a strain of humorous irony which has seldom been surpassed, he holds up to ridicule their imputed laxity of principle on the obligation of restitution, on simony, on probable opinions, on

directing the intention, on equivocation and mental reservation, &c. In all this, he professes to produce the authorities of their own authors. Of the extraordinary ability displayed in these celebrated Letters, no question can be entertained; but the Jesuits and their friends loudly complain of their unfairness, and represent them as in great part the work of a special pleader. The quotations, with the exception of those from Escobar, were confessedly supplied by P.'s friends. It is complained that many of the authors cited are not Jesuits at all; that many of the opinions ridiculed and reprobated as opinions of the Jesuit order, had been in reality formally repudiated and condemned in the Society; that many of the extracts are garbled and distorted; that it treats as though they had been designed for the pulpit and as manuals for teaching, works which in reality were but meant as private directions of the judgment of the confessor; and that, in almost all cases, statements, facts, and circumstances are withheld, which would modify, if not entirely remove, their objectionable tendency. See JESUITS. To all which the enemies of the Jesuits reply by arguments intended thoroughly to vindicate Pascal. P. himself entertained no compunctious feeling for the production of these Letters, but even at the approach of death declared his full satisfaction with the work, such as it was. His later years were made very wretched by continued, or at least frequently recurring hypochondria, under the influence of which he suffered from very painful fantasies, which he was unable to control. His strength was completely worn out by these and other infirmities, and, prematurely old, he died at the early age of thirty-nine in Paris, in the year 1662. His *Pensées sur la Religion, et sur quelques autres Sujets*, being unfinished, were published with suppressions and modifications in 1669; but their full value was only learned from the complete edition which was published at the instance of M. Cousin (2 vols., 8vo, Paris, 1844). Of all his works, the *Lettres Provinciales* have been the most frequently reprinted. They were translated into Latin in the lifetime of P. by Nicole, under the pseudonym of a German professor, 'Wilhelm Wendroc;' and an edition in four languages appeared at Cologne, in 1684.

PA'SCO, or CERRO DE PASCO, an important mining city in Peru, in the department of Junin, stands at an elevation of upwards of 13,000 feet above sea-level, 80 miles north-east of Lima in a direct line, but upwards of 130 miles by the winding mountain road. It consists of a collection of huts spread over an area that has been hollowed out and perforated in all directions by mines. The number of the inhabitants varies according to the state of the mines; being sometimes considerably more than 12,000, and often much less. The Cerro, or 'mountain knot,' of Pasco rises in Sacahuana, 16,000 feet above the level of the sea. Coal is found in the vicinity.

PAS-DE-CALAIS (Fr. for Strait of Dover), a department in the north of France, bounded on the N. by the department of Nord and the Strait of Dover, and on the W. by the Strait of Dover and the English Channel. Area, 1,631,590 acres, of which 883,300 acres are cultivated, and 236,707 in meadows. Pop. (1862) 724,338. The surface is level, with the exception of a ridge of hills running from the south-east to the north-west, ending in Gris-nez Cape (q. v.), and forming the water-shed between the North Sea and the English Channel. The rivers, which are of no considerable length, are the Scarpe and Lys in the basin of the North Sea, and the Authie and Canche belonging to the basin

of the English Channel. The rivers are navigable within the department, and are connected by canals. The coast-line is 80 miles in length, and the shores are in certain parts low and sandy; while for several miles on either side of Gris-nez, cliffs similar to those of Dover front the sea. The climate is mild, but exceedingly inconstant. The soil is very fertile—all the usual cereal and leguminous crops are produced in abundance—and the country is very productive both as regards agriculture and manufactures. Fishing is actively carried on, on the coast, particularly in the neighbourhood of Boulogne. Coal of an indifferent quality is raised, the excellent quarries of the department are worked, and considerable quantities of turf are cut. The industrial establishments are numerous and important, as iron-foundries, glass-works, potteries, tanneries, and numerous bleach-works, and mills and factories of various kinds. Boulogne and Calais are the principal harbours. There are six *arrondissements*—Arras, Béthune, St Omer, St Pol, Boulogne, and Montreuil. The capital is Arras.

**PASENG.** See GOAT.

**PA'SEWALK**, a town of Prussia, in the government of Stettin, 25 miles west-north-west of the city of that name, on the Uker. It contains two churches, two hospitals, and several woollen-cloth and leather factories; and carries on an active general trade. Pop., exclusive of military, 6380.

**PASHA'**, or **PACHA**, a title used in the Ottoman empire, and applied to governors of provinces, or military and naval commanders of high rank. The name is said to be derived from two Persian words—*pa*, foot or support, and *shah*, ruler—and signifies 'the support of the ruler.' The title was limited in the early period of the Ottoman empire to the princes of the blood, but was subsequently extended to the grand-vizier, the members of the *divan*, the *seraskier*, *capitan-pasha*, the *begler-begs*, and other civil and military authorities. The distinctive badge of a pasha is a horse's tail, waving from the end of a staff, crowned with a gilt ball; in war, this badge is always carried before him when he goes abroad, and is at other times planted in front of his tent. The three grades of pashas are distinguished by the number of the horse-tails on their standards; those of the highest rank are pashas of three tails, and include, in general, the highest functionaries, civil and military. All pashas of this class have the title of vizier; and the grand-vizier is, *par excellence*, a pasha of three tails. The pashas of two tails are the governors of provinces, who generally are called by the simple title 'pasha.' The lowest rank of pasha is the pasha of one tail; the *sanjaks*, or lowest class of provincial governors, are of this rank. The pasha of a province has authority over the military force, the revenue, and the administration of justice. His authority was formerly absolute, but recently a check was imposed on him by the appointment of local councils. The pasha is in his own person the military leader and administrator of justice for the province under his charge, and holds office during the pleasure of the sultan—a most precarious tenure, as the sultan can at any moment, in the exercise of his despotic power, exile, imprison, or put him to death; and this has frequently been done in cases where the pasha's power has excited the apprehension, or his wealth the avarice of his royal master.

**PASKEVITCH**, **IVAN FEODOROVITCH**, Count of Erivan, Prince of Warsaw, and a Russian field-marshal, was born at Poltava, May 19, 1782. He was descended from a Polish family, and was at first a page to the Czar Paul, but entered the army,

and served in the campaign in 1805, which was ended by the defeat of Austerlitz; and then against the Turks. He took a prominent part in the campaign of 1812, and several times defeated the French under Eugène, Ney, and St Cyr; he was also present at Leipzig and the conflicts under the walls of Paris. In 1825, he was appointed commander-in-chief against the Persians, whom he completely defeated, conquering Persian Armenia, taking Erivan, and ending the war by the peace of Turkmanshai (q. v.), a peace exceedingly favourable to Russia. In recompense for these services, he was created Count of Erivan, and received a grant of 1,000,000 rubles (£158,600). In 1828 and 1829, he made two campaigns against the Turks in Asia, signalised by the taking of Kars, Erzerum, and other important provinces, and terminated by the treaty of Adrianople in 1829. In 1831, P., now a field-marshal, was appointed viceroy of Poland, put an end to the revolt within three months after his appointment, and reconstructed the administration on the basis of a complete incorporation with Russia. Such was the vigour and severity of his rule, that the eventful year 1848 passed over without any attempt at revolution. When Russian intervention in Hungary had been resolved upon, P., though now 67 years of age, marched into that country at the head of 200,000 men, and, after a junction with the Austrians, defeated the Hungarians in several battles, and by mere force of numbers crushed out the last spark of insurrection. The 50th anniversary of his military service was celebrated at Warsaw, in 1850, with the utmost rejoicings, and on this occasion the sovereigns of Austria and Prussia conferred on him the rank of field-marshal in their respective armies. In 1854, he unwillingly took the command of the Russian army on the Danube; but fortune, which had hitherto invariably smiled upon him, deserted him at Silistria; and after undergoing a succession of sanguinary repulses, and being himself grievously wounded, he withdrew his army, and resigning the command, retired to Warsaw, where he fell into a state of profound melancholy, and died January 29, 1856.

**PA'SPALUM**, a genus of grasses, with spikes either solitary or variously grouped, one-flowered spikelets, and awnless pales. The species are numerous, natives of warm climates.—*P. scrobiculatum* is cultivated as a cereal in India, where it is called Koda. See MILLET. It will grow in very barren soils, and delights in a dry loose soil. *P. exile* is cultivated in like manner in the west of Africa, where it is called Fundi (q. v.) or Fundungi.—Other species are valuable as fodder-grasses. *P. purpureum* is a very important fodder-grass in the coast districts of Peru, during the dry months of February and March. *P. stoloniferum*, also a Peruvian species, has been introduced into France; but is apt to be injured by frosts, and seldom ripens its seeds in the neighbourhood of Paris.

**PASQUE FLOWER** (*Pulsatilla*), a genus of plants of the natural order *Ranunculaceæ*, by many botanists still included in *Anemone*, the chief distinguishing characteristic being the long feathery awns of the fruit. The species are perennial, silky, herbaceous plants, with doubly pinnatifid or doubly trifid leaves, and a simple one-flowered scape. They are narcotic, acrid, and poisonous. The Common *P.* (*Pulsatilla vulgaris* or *Anemone pulsatilla*) is a native of many parts of Europe, and of chalky pastures in several parts of England. It has widely bell-shaped bluish-purple flowers. Another species, *P.* or *A. pratensis*, a native of the continent of Europe, not of Britain, has smaller and more perfectly

ball-shaped blackish-purple flowers.—These plants emit, when bruised, a pungent smell; and contain, as their principal constituent, a peculiar pungent essential oil, which, in combination with *Anemonic Acid*, forms an acrid and very inflammable substance called *Anemonine*, or *Pulsatilla Camphor*, and



Pasque Flower (*Anemone pulsatilla*).

is sometimes used in medicine. *Pulsatilla* is a favourite medicine of the homœopathists. *Easter Eggs* are coloured purple in some places by the petals of the pasque flower.—More acrid than any of the species just named is *Pulsatilla patens*, which occasionally even blisters the skin.

PASQUINADE, an anonymous or pseudonymous publication of small size, sometimes printed, sometimes only posted up or circulated in manuscript, and having for its object the defamation of a character, or at least the turning of a person to ridicule. The name is derived from *Pasquino*, a tailor remarkable for his wit and sarcastic humour, who lived in Rome towards the close of the 15th c., and attracted many to his shop by his sharp and lively sayings. Some time after his death, a mutilated fragment of an ancient statue, considered to represent Menelaus supporting the dead body of Patroclus, was dug up opposite his shop, and placed at the end of the Braschi Palace, near the Piazza Navoni. It was named after the defunct tailor, and thus the practice originated of affixing to it placards containing satires and jests relative to the affairs of the day—the pope and the cardinals being favourite victims of the invisible satirists. It was, and still continues to be, the only outlet which the Roman has for his opinions and feelings. One or two may be quoted as specimens of the mordant style of the Pasquin statue. 'Great sums,' said the satirist one day, in an epigram addressed to Pope Paul III., 'were formerly given to poets for singing; how much will you give me, O Paul, to be silent?'—On the marriage of a young Roman called Cesare to a girl called Roma, the statue gave the following advice: 'Cave, Caesar, ne tua Roma republica fiat.' Next day the rival statue of Marforio, in the Capitol, replied: 'Cæsar imperat;' to which Pasquin with exquisite malice retorted: 'Ergo coronabitur.'

PA'SSAGE, WEST, a seaport town upon the western shore of the estuary of the river Lee, in the

county of Cork, Ireland, which has risen into importance chiefly as a watering-place, and as the shipping-port and marine suburb of the city of Cork, from which it is distant, by the Cork and Passage Railway, about 6 miles. As the river above P. is not navigable for ships above 400 or 500 tons burden, ships of higher tonnage discharge their cargoes at Passage. It is also a ship-building station. Pop. in 1861, 2287; of whom 1879 were Catholics; 375, Protestants of the Established Church, and the rest of other religious denominations.—There is another small town of the same name, EAST PASSAGE, near the mouth of the Suir, in the county of Waterford, Ireland.

PASSAGLIA, CARLO, a Roman Catholic theologian of great eminence, who has obtained much notoriety in connection with the recent movement for the unity of Italy, is a native of the duchy of Lucca, where he was born May 2, 1812. His origin is very humble, and he entered extremely young as a scholar of the Jesuit Society, of which he was enrolled a member in the year 1827. Having obtained much distinction in the schools of the order, and having, as is usual with its members, taught for some time in the lower schools, he completed his theological studies in the Roman College, and was appointed Professor of Canon Law, and eventually of Dogmatical Theology. His reputation for learning stood in the very first rank of Roman Catholic theology, and his lectures were exceedingly admired for their eloquence and erudition, but were considered in some respects too diffuse for the class of pupils who frequented his school. During the temporary withdrawal of the Jesuits from Rome in 1848—1851, P. with some of his brethren came to England, where he taught theology to the young brethren of his order, and on the re-establishment of the Jesuits in the Roman College, he resumed possession of his chair. During the discussions which preceded the definition of the doctrine of the Immaculate Conception of the blessed Virgin Mary (q. v.), P. prepared an elaborate treatise as well on the doctrine as on the history of that question, which was published at the cost of the Roman government. Soon afterwards, however, the dissatisfaction which was felt at the unsuitable character and method of his lectures, led to some remonstrance on the part of the authorities of the order, and ultimately to his resignation of the professorship of theology. Still, however, he continued a member of the Society; and the pope, who felt a warm friendship for him, established in the Roman university a special chair of Philosophy for him, of which he took possession, but which he did not long retain. In the end of 1858, or early in 1859, he left the Society of the Jesuits, and soon afterwards he began to take an active part in the discussions as to the temporal power of the pope; and with a view to an accommodation of the difficulties in which it was involved, he undertook a voluntary mission to Turin, which, however, led to no results. Having fallen under suspicion in Rome, and his house having been invaded by a domiciliary visit of the police, he withdrew from Rome, and settled at Turin, where he established a journal, entitled *Il Mediatore*, which in 1864 was still in course of publication. He was elected a member of the Turin parliament, in which career, however, his success hitherto has fallen far short of his reputation.

P.'s principal works are the treatise on the Immaculate Conception already referred to (4 vols. 4to); a treatise (Latin) on the Primacy of St Peter (8vo, 1850); a scholastic treatise entitled *Commentarius Theologicus de Partitione Divinae Voluntatis* (8vo, Rome, 1851); an apology for the cause of Italian unity, entitled *Pro Causa Italica; ad*

## PASSAIC—PASSENGER PIGEON.

*Episcopos Catholicos* (Florence, 1861), in which he recommends the church to make peace with the nation; several essays on various subjects, and quite recently a Reply to Renan's *Vie de Jesus* (Italian).

**PASSAIC**, a river of New Jersey, U. S., rises in Morris County, and after a circuitous south-easterly course of 90 miles, empties into Newark Bay. It is navigable for sloops for a short distance; and its falls of 72 feet at Patterson furnish water-power to numerous factories, and are an attraction to tourists.

**PASSAMAQUODDY BAY** opens out of the Bay of Fundy, between Maine and New Brunswick, North America. It is 12 miles long by 6 wide, and shut in by a cluster of islands so as to form an excellent harbour. It receives the St Croix, Didgequaah, and other rivers, and forms the harbour of the flourishing town of Eastport. The bay abounds in fish, and has tides of 25 feet.

**PA'SSANT**, a heraldic term used to express the attitude of an animal in a walking position, with



his head straight before him (fig. 1); fig. 2 represents the attitude, *Passant gardant*; fig. 3, *Passant regardant*.

**PASSA'ROWITZ**, a well-built town of European Turkey, in the province of Servia, 5 miles south of the Danube, and 15 miles east of Semendria. Its streets are wide and unpaved, its houses detached, and surrounded with palisades. Pop. 5000. The town is chiefly noteworthy for the treaty which was signed here by Prince Eugene and the grand vizier, July 21, 1718. By this treaty, which put an end to the war undertaken by the Turks against Venice in 1714 for the conquest of the Morea, a truce of 25 years was established, and the Banat of Temesvar, the western portion of Walachia and Servia, the town and territory of Belgrade, and a part of Bosnia, were secured to the House of Austria.

**PA'SSAU**, a picturesque, fortified, frontier town of Bavaria, at the confluence of the Inn and the Ilz with the Danube, 90 miles east-north-east of Munich. It consists of P. Proper (triangular in shape, and occupying an eminence on the tongue of land between the right bank of the Danube and the left bank of the Inn), and the suburbs, Innstadt, on the right bank of the Inn; Anger and Fort Oberhaus, between the Danube and the Ilz; and Ilzstadt, on the left bank of the Ilz. At the point of junction, the Inn is both wider and has had a longer course than the Danube, the former being 834 feet; while the latter is only 696 feet wide. A wooden bridge over the Inn, resting on eight piers of granite, connects Innstadt with P., and the Danube is crossed by a fine bridge resting on seven piers, also of granite. Fort Oberhaus, on the left bank of the Danube, stands on steep, wooded cliffs, at an elevation of upwards of 400 feet, and commands the passage both of the Inn and Danube, besides which the town is further defended by the castle of Niederhaus, and by ten detached forts. The appearance of P., situated at the confluence of two great rivers, and rising like an amphitheatre on the most beautiful spot of the Danube, is strikingly effective and picturesque. Among the chief buildings are the cathedral, the bishop's palace, the

post-office, where the treaty of P. was signed in 1552; the Jesuits' College, a large building now used as a school; and the Church of St Michael's. In the Cathedral Square (Domplatz) is a bronze statue of King Maximilian Joseph, of recent erection. P. contains also numerous picture-galleries, collections of antiquities, and benevolent and charitable institutions. The women of P. are famous for their beauty. Pop. 11,960.

The natural advantages of this site, in a military point of view, were appreciated at an early period by the Romans, who erected a strong camp here, garrisoned it with Batavian troops, and from this circumstance named it *Batava Castra*. P. was long the see of a bishopric founded in the 7th c., but secularised in 1803. By the treaty of P.; signed here in 1552 by the emperor Charles V. on the one side, and the Protestant princes of Germany on the other, public recognition of the Lutheran faith among the institutions of the empire was granted. The cathedral of P. and great part of the town were consumed by fire in 1662.

**PASSECAILLE AND PASSEPIED**, two old French dances, the music of the former being in  $\frac{3}{4}$ , the latter in  $\frac{3}{8}$  time. Compositions under these names, suggestive of the dances in question, though not meant for dancing, occur among the 'Suites,' or collections of short pieces for the harpsichord or clavichord by Sebastian Bach and Handel.

**PA'SSENGER PIGEON** (*Ectopistes migratorius*), a species of pigeon, native of North America, and particularly interesting from the marvellous numbers of which its flocks are often composed. The genus to which it belongs has, like the turtle doves, a bill more slender than the ordinary pigeons, notched, and with a tumid fleshy covering above at the base; the head is small in proportion to the body, the legs are short and strong, the feet naked, the tail either rounded or wedge-shaped, the wings long and pointed. The P. P., generally known in North America as the Wild Pigeon, has a long wedge-shaped tail; the whole length being from 15 to 17 inches, of which the tail occupies nearly



Passenger Pigeon (*Ectopistes migratorius*).

one half. It is a beautiful bird, of very graceful form and finely-coloured plumage. The plumage of the female is duller than that of the male.—The P. P. is found in almost all parts of North America, from the Gulf of Mexico to the Arctic regions. It

is not, properly speaking, a bird of passage; its migrations being apparently altogether consequent on the failure of the supplies of food in one locality, and the necessity of seeking it in another, and not connected with the breeding season or the season of the year. Its power of flight is very great, and it is supposed to be able to sustain a long flight at the rate of sixty miles an hour. Passenger pigeons have been killed in the neighbourhood of New York, with their crops full of rice, which they must have collected in the fields of Carolina or Georgia not many hours before. It is not, therefore, very wonderful that wanderers of this species should occasionally appear in Britain and in other regions far from their native abode. The nest of the P. P. in the American forests generally consists of a few dry twigs placed in a fork of the branches of a tree, and containing two eggs, sometimes only one egg. They breed two or three times in a season. In the backwoods, vast numbers of pigeons building in one breeding-place, many nests, sometimes 100 or more, are often to be seen in one tree. These great breeding-places extend over a vast tract of forest, sometimes not less than forty miles in length; but in the more cultivated parts of the United States the P. P. builds singly and not in communities. The numbers of birds forming the communities of the western forests surpass calculation. Flocks of them are to be seen flying at a great height in dense columns, eight or ten miles long; and there is reason to suppose, from the rapidity of their flight, and the number of hours taken by a column in passing a particular spot, that in some of their great migrations the column, a mile broad, is more than 150 miles long. Their roosting-places, as well as their breeding-places, are of prodigious magnitude. The graphic descriptions of Wilson and Audubon are too long to be quoted; but there is perhaps nothing of the kind so wonderful in relation to any species of bird. The noise of wings and of cooing voices is as loud as thunder, and is heard at the distance of miles. It drowns the report of guns. The multitudes which settle on trees, break down great branches by their weight, so that it is dangerous to pass beneath. They crowd together, alighting one upon another, till they form solid masses like hogsheds, and great numbers are killed when the branches break. The inhabitants of the neighbouring country assemble, shoot them, knock them down with poles, stifle them by means of pots of burning sulphur, cut down trees in order to bring them in great numbers to the ground, eat them, salt them, and bring their hogs to fatten on them. Wolves, foxes, lynxes, cougars, bears, racoons, opossums, polecats, eagles, hawks, and vultures all congregate to share the spoil. The flesh of the P. P. is of a dark colour, but tolerably pleasant. That of young birds is much esteemed. The nestlings are in general extremely fat, and are sometimes melted down for the sake of their fat alone. The food of the P. P. consists chiefly of beech-mast and acorns, but it readily eats almost any kind of nut, berry, or seed.

**PASSENGERS BY LAND AND SEA.** The law affecting passengers by land, in a carriage or public conveyance, may be stated as follows: The owners of the railway or other carriage do not contract to carry the passenger with perfect safety; they do not warrant that he will not be injured; but they merely contract to carry him without any negligence on their part. Hence, in case of accident, though it is not strictly correct in point of law to assume that the accident arose from some negligence of the carrier, unless there is evidence to support it, this presumption is in point of fact always made,

and it lies on the carrier to shew that it was from no fault or negligence on his part that the accident happened. As questions of negligence must always be decided by a jury, and their prepossessions are against admitting the idea that accidents arise from any cause except negligence of the carrier—which is a wholesome doctrine—it seldom ever happens that a railway or public company attempt to dispute their responsibility on that ground. The rule is that a railway company is responsible for the negligence of any of their servants; and hence, in case of accidents, all passengers injured, and in case of death, the parent, husband, wife, or children of the deceased passenger, invariably make a claim of compensation, except when the accident was caused by the passenger's own personal negligence. For while a carrier is bound to use due care to carry the passenger with safety, it is equally true that the passenger is at the same time bound to take ordinary care of himself, and not act in a rash or foolish way, so as to lead to an accident. Before railways and canals were in use, it was sometimes doubted whether it was not the duty of carriers by coach to carry all persons who presented themselves and offered to pay their fare; but this notion is exploded, and even railway companies are not bound to carry everybody who comes, but merely to give reasonable accommodation to the ordinary number, otherwise their liability would be enormous on particular occasions where crowds assemble. Their interest is usually a sufficient inducement on such occasions to provide the accommodation required. A passenger has a right to carry along with him Luggage (q. v.).

In the case of passengers by sea, a peculiar code has been constructed, owing to the peculiarity of their situation. The fundamental rule of the common law is the same as on land carriage—that the carrier by sea does not engage to carry with absolute safety, but merely to omit nothing in his power, and to use due care. The legislature, however, has passed statutes to regulate the duties of carriers by sea, the latest being 18 and 19 Vict. c. 119. The act, however, only applies to voyages from the United Kingdom to places out of Europe, and not to the Mediterranean Sea. Payment of the passage money must be made before commencing the voyage, and the owners are not bound to forward steerage passengers by the very ship contracted for, if an equally eligible ship be offered, provided, however, that families are not to be separated. If the ship is disabled on the voyage, the owners are bound to repair the ship in six weeks, or send on the passengers. If the passengers exceed 300, a medical practitioner must be on board, and the provisions must be according to a certain scale of diet. The Emigration Commissioners require to inspect emigrant ships, and to give a certificate as to fitness. As to passenger steamers in this country, a certificate is required from the Board of Trade, specifying the voyage and number of passengers allowed to be carried.

#### PA'SSERINE BIRDS. See INSESSORES.

**PASSING-BELL,** a bell tolled during the death agony of a dying person, at the moment of the soul's 'passing' from earth to its eternal abode. Its use in Catholic countries is to invite the hearers to join in the prayers which are ordered 'for the dying in their hour of agony,' and which the priest with his attendants recite in the death chamber. See BELL.

**PASSING-NOTES,** in Music. In passing from one chord to another, an intervening note, not belonging to either chord, may be used to assist the progression. Such a note is called a passing-note or

note of transition, as the notes D and F in the upper part of the subjoined example :



**PASSION CROSS**, a cross of the form on which our Saviour suffered, with a long stem and a short traverse near the top. It is of occasional occurrence as a heraldic charge, though less frequent than many other varieties of cross. A passion cross, when elevated on three steps or degrees (which have been said by heralds to represent the virtues of Faith, Hope, and Charity), is called a Cross Calvary.

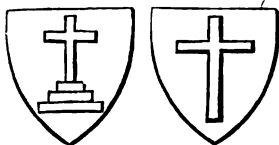

Passion Cross.

**PASSIONFLOWER** (*Passiflora*), a genus of plants almost exclusively natives of the warm parts of America, and belonging to the natural order *Passifloraceæ*; an order of exogenous plants, of which more than 200 species are known, mostly climbers, having tendrils which spring from the axils of the leaves, herbaceous or half shrubby, natives of tropical and subtropical countries, but rare in Asia and Africa. The leaves of the *Passifloraceæ* are alternate, simple, and variously lobed. The flowers are generally hermaphrodite, with a



Passionflower (*Passiflora carulea*).

coloured calyx, generally of five segments; the segments of the corolla equal in number to those of the calyx or absent, and several rows of filamentous processes springing from within the cup which is formed by the consolidated calyx and corolla; the stamens, generally five, and generally united by their filaments, inserted at the base of the tube of the calyx; the ovary free, generally elevated on a long stalk, one-celled; three thick styles with dilated stigmas; ovules numerous. The fruit is either fleshy or capsular. In the Passionflowers it is fleshy. This genus has received its name from fanciful persons among the first Spanish settlers in America, imagining that they saw in its flowers a representation of our Lord's passion; the filamentous processes being taken to represent the crown of

thorns, the nail-shaped styles the nails of the cross, and the five anthers the marks of the wounds. The species are mostly half shrubby evergreen climbers, of rapid growth; and most of them have lobed leaves, with from two to seven lobes. The flowers of many are large and beautiful, on which account they are often cultivated in hothouses. Some of the species are also cultivated in tropical countries for their fruit, particularly those of which the fruit is known by the name Granadilla (q. v.). The fruit of *P. edulis* is also somewhat acid and of a pleasant flavour, and ices flavoured with it are delicious. Its fruit is about two inches long, and an inch and a half in diameter, of a livid purple colour, with orange pulp.—The fruit of some species of *P.*, however, is not only uneatable, but fetid; and the roots, leaves, and flowers of some, as well as of other *Passifloraceæ*, have medicinal properties, narcotic, emmenagogue, anthelmintic, febrifugal, &c. *P. rubra* is called Dutchman's Laudanum in Jamaica, because a tincture of the flowers is used as a substitute for laudanum. The most hardy species of *P.* is the BLUE *P.* (*P. carulea*), which grows well enough in some parts of France, and even in the south of England. Where the climate is suitable, passion-flowers form an admirable covering for arbours and trellises.

**PASSIONISTS**, a religious congregation of priests of the Roman Catholic Church, the object of whose institute, indicated by their name, is to preach 'Jesus Christ and him crucified.' The founder, Paul Francis, surnamed Paul of the Cross, was born in 1694 at Ovada, in the diocese of Acqui in the kingdom of Sardinia. Having commenced his career as a hermit, he formed the design of enlisting others in the missionary life; and being ordained priest in 1737, he associated himself with ten others, and obtained for his plan the approbation of successive popes, together with the convent on the Celian Hill, at Rome, which still forms the mother-house of the congregation. The special object of the institute was to instil into men's minds by preaching, by example, and by devotional practices, a sense of the mercy and love of God as manifested in the passion of Christ. Hence the cross appears everywhere as their emblem, in their churches, in their halls, and in the courts and public places of their monasteries. A large crucifix, moreover, forms part of their very striking costume. They go barefooted, and practise many other personal austerities, rising at midnight to recite the canonical hours in the church; and their ministerial work consists chiefly in holding what are called 'missions,' wherever they are invited by the local clergy, in which sermons on the passion of Christ, on sin, and on repentance, together with the hearing of confessions, hold the principal places. Paul of the Cross died in 1775. For a time his congregation remained in obscurity; but it has risen into much notice within the last 30 years, new houses having been founded in England, Ireland, Belgium, America, and Australia.

**PASSION-WEEK**, the name commonly given in England to the week immediately preceding Easter, and otherwise called HOLY WEEK (q. v.). But by the proper rubrical usage, Passion-Week is that which precedes Holy Week, commencing on PASSION SUNDAY, the fifth Sunday of Lent. In the Roman calendar, the whole of the last fortnight of Lent is known by the name of Passion-tide, and all the services of that time differ in many respects from those, not alone of the year, but even of the rest of Lent. The verse *Gloria Patri* is discontinued both in the mass and in the Breviary, and all pictures,

crucifixes, statues, and other sacred representations are veiled during the whole of Passion-tide.

**PASSIVE TITLE**, in the Law of Scotland, is the liability of an heir, or one who represents and interferes with the estate of a deceased person, to pay all the debts of the deceased. It was considered that so great an opportunity of fraud in secreting the goods of a deceased person existed, that the heir was presumed to be liable for all the debts of the deceased, unless he took good care to give up an inventory, and so shew what property there was. The barbarous doctrine of holding an heir universally liable has latterly been much restricted; but the explanation is entirely technical.

**PASSOVER** (*Pesach, Pascha*), the first and greatest of the three annual feasts (*Regalim*) instituted by Moses, at which it was incumbent upon every male Israelite to make a pilgrimage to the house of the Lord. It was celebrated on the anniversary of the Exodus from Egypt—i. e., on the 14th day of Nisan, otherwise called Abib, the period of the first full moon in the spring—and lasted eight days. In commemoration of the incidents connected with the great event of the liberation of the people, it was ordained that unleavened bread only should be eaten during this festive period, whence it also bore the name *Chag hamazoth* (Feast of Unleavened Bread); and, further, that a lamb one year old, and free from all blemish, roasted whole, together with bitter herbs, should form the meal in every house on the eve of the feast. Prayers and thanksgivings, all with a reference to the redemption from bondage, accompanied the repast, at which the members of the family or families who had joined in the purchase of the lamb had to appear in travelling garb. At a later period, a certain number of cups of red wine were superadded to this meal, to which, as its special ceremonies and the order of its benedictions were fixed, the name *Seder* (arrangement) was given. The name P. was more strictly limited to the first day, in which the paschal lamb was entirely consumed, the reserving of any part of it to the next day being expressly forbidden (Ex. xii. 10); and the name Feast of Unleavened Bread belonged rather to the remaining days, on which other animal food was eaten; but the names were often used indiscriminately.

The P. is generally regarded by Christian theologians as at once a sacrifice and a sacrament, and in the former character as an eminent type of the sacrifice of Christ. The death of Christ at the very time of the P. is regarded as corroborative of this view, which is indeed plainly adopted in certain passages of the New Testament, as John xix. 36, and 1 Cor. v. 7, in which last place our Saviour is designated 'Christ our Passover.' The P. is regarded as typical of Christ, in its connection with the deliverance of Israel from the bondage of Egypt, held to typify our salvation from the bondage of sin; in its being a sacrifice, and that of a lamb without blemish—the perfection of the paschal lamb, as of the other sacrificial victims, being supposed to signify the perfection of the great sacrifice; and in many other minor particulars, of which one is that referred to in John xix. 36, that no bone of the paschal lamb was to be broken.

The Paschal meal, as at present celebrated among the Jews, has more the character of a hallowed family-feast, with reference, however, to the great national event. The greater part of those—it may be added here—who live out of the Holy Land celebrate it on the two first evenings, as, owing to the uncertainty prevalent at one time with respect to the fixing of the new moon by the Sanhedrim at

Jerusalem, it was ordained that the 'Exiles' should celebrate all their festivals—except the Day of Atonement—on two successive days, a law still in force among the orthodox. The regulations of the 'lamb for each house,' the travelling garb, &c., are abrogated, but many further symbolical tokens have been superadded; reminiscences, as it were, both of the liberation from Egypt, and the subsequent downfall of the sanctuary and empire. The order of prayers and songs to be recited on these evenings has also received many additions, and even medieval German songs have crept in, as supposed to contain a symbolical reference to the ultimate fate of Israel. See HAGGADA (*shel Pesach*), FESTIVALS, EASTER, LORD'S SUPPER.

**PASSPORT**, a warrant of protection and permission to travel, granted by the proper authority, to persons moving from place to place. Every independent state has the right to exclude whom it pleases from its territory, and may require that all strangers entering it be furnished with properly authenticated documents, shewing who they are, and for what purpose they are visiting the country. Passports are sometimes issued by the ministers and consuls of the country which the traveller intends to visit, which cannot, however, be done without the consent or connivance of the state of which the holder of the instrument is a subject; they properly proceed from the authorities of the state to which the traveller belongs, and ought to bear the *visa* or countersignature of the minister or consul of the country which he is about to visit. In many European states no one is allowed to go abroad without a passport from his government authorising him to leave the country—a provision used as a means of detaining persons charged with crime. In some states, passports are even required by the natives to enable them to go from place to place in their own country. The regulations of different states have varied much regarding the use of passports; and of late years the general tendency has been to relax the stringency of the regulations connected with them. Since the facilities of travelling have so greatly increased, it seems to have become the prevalent opinion that the passport system tends to obstruct the free intercourse that is desirable between citizens of different countries; while it is ineffectual to prevent the entrance of dangerous or suspicious characters, who can obtain passports on false pretences, or make their way in without them. Within the United Kingdom no passports are required; but for a British subject travelling in many parts of the continent, they are requisite. Till of late years, the greater part of British subjects travelling abroad used to be furnished with passports from the ministers or consuls of the countries which they purposed to visit; the lord provost of Edinburgh was also in the way of issuing passports to Scotchmen. Of late years the passport most used by British subjects is that of the British Secretary of State for Foreign Affairs, which is now granted to any British subject on application of a banking company in the United Kingdom, or on the recommendation of the chief magistrate of any corporate town in the United Kingdom, or of any magistrate or justice of the peace, physician, surgeon, solicitor, notary, or minister of religion, who shall certify that the applicant is the person that he professes to be. If the applicant be a naturalised British subject, he must be known to the Foreign Secretary, or recommended to him by some person known to him, and his certificate of naturalisation must be forwarded to the Foreign Office. A Foreign Office passport must, as a general rule, be countersigned by the minister or consul of each country which the

holder means to visit. The passport is good for life; the visas only for a year. Since January 1861, British subjects have been admitted from England into France, and allowed to travel in that country without passport, on merely declaring their nationality; but that exemption does not seem to apply when France is entered from another side than the Channel. In Belgium, Holland, Norway, Sweden, Italy, and, according to the most recent regulations, also in Prussia, passports are not asked for. In Austria, the passport has to be shewn and countersigned by the police authorities at the frontier; but except in the garrison towns of Venetia, it is hardly ever asked for in the interior. In many of the smaller German states, any person meaning to remain in a town above 24 hours must send his passport to the police-office, and obtain a permission to reside. Till lately, throughout the greater part of Europe, a traveller was liable to be called on to produce his passport, not only at every frontier town, but at every garrison town through which he passed, the ceremony of countersignature by the police being repeated each time. This was more especially the case in Italy, where the visas were attended with perpetual delays, annoyances, and demands on the traveller's purse. Foreign Office passports cannot be sent to British subjects residing abroad, who must apply for a passport to the nearest British mission or consulate.

In time of war, passports or safe-conducts are granted by the supreme authority on the spot—i. e., the officer in command—to insure safety to the holders when passing from spot to spot, or while occupied in the performance of some act specified in and permitted by the passport. Passports may be granted for goods as well as individuals; and, in time of war, the passport of a ship is the formal voucher of its neutral character. It purports to be a requisition on the part of the government of a state to allow the vessel to pass freely with her company, passengers, goods, and merchandise, without hinderance, seizure, or molestation, as being owned by citizens or subjects of such state.

**PASSY**, a town of France, in the department of Seine, a suburb of Paris, and included within the fortifications of that city. See **PARIS**.

**PASTA**, **GIUDITTA** (**JUDITH**), one of the most distinguished opera singers of modern times, was born near Milan in Italy in 1798, and received her musical education partly at Como, under the chapel-master of the cathedral there, and partly in the conservatoire at Milan. After 1811 she appeared at various theatres of the second rank in Northern Italy, and obtained a respectable success, but did not give any particular indication of possessing more than average ability. Her first great triumph was achieved at Verona in 1822. The year following she was engaged at the Paris Italian Opera, where her singing excited great admiration. From this moment she laboured incessantly to reach the ideal perfection she had set before her mind. From 1825 to 1830 was the period of her most splendid triumphs, which were won principally in London and Paris. Vienna, where she accepted an engagement in 1832, witnessed the last. Some time afterwards she withdrew from the stage, and purchased a villa on the banks of Lake Como, where, and at Milan, she has ever since resided. P. in her best days had a magnificent voice, which easily passed from clear shrill soprano notes to the gravest contralto tones. In addition she had a fine dramatic energy and stateliness of manner, that suited lofty and imposing characters. Her principal rôles were *Medea*, *Desdemona*, *Semiramide*, *La Sonnambula* (the opera of this name was written for her by Bellini), and *Giulia in Romeo e Giulia*.

**PASTE**, a term applied to various compositions in which there is just sufficient moisture to soften without liquefying the mass.

Common or adhesive paste is made by mixing wheaten flour with cold water in the proportion of about two pounds to a gallon. The water is added by degrees, and well stirred in, so as to prevent lumpiness. About an ounce of powdered alum is sometimes added to increase its adhesiveness, and for shoemakers and bookbinders about an ounce and a half of finely-powdered rosin is substituted for the alum, which thickens it much and renders it much more tenacious. When the ingredients are thoroughly mixed, they are boiled, great care being taken to stir them thoroughly whilst boiling to prevent burning. This paste is used for a great variety of purposes, more especially by paper-hangers, bill-stickers, bookbinders, paste-board makers, &c. An adhesive paste, called *Chinese Paste*, is made by reducing to perfect dryness bullock's blood. It is then powdered and mixed with one tenth of its weight of finely-powdered quicklime. When used, it is mixed with water sufficient to form a paste, which is a strong cement for pottery, wood, stone, &c.

*Fruit Paste* is made by taking the juice of any fruit and dissolving in it an ounce to a pint of gum-arabic, or gum-senegal, which many prefer; then evaporate by a gentle heat until the liquid is as thick as syrup, and add to every pound of it a pound of finely-powdered refined sugar; continue the heat, and stir it until the sugar and juice are thoroughly incorporated, after which it is poured out on a marble slab slightly oiled. When cooled, it may be formed into lozenges for use. An imitation of this is made very generally by mixing three parts of citric acid, twenty-four parts of gum, and forty-eight parts of refined sugar, and dissolving the whole in water, and gently heating it to insure complete solution and mixture. It is then variously coloured and flavoured with any of the fruit essences. This paste is often sold under the name of jujubes, which were formerly lozenges of fruit paste prepared from the juice of the jujube fruit, *Ziziphus jujuba*.

*Polishing Pastes* vary according to the materials upon which they are to be employed. For brass, the best kind is a mixture of two parts of soft soap with four parts of rotten-stone in very fine powder. Another sort is eight parts of fine rotten-stone powder, two parts of oxalic acid powdered, three parts olive oil, and enough of turpentine to make them into a paste. For iron, a mixture of emery powder and lard is used; and for pewter a mixture of finely-powdered bath-brick and soft soap. For wood, a paste called furniture paste is made by adding spirit of turpentine to beeswax sufficient to form it into a soft paste, which is rubbed on thinly with a brush and woollen rag, and afterwards polished with a dry woollen cloth and soft brush.

Shaving pastes are very numerous, but the base of all is soap. The best of all is the true Naples soap (see **SOAP**), but it is often mixed with other ingredients according to the fancy of the vendor. For other applications of the word *Paste*, see **GEMS** (**IMITATION**), and **MACARONI**.

**PA'STEL**, chalk mixed with other materials and various colours, and formed into pencils or crayons (q. v.).

**PASTEL**. See **WOAD**.

**PASTILE**, **PASTIL**, or **PASTILLE**, a diminutive of *paste*. This term was originally applied to lozenges as little portions of confectionary paste, but it has been of late chiefly confined to a mixture of odorous materials, as in the case of the *fumigating*



*pastiles*, which are burned either as incense or as a means of diffusing an agreeable odour. They are composed of charcoal powder, with such aromatic gums as benzoin, labdanum, &c.; and powders of sweet-scented woods and barks, as sandal-wood, cinnamon, and especially cascarilla barks. Essential oils are also added, and the whole are worked into a paste with a little gum-mucilage, and formed into small sharp-pointed cones about an inch and a half high, and half an inch broad at the base. When perfectly dry, they are used by lighting at the point, and as they burn down an agreeable odour is given out with the smoke. Very tasteful vessels, called pastille burners, usually of porcelain, are made for using them. Another kind of pastille, usually in the form of a small pill covered with gold or silver leaf, is used for perfuming the breath; it is made of the same kind of ingredients, excepting the charcoal.

**PASTO**, a town of the United States of Colombia, on a high plateau between two ridges of the Andes, 148 miles north-east of Quito. Height above sea-level upwards of 8500 feet. It is in the direct route from the Popayan Pass to Quito. Pop. about 7000.

**PASTOR**, a genus of birds of the Starling family (*Sturnidae*), differing from starlings in the compressed and slightly-curved bill. In habits, as in characters, they are very nearly allied to starlings. The name P. is supposed to be derived from their



Rose-coloured Pastor (*Pastor roseus*).

being frequently seen with flocks of sheep. The only European species is the ROSE-COLOURED P., or Rose-coloured Ouzel (*P. roseus*), a rare visitant of Britain and of the northern parts of Europe, and more common in the north of Africa, Syria, and India than in any part of Europe.

**PASTORAL LETTER**, a letter addressed either at certain stated times, or on the occurrence of some notable occasion, by a 'pastor,' but especially by a bishop to the clergy under his jurisdiction, to the laity of his flock, or to both. Of the former class, in the Church of Rome, are the so-called *Leuten Mandates*, or *Instructions*, issued before the commencement of Lent, and making known the regulations enacted for the observance of the Lenten fast, the dispensations granted, and the devotions and other pious works prescribed. Such also are the letters issued by a bishop on many of the chief festivals of the year. It is usual for bishops, besides their stated letters, to address to their clergy or people instructions suited to any particular emergency which may arise, and sometimes to take occasion from the issuing of the stated pastoral letter to offer instruction on some topic of importance which may engage public attention at the time, on some prevalent abuse or

scandal, or some apprehended danger to the faith or to morals. To this class belong many of the remains of the early fathers, especially in the Western Church. In some countries the government, as formerly in Austria, claimed a right to exercise a censorship over the pastoral letters to be issued by the bishops. This right, however, is regarded by churchmen as a usurpation, and although submitted to, is admitted only under protest. See **PLACETUM REGIUM**, **FEBRONIANISM**.

**PASTORAL POETRY** is that kind of poetry which professes to delineate the scenery, sentiment, and incidents of shepherd-life. It is highly probable that the first attempts to give a rhythmic expression to human feeling were to some extent of this character. Men were originally shepherds, and their festal songs and hymns would derive at least substance and imagery from their primitive occupations; but as a distinct branch of poetic art, pastoral poetry was not cultivated till a comparatively late period; for although critics are fond of pointing to the lives of the Hebrew patriarchs, and to the story of Ruth, as specimens of the antiquity of the pastoral in the East, yet, as these profess to be history, and not fiction, they can be instanced only to prove that the material for this kind of poetry existed from the earliest ages. In point of fact, it was only after innocence and simplicity had passed away, or were thought to have passed away, from real life, that men began, half from fancy, and half from memory, to paint the manners of the past as artless, and the lives of their ancestors as constantly happy. It was thus the *Brass Age* that made the *Golden*. The oldest specimens of the classic pastoral are the *Idylls of Theocritus* (q. v.), which appeared about 275 B. C.—long after Greece had produced her masterpieces in epic narrative, in the war ode, and almost all other kinds of the lyric, in tragedy, comedy, history, philosophy, and rhetoric. Theocritus was imitated by Bion and Moschus, whose pastorals approximate in form to the drama. Among the Latins, the refined and courtly Virgil, in the reign of Augustus, wrote his *Bucolica* or *Ecloques*, on the model of his Greek predecessors; but, however beautiful and melodious the verses of these urban writers are, we cannot suppose for a moment that the rude shepherds and shepherdesses of Italy or Sicily indulged in such refined sentiments, or spent their time so poetically as there they are made to do. Virgil, we may rest assured, is as far from giving a genuine picture of pastoral life in his verse, as any modern poet who prates of Chloë and Phyllis.

During the middle ages, pastoral poetry in this artistic, and therefore conventional sense of the term, was almost unknown; but with the first glimpse of reviving classicism, the pastoral reappears. The earliest specimens are afforded by Boccaccio (q. v.), about the first modern Italian who studied Greek. It is to the countrymen of Boccaccio that we owe the creation of the pastoral drama, of which there is no trace in ancient literature. The *Favola di Orfeo* of Politian (q. v.), performed at the court of Mantua in 1483, is the first dramatic poem which pretends to represent the sentiments, incidents, and forms of pastoral life. Critics have forgotten this work when they make Tansillo the inventor of the *favola pastorale*, or *boscareccia*, on account of his *I due Pellegrini* (1539), or Agostino Beccari, whose pastoral comedy, *Il Sacrificio*, was played at Ferrara in 1554. However, it is true that the extraordinary popularity of Beccari's piece originated a crowd of *favole boscareccie*, the finest and most poetical of which is the *Aminta* of Tasso, represented at the court of Ferrara in 1572. A later, but hardly less famous production

is the *Pastor Fido* of Guarini (q. v.), published at Venice in 1590; and in the 18th c., the poet Metastasio (q. v.) revived for a moment the interest in this graceful and picturesque, but unreal branch of literature. In Spain, during the first part of the 16th c., it abundantly flourished. The first who wrote pastoral dialogues was Juan del Elcina (cir. 1500); he was followed by Garcilaso de la Vega, and others. During the reign of the Emperor Charles V., one may say that Spanish imaginative literature was almost wholly of a bucolic character; but in Spain, as elsewhere, it took largely the form of prose-romance (see NOVELS) rather than of poetry, deriving its inspiration from the *Daphnis* and *Chloe* of Longus, the Byzantine romancist, not from the tuneful strains of the Mantuan swan. England, however, can boast of Spenser's *Shepherd's Calendar*, which is at least full of charming poetry, and is appropriately dedicated to Sir Philip Sidney, whose pastoral romance of *Arcadia* outstrips in point of literary beauty all other fictions of that class. The Germans reckon Shakspeare's *As You Like It* in the list of pastoral dramas; but its right to be so classified is by no means clear, although we may admit that it betrays the influence of the pastoral poetry and romance that had just ceased to be the rage among the scholarly geniuses of Europe. A similar influence is visible in the writings of other Elizabethan dramatists, as, for example, in the *Faithful Shepherdess* of Fletcher. In France, pastoral poetry is perhaps older than in any of the western nations. The comedy of Adam de Lehalle, surnamed Le Bossu d'Arras (The Hunchback of Arras), entitled *Le Jeu de Robin et Marion* (and which exists in MS. in the *Bibliothèque Impériale*), belongs to the middle of the 13th century. During the civil wars in the latter half of the 16th c., the pastoral was turned to political uses. In the following century, it continued for some time to be popular, or rather, let us say, fashionable. Even the great Richelieu alleviated the cares of office with the composition of *La Grande Pastorale*; but here, too, the poem soon gave way to the prose-romance, which was hardly less unreal, and far more exciting.

Perhaps the best pastoral, ancient or modern, is the *Gentle Shepherd* of Allan Ramsay (q. v.), published in 1725. 'It is,' says Mr Carruthers (Chambers's *Cyclopædia of English Literature*, vol. i., p. 601), 'a genuine picture of Scottish life, but of life passed in simple rural employments, apart from the guilt and fever of large towns, and reflecting only the pure and unsophisticated emotions of our nature. The affected sensibilities and feigned distresses of the Corydons and Delias find no place in Ramsay's clear and manly page. He drew his shepherds from the life, placed them in scenes which he actually saw, and made them speak the language which he every day heard—the free idiomatic speech of his native vales.' His English contemporaries, Pope, Ambrose Philips, Gay, and others, who form the 'Augustan,' or Queen Anne school of poets, also addicted themselves to the composition of pastoral poetry; but though there is much fine description in the verses, they are, in general, purely conventional performances, in imitation of the classic poets, who, as we have said, did not themselves imitate nature. From this censure, however, must be excepted the six pastorals of Gay, entitled the *Shepherd's Week*, which are full of honest country humour, and contain charming pictures of English country life. Since the early part of the 18th c., however, pastoral poetry, strictly so called, has ceased to be cultivated in England and almost everywhere else. In the pages of Wordsworth, who lived all his days among the

Cumberland shepherds, we indeed find many exquisite glimpses of pastoral life, as it presented itself to the profound and tender imagination of that great poet of nature, but few direct delineations of pastoral manners. Germany imitated abundantly the French and Italian models during the greater part of the 18th century. The last and best of the German series is the *Erwin and Elmire* of Goethe's youth. The general impression appears to be that the age of pastoral poetry has passed away forever, and that Damon and Chloe will never reappear in verse.

PASTORAL STAFF, sometimes also, although not properly, called CROSIER (q. v.) (Lat. *baculus pastoralis*), one of the insignia of the episcopal office, sometimes also borne by an abbot. It is a tall staff of metal, or of wood ornamented with metal, having, at least in the Western Church, the head curved in the form of a shepherd's crook, as a symbol of the pastoral office. The head of the pastoral staff of an archbishop, instead of the crook, has a double cross, from which its name of *crozier* is derived. In the Greek Church the staff is much shorter, and the head is either a plain Greek cross of the form of the letter *Tau*, or it is a double-headed crook, which sometimes appears in the shape of the upsilon,  $\tau$ . It is difficult to determine the time at which the pastoral staff first came into use. The first distinct allusion to it is in St Augustine's commentary on the 124th psalm. Gregory of Tours, in his life of St Martin, mentions the pastoral staff of St Severinus, who was Bishop of Cologne in the end of the 4th century. From an early time, the pastoral staff was connected with



Pastoral Staff.

the actual possession of the jurisdiction which it symbolises. The giving of it was one of the ceremonies of investiture; its withdrawal was part of the form of deprivation; its voluntary abandonment accompanied the act of resignation; its being broken was the most solemn form of degradation. So also the veiling of the crook of an abbot's pastoral staff, during the episcopal visitation, signified the temporary subjection of his authority to that of the bishop. An abbot being required to carry his pastoral staff with the crook turned inwards, shewed that his authority was purely domestic. The pope alone does not use a pastoral staff. In the later medieval period the material was often extremely costly, and, referring to the relaxation of the times, it was said 'that formerly the church had wooden pastoral staves and golden bishops, but that now the staves are of gold and the bishops of wood.' The workmanship was sometimes extremely beautiful. We annex as a specimen of the highest art the pastoral staff of William of Wykeham, now in New College, Oxford. This is a sample of the Norman pastoral staff. The Saxon was by no means so tall. The Irish pastoral staff is of a type quite peculiar, and some of the sculptured specimens preserved in the British Museum, at the Royal Irish Academy, and elsewhere, are very interesting as illustrating the ecclesiastical costume of the period.

PASTORAL THEOLOGY, that branch of theological science which regards the duties and obligations of pastors in relation to the care of souls. It comprises two parts; first, that which treats of

the obligations of the pastors themselves, and which is therefore designed for the training and preparation of the candidates for the pastoral office. The other part of pastoral theology, which might perhaps better be called Popular Theology, comprises the objective teaching which is to be employed in the instruction and direction of the flock committed to the pastor's charge. This branch of theology has long formed a leading portion of the training of candidates in the Evangelical Churches of France and Germany; and a valuable manual for Catholic studies has recently appeared in Vienna, *Lehrbuch der Katholischen Pastoral*, von Dr A. Kerschhammer, 8vo, Wien. 1863.

**PASTRY**, articles of food in which the chief part consists of a paste made of flour. This would of course apply to bread, but it has been limited by custom to such lighter articles as are made by the pastry-cook, and chiefly to those in which the paste is made to assume a light flaky character by the addition of butter, &c., and by the mode of working it up. The commonest kind is made of a dough of flour and water, into which butter or lard is worked by hand, in the proportion of six ounces to the pound. The finest kind is usually termed *puff paste*, and considerable skill is required to make it well, for it depends, next to the goodness of the materials, upon lightness of hand in kneading the ingredients together. These ingredients consist of fine wheaten flour and butter in the proportion of four ounces of butter to a pound of flour, with cold water just sufficient to make a good stiff elastic dough; this is rolled out with a *rolling-pin*, and double the previous quantity of butter is then spread over it. It is then rolled up and lightly kneaded, so as to work the butter in thoroughly. Coolness is very important in making pastry; a marble slab is therefore most desirable for making it upon. The thinner it is rolled out before the butter is then spread the better, because when it is put in the oven the laminae which have been formed by folding or rolling up the butter with the dough, separate by the disengagement of the watery vapour, and the thinner and lighter the flakes are the better is the puff paste. Another kind is called *short paste*; in this the flour is made warm, and the butter or lard used is often melted, and a little sugar and an egg or two are added. This, when baked, has none of the flaky character of puff paste, but it is better adapted for meat and some other kinds of pies which require to be baked without a dish. Game pies, with elaborately-decorated crusts, are made of this pastry.

**PASTURAGE**, in English Law called Common of Pasture, is classed among rights of common or profits *à prendre*, and is the right of one who is not the owner of land to put his sheep or cattle on such land to feed there. In Scotland it is called a servitude of pasturage. In both countries the right can be established by prescription, in England of thirty years, and in Scotland of forty years. Where the parties entitled to pasturage dispute as to their respective proportions of cattle, the suit to redress the matter is called in Scotland an action of 'sowming and rowming.'

**PASTURES** (Lat. *pasco*, to feed) are fields or tracts of land devoted to the feeding of oxen, sheep, and other herbivorous animals, which eat the grass and other herbage as it grows. Grass is grown sometimes in the rotation with grain and other crops, when it remains on the ground for one or more years, is frequently mown during the first summer, and grazed afterwards, but is again ploughed up to be succeeded usually by oats or wheat. For such purposes, rye-grass, red, white, yellow, and alaike clovers, are used either alone or mixed in

varying proportions. On the uplands of Great Britain, wherever from any cause grain crops cannot profitably be grown, and throughout many of the richest plains and valleys, especially of England and Ireland, there are thousands of acres of land which have been under grass from time immemorial. Such permanent pastures are estimated to occupy fully 14,000,000 acres in England, nearly 8,000,000 in Scotland, and about 9,000,000 in Ireland. Sometimes they have been self-sown, occasionally they have been laid down with care, seldom are they as highly cultivated and liberally managed as they should be. The best of them are used for feeding heavy bullocks; those of somewhat poorer description are often grazed by dairy stock; whilst the down or upland pastures are especially profitable for sheep. It has now become a common practice, and is every year becoming more and more general, to give additional food of various kinds to animals fed on pastures. Even cattle grazing on the richest pastures are supplied with linseed cake, &c., to hasten the process of fattening, and to improve their quality; roots are given to sheep when fattening for the market, and hay to those which are to be kept as stock; whilst when oats or beans are cheap, many sheep-farmers find it advantageous to give them even to the hardy stock of exposed hill-pastures. All pastures are much improved by thorough drainage. The application of farmyard dung, soil, lime, and almost every sort of top-dressing is beneficial. Irrigation is sometimes profitable, and in some other countries is far more common and far more requisite than in Britain. Rich pastures on which oxen are fed are injured by sheep, which reject the coarsest grass, and pick out the finest; but a few horses turned into them during the autumn or winter help to consume the coarser tufts. The coarsest and rankest grass may once or twice a year be cut over by the scythe; and either made into rough hay, or if left on the ground, the cattle, when it has partially dried, will readily eat it up. A dressing of lime and salt scattered over the rougher parts of the fields in autumn will sweeten the herbage, and induce the stock to eat it down regularly. Moss, which is a great pest in many pastures, may be got rid of by penning sheep, well fed with swedes, cake, or corn, regularly over the field; or by harrowing the surface in several different directions during January or February, applying then a top-dressing of soil or dung, and in March or April sowing some clover or other seeds, which will be firmed down by the bush harrow, clod-crusher, or heavy roller. The droppings of the cattle ought to be broken up and scattered over the ground. Rich pastures intended for the fattening of cattle ought not to be used during winter, but allowed to become luxuriant before the cattle are turned upon them in spring. Very lean animals, whether oxen or sheep, cannot with advantage be at once placed on very rich pasture, but must be gradually fitted for it. In some of the hill districts of Scotland, devoted to sheep-farming, increased productiveness has resulted from breaking up portions of the pasture, and after two or three crops have been taken, laying them down as pastures again. All good pastures produce a very mixed herbage, not consisting merely of one kind of grass, but of several or many, with clovers and other plants. Different species of Meadow-grass (*Poa*), Fescue (*Festuca*), Foxtail (*Alopecurus*), Oat-grass (*Avena*), Cock's-foot (*Dactylis glomerata*), Rye-grass (*Lolium*), Hair-grass (*Aira*), Vernal-grass (*Anthoxanthum*), and Timothy or Cat's-tail (*Phleum*), are among the most common grasses of British pastures. Yarrow (*Achillea millefolium*) is very abundant in some

## PATAGONIA.

pastures, and is sometimes sown with grass, clover, &c., in land meant for permanent pasture. Different kinds of clover are adapted to different soils and situations. The presence of rushes is very indicative of the want of drainage. Thistles and docks are injurious, and are to be extirpated as much as possible. Some of the plants naturally abundant on high hill-pastures, as *Nardus stricta* and *Juncus bafomius*, are very unnutritious; and the substitution of others in their stead, is one of the benefits derived from the breaking up of such lands.

**PATAGO'NIA**, the most southern country of South America, bounded on the N. by the Argentine Republic, and the Rio Negro, which separates it from the Pampas (q. v.); on the N.W. by the Chilean territories; on the W. by the Pacific; on the S. by the Strait of Magellan, which separates it from Tierra del Fuego; and on the E. by the Atlantic. It lies in lat. 38°—53° S.; and in long. 62° 40'—75° 40' W. Length upwards of 1000 miles, greatest breadth about 480 miles; area about 350,000 square miles; pop. estimated at 120,000. If this estimate is correct, P. must be one of the most sparsely-peopled regions of the globe. The coast of the Atlantic is much broken by extensive bays and inlets, none of which, however, are of much importance or advantage, in a commercial point of view. Along the western coast, and stretching from 42° S. to the Strait of Magellan, are numerous islands, with precipitous shores, belonging apparently to the system of the Cordilleras. The principal islands are Chiloé, the Chonos Archipelago (q. v.), Wellington Island, the Archipelago of Madre de Dios, Queen Adelaide's Archipelago, and Desolation Island. These islands—which, together with several peninsulas, form a coast almost as rugged as that of Norway—are mountainous; but in none of them, except in Desolation Island, do the mountains rise to the snow-line.

*Surface, Soil, &c.*—The country of P. divides itself into two regions, very unequal in size and very different in character. These are Eastern and Western P., which are divided by the great mountain range of the Andes. Western P., comprising this range, the coast districts, and the islands, is rugged and mountainous. Opposite the island of Chiloé are two active volcanoes, one of which, Minchinmavida, is 8000 feet high. The slope of the country from the Andes to the Pacific is so steep, and the strip of shore so narrow, that the largest river of this district has its origin only about 13 miles from its embouchure on the coast. In the island of Chiloé, in the north of Western P., the mean temperature of winter is about 40°, that of summer rather above 50°; while at Port Famine, in the extreme south of this region, and 800 miles nearer antarctic latitudes than Chiloé, the mean temperature is not much lower, being in winter about 33°, and in summer about 50°. This unusually small difference in the mean temperature of the extremes of Western P., which extends over about 14° of lat., is due to the great dampness of the atmosphere all along the coast. The prevailing winds of this region blow from the west; and, heavily surcharged with the moisture they have drawn from the immense wastes of the Pacific Ocean, they strike against the Andes, are thoroughly condensed by the cold high mountains, and fall in rains that are almost perpetual from Chiloé to the Strait of Magellan. South of 47° S. lat., hardly a day passes without a fall of rain, snow, or sleet. This continual dampness has produced forests of almost tropical luxuriance. A kind of deer wanders on the east side of the mountains; pumas and water-fowl are met with; and, along the coast, seals, otters, sea-elephants, fish, and shell-fish are found.

Eastern P., often called *the plains*, comprises by far the larger portion of P., and extends eastward from the Andes to the Atlantic. Its surface has not yet been thoroughly explored, and is described only in the most general terms. According to all accounts written previously to the present year (1864), Eastern P., from its northern to its southern limits, is an immense, stony, shingly waste, generally level, but gradually rising in terraced steppes from the Atlantic to the Cordilleras. The elevation of the highest of these terraces is about 3000 feet. The surface is covered with stones and pebbles, mixed with earth of a whitish colour, overlying great masses of porphyry, and strewn with immense boulders. Thorny brushwood, tufts of coarse brown grass, and, toward the west, basaltic ridges, break the dead level of the dreary landscape. The soil is strongly impregnated with saltpetre. Salt lakes of every variety of extent and level abound. Many of these lakes are surrounded by a brilliant snow-white crust; the waters of some of them are cold in summer and hot in winter, while in others the waters are poisonous. Extending along the south coast for several hundred miles, there is a great deposit of tertiary strata, underlying a stratum of a white pumaceous substance, a tenth part of which is marine infusoria. Sea-shells are scattered everywhere across the country, and salt is everywhere abundant, from which circumstances it has been inferred that this tract was once a sea-bottom. The air of Eastern P. is generally dry and hot, deriving no moisture from the prevailing west winds, which pass over the plains after having been drained by the Andes. Hurricanes, however, cutting and frigid, sweep over the plains with great fury, stripping the hides from the roofs of the *routahs* or huts, and paralysing the inhabitants with cold and with fear. The above account, though in general correct, must be supplemented as well as modified by a few facts as to the surface from one who recently lived for three years in P. and its vicinity. According to M. Guinnard, the country along the banks of the Rio Negro is for the most part mountainous, and is intersected by deep ravines; but it is not, as has hitherto been believed, completely sterile, for, on the contrary, the escarped banks of the river are sometimes abundantly fertile. The same traveller further estimates that one-third of the entire area of this country—which has hitherto been described as barren—is of great fertility, especially the regions on the east coast and on the Strait of Magellan in the south. Along the eastern base of the Andes also, the great tract of territory called *Los Serranos* is astonishingly picturesque and fertile. Here great forests abound, to which the Indians retire for shelter from the freezing winds of winter. There are also deep valleys furrowed by mountain torrents; and numerous lakes, the haunts of wild-duck and other water-fowl which would delight the European sportsman, but which are never disturbed by the Indians, and are almost as tame as barn-yard fowls. Except pasture, Eastern P. has no productions. However fertile the soil in some places may be, it is nowhere cultivated. The Indians live upon the produce of the chase alone, and seem to desire no better sustenance. The principal rivers are the Rio Negro (q. v.); the Chupat, which flows through a good soil, producing excellent pasture and good fire-wood; and the Santa Cruz, which flows through a barren district, in a valley from one to five miles wide, and 1400 feet below the level of the plain. All these rivers rise in the Andes; the Chupat flows east, and the others south-east. Herds of horses are reared, dogs abound, and in the more favoured regions, cattle are bred; pumas and foxes are met with as well as condors, hawks

## PATAGONIA.

partridges, and water-fowl in Los Serranos. But by far the most important animals are the guanaco (wild llama), the nandou (Patagonian ostrich), and the gama, a kind of deer.

*Inhabitants.*—The Patagonians have been hitherto described only in the most general terms, and in many cases very inaccurately. Little was known of their appearance, habits, and employments. Recent information, however, enables us definitively to class the Patagonian monster of the early voyagers with Gulliver's giants. The tallest of the tribes are composed of men who, on an average, are nearly six feet in height; while in other tribes the average height is an inch or two less. There is reason to believe, however, that instances of unusual height are as rare in P. as in Europe. The peculiar costume of the Patagonians, which in most instances consists of a long mantle of hide, drooping with unbroken outline from their shoulders almost to the ground, gives them the appearance of extraordinary height. Many of the tribes also are large in body, while they have comparatively short extremities; and these, when seen on horseback, covered with their long mantles, seem almost gigantic in stature. Their colour is a reddish brown. Their shoulders are large, and well thrown back; the chest is well expanded; the head large, the forehead open and prominent; the mouth large; the eyes black, and generally large; the nose frequently hooked, long, and thin, though among some tribes it is, as a rule, broad at the nostrils; the ears are large, and elongated by the heavy ornaments of their own manufacture which they wear in them, and which are so large that they often rest on the shoulders. The hair, generally black, coarse, and lank, is sometimes rolled together on the top of the head. Their houses, called *roukaks*, are formed of three rows of stakes driven into the ground. The middle row is higher than the others, and the three rows are tied together with strings of hide, and so kept in their place. This frail framework is covered with hides which reach the ground on all sides, and are fastened to it by small stakes of bone. At nightfall, guanaco hides are spread on the ground within the tents, and the men and women laying aside their mantle, their only garment, and which sometimes serves as a blanket, go to sleep under the same roof and in the same apartment. Bathing in cold water every morning, throughout the whole year, is a custom to which men, women, and children conform; and although the morning bath may not free them from vermin—a national characteristic—yet it has the effect of preventing disease, and of enabling them the more easily to endure the severities of winter. The men, when out on the hunt, shew wonderful courage and adroitness; when not so engaged, they live in perfect idleness. They are incredibly greedy and voracious. They deck their heads, and ornament them into the perfection of ugliness, greasing their hair with the grease of the horse. They pull out the hair of the eyebrows and beard, and paint their bodies with black, red, and other colours. The Patagonians are nomads; some of the tribes, however, as the *Puelches*, are nomads from choice, not from necessity, for their district or headquarters is abundantly fertile. The more important tribes are nine in number; and each tribe is led and governed by a cacique, whose power extends also to numerous sub-tribes. Each family and each man, however, is entirely free, and can remain attached to a certain tribe or separate from it at pleasure. The Patagonians form themselves into these communities for the purpose of self-defence. Wars are so frequent that security is found only in union. The chiefs are considered as the fathers, the leaders, and the rulers of the tribe; and are selected

chiefly on account of their bravery in battle. The more powerful tribes frequently make raids upon settlements, and carry off great numbers of horses and cattle. They subsist upon the flesh of horses, nandous, gamas, and guanacos; the flesh they eat is generally raw. Their choice morsels are the liver, the lungs, and the raw kidneys, which they prefer to eat dished in the warm blood of the animal, or in curdled milk seasoned with salt. Roots and fishes are also eaten, but raw flesh is the staple. They are hospitable among themselves, though bitterly hostile to Christians. Their only manufactures are mantles of guanaco hide, and saddles, bridles, stirrups, and lassos. The lassos and the articles of harness are chiefly plaited, and evince wonderful ingenuity and nicety of execution. The mantles are made for the most part by a tribe called the *Tcheuelches*. They are mainly made by women, who first in a rude and primitive manner tan the leather, then put the hides together, and sew them with the small sinews of the animal itself. Afterwards the men rub them with a stone for the purpose of suppling them and flattening the seams, and then ornament them with capricious designs in red and black paint. The Indians obtain a few cattle and horses in exchange for these mantles, which are no less prized by neighbouring tribes than they are by the Hispano-Americans. Clothed in one of them, the natives expose themselves to the most intense cold without receiving any injury.

The religion of the Patagonians is dualistic. They believe in two gods or superior beings—the God of Good and the God of Evil; or, in their own language, *Vita Ouñetrou*—the Great Man, and *Honacouvou* or *Gualetchou*—the Cause of Evils. The former they consider the creator of all things, and they believe that he sends the sun to them as his representative, as much to examine what takes place among them, as to warm their bodies and renew the brief spring verdure. The moon is another representative, whose office it is to watch them and give them light. Believing that they themselves require a great deal of 'watching,' they further believe that every country on the globe has its own sun and moon, or special watchers. They have no idols. Their faith is transmitted from father to son, and its observances are strictly attended to. They are full of strange superstitions. They dread the north and the south, believing that from the south come evil spirits, who take possession of the souls of the dying, and bear them off to the north. They consider that the best means of ensuring a long life is to go to sleep with the head lying either to the east or to the west. They also believe that all natural phenomena have their causes in their own conduct, and that all misfortunes are sent as punishments due to moral delinquencies. Thus, the fearful tempests that sweep over their plains inspire them with the greatest dread. During the prevalence of the hurricane, they crouch together in their huts; fear makes them inactive, and they do not stir from their grovelling position even to cover themselves with the hides which the tempest strips from their huts. The Patagonian never eats or drinks without turning to the sun, and throwing down before him a scrap of meat or a few drops of water, and using a form of invocation. This form of invocation is not fixed, but it hardly ever varies, and is to the following effect: 'O Father, Great Man, king of this earth! give me favour, dear friend, day by day; good food, good drink, good sleep; I am poor myself, are you hungry? Here is a poor scrap; eat if you wish.' The Patagonians observe two great religious fêtes—one in summer, in honour of the Benevolent Deity; and another in autumn, in honour of the God

of Evil. On the occasion of these fêtes, the Indians assemble on horseback, dressed in the most ceremonious manner, with their hair newly greased, and their bodies freshly painted. On such occasions, it is customary to wear whatever vestments they may have obtained either in war or by stealth from civilised men; and a Patagonian chief may be seen wearing above his mantle of hide the shirt of the European, or casing his legs in a pair of pantaloons. The Patagonians are much given to gambling and to drinking. They make intoxicating beverages from the berries which they find in their woods, and they obtain liquor from the Hispano-Americans, in exchange for mantles.—*Trois Ans D'Esclavage chez les Patagons, par A. Guinnard.*

PĀTĀLA (from *pat*, fall) is, in Hindu Mythology, the name of those inferior regions which have seven, or, according to some, eight divisions, each extending downwards ten thousand *yojanas*, or miles. The soil of these regions, as the *Vishn'u-Purān'a* relates, is severally white, black, purple, yellow, sandy, stony, and of gold; they are embellished with magnificent palaces, in which dwell numerous *Dānavas*, *Daityas*, *Yakshas*, and great snake-gods, decorated with brilliant jewels, and happy in the enjoyment of delicious viands and strong wines. There are in these regions beautiful groves, and streams and lakes, where the lotus blows, and the skies are resonant with the kokila's songs. They are, in short, so delightful, that the saint Narada, after his return from them to heaven, declared among the celestials that P. was much more delightful than Indra's heaven. Professor Wilson, in his *Vishn'u-Purān'a*, says 'that there is no very copious description of Pātāla in any of the *Purān'as*; that the most circumstantial are those of the *Vāyu* and *Bhājavata Purān'as*; and that the *Mahābhārata* and these two *Purān'as* assign different divisions to the *Dānavas*, *Daityas*, and *Nāgas*. . . . The regions of the Pātāla and their inhabitants are oftener the subjects of profane than of sacred fiction, in consequence of the frequent intercourse between mortal heroes and the serpent-maids. A considerable section of the *Vṛ'hat-Kathā* consists of adventures and events in this subterraneous world.' For inferior regions of a different description, see NARAKA.

PATANJALI is the name of two celebrated authors of ancient India, who are generally looked upon as the same personage, but apparently for no other reason than that they bear the same name. The one is the author of the system of philosophy called Yoga (q. v.), the other the great critic of Kātyāyana (q. v.) and Pān'ini (q. v.). Of the former, nothing is known beyond his work—for which see the article YOGA. The few historical facts relating to the latter, as at present ascertained, may be gathered from his great work, the *Mahābhāshya*, or 'the great commentary.' The name of his mother was Gonikā; his birthplace was Gonarda, situated in the east of India, and he resided temporarily in Cashmere, where his work was especially patronised. From circumstantial evidence, Professor Goldsticker has, moreover, proved that he wrote between 140 and 120 B. C. (*Pān'ini, his Place in Sanscrit Literature*, p. 235, ff.). The *Mahābhāshya* of P. is not a full commentary on Pān'ini, but, with a few exceptions, only a commentary on the Vārttikas, or critical remarks of Kātyāyana on Pān'ini. 'Its method is analogous to that of other classical commentaries: it establishes, usually by repetition, the correct reading of the text, in explaining every important or doubtful word, in shewing the connection of the principal parts of the sentence, and in adding such observations as may be required for a

better understanding of the author. But frequently Patanjali also attaches his own critical remarks to the emendations of Kātyāyana, often in support of the views of the latter, but not seldom, too, in order to refute his criticisms, and to defend Pān'ini; while, again, at other times, he completes the statement of one of them by his own additional rules.' P. being the third of the grammatical triad of India (see PĀN'INI), and his work, therefore, having the advantage of profiting by the scholarship of his predecessors, he is looked upon as a paramount authority in all matters relating to classical Sanscrit grammar; and very justly so, for as to learning, ingenuity, and conscientiousness, there is no grammatical author of India who can be held superior to him. The *Mahābhāshya* has been commented upon by Kaiyyat'a, in a work called the *Bhāshya-Pratīpa*; and the latter has been annotated by Nagojibhatta, in a work called the *Bhāshya-pratīpodyota*. So much of these three latter works as relates to the first chapter of P's first book of Pān'ini, together with the Vārttikas connected with them, has been edited at Mirzapore, 1856, by the late Dr J. R. Ballantyne, who also gave a valuable literal translation of the first forty pages of the text.

PATA'PSCO, a river of Maryland, U.S., rises on the northern boundary of the state, and flows south-easterly 80 miles to the Chesapeake Bay, 14 miles south of Baltimore, to which city it is navigable. Its falls furnish water-power to numerous factories.

PATCHOULL. This very interesting material is the dried branches of *Pogostemon Patchouli* (natural order *Labiatae*), which was first introduced to this country as an article of merchandise in 1844. The plant is a native of Silhet, the Malay coast, Ceylon, Java, the neighbourhood of Bombay, and probably also of China; but owing to the fondness of Asiatics for the perfume which it yields, it is difficult to say where it is native or cultivated. Every part of the plant is odoriferous, but the younger portions of the branches with the leaves are chosen; they are usually about a foot long. The odour is peculiar and difficult to define, but it has a slight resemblance to sandal-wood; it is very powerful, and to many persons is extremely disagreeable. The odour of patchouli was known in Europe before the material itself was introduced, in consequence of its use in Cashmere to scent the shawls with a view of keeping out moths, which are averse to it; hence the genuine Cashmere shawls were known by their scent, until the French found the secret, and imported the herb for use in the same way. Its name in India is *Pucha-pat*, and it is there used as an ingredient in fancy tobaccos, and as a perfume for the hair. It is also much prized for keeping insects from linen and woollen articles. The essence of patchouli is a peculiar heavy brown oil, with a disagreeably powerful odour; it is obtained by distillation, and requires extreme dilution for perfumery purposes.

PATELLA, or KNEE-CAP, is a Sesamoid Bone (q. v.), developed in the single tendon of the *rectus, vastus externus*, and *vastus internus* muscles—the greater extensor muscles of the leg. It is heart-shaped in form, the broad end being directed upwards, and the apex downwards. The anterior or external surface is convex, perforated by small apertures for the entrance of vessels, and marked by rough longitudinal striae, while the posterior or internal surface is smooth and divided into two facets by a vertical ridge, which corresponds and fits into the groove on the lower articulating surface of the femur or thigh-bone, while the two facets (of

PATELLA AND PATELLIDÆ—PATENT.

which the outer is the broader and deeper) correspond to the articular surface of the two condyles.

This bone is liable both to dislocation and fracture.



Fig. 1.—Posterior surface of right Patella.

1, outer facet; 2, inner facet; 3, surface to which the ligamentum patellæ is attached.

Dislocation may occur either inwards or outwards; but it is most frequent in the outward direction. The displacement may be caused either by mechanical violence, or by too sudden contraction of the extensor muscles in whose conjoined tendon it lies; and is most liable to occur in knock-kneed, flabby persons. It may be readily detected by the impossibility of bending the knee, and by the bone being felt in its new position, and

except in one rare variety, the dislocation is capable of being reduced without any difficulty. Fractures of the patella may (like dislocation) be caused either by muscular action or by mechanical violence.

Fracture by muscular action is the more common of the two forms, and occurs thus: A person in



Fig. 2.

a, rectus muscle; b, vastus externus muscle; c, ligamentum patellæ; d, external condyle of right femur; e, head of tibia; f, head of fibula.

danger of falling forwards, attempts to recover himself by throwing the body backwards, and the violent action of the extensors (chiefly the *rectus*) snaps the patella across, the upper fragment being drawn up the thigh, while the lower portion is retained *in situ* by that portion of the common tendon which is continued from the patella to the tubercle of the tibia, and which is called the ligamentum patellæ. The treatment consists in relaxing the opposing muscles by raising the trunk, and slightly elevating the limb, which should be kept in a straight position. In consequence of the great difficulty of bringing the broken surfaces into exact apposition, as may be readily understood from the accompanying figure, it is very difficult to obtain bony

reunion of the parts, and the case generally results either in mere ligamentous union or in no true union at all.

PATELLA and PATELLIDÆ. See LIMPET.

PAT'EN (Lat. *patina*, a dish), the plate employed for the elements of bread in the Eucharistic service. Anciently it was of considerable size; and while the practice of the OFFERTORY (q. v.) continued, there was a special paten for the bread-offering. In the Roman Catholic Church, in which the unleavened wafer-bread is used, and the communion is distributed from a distinct vessel called PYX (q. v.), the paten is a small circular plate, always of the same material with the chalice. It is often richly chased or carved, and studded with precious stones. It is used only in the mass.

PAT'ENT is an exclusive right granted by the crown (in letters *patent* or open, whence the name) to an individual to manufacture and sell a chattel

or article of commerce of his own invention. The policy of the present law of patents has latterly been much canvassed, and it has been suggested that, instead of the present monopoly, with the drawback of litigation to which it uniformly gives rise, the use of all inventions should be dedicated to the public at once, and the inventor rewarded by a pension from the state, according to the merits and utility of the invention. The present law allows the inventor to have a monopoly of his invention for fourteen years, with a further privilege at the end of that time, provided he has not been sufficiently remunerated, to have the patent renewed for a further term of fourteen years. That some mode of rewarding the individual whose perseverance and ingenuity have enabled him to discover a new invention should be established, is universally admitted, but whether it should be at the expense of that part of the public who are purchasers, and therefore benefited by his discovery, or by the public at large in the shape of a pension, is a matter still undecided. The evils of the present law are that there is a great deal of uncertainty in the mode of ascertaining what is a new invention. Hence, when a patent has been granted, if it is of such a nature as to lead to competition, infringements are almost matters of course, and the only mode of discovering and checking the infringement is so tedious, costly, and ineffective, that inventors generally pass their lives in constant litigation, fighting in detail a succession of imitators who often have nothing to lose by defeat, and therefore entail all the greater burden on the legitimate manufacturer. It has been said that not more than three patents per cent. are remunerative. A royal commission has latterly been engaged in inquiries as to the best mode of remunerating inventors, and improving the law in reference to infringements; but it is doubtful how far the subject is capable of being put on a better footing, so many difficulties being inherent in it. The crown seems always to have enjoyed the prerogative right to grant monopolies, and this had been so greatly perverted in the time of Elizabeth, that the popular clamour led to a statute in the following reign, having for its object to prevent the crown in future making any grants of that kind which should be prejudicial to the interests of trade. By that act an exception was expressly made in favour of new inventions. At first the judges construed grants of monopoly to inventors very strictly; but afterwards it was seen that they were for the benefit of trade, and were dealt with more liberally. An important modification of the law was introduced by a statute of Queen Anne, which required every inventor to describe in detail the nature of the invention in an instrument called a specification. Another statute of 5 and 6 Will. IV. c. 83, further altered the law by allowing parties who had a difficulty in separating what was new from what was old in their invention to enter an express disclaimer of that part which was not new. But the most important alteration was made in 1852, by the statute of 15 and 16 Vict. c. 83, which reduced the fees, and otherwise improved the practice attending the obtaining of patents for the United Kingdom. Before stating shortly the substance of this act, it may be observed that there has always been a difficulty in defining what is an invention that is patentable—a difficulty which no act of parliament can get rid of, for it is inherent in the subject-matter. It has been held that a patent must be not merely a discovery of a new substance or article of food, but it must be a combination of processes producing some new result, or an old result by different means. It is of the essence of the patent that it be entirely new, that is,

that it should not have been described in a published book, or well known in the business of the world, nor publicly used before. What amounts to a public use is necessarily difficult of definition, but the thing must have been so used that others may have known and used it besides the inventor. The specification must be so drawn as to give a full disclosure of the secret, and describe it so that an intelligent person could from the description make or produce the article itself.

There is a patent-office in London, in Edinburgh, and in Dublin. All the business connected with patents is now transacted at the office in London, the Scotch and Irish offices being used only as places for inspecting copies of patents, specifications, and documents. The commissioners of patents are the Lord Chancellor, Master of the Rolls, Attorney and Solicitor General of England and Ireland, and the Lord Advocate and Solicitor General of Scotland. The mode in which an inventor proceeds is, first to present a petition for a grant of letters-patent, accompanied by a statement in writing of the specification, a copy of which must be left at the patent-office. These papers, as also drawings, must be in a certain prescribed form. The application is referred, as a matter of course, to one of the law officers of the crown, who may call to his aid a scientific person to be paid by the applicant. A provisional patent may be applied for in the first instance, and the complete patent deferred for six months—an arrangement which gives the benefit of priority to the applicant of time to prepare and test his specification, and of paying the expenses more gradually; but the effect is the same in the end, the patent dating from the first application. After a patent has been granted, and been in existence for three years, a fee of £50 must be paid; and, at the end of the seven years, a fee of £100. The letters-patent extend to the whole of the United Kingdom. The practice with reference to patents, especially as to the drawing of the specification, is too minute to justify an inventor to attempt to take out a patent without professional aid; and a class of persons called patent agents (a business for which no qualifications are at present required by any constituted authority) devote themselves to this branch of business. But great caution is required in selecting those only who are competent and honourable. Their charges are generally ascertained by estimate beforehand, and are usually made in a round sum. The fees payable to the law officers are as follows: On leaving petition for grant of letters-patent, £5; on notice of intention to proceed with application, £5; on warrant of law officer for letters-patent, £5; on sealing of letters-patent, £5; on filing specifications, £5; at or before expiration of third year, £50; at or before expiration of seventh year, £100.

Besides these fees, if opposition is entered to the grant, additional fees are incurred, both by the party applying and the party opposing.

A patent obtained in this country does not extend to the colonies, but several of the colonies have machinery for granting patents for a like period. In the United States, patents are also granted for a term of 14 years. In France, the term is 5, 10, or 15 years, at the option of the applicant; in Prussia, for 15 years; in Russia, for 3, 5, or 10 years; in Spain, for 5, 10, or 15 years; in Belgium, for 20 years; in Holland, for 5, 10, or 15 years; in Austria, not more than 15 years; in Sardinia, 15 years. In all cases, fees are exigible from the patentee.

PATERA (Lat.), a round dish, imitations of which were carved by the Romans in the panels

of their ceilings, &c. The name is also applied

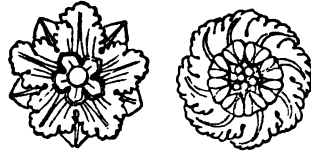

Patera.

to the foliated ornaments used in the same position.

PATERCULUS, C. VELLEIUS, a Roman historian, descended from an ancient and wealthy Campanian family, is thought to have been born about 19 B. C. He entered the army at an early age, and from 4 to 12 A. D. served under Tiberius as prefect or legate in Germany, Pannonia, and Dalmatia. He was a great favourite with Tiberius, and when the latter became emperor, 14 A. D., P. was appointed prætor. He was alive in 30 A. D., as his history comes down to that year; but it is conjectured that in the following year he was probably put to death as one of the friends of Sejanus, of whom he speaks highly in his work. P.'s claim to remembrance is his *Historia Romana*, a compendium of universal, but more particularly of Roman history, in two books. The work, as we have it, is not complete; the beginning, and a portion following the 8th chapter, being wanting. It seems to have commenced with the fall of Troy; and describes only the most prominent historical incidents, but these, fortunately, with considerable fulness of detail. Scholars are satisfied that it is the work of a man who is, on the whole, impartial and discriminating. The style is based on that of Sallust. The *editio princeps* of the *Historia Romana* appeared at Basel in 1520; the most valuable is Rhunken's, on account of its excellent notes (Lugd. Bat. 1789), reprinted by Frotscher (Leips. 1830—1839); but Orelli's (Leips. 1835) has the least corrupt text.

PATEREROS, were small pieces of ordnance, now obsolete, worked on swivels; most commonly used on board ships, where they were mounted on the gunwale, and discharged showers of old nails, &c., into hostile boats. The French called them Pierriers, from loading them with stones.

PATER-NOSTER (Lat. 'Our Father') called also THE LORD'S PRAYER, a short form of prayer suggested or prescribed by our Lord to his disciples (Matt. vi. 9—13, Luke xi. 1—4) as the model according to which, in contrast with the prayers of the Pharisees, their petitions ought to be composed. From the earliest times the Pater-Noster has been accepted as, by excellence, the form of Christian prayer. It formed part of all the ancient liturgies. So sacred, indeed, was its use, that, strange as the provision may now appear, it was comprehended among the things which were reserved from pagans and catechumens under the well-known Discipline of the Secret (q. v.). The early fathers—Origen, Tertullian, Cyprian—refer to it in terms which shew that even then it was a recognised form of private prayer. It was solemnly recited at the administration of baptism, and one of the privileges of the baptised was the use of the Pater-Noster. More than one of the fathers, and very many later writers of every form of Christian belief, have devoted special treatises to the exposition of this prayer, which is regarded as embracing in its few but comprehensive clauses all the fitting and legitimate objects of the prayer of a Christian. The Catechism of the Council of Trent contains a



detailed exposition and commentary of it, and in all the services not only of the Roman Missal, Breviary, Ritual, Processional, and Ordinal, but in all the occasional services prescribed from time to time, it is invariably introduced. In the Rosary (q. v.) of the Virgin Mary it is combined with the Hail Mary, the prayer addressed to the Virgin (whence the larger beads of the 'Rosary' are sometimes called *Pater-Nosters*), and perhaps the most usual of all the formal shorter devotions among Roman Catholics is the recitation a stated number of times of the 'Pater,' with one or more 'Ave Marias,' generally concluding with the Doxology. The form of this prayer as commonly used by Protestants concludes with the clause, 'for Thine is the kingdom, and the power, and the glory for ever. Amen.' This clause is not used by Roman Catholics. Of the two gospels—that of Matthew and that of Luke—in which the delivery of the prayer by our Lord is related, that of Luke has not this clause; and even in the Gospel of Matthew it is found only in the later MSS., in which it cannot be doubted that it is a modern interpolation. It was retained, however, in Luther's German translation, and in the Authorised Version, whence its use became common among Protestants.

PATERSON, a city of New Jersey, U.S., at the falls of the Passaic River, on the Morris Canal, and New York and Erie Railway, 17 miles north-west of New York, a well-built city, with 8 cotton factories, 10 machine factories, extensive paper-mills, and factories of cotton, duck, flax, hemp, &c., to which the falls of the Passaic furnish abundant water-power. The half of the locomotives made in the United States are manufactured here. The city contains county buildings, an academy, bank, 2 newspapers, and 16 churches. Pop. in 1860, 19,588.

PATERSON, WILLIAM, the most celebrated, after John Law (q. v.), of the commercial schemers of the 17th c., was, like Law, a Scotchman, and is said to have been born in the parish of Tinwald, Dumfriesshire, about 1660. Of his early history nothing is known beyond the fact, established by conclusive evidence, that he possessed himself of an extensive and minute knowledge respecting the institutions and commerce of foreign countries. His first appearance in history is at the time when he laid before the merchants and capitalists of London the complete draught of his scheme of banking. The scheme was favourably, nay even eagerly, adopted by them, and after being modified so as to render it practically serviceable, became the basis of an institution which, in 1690, was incorporated under the name of the 'Bank of England.' P., however, soon became, for reasons now unknown, disconnected with the Bank. His next project was the renowned Darien Scheme (q. v.), which received the royal sanction in 1695, and came to ruin in 1701. Its disastrous failure so affected P. as to produce temporary lunacy, and after his recovery he lived in retirement. Nothing further is known concerning him.

**PATHOLOGICAL ANATOMY**, or the anatomy of diseased organs, is included in, but must not be confounded with pathology, as until comparatively lately was often the case. It is merely a section—although a most important section—of pathology, contributing (as Professor Vogel has well remarked) 'to practical medicine the solid materials from which to construct a basement, without having the power to erect a perfect edifice.' Pathological anatomy enables the surgeon to decide whether a suspicious tumour is malignant or of a comparatively harmless nature, and

in many other ways is of the greatest importance to surgery; and although at first sight it might appear to be of small importance in relation to Therapeutics, this is not in reality the case. Scientific treatment necessarily demands an accurate knowledge of the material changes which lie at the foundation of the various morbid symptoms. Hence pathological anatomy not only forms a portion of the positive basis of Therapeutics, but it also points out the processes by which the different altered parts may be gradually restored to their normal condition. It not merely indicates what requires healing, but in many cases also the course that must be adopted in order to aid the curative tendency of nature. It likewise serves as a check on therapeutics, exposing, in a most conclusive manner, the absurdity of many pretended methods of cure. It points out, for example, that in a certain stage of inflammation of the lungs (Pneumonia) a fibrinous fluid separates from the blood, and by its coagulation renders a portion of the tissue of the lung impermeable to air; and further that it requires several days for this coagulated matter to resume the fluid condition and to be removed. If any one should assert—and such assertions have often been made—that in this stage of the disease he could apply a remedy which would cure the patient in a few hours, a very slight knowledge of pathological anatomy would shew the folly of such an assertion. The best English works on this subject are Vogel's *Pathological Anatomy of the Human Body*, and Jones and Sieveking's *Manual of Pathological Anatomy*.

**PATHOLOGY** (from the Gr. *pathos*, disease, and *logos*, a discourse) is that department of medicine which treats of the doctrine of morbid actions or diseases. In this country the term is so far restricted as not to include the causes, treatment, &c., of diseases, but the most eminent French and German writers regard it as equivalent to 'the Theory and Practice of Medicine,' and consider it as treating not only of the classification, causes, symptoms, and physical signs of diseases, but as also including their seat, the phenomena which precede and follow them, their progress, their duration, their modes of termination, the different forms in which they occur, their complications, the changes to which they give rise in the solids and fluids of the body, and their treatment.

PATMOS, a bare and rocky island in the Ægean Sea, about 45 miles in circumference. It belongs to the group called the Sporades, lies to the south of Samos, and is now called Patino, but in the middle ages *Palmosa*, although there is now only one palm-tree in the whole island. It is celebrated as the place to which the apostle John was exiled, and where he saw the visions recorded in the Book of Revelation. On the top of a mountain stands the famous monastery of 'John the Divine,' half way up to which a cave is pointed out to the traveller in which, according to tradition, the apostle received his revelations. See Ross's *Reisen auf den Griechischen Inseln des Agäischen Meeres*, and Guérin's *Description de l'île de Patmos*, &c. (Paris, 1856).

PATNA, or more correctly, PATIANA (i. e., the town), an important trading town of Hindustan, capital of a British district of the same name, stands on the right bank of the Ganges, 10 miles east of Dinapur, and 377 miles by land, and 464 miles by water, north-west of Calcutta. The city proper, forming a quadrangle, extends a mile and a half along the river-side, and is half that extent in breadth. P. is generally supposed, however, to include the suburbs, which stretch on each side

of it, on the south bank of the Ganges. The European quarter is on the west of the town proper; but the houses are neither numerous nor of imposing appearance. In this quarter is a large school, in which the English language and literature form important branches of study. P. is not a pleasant place of residence; its streets are covered with mud and slime in winter, and its air is thickly impregnated with choking dust in summer. Its temperature rises unusually high during the hot season, being increased by the heat reflected and radiated from a bare tract of sand on a neighbouring island in the Ganges. Pop. about 284,000.

P., under the former name of *Padmavati*, is supposed to have been the capital of Bahar, 419 years B. C. Here, at an early period, the English established factories, and traded in opium, rice, &c. In 1763, disputes about transit-duties arose between the Company's servants and the native government. A war ensued, the result of which was that the British drove out the native forces, and took possession of the district.

**PATOIS** (of uncertain derivation), the French term applied to corrupt dialects of a language spoken by the uneducated. See **DIALECT**.

**PATON, JOSEPH NOEL, R.S.A.**, one of the most distinguished living Scottish artists, was born in Dunfermline in 1823. It is understood that in early life he employed himself in making designs for the damask manufacturers of his native place, and for the muslin and lace embroiderers of Paisley. He, however, soon turned his attention to the walk of art proper, and his cartoon sketch, 'The Spirit of Religion,' gained one of the three premiums at the Westminster Hall competition in 1845. Two years thereafter, his oil-picture of 'Christ bearing the Cross,' and his 'Reconciliation of Oberon and Titania,' jointly gained the prize of £300. He subsequently executed a companion-picture to the 'Reconciliation,' entitled the 'Quarrel of Oberon and Titania;' and both now adorn the Royal Scottish Academy's galleries in Edinburgh. These pictures made the artist's reputation. Although somewhat hard and dry in colour, and without any retiring and shadowy depth, they are full of brilliant fancy; and the multitudes of figures, and the variety of fairy incident, affect the spectator much in the way that the constant sparkle of Congreve or Sheridan affects the reader. He has since painted much more simply and powerfully. 'Dante Meditating the Episode of Francesca,' was exhibited in Edinburgh in 1852; and the 'Dead Lady,' a work of great and solemn pathos, in 1854. In 1855, his great picture, 'The Pursuit of Pleasure,' was exhibited in that city, where it was much criticised and much admired. He has since painted 'Home from the Crimea,' a replica of which is in the possession of Her Majesty; and 'In Memoriam,' a scene from the Indian mutinies; and for the Association for the Promotion of the Fine Arts in Scotland, a series of picture-illustrations of the 'Dowie Dens o' Yarrow.' The three works referred to have been engraved, and are deservedly popular. His last picture of importance, 'Luther at Erfurt,' was exhibited in London in 1862, and subsequently in Edinburgh. He has not confined himself to painting alone. In conjunction with his brother, he illustrated Professor Aytoun's *Lays of the Scottish Cavaliers*, published Christmas 1863; and for the London Art Union, 1864, he executed twenty illustrations of the *Ancient Mariner*.

P. has worked with the pen as well as with the brush and pencil. In 1861 appeared his volume of poetry, entitled *Poems by a Painter*, full of grace, melody, and eloquence.

**PATONCE, Cross, in Heraldry** (*Lat. patens*, expanding), a cross with its terminations expanding like early vegetation or an opening blossom.

**PA'TOS, LAGO DES.** See **SUL, RIO GRAND DO.**

**PATRAS** (ancient *Patrae*, Turk. *Baliabadra*), a fortified seaport, and the most important trading town in the west of Greece, in the government of Achaia and Elis, stands on the eastern shore of the gulf of the same name, 12 miles south-south-west of Lepanto. It is overlooked by the strong citadel—on the site of the ancient Acropolis—crowning a ridge, on the southern slopes of which the ancient city, as well as the modern one before the revolution, was built. The P. of to-day stands on a level space close to the sea. The plain of P. is exceedingly valuable for the currants grown, and which are the most important export of the town. Its harbour, though protected by a mole, is unsafe, and exposed to heavy seas. Earthquakes frequently occur, and most of the houses are on that account only of one story. Capotes, made of mixed wool and goat's hair, are manufactured; and besides currants, silk, cotton, wool, and hides are exported. P. is a thriving town, and has almost entirely recovered from the injury it sustained during the Greek revolution. Pop. about 20,000.

*Patrae* is the only one of the 'twelve cities' of Achaia which still exists as a town; but most of its relics have been swept away by earthquake and revolution.

**PATRIA POTESTAS** is the term used to express the power which the civil law gave to the Roman father over his children, and which has been the foundation of the greatly modified paternal authority recognised in modern systems of jurisprudence. The right of a parent to control his child not come to years of discretion is a part of natural law, but the more extensive *patria potestas* of the Romans was probably a relic of those early times in which families, or tribes considered as families, led a wandering pastoral life in dread of each other, under the guidance of a chief, whom it was necessary to invest with an almost unlimited authority.

By the Roman law, the *patria potestas* was acquired naturally, by the birth of a child in wedlock, or civilly, by legitimation or adoption. An unemancipated son or daughter, a grandchild by a son, or any other descendant by males, was viewed as a part of the parent's property. In early times a father had the power of life and death over his children: by the Laws of the Twelve Tables he could sell them as slaves, or could transfer them to another family by adoption. Under the republic, the despotic authority exercised by fathers over their offspring was practically limited to a considerable extent by the censors, and several emperors issued constitutions to restrain the cruelties often perpetrated by fathers towards their children. First the right of sale, and then that of life and death was taken away. Alexander Severus restricted the right of the father to moderate chastisement, and Constantine declared that the father who should kill his son was to be held guilty of murder. By the early Roman law, the son, being in his father's power, could not acquire property for himself; his acquisitions all belonged to his father; hence he was incapable of making a testament. There were, however, particularly in later times, modes by which he could acquire *peculium*, or property which should be independent of his father. A father might give



Patonce.

his son property to trade on, which would be his own; and latterly a son acquired for himself whatever he gained in military service, or by the discharge of certain civil functions. In all matters belonging to the *ius publicum* a son was independent of his father; he could vote at the elections, hold the most important offices of state, or command the army. He could also be a tutor, tutory being considered a *munus publicum*. In later times, a son promoted to the consular dignity ceased to be under the restraints of paternal control, but, unlike an emancipated son, he retained his rights of succession. Lawful children were entitled to aliment from their parents; an obligation attached in the first instance to the father and mother, and, failing them, to the grandfather. Until the time of Justinian, illegitimate children had only a claim for support against their mother; that emperor gave them a right to demand aliment from their father.

In no modern system has the paternal power been carried so far as under the Roman law. According to the French 'Code Civile,' a child is under the authority of his parents till majority or emancipation; up to that time he cannot quit the paternal residence without leave of his father, except for enrolment in the army at 18 years of age. Majority is attained at the age of 21, but a minor is emancipated by marriage. At 15, a minor may be emancipated by his father, or, if his father be dead, by his mother, by a simple declaration before a magistrate. The father possesses somewhat extensive powers of chastisement. He may obtain a warrant to arrest his child under 16, and detain him in prison for a month; and an order may be obtained for the incarceration for six months of a child above 16, on cause shewn to the satisfaction of the magistrate. Parents are entitled to the usufruct of their children's property till the age of 18 or emancipation, subject to the burdens of maintenance and education; but this right does not extend to property acquired by the industry of the children, or bequeathed by a stranger under the condition of an exclusion of parental interference.

By the law of England, a father is guardian to his lawful children in minority, though this right ceases to some extent at 14. He has the power of moderate chastisement. As guardian, he receives the rents of any real estate which the child may possess, which he must account for when majority is attained. The paternal power never extends beyond majority, and, to some effect, marriage acts as an emancipation. A father may by deed appoint a guardian to such of his children as are unmarried at his death till they attain majority.

In Scotland a father has a general control over the persons of his children during pupilarity; that is, till the age of 14 in the case of sons, and 12 in the case of daughters. He may fix their place of residence, direct their education, and inflict reasonable chastisement. The limits of the *patria potestas* as regards children who have attained puberty, but are under 21 years of age, are not very exactly defined; but it seems to be understood that in ordinary circumstances minors are not entitled to choose their own place of residence in defiance of paternal authority. The father is administrator-in-law, and tutor and curator of his children, unless in the case of an estate left by a stranger and placed under separate management. This guardianship ceases on majority, or on the marriage of a daughter.

PATRIARCH (Gr. *patriarches*, the head of a tribe) is the name given to the heads of the families in the antediluvian period of Scripture history, and is still more familiar as the designation in Jewish history of the three progenitors of the Jewish people, Abraham, Isaac, and Jacob. In the

later history of the Jews, too, after the destruction of Jerusalem, the name was used to designate the heads of the Sanhedrim, one of whom, the patriarch of the west, resided at Tiberias, in Galilee, and the other, the patriarch of the Eastern Jews, at Babylon. The most familiar use of the word, however, is in the history of the Christian church. It is the name given to the bishops of certain great Metropolitan (q. v.) Sees, who not only held rank beyond other metropolitans, but also enjoyed a jurisdiction almost identical with that of the metropolitan in his own province over all the metropolitans themselves (with their provinces) included in their district, which was called a PATRIARCHATE. The name patriarch originally seems to have been given commonly to bishops, or at least was certainly given in a less special sense than what it eventually assumed; nor can the date at which the title first assumed its now received use be exactly determined. It is certain, however, that the name and the office were both recognised before the Council of Nice, at which time, as we learn from the sixth canon, the patriarchal sees, acknowledged by 'ancient custom,' were three in number, Rome, Antioch, and Alexandria. After the translation of the seat of empire to Byzantium, thenceforward called Constantinople, that see, originally subject to the metropolitan of Heraclea, obtained, first metropolitan, and afterwards patriarchal rank; and eventually established a precedence over the patriarchs of Antioch and Alexandria, being second only to Rome. The contests between the patriarchs of Rome and Constantinople were among the chief causes of the GREEK SCHISM (q. v.). To these four patriarchates was added a fifth, in the year 451, that of Jerusalem, which was formed out of the ancient patriarchate of Antioch. The limits of these five patriarchates can only be loosely assigned. The authority of a patriarch was, in the main, that of a metropolitan, but extended over the metropolitans themselves. He had a right to consecrate the metropolitans, and to preside over the councils of his patriarchate. After the Greek Schism, and particularly after the establishment of the Latin Kingdom of Jerusalem, Latin prelates were appointed with the title and rank of patriarch in the four great Eastern sees. It was hoped that the union of the churches, effected at the Council of Florence, would have put an end to the contest thus created; but that union proved transitory; and the double series of patriarchs has been continued to the present day. The Nestorian and Eutychnian sections of the Eastern Churches, too, have each their own patriarch, and the head of that portion of the former, which in the 16th c. was reconciled with the Roman see, although known by the title of *Catholicos*, has the rank and authority of patriarch. After the separation of the Russian Church from that of Constantinople, the name and authority of the metropolitan in the end was transformed into that of patriarch. But the office was suppressed by Peter the Great.

Besides these, which are called the Greater Patriarchates, there have been others in the Western Church known by the name of Minor Patriarchates. Of these the most ancient were those of Aquileia and Grado. The latter was transferred to Venice in 1451; the former was suppressed by Benedict XIV. France also had a patriarch of Bourges; Spain, for her colonial missions, a patriarch of the Indies; and Portugal a patriarch of Lisbon. These titles, however, are little more than honorary.

In the non-unioned Greek Church, the ancient system of the three patriarchates of Constantinople, Antioch, and Jerusalem is nominally maintained, and the authority of the patriarchs is recognised by their own communion. But the jurisdiction-limits

## PATRIARCHAL CROSS—PATRICK, ST, ORDER OF.

of the patriarch of Constantinople, who is acknowledged as the head, have been much modified. The Russo-Greek Church withdrew from him partially in the 17th, and finally in the 18th century. That of Greece proper has been practically separated since the independence of the kingdom of Greece; and some years since it formally declared its independence. The patriarchs of Jerusalem and Antioch have few followers of their own rite.

**PATRIARCHAL CROSS**, a cross which, like the patriarchal cross, has its upright part crossed by two horizontal bars, the upper shorter than the lower. A cross patriarchal fimbriated or was a badge of the Knights Templars.



**PATRICIAN** (Lat. *patricius*, from Patriarchal *pater*, father), a name given to the members of Roman *gentes*, of whom the *populus Romanus* consisted, and to their descendants by blood and adoption. *Patres* and *patricii* were in the early days of Rome synonymous, they were so named from the *patrocinium* which they exercised over the whole state, and all classes of whom it was composed. Niebuhr's researches have established that, until the *plebs* became a distinct order, the patricians were the entire citizens or *populus* of Rome; a select number of them were senators; and the original inhabitants, reduced to a condition of servitude, were known by the name of *clientes* or *plebs*. The amalgamation of the three tribes of Ramnes, Tities, and Luceres, gave rise to a distinction between *patres majorum gentium* and *patres minorum gentium*—the latter term being applied to families recently elevated to an equality with the old patrician class. On the establishment of the plebeians as a distinct order, sharing certain rights with the patricians, the patriciate became an aristocracy of birth, in the exclusive possession of a number of important privileges. A long struggle between the two orders ended in the attainment by the plebeians of a political equality, and the establishment of a new aristocracy of *nobles* based on wealth and office. Under Constantine, the dignity of *patricius* became a personal title; not hereditary, but conferring very high honour and certain privileges. It was created at Constantinople, and not confined to Romans or subjects of the empire, but sometimes bestowed on foreign princes. These patricians, unlike the old Roman order, were distinguished in dress and equipage from the ordinary citizens. The popes in after times conferred the same title on eminent persons and princes, including many of the German emperors. In several of the Germanic kingdoms the title of patrician was bestowed on distinguished subjects; and in some parts of Italy the hereditary nobility are still styled patricians.

**PATRICK, Sr.**, a distinguished missionary of the 5th c., commonly known as the Apostle of Ireland. There is some uncertainty as to the date and place of his birth. The year of his birth is variously assigned to the years 377 and 387, of which the latter, if not even a later date is more probable. Of the place, it is only known for certain, from his own confession, that his father had a small farm near Bonavem Tabernias; and in one of the ancient lives he is said to have been born at Nemthur. Arguing on these data, connected with other collateral indications, some writers assign his birthplace to the present Boulogne-sur-Mer; others to a place in the estuary of the Clyde (called from him Kilpatrick) or at near the modern Dumbarton. His father, he himself tells, was a deacon named Calpurnius; his mother, according to the ancient biographers, was named Conches or Conchessa,

according to some of these authorities, a sister of St Martin of Tours. P.'s original name is said to have been Sucoath, Patricius being the Roman appellation by which he was known. In his 16th year he was seized, while at his father's farm of Bonavem Tabernias, by a band of pirates, and with a number of others was carried to Ireland, and sold to a petty chief, in whose service he remained for six years; after which he succeeded in effecting his escape, and, probably after a second captivity, went to France, where he became a monk, first at Tours, and afterwards in the celebrated monastery of Lerina. In the year 431 he went to Rome, whence he was sent by the pope of the day, Celestine, to preach in Ireland; Palladius, who had been sent as missionary to that country a short time before, having died. Such is the received account of his mission; but Dr Todd, his latest biographer, regards this statement as erroneous, and fixes the date of his coming to Ireland eight years later. He was ordained in France, and arrived in Ireland in 432. His mission was eminently successful. He adopted the expedient of addressing himself first to the chiefs, and of improving, as far as possible, the spirit of clanship, and other existing usages of the Irish for the furtherance of his preaching; nor can it be doubted that he had much success in Christianising the ancient Irish system of belief and of practice. By degrees he visited a large portion of the kingdom, and baptised great numbers as well of the chieftains as of the people. According to the accounts of his Irish biographers, he founded 365 churches, and baptised with his own hand 12,000 persons. He is said also to have ordained a vast number of priests, and to have blessed very many monks and nuns. After he had been about 20 years engaged in his missionary enterprise, he is said to have fixed his see at Armagh about the year 454; and having procured two of his disciples to be ordained bishops, he held probably more than one synod, the decrees of which have been a subject of much controversy. He died at a place called Saul, near Downpatrick; and his relics were preserved at Downpatrick down to the period of the Reformation. The place is still venerated by the people. The date of his death is much disputed; the Bollandists placing it in 460, while Usaher holds it to have been 493. Dr Todd inclines strongly to the latter opinion, in which case P.'s age would have been 126, or at least 116. The only certainly authentic literary remains of St P. are his 'Confession' and a letter, both of very rude Latinity, but of much historical interest. The letter is addressed to Coroticus, who is supposed to have been a Welsh chieftain named Caradoc (from whom Cardigan is named), who had made a descent on the Irish coast, and slain or carried off, with circumstances of great cruelty, a number of the Irish, many of whom were neophytes. These, with some other remains ascribed to him, as also decrees of synods, were published in Wilkins's *Concilia*, and separately by Ware, *Opuscula S. Patricii Adscripta* (1656) and by Villanueva (Dublin, 1835). The latest biography of St P. is that of the Rev. J. H. Todd, 1 vol. 8vo. (Dublin, 1863).

**PATRICK, ST, ORDER OF**, a national order of knighthood for Ireland, established by George III. on the 5th of February 1783, and enlarged in 1833. As originally constituted, it consisted of the Sovereign, the Grand-master (who was always the lord-lieutenant of Ireland for the time being), and 15 Knights. By the statutes of 1833 the number of Knights was increased to 22.

The *Collar* of the order (of gold) is composed of roses alternating with harps, tied together with a

knot of gold, the roses being enamelled alternately white within red, and red within white, and in the centre is an imperial crown surmounting a harp of gold, from which the badge is suspended. The *Badge or Jewel* is of gold, and oval; surrounding it is a wreath of shamrock proper on a gold field; within this is a band of sky-blue enamel charged with the motto of the order, *QUIS SEPARABIT MDCCCLXXXIII.* in gold letters; and within this band a saltire gules (the cross of St Patrick), surmounted by a shamrock or trefoil slipped vert, having on each of its leaves an imperial crown or. The field of the cross is either argent, or pierced and left open.



Order of St Patrick.

A sky-blue *Ribbon*, worn over the right shoulder, sustains the badge when the collar is not worn. The *STAR*, worn on the left side, differs from the badge only in being circular in place of oval, and in substituting for the exterior wreath of shamrocks eight rays of silver, four of which are larger than the other four. The *MANTLE* is of rich sky-blue tawny, lined with white silk, and fastened by a cord of blue silk and gold with tassels. On the right shoulder is the *HOOD*, of the same materials as the mantle.

The order is indicated by the initials K. P.

**PATRIPASSIANS** (Lat. *pater*, father, and *passus*, suffered), the name of one of the earliest classes of anti-Trinitarian sectaries, who, in maintaining the oneness of the Godhead, held that all that is ascribed in the Scriptures, according to the Trinitarian exposition, to any of the Three Persons, is in reality true of the one Principle, whom alone these sectaries admitted, being in consequence called 'Monarchians' (Gr. *monos*, one, and *arché*, principle). The leader of this sect was Praxeas, a native of Phrygia, who lived in the end of the 2d century. The name P., for which the Greek equivalent was *Patropaschite*, was in some sense a sobriquet, being founded on what their antagonists regarded as the absurd consequence derivable from their doctrine—viz., that as it was true to say that Jesus, in whom dwelt the Logos, or the Son, suffered, therefore it

would be true on their principles to say that Father suffered. The sect in this particular was chiefly known in Rome; but their principles in the main the same with those of the Sabellians. In Rome, Praxeas was succeeded by Noetus, but party does not appear to have been numerous influential.

**PATRO'CLUS.** See **ACHILLES.**

**PATRO'L** is a detachment of five or six soldiers fully armed, sent out, under a sergeant, from a main guard or picket to traverse the streets of a garrison town, &c., and arrest disorderly persons or soldiers out of barrack without proper pass. Prisoners are taken to the guard-house, and brought before the town-major. In a besieged fortress *patrols* are strong bodies of men employed to man the lines of defence, and watch against assaults on the part of the enemy.

**PATRON** (Lat. *patronus*, from *pater*, father, among the Romans originally signified a citizen who had dependents, who were called *clientes*, attached to him. Before the time of the Laws of the Twelve Tables, the most frequent use of the term *patronus* was in opposition to *libertus*, these two words being used to signify persons who stood to one another in the relation of master and manumitted slave. A Roman was not denuded of all right in his slave when he freed him; a tie remained somewhat that of parent and child, and the law recognized important obligations on the part of the *libertus* towards his patron, the neglect of which involved severe punishment. In some cases the patron could claim a right to the whole or part of the property of his freed man. The original idea of a patron apart from the manumitter of slaves continued to exist. A Roman citizen, desirous of a protection might attach himself to a patron, whose client he thenceforward became; and distinguished Roman were sometimes patrons of dependent states or cities, particularly where they had been the means of bringing them into subjection. Thus the Lucullians were patrons of the Sicilians, because Claudius Marcellus had conquered Syracuse and Sicily. A Roman patron was the guardian of his client's interests in public and private; as his legal adviser, he vindicated his rights before the courts of law. A client was bound, on various occasions, to assist the patron with money, as by paying the costs of his suits, contributing to the marriage portions of his daughters, and defraying in part the expenses incurred in the discharge of public functions. Patron and client were under an obligation never to accuse one another; to violate this law amounted to the crime of treason, and any one was at liberty to slay the offender with impunity. One obvious result of the institution of *clientela* was the introduction of an element of union between classes of citizens who were otherwise continually brought into opposition to each other. As the patron was in the habit of appearing in support of his clients in court, and for justice, the word *patronus* acquired, in course of time, the signification of advocate or legal adviser, and defender, the client being the party defended; hence the modern relation between counsel and client.—*Patron*, in after times, became a common designation of every protector or powerful promoter of the interests of another; and the saint who were believed to watch over the interests of particular persons, places, trades, &c., acquired in the middle ages the designation of their patron saints. The saint in whose name a church was founded is considered its patron saint. The term *Patron* has also been applied to who endowed or supported churches and convents. See **PATRONAGE, ECCLESIASTICAL.**

## PATRONAGE.

**PATRONAGE, ECCLESIASTICAL**, the right of presenting a fit person to a vacant ecclesiastical benefice. The patron, in the original and more strict sense, was the person who founded or endowed the church. In the early ages of Christianity, the countries where the new religion had been adopted were parcelled out into large districts or dioceses, under the superintendence of a bishop, who usually resided in the neighbourhood of one of the religious houses. Within such district the bishop had the nomination of the priests, who supplied religious instruction to the people. The priests were paid out of the episcopal treasury, and travelled about in the exercise of their duties, having their residence with the bishop, and forming that *episcopi clerus* which constituted the notion of cathedral churches and monasteries in their simplest form. Occasionally a bishop endowed a church in his diocese, and attached a priest permanently to it; and in Gaul, in the 5th c., a bishop who founded a church in a neighbouring diocese was allowed to appoint an incumbent of his choice. As Christianity became more universal, and the population increased, the means of worship supplied by the bishoprics, the monasteries, and occasional episcopally endowed churches, became inadequate for the demands of the people, and the proprietors of lands began to build and endow churches in their own possessions. In such cases the chaplain or priest was not paid by the bishop, but allowed to receive for his maintenance, and for the use of his church, the whole or a part of the profits of the lands with which the founder had endowed it, and the offerings of those who frequented the church for worship. A district was defined by the founder, within which the functions of the officiating priest were to be exercised; and both the burden and the advantages of his ministry were limited to the inhabitants of that district. As these pious foundations tended both to the advancement of religion and to the relief of the episcopal treasury, they were encouraged by the bishops, who readily consecrated the churches thus established, and consented that the incumbent should be resident at the church, and receive the tithes and offerings of the inhabitants and what endowment the founder had annexed to the church. Eventually, it came also to be stipulated with the bishop that the founder and his heirs should have a share in the administration of the property, and have the right to nominate a person in holy orders to be the officiating minister whenever a vacancy occurred. It also became a not unusual arrangement that when owners of estates rebuilt such churches as were dependent on the cathedral, or undertook to pay the incumbent, to the relief of the cathedral, the right of presentation was transferred from the bishop to these persons, who thenceforward stood in the same relation to these churches as if they had been the original founders. Out of these private endowments arose the parochial divisions of a later time, which thus owe their origin rather to accidental and private dotation than to any legislative scheme for the ecclesiastical subdivision of the country. The bounds of a parish were at first generally commensurate with those of a manor, and the lord of the manor was the hereditary patron. The person enjoying the privileges of a founder was called *patronus* and *advocatus*. He had a pre-eminent seat and a burial-place in the church; he enjoyed a precedence among the clergy in processions; his name and arms were engraved on the church and on the church-bells, and he was specially named in the public prayers. He had the right to a certain portion of the church funds, called *patronagium*, and enjoyed the fruits of the benefice during a vacancy. In the course of time it sometimes happened that,

with the concurrence of all parties interested, the patronage, and the church with its revenues and appurtenances, were made over to a religious house, which thus became both patron and perpetual incumbent of the parish, while the immediate duties of the cure were devolved on a vicar or stipendiary curate. In France, the right of patronage was often extended to churches not originally private foundations by the necessities of the sovereigns, which led them to take possession of church property, and bestow it in fee on laymen, who appropriated the greater part of the revenues, and took the appointment of the clergy into their own hands. For a length of time, not merely the nomination but the investiture of the clergy came to be exercised by lay patrons, a state of matters which roused the indignation of successive popes and councils: until it was at last ruled by the third and fourth Lateran Councils (1179 and 1215 A.D.) that the presentation of the patron should not of itself suffice to confer any ecclesiastical benefice, even when qualified by the discretionary power of rejection given to the bishop, when the presentee was a layman. It was declared necessary that the presentee should not merely have the temporalities of the benefice conferred on him by induction, but also be invested with the spiritualities by institution. When the bishop was patron of the benefice, the ceremonies of induction and institution were united in that of collation. With the growth of the papal power, however, a practice arose by which the right of presentation or induction, which had nominally been left to the patrons, became in some degree nugatory. Towards the close of the 12th c., letters of request, called mandates or expectatives, began to be issued by the popes to patrons, praying that benefices should be bestowed on particular persons. What had at first been requested as a favour was soon demanded as a right, and a code of rules was laid down with regard to grants and revocations of expectatives. In the 13th c. the patronage of all livings whose incumbents had died at the court of Rome (*vacantia in curia*) was claimed by the pope; and as ecclesiastics of all ranks from every part of Europe frequently visited Rome, the number of benefices *vacantia in curia* was always very great. Clement V. went so far as broadly to declare that the pope possessed the full and free disposal of all ecclesiastical benefices. The practice next arose of the pope making reversionary grants, called provisions of benefices, during the lifetime of the incumbent, and reserving what benefices he thought fit for his private patronage. By means of permissions to hold benefices *in commendam*, and dispensations for non-residence and holding of pluralities, upwards of fifty benefices were often held by one person; and throughout all Europe the principal benefices were filled by Italian priests, nominees of the popes, who were often ignorant of the very language of the people among whom they ministered. In the 14th c. these claims encountered much opposition. England took the lead in an organised resistance, which was in the end successful. A series of English statutes was passed, beginning with the Statute of Provisors, 25 Edw. III. c. 6, solemnly vindicating the rights of ecclesiastical patronage, and subjecting to severe penalties (see **PREMUNIRE**) all persons who should attempt to enforce the authority of papal provisions in England. The principles adopted by the third and fourth Lateran Councils have since been substantially the law of patronage in Roman Catholic countries. A lay patron is, by the canon law, bound to exercise his right of presentation within four, and an ecclesiastical patron within six months, failing which the right to present accrues *jure devoluto* to the

bishop of the diocese. Patronage has always been more or less subject to alienation, transmission, and the changes incident to other kinds of property. The modern practice of patronage in the Roman Catholic church is detailed under the head **PROVISION** (q. v.).

In England, where the modified canon law, which was in use before the Reformation, is still in force, the rights of patrons do not materially differ from those which they possess in Roman Catholic countries. For some details regarding the right of presentation in England, see **ADWOWSON**.

In Scotland, at the Reformation, the rights of patrons were reserved, and presbyteries were bound by several statutes to admit any qualified person presented by the patron. The principle of these statutes was retained in the enactments introducing Episcopacy. On the establishment of Presbytery under favour of the civil war, patronage was abolished by act 1649, c. 23, and the election of the clergy was committed to the kirk-session. At the Restoration, this statute fell under the act rescissory, and patronage was replaced on its former footing. On the reintroduction of Presbytery at the Revolution, patronage was again cancelled, and the right to present conferred on the Protestant heritors and the elders of the parish, subject to the approval or rejection of the whole congregation. In consideration of being deprived of the right of presentation, patrons were to receive from the parish a compensation of 600 merks (£33, 6s. sterling), on payment of which they were to execute a formal renunciation of their rights. Only three parishes effected this arrangement with the patron, and patronage was permanently restored in all the parishes where no renunciation had been granted by 10 Anne, c. 12. This act, with modifications introduced by 6 and 7 Vict. c. 61, is now law. Should a patron fail to present for six months after the occurrence of a vacancy, the right to present falls to the presbytery *jure devoluto*. The presentee, before he acquires a right to the emoluments of the benefice, must be admitted to it by the presbytery of the bounds. He is first appointed to preach certain trial sermons, after which a day is fixed within six weeks for moderating in his call. On that day the people are invited to sign a written call to the presentee to be their minister, and however few the signatures to the call may be, the presbytery are in use to pronounce a formal judgment sustaining it. They then proceed to examine into the qualifications of the presentee, and provided the result be satisfactory, the ordination follows (if he have not been previously ordained), and he is formally admitted minister of the parish by the presiding minister. Soon after the above-mentioned act of Queen Anne, a feeling which had sprung up in favour of popular election, in opposition to patronage, led to various acts of resistance to the settlement of presentees, and brought about two considerable secessions from the Church of Scotland. It continued for a length of time to be a subject of dispute how far the right of the church to judge of the fitness of presentees could entitle her to make rules tending to disqualify them, and in particular whether she could legally make the dissatisfaction of the congregation a disqualification. For a long time prior to 1834, there had been no attempt to give effect to any dissent on the part of the congregation. In that year the law of patronage again became a ground of contention, when a majority of the General Assembly embodied their views on the subject in the so-called Veto Act, which declared that no minister was to be imposed on a congregation when a majority of heads of families and communicants should dissent from

his admission. The decision of the Court of Session, confirmed by the House of Lords, finding this act to be *ultra vires* of the General Assembly, led to the secession of 1843 and formation of the *Free Church* (q. v.). After that event, an act, 6 and 7 Vict. c. 71, commonly called Lord Aberdeen's Act, was passed to fix by a legislative provision the effect which the church courts were in future to be entitled to give to the dissent of the congregation in the collation of ministers. It is there enacted, that after the trial sermons, the presbytery shall give to the parishioners, being members of the congregation, an opportunity to state objections which do not infer matter of charge to be proceeded against according to the discipline of the church. The presbytery are either to dispose of the objections, or to refer them to the superior church judicatory; and if the objections be considered well founded, the presbytery may reject the presentee. No power is, however, given to reject him on the ground of mere dislike as such on the part of any portion of the congregation. In Scotland, patronage is in all cases a heritable right; it is transferable by disposition without infestment, but capable of being feudalised, after which it can be completely conveyed only by infestment.

In the Protestant churches of Germany, Sweden, and Denmark, patronage exists to some extent, subject to restrictions, which differ much in different localities. The right to present is sometimes divided between the patron and the consistory. The parishioners have in many instances a voice: the appointment may be entirely in their hands, or they may have merely a right to reject the presentee after he has been subjected to the ordeal of a trial sermon; and in either case this right may be exercised, according to local usage, either by the parishioners at large, by a committee of their number, or by the *bürgermeister*. When there is no patron, the choice generally rests with the consistory in East, and with the parishioners in West Germany. Induction by the superintendent completes the right of the presentee.

In the Greek Church the right to present is generally in the hands of the bishops, excepting in Russia, where lay patronage exists to a limited extent.

**PATRONYMIC** (Gr. *pater*, father, and *onoma*, name), properly a name taken from one's father, but generally applied to such names as express descent from a parent or ancestor. In Sanskrit, Greek, and Latin, patronymics are very numerous. They may be derived from the name of a father, mother, grandfather, or remoter ancestor, as Atrides, i. e., (Agamemnon), son of Atreus; Philyrides, i. e., (Chiron), son of Philyra; Æacides, i. e., (Achilles), grandson of Æacus. The names of the founders of nations have also been used to form a sort of patronymic, as when the Romans are called Romulida. In Greek and Latin the commonest terminations of patronymics are *ides* and *ia*. Patronymics have no fewer than thirteen recognised terminations in Sanskrit. A number of the surnames in use in modern times are patronymics, as Johnson, the son of John; Thomson, the son of Thomas. Originally these names fluctuated from generation to generation, as still is, or very recently was, the case in Shetland, where Magnus Johnson's son calls himself John Magnusson or Manson. In the course of time, it was generally found more convenient to take a surname from one well-known ancestor, which should descend unchanged to the children of the bearer of it. The termination *s* is sometimes used as equivalent to son, as in Jones, Rodgers. To patronymics belong Norman, Highland, Irish, and Welsh surnames with the prefixes *Fitz*, *Mac*, *O*, and *Ap*, respectively. In many cases the *Mac* of

the Highlands of Scotland ceased to have a fluctuating character only a few generations ago. In 1465, an act of the parliament of Ireland was directed against the use of patronymics. Every Irishman dwelling betwixt or among Englishmen in the counties of Dublin, Myeth, Uriel, or Kildare, was ordered 'to take to him an English surname of a town, as Sutton, Chester, Trym, Skryne, Corke, Kinsale; or colour, as White, Blacke; or arte or science, as Smith or Carpenter; or office, as Cooke or Butler; and that he and his issue should use the same.' In Wales it was long the practice to use a string of ancestral names, each with the syllable *Ap* prefixed to it. Camden relates that 'in the time of King Henry VIII an ancient worshipful gentleman of Wales being called at the pannell of a jury by the name of Thomas Ap William Ap Thomas Ap Richard Ap Hoel Ap Evan Vaghan, &c., was advised by the judge to leave that old manner; whereupon he afterwards called himself Moston, according to the name of his principal house, and left that surname to his posteritie.' See NAME.

**PATTEE**, Cross, in Heraldry (Lat. *patulus*, spreading), also called Cross Formée, a cross with its arms expanding towards the ends, and flat at their outer edges.

**PATUXENT**, a river of Maryland, U.S., rises 20 miles east of Frederick City, and after a south-easterly course of 90 miles, empties by a broad estuary into Chesapeake Bay; navigable for small vessels for 50 miles.

**PAU**, a flourishing town of France, capital of the department of Basses-Pyrénées, on the right bank of the Gave-de-Pau, 105 miles south-south-east of Bordeaux. It occupies a rocky height, cloven into two portions by a ravine through which a streamlet flows into the Gave-de-Pau, and united by a high bridge. Toward the south it commands most magnificent views of the Western Pyrénées; indeed, for mountain views its situation is hardly surpassed by that of any town in France. As seen from this town, the distant Pyrénées rise in peaks, cones, and serrated ridges, and present an outline as varied as it is strikingly beautiful. The town contains a palace of justice, a promenade, Royal Square, with a bronze statue of Henri IV., beautiful theatre, university-academy, museum, and library of 25,000 vols. Linen and cloth manufactures are the chief branches of industry; in the vicinity, Jurançon wine (good but strong) is grown. Many swine are fed in the vicinity, and from the pork the famous *Jambons de Bayonne* are made. Pau is a favourite resort of the English, especially during winter, and is a general rendezvous for those who wish to explore the Pyrénées. Pop. 17,865.

The principal building, however, of Pau, and that to which it owes its existence, is the old castle which stands on the ridge overlooking the river, and forms both the most conspicuous and most interesting feature of the town. It has five towers, united by an outer wall, and is supposed to have been founded by Gaston de Foix about the year 1363. Pau was the capital of the kingdom of Béarn, and its castle was the birthplace of the famous Henri IV.

**PAUL**, the great apostle of the Gentiles, was born of Jewish parents at Tarsus, in Cilicia, and inherited from them the rights of Roman citizenship. His original name was Saul. He was educated first in his native city, then in the zenith of its reputation for its schools of literature and philosophy, where he doubtless learned to speak and write Greek; and afterwards, to be perfected 'in the law of his fathers,' was sent to Jerusalem, where he

studied under Gamaliel, a great Jewish doctor, and became one of the strictest, most zealous, and most ardent Pharisees. Whether it was here or at Tarsus that he acquired his knowledge—which we have no reason to believe was ever very deep—of the philosophy and literature of Greece, cannot be ascertained. According to the wholesome rule observed among the Jews, that every person should learn some trade, Saul became a tent-maker, and at this trade he afterwards laboured (Acts xviii. 3) for his support. A few years after the death of Jesus, he became, as might have been expected from his training and temperament, a furious adversary of the new sect of Christians. We are told (Acts vi. 9) that the Jews of the Cilician synagogue at Jerusalem were among those who disputed with Stephen, and it is natural to suppose that the young and brilliant zealot, eager for disputation, was conspicuous among the crowd of Jewish students who poured out of their synagogues (of which, according to the Talmud, there were 480 in the holy city), in the insolence of their youth and scholarship, to crush the ignorant followers of the Nazarene. This supposition is rendered highly probable by the fact, that he was present at the martyrdom of Stephen, which followed almost immediately, having charge of the raiment of them that slew him. He now became a prominent actor in the great persecution of the Christians that broke out at Jerusalem. The mysterious circumstances that led to and attended his conversion are familiar to all readers of the Acts of the Apostles, and need not be recapitulated here. After a solitary sojourn in Arabia—perhaps to calm his perturbed spirit in communion with God, and to solemnly prepare himself for his new mode of life—on his return to Damascus, he changed his name to Paul, and resumed or began (it is not quite clear which) his apostolic labours. Naturally, he became an object of intense hostility to the unbelieving Jews in that city. They resolved to kill him; but his friends contrived a way of escape, and he fled to Jerusalem, where at first he was received with suspicion by the disciples, but afterwards, through the kind offices of Barnabas, with great cordiality. He now 'spoke boldly in the name of Christ,' disputing also against the 'Grecians'—i. e., the Hellenistic Jews—with dangerous success, for his opponents sought to take his life. Again he was obliged to flee, and betook himself to his birthplace, Tarsus, where he seems to have remained till Barnabas brought him to Antioch (not far off), to assist in the great work of evangelisation going on in that city. After a short visit to Jerusalem in the year of the famine, 44 A.D., they were set apart by the prophets and elders of the church at Antioch for the evangelisation of the more distant Jews. From Seleucia they proceeded on their first missionary expedition to the southern districts of Asia Minor, Pamphylia, Pisidia, and Lycaonia, where they met, especially in some places, with considerable success, in preaching the gospel. It is very interesting to notice how gradually the light of Christianity dawned on the mind of the apostle. He did not grasp all at once its grand design. It was not even by abstract reflection that he arrived at it. Circumstances of quite an outward sort forced him to the sublime conclusions of his creed. It was when the Jews of Pisidian Antioch, enraged at his preaching the gospel indiscriminately to their Gentile fellow-townsmen and themselves, 'contradicted and blasphemed' him, that he boldly announced Christ as the universal Redeemer. After the return of P. and Barnabas to Antioch, they continued to labour in that city for a long time, till dissensions having arisen about the circumcision of



Gentile converts, he, along with Barnabas and others, was chosen to go up to Jerusalem, to get the opinion of the apostles and elders there on the question, about 51 A. D. P. and Barnabas now returned to Antioch, where they continued to teach and preach, till a yearning grew up in the heart of the former to revisit his Gentile converts in Asia Minor. In his second expedition, P. was accompanied by Silas instead of Barnabas, and traversed the whole of Asia Minor from south to north, evangelising with great success, after which the two missionaries crossed the Ægean and landed in Europe, planting at Philippi, the capital of Thracian Macedonia, the first Christian church in that continent. The details of his visits to Thessalonica, Berea, Athens, and Corinth are, doubtless, familiar to our readers, and need not be given here. We can only notice his appearance at Athens, where, on Mars' Hill, before a crowd of the citizens, among whom were Epicurean and Stoic philosophers, he delivered that magnificent discourse in which he declared to the Athenians the character of the 'unknown' God. On his return to Asia Minor he visited Ephesus, where, as usual, he 'reasoned' with the Jews in their synagogue; sailed thence to Cæsarea, in Palestine, and proceeded to Jerusalem 'to keep the feast;' after which he again returned to Antioch, the centre from which his operations radiated. Thus closed his second evangelistic journey.—The third journey of P. commenced probably about 54 A. D., and extended over much the same district as the previous one. At Ephesus, where he remained for a period of two years and three months, his efforts were powerfully seconded by the eloquence of the great Alexandrian convert, Apollos. Here it is recorded (Acts, xix.) that 'God wrought special miracles by the hand of Paul, so that from his body were brought unto the sick handkerchiefs or aprons, and the diseases departed from them, and the evil spirits went out of them.' In explanation of this very curious procedure, which has a disagreeable resemblance to ordinary legerdemain, it has been suggested, that as Ephesus was a city noted for its exorcisms, spells, and incantations—the famous *Ephesia Grammata* sold at a high price to the ignorant and superstitious populace—this style of miracle was an accommodation to their belief in magic and demonism, and intended to shew them, according to their own way of regarding things, the superiority of Christ's power to that of the evil spirits of heathen worship. From Ephesus, P. went up to Jerusalem with a presentiment that heavy evils were about to fall upon him through the ever-maddening malice of the Jews. The Jewish populace were goaded into the wildest fury by the very sight of Paul. The captain of the Roman guard, Claudius Lysias, had to interfere to save him from being torn to pieces; but as forty Pharisees had sworn neither to eat nor drink till they had taken his life, he was sent by night, under a strong escort, to the Roman governor, Felix, at Cæsarea, where he was unjustly detained a prisoner for two years. Having finally appealed to the Roman emperor, according to the privilege of a Roman citizen, he was sent to Rome. On the voyage thither, he suffered shipwreck at Melita (probably Malta), in the spring of 61 A. D. At Rome, he was treated with respect, being allowed to dwell 'for two whole years in his own hired house.' His first thoughts were, as usual, directed towards his Jewish brethren in the city; but, on the whole, he made little impression on them. Whether he ever left the city or not, cannot be positively demonstrated, but it is believed by many critics, from a variety of considerations, that he did obtain his liberty about 64 A. D., and that he made journeys both to the east

and to the west, revisiting Asia Minor, and carrying out his long-cherished wish of preaching the gospel in Spain, then thought to be the western limit of the world. Meanwhile occurred the great and mysterious burning of Rome, generally attributed to Nero. The latter threw the blame on the Christians, who were, in consequence, subjected to a severe persecution. Among the victims was P. who, according to tradition, suffered 67 A. D.—For an account of P.'s correspondence with the churches see the articles on the different Epistles.

PAUL, the name of five popes, of whom the following appear to call for special notice.—PAUL III., whose pontificate falls upon one of the most critical periods in the history of the church, was originally named Alessandro Farnese, and was born at Carino, in Tuscany, in 1468. Having been created cardinal, he served in several important trusts, and eventually became Bishop of Ostia and Dean of the Sacred College. On the death of Clement VII., in 1534, he was elected pope, just at the crisis when the world was alive with expectation of the general council which was to decide all the controversies at that time agitating the public mind of Europe. After some delays, P. convoked the council to meet at Mantua in 1542; but it did not actually assemble (in Trent) until 1545. These delays are by some charged upon P.; but it can hardly be doubted that much of it was due to the difficulties of the times. The bull of excommunication and deposition which he issued in 1538 against Henry VIII. of England is one of the last examples of the exercise of the temporal power claimed by the mediæval popes. In the contest of Charles V. with the Protestant League in Germany, P. sent a large force to support him, and he opposed the pacification proposed by the emperor upon the basis of the INTERIM (q. v.). P.'s conduct in aggrandising the fortune of his son Pietro Luigi Farnese, has been severely criticised by historians; the more so, that this son was born out of wedlock, in the early youth of his father. P. died November 10, 1549, in his 82d year.—PAUL IV. named John Peter Caraffa, a member of the noble family of that name, was born in Naples in 1476. His early career was distinguished for ascetic rigour. He was appointed Bishop of Chieti, in which see he laboured most earnestly for the reformation of abuses, and for the revival of religion and morality. With this view, he established, in conjunction with several congenial reformers, the congregation of secular clergy called THEATINES (q. v.), and was himself the first superior. It was under his influence that Paul III. organised the tribunal of the Inquisition in Rome. On the death of Marcellus II. in 1555, although in his seventy-ninth year, he was elected to succeed. He entered upon the wide career of reformation which his new position opened for him with all the ardour of a young man, and with all the stern enthusiasm which had characterised him during life. He enforced vigorously upon the clergy the observance of all the clerical duties, and enacted laws for the maintenance of public morality. He established a censorship, and completed the organisation of the Roman Inquisition; he took measures for the alleviation of the burdens of the poorer classes, and for the better administration of justice, not sparing even his own nephews, whom he banished from Rome, on account of their corrupt conduct and profligate life. His foreign relations, too, involved him in much labour and perplexity. He was embroiled with the Emperor Ferdinand, with Philip II. of Spain, with Cosmo, Grand Duke of Tuscany. Having condemned the principles of the Peace of Augsburg, he protested against its provisions. Under the weight of so many cares, his great age gave way

## PAUL.

He died August 18, 1559, in his 84th year. At his death, the populace broke out into an insurrectionary tumult, which lasted till the conclave for the appointment of his successor.—PAUL V., originally named Camillo Borghese, was born in Rome in 1552. In his early life, he was a distinguished canonist and theologian; and after the ordinary prelatical career at Rome, he rose first to the post of nuncio at the Spanish court, and afterwards to the cardinalate under Clement VIII. On the death of Leo XI. in 1605, Cardinal Borghese was elected to succeed him. His pontificate is rendered memorable by the celebrated conflict with the republic of Venice, into which he was plunged at the very outset of his career. The original ground of dispute was the question of the immunity from the jurisdiction of civil tribunals conceded to the clergy, who claimed to be tried by ecclesiastical tribunals alone. This claim the senate resisted; and further causes of dispute were added by a mortmain law, and a law prohibiting the establishment of new religious orders or associations unless with the sanction of the senate. Each party remaining inflexible in its determination, P. issued a brief, directing a sentence of excommunication against the doge and senate, and placing the republic under an interdict, unless submission should be made within twenty-four days. The senate persisted, and an animated conflict, as well of acts as of writings ensued, in the latter of which the celebrated Fra Paolo Sarpi, on the side of the republic, and on the papal side, Bellarmino and Baronius, were the leaders. Preparations were even made for actual hostilities; but, by the intervention of Henry IV. of France, the dispute was accommodated, and peace restored in 1607, although dissatisfaction afterwards arose on the subject of the nomination of a patriarch. A misunderstanding of a similar nature arose between the pope and the crown in France as to the rights of censorship on books, and as to the receiving of the disciplinary decrees of the Council of Trent; but it was removed by mutual explanations. His administration was vigorous and enlightened, and he did a great deal for the promotion of useful public works, for the embellishment of the city, the restoration and preservation of antiquities, the improvement of the museums and libraries, and, above all, for the pious and charitable institutions of Rome. P. died in his 69th year, January 28, 1621.

PAUL, VINCENT DE, one of the most eminent saints of the modern Catholic Church, was born of humble parentage at Ranquines, in the diocese of Dax, in the year 1576. The indications of ability which he exhibited led to his being sent to school at Toulouse. He became an ecclesiastical student, and was admitted to priest's orders in 1600. On a voyage which he was making from Marseille to Narbonne, his ship was captured by corsairs, and he with his companions sold into slavery at Tunis, where he passed through the hands of three different masters. The last of these, who was a renegade Savoyard, yielded to the exhortations of Vincent, resolved to return to the Christian faith, and with Vincent, made his escape from Barbary. They landed in France in 1607. Having gone thence to Rome, he was intrusted with an important mission to the French court in 1608, and continued for some time to reside in Paris as the almoner of Marguerite de Valois. The accident of his becoming preceptor of the children of M. de Gondy, the commandant of the galleys at Marseille, led to his being appointed almoner-general of the galleys in 1619. It was at this time that the well-known incident occurred of his offering himself, and being accepted, in the place of one of the convicts, whom he found overwhelmed with grief and despair at having been obliged to

leave his wife and family in extreme destitution. Meanwhile he had laid the foundation of what eventually grew into the great and influential congregation of Priests of the Missions; an association of priests who devote themselves to the work of assisting the parochial clergy by preaching and hearing confessions periodically in those districts to which they may be invited by the local pastors. The rules of this congregation were finally approved by Urban VIII in 1632; and in the following year the Fathers established themselves in the so-called Priory of St Lazare, in Paris, whence their name of *Lazarists* is derived. From this date, his life was devoted to the organisation of works of charity and benevolence. To him Paris owes the establishment of the Foundling Hospital, and the first systematic efforts for the preservation of the lives, and the due education of a class theretofore neglected, or left to the operation of chance charity. The pious Sisterhood of Charity is an emanation of the same spirit, and Vincent was intrusted by St Francis of Sales with the direction of the newly-founded order of Sisters of the Visitation. The queen, Anne of Austria, warmly rewarded his exertions, and Louis XIII. chose him as his spiritual assistant in his last illness. He was placed by the queen-regent at the head of the *Conseil de Conscience*, the council chiefly charged with the direction of the crown in ecclesiastical affairs; and the period of his presidency was long looked back to as the golden era of impartial and honest distribution of ecclesiastical patronage in France. Vincent was not, in any sense of the word, a scholar, but his preaching, which (like that of the Fathers of his congregation of Lazarists) was of the most simple kind, was singularly affecting and impressive. He left nothing behind him but the *Rules or Constitutions of the Congregation of the Mission*, 1658; *Conferences on these Constitutions*, 4to; and a considerable number of letters, chiefly addressed to the priests of the mission, or to other friends, on spiritual subjects. He died at the advanced age of 85, at St Lazare, September 27, 1660, and was canonised by Clement XII. in 1737. His festival is held on the 19th July, the day of his canonisation.

PAUL (PETROWITSCH), Emperor of Russia, the second son of the unfortunate Peter III. and the Empress Catharine II., was born in 1754, became heir-apparent on the death of his elder brother in 1763, and succeeded his mother on the imperial throne in 1796. The tragical death of his father when he was still a child, and the neglect and want of confidence with which his mother treated him, exerted a baneful influence on the character of P., who was kept in compulsory seclusion while Catharine shared the administration of the government with her favourites. In 1776, P., on the death of his first wife, a princess of Hesse-Darmstadt, married the Princess Dorothea of Wurtemberg, by whom he had four sons—the late Emperors Alexander and Nicholas, and the Grand Dukes Constantine and Michael, and several daughters. After spending some years in travelling with his wife through Germany, France, and Italy, P. was recalled by his mother, who assigned to him the palace of Gatchina, 30 miles from St Petersburg, as his settled residence, while she took his children under her own immediate care. The death of the empress in 1796 released him from his unnatural restraint, and he ascended the throne with no practical acquaintance with the mechanism of government, and no knowledge of the people whom he was called to rule over. A determination to change everything that had existed under the previous reign, and to wreak vengeance on the murderers of his father, were the predominating influences that

guided his actions; and his earliest measures, which were the disgrace of his father's murderers, and the pardon of all Polish prisoners, gave hopes of a good reign; but the capricious violence of character and incapacity for business which P. betrayed, soon disappointed the hopes that he had awakened. No department of the state was free from his frivolous interference, and no class of the nation exempt from the effect of his arbitrary legislation. While he irritated the soldiery by vexatious regulations in regard to their dress, he offended the nobles by imperious enactments as to the ceremonials to be observed in his presence. His foreign policy was marked with similar caprice. After having adopted a system of neutrality in the war between France and the rest of Europe, he suddenly declared in favour of the allied powers, and sent an army of 56,000 men under Suwaroff into Italy. The success of his general encouraged him to send a second army of equal strength to co-operate with the Austrians; but their defeat in 1799 induced P. to recall Suwaroff with the Russian troops; and having retired from the allied coalition without having given any reason for his conduct, he quarrelled with England, because she would not comply with his whimsical demand for the surrender of Malta, and his own recognition as Grand Master of the Order of Malta, and entered into a close alliance with Bonaparte, who was then First Consul. The jealousy and hatred of England by which both were actuated, proved a powerful bond of union between them; and in furtherance of their scheme of uniting all the smaller maritime powers into one vast confederation against England, P. concluded a convention with Sweden and Denmark for the purpose of opposing the right insisted on by England of searching neutral vessels. The result was that the English government sent a fleet into the Baltic under Nelson to dissolve the coalition, at the close of March 1801. P. was preparing to give material aid to the Danes, when a conspiracy was formed at St Petersburg to put a stop to the capricious despotism under which all classes of men in Russia were groaning. The conspirators, whose numbers included Count Pahlen, the most influential man at court, General Beningssen, Uwarow, and many other distinguished nobles and officers, appear originally to have intended only to force P. to abdicate, but his obstinate disposition led to a scuffle, in which the emperor was strangled, March 24, 1801.

PAULDING, JAMES KIRKE, an American author, was born at Pleasant Valley, New York, August 22, 1779. His father was a farmer, descended from the early Dutch settlers. Self-educated, and early developing a tendency to literature, he was a friend of Washington Irving, and wrote a portion of *Salmagundi*. During the war of 1812, he published the *Diverting History of John Bull and Brother Jonathan*; in 1813, a parody of the *Lay of the Last Minstrel*, entitled *A Lay of the Scottish Fiddle*; and in 1814, a more serious work, *The United States and England*, a defence against articles in the *Quarterly Review*. This work attracted to him the attention of President Madison, and caused him to be appointed a member of the Board of Naval Commissioners. In 1817, he published a defence of the southern states and of slavery in *Letters from the South, by a Northern Man*; in 1819, a new series of *Salmagundi*; in 1822, *A Sketch of Old England, by a New England Man*; and in 1824, *John Bull in America, or the New Munchausen*, a satire on the writings of certain British tourists. This was followed by *Konigsmarke*, a novel (1825); *Merry Tales of the Three Wise Men of Gotham* (1826); *The New Pilgrim's Progress* (1828); *Tales of a Good Woman* (1829); *Book of St Nicholas* (1830). These

works, mostly humorous and satirical, had various degrees of local popularity; but in 1831 he produced *The Dutchman's Fireside*, a novel that was reprinted in England, and translated into French and Dutch; and in 1832, *Westward Ho!* which attained to a similar popularity. These were followed by *A Life of Washington* (1835), *Slavery in the United States* (1836), in which the institution is defended on social, economical, and physiological grounds. He held at this period the lucrative post of Navy Agent at New York, and was by Mr Van Buren appointed Secretary of the Navy, which gave him the position of cabinet minister. At the close of Mr Van Buren's presidency in 1841, Mr P. retired to a country residence at Hyde Park, New York, where he wrote *The Old Continental*, a novel (1846); *The Puritan and his Daughter* (1849); and with his son, a volume of Plays and Fairy Tales. He died at Hyde Park, April 6, 1860.

PAULICIANS, an ancient sect of the Eastern Empire, who, by Catholic writers, are reckoned an offshoot of the Manichæans (q. v.). According to Peter of Sicily and Photius, the sect originated in Armenia from two brothers, named Paul (from whom it is alleged to have received its name) and John, who flourished in the 4th century. Others trace it to an Armenian named Paul, who lived under Justinian II. The P. were at all times treated with much suspicion, and repressed with great severity, by the eastern emperors; Constantine II., and Leo the Isaurian especially laboured to repress them, and indeed, with the exception of Nicephorus Logotheta (802—811), it may be said that all the emperors, with more or less rigour, persecuted them. Their greatest enemy, however, was Theodora (841—855), who, having ordered that they should be compelled to return to the Greek Church, had all the recusants cruelly put to the sword or driven into exile. A bloody resistance, and finally an emigration into the Saracen territory, was the consequence; and it is from the Paulician settlers in Bulgaria (Catholic historians) that the Manichæan doctrines which tinged the opinions of most of the mediæval sects, are supposed by Roman Catholic historians to have found their way into the eastern provinces of the Western Empire. Even so late as the 17th c., according to Mosheim (ii. 238), there was a remnant of this sect existing in Bulgaria.

It is proper, however, to notice that a very different view of the character and doctrines of the P. has been advocated by such modern writers on ecclesiastical history as Gieseler and Neander, according to whom they had their origin from one Constantine of Mananalis (near Samosata), an Armenian, who had received a present of two volumes—one containing the four gospels, and the other the epistles of Paul—and who afterwards assumed the name of Paul, in testimony of his great veneration for that apostle. The distinctive characters of his doctrine and that of his followers were the rejection of the worship of the Virgin, the saints, and the cross, the denial of the material presence of Christ in the Eucharist, and the assertion of a right freely to search the Scriptures; and the charge of Manichæism was falsely brought against them by their persecutors.

PAULLI'NIA. See GUARANA BREAD.

PAUL'S (ST) CATHEDRAL in London is noted from its being the largest and most magnificent Protestant church in the world, and second only to St Peter's in Rome among the religious structures of modern times. The site of the present building was occupied about 610 by a Christian church dedicated to St Paul. This church continued till 1083, when it

was destroyed by fire. From its ruins arose a much more splendid edifice—the immediate precursor of the present cathedral. In 1137, the building suffered severely from fire; but, that being the great age for splendid churches, it was soon restored with great magnificence, the bishops and the people contributing most liberally to defray the cost. Old St Paul's was the largest church in the country, being 690 feet in length, 130 in breadth, and about 150 feet high. The total height of the stone tower and the spire, covered with lead, which surmounted it, was 520 feet. The cloister was 90 feet square, with a beautiful chapter-house in the centre. In 1666, the great fire of London completely destroyed the old cathedral, along with a large portion of the city and most of the churches; and thereafter, Sir Christopher Wren was employed to design about 50 of the new churches, and, among others, the new cathedral. In 1673, he submitted several designs for a new cathedral to the king, who selected one, and ordered a model of it on a large scale to be prepared. This was done by Wren, and the model still exists. Its plan is in the form of a Greek cross, having a large dome over the centre, supported on eight arches. This was, however, eventually departed from; and the new design was modelled on that of a Gothic cathedral, with an interior length of 460 feet, width 240 feet across transepts, and a nave 94 feet wide. The dome, and the eight supporting arches of the model, are preserved; but in the new design the angle arches lead to no spacious compartment, but to small dark passages only: while the upper portions of these great arches are blocked up with other arches, introduced for constructive purposes, but very destructive of the architectural effect. The plan of supporting the dome on eight arches had the charm of novelty, and also of simplicity of construction, but it made the arches themselves too small in proportion to the great span of the dome. The constructive skill displayed by Wren in this building is universally acknowledged and admired, but it is thought that he has allowed the mechanical exigencies of the work to interfere too much with its decorative requirements. The dome, for example, is constructed on a new and most masterly principle, the thrust of the vault being counterbalanced by the weight of a brick cone, which is carried up to support the stone lantern over the exterior dome. But in order to carry this out with the least expenditure possible, the drum, or plain cylindrical wall under the dome, is sloped inwards, so that the columns with which it is decorated appear to the spectator below to be falling inwards, thus producing a painful and disagreeable effect. Great exception is taken to the fact, that the external dome is of wood, and not of stone, and so liable to premature decay; but the same may be said of the wooden roofs over the vaults of Gothic cathedrals; and by making it of wood, Sir Christopher was enabled to raise it to a height which makes it one of the noblest buildings of the kind in the world. The design of the nave, from the classic vaulting with which it is covered, is necessarily to a great extent a failure. When domes, or intersecting vaults, are used in a classic building, the compartments must be about square; there can therefore be but a small number of nave piers, as compared with those of a Gothic cathedral, and the perspective effect of the latter is thus entirely wanting. The same is the case at St Peter's. The dome is particularly successful, and is admitted to be the finest in existence; no other being so graceful and varied in outline and yet so massive in general effect. Its height from the pavement to the top of the cross is 40½ feet. The west front, as seen from Ludgate

Hill, is most striking; the two campaniles group most harmoniously with the dome, and, together with the portico, produce a most pleasing and remarkable effect. This front must, however, be condemned, along with the screen-walls, if strictly criticised. The upper portico appears to indicate an upper story where there is none, and the actual construction and true form of the building are not expressed at all. St Paul's is the burial-place of many heroes and men of distinction, whose tombs are in the crypt, and whose monuments adorn the interior of the cathedral. Amongst these are Nelson and Wellington, Collingwood, Abercromby, Moore, Howe, St Vincent, Picton, Rodney, and many other celebrated soldiers and sailors; Howard, Johnson, Reynolds, Barry, Opie, West, Astley Cooper, Sir William Jones, Sir Christopher Wren, and other distinguished civilians. Several of the monuments are by Flaxman, Chantrey, Bacon, and Rossi; but it must be confessed that they savour generally too much of heathen mythology, to be appropriate in a Christian cathedral.

PAULUS ÆGINETA, a celebrated Greek physician, was born in the island of Ægina, and flourished during the conquests of the Calif Omar in the 7th century. Of his life we know almost nothing more than that he pursued his medical studies first at Alexandria, and afterwards in Greece and other countries. His forte lay in surgery and obstetrics, in the latter of which departments of medicine his practice was great. He abridged the works of Galen, and was deeply read in those of Ætius and Oribasius, while he always exercised an independent judgment in forming his conclusions. His descriptions of diseases are brief and succinct, and also complete and exact. He often grounds his explanation of morbid phenomena on Galen's theory of the cardinal humours; while in surgery his writings abound with novel and ingenious views. His works—the principal of which is commonly called *De Re Medica Libri Septem* (Lond. 1834)—have passed through many editions, of which the best is that completed at Lyon in 1567, and they have also had many translators, of whom the best in English is Dr Francis Adams.

PAULUS DIACONUS (also called PAULUS LEVITA, both surnames being derived from his ecclesiastical office), one of the most learned men of his time, and the greatest Lombard historian, was born of a noble Lombard family at Friuli about 730. His father's name was Warnefrid. He received a superior education at Pavia, at the court of the Lombard king Ratchis, and appears to have continued at court during the reigns of his successors, Aistulf and Desiderius, and to have accompanied Adelperga, the daughter of Desiderius, whose education he had conducted, to the court of her husband, Duke Arichis of Beneventum. For her he wrote, in 781, after he had become an ecclesiastic, one of his principal works, his *Historia Romana*, a work of no authority, as it is a mere compilation from works which we possess, but which was greatly used during the whole of the middle ages, as the many manuscripts, recensions, and continuations of it, attest. An edition of the genuine text is still wanting, but a great part of it is given in Muratori's *Rerum Italicarum Scriptores*, vol. 1 (Milan, 1728). In 781, P. became a monk of Monte Casino; but afterwards went to France, and won the esteem of Charlemagne in a high degree by his character and learning. He aided that monarch in his schemes for the promotion of learning, and introduced the study of the Greek language into France. He made a collection of homilies from the best sources, at the emperor's desire, known as the *Homiliarium*, often

printed between 1482 and 1569, and translated into German and Spanish. At the request of Angilram, Bishop of Metz, he also wrote a history of the Bishops of Metz, *Gesta Episcoporum Mettensium* (printed in Pertz's *Monumenta Germanica Historica*, vol. 2), the first work of the kind on the north of the Alps, but the example of which was soon very generally followed. In 787, he returned to his convent, where he remained till his death, which is said to have taken place in 797. In the latter years of his life, he wrote his *History of the Longobards* (*De Gestis Langobardum*, *Libri* 6), but did not live to complete it, bringing down the history only to the death of Liutprand in 744. There are several editions of this work, the best of which is contained in the work of Muratori. It is characterised by remarkable candour, and a style unusually pure for that age. The high repute in which this work also was long held, is attested by the great number of manuscripts and continuations. P. was likewise the author of a number of theological works, and of some hymns and letters still extant.

PAULUS, HEINRICH EBERHARD GOTTLÖB, a German theologian of great note in his day, and one of the leaders of the Rationalists at the close of the last and the first quarter of the present century, was born at Leonberg, near Stuttgart, 1st September 1761. He gave himself to the study of oriental languages at Göttingen, and afterwards prosecuted it in London and Paris. In 1789, he was called to the professorship of Oriental Languages at Jena, and in 1793 became Professor of Geology, on the death of Döderlein. Here he especially signalled himself by the critical elucidation of the Scriptures of the Old and New Testament, in so far as they presented oriental characteristics. The results of his labours may be seen in his *Philologisch-kritischen und historischen Commentar über das Neue Testament* (4 vols. Lüb. 1800—1804); *Clavis über die Psalmen* (Jena, 1791); *Clavis über den Jesaia*, and other writings belonging to this period of his literary activity. In 1803, he removed to Würzburg; in 1808, to Bamberg; in 1809, to Nürnberg; and in 1811, to Ansbach. During these various changes, he had ceased to be a professor, and become a director of ecclesiastical and educational affairs; but in 1811 he accepted the professorship of Exegesis and Ecclesiastical History at Heidelberg. In 1819, he started a kind of historico-political journal entitled *Sophronizon*, in which he continued to write for about ten years. His contributions were marked by weighty sense, moderation, and knowledge of his various subjects, and won him great applause at the time. As a theologian, he is generally looked upon as the type of pure unmitigated rationalism—a man who sat down to examine the Bible with the profound conviction that everything in it represented as supernatural was only natural or fabulous, and that true criticism consisted in endeavouring to prove this. From his numerous writings, we select for mention the following: *Memorabilien* (Leip. 1791—1796); *Sammlung der merkwürdigsten Reisen in den Orient* (7 vols. Jena, 1792—1803); *Leben Jesu, als Grundlage einer reinen Geschichte des Urchristenthums* (2 vols. Heidelb. 1828); *Aufklärende Beiträge zur Dogmen-Kirchen- und Religionsgeschichte* (Bremen, 1830); and *Exegetisches Handbuch über die drei ersten Evangelien* (3 vols. Heidelb. 1830—1833). P. died 10th August 1851, at the advanced age of 90—having lived long enough to see his own rationalistic theory of Scripture give place to the 'mythical' theory of Strauss, and that in its turn to be shaken to its foundations partly by the efforts of the Tübingen school, and partly by those of Neander and the 'Broad Church' divines of Germany. See P.'s *Skizzen aus meiner Bildungs- und Lebensgeschichte*

*zum Andenken an mein 50-jähriges Jubiläum* (Heidelb. 1839), and Reichlin Meldegg's *H. E., G. Paulus und Seine Zeit* (2 vols. Stuttg. 1853).

PAUPER COLONIES are establishments at Frederikssoord and Veenhuizen in the Netherlands, province of Drenthe, and at Willemssoord and Ommerschans in Overijssel. They were erected by a benevolent society for the purpose of employing poor people in cultivating land and various industries. In 1858, the society suspended payments, and the state took the temporary management, arranged with the creditors, finally retaining Ommerschans and Veenhuizen, leaving Frederikssoord and Willemssoord to be governed by the society.

On 1st January 1860, the government colonies contained 603½ persons, of whom 4407 had been beggars. There were 41 farms, 15 factories and workshops, with churches and schools. The stock consisted of 104 horses, 508 cows, 1259 sheep, &c., and the breadth of land in culture extended to 1454 acres in rye, barley, oats, and buckwheat, 741 in potatoes, and 1124 in grass. Peat is extensively cut; half a million coffee-bags are made annually, &c. These institutions are kept up at a considerable expense to the nation, but have been successful in reducing the numbers and improving the social condition of many of the destitute poor.

The colonies of the benevolent society extend to 4942 acres, and the inhabitants are either tenant cotters, with about 7 acres of land attached to each house, or labour for the society. In 1863, there were 259 cotter families, paying for house, garden, land, and the use of a cow, a yearly rent of about £5, 17s. Those who are not required for the land, work in the factories, weaving cottons, bagging, coarse linens, making baskets, mats, &c. There are two Protestant churches, a Roman Catholic chapel, and a synagogue. The society's colonies have never been self-supporting, and are partly maintained by the yearly contributions of members, gifts, legacies, &c.; the total receipts, from all sources, in 1862, amounting to £37,000, and the expenditure to £34,000. Pop. 2611. In 1863, there were 5079 members who contributed £1378; and the property, stock, &c., of the society are valued at £74,000. The colonists have been greatly improved in position, and their houses shew signs of industry and comfort. When working in the factories, a tenth part of their weekly earnings is placed in a reserve fund, which is paid out to them in winter or in time of sickness.

PAUSA'NIAS, a famous Spartan regent and general, the son of Cleombrotus, and nephew of Leonidas. He commanded the confederate Greeks in the important battle of Plataea (479 B.C.), in which the Persians were totally routed, and their leader, Mardonius, slain. He then marched his troops against Thebes, and compelled the inhabitants to give up the chiefs of the Persian party to him for punishment. Elated by this victory, however, he became in an extreme degree haughty and vain-glorious, took all the credit to himself, and allowed none to the Athenian generals, Aristides and Kimon, who commanded under him, and treated all the other Greeks as if the Spartans were their lords. Nevertheless, he still continued his conquests, capturing Cyprus and Byzantium. It was here he first began to play false to Greece. He entered into secret negotiations with Xerxes, with the view of becoming ruler, under the Persian monarch, of the whole country, and in his journey through Thrace, even adopted the dress and luxurious habits of a Persian satrap, and surrounded himself with a body-guard of Persians and Egyptians. Being recalled, on account of these things, by the Spartans, his former

services procured his acquittal. He then returned to Byzantium, where he renewed his traitorous intrigues, was expelled from the city for a criminal assault upon a Byzantine lady, withdrew to the Troad, and there continued his treachery. He was a second time called to account by the Spartan ephors, but again escaped, though with greater difficulty. Yet his passion for the sovereignty of Greece, even though at the expense of the national liberties, once more drove him to play the traitor. He tried to stir up the Helots, but was taken in his own net. A Helot betrayed him. When P. found his position desperate, he took refuge in a temple of Athene. Hereupon the people blocked up the gate of the temple with heaps of stones, and left him to die of hunger, his own mother depositing the first stone.

PAUSANIAS, one of the most eminent of Greek geographers and historians, was probably a native of Lydia in Asia Minor, and was born some time in the 2d century. He travelled through almost all Greece, Macedonia, and Italy, and also through part of Asia and Africa, and composed from his observations and researches an Itinerary, entitled *Hellados Periegesis*, in ten books, describing the different parts of Greece, and giving a particular account of the monuments of art and of the legends connected with them. His style is by no means pure; but in matters of his own observation he is most trustworthy, and his work is, on many subjects, one of the most valuable sources of information that we possess. There are numerous editions of his work; the oldest was printed at Venice in 1516 by Aldus; and the most recent is that by J. H. C. Schubart and C. Walz (3 vols. Leip. 1838—1840. Translations of P. exist in English, German, and French.

PA'VEMENT, flat stones or 'flags' used for the flooring of halls, kitchens, and other apartments, and frequently for footpaths; also the stone covering of the roadway of streets. The stones used for flags vary in different districts, according to the geological formation of the neighbourhood. The pavements now most commonly used in England and Scotland are the Arbroath and Caithness stones—the former a softer and more agreeable stone than the latter, which is exceedingly hard and slippery when wet. Pavement should be carefully laid on a solid dry foundation, and set in a good bed of concrete or lime, and the joints pointed with cement. It may also be laid on small dwarf walls, built of brick, so as to support all the edges—this is a good method for keeping the floor dry.

The PAVING OF STREETS is of early date, and is, in fact, necessary to any considerable degree of civilisation and traffic. The Romans paved their streets in the same elaborate and solid manner in which they paved their highways. See ROADS. Portions of the ancient pavement of the streets of Rome are in use to the present day, and the pavement of Pompeii remains entire. It is laid with large blocks of stone of polygonal shape (like Cyclopean masonry), very carefully fitted together, and of considerable depth, and below there is a carefully prepared basis, often composed of several distinct strata. Some of the Italian towns—Florence, for instance—have still pavement of this description, and no foot-pavement.

The mediæval cities were almost all unpaved till about the 12th c., when the main streets of the chief towns began to be protected with stone. The plan now adopted is nearly the same in all the cities of Europe. The first thing to be done is to secure or make a solid foundation. This is done, where the natural substratum is not of a solid kind,

by laying the street with a solid bed of concrete, having a slope from the middle to the sides to throw off the water. On the concrete is placed the real pavement, which is composed of blocks of granite, trap, or other tough rock. These should be rectangular, and the deeper the better. They are generally about 10 inches to 12 inches in depth, and 6 inches or 7 inches broad, and from 1 to 2 feet in length. They should be all bedded and jointed in strong mortar. This is not often done, as it is thought sufficient to bed the stones in sand, and grout them with hot lime on the top. It is clear, however, that the more equal the stones are in depth, and the more solidly they are bedded, the longer they will last. Other materials besides stone have been tried for the paving of streets—such as blocks of wood with the end up, and blocks of cast iron. The wooden pavement is delightfully easy, and not noisy, but in wet weather it is exceedingly slippery. Cast-iron is too hard, and causes too much jolting and noise.

The great obstacle in the way of really good pavement in modern streets is the necessity of frequently breaking it up for the laying and repairing of pipes for gas, water, &c. The true remedy—and, in the end, the cheapest—would be to have, in the chief streets at least, sub-ways or tunnels for drains and pipes, accessible without breaking up the pavement.

PA'VIA, a city of Northern Italy, capital of the province of the same name, on the left bank of the Ticino, 20 miles south of Milan, and 3 miles above the confluence of the Ticino and the Po. A covered bridge of eight arches connects the city with the suburb of *Borgo Ticino*, on the right bank of the river, and from this bridge the *Strada Nuova*, or *Corso*, the principal thoroughfare, leads north, and extends to the outskirts. The city is large, surrounded by walls, and has an imposing appearance, bearing the impress of antiquity. In former times, it was called the 'city of a hundred towers;' but the palace of Theodoric, and the tower where Boëthius wrote the treatise *De Consolatione Philosophicæ*, no longer exist; among the remaining ones are those of Belcredi and Del Maino, which are each 169 feet high. Its oldest church, and perhaps the oldest in Italy, is that of San Michele, which, although the date of its foundation is uncertain, is first mentioned in 661. The cathedral, containing some good paintings, was commenced in 1484, but was never finished. In a beautiful chapel attached to it, are the ashes of St Augustine, in a sarcophagus ornamented with 50 bassi-rilievi, 95 statues, and numerous grotesques. In the Church of San Pietro in Ciel d'Àuro are deposited the remains of the unfortunate Boëthius. The Certosa of P., the most splendid monastery in the world, lies four miles north of the city. It was founded in 1396, contains many beautiful paintings, and abounds in the richest ornamentation. It has an octagonal cupola, painted ultramarine, and enamelled in gold. It was sacked by the French in 1796. Its church is in the form of a Latin cross, and is 249 feet long, and 173 feet wide. The university of P. is said to have been founded by Charlemagne in 774, and was one of the most famous seats of learning during the middle æge. Its efficiency was much increased by Galeazzo Visconti, who bestowed many privileges upon it in the year 1396. It consists of numerous colleges, and attached to it are a library of 120,000 vols., a numismatic collection, anatomical, natural history, and other museums, a botanic garden, a school of the fine arts, &c. The university is attended by about 1600 students. It has numbered among its professors Alciati, Fidelfo, Spallanzani, Volta, Scarpa, Foscolo, and Monti.

The other chief edifices comprise private palaces, theatre, gymnasium, &c. P. carries on a good trade in wine, rice, silk, and cheese. Pop. (1862) 30,480.

P., the ancient *Ticinum* (afterwards *Papia*, whence the modern name), was founded by the Ligurii; it was sacked by Brennus and by Hannibal, burned by the Huns, conquered by the Romans, and became a place of considerable importance, at the end of the Roman empire. Then it came into the possession of the Goths and Lombards, and the kings of the latter made it the capital of the kingdom of Italy. It became independent in the 12th c., then, weakened by civil wars, it was conquered by Matthew Visconti in 1345. Since that period, its history is merged in that of the conquerors of Lombardy. Here, in 1525, the French were defeated by the imperialists, and their king taken prisoner; but in 1527, and again in the following year, it was taken and laid waste by the French. It was stormed and pillaged by Napoleon in 1796, and came into the possession of Austria by the peace of 1814. Since 1859, it has been included within the re-organised kingdom of Italy.

PAVIA. See HORSE-CHESTNUT.

PAVILION, a portion of a building, under one roof, of a tent-like form, with the slope of the roof either straight or curved. This form is much used in France—the higher parts of the new buildings at the Louvre are good examples of pavilions. Pavilion roofs are sometimes called French roofs.

PAVLOGRA'D, a town of South Russia, in the government of Ekatermoslav, and 38 miles east-north-east of the town of that name, on the Voltcha, an affluent of the Dnieper. It was founded in 1780, during the reign of the Empress Catharine II., and its first colonists were the Zaporogsky Cossacks. But in 1782, a great portion of the English garrison of Fort Magon in Minorca, having been subdued by the Spaniards, and being forced by the terms of their capitulation to renounce the English service, obtained liberty from the Empress Catharine to settle in Pavlograd. The garrison was composed chiefly of Corsicans. Pop. of the town (1864), 9309.

PAVO'NIDÆ, a name sometimes used by ornithologists to designate the family of gallinaceous birds more commonly called *Phasianids* (q. v.), sometimes applied as a designation to a portion of that family separated from the rest on very slight grounds, the chief distinction being the greater expansion of the tail. See PEACOCK and POLYFLETRON.

PAWL, on shipboard, is a catch or hook to prevent the capstan from flying round backwards during a pause in the heaving. A similar catch is used in the common windlass.

PAWNBROKING (Du. *pand*, Ger. *pfand*, Fr. *pan*, a pledge). The business of lending money on pawns or pledges appears to have been carried on in England by certain Italian merchants or bankers as early at least as the reign of Richard I. By the 12th of Edward I., a message was confirmed to these traders where Lombard Street now exists; the name being, according to Stow, derived from the Longobards who used to congregate there for business purposes. Subsequently, these merchant adventurers became known generally by the name of Lombardens. Their wealth became proverbial. Among the richest of them were the celebrated family of the Medici; from whose armorial bearings it is conjectured that the pawnbroking insignia of the three balls have been derived. The bankers of Lombard Street appear to have exercised a monopoly in pawnbroking until the reign of Elizabeth. The trade is first recognised in law by the act 1st

James I. c. 21. In the perilous days of Charles I. the goldsmiths were very frequently chosen as the custodiers of plate and money; which circumstance seems to have suggested to them the profitable business of lending on pawns and discounting bills. From this time, the oppression and extortion often exercised by brokers has continued to attract much public attention and discussion; and an effort has been made, both in England and on the continent, to obviate the evil by the establishment of what are called *Monts de Piété*, the object of which is to advance small sums to the very poor at a moderate interest. See MONT DE PIÉTÉ. In England, after many abortive efforts, a *Mont de Piété* office was started in 1708; but in 1731 it came to a disastrous end. The bubble mania of 1824—1825 gave rise to a similar scheme. In this instance upwards of £400,000 was subscribed; but the undertaking miscarried, and the capital was lost. A similar fate attended the Irish *Monts de Piété*, of which there were eight in 1841. In 1848, they had all disappeared except one, which lingered to 1853; when it also expired. It would thus seem hopeless to attempt to establish a pawnbroking office in England on any other footing than an ordinary commercial one. The cause of failure will be found to lie, generally, in the great difficulty of conducting a commercial undertaking on charitable principles, with sufficient energy and ability to compete successfully with others originating in the ordinary motives which lead men to engage in trade.

It hardly admits of dispute that the pawn-shop, in its practical working, is an evil—necessary, it may be, but still an evil; and the having recourse to it is strongly to be discouraged. There are, doubtless, cases where men are driven to pawn their goods from causes which are not discreditable, and which do not render it certain that they are on the road to ruin; but such cases are rare exceptions to the general rule. Besides making borrowing too easy, and thus encouraging the fatal habit of anticipating income, the pawn shop is, in nine cases out of ten, the door to the drinking-shop. Even where the one does not directly lead to the other, it generally does so in the end. That 'borrowing dulls the edge of husbandry' applies with a force increasing in a geometrical ratio as we descend in the scale of society. Admitting, however, that with all its tendency to demoralise, pawnbroking is, in many cases, of value in tiding over unforeseen pecuniary difficulties, it is sufficient to say, that so long as improvidence prevails among large classes of society, and so long as even the most prudent are liable to unforeseen accidents, the accommodation of the pawn-shop is to a certain extent a necessity, and like other demands of the public will continue to be supplied. Nor are those who supply this demand to blame, any more than the caterers for many other expenses which economists pronounce to be wasteful. The fault, where there is a fault, is in those who borrow, not in those who lend. The legislature, accordingly, instead of trying to put down pawnbroking, has wisely confined itself to putting it under stringent regulations so as to prevent as far as possible its abuse.

Pawnbrokers are restricted in their business by various acts of parliament, some of which were passed before the recent abolition of the Usury Act. The chief statute is the 39 and 40 Geo. III. c. 99, which requires them to take out a licence (for which they pay £7, 10s., and if they deal in silver-plate, £5, 15s. additional), fixes the rate of interest, and makes it necessary that a table of interest should be put up in a conspicuous part of the shop, to keep books with correct entries of the name and place of abode of the owners

of goods, &c. If the owner of goods has just cause to suspect that such goods have been pawned at a particular shop, the justices of the peace may grant a search-warrant, and if found, the goods must be restored to the owner. Pawnbrokers are expressly prohibited from taking in pledge goods of manufacture in an unfinished state, and also any goods under circumstances which ought to have aroused their suspicions. Goods which have been in pledge for a year may be sold, unless notice not to sell be given before the expiration of the 12 months, in which case three months more are allowed to the owner to redeem them. If the duplicate is lost, the owner of the goods may obtain a fresh one on verifying the fact of his being the owner before a justice of the peace. If the money borrowed be tendered with interest within the year, the pawnbroker is bound to deliver them up, otherwise a justice of the peace may by order compel him to do so. The mode of selling forfeited goods is prescribed by the statute to be by auction, and at four times in the year—the catalogues to contain the names of the pawnbrokers, and the month when the goods were pawned and the number entered in the pawnbroker's books. The result of the sales is to be entered in the books of the pawnbroker and auctioneer, and the surplus is to be paid on request to the owner of the goods after deducting the costs of the sale. Pawnbrokers are not to take goods in pawn from persons under the influence of drink, or under the age of 16, nor after certain hours, according to the season of the year. In case of penalties imposed on pawnbrokers for offences against the act, these, in several cases, or parts of them, are made payable for the benefit of the poor of the parish. A pawnbroker is not liable to the owner of the goods for their value in case of an accidental fire occurring on the premises. But in all cases of loss, or destruction by his neglect or fault, the pawnbroker is liable.

The greatest pawnbroking establishment in the world is the Mont de Piété of Paris. It trades with borrowed capital, and with the profits of former years temporarily capitalised. Recent statistics are not at hand; but in 1853 it received 1,431,575 pledges, valued at £1,036,371, including renewals, and the average charge was about 15 per cent. per annum. Taking one of the largest offices in England out of London, we find that in 1857 it received 142,835 pledges, valued at £36,560, including renewals, and the average charge was 25 per cent. per annum. Various circumstances render the difference between the rates really much less than these figures indicate; still there is no doubt that the interest charged on small loans is lower at the Mont de Piété of Paris than in the pawnbroking offices in this country; but this convenience is limited by the fact of the French establishment taking no loans under three francs.

What is called in England the 'dolly shop,' and in Scotland the 'wee pawn' system is carried on by brokers, ostensibly buying and selling. They receive articles as bought; there being a distinct understanding that the seller is to have an opportunity of repurchasing within a limited time, at an understood increase of price. The general understanding as to charge is a penny per shilling per week; a month being usually allowed to redeem the article. The 'wee' broker is commonly resorted to because the article is one which the regular dealer will not take, or will not give so high an advance upon.

PAWTUCKET, a town of Rhode Island, U.S., on both sides of the Pawtucket River, 4 miles north of Providence. A fall of 50 feet on the river, and its proximity to the sea, caused it to be selected by Samuel Slater, in 1790, as the site of the first cotton

factory in the United States. It now contains 13 cotton mills, 9 machine shops, 3 furnaces, and manufactures of fire-engines, belting, jewellery, &c. There are 11 churches, 4 banks, 2 newspapers, a public library, with extensive steam-boat and railway connections. Pop. in 1860, 8880.

PAX, called also PACIFICALE and OSCULATORIUM (Lat. *osculator*, I kiss), the 'Kiss of Peace,' and also a sacred utensil, employed in some of the solemn services of the Catholic Church in the ceremony of giving the so-called 'kiss of peace' during the mass. The practice of saluting each other—the men, men, and the women, women—during public worship, and particularly in the *agape*, or love-feast, is frequently alluded to by ancient writers, as Cyril of Jerusalem, Catech. xv., and St Augustine, Serm. 227. All the ancient liturgies, without exception, refer to it as among the rites with which the Eucharist was celebrated; but they differ as to the time and the place in the Eucharistic service in which it is introduced. In the Eastern liturgies it is before, in the Western after the Offertory (q. v.); and in the Roman it immediately precedes the communion. The ceremony commences with the celebrating bishop or priest, who salutes upon the cheek the deacon; and by him the salute is tendered to the other members, and to the first dignitary of the assistant clergy. Originally the laity also were included, but this has long since been abandoned. It is when the mass is celebrated by a high dignitary that the utensil called the pax is used. The pax is sometimes a crucifix, sometimes a reliquary, sometimes a tablet with a figure sculptured or enamelled upon it. Having been kissed by the celebrant, and by him handed to the deacon, it is carried by the latter to the rest of the clergy. In ordinary cases, the pax is given by merely bowing, and approaching the cheek to the person to whom it is communicated. The pax is omitted in the mass of Maundy-Thursaday (q. v.), to express horror of the treacherous kiss of Judas.

PAXO, one of the Ionian Islands, lies 10 miles south-west of the coast of Albania, and 9 miles south-south-east of the island of Corfu. It is about 5 miles long, and about 2 miles broad. The capital, or rather the chief village, is Port Gaio (pop. 2000), on the east coast. Olives, almonds, and vines are grown, and the island is famous for its oil. Water is sometimes very scarce. Pop. of the island about 5000.

PAXTON, Sir JOSEPH, English architect and horticulturist, was born at Milton-Bryant, near Woburn, Bedfordshire, in 1803. He was sent to Woburn Free School, but left it at an early age, and obtained employment as a working gardener. He entered the service of the sixth Duke of Devonshire, at Chiswick, and was thence transferred to Chatsworth, where he became the duke's chief gardener. His abilities as a horticulturist found ample scope in the beautiful gardens of Chatsworth, and are further attested by *Paxton's Magazine of Botany*, of which he was editor, as well as other works on plants and flowers. The experience he obtained in designing capacious glass conservatories at Chatsworth led him to propose a Crystal Palace of glass and iron for the Great Exhibition (q. v.) of 1851. It was the first time these materials had been employed on so extensive a scale, and visitors found an inexhaustible theme of admiration in a fairy palace so novel, beautiful, and magnificent. His design obtained for him great popularity and the honour of knighthood. The Crystal Palace of 1851 was removed from Hyde Park, but became the germ of the nobler and more



splendid Palace at Sydenham, the construction of which he superintended, the grounds were also laid out by him. Crystal palaces for exhibitions of artistic and industrial objects have since 1851 been constructed at Dublin, New York, Paris, Manchester, &c. In 1854, P. was returned to parliament on the liberal interest for Coventry, which he still (1864) continues to represent. He is a member of many learned societies in Europe, and his works on horticulture and botany are much esteemed.

**PAYMASTER-GENERAL** is an officer of the British ministry, but not of the cabinet, charged with superintending the issue of all moneys voted by parliament. He is virtually the paymaster of the public service, having no control over the sums issued, and paying merely on the order of the department concerned. The salary of the office is £2000 per annum. The paymaster-general is always either a peer or a member of the House of Commons, and of course changes with the ministry. Of late years the office has been held in conjunction with that of Vice-president of the Board of Trade. The paymaster-general is assisted by a deputy and a staff of clerks, the annual cost of the whole department amounting to £21,500. The first notice of this office is in the early part of the reign of Charles II., when the paymaster-general was nothing more than the sole paymaster of the army. The present extensive duties of the office have been added by degrees during the 19th century.

**PAYMASTER, MILITARY AND NAVAL**—Military paymasters are either 'District' or 'Regimental.' Of the latter, who constitute by far the more numerous class, there is one to every brigade of artillery, regiment of cavalry, and battalion of infantry. The paymaster holds no other commission, but the appointment is nearly always conferred upon some person who has previously held a combatant rank in the army. The functions of paymaster comprise issuing and accounting for the pay of officers and men, and having charge generally of all the finances of the corps. In discipline, the paymaster is responsible to the officer commanding the regiment; but in all money matters he looks for orders to the War Office alone. He commences with a pay of 12s. 6d. a day, with the relative rank of captain; and after twenty years' service attains the pay of £1, 2s. 6d. a day and relative rank as major. Regimental paymasters were first appointed during the French war.

District paymasters have financial charge in recruiting districts. They are usually old officers, and receive each 2s. 6d. a day more than the rates of regimental pay. Both in districts and regiments army paymasters have to provide security for the faithful discharge of their duty.—The **NAVAL PAYMASTER** is for a ship what the military paymaster is for a regiment; but he adds to those duties some of those performed in the army by the quartermaster, commissariat, and military storekeeper, for he has charge of the provisions, clothing, and miscellaneous stores, as well as of mere money. Paymasters are commissioned officers, receiving from £1, 12s. 11d. to 13s. 8d. a day, and ranking, according to service, with captains, commanders, and lieutenants. Up to the year 1844 paymasters were styled pursers, and were paid by profits they made on certain of the ship's charges. At a still earlier period these pursers had been warrant-officers.

**PAYMASTER-SERGEANT**, in the army, is a non-commissioned officer, whose duty it is to act as clerk to the paymaster. He ranks with other staff-sergeants, and receives from 2s. to 3s. a day, according to his corps, with an increase of 6d. after

seven years' uninterrupted service as paymaster-sergeant.

**PAYNISING**, a process for preserving and hardening wood, invented by a Mr Payne. It consists in placing well-seasoned timber in an air-tight chamber, and then, when, by means of a powerful air-pump, the wood is deprived of its air, a solution of *sulphuret of calcium*, or of sulphuret of barium is admitted, and readily fills up the empty vessels all through the wood. The air-pump is again used, and the superfluous moisture is drawn out, and a solution of sulphate of iron is injected; this acts chemically upon the sulphuret of barium or of calcium, and forms all through the wood either the insoluble sulphate of barium (heavy spar) or of lime (gypsum). The addition of these mineral matters renders the wood very heavy, but it becomes also very durable, and almost incombustible.

**PEA** (*Pisum*), a genus of plants of the natural order *Leguminosæ*, suborder *Papilionaceæ*, closely allied to the genus *Lathyrus* (q. v.), from which it differs chiefly in the triangular style. Two species are supposed to be natives of the south of Europe and of the East, are very extensively cultivated for their seeds (peas), which are the best of all kinds of pulse; the **COMMON PEA** or **GARDEN PEA** (*P. sativum*) in gardens, and the **FIELD PEA** (*P. arvense*) in fields; both of them climbing annuals, with pinnate leaves, ovate leaflets, and branching tendrils in place of a terminal leaflet; the **Garden Pea** distinguished by having two or several flowers on each flower-stalk, the flowers either red or white, more generally white, and the seeds subglobular; the **Field Pea** having one flower on each flower-stalk, the flowers always red, and the seeds angular from crowding and compression in the pod. But it is not improbable that they are truly one species, of which the **Garden Pea** has, through cultivation, departed furthest from the original type. Peas have been cultivated in the East from time immemorial, although the ancient Greeks and Romans do not seem to have been acquainted with this kind of pulse, the cultivation of which was apparently introduced into Europe very early in the middle ages; and its cultivation extends from warm climates, as India, even to the Arctic regions, the plant being of rapid growth and short life. The seeds of the **Garden Pea** are used for culinary purposes both in a green and in a ripe state; also the green succulent pods of some varieties, known as **Sugar Peas** or **Wyker Peas**, which the membrane lining the inside of the pod is parchment-like in most kinds—is much attenuated. **Field peas** are used both for feeding cattle and for human food. For the latter purpose, peas are often prepared by being *shelled*, or deprived of the membrane which covers them, in a particular kind of mill; they are then sold as *Split Peas*, and are much in use for making *Pea Soup*. They are ground into meal, which is used in various ways, chiefly for making a kind of pottage and of unleavened bread. In the countries bordering on the Mediterranean, peas are roasted in order to eating.

There are innumerable varieties both of the **Field Pea** and the **Garden Pea**, those of the latter being much the products of horticultural art, that they cannot be preserved without the utmost attention. Some of the kinds of garden peas have long stems and require for their support stakes of six or eight feet in height; others are of humbler growth; a certain dwarf kind, preferred as most convenient in many gardens, succeed very well without stakes. The largest kinds are sown in rows about four feet asunder. In Britain, garden peas are sown at different times from February to June, in order

PEA—PEABODY.

secure a supply of green peas during a considerable part of summer and autumn; and in the southern parts of the island they are also sown in the end of autumn, a very little protection being sufficient for them during the winter. Certain small kinds, of very rapid growth, known as *Early Peas*, are preferred for the first sowings, although less productive than many others. The varieties known as *Mammoth Peas* are remarkable for their size and tenderness in a green state, but shrivel as they ripen.

Branches of trees are generally used for pea-stakes, when they can be obtained, and nothing can be better; but in lieu of them, strings are sometimes stretched between poles along the rows. Field peas are sometimes sown alone, and allowed to support each other, where the soil is not very rich, but are very generally sown with beans, to which they cling.

Chalky and other calcareous soils are particularly suitable for peas, and in other soils a good field crop is seldom obtained unless the land has been well limed, or manured with gypsum. The free use of lime is supposed, however, to be unfavourable to the quality of garden peas intended to be used for food.

Peas are cultivated to a considerable extent as a field crop in Britain, but are best adapted to those districts in which the climate is least moist, the seeds being very apt to grow in the pods when moist weather prevails in autumn, by which the crop is injured or destroyed. The most productive kinds, being also in general the most bulky in growth, are very apt to lodge before the pods are filled, in wet seasons, and particularly on rich land. The crop is, therefore, rather a precarious one.

The haulm or straw of peas is used for feeding cattle; and for its sake, field peas are often reaped before they are quite ripe, great care being taken in stacking the straw to provide for ventilation, so that it may not heat. Pea haulm is more nutritious and more nutritious than hay.

Land to be sown with field peas should be very clean, and in particular free of couch grass; otherwise the best management cannot prevent its becoming more foul whilst bearing the pea crop. The seed ought always to be sown in rows, twelve inches apart, or, in rich soils, eighteen or twenty inches apart. Various means are employed for sowing peas; they are not infrequently ploughed under each second furrow; but the seed ought not to be buried more than four inches under the surface, and indeed that depth is too great; though many farmers sow their peas deeper than they otherwise would, to place them beyond the reach of wood pigeons. All possible means ought to be used to keep the land free of weeds. In some districts, peas are generally sown broadcast, which renders it impossible to do anything for this purpose. In the harvesting of peas, the sheaves are generally left loose till the haulm is somewhat dry, when, if they are to be used for food, they are dried, it shrinks very much. Broadcast peas are often cut with the scythe, and the harvesting of them is managed much as that of hay.—*Winter Peas*, a variety with very small seeds, are chiefly cultivated in France and Germany, being sown in October, enduring the severest frosts without injury, and ripening very early.

Besides being one of our most important agricultural and horticultural crops, peas are largely exported into Britain, the quantity sometimes reaching 120,000 quarters. We receive them from Denmark, Prussia, the Hanse Towns, Holland, Morocco, United States, British North America; and of these, Denmark and our North American colonies send the greater part. As an article of

food, if not taken too often or without other food, peas are very valuable, as they contain a large percentage of *casein*, which is a flesh-forming principle. This principle in the pea has been called *legumin*, but chemists are now generally agreed that it is identical with the casein of cheese. The following is an analysis of one hundred parts of pea meal:

Water,	14.1
Casein,	23.4
Starch,	37.0
Sugar,	2.0
Gum,	9.0
Fat,	2.0
Woody Fibre,	10.0
Mineral Matter,	2.5
	100.0

The unripe peas of the garden varieties are amongst our most esteemed vegetables, and the meal of the white or yellow varieties used in soups is a highly nutritious and agreeable food.

A plant found on some parts of the shores of Britain, as well as of continental Europe and North America, and known as the SEA PEA, has been commonly referred to the genus *Pisum*, and called *P. maritimum*, although botanists now generally refer it to *Lathyrus*. It much resembles the common pea; has large reddish or purple flowers on many-flowered stalks; and its seeds have a disagreeable bitter taste. Its abundance on the sea coast at Orford, in Sussex, is said to have saved many persons from death by famine in 1555.—The other species of *Pisum* are few. But the name Pea is often given to species of other papilionaceous genera. The SWEET PEA and EVERLASTING PEA are species of *Lathyrus*. The CHICK PEA (q. v.) is a species of *Cicer*.

PEA BEETLE, or PEA CHAFER (*Bruchus pisi*), a coleopterous insect, very destructive to crops

in the south of Europe and in North America. It is about a quarter of an inch long, black, variegated with bright brown hairs, and with white spots and dots on the wing-cases. It lays its eggs in the young pods, one for each pea, and the larva eats its way into the pea, and completely hollows it out.



Pea Beetle (*Bruchus pisi*), a, natural size.

PEABODY, GEORGE, an American merchant, whose name deserves to be held in remembrance on account of his munificent philanthropy, was born at Danvers, Massachusetts, February 18, 1795. His parents were poor, and his only education was received at the district school. At the age of 11 he was placed with a grocer, and at 15 in a haberdasher's shop in Newburyport. When 22 years old, he was a partner with Elisha Riggs in Baltimore. Coming to England in 1827 to buy merchandise, he transacted financial business for the state of Maryland. In 1837 he removed to London, and in 1843 became a banker, and accumulated a large fortune. He did not forget his humble origin or place of birth. In 1852, on the 200th anniversary of the settlement of his native town, he sent home 20,000 dollars to found an Educational Institute and Library, a sum he afterwards increased to 60,000 dollars, with 10,000 to North Danvers. He also contributed 10,000 to the first Grinnell Arctic Expedition, 500,000 dollars to the city of Baltimore for an Institute of Science, Literature, and the Fine Arts; and in 1863, on retiring from active business in London, he made the splendid donation of £150,000 sterling, for the benefit of the poor of

London, which is now being expended in building improved dwellings for the working-classes.

**PEACE, ARTICLES OF THE,** in English Law, are certain complaints made against a person who threatens another with bodily injury, and the redress given is to bind the threatening party over with sureties to keep the peace. All justices of the peace have, by their commission, authority to cause persons to find sufficient security to keep the peace, and an ancient statute also gives authority. Hence any one who is threatened either in person or property, or in the person of his wife or child, may go before a justice of the peace and complain on his oath of the fact. The justice is to consider if the language used amounted to a threat, and if he is satisfied that it does, he issues his warrant to bring the party before him, who is then heard in explanation, and if it is not satisfactory, he is ordered to find sureties. If he cannot do so, he is committed to prison for a limited time, or until the next quarter-sessions. The party, when he finds sureties, is bound over for a term not exceeding twelve months. If he has entered into recognizances (i. e., given a bond with sureties), and he break the peace, he forfeits his recognizance, and the sureties' goods can be seized to pay the amount of the bond.

**PEACE, OFFENCES AGAINST THE PUBLIC,** are those offences which consist in either actually breaking the peace, or constructively doing so by leading directly to a breach. These offences are now usually known under the heads of unlawful assemblies, seditious libels and slanders, riots, affrays, challenges to fight, forcible entry and detainer, and libel and slander. Those who take part in an unlawful assembly commit a misdemeanour against the public safety. All persons assembled to sow sedition, and bring into contempt the constitution, are in an unlawful assembly. Thus it was held that an attempt to hold a national convention was illegal, for it was impossible to anticipate with certainty the peaceable result of such a meeting. It is, however, somewhat difficult to define precisely what amounts to an illegal assembly, except by saying that it points to some course inconsistent with the orderly administration of the laws. It is the duty of all individual citizens to resist and oppose any unlawful assembly; but the duty rests primarily with the magistrates of the district, who are indictable for breach of duty in not taking active and immediate steps to put down riots. Thus the mayor of Bristol was indicted for not suppressing the riots at the time of the Reform Bill. The magistrates ought to call at once upon special constables to be sworn in, and if these are insufficient, to call for the aid of the military. Seditious libels are also offences against the peace, as inciting directly to a breach. Such are libels vilifying the Sovereign or the Houses of Parliament, or the courts of justice, or even a foreign sovereign, as in the case of Peltier, who was tried for a libel against the Emperor Napoleon I., the tendency of such a libel being to breed misunderstanding between our own sovereign and the foreign sovereign. A riot is the most active form of an offence against the public peace. To constitute a riot, there must be at least three persons engaged together in pursuance of an illegal purpose. Riots often originate in an attempt to redress summarily some private wrong. On such an occasion, before extreme measures are resorted to, and as a test of the good faith of those who are spectators, instead of parties, and by way of full notice to all concerned, the justices of the peace may read the Riot Act, 1 Geo. I. st. 2, c. 5, which commands all persons to disperse within one hour after a proclamation is read, otherwise they will be

guilty of felony. Persons not removing within one hour thereafter may be arrested, and carried before a justice, and committed to prison. It is, however, possible that the justices may make a mistake in thinking that to be an illegal assembly which is not so, for the mere reading of the Riot Act does not alter the character of the assembly, and accordingly if the party arrested prove at the trial that it was no illegal assembly he will be discharged. An affray is also an offence against the public peace, being a public assault, i. e., an assault committed in presence of third parties, for this is apt to lead to further breaches of the peace by others joining in it. Thus prize-fights and duels are affrays, and all present at them are principal offenders, and may be arrested by a constable and bound over to keep the peace, and punished by fine and imprisonment besides. So challenges to fight, provocations to fight, and forcibly entering into a house, are misdemeanours against the public peace.

**PEACH (*Amygdalus Persica*),** a tree much cultivated in temperate climates for its fruit; a native of Persia and the north of India; of the same genus with the ALMOND (q. v.), and distinguished by oblongo-lanceolate serrulate leaves; solitary flowers, of a delicate pink colour, appearing before the leaves; and the sarcocarp of the drupe succulent and tender, not fibrous as in the almond. This difference in the drupe has been made by some the ground of a generic distinction, but there are intermediate states, so that others have doubted if the P. and almond are even specifically distinct. The NECTARINE differs from the P. only in having a smooth fruit, whilst that of the P. is downy or velvety, and is a mere variety, probably produced and certainly preserved by cultivation. Both peaches and nectarines are divided into *freestones* and *clingstones*. In the former the flesh of the fruit parts from the stone; in the latter it adheres to it. The Freestone P. is the *Pêche* of the French, the Clingstone P. their *Pavie*; the Freestone Nectarine they call *Pêche lisse*, and the Clingstone Nectarine *Brugnon*. Of all these there are many sub-varieties, the finer ones being perpetuated by budding, which in Britain is generally on plum or almond stocks. There is a remarkable variety of Chinese origin, with the fruit compressed and flattened, and with almost evergreen leaves. The P. is much cultivated in the south of Europe, in many parts of the East, in the warmer temperate parts of North and South America, in Australia, &c., as a standard tree; in general, it is rather a small tree with a full head; in Britain, it is generally trained on walls, and in the northern parts of it on flued walls or in hot-houses, although even in Scotland excellent peaches are ripened on open walls without artificial heat. The Nectarine is rather more tender than the peach. In the extensive P. orchards of New Jersey, Pennsylvania, Maryland, and other states of North America, which sometimes contain 10,000 or 20,000 trees, the fruit is often of very inferior quality, from want of care in cultivation—the orchards being planted by simply depositing the seed in the ground; and much of the fruit is used for making a spirituous liquor called *Peach Brandy*; much of it is dried in ovens, or in drying-houses furnished with stoves, or, in the more southern states, in the sun, each fruit being divided into two parts, and the stone taken out, and when dried it is sent to market to be used for pies; the refuse of the orchards is used for feeding swine.—The P. is a very pleasant and refreshing fruit, and in a stewed form is useful in slight cases of constipation. The leaves, when fresh, have the smell and taste of bitter almonds; and by bruising them, mixing the pulp with water, and distilling, the *Peach Water* is

## PEACH-WOOD—PEACOCK.

obtained which is so much esteemed by many for flavouring articles of cookery. They have been employed as a sedative and as a vermifuge. The seeds almost entirely agree in their properties with bitter almonds; the flowers exhale an odour of bitter almonds; and both seeds and flowers are employed in the manufacture of a liqueur called *Persico*.

**PEACH-WOOD, or LIMA-WOOD**, a dye-wood imported from South America, supposed to be the produce of a species of *Cæsalpinia*, allied to that which yields the Nicaragua wood. It yields a fine peach colour, whence its name, and is now much used in muslin and calico printing and dyeing.

**PEA'COCK, or PEA FOWL (*pavo*)**, a genus of gallinaceous birds of the family *Pavonidæ*, or *Phasianidæ*, of which only two species are known, natives of the East Indies; birds of large size, and remarkable for magnificence of plumage. The bill is of moderate size, somewhat arched towards the tip; the cheeks nearly naked; the head crested; the tarsi rather long, and armed with a single spur; the wings short; the upper tail-coverts prolonged far beyond the tail, and forming a splendid train—popularly called the *tail*—which is capable of being erected and spread out into a great disk, the true tail being at the same time erected to support it. The Common P. (*P. cristatus*) has for crest a kind of

than the male bird, has no train, and is of dull plumage, mostly brownish, except that the neck is green. As in some other gallinaceous birds, the female has been known, in old age, to assume the plumage of the male. Individuals with white plumage not unfrequently occur, in which even the eye-like spots of the tail are but faintly indicated; and pied peacocks, having the deep blue of the neck and breast contrasted with pure white, are sometimes to be seen. The P. is generally supposed to have been known to the Hebrews in the time of Solomon, but it is not certain that the word commonly translated *peacocks* in the account of Solomon's importations from Tarshish (2d Chron. ix. 21) does not signify *parrots*. It is commonly stated that it first became known to the Greeks on the occasion of Alexander's expedition to India, but Aristophanes mentions it in plays written before Alexander was born. The P. became common among the Greeks and Romans; a sumptuous banquet in the latter days of Roman greatness was scarcely complete without it; and wealth and folly went to the excess of providing dishes of peacocks' tongues and peacocks' brains. Throughout the middle ages, also, a P. was often presented at the tables of the great, on great occasions, the skin with the plumage being placed around the bird after it was cooked. The P. is now common in most parts of the world; generally kept, however, except in warm countries, for ornament rather than for profit, although both the flesh and the eggs are very good. It readily partakes of all the ordinary food provided for the poultry-yard, and is fond of buds and succulent vegetables. It is hardy enough even in cold climates, except that few eggs are laid, and the young are difficult to rear, but the adult birds sit on trees or on the tops of houses, stacks, &c., during the keenest frosty nights, never, if they can avoid it, submitting to the confinement of a roosting-place, like that of the common fowl. Peacocks are found in almost all parts of India, Siam, &c., and the multitudes in which they occur in some districts are wonderful. 'About the passes in the Jungletery district,' Colonel Williamson says, in his *Oriental Field Sports*, 'whole woods were covered with their beautiful plumage, to which a rising sun imparted additional brilliancy. The small patches of plain, among the long grass, most of them cultivated, and with mustard then in bloom, which induced the birds to feed, increased the beauty of the scene; and I speak within bounds when I assert that there could not be less than 1200 or 1500 peafowls, of various sizes, within sight of the spot where I stood for near an hour.' Sir James Emerson Tennent, also, in his work on Ceylon, says that 'in some of the unfrequented portions of the eastern province, to which Europeans rarely resort, and where the peafowl are unmolested by the natives, their number is so extraordinary that, regarded as game, it ceases to be "sport" to destroy them; and their cries at early morning are so tumultuous and incessant as to banish sleep, and amount to an actual inconvenience.'—The harsh cry of the P. seems to have been imitated in its Greek name *Taōs*, and probably has given rise also to the Latin *Pavo* and the English *pea-cock*. The P., in a wild state, always roosts on trees, but makes its nest on the ground. When alarmed, as it feeds on the ground, it cannot readily take wing, and is sometimes run down by dogs or by horsemen.—The other species of P. is the JAPAN P. or JAVANESE P. (*P. Japonensis*, *Javanicus*, or *multicus*), a native of some of the south-eastern parts of Asia and neighbouring islands. It is nearly equal in size to the Common P., but of less brilliant although very similar plumage. The cheeks and around the



Peacock.

agrette of 24 upright feathers, with slender almost naked shafts and broad tip. The tail consists of 18 brown stiff feathers, and is about six inches long. The train derives much of its beauty from the loose barbs of its feathers, whilst their great number and their unequal length contribute to its gorgeousness, the upper feathers being successively shorter, so that when it is erected into a disk, the eye-like or moon-like spot at the tip of each feather is displayed. The lowest and longest feathers of the train do not terminate in such spots, but in spreading barbs, which encircle the erected disk. The blue of the neck, the green and black of the back and wings; the brown, green, violet, and gold of the tail; the arrangement of the colours, their metallic splendour, and the play of colour in changing lights, render the male P. an object of universal admiration—a sentiment in which the bird himself evidently participates to a degree that is very amusing, as he struts about to display himself to advantage, and labours to attract attention, affording a familiar proverbial image of ostentation and pride. When the disk is erected, the P. has the power of rattling the shafts of its feathers against each other in a very peculiar manner, by a strong muscular vibration. The Peahen is much smaller

eyes are yellow; the neck, and other fore parts, greenish with golden reflections. The crest is longer than that of the Common P., its feathers less equal, and webbed along their whole length.

**PEACOCK-STONE**, the name under which the dry cartilaginous ligaments of some large lamellibranchiate molluscs, as the pearl oyster, are sold by jewellers. They are used for ornamental purposes, although not so much as formerly; and far more on the continent of Europe, particularly in Portugal, than in Britain. They have opaline reflections, and are therefore sometimes called *Black Opal*.

**PEA CRAB** (*Pinnotheres*), a genus of brachyurous crustaceans, with nearly circular and not very hard carapace. They are of small size, and interesting from their living within the mantle-lobes of lamellibranchiate molluscs, a circumstance which was well known to the ancients, and gave rise to many curious fables. A species (*P. veterum*) is very common in the *pinnae* of the Mediterranean, and was imagined to render important services to its host in return for its lodging, keeping a lookout for approaching dangers, against which the blind *pinna* itself could not guard, and particularly apprising it, that it might close its shell when the cuttle-fish came near. It is curious to find this repeated by Hasselquist, in the middle of last century, as a piece of genuine natural history. Whether the P. C. lives at the expense of the mollusc, and sucks its juices, is uncertain. It is certain that the flesh of such molluscs is palatable to pea crabs, and they eat it greedily in the aquarium. The friendship of the P. C. and the *pinna* is of course as fabulous as that of the lion and jackal, or of the rattlesnake, the owl, and the prairie-dog. A species of P. C. (*P. pium*) is very common within the mantle-lobes of the Common Mussel on the British coasts. Species are found in almost all parts of the world.

**PEA MAGGOT**, the caterpillar of a small moth (*Tortrix* or *Grapholitha pisii*), which lays its eggs in young pods of peas. The caterpillar lives in the pods, and eats the peas. This moth is very common in Britain, and in wet seasons the pods of peas are often found very full of its caterpillar.

**PEAN** (Old Fr., *pannes*, furs), one of the furs borne in Heraldry, differing from Ermine only in the tinctures: the ground being sable, and the spots of gold.



Pean.

**PEA ORE**, a form of compact brown iron ore (hydrated peroxide of iron), consisting of round smooth grains, from the size of mustard-seed to that of small pease. Sometimes the grains are still smaller and flattish. This iron ore is very abundant in some places in France, and is smelted.

**PEAR** (*Pyrus communis*), a tree of the same genus with the Apple (see **PYRUS**), and like it one of the most extensively cultivated and valuable fruit-trees of temperate climates. The leaves are ovate, serrated, smooth on both surfaces, and without glands; the flowers are produced in corymbs, which may almost be called umbels, and are smaller than those of the apple; the styles are distinct and not combined at the base, as in the apple; and the fruit is hemispherical at one end, tapering gradually away, more or less rapidly, to a point at the other. The pear-tree grows wild in woods and copses in Britain, on the continent of Europe, and throughout the temperate parts of Asia. In its

wild state it is usually either a large shrub or a small tree, thorny, and with small austere fruit. In cultivation it is without thorns, becomes a tree of 40 or 50 feet high, sometimes more; and its stem attains a diameter of three feet. Cultivation has wrought even greater changes in the size and quality of its fruit. The pear has been cultivated from remote antiquity. Its cultivation was probably introduced into Britain by the Romans. The cultivated varieties are extremely numerous; and many new ones of great excellence have recently been produced. The *Jargonelle Pear* may be mentioned as one of the most esteemed of the varieties long known in Britain. Some of the kinds called *Bergamot* and *Beurré* are highly esteemed. Many new kinds have recently been introduced into Britain from France and Belgium. The varieties of pear differ much in hardness and in fitness for particular soils; although a deep, moderately strong, dry, loamy soil is the best for this fruit. The finer varieties are cultivated in Britain as wall-trees. Pears succeed well as espaliers. They are generally grafted on seedling stocks of the wild pear, but sometimes on the rowan, and sometimes on the quince. Pears grafted on quince stocks are the best for shallow soils. The flowers and fruit of the pear are mostly produced on spurs, which spring from branches of more than one year old. Various modes of training and pruning are practised for pear-trees. Among the varieties of pears are some which ripen early in autumn, and some which do not ripen till the beginning of winter, and which even require to be mellowed by keeping for a short time; whilst some of the kinds cannot easily be kept for more than a few days. In general, pears cannot be kept so long nor so easily as apples. Pears are sometimes made into a preserve with syrup; and sometimes cut into pieces, and dried in the sun or in an oven, to be afterwards used in pie, a practice very prevalent in France.—A very agreeable fermented liquor called *Perry* is made from pears, in the same manner as Cider from apples; and pear orchards for this purpose are to be seen in some parts of England, especially in Worcestershire and Herefordshire. The varieties of pear cultivated for making perry are all rather austere, and those which yield the best perry are far too austere to be palatable.—The wood of the pear-tree is reddish, very hard, fine-grained, and valuable to turners and joiners. It is often dyed black in imitation of ebony, which it then greatly resembles.

Besides the varieties of pear usually referred to *Pyrus communis*, some are occasionally cultivated which are generally regarded as distinct species. Such are the **AURELIAN PEAR** (*P. salviifolia*), a native of France, with leaves much narrower than the common pear, and a long fruit, which is used for making perry; the **SNOWY PEAR** (*P. nivalis*), a native of the Alps of Austria, with oval obtuse leaves, white and silky beneath, and a globose fruit, which is very acid till it becomes quite ripe, or is beginning to decay, when it is very sweet; the **SAND PEAR** (*P. Sinensis*), a native of China and Cochin-China, with heart-shaped, shining, almost evergreen leaves, and apple-shaped warted fruit, very gritty, and fit only for baking, cultivated in gardens in India, but hardly in Britain. The **PASHIA** (*P. pashia* or *P. variolosa*) is a native of the Himalaya; the fruit of which is only edible when blotted or partially decayed. The **PALTOO** (*P. lanata*) is another Himalayan species with edible fruit. Both are quite hardy in Britain.

**PEAR, PRICKLY.** See **PRICKLY PEAR**.

**PEARL**, a peculiar product of certain marine and fresh-water molluscs or shell-fish. Most of the

## PEARL

molluscan animals which are aquatic and reside in shells are provided with a fluid secretion with which they line their shells, and give to the otherwise harsh granular material, of which the shell is formed, a beautifully smooth surface, which prevents any unpleasant friction upon the extremely tender body of the animal. This secretion is evidently laid in extremely thin semi-transparent films, which, in consequence of such an arrangement, have generally a beautiful iridescence, and form in some species a sufficient thickness to be cut into useful and ornamental articles. The material itself in its hardened condition is called *nacre* by zoologists, and by dealers Mother-of-pearl (q. v.). Besides the pearly lining of the shells, detached and generally spherical or rounded portions of the nacre are often found on opening the shells, and there is great reason to suppose these are the result of accidental causes, such as the intrusion of a grain of sand or other substance, which, by irritating the tender body of the animal, obliges it in self-defence to cover the cause of offence, which it has no power to remove; and as the secretion goes on regularly to supply the growth and wear of the shell, the included body constantly gets its share, and thereby continues to increase in size until it becomes a pearl. The Chinese avail themselves of the knowledge of this fact to compel one species of freshwater mussel, *Unio Hyria*, to produce pearls. In order to do this, they keep the Unios in tanks, and insert between the shell and the mantle of the animal either small leaden shot or little spherical pieces of mother-of-pearl. These are sure to receive regular coatings of the nacreous secretion; and after a time look like pearls formed under ordinary circumstances. These curious people also practise another trick upon these animals; they insert small images of the Buddha stamped out of metal, which soon become coated with the pearl-secretion, and are cemented by it to the shells; to those ignorant of its origin, the phenomenon is a supernatural testimony to the truth of Buddhism. Examples of these curiosities are to be found in many of our museums.

A plan of making pearls was suggested to the Swedish government by Linnaeus. It consisted in boring a small hole through the shell of the river mussel, and inserting a grain of sand, so as to afford a nucleus for a pearl. The plan at first succeeded sufficiently well to prove its practicability, and he was rewarded by a sum of money (£450), but it failed as a profitable speculation, and was abandoned.

The exact nature of the secretion has never been satisfactorily determined; it is, however, ascertained that it is deposited in thin films, which overlie each

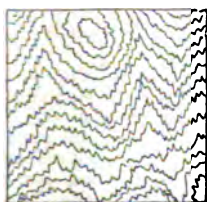

Fig. 1.

other so irregularly, that their sharply serrated edges, when magnified, present the appearance represented in fig. 1; and to this peculiar disposition of the plates, the beautiful iridescence of common pearls is attributed. Their formation was a great puzzle to the ancients, amongst whom they were very highly prized. Dioscorides and Pliny mention the

belief that they were drops of dew or rain which fell into the shells when opened by the animal, and were then altered by some power of the animal into pearls. This opinion, which obtained all over the east, is thus charmingly alluded to by Moore:

‘And precious the tear as that rain from the sky,  
Which turns into pearls as it falls in the sea.’

The most famous pearls are those from the east; the

coast of Ceylon, or Taprobane as it was called by the Greeks, having from the earliest times been the chief locality for pearl fishing. They are, however, obtained now of nearly the same quality in other parts of the world, as Panama in South America, St Margarita in the West Indies, the Coromandel Coast, the shores of the Sooloo Islands, the Bahrein Islands, and the islands of Karak and Corgo in the Persian Gulf. The pearls of the Bahrein fishery are said to be even finer than those of Ceylon, and they form an important part of the trade of Bassora. These, and indeed all the foreign pearls used in jewellery, are produced by the Pearl Oyster (q. v.). The shells of the molluscs which yield the Ceylon,



Fig. 2.

Indian, and Persian ones, are sometimes as much as a foot, in diameter, and are usually about nine inches. Those of the New World, although the shells are smaller and thicker, are believed to be the same species. The chief locality of the Ceylon pearl fishery is a bank about 20 miles long, 10 or 12 miles from shore, opposite to the villages of Condatchy and Aripo on the northern coast. The season of the fishery lasts about three months, commencing at the beginning of February, and is carried on under government regulations. The boats employed are open, and vary in size from 10 to 15 tons burden; they put out at night, usually at 10 o'clock, on a signal gun being fired from the fort of Aripo, and make for the government guard vessel, which is moored on the bank, and serves the double purpose of a guard and a light-ship. The divers are under the direction of a manager, who is called the Adapanaar, and they are chiefly Tamils and Moors from India. For each diver there is provided a diving-stone, weighing about 30 pounds, which is fastened to the end of a rope long enough to reach the bottom, and having a loop made for the man's foot; and in addition to this, a large network basket, in which to place the pearl oysters as he collects them. These are hung over the sides of the boat; and the diver, placing his foot in the loop attached to the stone, liberates the coils of the rope, and with his net-basket rapidly descends to the bottom. To each boat there is usually allotted a crew of 13 men and 10 divers, 5 of whom are descending whilst the others are resting. This work is done very rapidly; for, notwithstanding the stories to the contrary, the best divers cannot remain longer than 80 seconds below, and few are able to exceed 60. The greatest depth they descend is 13 fathoms, and the usual depth about 9 fathoms. When the diver gives the signal by pulling the rope, he is quickly hauled up with his net and its contents. Accidents rarely happen; and as the men are very superstitious, their safety is attributed to the incantations of their shark-charmers, performed at the commencement of the fishing. Sir E. Tenent, however, attributes the rarity of accidents from sharks, usually so abundant in tropical seas, to the bustle and to the excitement of the waters during

## PEARL

the fishery frightening away those dreaded creatures. The divers are sometimes paid fixed wages, others agree for one-fourth of the produce. When a boat-load of oysters has been obtained, it returns to shore, and the cargo, sometimes amounting to 20,000 or 30,000, is landed and piled on the shore to die and putrefy, in order that the pearls may be easily found. The heaps are formed in small walled compartments, the walls surrounding each being about one or two feet in height. Several of these compartments surround a small central enclosure, in which is a bath, and they slope towards this bath, and are each connected with it by a small channel, so that any pearls washed out from the putrefying mass by the rain may be carried into the bath. When the animals in the shells are sufficiently decomposed, the washing commences, and great care is taken to watch for the loose pearls, which are always by far the most valuable; the shells are then examined, and if any attached pearls are seen, they are handed over to the clippers, who, with pinchers or hammer, skilfully remove them. Such pearls are used only for setting; whilst the former, being usually quite round, are drilled and strung, and can be used for beads, &c. The workmen who are employed to drill the pearls also round the irregular ones, and polish them with great skill. The method of holding the pearls during these operations is very curious; they make a number of holes of small depth in a piece of dry wood, and into these they fit the pearls, so that they are only partly below the surface of the wood, which they then place in water. As it soaks up the water and swells, the pearls become tightly fixed, and are then perforated, &c. These operations are all carried on on the spot.

For many miles along the Condatchy shore, the accumulation of shells is enormous, and averages at least four feet in thickness. This is not to be wondered at, when it is remembered that this fishery has been in active operation for at least 2000 years. The place itself is exceedingly barren and dreary, and, except during the fishing season, is almost deserted; but at that time it presents an exceedingly animated spectacle; thousands of people, of various countries and castes, are here drawn together—some for the fishery, others to buy pearls, and others to feed the multitude. They chiefly reside in tents, so that it appears a vast encampment.

The pearls vary much in size; those as large as a pea, and of good colour and form, are the best, except unusually large specimens, which rarely occur, the most extraordinary one known being the pearl owned by the late Mr Hope, which measured two inches in length, and four in circumference, and weighed 1800 grains. The smaller ones are sorted into sizes, the very smallest being called seed-pearls. A considerable quantity of these last are sent to China, where they are said to be calcined, and used in Chinese pharmacy. Amongst the Romans, the pearl was a great favourite, and enormous prices were paid for fine ones. One author gives the value of a string of pearls at 1,000,000 sesterces, or about £8000 sterling. The single pearl which Cleopatra is said to have dissolved and swallowed was valued at £80,729; and one of the same value was cut into two pieces for earrings for the statue of Venus in the Pantheon at Rome. Coming down to later times, we read of a pearl, in Queen Elizabeth's reign, belonging to Sir Thomas Gresham, which was valued at £15,000, and which he is said to have treated after the fashion of Cleopatra; for he powdered it and drank it in a glass of wine to the health of the Queen, in order to astonish the ambassador of Spain, with whom he had laid a wager that he would give a more costly dinner than could the Spaniard.

During the occupation of Britain by the Romans this country became famous for its pearls, which were found in the freshwater mussel of our rivers. See FRESHWATER MUSSEL. Generally the pearls of this mollusc are small, badly coloured, and often valueless; but occasionally they occur of such beauty as to rival those of the pearl oyster. At present, in the Scotch rivers, the search for pearls is prosecuted vigorously and successfully, especially by a merchant, named Unger, of Edinburgh, who has brought Scotch pearls into great repute. He has collected specimens ranging from £5 to £90 each, and formed a necklace worth £350. In Scotch pearls of the highest quality, there is a pleasing pinkish tint, which is very permanent. The fishing for pearl mussels is by no means so dangerous or troublesome as for pearl oysters; usually they are found in the beds of streams, shallow enough to wade in, and so clear that they can be seen at the bottom. If too deep to remove with the hand, they are easily captured by putting a stick between their gaping shells, which instantly close upon it, and can be drawn out with it. So profitable is this pursuit becoming, that a great many persons are now engaged in it.

Very fine river pearls, known on the continent as Bohemian pearls, are found in the rivers Moldau and Wottawa. There is also a fresh-water pearl fishery in Bavaria, where the river Iltz yields at times very fine specimens. Even the most inferior pearls have a market value; for pearls can only be properly polished with pearl dust, and the inferior pearls are powdered for the purpose of polishing and rounding the finer ones.

*False pearls* are very admirable imitations, made by blowing very thin beads or bulbs of glass, and pouring into them a mixture of liquid ammonia, and the white matter from the scales of the Bleak, and sometimes of the Rosch, and Dace. The proper way to prepare the pearl-matter is first to remove the scales of the lower part of the fish; these must then be very carefully washed, after which they are put to soak in water, when the pearly film falls off and forms a sediment at the bottom of the vessel, which is removed and placed in liquid ammonia for future use. This pearl mixture, when of the best quality, is very costly, being as much as £4 or £5 per ounce. For use, it is diluted with ammonia, and injected into the glass beads, so as to thinly coat them inside; afterwards the better kinds have melted white wax poured in, which renders them much more durable. The French and Germans produce in this way imitations of the finest oriental pearls of such beauty, that the most practised eye can hardly detect the difference. The bleak is procured in considerable quantities for this purpose from the Thames and other rivers in England. See BLEAK.

The invention of artificial pearls is due to a Frenchman, named Jaquin, in the time of Catharine de Medicis, and the manufacture is now chiefly carried on in the department of the Seine, where great improvements have lately been made, especially in the art of giving the irregular forms of large pearls to the glass-bulbs, and thus increasing the resemblance, and in removing the glassy appearance caused by the exterior glass coating, by exposing it for a short period to the action of the vapour of hydrofluoric acid. Mucilage of fine gum-arabic is also used instead of wax, which increases the translucency, gives greater weight, and is not liable to melt with the heat of the wearer's body—a defect to which those filled with wax are very liable.

*Roman pearls* differ from other artificial pearls, by having the coating of pearly matter on the

outside, to which it is attached by an adhesive substance. The art of making these was derived from the Chinese.

**PEARL**, a river of Mississippi, U.S., which rises about 100 miles north-north-east of Jackson, and, flowing south through the state, separates it in its lower course from Louisiana, and empties into Mississippi Sound, near the outlet of Lake Pontchartrain. It flows nearly 300 miles through a fertile cotton country, and is navigable to Jackson, the capital.

**PEARL ASHES.** See **POTASH.**

**PEARL BARLEY.** See **BARLEY.**

**PEARL OYSTER** (*Avicula* or *Meleagrina margaritifera*), a lamellibranchiate mollusc, of the family *Aviculidae*, generally found—great numbers together—attached to submarine rocks at a considerable depth on the coasts of tropical countries, and important as producing almost all the pearls and all the mother-of-pearl of commerce. It is sometimes called the **PEARL MUSSEL**; but the family to which it belongs differs considerably both from that of mussels and from that of oysters, the valves of the shell being unequal, the hinge-line straight and long, and the animal furnished with two adductor muscles, one of them small, and with a foot by which it produces a byssus. The P. O. is of an oblique oval form, longitudinally ribbed, and with concentric foliations when young which disappear when it is old. It attains a large size, and there are several varieties, the most important of which are noticed in the article **MOTHER-OF-PEARL**. The whole inside of the shell is covered with a thick layer of nacre or mother-of-pearl, compact and beautiful, forming indeed the chief part of the shell, and exhibiting very considerable variety of colour, most frequently white, but sometimes blood-red. Pearls are formed of the same substance (see **PEARL**), and are generally, if not always, produced by eggs which have become abortive, and which remain lodged within the mollusc instead of being ejected into the sea.

The P. O. is too rank and coarse to be eaten. When taken from the sea it is commonly laid out in the sun to die, that the pearls may be sought for after the shell opens.

The P. O. is not the only mollusc which produces pearls. The *Placuna placenta*—an oyster (family *Ostrea*) with thin transparent shell, which is used in China and elsewhere as a substitute for window glass—produces diminutive pearls. The Fresh-water Mussel (q. v.) of Britain produces pearls sometimes of considerable beauty and value; and instances have occurred of pearls being found in pinnæ, &c., and even in limpets.

**PEARL SHELLS.** See **MOTHER-OF-PEARL.**

**PEARL WHITE.** See **WHITE COLOURS.**

**PEARSON, JOHN**, an English prelate of high celebrity, was born in 1612 at Snoring, in Norfolk, of which place his father was rector, educated at Eton and King's College, Cambridge, where he took the degree of M.A. in 1639, and in the same year took orders, and was collated to a prebend in Salisbury Cathedral. In 1640 he was appointed chaplain to Finch, lord-keeper of the great seal, and on the outbreak of the civil war became chaplain to Lord Goring, and afterwards to Sir Robert Cook, in London. In 1650, he was appointed minister of St Clement's, Eastcheap, London; and in 1659, published the great work by which he is now remembered, *An Exposition of the Creed*. It was dedicated to his flock, to whom the substance of it had been preached some years before in a series of discourses. The laborious learning and the judicial calmness displayed by the author in this treatise have long been acknowledged, and command the

respect even of those who think his elaborate argumentation tedious and not always forcible. It is generally reckoned one of the ablest works produced in the greatest age of English theology—the 17th century. During the same year, P. published *The Golden Remains of the Ever Memorable Mr John Hales of Eton*. At the Restoration, honours and emoluments were lavishly showered upon him. Before the close of 1660 he received the rectory of St Christopher's, in London; was created D.D. at Cambridge; installed Prebendary of Ely and Archdeacon of Surrey; and made Master of Jesus College, Cambridge. In 1661, he obtained the Margaret professorship of Divinity, and was one of the most prominent commissioners in the famous Savoy conference; in 1662, he was made Master of Trinity, Cambridge, and in 1673, was promoted to the bishopric of Chester. The year before he had published his *Vindicia Epistoliarum S. Ignatii*, in answer to M. Daillé, who had denied the genuineness of the epistles. It was imagined for years that P. had triumphed over his opponent. The history of the controversy, however (see **IGNATIUS**), has shewn that Daillé was right and P. wrong. In 1684, appeared his *Annales Cypriani*. He died July 16, 1686. P.'s *Opera Posthuma Chronologica* were published by Dodwell (Lond. 1688), and his *Orationes, Conciones et Determinationes Theologicae* contain much valuable matter, for, as Bentley used to say, P.'s 'very dross was gold.' Bishop Burnet thought him 'in all respects the greatest divine of his age.'

**PEASANT WAR**, in German history, the name given to that great insurrection of the peasantry which broke out in the beginning of the year 1525, and which Zschokke has described as the 'terrible scream of oppressed humanity.' The oppression of the peasants had gradually increased in severity, as the nobility became more extravagant and the clergy more sensual and degenerate. The example of Switzerland encouraged the hope of success, and from 1476 to 1517 there were risings here and there amongst the peasants of the south of Germany. A peasant rebellion, called from its cognizance, the *Bundschuh* (Laced Shoe), took place in the Rhine countries in 1502, and another, called the 'League of Poor Conrad,' in Würtemberg, in 1514, both of which were put down without any abatement of the grievances which occasioned them. The Reformation, by the mental awakening which it produced, and the diffusion of sentiments favourable to freedom, must be reckoned amongst the causes of the great insurrection itself; although Luther, Melancthon, and the other leading reformers, whilst urging the nobles to justice and humanity, strongly reprobated the violent proceedings of the peasants. The Anabaptists, however, and in particular Münzer, encouraged and excited them, and a peasant insurrection took place in the Hegau in 1522. Another, known as the 'Latin War,' arose in 1523 in Salzburg, against an unpopular archbishop, but these were quickly suppressed. On January 1, 1525, the peasantry of the abbacy of Kempten, along with the townspeople, suddenly assailed and plundered the convent, compelling the abbot to sign a renunciation of his rights. This proved the signal for a rising of the peasants on all sides throughout the south of Germany. Many of the princes and nobles at first regarded the insurrection with some measure of complacency, because it was directed in the first instance chiefly against the ecclesiastical lords; some, too, because it seemed likely to promote the interests of the exiled Duke of Würtemberg, who was then upon the point of reconquering his dominions by the help of Swiss troops; and others,



because it seemed to set bounds to the increase of Austrian power. But the Archduke Ferdinand hastened to raise an army, the troops of the empire being for the most part engaged in the emperor's wars in Italy, and intrusted the command of it to the Truchsess Von Waldburg, a man of stern and unscrupulous character, but of ability and energy. Von Waldburg negotiated with the peasants in order to gain time, and defeated and destroyed some large bodies of them, but was himself defeated by them on the 22d of April, when he made a treaty with them, not having, however, the slightest intention of keeping it. Meanwhile the insurrection extended, and became general throughout Germany, and a number of towns took part in it, as Heilbronn, Mühlhausen, Fulda, Frankfurt, &c., but there was a total want of organisation and co-operation. Towards Easter, 1525, there appeared in Upper Swabia a manifesto, which set forth the grievances and demands of the insurgents. They demanded the free election of their parish clergy; the appropriation of the tithes of grain, after competent maintenance of the parish clergy, to the support of the poor and to purposes of general utility; the abolition of serfdom, and of the exclusive hunting and fishing rights of the nobles; the restoration to the community of forests, fields, and meadows, which the secular and ecclesiastical lords had appropriated to themselves; release from arbitrary augmentation and multiplication of services, duties, and rents; the equal administration of justice; and the abolition of some of the most odious exactions of the clergy. The conduct of the insurgents was not, however, in accordance with the moderation of their demands. Their many separate bands destroyed convents and castles, murdered, pillaged, and were guilty of the greatest excesses, which must indeed be regarded as partly in revenge for the cruelty practised against them by Von Waldburg. A number of princes and knights concluded treaties with the peasants conceding their principal demands. The city of Würzburg joined them, but the Castle of Leibrauenberg made an obstinate resistance, which gave time to Von Waldburg and their other enemies to collect and strengthen their forces. In May and June 1525, the peasants sustained a number of severe defeats, in which large bodies of them were destroyed. The Landgraf Philip of Hesse was also successful against them in the north of Germany. The peasants, after they had been subjugated, were everywhere treated with terrible cruelty. In one instance a great body of them were perfidiously massacred after they had laid down their arms. Multitudes were hanged in the streets, and many were put to death with the greatest tortures. Weinsberg, Rothenburg, Würzburg, and other towns which had joined them, suffered the terrible revenge of the victors, and torrents of blood were shed. It is supposed that more than 150,000 persons lost their lives in the Peasant War. Flourishing and populous districts were desolated. The lot of the defeated insurgents became harder than ever, and many burdens of the peasantry originated at this period. The cause of the Reformation also was very injuriously affected. See Sartorius, *Versuch einer Geschichte des Deutschen Bauernkriegs* (Berl. 1795); Oehale, *Beiträge zur Geschichte des Deutschen Bauernkriegs* (Heilbronn, 1829); Wachsmuth, *Der Deutsche Bauernkrieg* (Leip. 1834); and Zimmermann, *Allgemeine Geschichte des grossen Bauernkriegs* (3 vols., Stuttg. 1841—1843).

**PEA-STONE, PISOLITE, or PISIFORM LIMESTONE**, is a kind of calcareous spar or limestone, which occurs in globules from one-eighth of an inch to half an inch in diameter, imbedded in a cement of similar substance. There is generally

a grain of sand in the centre of each globule as the nucleus, around which it has been formed, and the concentric plates of its structure are easily visible. Sometimes the nucleus is merely a bubble of air. P. is found in great masses near the hot springs of Carlsbad, in Bohemia. It is sometimes used for ornamental purposes.

**PEAT**, a substance formed by the decomposition of plants amidst much moisture, as in marshes and morasses; and sometimes described as a kind of *Humus* (q. v.), formed by the accumulation of the remains of mosses and other marsh-plants. The remains of the plants are often so well preserved in it, that the species can be easily distinguished. Reeds, rushes, and other aquatic plants may usually be traced in peat, and stems of heath are often abundant in it; but it chiefly consists, in the northern parts of the world, of different species of *Sphagnum* (q. v.), or Bog-moss. Mosses of this genus grow in very wet situations, and throw out new shoots in their upper parts, whilst their lower parts are decaying and being converted into peat; so that shallow pools are gradually changed into bogs. It was at one time believed that bogs owed their origin to the destruction of forests, the fallen trees impeding the natural drainage, and causing the growth of those marsh-plants of which peat is formed; and this theory was supported by reference to instances supposed to be authenticated by tradition—as that of the moor of Hatfield in Yorkshire, now consisting of about 12,000 acres of peat, and said to have been a forest of firs, till 'the Romans under Ostorius, having slain many Britons, drove the rest into the forest, which was then destroyed by the victors. There are, however, satisfactory proofs that peat has accumulated in many places around trees; and firs remaining in their natural position have been found to have six or seven feet of peat under their roots, although other trees, as oaks, are commonly found with their stumps resting on the soil beneath the peat. Yet it is not improbable that the destruction of forests may, in some instances, by impeding the course of the streams which flowed through them, have caused the stagnation of water from which the growth of peat resulted. Some of the largest mosses and fens of Europe occupy the place of forests, which were destroyed by order of Severus and other Roman emperors; and some of the British forests, now mosses, as well as some of those of Ireland, were cut because they harboured wolves or outlaws. The overthrow of a forest by a storm in the 17th c. is known to have caused the formation of a *peat-moss* near Loch Broom, in Ross-shire. Layers of trees are not unfrequently found in peat, which seem to have been suddenly deposited in their horizontal position, and sometimes to have been felled by human hands. It is not improbable, however, that sometimes peat has been formed where the soil has been exhausted by the long-continued growth of one kind of tree. The growth of peat is often rapid: bogs have been known to increase two inches in depth in a year. The surface of a bog sometimes becomes a floating mass of long interlaced fibres of plants, known in Ireland as *Old Wives' Tow*. The vegetation on the surface is sometimes very green and compact, like a beautiful turf.

Peat is vegetable matter more or less decomposed, and passes by insensible degrees into Lignite (q. v.). The less-perfectly decomposed peat is generally of a brown colour; that which is more perfectly decomposed is often nearly black. Moist peat possesses a decided and powerful antiseptic property, which is attributed to the presence of gallic acid and tannin, and is manifested not only in the perfect preservation of ancient trees and of leaves, fruits, &c., but sometimes even of animal bodies. Thus, in some

instances, human bodies have been found perfectly preserved in peat, after the lapse of centuries.

The formation of peat may be regarded as one of the most important geological changes now in evident progress. It takes place, however, only in the colder parts of the world. In warm regions, the decay of vegetable substances, after life has ceased, is too rapid to permit the formation of peat. The surface covered by peat is very extensive in all the colder parts of the world; although in the southern hemisphere no moss seems to enter into its composition; and the South American peat is said by Mr Darwin to be formed of many plants, but chiefly of *Astelia pumila*, a phanerogamous plant of the rush family. The surface covered by peat even in England is considerable; it is greater in Scotland, and very great in Ireland. Extensive tracts are covered with peat even in the southern countries of Europe, and sometimes even near the sea; and in more northern regions, the *mosses* or *bogs* are still more extensive. For their physical characters, and the mode of reclaiming them, or converting them into arable land, see Bog.

Mere peat is not a good soil, even when sufficiently drained, but, by the application of lime, marl, &c., it is soon converted into good soil, yielding excellent crops. A mixture of peat is often of benefit to soils otherwise poor. And for many shrubs, as rhododendrons, kalmias, whortleberries, &c., no soil is so suitable as one in great part composed of peat; which is therefore in much request with gardeners in order to the formation of the soil for certain kinds of plants.

Peat is extensively used for fuel. The more perfectly decomposed that the vegetable matter is, and the more consolidated that the peat therefore is, the better is it suited for this use. It is the ordinary fuel of great part of Ireland, and is there almost always called *turf*, although the term *turf*, in its ordinary English sense, is utterly inapplicable to it. To procure peat for fuel, the portion of bog to be operated upon must first be partially dried by a wide open drain; its surface is then pared off with the spade, to the depth of about six inches, to remove the coarse undecomposed vegetable matter; the peat is afterwards cut out in pieces (*peats*) like bricks, by means chiefly of a peculiar implement, called in Ireland a *slane*, and in Scotland a *peat-spade*, resembling a long, narrow, sharp spade, the blade of which is furnished on one side with a tongue set at a right angle to it. This implement is used by the hands alone, without pressure of the foot. The soft peats are conveyed to some neighbouring place, where they are set up on end in little clusters to dry. When sufficiently dry, they are conveyed away, and may be piled in outhouses or stacked in the open air. The operation of *peat-cutting* is always performed in spring or summer.—Where peat for fuel cannot be obtained in the way just described, the black mud of a semi-fluid bog is sometimes worked by the feet of a party of men, women, and children until it acquires such a consistency that it can be moulded by the hand. The process is laborious, but the fuel obtained by it is good.—In countries depending on peat for fuel, a very rainy season sometimes occasions great inconvenience, and even distress, by preventing the cutting and drying of the peat.

Peat is a light and bulky kind of fuel, and cannot be conveyed to considerable distances without too great expense. Efforts have, however, been made, both in Scotland and Ireland, to render it more generally useful, and so to promote the reclaiming of bogs, by compressing it until its specific gravity is nearly equal to that of coal. For this purpose, it is first reduced to a pulp. The compressing of peat

has not yet been advantageously prosecuted on an extensive scale.

Peat-charcoal, made from uncompressed peat, is very light and inflammable, and therefore unsuitable for many purposes, but for others it is particularly adapted, and no kind of charcoal excels it in antiseptic and deodorising properties. It is also an excellent manure for many kinds of soil, and great crops have often been obtained by its use. Peat-charcoal is highly esteemed for the smelting of iron, and for working and tempering the finer kinds of cutlery. Charcoal made from compressed peat is in density superior to wood-charcoal, and is capable of being used as coke. The Irish Amelioration Society, some years ago, encouraged the conversion of peat into charcoal, but it seems not to have paid as a commercial speculation, although the resulting charcoal was of good quality. Various companies have been formed for the purpose of obtaining valuable products from the destructive distillation of peat. It appears from researches of Sir R. Kane and others, that 1000 parts of peat yield about 11 of sulphate of ammonia, 7 of acetate of lime, 2 of wood naphtha, 1 of paraffin, 7 of fixed oil, and 3 of volatile oil. The manufacture has not, however, as yet proved sufficiently profitable to be generally adopted, although the distillation of peat has, we believe, been carried on for some years at Athy, near Kildare. For further details on this subject, the reader is referred to a parliamentary *Report on the Nature and Products of the Destructive Distillation of Peat*, published in 1851, and to a paper by Dr Paul in the 6th volume of *The Chemical News*.

Flower-pots are sometimes made of peat, and might perhaps with advantage be more extensively used than they have yet been. It is easy to transplant flowers growing in them without loosening the earth from the roots, the pot being readily cut to pieces; and liquid manure applied outside such a flower-pot finds its way sufficiently to the roots of the plant.

PEA WEEVIL (*Sitona crinita* and *S. lineata*), small coleopterous insects, about a quarter of an inch long, which are very destructive to crops of peas and other kinds of pulse, devouring the leaves and other succulent parts, often soon after the plants appear above ground. Lime, soot, or wood ashes dusted over the plants, protect them in some measure from the ravages of these insects; and hoeing or other stirring of the soil is beneficial, probably by destroying the eggs, larvæ, and pupæ.

PEBBLE (probably allied to *bubble*, from the sound of water running among stones), a small, round, water-worn stone of any kind; but with jewellers sometimes an agate—agate being often found as loose pebbles in streams, and those of Scotland in particular being popularly designated *Scotch Pebbles*. Hence the name has come even to be extended to rock-crystal, when not in the crystalline form, and we hear of spectacles with eyes of pebble, &c. Deposits of pebbles (in the sense of water-worn stones), occur among the rocks of all periods, but the pebbles are seldom loose; they are generally cemented together by iron, lime, or silex, forming a pudding-stone of greater or less hardness. Single pebbles are sometimes found in deposits which have been formed at a distance from currents in perfectly still water, as in chalk and fine silt. They must have been floated to their places entangled in the roots of trees, or attached to the roots of large buoyant sea-weeds.—BRAZILIAN PEBBLES (so called from Brazil having been long famous for the purity of its rock crystal), are very pure pieces of Rock Crystal (q. v.), used by opticians for making the lenses of spectacles, &c.

PECCARY—PECTORILOQUY.

**PECCARY** (*Dicotyles*), a genus of *Pachydermata*, of the family *Suidæ*, much resembling hogs; but having a mere tubercle instead of a tail; only three toes—no external toe—on the hind-foot; the molar teeth and incisors very like those of hogs, but the canine teeth not nearly so long, and not curving



Peccary (*Dicotyles torquatus*).

outwards. An approach to ruminants is seen in the stomach, which is divided into several sacs; also in the union of the metacarpal and metatarsal bones of the two greater toes into a kind of cannon bone. A glandular opening on the loins, near the tail, secretes a fetid humour. Only two species are known, both natives of South America, and except the tapirs, the only existing pachydermata of the American continent.—The COMMON P., COLLARED P., or TAJAQU (*D. torquatus*), is found in almost all parts of South America; the WHITE-LIPPED P. (*D. labiatus*) is found in many parts of it. Both are gregarious; the White-lipped P., often assembling in very large herds, and sometimes doing great mischief to maize and other crops. The herds of the White-lipped P. seem to follow a leader, like those of ruminants. The Common P. chiefly frequents forests, and small companies sometimes take up their abode in the hollow of a great tree. The Common P. is about the size of a small hog, grayish; the hairs alternately ringed with black and yellowish white, bristly; and on the neck longer, and forming a mane. A narrow white collar surrounds the neck. The White-lipped P. is considerably larger, of a darker colour, with conspicuously white lips. The ears are almost concealed by the hair. Both species are capable of being tamed, but are of irritable and uncertain temper. In a wild state they defend themselves vigorously against assailants, making good use of their sharp tusks, and a whole herd combine for defence. The hunter has often to take refuge from them in a tree. They are omnivorous; and if hurtful to crops, render service by destroying reptiles. Their voice is somewhat like that of the hog, but more sharp. Their flesh resembles that of the hog, but is said to be inferior. The glands on the loins must be cut out immediately after the P. is killed, or their fetid humour infects the whole flesh. No attempts seem yet to have been made for the economic domestication of the peccaries.

**PE-CHIH-LE'**. See CHIH-LE.

**PECK**, a measure of capacity for dry goods, such as grain, fruit, &c., used in Britain, and equivalent to 2 imperial gallons, or 554.548 cubic inches. It is thus the fourth part of a Bushel (q. v.). The old Scotch peck, the 16th part of a boll, when of wheat, was slightly less than the imperial peck; but when of barley, was equal to about 1.456 of it.

**PECORA** (Lat. cattle), a Linnæan order of Mammalia, now generally called RUMINANTIA (q. v.).

**PECOS**, a river of Texas, U.S., rises in the mountains near Santa Fé, New Mexico, runs south-

easterly 600 miles through New Mexico and Texas, and flows into the Rio Grande-del-Norte, in lat. about 29° 20' N., long. 102° W.

**PECTEN**, a genus of lamellibranchiate mollusca, commonly referred to the same family with the oyster (*Ostrea*), which is sometimes called *Pectinida*. The shell has neither teeth nor laminae in the hinge; the valves are unequal, one of them being often much more convex than the other; the shape is regular; the hinge is extended by *ears*, and in most of the species both valves have ribs radiating from the umbo to the margin. Hence the name *pecten* (Lat. a comb), from the appearance which they present. The animal has a small foot; some of the species are capable of attaching themselves by a byssus; they are capable also of locomotion by opening and rapidly closing the valves, and in this way can even regain the sea from a short distance by leaping on the shore. Some of the larger species are often popularly called *clams*, a name shared by other bivalves. *P. Jacobæus*, a native of the Mediterranean, is the SCALLOP-SHELL which pilgrims were accustomed to wear in front of their hat, in token of their having visited the shrine of St James at Compostella. It attains a size of about 4 inches long and 5 inches broad. *P. maximus*, found on many parts of the British coasts, is about 6 inches broad. It is sometimes eaten, but is hard and indigestible. Several other species are British. Species are found in almost all parts of the world.



Pecten.

**PECTIC ACID AND PECTINE**. See FRUIT.

**PECTINIBRANCHIATA** (Lat. comb-gilled), an order of gasteropodous mollusca, having the gills composed of numerous leaflets or fringes, arranged like the teeth of a comb, and affixed to the internal surface of a cavity which opens with a wide opening above the head. The sexes are distinct. All the P. have two tentacles and two eyes, the eyes often stalked. The mouth is produced into a proboscis, more or less lengthened. The eggs are deposited in a mass, with an envelope often of very remarkable and complicated form, which is produced by coagulation of a viscous albuminous matter secreted by a peculiar gland of the female. The P. are very numerous; the greater number of gasteropods being included in this order; some have a siphon, and some are destitute of it; some have spiral, and some have simply conical shells. Almost all are inhabitants of the sea or its shores; a few are found in fresh water. To this order belong *Whelks*, *Periwinkles*, *Cones*, *Volutes*, *Calyptrae*, &c.

**PECTORILOQUY** is a term of such frequent occurrence in the history of chest diseases as to require a brief notice in this work. If the stethoscope be applied to the chest of a healthy person, and he be requested to speak, the sounds of his voice will be conveyed to the ear of the observer with very different degrees of clearness, according to the part of the chest on which the base of the instrument rests. If, for example, it be applied at the top of the sternum or breast-bone the voice will reach the ear, through the tube, with tolerable distinctness. For a short distance on either side of the sternum, just below the collar-bones, and in the arm-pits, the voice is still heard, but the sound is indistinct and confused. Below the third rib, and over the remainder of the chest, the voice only

produces an obscure thrilling sound which is known as *pectoral resonance*. In certain morbid conditions the sounds of the voice seem to proceed with distinctness from the walls of the chest directly into the ear; and then, in place of the normal pectoral resonance, we have the physical sign known as Pectoriloquy (from the Latin *pectore*, from the chest, and *loquor*, I speak). It occurs when a tolerably superficial excavation, of moderate or considerable size, lies under the stethoscope; and hence it was at one time regarded as an almost certain indication of advanced consumption, but it is now known that it may also occur when solidified masses of lung lie between a large bronchial tube and the part of the chest on which the instrument rests.

**PECULIAR** (Fr. *peculier*, i. e., private) is, in English Law, a particular parish or church having jurisdiction within itself, and exempt from the jurisdiction of the ordinary. The Courts of Peculiars in these jurisdictions amount to about 300 in England and Wales, and had jurisdiction in reference to probates of wills before the recent constitution of the Court of Probate. Their jurisdiction is still somewhat obscure.

**PEDAL** (Lat. *pes*, a foot), any part of a musical instrument acted on by the feet. The pianoforte, the harp, and the organ are furnished with pedals, which, however, serve an entirely different purpose in each instrument. In the pianoforte, their object is to effect a change in the quality or intensity of the sound; the damper pedal prolongs the sound after the finger is lifted from the key, and the shifting or *una corda* pedal softens the tone. The pedals of the harp are the means by which the chromatic changes of intonation are effected. In the organ, the pedals are keys put in action by the feet. The division of the organ which is connected with the foot-keys is called the pedal-organ, and contains the largest pipes. The introduction of pedals in the organ is assigned to a German of the name of Bernhard, who flourished in the 15th c.; they were long of being brought into use in England, but now few organs, except those of the smallest dimensions, are made without them. Pedals are also used in the organ to act on the swell and on the stops. See **ORGAN**.

**PEDALIA'CEÆ**. See **BIGNONIACEÆ**.

**PEDAL-POINT**, or **PEDAL HARMONY**. See **ORGAN-POINT**.

**PEDEE', GREAT**, a river of North and South Carolina, U.S., rises in the Alleghany Mountains, in the north-west of North Carolina, and running south by east flows through the east portion of South Carolina, and enters the Atlantic through Winyaw Bay at Georgetown. It is navigable to Cheraw, 150 miles, and is about 350 miles in length. —The **LITTLE PEDEE**, its principal eastern branch, is formed by the confluence of several smaller rivers in the south part of North Carolina.

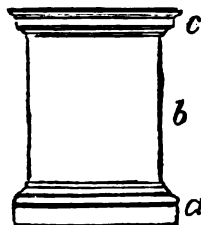

Pedestal.

called the dado or die, b.

**PEDETES**, or **HÉLAMYS**, a genus of rodent quadrupeds of the family *Muridae*, allied to

Jerboas, but differing from them in some of the characters of their dentition. The hind-legs, although very long, are not so long as in the jerboas. The tail is long. The **JUMPING HARE** (*P.* or *H. Capensis*) of South Africa is about the size of a rabbit. It can jump 20 or 30 feet at a bound. Its fore-feet also are very strong, and it burrows very expeditiously. The claws are long and strong. The habits of the animal are nocturnal, and it does considerable mischief in corn-fields and gardens.

**PEDICELLA'RIÆ** are very remarkable minute appendages of the integuments of many of the Echinodermata, having the form of a stalk, with a small two-bladed or three-bladed forceps at its summit. They are of a fleshy substance, with calcareous granules imbedded, and in a living state the blades are continually opening and closing. They were at one time supposed to be parasitic zoophytes, but are now generally believed to be organs of the starfish or sea-urchin, although their use is merely conjectured to be that of keeping the surface of the echinoderm free of algæ and zoophytes. The introduction of a pin's point between the blades causes an immediate closing of them. They are found both on shelly and on comparatively soft integuments, and are always present, and always of a particular form, according to the species of echinoderm, and according to the particular place which they occupy, being crowded chiefly around the spines, and near the mouth of sea-urchins.

**PEDICULA'RI'S**, a genus of herbaceous plants of the natural order *Scrophulariaceæ*, some of which have rather large and finely-coloured flowers. Two species, *P. palustris* and *P. sylvatica*, are natives of Britain, common in wet grounds. Both have received the name of Lousewort, the English equivalent of 'pedicularis,' from their supposed influence in producing the lousy disease in sheep; an influence purely imaginary. Their acridity renders



*Pedicularis palustris* :

a, corolla cut open, shewing the stamens; b, fruit; c, pistil.

them injurious to sheep which eat them. Continental Europe and the northern parts of Asia produce many other species, and some are found in North America. *P. sceptrum*, or King Charles's Sceptre, is one of the principal ornaments of marshy grounds in the most northern countries of Europe.

**PEDICULUS.** See **LOUSE**.

**PEDIGREE** (probably from Lat. *pes*, a foot), a tabular view of the members of a particular family with the relations in which they stand to each other, accompanied or unaccompanied by a notice of the chief events in the life of each, with their dates, and the evidence of the facts stated. Pedigrees are indispensable aids to the student of history. The wars of the Roses, the claim of Edward III. to the crown of France, the relative position of Mary and Lady Jane Grey, the circumstances which brought about the union of the crowns of England and Scotland, the Schleswig-Holstein question—now occupying the attention of Europe—and many other familiar chapters in the history of nations, as well as of families, cannot be read aright without the aid of pedigrees. The materials to be used in the formation of a pedigree are notes of the facts to be set forth, and a recognised series of signs and abbreviations. These notes comprise the name of every person who is to appear in the pedigree, with such dates and circumstances as it may be considered desirable to record. Among the commonest abbreviations are *da.*, for daughter of; *s.* and *h.*, son and heir of; *coh.*, coheir of; *w.*, wife of; *s. p.* (*sine prole*), without issue; *v. p.* (*vult patria*), in his father's lifetime; *b.*, born, *d.*, died; *dep.*, deposed; *K.*, king; *E.*, earl, &c. The sign = placed between two names, indicates that they were husband and wife; ∩ indicates that they had children; ↓ under a name signifies that the person had children. All persons of the same generation are to be kept in the same horizontal line; and the main line of descent is, wherever possible, to be indicated by keeping the successive names in a vertical column. Continuous lines indicate the succession of the different generations. The members of the same family are generally arranged in their order of birth in two groups—the sons first, and then the daughters; but where the same father or mother has children by more than one marriage, the children of each marriage ought to form distinct groups. The actual arrangement, however, of a pedigree must always depend on the leading object which it is intended to illustrate.

Tabular genealogies, generally brief, and meant to illustrate some particular claim of right, are found among the records, public and private, of the early middle ages; but after the incorporation of the English Heralds' College, far more attention was devoted to the compilation of pedigrees of families, more particularly with reference to their claims to dignities and heraldic insignia. In the course of the 16th c., the heralds obtained copies of all such accounts of the English families of any distinction as could be supplied to them, and entered them in the books which contain the records of their official proceedings. Royal commissions were issued under the Great Seal to the two provincial kings-of-arms, empowering them to visit in turn the several counties of England, in order to collect from the principal persons of each county an account of the changes which had taken place in their respective families in the interval since the last preceding visitation, and to inquire what account could be given of themselves by families who had stepped into the rank of gentry, or had become settled in the county since that period. The register-books kept by the heralds and their assistants contain the pedigrees and arms collected in the course of the visitations, with the signatures of the heads of the families. The pedigrees thus collected contain a vast body of information, interesting not only to the professed genealogist, but to every one who would know anything of the distinguished

characters in English history. Some of these books are lost, the rest are scattered among the public and private libraries of the country, the largest collections being in the archives of the College of Arms and the British Museum. After the beginning of last century, the visitations were discontinued, and there has since been no official and regular collection of pedigrees. A standing order of the House of Lords, in 1767, required that before any peer should be allowed to take his seat, Garter-king-of-Arms was to deliver at the table of the House of Lords a pedigree of his family, to be verified by the Committee of Privileges, and eventually preserved in the records of the House, a copy being also registered in the College of Arms. This order was rescinded by Lord Thurlow in 1802, with the view of framing a new one; but, unfortunately, this was never done. Persons sensible of the importance of preserving an authentic account of their descent, frequently record their pedigrees for preservation in the Register of the College of Arms. This register is quite distinct from the heraldic department of that institution, and is open to any one who wishes to preserve evidence of any properly authenticated facts regarding his descent and family.—In Scotland, in the absence of the regular system of visitations which prevailed in England, there is a great deal of evidence regarding the pedigrees of the historical families of the country scattered here and there in public and private collections, including the Advocates' Library and Lyon Office. A register of genealogies, similar to that of the English Heralds' College, exists in the Lyon Office, in which the pedigrees of applicants, after being proved to the satisfaction of the heraldic authorities, are inserted with the accompanying evidence. 'To what extent the register of genealogies in the Lyon Office may be admitted as a probative document, conclusive of the facts which it sets forth, has not been ascertained by actual decision; but there can be no doubt that, in questions both as to property and honours, it would be regarded as a most important adminicle of proof. The genealogical department of the Heralds' College in London is a very important one, and it is to be regretted that the uses of the corresponding department of the Lyon Office are so little understood and appreciated by the public.'—*Lorimer's Handbook of the Law of Scotland*, 2d edit., p. 446.

**PEDIGREE**, in point of law, is the legal relationship between individuals which is looked to with regard to the descent of property and honours. The occasion in which it comes into question is where a person dies, in which case his property, if he died intestate, is divided among those who are related by blood. The real property goes to one set of relations, and the personal property to others. See **INTESTACY**, **NEXT OF KIN**, **SUCCESSION**, *Paterson's Comp. of English and Scotch Law*, 251, 257.

**PE'DIMENT**, the triangular space over the portico at the ends of the roof of classic buildings. It is enclosed by the horizontal and the *raking* cornices, the latter of which follow the slopes of the roof. The pediment may be called the gable of classic buildings. It is frequently enriched with sculpture, for which it forms a fine setting. The doors and windows of classic buildings are often surmounted by pediments, either straight-sided or curved.

**PEDLERS.** See **HAWKERS**.

**PEDO'METER**, an instrument for measuring walking distances. It sometimes has a watch or clock attached. In the patent pedometer of Messrs Payne, William, & Co., there is a repeating watch,

which shews seconds, minutes, and hours, and also the day of the month. They are used by pedestrians, and for measuring streets when the fares of hired carriages are disputed. See ODOMETER.

**PEDRO I. (DOM PEDRO D'ALCANTARA)**, Emperor of Brazil, was the second son of John VI., king of Portugal, and was born at Lisbon, 12th October 1798. On the death of his elder brother in 1801, he became Prince of Beja, and heir to the throne; and after his father's accession to the throne of Portugal and Brazil in 1816, he received the title of Prince of Brazil. He was carried along with the rest of the royal family of Portugal in their flight to Brazil in 1807, and from that time remained in that country. His education, owing to political disturbances, was not carried on systematically, and after his arrival in Brazil, he was left to instruct himself very much according to his own inclination. In 1817, he married the Archduchess Leopoldine of Austria, and on his father's return to Lisbon in 1821, was named Regent of Brazil. At this time, a great political crisis was impending; the Brazilians had been utterly disgusted at the preferment of Portuguese to the highest offices of state and the chief clerical dignities, and their discontent was heightened by the refusal of the Portuguese Cortes to accord to Brazil a liberal constitution similar to that which had been granted to the mother-country, and by its arbitrary command, that P., who was at the head of the liberal party, should at once return to Portugal to complete his education. P., however, cast in his lot with the Brazilians, despite threats of exclusion from the throne of Portugal, and was chosen, on 12th October 1822, Emperor of Brazil. His government was very vigorous, but a war which broke out between his supporters and the advocates of republicanism, distracted the country for a time, and prevented the liberal measures of the government from taking full effect. In 1825, his title was recognised by the Portuguese Cortes; and the death of his father, in the following year, opened for him the succession to the throne of Portugal. This revived the national spirit of the Brazilian Chambers, who feared that they were about to be again reduced to a dependent state, and P.'s hasty and passionate temper led him to measures which whetted the general discontent. But he merely retained the dignity of king of Portugal long enough to shew his right to it, and, after granting a more liberal constitution, immediately resigned in favour of his daughter, Maria II. (q. v.). The disturbances in Brazil still increased, the finances fell into disorder, the emperor's second marriage with the Princess Amelia of Leuchtenburg displeased his subjects; and after making various ineffectual attempts to restore tranquillity, he was compelled, by the revolution of July 1831, to resign the throne in favour of his son, Pedro II., a boy of 5½ years old. P. then sailed for Portugal, where his brother Miguel had usurped the throne; and with the aid of an army which was swelled by French and English volunteers, after a three years' campaign, he drove away the usurper, and restored his daughter to the throne in 1834. But the ceaseless excitement by which he had been surrounded, and the excessive demands on his energies, had produced total exhaustion, and he died 24th September 1834. See BRAZIL; MIGUEL, DOM; and PORTUGAL.

**PEDUNCLE.** See FLOWER.

**PEEBLES.** See PEEBLESHIRE.

**PEEBLESHIRE**, a county in the south of Scotland, also called Tweeddale, from consisting mainly of the upper valley of the Tweed, a river which originates in the county. P. is bounded by

Dumfries and Selkirk shires on the S., Lanarkshire on the W., Mid-Lothian on the N., and Selkirkshire on the E. The county is small, containing only 356 square miles, or 227,869 statute acres. Its lowest point above the mean level of the sea is about 450 feet, from which to 1200 feet is the region of cultivation; but the county being a group of hills, is mostly pastoral, with the arable lands chiefly in the valleys. The highest hill is Broad Law, which reaches an elevation of 2754 feet. Within the county, the Tweed has for tributaries the small rivers Eddleston, Leithen, Quair, Manor, and Lyne, besides many mountain rivulets. P. comprehends sixteen parishes, but several being ecclesiastically united, the number of parish churches, each with a settled minister, is fourteen; the number of parish schools is fifteen. The only town in the county is Peebles, an ancient royal burgh, pleasantly situated on a peninsula formed at the confluence of the Eddleston with the Tweed. The principal villages are Innerleithen, Walker Burn, West Linton, and Carlops. In 1861, the population of the county was 11,408, of whom about 2000 belonged to Peebles, which, distant 22 miles from Edinburgh, is the seat of a sheriff and county administration. It is also the seat of a presbytery. Besides the parish church, the town has several dissenting places of worship, including an Episcopal and a Roman Catholic chapel. It likewise possesses some good schools, has three branch banks, and a number of inns. As a means of literary and social improvement, Mr W. Chambers, in 1859, made a free gift to this his native town of a spacious suite of buildings, comprising a Reading-room, a Public Library consisting of 15,000 volumes, a Museum, Gallery of Art, and Hall for lectures and concerts—the whole being designated the CHAMBERS' INSTITUTION. Long secluded from general traffic, P. has been lately opened up by railways; and the woollen manufacture has made considerable progress in the parish of Innerleithen. In 1863, the valued rental of the county, town included, exclusive of railway property, was £96,734, 5s. 1d. P. abounds in the remains of British hill-forts, border towers, and other antiquities, and possesses numerous modern mansions of a handsome kind. Hitherto, the only account of the shire has been a *Description of Tweeddale*, by Dr Alexander Pennicuik, 1715; reissued with notes, 1815; but in the present year (1864) has been written a *History of Peebleshire*, by W. Chambers, 1 vol. 8vo, illustrated with maps and wood-engravings.

**PEEL**, a small but populous and thriving seaport town on the west coast of the Isle of Man. It was formerly called 'Holm,' and was a place of great importance in the island. The herring-fishery, the building of vessels of small tonnage, and the manufacture of nets, are here carried on extensively, and form a source of large profits to the inhabitants. The bay is spacious, and abounds with fish of excellent quality.

At the northern extremity of this bay are several grotesque and romantic caverns. The southern extremity is formed by Peel Island, on which stand the grand old ruins of Peel Castle and St German's Cathedral. The castle was formerly the frequent residence of the Earls of Derby, then Lords of the Isle of Man, and is expressly named in the original grant of Henry IV. to the Stanley family. Beneath the cathedral is a strong subterranean dungeon, where many noble persons were in former days imprisoned, including Thomas, Earl of Warwick, in the time of Richard II., and Elinor Cobham, Duchess of Gloucester, who was sentenced to perpetual imprisonment in it in the year 1440, and who died within its gloomy recesses. In Sir Walter

The text in this column is extremely faint and largely illegible. It appears to be a continuation of a historical or political narrative, possibly related to the events mentioned in the right-hand column.

...of the Wellington  
...by a Whig  
...1832 carried  
...the death of h  
...law that econ  
...and its resul  
...from any  
...the measure in  
...as possibly  
...it was  
...servative  
...repor  
...be only  
...of Wh  
...of the  
...parli  
...member  
...the nose  
...the M. Bour  
...the other  
...in 1830  
...was compen  
...in Apr  
...of the  
...was alway  
...were bein  
...part  
...of the  
...1841, o  
...part  
...was  
...and Pr  
...the ne  
...was har  
...servative  
...into the  
...ment was  
...The  
...their ex  
...in  
...Law League  
...repea  
...had existe  
...1842, i  
...based upo  
...which  
...the M. Bour  
...attention an  
...for the impo  
...the found t  
...the ne  
...of the gener  
...the distri  
...of ammer  
...salt  
...He als  
...of the  
...of Ireland  
...an  
...was set asi  
...the influen  
...of 184  
...with bein  
...endow  
...and by the  
...colleges, an  
...the potato-rot i  
...by a frightf  
...a necessity,  
...starve. Cobden and th  
...their exertions. Lord John  
...the views of the Whig part  
...and Peel again yielded. He told hi  
...that the corn-laws were

...of Oxford had rejected  
...and shown in the stead  
...of 1841. His now came on the  
...of Parliamentary reform, which P. ...

and that their repeal was inevitable. Some refused to go along with him, he resigned; after a few days, was recalled, and resumed office. Lord Stanley (now Earl Derby), seceded, and Lord George Bentinck, Mr. Disraeli, &c., led a 'no-surrender' Tory party; but the Duke of Wellington, Graham, Aberdeen, Gladstone, other eminent Conservatives, stood by him, and the measure for the repeal was carried. He was, however, immediately afterwards defeated on the Protection of Life Bill. Not so much upon account, as because he felt that the course which he pursued had produced a dissolution of the ties of party, and that he could not expect for some time to find himself at the head of a strong government, P. retired from office in June 1846, to place to a Whig administration under Lord Russell, to which he gave an independent personal support as the leader of a middle rather Whig than Tory. In the critical year of 1847—1848, he was one of the most important props of the government, whose free-trade principles he had now completely accepted. His fiscal policy had also undergone a remarkable change, and he now frankly supported the Whigs in the efforts to carry an act for the repeal of the Jewish disabilities. He was highly regarded by the working and middle classes generally with much grateful respect. An unexpected catastrophe put an end to his career. On the 28th of June 1850, he had spoken with great force in the debate on Lord Palmerston's Greek Loan Bill; but on the following day was thrown from his horse in Hyde Park, and was so much injured, he died on the evening of the 2d of July.—He left three sons, SIR ROBERT PEEL, the second, FREDERICK, are both members of the House of Commons, and have adopted generally the Whig politics of their father.

**PEEL-TOWER** (W. *pill*, a stake, a fortress; *stela*, a stake, pillar, structure), the name given to towers erected on the Scottish borders for defence. They are square, with turrets at the corners, and the door is sometimes at a height from the ground. The lower story is usually vaulted, and formed a stable for horses, cattle, &c. For an account of these old towers, now mostly in ruin, see *History of Peebleshire*, by W. Chambers, 1864.

**PEPUL, PIPUL, or PIPPUL** (*Ficus religiosa*), known as the SACRED FIG of India, and in Persia called the BO TREE; a species of Fig (q. v.), that resembling the Banyan, but the branches drooping like those of that tree, and the leaves shaped with long attenuated points. The tree is sacred by the Hindus, because Vishnu is said to have been born under it. It is generally planted in temples, and religious devotees spend their lives under its shade. It is also held sacred by the Buddhists. It attains a great size and age. A remarkably aged tree of this species is figured in the article BO TREE. The P. is often planted near houses, and by the sides of walks, for the sake of its grateful shade. The juice contains caoutchouc, and is used by women as bandoline. Lac insects deposit upon this tree, and much lac is obtained from the fruit is not much larger than a grape, and is not valued.

**PAR** (Fr. *pair*; Lat. *par*, equal), a general title applied to the titled nobility of Great Britain and Ireland, indicating their equality of rank. The title includes the various degrees of Baron, Viscount, Earl, Marquis, and Duke. The peers of Great Britain, of the United Kingdom, and certain representative peers of Scotland and Ireland, together with certain of the bishops and

archbishops, who are called lords spiritual, constitute the House of Lords. The dignity of the peerage is hereditary, but in early times was territorial. Life peerages seem at one time to have been not unknown in England; but in 1856 Sir James Parke, having been created by Her Majesty Baron Wensleydale 'for and during the term of his natural life,' the House of Lords, on the report of a Committee of Privileges, held that he was not entitled to sit and vote in parliament. Ladies may be peeresses in their own right either by creation or by inheritance. The wives of peers are also styled peeresses. Under the articles NOBILITY, PARLIAMENT, DUKE, MARQUIS, EARL, VISCOUNT, and BARON, will be found notices of each order of peers, and of the origin, history, and privileges of the peers as a body. A certain limited number of the French nobility were styled Peers of France.

**PEE'WIT.** See LAFWING.

**PEGASSE, or PACASSE** (*Bos pegasus*), a species of ox, a native of the interior of Western Africa. The head is short and thick, the forehead wide; the horns long, extending laterally from the frontal ridge, then turning downwards, and again upwards; the ears very large and pendulous; the neck maned; the tail entirely covered with long hair; the legs long. Little is yet known of this curious species of a most important tribe.

**PE'GASUS**, in Greek Mythology, a winged horse which arose with Chrysaor from the blood of the Gorgon Medusa, when she was slain by Perseus. He is said to have received his name because he first made his appearance beside the springs (*pegai*) of Oceanus. He afterwards ascended to heaven, and was believed to carry the thunder and lightning of Zeus. According to later authors, however, he was the horse of Eos. The myth concerning P. is interwoven with that of the victory of Bellerophon over Chimæra. Bellerophon had in vain sought to catch P. for his combat with this monster, but was advised by the seer Polyidos of Corinth to sleep in the temple of Minerva, and the goddess appearing to him in his sleep, gave him a golden bridle and certain instructions, upon which he acted, and made use of P. in his combat with the Chimæra, the Amazons, and the Solymi. P. is also spoken of in modern times as the horse of the Muses, which, however, he was not. The ancient legend on this subject is, that the nine Muses and the nine daughters of Pieros engaged in a competition in singing by Helicon, and everything was motionless to hear their song, save Helicon, which rose ever higher and higher in its delight, when P. put a stop to this with a kick of his hoof, and from the print arose Hippocrene, the inspiring spring of the Muses. But that P. is the horse of the Muses, is entirely a modern idea, being first found in the *Orlando Innamorato* of Boiardo.

**PEGASUS**, a genus of fishes, constituting the

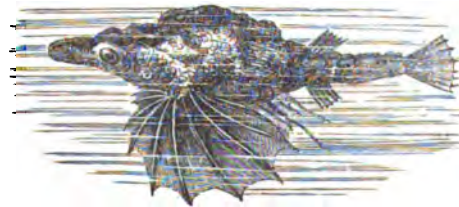

Sea Dragon (*Pegasus draco*).

family *Pegasidae*, of the order *Iophobranchii* (q. v.). The species are few; they are small fishes, natives of the Indian seas, interesting from their peculiar form



and appearance. The breast is greatly expanded, much broader than high, the gill-openings in the sides; the pectoral fins are extremely large and strong; a long snout projects before the eyes, and the mouth is situated under and at the base of it; the body is surrounded by three knobbed or spinous rings. One species (*P. draco*) is called the SEA DRAGON, another (*P. volans*) is popularly known as the PEGASUS.

**PEGS.** Small square pointed pegs of wood have of late years been introduced by the Americans into the manufacture of boots and shoes, for the purpose of connecting the parts of the sole and upper leather together without sewing. See SHOEMAKING. This invention has been so extensively adopted, that the manufacture of wooden pegs, for this purpose, has become an important trade in America and Bohemia, from which countries a considerable importation is made to Great Britain. They are chiefly made of maple-wood, and are rarely more than an inch in length.

**PEGU'**, a province of British Burmah, lies between the parallels of 15° 14'—19° 27' N. lat., and the meridians of 94° 13'—96° 52' E. long., and is divided for fiscal purposes into the following districts or provinces:

	Area in Square Miles.	Population, 1862.
Rangoon, . . . . .	9800	252,507
Basseln, . . . . .	8900	225,876
Prome, . . . . .	5494	232,067
Henzada, . . . . .	2200	118,614
Tharwady, . . . . .	2160	128,248
Tonghoo, . . . . .	3900	66,773
Total, . . . . .	32,454	1,024,885

Of this number of inhabitants, about 800,000 are true Burmahs; but in addition to these, there is a sprinkling of Karens, who live in the wild and hilly districts, Taleins or Peguers, Shans, Khyngs, Yabaings, Indians, Chinese, and a few other races.\*

The principal river of P. is the Irrawadi (q. v.). In March, the river begins to rise, and gradually increases in volume till its waters are forty feet above their lowest level. They rapidly subside in October, when the rains cease, and the north-east monsoon sets in. The revenue of P. for the year 1862—1863 was 5,653,316 rupees; though, under the rule of the king of Burmah, it did not amount to half that sum. P. was annexed to British India at the close of the Burman war of 1852, since which time slavery has ceased to exist, schools have been established, and various public works undertaken.

Rice and teak timber are the principal exports. A flotilla of steamers keep up the communication between Rangoon (q. v.), the principal port, and the chief stations on the Irrawadi, conveying troops, stores, passengers, and mails from place to place.—*Winter's Six Months in British Burmah* (Lond. 1858); *Martin's British India* (Lond. 1862).

**PEHLEVI** (Valour, Power; *Zabán Pehlvi* = Language of Heroes) is the name of an ancient West-Iranian (Median and Persian) idiom, in use

\* Lieutenant-colonel A. P. Phayre, chief commissioner of British Burmah, in his report for 1863 (Rangoon, 1863) states the population of Pegu as follows:

Races.	
1. Europeans and their descendants, . . . . .	2,409
2. Burmese, including Aracanese and Talaings, . . . . .	924,091
3. Karens, . . . . .	249,518
4. Shans and Tounghoos, . . . . .	24,689
5. Chinese, . . . . .	1,724
6. Khyngs, . . . . .	18,879
7. Indians, . . . . .	11,844
8. Mohammedans of Burmah, . . . . .	2,089
9. All races not included above, . . . . .	9,142
Total, . . . . .	1,244,385

chiefly during the period of the Sassanides (230—640 A. D.), who, wishing fully to restore the ancient Persian empire, endeavoured also to reinstate primitive national language, fallen into disuse as a court-language since the time of Alexander's conquest. Yet they did not fix upon the pure Persian as it was still spoken in the interior, but upon a dialect of the western provinces, largely mixed with Semitic words, to which Arian terminations were affixed. The grammatical structure of the presents almost the same poverty of inflections and terminations as the present Persian. Although, however, less rich than Zend (q. v.) in inflection and accentuation, it yet boasts of the same copiousness of words as that dialect, to which it really succeeded. It is written from right to left, and letters are mostly joined. The remnants of P. consist of coins, inscriptions (found at Haja, Persepolis, Kirmanshah, &c.), and a number of books all relating to the religion of Zoroaster. The most important of these are the translation of the Gáthas, part of the Zend-Avesta (Yazna, Visparad, Vendidad), and such original religious works as Bundehesh, Shikandgumâni, Dinkart, Atash Bâst, &c. The P. of the books differs from that of the inscriptions and coins to such a degree—according to the larger or smaller preponderance of the Semitic element—as to have misled investigators (Westergaard and others) to assume that utterly distinct languages, a purely Iranian and Semitic one, had been used somewhat indiscriminately at the time. The non-Iranian element called Huzvareh (Huzooreh) by the Parsee priests, who, taking advantage of the ambiguity of the alphabet, often substitute the corresponding Persian for the foreign words. The Iranian part of P. differs little from the Persian of our day, and, in fact, the P. changed first into modern Persian, and subsequently into modern Persian, simply by getting rid first of its Chaldee, and then of its Iranian words which had become obsolete. The chief use of the P. dialect at present is as an assistance it offers towards the elucidation of the Zend itself. For the history of its investigation since it was first made known in Europe, we refer to PERSIAN LANGUAGE AND LITERATURE.

**PEI-HO'**, a river of China, which, rising on the confines of Tartary, traverses the northern part of the province of Chih-le (q. v.) or Pe-chih-le, and empties into the Gulf of Pe-chih-le, in about 38° 30' N. lat.

The attack on the escort of the British and French ambassadors, whilst ascending the Pei-Ho' (June 1859), led to the war with China in 1860. See CHINA.

**PEINE FORTE ET DURE**, the 'strong and hard pain,' a species of torture formerly applied by the law of England to those who, on being arraigned for felony, refused to plead, and stood mute, or peremptorily challenged more than twenty jurymen, which was considered a contumacy equivalent to standing mute. In the beginning of the 13th century this penalty seems to have consisted merely of severe imprisonment with low diet, persisted in till the contumacy was overcome. But by the reign of Henry IV., it had become the practice to load the offender with weights, and thus press him to death, and till nearly the middle of the 18th c., pressed to death was the regular and lawful mode of punishing persons who stood mute on their arraignment for felony. The motive which induced an accused party, in any case, to submit to this penalty rather than to plead, was probably to escape attainder which would have resulted from a conviction for felony. During the 15th, 16th, and even the 18th c., various cases are recorded

the infliction of the punishment in question. Formerly, a practice prevailed which had no sanction in the law, of first trying the effect of tying the thumbs tightly together with whipcord, that the pain might induce the offender to plead. Among instances of the infliction of the *peine forte et dure*, is the following: Juliana Quick, in 1442, charged with high treason in speaking contemptuously of Henry VI., was pressed to death. Anthony Arrowood, in 1598, was pressed to death (Surtees's *History of Durham*, vol. 3, p. 271). Walter Calverly, of Calverly, in Yorkshire, arraigned at the York Assizes in 1605, for murdering his two children and his wife, was pressed to death in the castle with a large iron weight placed on his breast (Stow's *Annals*). Major Strangways suffered death in a similar way in Newgate in 1657, for refusing to plead when charged with the murder of his brother-in-law, Mr Fussell. In 1720, a person of the name Phillips was pressed in Newgate for a considerable time, till he was released on his submission; and the same is recorded in the following year of one Nathaniel Hawes, who lay under a weight of 250 lbs. seven minutes. As late as 1741, a person is said to have been pressed to death at the Cambridge assizes, the tying of his thumbs having been first tried without effect.

The statute 12 Geo. III. c. 20 virtually abolished the *peine forte et dure*, by enacting that any person who shall stand mute when arraigned for felony or felony shall be convicted, and have the same judgment and execution awarded against him as if he had been convicted by verdict or confession.

PEIPUS, LAKE, in the north-west of Russia, is surrounded by the government of St Petersburg, and the provinces of Esthonia and Livonia. On the south-east it is connected with Lake Pskoff by a strait 16 miles in length and from  $1\frac{1}{2}$  to  $4\frac{1}{2}$  miles broad. The length of both lakes is 87 miles, the greatest breadth about 40, and the depth from 14 to 20 feet. Lake Pskoff receives the waters of the rivers Velekaia, and Lake P. is supplied by Lake Pskoff, and by the Embach from the west, and other rivers. The waters of the lower lake are carried to the Gulf of Finland by the Narova. The lakes are studded with several picturesque islands, and surrounded with banks which are for the most part rocky and abound in fish, the taking of which is employment to many.

PEISI'STRATOS (Lat. *Pisistratus*), a famous tyrant of Athens, belonged to a family of Attica, which claimed descent from Pylion Nestor, and was slain towards the close of the 7th c. B. C.—certainly not later than 612. His father's name was Hipponates, and through his mother he was pretty intimately related to the great lawgiver, Solon, between whom and P. a very intimate friendship long existed. He received an excellent education; and the charm of his manners, as well as the generosity of his spirit was so great that (according to Solon) had he not been ambitious, he would have been the saviour of Athenians; but his passion for the exercise of sovereign power led him to adopt a policy of dissimulation, for the purpose of attaining his ends, which prevents us from regarding him with the admiration that the beneficent character of his government might seem to demand. At first, P. co-operated with his kinsman Solon, and in the war against the Megarians, acquired considerable military distinction; but afterwards, when probably his ambitious views had become more matured, he came forward as the leader of one of the three parties into which Attica was then divided. These were, the *Pedizai* (party of the Plain), or the landed proprietors; the *Parali*

(party of the Seaboard), or wealthy merchant classes; and the *Diacrii* (party of the Highlands), chiefly a labouring population, jealous of the rich, and eager for equality of political privileges. It was to the last of these that P. attached himself; but indeed he assiduously cultivated the good-will of all the poorer citizens, to whom he shewed himself a most liberal benefactor. At last P. took a decided step. Driving into the market-place of Athens one day, and exhibiting certain self-inflicted wounds, he called upon the people to protect him against his and their enemies, alleging that he had been attacked on account of his patriotism. Solon, who was present, accused him of hypocrisy; but the crowd were, according to Plutarch, ready to take up arms for their favourite; and a general assembly of the citizens being summoned, Ariston, one of P.'s partisans, proposed to allow him a body-guard of fifty men. The measure was carried in spite of the strenuous opposition of Solon. Gradually P. increased the number, and in 560 B. C., when he felt himself strong enough, seized the Akropolis. The citizens, in general, seem to have tacitly sanctioned this high-handed act. They were sick of the anarchic broils of the different factions, and probably glad to see their champion and favourite usurp supreme authority. Megakles and the Alkmeonids—the heads of the rich aristocratic party—immediately fled from the city. Solon, who loved neither oligarchic arrogance nor military despotism, but was a thorough constitutionalist, tried, but in vain, to rouse the Athenians against Peisistratos. P., who was not at all vindictive in his disposition, did not attempt to molest Solon; he even maintained the legislation of the latter almost intact, and distinguished himself chiefly by the vigour of his administration. P. himself did not enjoy his first 'tyranny' long. The *Pedizai* and the *Parali* rallied under Lykurgos and Megakles, united their forces, and overthrew the usurper, who was forced to go into exile. But the coalition of the two factions was soon broken up. Megakles hereupon made overtures to P., inviting him to resume his tyranny, which he did, but a family quarrel with Megakles induced the latter to again ally himself with Lykurgos, and P. was driven from Attica. He retired to Euboea, where he remained for ten years, ever keeping an eye, however, on Athens, and making preparations for a forcible return. How he managed to acquire so much influence while only a banished man, is difficult to ascertain; but certain it is that many Greek cities, particularly Thebes and Argos, placed the greatest confidence in him, and finally supplied him abundantly with money and troops. P. at length sailed from Euboea, landed in Attica at Marathon, and marched on the capital. His partisans hurried to swell his ranks. At Pallene, he encountered his opponents, and completely defeated them, but used his victory with admirable moderation. When he entered the city, no further resistance was made, and he resumed the sovereignty at once. The date of this event, as of most others in the life of P., is very uncertain; perhaps we shall not err far if we place it about 543 B. C. He lived for sixteen years afterwards in undisturbed possession of power, dying 527 B. C., and transmitting his supremacy to his sons, Hippias and Hipparchus, known as the *Peisistratidæ*. His rule was mild and beneficent. Although the precautionary measures that he adopted to establish his authority involved at first a certain resolute and stringent policy (e. g., the seizure of the children of his leading opponents, and the detaining them as hostages); yet no sooner had he placed himself out of danger, than he began to display that wonderful tact,

moderation, kindness, and sympathetic appreciation of the wishes of the Athenians, that have won him the praise and esteem of all later ages, in spite of his usurpation. He firmly, but not harshly, enforced obedience to the laws of Solon; emptied the city of its poorest citizens, and made them agriculturists, supplying such as had no resources with cattle and seed; secured provision for old and disabled soldiers; bestowed great care on the celebration of the religious festivals of the Atticans, and even introduced some important changes; encouraged literature more than any Athenian had ever done before—it is to P., or to the poets, scholars, and priests about him, that we owe, for example, the first complete edition of Homer (q. v.); and, like his still more brilliant successor in the following century, Perikles, he adorned Athens with many beautiful buildings, such as the Lyceum, a temple to the Pythian Apollo, another to Olympian Zeus, &c.

**PEKAN**, or **WOOD-SHOCK** (*Martes Canadensis*), a species of Marten (q. v.), very nearly allied to the sable, a native of the northern parts of North America. It is twice the size of the pine marten, and is generally of a grayish brown colour; the legs, tail, and back of the neck marked with darker brown. The fur, although not so valuable as sable, nor even as that of the pine marten, is useful, and large quantities are sent to the market. The P. lives in burrows, which it excavates in the banks of rivers; and feeds chiefly on fish and other aquatic animals.

**PEKIN**, or **PE-K'ING** (i. e., Northern Capital), the capital of the Chinese empire since 1408 A. D., is situated in lat. 39° 54' 13" N., and long. 116° 28' 54" E., in the northern province of Chih-le, at a distance of nearly 100 miles from the sea, and about 60 miles from the great Chinese Wall. The population of the city is estimated at about 2,000,000; the entire area, in which is included much vacant space, at 27 square miles, and the circuit of the walls is said to be about 25 miles. These walls are made of earth, with an outer casing of brick, having embrasures for musketry or ordnance every 50 feet; their height is about 40 feet; thickness at the base about 30 feet, and at the top 12 feet, which is paved with stone, and where horsemen can ascend by a ramp or sloping way. At intervals of 60 yards are square towers, projecting outwards from the walls 50 or 60 feet. The gates which give access to the city from the surrounding country are 16 in number, nine of which belong to the Northern or Tartar City, and seven to the Southern or Chinese City. Over each gate is a watch-tower nine stories in height, and loopholed for cannon.

The city of P. is divided into two parts, separated by a wall with three gates. These two sections form respectively the Northern, Interior, or Tartar City, called *Nei-tching*; and the Southern, Exterior, or Chinese City, called *Wai-tching*.\*

1. *Nei-tching*, or the Northern City, has three distinct divisions or enclosures—viz., the Prohibited City, the Hwang-Ching, or Imperial City, and the General City. The first of these—the innermost or

\* Northern City and Southern City are the most correct terms. The latter was added to the more ancient Northern City, and was originally designed to encircle it; hence it was called the Exterior City, in contradistinction to the Northern or Interior City. It was also intended to reserve the Northern City for the Tartars, and the Southern City for the Chinese, as the names still imply; but in point of fact, the Tartar City contains as many Chinese as Tartars; and it is not surrounded by the so-called Chinese City, which latter has only been added on the south side.

central block—is surrounded by a yellow wall about two miles in circumference, which shuts in the palaces, pleasure-grounds, and temples of the sacred city. Here live the emperor and his family, the ladies of the court, and the attendant eunuchs. 'Keñ-tsing-kung,' or 'the Tranquil Palace of Heaven,' the emperor's private palace, is the most magnificent of the royal residences. Other notable buildings of the prohibited city are 'Fung-see-teen,' the Temple of Imperial Ancestors; Ching-hwang-meou, the Temple of the Guardian Deity of the city; Nan-heun-teen, the Hall of Portraits of the Chinese emperors and sages; and Wan-yuen Kung, the Imperial Library. The Imperial City is built around this central block, and contains the palaces of the princes, temples, some of the government offices, and spacious pleasure-grounds. From Wo-ying-teen, the Imperial Printing-office, the *Imperial* or *Pe-king Gazette* is issued daily for all government officials throughout the empire. This is the only publication in China approaching to a newspaper, and is named *King Paou*, or 'Great Report.' It is not merely a report for official information, but forms the basis of the national annals, and is compiled from the daily records of the Supreme Council. Besides the daily edition there is one published every two days, which is sold to the public, and from which is withdrawn decrees and reports of a secret character. The journal itself is a miserable production even for China, and consists of from 15 to 20 pages, not so large as common note-paper. The General City—the third division or enclosure—lies between the Imperial City and the outside walls; it is more densely populated than either of the preceding divisions, and contains the most important of the public offices, including the six supreme tribunals or boards; the Le-fan-yuen, or the Office of Foreign Affairs; Too-cha-yuen, or the Imperial Censorate, &c.; Han-lin-yuen, or the Grand National College; the Great Medical College; the Observatory; the Police office; and the British, French, and Austrian legations, which are close to the south wall. The British minister resides in the Leang-kung-foo, the Palace of Leang, a gorgeous building, consisting of four or five large halls, and covering many acres of land. The principal streets of the general city—from 140 to 200 feet wide and unpaved—are continuous lines of shops painted red, blue, and green, decorated with staring signs and resplendent with Chinese characters highly gilt. By day and by night, by the light of the sun, or by the illumination of torches and paper lanterns, the roar of these great thoroughfares is incessant; shopkeepers, pedlars, mountebanks, quack-doctors, passengers on foot or on horseback, each and all contributing to the general hubbub. The minor streets and lanes, where the houses of the populace are mingled with public offices, temples, stores, and manufactories, are by means pleasant places, their general character being an 'insupportable odour,' and one-story brick houses with roofs of a gray colour. There are 'Fetid Hide Street,' 'Dog's-tooth Street,' 'Dog's-tooth Street,' 'Barbarian Street,' and many others whose names equally uninviting.

2. *Wai-tching*, or the Southern City, is the second great division of Peking. It measures about four miles from east to west, and two miles or less, from north to south; but a great portion of the enclosed space is laid out in parks and gardens. Teen-Tan, or the Temple to Heaven, and Tec-Tan, or the Temple to Earth, with their grounds, occupy a considerable space; the theatres and places of public amusement are likewise situated in the Southern or Chinese City. Robert Fortune, who has lately visited P., describes its most peculiar

## PEKIN—PELAGIANISM.

striking features as follows: 'As an eastern city, it is remarkable for its great size, and for its massive walls, ramparts, and watch-towers. The straight and wide streets are different from those of any other Chinese town which has come under my observation. Its imperial palaces, summer-palaces, and temples, with their quaint roofs and blue tiles, are very striking objects; and the number of private dwellings situated amongst trees and gardens, surrounded with high walls, give a country or park-like appearance to the great city. The trees and gardens of the palace, with King-tan, or Prospect Hill, are objects of considerable interest, as is also Lama Mosque, suggesting as it is some connection, in times long gone by, with Tibet or India.'

Outside the city, there are unwall'd suburbs, as in every walled town in China. These are of considerable extent, but straggling, and consist principally of an agricultural population, the land being everywhere in a state of cultivation, producing chiefly maize and millet, as it is not so suitable for staple products of rice and wheat. The land is richly watered, but well timbered, which gives a pleasing aspect to the landscape; and when viewed from the range of mountains extending from the west of P. to the north-east, presents a picturesque panorama. It is in the former direction, towards the north, that the famous *Yuen-ming-yuen* palaces were situated, which were sacked and destroyed by the allies in October 1860. These were 30 in number, surrounded by every variety of hill and dale, meadow and lawn, interspersed with canals, pools, fountains, and lakes, with numerous temples and statues containing statues of men and gods in gold, silver, and bronze. Here had been heaped up for centuries all the movable riches and presents of the emperors of China, amongst which were found many sent by the English embassies. At the approach of the allies, Hien-fung fled in haste; and Lord Elgin learned that it was in those mountains that the British and French prisoners, secured by treachery, had been tortured, he gave order to sack and destroy this favourite residence of the emperor's, 'as it could not fail to be a blow to his pride as well as his feelings; and it would be a solemn act of retribution.' The palaces were cleared of every valuable, and their walls destroyed by fire and sword; while the fugitive emperor died at his stronghold, Zehol, among the Altai mountains.

This has thus been rendered memorable by this attack of the British and French forces (1860) on the walls of the city, on which the British and French flags were raised. The provisions of the Convention of Tien-tsin (1858, see CHINA) were subsequently ratified and supplemented by the Convention of Peking, which was signed in the English and French languages at P., October 24, 1860. The following is an abstract of this important document. By Article 1, it is agreed that on the day on which the convention is signed, the port of Tien-tsin shall be opened to trade, and British subjects shall reside and trade there under the same conditions as at any other port of China by treaty or trade. Article 2 confers full liberty on the Chinese to emigrate, together with their families, to British colonies or other foreign parts. Article 3 cedes to Her Majesty the Queen of Great Britain and Ireland, and to her heirs, the island of Cowloon, in the province of Kwang-tung, as a dependency of Her Britannic Majesty's Colony of Hong-kong, with a view to the maintenance of law and order in and about the harbour of Hong-kong. But the most important article of the Convention is that which allows the residence

of a British envoy at P., a privilege which was alone accorded to Russia. About four years have elapsed since then, and the greatest benefits have resulted to both governments by this step. The same has been granted to the French and American governments; who, with the several missionary establishments, now (1864) form a population of 41 foreign residents, besides a few ladies, children, and servants; while foreigners of all nations are allowed to visit, but not to trade within the precincts of the city.—See *Yedo and Peking*, by Robert Fortune (London, 1863), *Chinese Repository* (March 1834), *Macmillan's Magazine* (January 1861), *Lord Elgin's Despatches* (October 1860), *M.S. Notes* (1863).

PELAGIANISM, the doctrinal system of Pelagius (q. v.), especially on the subjects of the natural condition of man, original sin, grace, free-will, and redemption. Under the head PELAGIUS will be found what may be called the external history of the controversy to which the opinions of that remarkable man gave occasion. The movement, considered in itself, is one of the most interesting in the history of the human mind. At the close of the great controversies on the Trinity and Incarnation, the speculation, which for nearly a century had wearied itself in vain endeavours to make plain the inscrutable mysteries of the divine nature, at length turned inwards upon itself; and no one at all familiar with the controversy on P. can doubt that that prouder view of the capabilities of human nature, which lies at the root of all the theories of which P. was but the exponent, was a reaction against the crude and degrading conceptions of the nature and origin of the soul which characterised the philosophy, not alone of the Manichean teachers, but of all the dualistic religions which sprung from the prolific soil of Gnosticism. To the Manichean, and to all in general who adopted the Gnostic views as to the evil origin and nature of matter and material substances, man was, in his *psychical* nature, evil and incapable of good. The Christian teacher, in combating this view, easily passed into an opposite extreme, and overlooking or explaining away the strong language of the Scripture, was led to represent man as endowed with full capacity for all good; and so long as the only adversaries to be controverted were those who urged the views of the Gnostic school, the line taken by Christian writers was but little guarded by any of those limitations and reserves which have arisen in later controversy; and thus the earlier Fathers, especially those of the Eastern Church, where Gnosticism was chiefly to be combated, are found to press earnestly the power for good which man possesses, without entering nicely into the origin or the motive principle of that power. But whatever of vagueness hung over this important subject was dispelled by the bold and precise statements of Pelagius, or at least by the discussion which at once arose thereupon, throughout the entire church. His teaching on the subject of original sin and on the primitive state of man, has been already detailed. See ORIGINAL SIN. The earliest formal embodiment of these doctrines, for the purpose of obtaining upon them the public judgment of the church, was in a number of articles presented to the council of Jerusalem, in 415, by Orosius. See PELAGIUS. Of these, the first five regarded the doctrines already noticed under ORIGINAL SIN. The latter portion of the articles alleged that no grace or aid from God was needed for particular actions, but that free-will and the teaching of the law sufficed; that God's grace is given in proportion to our merits; that free-will would not be free, if it stood in need of aid from God; that the pardon of penitents is not granted according to God's grace and mercy, but according to their own merit and labour;

and that our victory does not come from God's assistance, but from our free-will. Although the final sentence condemnatory of these doctrines (see PELAGIUS) was very generally accepted, yet the recusant party was not wanting in energy and ability. The great champions on each side were Augustine for the orthodox, and Julianus, Bishop of Eclanum, for the Pelagians. Of so much of the controversy as regards original sin, the history has been already related; that on grace and free-will was more subtle, and has led to more numerous divisions on the side of orthodoxy as well as of dissent. In order to evade the condemnation of the doctrine originally ascribed to them as to grace, Pelagius and his followers declared that they did not deny the necessity of grace; but by this name they did not understand any real and internal supernatural aid given by God in each particular action, but only either some general external assistance, such as preaching, the Scriptures, good example, &c. or an aid given which might facilitate and secure the particular work, but which was by no means necessary for its accomplishment. Whether, indeed, they at any time admitted any real internal grace, is a question much disputed. Grace is of two kinds—that which moves the will, and that which enlightens the understanding. It is necessary, too, to distinguish two periods in the history of P.—one before the appearance of the *Epistola Tractoria* of Pope Zosimus; the other, subsequent to that decree. In the first period, it would seem that the Pelagians did not admit the necessity of any internal grace whatever; in the latter, they admitted the necessity of a grace of the intellect, but not of the will; or if they seemed to speak of any internal grace of the will, it was only as facilitating man's act, not as at all necessary to his doing it. The Pelagian theory, in a word, was, that man, as coming from his Creator's hand, possessed in himself, and as constituents of his own nature, all the powers which are necessary for the attainment of salvation; that by the faithful employment of these natural powers, without any further aid whatever from God, he merits eternal life, and all other rewards, by a strict title of justice; and that, to suppose grace to be necessary, is in truth to destroy the essence of free-will. This doctrine was somewhat modified in the Semi-Pelagian System (q. v.). The Catholic schools, all without exception, maintain the necessity of grace for the performance, not only of all meritorious, but of all supernatural good works; and they are equally unanimous in maintaining that the grace so given, even that which is called 'efficacious,' does not destroy the freedom of the will. They distinguish between the 'natural' and the 'supernatural' order, and between the powers and gifts which are proper to the one and to the other. For the attainment of all the ends of the natural order, man possesses, by his very constitution, all the powers and all the gifts which are necessary; and by the proper use of these powers, he is able to merit all the rewards which belong to the natural order. He is able, therefore, without any supernatural grace, to perform morally good works (as acts of natural benevolence, the fulfilment of the ordinary duties to his neighbour, &c.), and to fulfil the purely natural obligations. But in order to works in the supernatural order (such as the love of God above all things for His own sake, faith in Him as the author of all good, &c.), and the rewards which are promised for such works, the will of man must be moved and strengthened by supernatural grace, with which the will freely co-operates, but which is a purely gratuitous gift of God—so purely gratuitous, that although God has promised eternal life as the reward of man's co-operation, yet the merit arises

entirely from God's gift and promise, and not from the natural powers of the human will.

Without going into the details of the teaching of the Catholic schools, it will be enough to particularise the most remarkable among them. Of these, the chief are the Molinist, which, giving most to liberty lies nearest to the border of P., but is clearly distinguished from it by maintaining the necessity of grace for every supernatural act; and the Thomist and Augustinian, which give most to grace, but at the same time expressly preserve the freedom of man's will. The Thomists are often represented as denying the freedom of man's actions under grace; but although it is difficult to explain, in popular language, their method of reconciling both, yet, those acquainted with the scholastic terminology, their distinction between the infallible efficacy of grace, and its imposing necessity on the will, is perfectly appreciable. In this they, as well as the Augustinian school, differ from the Jansenists (q. v.). The Jansenists, indeed, regard the Molinist school as a plain revival of P., and they profess that they alone represent fully, in their own system, the very same position which St Augustine formerly maintained against that heresy in its first origin.

In the Reformed Church, the Arminian doctrine may be said to correspond in the main with the Molinist system in the Roman Church. The Gomarists, in most, although not in all particulars, fall in with the Jansenistic views. The Pelagian views are distinctly represented in modern controversy by the Socinians and Rationalists; and indeed very many of those who, outside of the Roman Church, have at various times engaged in the predestinarian controversy on the side of free-will, have leaned towards, if they have not fully adopted, the Pelagian view. In this controversy, however, the practice, which is not uncommon in polemics, of imputing to an antagonist the extremest views of the particular side to which he leans, has been especially noticeable. The Jesuits have been stigmatised, even by their Catholic antagonists, as Pelagians; the Thomists are called by the Jesuits indiscriminately Jansenists and Calvinists; while both unite in representing Calvin and his school in substance Manichæan.

Hardly one among the many Christian controversies has called forth a greater amount of subtlety and power, and not one has so long and so persistently maintained its vitality. Within the twenty-five years which followed its first appearance, upwards of thirty councils (one of them the General Council of Ephesus) were held for the purpose of this discussion. It lay at the bottom of all the intellectual activity of the conflicts in the medieval philosophic schools; and there is hardly a single subject which has come into discussion under so many different forms in modern controversy. See JANSEN, ARMINIUS, GRACE, PREDESTINATION, REPROBATION, ORIGINAL SIN, TRADUCIANISM.

PELAGIUS, a celebrated heresiarch of the 5th c., author or systematiser of the doctrine known as PELAGIANISM (q. v.). Of his early life, little is known. He was probably born about or before the middle of the 4th c., in Britain, or according to some, in Bretagne, his name being supposed to be a Greek rendering (*Pelagios*, of or belonging to the sea) of the Celtic appellative *Morgan*, or sea-lover. He was a monk, but the time and place of his entering that state are unknown; it is certain, however, that he never entered into holy orders. He settled in Rome, and at the end of the 4th c., had already acquired a considerable reputation for sanctity and for knowledge of the Holy Scriptures and the spiritual life. P. does not appear to have himself been a very active propagandist; but he has

attached to his views a follower of great energy, and a bold and ardent temper, named Celestius, who is generally supposed to have been a Scot, which, in the vocabulary of that age, means a native of Ireland. At Rome, however, they attracted but little notice, although they began to make their doctrine public about 405; and in 410, after the sack of the city by the Goths, they withdrew to Africa. After some time, P. made a pilgrimage to Jerusalem, where he met St Jerome, and for a time enjoyed the regard and confidence of that eminent but hot-tempered scholar. His opinions, however, becoming known, Jerome withdrew from this association. Celestius having remained at Carthage, and sought to be admitted to ordination, his doctrines became the subject of discussion, and in a synod several opinions ascribed to him were condemned. He appealed to Rome, but leaving Carthage without prosecuting the appeal, he passed to Ephesus; and the proceedings taken in Carthage regarding him are chiefly important as having first introduced St Augustine into the controversy. Meanwhile P. remained at Jerusalem, and news of the proceedings at Carthage having been carried to Palestine, P., in 415, was accused of heresy before the synod of Jerusalem, by a Spaniard named Orosius. The impeachment failed, probably from the fact that Orosius was unable to speak Greek, the language of the synod; and in a synod subsequently held at Diospolis in the same year, P. received condemnation by accepting the decrees of the synod of Carthage already referred to, and even obtained from the synod an acknowledgment of his orthodoxy. The West, however, was more sharp-sighted or less indulgent. A synod of Carthage, in 416, condemned P. and Celestius, and wrote to Pope Innocent I., requesting his approval of the sentence, with which request Innocent complied by a letter which is still extant. On the death of Innocent, Celestius came to Rome in person, and P. at the same time addressed a letter to Zosimus, the successor of Innocent; and in a council which Zosimus held, Celestius gave such explanations that the pope was led to believe that the doctrines of P. had been misunderstood, and wrote to call the African bishops to Rome. A council of 214 bishops, however, was held in Carthage, in which the doctrines of P. were formally condemned in nine canons, which were sent to Rome with full explanations; and on receipt of these decrees, Zosimus re-opened the cause, cited and condemned Celestius and P., and published a decree, called *Epistola Tractoria*, adopting the canons of the African council, and requiring that all bishops should subscribe them, under pain of deposition. Nineteen Italian bishops refused to accept these canons, and were deposed. Their leader, and the person who may be regarded as the greatest theological advocate of P. in the ancient controversy, was the celebrated Julian, bishop of Eclanum, near Beneventum, who is well known to every reader of a great antagonist, St Augustine. P. himself was banished from Rome, in 418, by the Emperor Honorius. From this date, P. disappears. Of his later-life, nothing is known in detail. Orosius gives an unfavourable account of his later career, but a period of such excitement, we may not accept implicitly the judgment of an adversary. The controversy, considered as an exercise of intellectual energy, is the most remarkable in the ancient history of the church. But the most important of the writings on the Pelagian side have been lost. Julian is chiefly known through the replies of Augustine. P.'s *Fourteen Books of a Commentary on St Paul's Epistles*, his *Epistle to Demetrius*, and his *Memorial to Pope Innocent*, have escaped destruction probably

from their being included by collectors in the works of St Jerome. They are much mutilated, but yet almost certainly genuine. All his other works have been lost, except some further portions, chiefly fragmentary, which (with the above) have been published under the title of *Appendix Augustiniana*. After his banishment, P. is supposed to have returned to his native country, and to have died there. Others, however, represent him as having died in Palestine. Of his doctrines in detail, an account will be found under PELAGIANISM.

**PELARGONIC ACID** ( $\text{HO}, \text{C}_{17}\text{H}_{33}\text{O}_2$ ) is one of the volatile fatty acids of the general formula  $\text{C}_n\text{H}_{2n}\text{O}_2$ . It is an oily fluid, nearly insoluble in water, but soluble in alcohol and ether. It derives its name from its having been originally obtained from the leaves of *Pelargonium roseum* (see next article), by distilling them with water. It may also be obtained by the oxidation of oleic acid or of oil of rue by nitric acid. The pelargonate of oxide of ethyl,  $\text{C}_2\text{H}_5\text{O}, \text{C}_{17}\text{H}_{33}\text{O}_2$ , is an oily fluid of a very peculiar smell. According to Frankland, it is to this compound that old whisky owes its peculiar flavour; and its addition to new whisky, with a view of giving it an old flavour, is not uncommon.

**PELARGONIUM**, a genus of plants of the natural order *Geraniaceæ*, including many of the most favourite greenhouse flowers, to which the old generic name, *Geranium*, is often popularly given. The characters which distinguish P. from geranium, as now restricted by botanists, are given in the article GERANIUM. The species are numerous, and mostly South African; Australia also producing a few. Some of them are herbaceous, and some are stemless; most of them are half-shrubby. Some have tuberous root-stocks. The leaves exhibit great variety in form, division, &c. The flowers always adhere to a certain type in form, but with great variety in size, colour, &c.; they are always in stalked umbels, which arise from the axils of the leaves, or in the stemless kinds from the midst of the leaves. In no genus has the art of the gardener produced more striking results than in this; and the number of beautiful hybrids and varieties is very great, some of them excelling in beauty any of the original species. Some species, not possessing much beauty of flower, are cultivated for the grateful odour of their leaves, which in some resembles that of roses; in others, that of apples, lemons, &c.; whilst that of many species is rather unpleasant. The cultivation of pelargoniums is similar to that of other *Geraniaceæ*. See GERANIUM. A few of the species endure the open air in the south of England; many are planted out in summer even in Scotland. Water must be liberally supplied to pelargoniums during the time of flowering; but no plants more strongly require a period of rest, and water must then be very sparingly given. Many of the shrubby kinds may be taken out of the soil, hung up by the roots in a dry dark cellar, or covered with hay, and put aside in a box, in a cool dry loft or garret, care being taken, however, to protect them from frost. Every leaf should be removed before they are taken up, and young watery shoots should be cut off. Another method of treating them is to cut off every leaf before frost comes, and to keep the plants all winter in their pots in a dry cool room, without giving them a drop of water. By such means, many of this beautiful genus are successfully cultivated by persons who have no greenhouse.

**PELAGIANS**, variously explained as denoting either 'Swarthy Asiatics' (*Pell-Asici*) or 'Storks' (*Pelargoi*)—significant of wandering habits; or as being derived from the biblical *Peleg* (Gen. x. 25),

from the Greek *Pelagos* (the Sea), *pelazo* (to approach), or *pelein* and *agros* (to till the field), &c.—‘a name, in fact,’ as Niebuhr says, ‘odious to the historian, who hates the spurious philology out of which the pretences to knowledge on the subject of such extinct people arise’—designates a certain tribe or number of tribes who inhabited Italy, Thracia, Macedonia, a part of Asia Minor, and many other regions of Southern Europe, in prehistoric times. Ethnologically, they belong to the same race as the great stock of the earliest known settlers, that reached from the Po and the Arno to the Rhyn-dakus (near Kyzikus). Yet no Pelasgian town or village existing in Greece Proper after 776 B.C., speculation has, ever since the commencement of European historiography, been busy trying to supply the facts that were wanting to ascertain the exact origin and history of these predecessors of the Hellenes and Romans; and so futile have all efforts in this direction remained, that the very term Pelasgi has, from the days of Homer to our own, been used almost arbitrarily to designate either a single obscure division of a tribe like the Leleges and the Dolopes, or as an equivalent for all the Greeks of a very early period. In this latter sense, they are spoken of by Æschylus, Herodotus, Homer; while they are considered one of the branches of the race or races that peopled Greece, by Thucydides, Strabo, and most modern writers, the word thus not being a comprehensive term, like Arian, but a narrowly circumscribed one, like Hindu. Recent investigation seems, as regards their previous history, to lead to the result, that soon after the first immigration of Turanians, they, like other tribes, left their Asiatic homes, and proceeded towards Europe. They are found at a very early period settled in Asia Minor; and Homer speaks of them as allies of the Trojans. They then seem to have spread themselves, by way of the Propontis and Ægean, and again by Crete, over many of the islands between the two continents; and finally, came to occupy a great part of the Hellenic mainland—Thessaly, Epirus, the Peloponnese, Attica, Macedonia, Arcadia, provinces which, one and all, up to the latest period, bore distinct traces of the once undisputed sway of the Pelasgians. According to Herodotus, the Hellenes themselves sprang from them; and there can hardly be a doubt that they formed a most important element in the formation as well of that most gifted of nationalities, as of the Latin people. The early Etruscans (q. v.) were P. to a certain extent; and the southern tribes of the Peucetians, Ænotrians, and Iapygians are distinctly declared by ancient writers to belong to their race. The step from Greece into Italy is natural enough. What caused their wanderings originally, is difficult to conjecture; but it may not unreasonably be assumed, that they were caused to a certain extent by immigrations of eastern tribes, such as the Lydians, Phrygians, Carians, who pushed them further and further west, as they took possession of their old homes. A special stock was formed by the Tyrrhenian Pelasgi, whose gradual advance in Greece may be traced from Acarnania to Bœotia, thence to Attica, and later still, to the Hælespont, Lemnos, &c. A strong protest, however, must be recorded here on the part of some modern writers against the assumption of others, that the P. were in reality the original population of all Italy, as they were of the greatest part of Greece (Pelasgia). It is absurd, they argue, to suppose that a rich and populous nation, which had held a country like Italy for many centuries, should suddenly, just at the approach of historical times, die out without leaving even such single remnants as the Pelasgic settlements in Greece mentioned by Herodotus. These aboriginal Italian P. are, according to them, neither

more nor less than a mere hypothesis of ignorant ancient writers, who wished to explain the ethnological and philological affinity between the two classical nations in an easy manner, and who, anticipating the questions about a contemporary colony kill the whole nation off by pestilence and famine.

The Pelasgians, from what we can glean about them, would appear to have been a highly intellectual, receptive, active, and stirring people, of simple habits withal, chiefly intent upon agricultural pursuits. Several improvements in this province were distinctly traced back to them, such as the ploughing with oxen—for which purpose they had to invent the special goad; further, the art of surveying, and the like. Yet they were no less warlike when attacked and driven to self-defence as the trumpet, which calls the widely scattered troops to the attack, was supposed to have been first used by them. That the art of navigation was well known to them, is shewn sufficiently by their incessant migrations over sea and land. Of their architecture, in that style which, in default of a better name, has been called Cyclopean (q. v. remnants are still existing. The names Larissa, Argos, Ephyra, frequently met in ancient Greece were bestowed by them upon their fortified cities and are only generic names, expressive of either mountain fortresses or strongholds in plains. Wishing to remain in peace, they endeavoured to keep off the invader by walls so enormously strong, that it really seems most surprising how they ever could have been taken. Besides these, they built canals, dams, and subterranean water-works of astounding strength and most skilful construction. The accompanying woodcut represents the

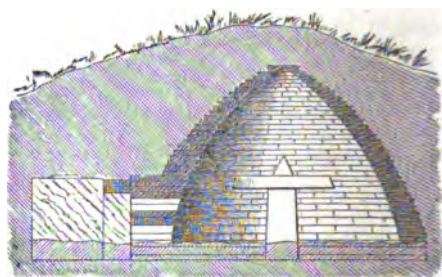

Fig. 1.—Section of Tomb of Atreus at Mycenæ.

tomb or treasury of Atreus at Mycenæ, vaulted with a fine pointed ‘horizontal arch,’ 48½ feet in diameter. Of their sculpture, which they no doubt likewise cultivated to a certain degree, we have but very small relics, such as a head of Medusa, and

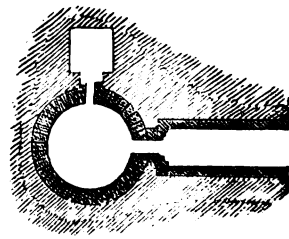

Fig. 2.—Plan of Tomb of Atreus at Mycenæ.

Xoanon (Divine Image) of Orpheus; besides these certain traces of their special mystic worship are to be found in archaic representations

which, though not hitherto ascribed to them, bear their direct influence upon their very face. How far they were either the inventors of the so-called Phœnician or Phœnician writing-characters, from which all European characters are derived, or merely their 'improvers,' is not to be decided by the contradictory evidence to be found on the subject: but this, at all events, is certain, that they were acquainted with the art of writing, and had as a vast element of culture in their possession before the dawn of history. Respecting their religion and worship, there is this only to be held with certainty, that it originally consisted in a mystic service of those natural powers, whose influence is chiefly visible in the growth of the plants of the earth. From Egypt they obtained names for their till then nameless gods, generally called by them the Theoi; and they proceeded by permission of the Dodonic oracle, which, together with the Pythian, they first founded—bestow them upon them individually. Their deities were, besides the Phœnician Kabiri, Demeter, Persephone Kora, Dionysos, Hermes, Zeus of Dodona, Apollo, Hephæstus, Themis, Pan, &c. Whether those P. who inhabited Lemnos and Imbros, and who were conquered by Darius, offered up human sacrifices or not, is doubtful. An ambiguous term Herodotus respecting the language of those small Pelasgian remnants who had survived to his day, has given rise to endless and most unsatisfactory discussions. He speaks (i. 57) of their 'barbarous language;' and the question is, whether he meant that it completely differed from Greek, or that there was only so vast a divergence of dialect, that it had become unintelligible to his contemporaries. Grote inclines to the former opinion; Niebuhr, Bunsen, and Müller, followed by G. Rawlinson and others, hold, with more apparent show of reason, that the term 'barbarous language' merely indicates a corruption or alteration of idiom, such as a long lapse of time would infallibly produce, and that it bore the same relation to the Greek of the day as the Gothic does to the German, or the Latin to any of the Romance languages, nor is this instance the forlorn patois of out-of-the-way places in Switzerland and elsewhere, supposed to be inhabited by unmixed descendants from Roman legions. That other phenomenon of the vast number of roots common both to Greek and Latin—the latter, it must be remembered, having been proved to be derived, not from the former, but from the Oscan—would thus easily be explained by the assumption of a common Pelasgian linguistic stock (as well as ethnical) stock in both nationalities. Their political circumstances are as unknown to us as the whole process of transition between them and the real Greek period. From a few scattered discussions, we may conclude, that they were not uniformly governed; that some of their multifarious tribes were ruled by priests, while others stood under the patriarchal rule of the head of the clan family. How they gradually disappeared from the rank of nations, by being either 'absorbed' by superior races (Hellenes, Italici, Carians, Lydians, Phrygians), or being reduced to nameless serf-populations, does not seem so difficult to understand as some writers would have it. Hundreds of nations have disappeared in the same manner, and we may even watch the process with our own eyes. Interesting as it might be to dwell more minutely on some of the widely divergent theories and speculations upon the P. on the part of historians, philologists, ethnologists, antiquaries, and investigators generally, to whom, at all times, this people proved exceedingly attractive, we cannot enter any further upon them

here, but we shall conclude with Grote's dictum: 'If any man is inclined to call the unknown ante-Hellenic period of Greece by the name of Pelasgic, it is open to him to do so. But this is a name carrying with it no assured predicates, noway enlarging our insight into real history, nor enabling us to explain what would be the real historical problem—how, or from whom, the Hellenes acquired that stock of dispositions, aptitudes, arts, &c., with which they begin their career.'

PELAYO, said by historians to have been the first Christian king in Spain, after the conquest of that country by the Arabs. Contemporary historians make no mention of him, but this may be accounted for on the ground of the insignificant size of his kingdom, which comprised only the mountainous district of Asturias. He is said to have been a scion of the royal Visigothic line, and to have retired before the conquering Arabs to the mountains of Asturias, where he maintained himself against the armies which were sent to attack him, defeating them in various pitched battles, and in numberless minor engagements. One of his most famous exploits was the destruction of a large army sent against him by Tarik, near Cangas-de-Onis. His men were posted on the heights bounding the valley through which the Arabs were to pass, and, waiting till the enemy had become involved in the defile, at a given signal, overwhelmed them with enormous masses of rock. This great success caused P. to be recognised as sovereign by the surrounding districts, and the Christians flocked to him from all parts of Spain. He was much engaged in contests with the Arabs, but nevertheless found time to reanimate agriculture, superintend the reconstruction of churches, and the establishment of a civil administration. He died in 737. Such is the account given us by later historians, who trace from him the genealogy of the royal family of Spain.

PELECA'NIDÆ, a family of palmiped birds, the *Totipalmati* of Cuvier; characterised by a long, straight, compressed bill, broad at the base, often with a pouch beneath the lower mandible; long wings, of which the first quill is the longest; short strong legs, and all the toes—including the hind toe—united by a membrane. They are generally excellent swimmers, expert divers, and birds of powerful flight. Some of them often perch on trees, which few other web-footed birds do. To this family belong pelicans, cormorants, frigate-birds, tropic-birds, and darters.

PELEW' ISLANDS, a group of islands in the North Pacific Ocean, 450 miles east of the Philippines, in lat. 7°—8° 30' N., long. 134°—136° E., at the western extremity of the Caroline Archipelago. The group includes about 20 islands, which form a chain running about 120 miles from south-south-west to north-north-east. The principal island is Babelthouap, 28 miles by 14, containing a mountain from whose summit a view of the whole group is obtained. As seen from the sea, the islands appear mountainous and rugged; but the soil is rich and fertile, and water is abundant. Bread-fruit, cocoa-nuts, bananas, sugar-cane, lemons, oranges, and other tropical trees and fruits, are grown. Cattle, fowls, and goats thrive, and fish abound on the coasts. The inhabitants, who are estimated at about 10,000 in number, are of the Malay race. They shew considerable ingenuity in building their canoes, are active agriculturists, and entertain exceedingly primitive notions regarding dress, as the men go entirely naked, and the women nearly so. In 1783, the *Antelope* was wrecked upon the P. I., and the crew were treated by the natives with the greatest kindness. Further



acquaintance with white men, however, seems to have altered their disposition, and several vessels, while visiting these islands, within comparatively recent years, have narrowly escaped being cut off. The islands are said to have been discovered by the Spaniards in 1545.

**PELICAN** (*Pelecanus*), a genus of birds of the family *Pelecanidae* (q. v.), having a very long, large, flattened bill, the upper mandible terminated by a strong hook, which curves over the tip of the lower one; beneath the lower mandible, which is composed of two flexible bony branches meeting at the tip, a great pouch of naked skin is appended; the tongue is very short, and almost rudimentary; the face and throat are naked; the wings of moderate length, the tail rounded. The species are widely distributed, frequenting the shores of the sea, lakes, and rivers, and feeding chiefly on fish. Although birds of powerful wing, they are seldom seen at a great distance from land. All of them are birds of large size. They take their prey by hovering over the water, and plunging upon it when it appears. They often fly in large flocks, and the sudden swoop of a flock of pelicans at a shoal of fish is a striking and beautiful sight. They store up their prey in their pouch, from which they bring it out at leisure, either for their own eating, or to feed their young. The pouch is capable of being wrinkled up into small size, and of being greatly distended.—The COMMON P. (*P. onocrotalus*) is as large as a swan, white, slightly tinged with flesh colour, and in old birds,



Pelican (*Pelecanus onocrotalus*).

the breast golden yellow. The quill-feathers are black, but are scarcely seen except when the wings are expanded. It is a native of the eastern parts of Europe, and of many parts of Asia and Africa, and frequents both the sea-coast and also rivers and lakes. It makes a nest of grass on the ground in some retired spot near the water, often on an island, and lays two or three white eggs. The parents are said to carry water to their young, as well as food, in their pouch. During the night, the P. sits with its bill resting on its breast. The nail or hook which terminates the bill is red, and Mr Broderip supposes that the ancient fable of the P. feeding its young with blood from its own breast has originated from its habit of pressing the bill upon the breast, in order the more easily to empty the pouch, when the red tip might be mistaken for blood.—The RUFIOUS-NECKED P. (*P. fuscus*) abounds in the West Indies and in many parts of America. Other species are found in other parts of the world, and in some places the number of pelicans is prodigious, particularly in some of the most southern parts of the world.

In Heraldry, the Pelican is drawn with her wings

endorsed, and wounding her breast with her beak. When represented in her nest feeding her young with her blood, she is called a pelican in her piety.

**PE'LION**, the ancient name of a wooded mountain range in Thessaly, extending along the east coast. Its eastern side descends in steep and rugged precipices to the sea. Further to the north, near the mouth of the Peneus, is the steep conical peak of Ossa (q. v.), which, according to the classic myth, the Titans placed upon the summit of P., in order to scale Olympus, the abode of the gods. The modern name is Zagorá, and of old, its sides and summit are clothed with venerable forests of oak, chestnut, beech, elm, and pine.

**PELISSIER**, AIMABLE JEAN JACQUES, Marshal of France, Duc de Malakhoff, born in 1794 at Maromme, near Rouen. His father was a small farmer, little above the degree of a peasant. P. was first sent to the Lyceum at Brussels. At twenty, he gained admission to the celebrated French artillery college of La Flèche, and was soon transferred to the special school of St Cyr. He entered the artillery of the Royal Guard as sub-lieutenant in 1814, and being transferred to the 57th Regiment of the line, which was not called upon to do duty after the return of Napoleon from Elba, he escaped the dilemma of declaring either for or against the Emperor. He served on the staff in Spain in 1823, made the campaign of the Morea in 1829; joined the first expedition to Algiers in 1830 as major of cavalry; and in 1839 returned to Algeria with the rank of lieutenant-colonel. He commanded the left wing of the French army at the battle of Isly. In 1845, he acquired an unenviable notoriety by suffocating more than 500 Arabs who took refuge in the caves of Ouled-Kiah in the Dahra. Marshal Soult, then Minister of War, did not venture to approve this atrocity, but Marshal Bugeaud, commander-in-chief in Algeria, declared that P. obeyed his positive orders. By 1850, he had attained the rank of General of Division. When the news of the *coup d'état* reached Algiers, he espoused the cause of the emperor, and placed the province of Algiers under martial law until order was restored. In the war with Russia, he obtained in 1855 the command of the first corps of the Crimean army, and soon succeeded Marshal Canrobert in the chief command, when a change came over the fortunes of the campaign. The Russians were defeated on the Tchernaya, and on the 8th of September the Malakhoff, the key of Sebastopol, was carried. After the fall of Sebastopol, he received a marshal's baton, and on his return to France, was created Duc de Malakhoff and senator, and received a dotation of 100,000 francs. He also received the order of a G.C.B. from Queen Victoria. In 1858, he came to London as the French ambassador, but resigned his post, for which he had little relish, in the following year. He was then named Governor-general of Algeria, where he died (May 1864) of congestion of the lungs.

**PELLA**, the ancient capital of Macedonia, and the birthplace of Alexander the Great, was situated on a hill, and surrounded by marshes. It was wealthy and powerful city, but declined under the Romans until it became a place of no consequence, and in the middle ages there remained only a strong castle called *Bodena*. Its site has been identified



Pelican, in Heraldry.

PELLAGRA—PELLITORY OF SPAIN.

with that of the village of *Neokhori* or *Yenikiuy*, near which is a spring called *Pella*.

**PELLAGRA**, at one time, the name of a loathsome skin-disease, supposed to be endemic to the rice-producing part of the north of Italy, is now employed to designate a group of phenomena, of which the most prominent and significant are mental. Allied affections have recently been described in various continental countries; but as presented in its most intense form in Lombardy, *Pellagra* consists in the skin being covered with tubercles and rough scales, in debility, vertigo, inability to preserve the equilibrium, epilepsy, and great depression of spirits. The melancholia which constituted the latter stage often led to suicide, and so frequently to destruction by drowning, that it was distinguished as a special form of the tendency by the appellation of *Hydromania*. The extent of the ravages of this affection may be estimated from the facts, that of 500 patients in the Milan Lunatic Asylum in 1827, one third were pellagrins; that when *Strambio* wrote (1784), one of every twenty, and when *Holland* (1817), one of every five or six of the population presented symptoms of the disease. The belief, so long current, that this malady was the result of the use of rice or maize as the chief article of diet, must now be greatly modified, as it has been observed in districts and under circumstances where the food is of a different description; but where poverty, insufficient nourishment, filth, toil, and the ordinary agents in human degeneration are at work.

**PELLET**, or **OGRESS**, in English Heraldry, a Roundle (q. v.) sable.

**PELLICO**, **SILVIO**, an Italian poet, celebrated for his long and cruel imprisonment by the Austrians, more, perhaps, than for his verses, was born in 1783 at *Saluzzo*, in Piedmont, and was educated in *Pignerol*, where his father, *Onorato Pellico*, also favourably known as a lyric poet, had a silk-factory. In his 16th year, he accompanied his sister *Rosina* (on her marriage) to *Lyon*, where he remained until *Foscolo's Carme de Sepolcri* awakened in him a strong patriotic feeling and an irresistible desire to return to Italy. Coming, about 1810, to *Milan*, where his family were now settled, he was warmly received by *Ugo Foscolo* and *Vincenzo Monti*, and was employed as tutor in the family of *Count Porro*, in whose house all the most distinguished men in *Milan* were accustomed to meet. His tragedies of *Laodamia* and *Francesca da Rimini* gained him an honourable name amongst Italian poets. He also translated the *Manfred* of *Byron*, with whom he had become acquainted. He lived in great intimacy with the most eminent patriots and authors of liberal views, and took an active part in a periodical called *Il Conciliatore*, which after a time was suppressed on account of its liberal tone. Having become connected with the secret society of the *Carbonari*, then the dread of the Italian government, *P.* was apprehended in 1820, and sent to the prison of *Sta Margherita*, where his friend, the poet *Maroncelli*, was also confined. In the beginning of the following year, he was carried to *Venice*, and in January 1822, to the prison on the isle of *San Michele*, near *Venice*; and *Maroncelli* and he were at last condemned to death; but the emperor commuted the sentence to 20 years' imprisonment for *Maroncelli*, and 15 years for *Pellico*. In March 1822, they were both conveyed to the subterranean dungeons of the *Spielberg*. In August 1830, however, they were set at liberty. *P.* published an account of his sufferings during his ten years' imprisonment, under the title *Le mie Prigioni* (*Paris*, 1833), which has been translated into other

languages, and has made his name familiar where it would not have been known on account of his poetry. *P.*'s health, never robust, was permanently injured. The Marchioness of *Barolo* received him into her house at *Turin* as her secretary. *P.* subsequently published numerous tragedies and other poems, and a little catechism on the duties of man. His death took place January 31, 1834.

**PELLITORY**, or **PELLITORY OF THE WALL** (*Parietaria*), a genus of plants of the natural order

*Urticeae*, having both unisexual and hermaphrodite flowers on the same plant, the perianth of both kinds 4-fid. The COMMON *P.* (*P. officinalis*), which grows on old walls and heaps of rubbish in Britain and many parts of Europe and Asia, is a herbaceous perennial, with prostrate branched stems, more rarely with erect stems, ovate leaves, and inconspicuous flowers. It sometimes attracts attention from the manner in which the pollen is copiously discharged in hot summer days by an elastic movement of the filaments. It was formerly much esteemed as a diuretic, refrigerant, and lithontriptic. Its properties depend on nitre, which it contains.



*Pellitory (Parietaria officinalis).*

**PELLITORY OF SPAIN** (*Anacyclus pyrethrum*), a plant of the natural order *Compositae*, of a genus nearly allied to *Chamomile* (q. v.), a native of the *Levant* and of *Barbary*, and cultivated to some extent in *Germany* and other countries. It has procumbent, branched, downy stems; each branch one-flowered; the root-leaves pinnate, with pinnatifid segments and linear-subulate lobes. The flowers (heads of flowers) have a white ray, purplish beneath, and a yellow disc. The root is spindle-shaped and fleshy, and when dried, is about the thickness of the little finger, inodorous, breaking with a resinous fracture. It has a very peculiar taste, slight at first, but becoming acidulous, saline, and acrid, with a burning and tingling sensation in the mouth and throat, which continues for some time. It is valued in medicine, and is chewed or administered in the form of a tincture to relieve toothache, also in cases of paralysis of the tongue, as a sialogogue in certain kinds of headache, and of rheumatic and neuralgic affections of the face, and is used as a gargle in relaxation of the uvula. The powder of it enters into the composition of certain cephalic snuffs, and is rubbed on the skin in some eastern countries, to promote perspiration. It is the *Radix pyrethri* of the pharmacopoeias. It is a powerful local irritant. The plant cultivated in *Germany* has more slender roots than that of the *Levant*, and has sometimes been described as a distinct species (*A. officinarum*), but is probably a mere variety.

**PELLS, CLERK OF THE** (Lat. *pellis*, a skin), a clerk belonging to the Court of Exchequer in England and Ireland, whose office was to enter every teller's bill into a parchment or skin, called *pellis receptorum*, and also to make another roll of payments, which was called *pellis exitum*, and which shewed the warrant under which the money was paid. The office was abolished in 1834 by the statute 4 and 5 Will. IV. c. 15, which transferred the duties to the comptroller-general, who thereupon assumed the custody of the records; and the Treasury thereafter established new forms of books, accounts, and warrants.

**PELOPIDAS**, a celebrated Theban general, of noble descent, noted among his fellow-citizens for his disinterested patriotism. The inviolable friendship between himself—one of the richest men in Thebes—and Epaminondas—one of the poorest—is among the most beautiful things recorded in Greek history. In 382 B. C. he was driven from Thebes by the oligarchic party, who were supported by the Spartans, and forced to seek refuge at Athens, whence he returned secretly with a few associates, 379 B. C., and recovered possession of the Kadmeia, or citadel, slaying the Spartan leader, Leontiades, with his own hand. Plutarch gives us a vivid picture of the adventurous exiles gliding quietly in disguise into the city on a winter afternoon, amid bitter wind and sleet. Having been elected *Bæotarch*, in conjunction with Melon and Charon, he set about training and disciplining his troops, so that they soon became as formidable as the Lacedæmonians, and were successful in several small encounters with the latter. His 'sacred band' of Theban youth largely contributed to the victory of Epaminondas at Leuctra (371 B. C.), but failed in a subsequent attack on Sparta itself. In the expedition of the Thebans against the cruel tyrant, Alexander of Phææ (368 B. C.), he was, after several important successes, treacherously taken prisoner, when in the character of an ambassador; but was rescued by Epaminondas in the expedition of the following year. He was then sent to Susa, as ambassador from Thebes, to counteract the Spartan and Athenian intrigues going on at the court of Persia, and behaved himself very nobly while there. His diplomacy was successful. In 364 B. C., a third expedition was planned against Alexander of Phææ, who, as usual, was threatening the Thessalian towns. The command was given to P., and in the summer he marched into Thessaly, where he won the battle of Kynoscephalæ, but was himself killed while too eagerly pursuing the foe. He was buried by the Thessalians with great pomp.

**PELOPIUM** was the name given, about the beginning of the present century (1802), by Rose to a new metal, which he thought he had discovered in the mineral Columbite. It was subsequently ascertained that it was identical with Niobium.

**PELOPONNESIAN WAR.** See GREECE.

**PELOPONNESUS** (i. e., the isle of Pelops), now called the Morea (q. v.), a peninsula, which formed the southern part of ancient Greece, Hellas Proper being situated to the northward of the isthmus, on which stood the city of Corinth. See GREECE. The whole area is less than 9000 square miles. In the most flourishing periods of Grecian history, the P. had a population of more than two millions, although at present it has little over half a million. Among its most important cities were Sparta in Laconia, and Argos the capital of Argolis. Sparta acquired, after the Messenian War, a decided supremacy over the other states, and disputed the supremacy with Athens in a war of almost thirty years' duration (431—404 B. C.)—

the famous 'Peloponnesian War,' of which the history has been written by Thucydides. After the Roman conquest, the P. formed part of the province of Achaia, and subsequently belonged to the Byzantine empire. For its later history, see MORÆA.

**PELOPS**, in Greek Mythology, the grandson of Zeus, and the son of Tantalus, was slain by his father, and served up at an entertainment which he gave to the gods, in order to test their omniscience. They were not deceived, and would not touch the horrible food; but Ceres, being absorbed with grief for the loss of her daughter, ate part of a shoulder without observing. The gods then commanded the members to be thrown into a cauldron, out of which Clotho brought the boy again alive, and the want of the shoulder was supplied by an ivory one. According to the legend most general in later times, P. was a Phrygian, who, being driven by Ilos from Siplyos, came with great treasures to the peninsula, which derived from him the name of Peloponnesus, married Hippodamia, obtained her father's kingdom by conquering him in a chariot-race, and became the father of Atreus, Thyestes, and other sons. But in what appear to be the oldest traditions, he is represented as a Greek, and not as a foreigner. He was said to have revived the Olympic games, and was particularly honoured at Olympia.

**PELTRY**, a general term applied to the trade in skins of wild animals, and to the skins themselves. It is understood to mean only skins undressed, except by drying, and chiefly those which, when dressed, are called furs, and it is especially applied to the produce of North America and the Hudson's Bay Territory, although all others are included. The following table will shew the kind of skins meant, and the vast destruction of animal life which is necessitated by this valuable branch of commerce.

PELTRIES IMPORTED INTO GREAT BRITAIN IN 1880.

Common Name.	From Hudson's Bay Territories.	From other Countries.	Total Imports.
Badger, . . .	1294	56.8	6912
Bear, . . .	8043	10,549	18,592
Beaver, . . .	108,130	118,176	226,306
Cat, . . .	...	19,688	19 6.8
Chinchilla, . . .	...	18,544	18,544
Deer, . . .	2695	73,891	76,586
Dog, . . .	...	3142	3142
Elk, . . .	12	363	375
Ermine, . . .	1251	313,909	315,160
Fisher, . . .	6430	10,869	17,299
Fitch, . . .	...	24,371	24,371
Fox, . . .	21,211	107,518	128,729
Goat, . . .	6430	4439	10 8.9
Hare, . . .	215	2,108 446	2,108 261
Kid, . . .	...	485,480	485,480
Kollinaki, . . .	...	61,965	61,965
Lamb, . . .	...	1,194,592	1,194,592
Leopard, . . .	...	186	186
Lion, . . .	...	19	19
Lynx, . . .	15,969	19,072	35,041
Marmot, . . .	...	232	232
Marten, . . .	77,979	98,769	176,748
Mink, . . .	32,699	116,926	149,625
Monkey, . . .	...	5787	5787
Mongoose, . . .	305,694	2,062,059	2,267,753
Neutria, . . .	...	1,045,345	1,045,345
Otter, . . .	13,519	27,180	40,699
Oter, Sea, . . .	137	165	302
Panther, . . .	...	78	78
Rabbit, . . .	29,972	216,039	246,011
Raccoon, . . .	2636	787,892	790,528
Sable, . . .	...	332	332
Seal, . . .	10,471	561,677	572,148
Sheep, . . .	...	2,257,918	3,2 7 918
Skunk, . . .	3769	134,617	138,386
Squirrel, . . .	10,471	164,976	175,447
Swan, . . .	1043	2932	3975
Tiger, . . .	...	380	380
Weasel, . . .	...	463	463
Wenuak, . . .	3639	...	3639
Wolf, . . .	6059	6186	12,245
Wolverine, . . .	1398	1453	2851

## PELUSIUM—PELVIS.

The pelts of many animals in their original state do not appear well fitted for decorative or even ordinary apparel, but the art of the furrier changes them greatly. The recent discovery, that the long hairs which project over the fine under-fur of many species, are also deeper rooted in the skin, has given rise to an easy and admirable method of removing them very completely. The pelts are stretched and passed through a paring-machine, which pares the flesh-side with such nicety that it takes off a thin layer, and cuts only through the roots of the coarse, deep-seated hairs, which are consequently easily shaken or brushed out. In this way, and by dyeing the fur, beautiful imitations of the costly seal-skins, &c., are prepared from musquash, hare, and other common pelts.

**PELUSIUM**, the Greek name of an ancient Egyptian city, situated at the north-eastern angle of the Delta, and important as the key of Egypt on the Asiatic side. The eastern mouth of the Nile derived from it the epithet Pelusian (*Ostium Pelusiacum*). P. is called *Sin* in the Old Testament; and both words, as well as the native Coptic or Egyptian name *Peremoun*, or *Peromi*, signify the mud-city. The *Ostium Pelusiacum* was choked up with sand as long ago as the 1st c. B. C., and its distance from the sea has ever since been increasing. P. appears to have originally borne the name of Anaris, or Abaris. It is so called by Manetho, who attributes its foundation to the Hyksos about 2000 B. C.; but it first figures in semi-authentic history as the scene of Sennacherib's defeat, when (according to the Egyptian tradition, as reported by Herodotus), the camp of the Assyrians was invaded at night by a host of field-mice, who gnawed their bowstrings and shield-straps, so that in the morning, when the Egyptians fell upon them, they were defenceless. For the Hebrew account of Sennacherib's defeat see 2 Kings, chaps. 18 and 19. In 525 B. C., Cambyzes overthrew, near P., the forces of Pharaoh-Sammetichus. The city was also taken by the Persians in 309 B. C.; and in 173 B. C., it was the scene of the defeat of Ptolemy Philometor by Antiochus Epiphanes. Mark Antony captured it, 55 B. C., and it opened its gates to Octavian after his victory at Actium, 31 B. C. Its later history is unimportant, and its ruins—at *Tineh*, near Damietta—possess little interest.

**PELVIS**, THE (from the Latin *pelvis*, a basin), is a bony ring interposed between the spinal column and the lower extremities, so as to transmit the weight of the former to the latter. Before considering the pelvis as a whole, it will be expedient to consider the individual bones of which it is composed. These, in the adult, are four in number, viz., the two *ossa innominata* which constitute the sides and front, and the *sacrum* and *coccyx*, which complete it behind. The *os innominatum* receives its name from its bearing no resemblance to any known body, and is a large irregular-shaped bone. In the young subject, it consists of three separate bones, which meet and form the deep, cup-shaped cavity (the *acetabulum*), situated a little below the middle of the outside of the bone, and in which the head of the thigh-bone rests. Hence it is usual to describe this bone as consisting of the *ilium*, the *ischium*, and the *pubes*. The *ilium* is the superior, broad, and expanded portion which forms the prominence of the hip, and articulates with the *sacrum*. This bone may be described as divisible into an external and an internal surface, a crest, and an anterior and posterior border. The external surface (see fig. I.) is convex in front, and concave behind; it is bounded above by the crest,

below by the upper border of the *acetabulum* (see fig. II.), and in front and behind by the anterior and posterior borders. It presents various curved lines and rough surfaces for the attachment of the *glutæi* and other powerful muscles connecting the pelvis and the lower extremities. The internal surface, which is smooth and concave, has the same boundaries as the external, except inferiorly, where it terminates in a prominent line, termed the *linea ilio-pectinea*. The surface of the crest is convex, roughened, and sufficiently broad to admit of the attachment of three planes of muscles. The borders will be sufficiently understood by a reference to fig. I. The *ischium* is the inferior and strongest

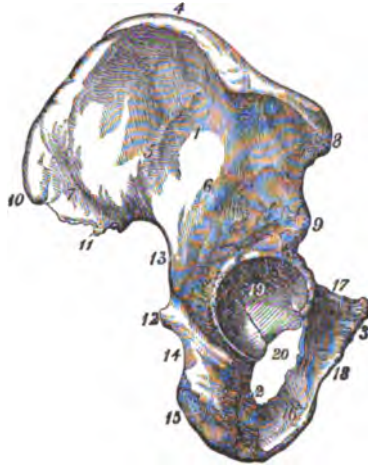

Fig. I.

The *Os Innominatum* of the right side.

1, the *ilium*, its external surface; 2, the *ischium*; 3, the *os pubis*; 4, the crest of the *ilium*; 5, 6, upper and lower curved lines for attachment of muscles; 7, the surface for attachment of the *gluteus maximus*; 8, 9, the anterior superior and inferior spinous processes; 10, 11, the posterior superior and inferior spinous processes; 12, the spine of the *ischium*; 13, 14, the greater and lesser sacro-ischiatic notches; 15, the tuberosity of the *ischium*; 16, its *ramus*; 17, the body of the *os pubis*; 18, its *ramus*; 19, the *acetabulum*; 20, the thyroid or obturator foramen.—(From Wilson.)

portion of the bone. It consists of a thick and solid portion, the *body* (whose inferior border is termed the *tuberosity*), and a thin ascending portion, the *ramus*. In the ordinary sitting position, the whole weight of the body rests on the *ischium*; and by sitting on the hands, we can usually feel the part (the *tuberosity*, see fig. I. 15) through which the weight is transmitted. The *pubes* is that portion which runs horizontally inwards from the inner side of the *acetabulum* for about two inches, and then descends obliquely outwards for about the same length, thus making an acute angle with its original direction. The former part is called the *body*, and the latter the *ramus*, of the *pubes*. The *ramus* is continuous with the *ramus* of the *ischium*. Between the *ischium* and *pubes* is a large aperture, known as the *thyroid* or *obturator foramen*, which in the living body is closed by a membrane termed the *obturator ligament*. The object of this large foramen is probably to give lightness to the parts, without materially diminishing their strength.

The development of the *os innominatum* affords an excellent example of the general principles laid down in the article **OSIFICATION**. There are no less than eight centres of ossification for this bone: three primary—one for the *ilium*, one for the

## PELVIS.

ischium, and one for the pubes—and five secondary ones for various processes, &c. The first centre appears in the lower part of the ilium, at about the same period that the development of the vertebrae commences, viz., at about the close of the second month of fetal life; the second in the body of the ischium, just below the acetabulum, at about the third month; and the third in the body of the pubes, near the acetabulum, during the fourth or fifth month. At birth, the crest of the ilium, the bottom of the acetabulum, and the rami of the ischium and pubes, are still cartilaginous. At about the sixth or seventh year, these rami become completely ossified; next, the ilium is united to the ischium; and lastly, the pubes is joined to the other two in the acetabulum. The complete ossification of the bone, from the secondary centres in the crest of the ilium, the tuberosity of the ischium, &c., is not completed till about the twenty-fifth year.

Each os innominatum articulates with its fellow of the opposite side (through the intervention of the *interosseous fibro-cartilage*, which unites the two surfaces of the pubic bones, see fig. II. f), with the sacrum, and with the femur (at the acetabulum). No less than thirty-five muscles are attached to this bone, some proceeding to the region of the back, others forming the walls of the abdomen, others forming the floor of the pelvis, others passing downwards to the lower extremities, &c. As the other

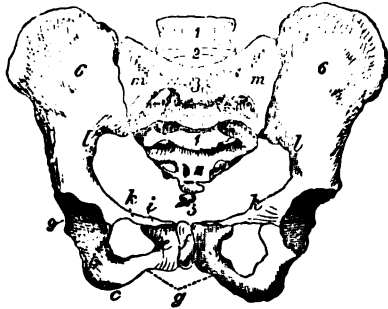

Fig. II.

Pelvis (with Fifth Lumbar Vertebra) of European Female Adult. Transverse diameter, 5 7/8; antero-posterior diameter, 4 5/8 inches.

1, the last lumbar vertebra; 2, the inter-vertebral substances connecting it with the sacrum; 3, the promontory of the sacrum; 4, its anterior surface; 5, the coccyx; 6, 6, the iliac fossae; 9, the acetabulum; c, the tuberosity, and d the body of the ischium; e, the os pubis; f, the symphysis pubis; g, the arch, h, the spine, and k the pectineal line of the pubis; k, l, k, l, the ilio-pectineal lines.—(From Humphry.)

bones entering into the formation of the pelvis, the sacrum, and the coccyx, belong essentially to the vertebral column, and will be described in the article on that subject, it is sufficient here to remark that, collectively, they form a triangular bony mass (with the base upwards, and with a concave anterior surface), which constitutes the posterior part of the pelvic ring. See fig. II. 4, 5.

The pelvis, considered as a whole, is divisible into a false and true pelvis. The *false pelvis* is all that expanded portion which is bounded laterally by the iliac bones, and lies above the prominent line termed the *linea ilio-pectinea* (see fig. II. k, l); while the *true pelvis* is all that part of the general pelvic cavity which is situated below that line. The broad, shallow cavity of the false pelvis serves to support the weight of the intestines; while the rectum, bladder, and part of the generative organs, lie in the cavity of the true pelvis. The upper aperture of the true pelvis is termed the *inlet*. It is somewhat

heart-shaped in form, and has three principal diameters—an *antero-posterior* (or sacro-pubic), which extends from the angle formed by the sacrum with the last lumbar vertebra to the symphysis pubis or point of union of the two pubic bones; the *transverse*, at right angles to the former, and extending across the greatest width of the pelvis; and the *oblique*, extending from the sacro-iliac symphysis (or union), on one side, to the margin of the brim corresponding with the acetabulum of the other. The diameters of the outlet are two—an *antero-posterior*, extending from the tip of the coccyx to the lower part of the symphysis pubis; and a *transverse*, from the posterior part of one ischiatic tuberosity, to the same point on the opposite side. As the precise knowledge of the diameter and depth of the pelvis is of the greatest importance in the practice of midwifery, we give the average numbers representing the dimensions of a well-formed adult female pelvis. *Diameters of inlet or brim*—antero-posterior, 4 1/4 inches; transverse, 5 1/4 inches; oblique, 4 3/8 inches. *Diameters of outlet*—antero-posterior, 5 inches; transverse, 4 1/2 inches. *Depth of the true pelvis*—posteriorly, 4 1/2 inches; in the middle, 3 5/8 inches; anteriorly, 1 1/2 inches.

The pelvis is placed obliquely with regard to the trunk of the body; the plane of the inlet to the trunk of the body forming an angle of from 60° to 65° with the horizon. According to Naegele (*Ueber das weibliche Becken*), the extremity of the coccyx in the female, when standing upright, about seven lines higher than the lower edge of the symphysis pubis; the upper edge of the symphysis being at the same level as the lower edge of the second segment of the coccyx. By attention to these data a detached pelvis may readily be placed at the angle at which it normally lies in the skeleton. The shape of the human pelvis is much affected by the curving forward of the lower part of the sacrum. This bend of the sacrum forward serves to support the viscera, when the body is in an erect posture; but it is of much more importance in its relation to the act of parturition. If all the antero-posterior diameters of the true pelvis from the brim to the outlet were bisected, the points of bisection would form a curved line, similar to the curve of the sacrum, and termed the *axis* of the pelvis. As the head of the child has to follow this curve, the difficulties of parturition are much greater than if the axis of the pelvis had been straight, as in the other vertebrata. Without entering into unnecessary details, we may remark generally, that the fetal head is of oval shape, with its greatest diameter from before backwards, and that in its passage through the pelvis it is so placed that its longest diameter at each stage of labour coincides with the longest diameter of the pelvis. The head enters the pelvis with the occiput (or back of the skull) being directed towards one ilium, and the face towards the other; while, at its final emergence, the face is turned towards the sacrum and coccyx. There can be no doubt that the screw-like or rotatory motion which is thus given to the fetal head, renders its passage through the pelvis more easy than it would otherwise have been.

There are well-marked differences, chiefly having reference to the act of parturition, between the male and female pelvis. In the female, the bones are lighter and more delicate than in the male, and the muscular impressions and eminences are less distinctly marked. The iliac fossae are large and expanded, and hence the great prominence of the hips. The several diameters (particularly the transverse diameter of the brim, which measures only 5 1/8 inches in the male) are somewhat greater; and the

pubic arch is wider by about ten degrees; the sacrum also is wider and less curved.

It is worthy of notice that the pelvis of the negro is smaller in all its dimensions than that of the

European, and presents a partial approximation to that of the monkey (fig. III.), especially in the deficiency of its width. This difference is very much more obvious in the male than in the female negro; and parturition in the black races is facilitated both by the sacrum being less curved, and by the fetal head being of smaller dimensions. In the apes and monkeys, which approach most nearly to man, the pelvis is longer and narrower, and much less curved than in the human subject. In other mammals, the differences are for the most part the same in kind, but

greater in degree. In many of the Cheiroptera (bats) and Insectivora (as the mole), the pubic bones are only loosely connected by a small ligament, or there is a complete opening between the bones (as occurs normally in birds), an arrangement by which the act of parturition in these animals is much facilitated. The pelvic bones are very simple in the Cetacea, in some cases being represented by two simple elongated bones lying near the anus, and converging from opposite sides (a transverse connecting piece being sometimes but not always present); in others, by a small V-shaped bone, while sometimes (as in *Manatus*) they seem to be entirely wanting. The additional pelvic bones in the non-placental mammals have been already noticed in the articles on the *MARSUPIATA* and *MONOTREMATA*. In the echidna (belonging to the latter order), the acetabulum is perforated, as occurs normally in birds. In birds, in addition to the peculiarity just noticed, we find the pelvis open in front (or, more correctly, inferiorly), there being no union of the pubic bones in any bird except the ostrich. This normal incompleteness of the pelvic ring is obviously for the purpose of facilitating the passage of the eggs. It is unnecessary to trace the further degradation of the pelvic bones in the Reptiles and Fishes.

PEMBROKE, a seaport of South Wales, a market-town, and municipal and parliamentary borough, in the county of the same name, occupies a rocky ridge on a navigable creek of Milford Haven, 7 miles south-east of Milford. On the extremity of the ridge on which the town is built, are the remains of its once extensive castle. In 1648, the castle was beleaguered by Cromwell, and taken after a siege of six weeks. Within this ancient stronghold, Henry VII. was born in 1457. The keep, the principal building in the inner court, is 75 feet high, and 163 feet in circumference, and is surmounted by a cone-shaped roof of masonry, still perfect. *Pater*, otherwise called Pembroke Dock, which is rather a ship-building than a commercial centre, is two miles from the town, and has 12 building-slips and a dry-dock. The entire naval establishment embraces an area of 80 acres, and is surrounded by a high wall, flanked by two martello towers. Within P. are St Michael's, a church of Norman date, and numerous ecclesiastical and educational institutions. Pop. (1861) of parliamentary borough,

which is co-extensive with the municipal borough, 15,071. P. unites with Tenby, Milford, and Wiston in sending a member to parliament.

PEMBROKE COLLEGE, Oxford. BROADGATES HALL, a place of education, originally belonging in part to St Frydeswyde's Priory, and in part to the monastery of Abingdon, was, on the dissolution of the religious houses, given to Christ Church by Henry VIII. In 1629, it was made a college by James I., and took its name from the Earl of Pembroke, then chancellor of the university. By the ordinances of the commissioners under 17 and 18 Vict. c. 81, the constitution of the college is now as follows: There are to be not less than 10 fellowships, open to all, not to exceed £200 a year in value, so long as the number of the fellowships is less than 16. There are not to be less than 10 incorporated scholarships, value £50 a year, and rooms free; of these, 5 are open, 5 filled up from Abingdon School. There are besides 11 other scholarships, subject to various conditions. This college presents to 8 benefices, of which 6 have been purchased since 1812.

PEMBROKE COLLEGE, CAMBRIDGE, was founded in 1347 by Mary de St Paul, the widow of Aymer de Valence, Earl of Pembroke. She was maid, wife, and widow all in one day, her husband being slain at a tilting-match held in honour of her nuptials. On this sad event, she sequestered herself from all worldly delights, and bequeathed her estate to pious uses. Henry VI. was so liberal a benefactor to this college as to obtain the name of a second founder. There are 16 fellowships and 24 scholarships of different values.

PEMBROKESHIRE, a maritime county of South Wales, and the westernmost county of the Principality, is bounded on the S. by the Bristol Channel, and on the W. and N. by St George's Channel. Area, 627 square miles, or 401,691 acres. Pop. (1861) 96,278. The river Teivy separates the county on the north-east from that of Carliogan. On the north are Newport and Fishguard Bays, the latter 3 miles in width, from 30 to 70 feet in depth, and with good anchoring-ground. Off St David's Head, on the west coast, are a number of rocky islets, called the Bishop and his Clerks. St Bride's Bay, the widest inlet, is 8 miles in width, and has an inland sweep of 7 miles. Milford Haven (q. v.) is the most important estuary. The shores on the south are wild and inhospitable, and fronted by high precipitous cliffs. The surface is undulating; green hills alternate with fertile valleys. The principal elevations occur in the Precelly Hills, which traverse the north of the county from east to west, and rise in their highest summit to the height of 1754 feet. The rivers of the greatest importance are the Eastern and Western Cleddau, which unite and form a navigable portion of Milford Haven. None of the rivers, of which the Western Cleddau is the principal, are important. The climate is mild, but damp in the south of the county; while in the north, the temperature is considerably lower. There are excellent and productive soils in the south, and along the north-west coast the barley districts are famous; but the land on the Precelly Mountains and in the coal districts is inferior. Coal, slate, lead, and iron are the only minerals worked. The county is penetrated by the great coal-field of South Wales, which, entering from the east, narrows as it approaches St Bride's Bay. The coal, which is anthracite, and is contained in beds of shale and sandstone, occurs in seams, varying in thickness from a few inches to 6 feet, and sometimes more. Oats, barley, and potatoes are the principal crops. The county returns one member

to parliament. The chief towns are Haverfordwest, St Davids, Pembroke, and Tenby.

**PEMMICAN.** This was originally a North American Indian preparation only, but it was introduced into the British navy victualling-yards, in order to supply the arctic expeditions with an easily-preserved food, containing the largest amount of nutriment in the smallest space. As made by the Indians, it consists of the lean portions of venison dried by the sun or wind, and then pounded into a paste, and tightly pressed into cakes; sometimes a few fruits of *Amelanchier ovata* are added, to improve the flavour. It will keep for a very long time uninjured. That made for the arctic voyagers was chiefly of beef. In making pemmican, it is necessary to remove the fat completely.

**PEMPHIGUS, or PO'MPHOLYX,** belongs to that order of skin-diseases which is characterised by an eruption of large vesicles, filled with serous fluid, and known as *bullæ*. The disease occurs both in the acute and in the chronic form. In a mild case of acute pemphigus, bullæ, or blisters, from the size of a pea to that of a chestnut appear in succession (chiefly on the extremities), and having continued three or four days, break, form a thin scab, and soon heal, unaccompanied with febrile or inflammatory symptoms. In severe cases, there is considerable constitutional disturbance; the bullæ are larger, and the scabs heal with difficulty. The chronic form differs mainly from the acute by its prolonged continuance. The acute variety chiefly affects children, and has been ascribed to dentition, errors of diet, &c.; while the chronic form chiefly attacks aged persons, and is probably due to debility and impaired nutrition. The acute form usually requires nothing but cooling medicines and diet, and mild local dressings, such as simple cerate, to protect the raw surfaces from exposure to the air. In the chronic form, a nutritious diet, with the judicious use of tonics (iron, bark, &c.), is most commonly successful. In obstinate cases, arsenic is sometimes of use.

**PEN,** an instrument for writing with a fluid. In ancient times, a kind of reed (Lat. *Calamus*) was chiefly used, though sometimes the letters were painted with a fine hair-pencil, as among the Chinese at the present day. Quill-pens (see **QUILLS**) probably came into use after the introduction of modern paper. The English name pen is from Lat. *penna*, a feather; but the old form of *penna* was *pena* or *petna* (= Gr. *peteron*), from the root *pet*, to fly; and just as Lat. *ped* is identical with Eng. *foot* (see letter F), so *petna* or *peteron* corresponds to *feather* (Ger. *feder*). During last century, many efforts were made to improve the quill-pen, the great defect of which was its speedy injury from use, and the consequent trouble of frequent mending; moreover, even the most skillful maker could not insure uniformity of quality, and any variation affected the writer's work. These efforts were chiefly directed to fitting small metal or even ruby points to the nib of the quill-pen; but the delicacy of fitting was so great, that but very little success attended the experiments. At the beginning of this century, pens began to be made wholly of metal; they consisted of a barrel of very thin steel, and were cut and slit so as to resemble the quill-pen as closely as possible. They were, however, very indifferent, and being dear (the retail price at first was half-a-crown, and subsequently sixpence), they made but little way; their chief fault was hardness, which produced a disagreeable scratching of the paper. In 1820, Mr Joseph Gillott, who dealt in the metal pens then made, hit upon an improvement, which,

by removing this great defect, gave a stimulus to the manufacture, which has caused it to be developed to an extent truly marvellous. This consisted in making three slits instead of the single one formerly used, and by this means much greater softness and flexibility were acquired. Mr Gillott also introduced machinery for the purpose of carrying out his improvements, and thereby so reduced the cost of production, that he was enabled to sell his improved pens in 1821 at £7, 4s. per gross, which was then considered a remarkable success. Better pens are now sold at twopence per gross by the same manufacturer; or, in other words, 864 pens for the same price as one pen in 1821. Nor is this to be wondered at, when we are acquainted with the wonderful ingenuity of the machinery by which it is effected. The lowest-priced pens are made almost entirely by machinery, but the better ones require much hand-labour for their completion; nevertheless, in the works of Mr Gillott alone, who is only one of several large manufacturers in Birmingham, the annual production is now nearly 150,000,000 pens, requiring a supply of five tons per week of the fine sheet-steel made for the purpose in Sheffield, a portion of which is returned as scrap or waste for re-manufacture. From Sheffield the steel is sent in sheets about eight feet long by three feet broad; it is prepared from the best iron, generally Swedish *bloom*. The manufacturer then prepares it by dipping for a short time in dilute sulphuric acid, which removes the *scale* or black surface; the acid itself is also carefully removed by immersion in clean water; the sheets are then passed backward

and forwards through a rolling-mill with smooth rollers, which reduces the steel to the exact thickness required, and gives it greater compactness; it is next slit into strips of various widths according to the kind of pen to be made; for the ordinary kind its width is seen in fig. 1. This is then passed through a cutting-machine, which rapidly punches out pieces of the shape shewn in fig. 2, and in the order shewn in fig. 1, which is a portion of the strip with the pieces or blanks, as they are called, cut out; that which is represented is the waste or scrap

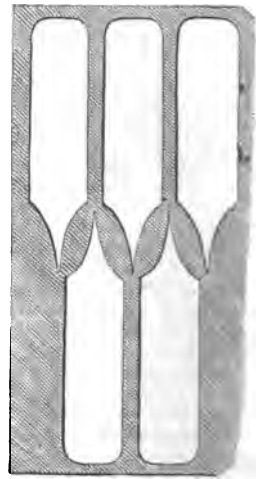
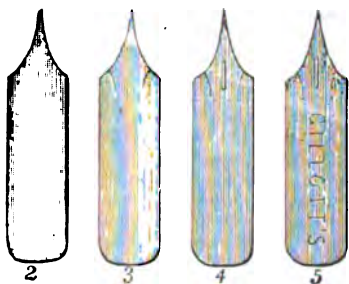

Fig. 1.

previously referred to. The blanks are now passed through a succession of operations, each conducted by a separate person: women or girls are chiefly employed. The first process is called *slitting*; they are passed one by one into a cutting-machine worked by a small hand-lever, which makes the two side slits, as seen in fig. 3. The second process, called *piercing*, is performed by a similar machine or hand-press, in which, however, only one punch acts, and that cuts out the small hole seen in fig. 4. The repeated rolling and stamping of the metal has by this time made it hard and brittle, and it is necessary to anneal it, for which purpose some thousands of the *slit* and *pierced* blanks are put into an iron box, and placed in the fire for a time, which softens them considerably; this is the third process. When cold, another operator receives them, and with

## PEN HOLDERS—PENALTY.

other hand-press and a punch stamps or marks, it is called, the name of the maker, fig. 5, which constitutes the fourth process. The fifth is somewhat similar, and is sometimes omitted; it consists



placing it under another press, which has a punch die for embossing any ornamental mark. The sixth process, called *raising*, consists in passing it to another press, which has a sinker and grooved as in fig. 6. The flat blank *a* is pushed under

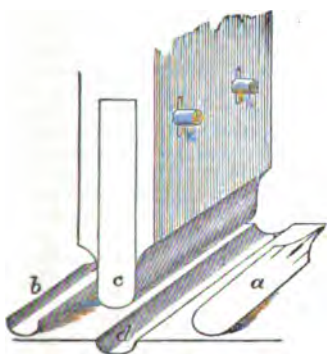

Fig. 6.

sinker *c*, is pressed by the action of the lever into groove *d*, and comes out with its edges curved as in *b*. The seventh process consists in *hardening*—which is done by placing the pens in an iron or *muffle*, and when they are at a red heat, drawing them into oil; this renders them exceedingly brittle and hard, too much so, indeed, for they now to pass through the eighth or *tempering* process, which brings them to the required temper hardness and elasticity. The ninth operation is *grinding*; this consists in putting a large number of pens in a tin cylinder, which is kept revolving by machinery; sand and coarse emery-powder are mixed with them; and the friction of these materials and of the pens themselves cleanses them from all impurities, and brings out the natural colour of the metal. The tenth and eleventh processes consist in grinding the outside of the nib, first lengthwise (fig. 7), and then crosswise (fig. 8), which are done by different persons at separate grinding-wheels. Next follows the most important operation, constituting the twelfth process or *slitting*—that is,

cutting the central slit, upon the nicety of which the whole value of the pen depends. This is done in a hand-press similar to the others, but the cutting part consists of two chisels, one fixed on the table, the other coming down on

the depression of the lever, and so accurately adjusted as to just clear each other. The operator then skilfully holds the pen lengthwise on the fixed chisel, and brings down the movable one so as to effect the beautifully clean cut which constitutes so important a feature in the manufacture. Two other processes, the thirteenth and fourteenth, finish the series: the first is colouring, by heating them in a revolving cylinder over a charcoal stove, which gives them a blue or yellowish colour, according to the time employed; and the last is varnishing them with a varnish composed of lac and naphtha. In the works of Messrs Gillott, from inspection of which we have gathered these facts, there are 400 women and 100 men employed, and the daily produce is enormous: a clever girl will cut out 14,000 pens per day, and a good slitter will *slit* 28,000. Besides the kind specially described above, many other forms are made, especially the large and small barrel pens; but the processes are all the same, or are modifications of those described. Gold pens are extensively made in Birmingham, and as they resist the corrosive action of the ink, they are very durable; their durability is also greatly increased by the ingenious but difficult process of soldering on to the points of the nib minute particles of iridium, which, from their extreme hardness, resist wear for many years. The manufacture of iridium-pointed pens is extensively carried on in the city of New York, where the process is said to have been first brought to perfection.

**PEN HOLDERS** are small turned sticks, usually of cedar, and generally with a steel cylinder to fix the pen. They are used only for metal pens, and are now made by machinery, which is so ingenious, that it turns the cedar, previously cut into square sticks, round, often in a spiral or otherwise ornamental style, cuts them to the required length, and polishes and varnishes them.

**PENAL SERVITUDE** is a sentence for criminal offences, which was recently introduced in lieu of the sentence of transportation beyond the seas. See **CONVICT**; **TRANSPORTATION**.

**PENALTY** is a sum of money declared by some statute or contract to be payable by one who commits an offence or breach of contract. It is considered as a kind of punishment, and constituting indirectly a motive to the party to avoid the commission of the act which induces such a consequence. Many contracts executed between parties contain a clause that one or other of them who fails to perform his part of the contract, will incur a penalty, i. e., will be liable to pay a fixed sum of money to the other party. In such cases, a distinction is drawn between a liquidated and unliquidated penalty; and whether it is of the one kind or the other, depends on the language used in the contract. If it is a liquidated penalty, then, when the breach of contract is committed, the party in default must pay that precise sum, neither more nor less; but if it is unliquidated, then he is not to pay the whole sum, but merely such part of it as corresponds to the amount of injury or damage done, and of which proportion a jury is the sole judge in an action of damages. In statutes, when penalties are declared to follow on certain illegal acts, the sum is sometimes fixed, but in many cases only a maximum sum: is stated, it being left to the court or the justices who enforce the penalty what is a sufficient punishment for the offence. Sometimes penalties can only be sued for by the parties immediately injured; but, as a general rule, and unless it is otherwise restricted, anybody may sue for the penalty, for in an offence against public law, where there is no public prosecutor, any person who chooses



may set the law in motion. Accordingly, not only may anybody in general sue for the penalty, but an inducement is offered by declaring the party who does so to be entitled to the whole or a half of the penalty. Without such inducement, many offences would be unpunished. The party who so sues is generally called the informer. Thus, in offences against the game laws, anybody may sue for the penalty, and he is entitled to half of it. Sometimes the penalty can only be sued for in the superior courts of law; but in the great majority of instances, the enforcing of penalties is part of the administration of justice before justices of the peace. It is for the justices to fix the amount if they have (as they generally have) a discretion to do so. If it is not paid, the justices may issue a distress-warrant, authorising a constable to seize and sell the goods of the party to pay the fine; and if there are no goods, then the justices may commit the party to prison as a substitutionary punishment. Sometimes justices have a discretion either to impose a penalty or commit the party to prison as an alternative punishment. All these matters depend on the construction of particular statutes.

**PENANCE** (Lat. *penitentia*), in Roman Catholic theology, means the voluntary or accepted self-inflicted punishment by which a repentant sinner manifests his sorrow for sin, and seeks to atone for the sin, and to avert the punishment which, even after the guilt has been remitted, may still remain due to the offence. Penance is believed in the Roman Catholic Church to be one of the sacraments of the New Law. It will be necessary to explain it briefly both under its relations as a sacrament, and as a private personal exercise.

Penance must be carefully distinguished from repentance, which is simply sorrow for evil-doing, accompanied with a purpose of amendment. Penance is the fruit or the manifestation of this sorrow, and it is commonly accompanied or expressed by some of those external acts which are the natural manifestations of any deep sorrow, either negative, as the neglect of ordinary attention to dress, to the care of the person, to the use of food; or positive, as the direct acts of personal mortification and self-inflicted pain, such as fasting, wearing haircloth, strewing the head with ashes, watching nights, sleeping hard, &c. Such manifestations of sorrow, whether from motives of religion or from merely natural causes, are common among the eastern races, and are frequently alluded to in the Scripture. In the personal practice of the early Christians, penance found a prominent place, and the chief and acknowledged object of the stated Fasts (q. v.), and other works of mortification which prevailed, was that of penitential correction, or of the manifestation of sorrow for sin.

A still more striking use of penance, however, in the early church, was the disciplinary one; and this, in the Roman Catholic view, is connected with the sacramental character of penance. Any discussion of this purely theological question would be out of place here, and it will be enough to state briefly that Roman Catholics number penance among the Seven Sacraments (q. v.), and believe it to be of direct divine institution (Matt. xvi. 19, xviii. 18; John xx. 21). The matter of this sacrament consists, in their view, of the three acts of the penitent—contrition, or heartfelt sorrow for sin, as being an offence against God; confession, or detailed accusation of one's-self to a priest approved for the purpose; and satisfaction, or the acceptance and accomplishment of certain penitential works, in atonement of the sin confessed; and the form of the sacrament is the sentence of absolution from

sin pronounced by the priest who has the confession, and has been satisfied of the penitential disposition of the self-accusing sinner. At all these points, of course, they are at issue with the Protestants. Even in the apostolic times the practice prevailed of excluding persons of notorious sin from our life from the spiritual fellowship of the Christian community (see EXCOMMUNICATION), without attempting to fix the date, it is stated as certain, from the authority of Tertullian and other writers, that from a very early time persons so excluded were subjected to penitential regulations. The class of offenders so treated were those who had been notorious for some of the grievous crimes of idolatry or murder, adultery, and other scandalous offences. The period of penitential probation differed at different times and places, but in general graduated according to the enormity of the offence, some going so far in their rigour (see NOTORIOUS SINNERS), as, contrary to the clearly-expressed sense of the church, to carry it even beyond the grave. In earlier ages, much depended upon the spirit of the particular church or country; but about the middle of the last century the public penitential discipline assumed a definite form, which, especially as established in the Roman Catholic Church, is so curious that it deserves to be more fully described. Sinners of the classes already mentioned to have their names enrolled, and were (in the Roman Catholic churches, after having made a preliminary confession to a priest appointed for the purpose, and after being admitted, with a blessing and other ceremonies, to the rank of penitents. This ceremony appears to have commonly taken place on the first day of Lent. The penitents so enrolled were arranged in four grades, called—1. *proklaivantes*, Lat. *fientes*) 'Weepers;' 2. *akroömenoi*, Lat. *audientes*) 'Hearers;' 3. (*gynaikei*, Lat. *prosternentes*) 'Prostraters;' 4. (*syntantes*, Lat. *consistentes*) 'Standers.' Of these four classes, the first were obliged to remain outside the church at the time of public worship, and to ask the prayers of the faithful as they entered. The second were permitted to enter and to kneel in the place and during the time appointed for the Catechumens (q. v.); but, like them, were required to depart before the commencement of the Eucharist part of the Liturgy (q. v.). The third were permitted to pray with the rest, but kneeling, and to prostrate, and for them were prescribed many acts of mortification. The fourth were permitted to pray with the rest in a standing posture, and were apparently in a distinct part of the church, and they were excluded from making offerings, and from receiving the communion. The time to be spent in each of these grades differed very much according to times and places, but was afterwards regulated by the laws, called penitential canons. Still it was a power of the bishop to abridge or to prolong the exercise of which is connected with the historical origin of the practice of Indulgence. Of these four grades, the first two hardly appear in the Western Church. It is a subject of controversy whether, and how far, this discipline was extended to other than public sinners; but it seems that individuals, not publicly known as sinners, voluntarily enrolled themselves among the penitents. All four grades wore a distinguishing penitential dress, in which they appeared on all occasions of public worship, and were obliged to observe certain rules of life, to renounce certain indulgent luxuries, and to practise certain austerities. In some churches, they were employed in the care of the sick, the burial of the dead, and other more laborious works of charity. The peni-

cases, could only be restored to communion by the bishop who had excluded him, and this only at the expiration of the appointed time, unless the sinner himself had shortened it; but, in case of illness, he might be restored, with the bishop, however, that, if he recovered from the illness, the whole course of penance should be completed. The reconciliation of penitents took place commonly in Holy Week, and was publicly performed by the bishop in the church, with prayer and imposition of hands. It was followed by the restoration of communion. If any of the clergy were guilty of a crime to which public penance was applied, they were first deposed from the rank of clergy, and then subjected to the ordeal, like the laymen themselves. This public discipline continued in force with greater or less exactness in the 5th, and 7th centuries, gradually, however, being replaced by semi-public, and ultimately by private penance. In the 11th and 12th centuries, public penance had entirely disappeared. The origin of *private penance* is a subject of controversy between Catholics and Protestants; the former contending that it had existed from the time that it held the same place even in the public penance for *secret sins* which the church did for public offences. At all times, from the date of the cessation of the public discipline, it has existed universally in the Christian Church. The priest, in absolving the penitent, imposes upon him the obligation of performing certain prayers, undergoing certain works of mortification, or performing certain devotional exercises. These acts of the penitent are held to be an integral part of the sacrament of

the development of their germs to have already begun during the age of the apostles.

In the discipline of the Protestant churches, penance is now unknown. The nearest approach to the Roman Catholic polity on the subject was that in use among the English Puritans of the 17th c., and more particularly in the Church of Scotland during that and the succeeding century, when it was common 'to make satisfaction publicly on the Stool of Repentance' (q. v.). It does not seem to have occurred to the Reformers or their more immediate successors in the Protestant churches, that their system of discipline, with its public rebukes and enforced humiliations of various kinds—as the wearing of a sackcloth robe, and sitting on a particular seat in church—was liable to be interpreted in a sense very different from that of a mere expression of sorrow for sin; but the belief is now very general among the most zealous adherents of their doctrinal opinions, that in all this they adopted practices incongruous with their creed, and in harmony rather with that of the Church of Rome. Nor do they seem to have perceived that Church-Discipline (q. v.), in its proper sense, as relating to ecclesiastical rights and privileges, is wholly distinct from the imposition of penalties by churches or church courts. Penitential humiliations, imposed by ecclesiastical authority, are now no more in favour where church discipline is most strict, than where the utmost laxity prevails. The commutation of penalties deemed shameful, for a fine to the poor of the parish, was an abuse once prevalent in Scotland, but never sanctioned by the higher ecclesiastical authorities.

**PENANG.** See PULO-PENANG.

**PENANG LAWYERS,** the commercial name for the stems of a species of palm imported from Penang for walking-sticks. They are small and hard, and have a portion of the root-stock attached, which is left to form the handle.

**PENATES.** See LARES, MANES, and PENATES.

ing to Protestants, penance has no countenance whatever from Scripture, and is contrary to the most essential principles of the Christian religion; particularly to the doctrine of justification by faith in Jesus Christ alone, and of his complete or 'finished' work; being, in fact, founded on a doctrine of—supplementary atonement by the works of the sinner—himself. The expressions of humiliation, sorrow, and contrition common under the Jewish dispensation, are regarded as very consistent with the character of the Christian dispensation, in which so many symbols were used. It is also held, that the self-inflicted penances, as fasting, sackcloth and ashes, &c., from the earliest Christian times, had for their purpose the mortification of unholiness and lusts and passions in the people of God; or the expression of sorrow for sin, so that others beholding the penitent were warned of its evil and restrained from sin, which is perfectly consistent with the doctrine of Christianity, if kept within the bounds of moderation and discretion. But penance, in other views, as a *personal exercise*, is utterly rejected. Arguments founded on the meaning of the Greek words *metanoēs* and *metamelomai*, translated in our English version *repent*, are urged by many Roman Catholic controversialists—the former being represented as equivalent to the English *Do Penance*; but this is rejected by Protestants as inconsistent with the meaning of the words in the New Testament itself. Penance, as a practice, very early in the Christian church, is not only admitted by Protestants, but alleged in proof of the very early existence of those corruptions which finally developed themselves in the doctrines and practices of the Roman Catholic Church, and of which Protestants contend that there are plain intimations in the New Testament, not only prophetic, but shewing

**PENCILS** are instruments for writing, drawing, and painting, and they differ as much in their construction as in the uses to which they are applied. Probably the pencil was the first instrument used by artists, and consisted then of lumps of coloured earth or chalk simply cut into a form convenient for holding in the hand. With such pencils were executed the line-drawings of Aridices the Corinthian, and Telephanes the Sicyonian, and also the early one-coloured pictures, or *monochromata*, of the Greeks and Egyptians; but as wet colours began to be used, small fine-pointed brushes would be required, and we find it recorded that as early as the 4th c. B. C., several Greek artists had rendered the art of painting with hair-pencils so famous, that some of their pictures sold for vast sums of money. There are now in use the following kinds of pencils: hair-pencils, black-lead pencils, chalk-pencils, and slate-pencils. The first are used for painting or writing with fluid colours, either oil or water, and in China and Japan are employed almost entirely instead of pens for writing; the colour used being the black or brown pigment obtained from various species of sepia or cuttlefish. The manufacture of hair-pencils is of great importance, and requires much care and skill. The hairs employed are chiefly those of the camel, badger, sable, mink, kolinski, fitch, goat, and the bristles of hogs; and the art of pencil-making requires that these hairs shall be tied up in cylindrical bundles, so nicely arranged that all their naturally fine points shall be in one direction, and that the central one shall project the furthest, and the others in succession shall recede,

may set the law in motion. Accordingly, not only may anybody in general sue for the penalty, but an inducement is offered by declaring the party who does so to be entitled to the whole or a half of the penalty. Without such inducement, many offences would be unpunished. The party who so sues is generally called the informer. Thus, in offences against the game laws, anybody may sue for the penalty, and he is entitled to half of it. Sometimes the penalty can only be sued for in the superior courts of law; but in the great majority of instances, the enforcing of penalties is part of the administration of justice before justices of the peace. It is for the justices to fix the amount if they have (as they generally have) a discretion to do so. If it is not paid, the justices may issue a distress-warrant, authorising a constable to seize and sell the goods of the party to pay the fine; and if there are no goods, then the justices may commit the party to prison as a substitutionary punishment. Sometimes justices have a discretion either to impose a penalty or commit the party to prison as an alternative punishment. All these matters depend on the construction of particular statutes.

**PENANCE** (Lat. *penitentia*), in Roman Catholic theology, means the voluntary or accepted self-inflicted punishment by which a repentant sinner manifests his sorrow for sin, and seeks to atone for the sin, and to avert the punishment which, even after the guilt has been remitted, may still remain due to the offence. Penance is believed in the Roman Catholic Church to be one of the sacraments of the New Law. It will be necessary to explain it briefly both under its relations as a sacrament, and as a private personal exercise.

Penance must be carefully distinguished from repentance, which is simply sorrow for evil-doing, accompanied with a purpose of amendment. Penance is the fruit or the manifestation of this sorrow, and it is commonly accompanied or expressed by some of those external acts which are the natural manifestations of any deep sorrow, either negative, as the neglect of ordinary attention to dress, to the care of the person, to the use of food; or positive, as the direct acts of personal mortification and self-inflicted pain, such as fasting, wearing haircloth, strewing the head with ashes, watching of nights, sleeping hard, &c. Such manifestations of sorrow, whether from motives of religion or from merely natural causes, are common among the eastern races, and are frequently alluded to in the Scripture. In the personal practice of the early Christians, penance found a prominent place, and the chief and acknowledged object of the stated Fasts (q. v.), and other works of mortification which prevailed, was that of penitential correction, or of the manifestation of sorrow for sin.

A still more striking use of penance, however, in the early church, was the disciplinary one; and this, in the Roman Catholic view, is connected with the sacramental character of penance. Any discussion of this purely theological question would be out of place here, and it will be enough to state briefly that Roman Catholics number penance among the Seven Sacraments (q. v.), and believe it to be of direct divine institution (Matt. xvi. 19, xviii. 18; John xx. 21). The matter of this sacrament consists, in their view, of the three acts of the penitent—contrition, or heartfelt sorrow for sin, as being an offence against God; confession, or detailed accusation of one's-self to a priest approved for the purpose; and satisfaction, or the acceptance and accomplishment of certain penitential works, in atonement of the sin confessed; and the form of the sacrament is the sentence of absolution from

sin pronounced by the priest who has received the confession, and has been satisfied of the penitential disposition of the self-accusing sinner. In all these points, of course, they are at issue with Protestants. Even in the apostolic times, the practice prevailed of excluding persons of scandalous life from the spiritual fellowship of the Christian community (see EXCOMMUNICATION); and without attempting to fix the date, it may be stated as certain, from the authority of Tertullian and other writers, that from a very early time the persons so excluded were subjected to certain penitential regulations. The class of offenders so treated were those who had been notoriously guilty of the grievous crimes of idolatry or apostasy, murder, adultery, and other scandalous offences. The period of penitential probation differed in different times and places, but in general was graduated according to the enormity of the sin, some going so far in their rigour (see NOVATIAN) as, contrary to the clearly-expressed sense of the church, to carry it even beyond the grave. In the earlier ages, much depended upon the spirit of each particular church or country; but about the 4th c., the public penitential discipline assumed a settled form, which, especially as established in the Greek Church, is so curious that it deserves to be briefly described. Sinners of the classes already referred to had their names enrolled, and were (in some churches, after having made a preliminary confession to a priest appointed for the purpose) admitted, with a blessing and other ceremonial, by the bishop to the rank of penitents. This enrolment appears to have commonly taken place on the first day of Lent. The penitents so enrolled were arranged in four grades, called—1. (Gr. *prosklaiontes*, Lat. *flentes*) 'Weepers'; 2. (Gr. *akroomenoi*, Lat. *audientes*) 'Hearers'; 3. (Gr. *hypopiptontes*, Lat. *prosternentes*) 'Prostraters'; 4. (Gr. *syntantes*, Lat. *consistentes*) 'Standers.' Of these classes, the first were obliged to remain outside of the church at the time of public worship, and to ask the prayers of the faithful as they entered. The second were permitted to enter and to remain in the place and during the time appointed for the Catechumens (q. v.); but, like them, were required to depart before the commencement of the solemn part of the Liturgy (q. v.). The third were permitted to pray with the rest, but kneeling or prostrate, and for them were prescribed many other acts of mortification. The fourth were permitted to pray with the rest in a standing posture, although apparently in a distinct part of the church; but they were excluded from making offerings with the rest, and still more from receiving the communion. The time to be spent in each of these grades at first differed very much according to times and circumstances, but was afterwards regulated by elaborate laws, called penitential canons. Still it was in the power of the bishop to abridge or to prolong it; a power, the exercise of which is connected with the historical origin of the practice of Indulgence (q. v.). Of these four grades, the first two hardly appear in the Western Church. It is a subject of controversy whether, and how far, this discipline was extended to other than public sinners; but it seems certain that individuals, not publicly known as sinners, voluntarily enrolled themselves among the penitents. All four grades wore a distinguishing penitential dress, in which they appeared on all occasions of public worship, and were obliged to observe certain rules of life, to renounce certain indulgences and luxuries, and to practise certain austerities. In some churches, they were employed in the care of the sick, the burial of the dead, and other of the more laborious works of charity. The penitent, in

ordinary cases, could only be restored to communion by the bishop who had excluded him, and this only at the expiration of the appointed time, unless the Bishop himself had shortened it; but, in case of dangerous illness, he might be restored, with the condition, however, that, if he recovered from the illness, the whole course of penance should be completed. The reconciliation of penitents took place commonly in Holy Week, and was publicly performed by the bishop in the church, with prayer and imposition of hands. It was followed by the administration of communion. If any of the clergy were guilty of a crime to which public penance was annexed, they were first deposed from the rank of the clergy, and then subjected to the ordeal, like the laity themselves. This public discipline continued in force with greater or less exactness in the 5th, 6th, and 7th centuries, gradually, however, being replaced by semi-public, and ultimately by private penance. In the 11th and 12th centuries, the public penance had entirely disappeared. The nature and origin of *private penance* is a subject of controversy between Catholics and Protestants; the former contending that it had existed from the first, and that it held the same place even in the ages of public penance for *secret sins* which the public penance did for public offences. At all events, from the date of the cessation of the public discipline, it has existed universally in the Roman Church. The priest, in absolving the penitent, imposes upon him the obligation of reciting certain prayers, undergoing certain works of mortification, or performing certain devotional exercises. These acts of the penitent are held to form an integral part of the sacrament of penance.

According to Protestants, penance has no countenance whatever from Scripture, and is contrary to some of the most essential principles of the Christian religion; particularly to the doctrine of justification by faith in Jesus Christ alone, on the ground of his complete or 'finished' work; penance being, in fact, founded on a doctrine of—at least—supplementary atonement by the works or sufferings of man—the sinner—himself. The outward expressions of humiliation, sorrow, and repentance common under the Jewish dispensation, are regarded as very consistent with the character of that dispensation, in which so many symbols were employed. It is also held, that the self-inflicted austerities, as fasting, sackcloth and ashes, &c., of Jewish and earliest Christian times, had for their sole purpose the *mortification* of unholiness and sinful passions in the people of God; or the expression of sorrow for sin, so that others beholding might be warned of its evil and restrained from it; all which is perfectly consistent with the principles of Christianity, if kept within the bounds of moderation and discretion. But penance in any other view, as a *personal exercise*, is utterly rejected. Arguments founded on the meaning of the two Greek words *metanoet* and *metameleomai*, both translated in our English version *repent*, are much urged by many Roman Catholic controversialists—the former being represented as equivalent to the English *Do Penance*; but this is condemned by Protestants as inconsistent with the very use of the words in the New Testament itself. That penance began, as a practice, very early in the Christian church, is not only admitted by Protestants, but alleged in proof of the very early growth of those corruptions which finally developed themselves in the doctrines and practices of the Roman Catholic Church, and of which Protestants also hold that there are plain intimations in the New Testament, not only prophetic, but shewing

the development of their germs to have already begun during the age of the apostles.

In the discipline of the Protestant churches, penance is now unknown. The nearest approach to the Roman Catholic polity on the subject was that in use among the English Puritans of the 17th c., and more particularly in the Church of Scotland during that and the succeeding century, when it was common 'to make satisfaction publicly on the Stool of Repentance' (q. v.). It does not seem to have occurred to the Reformers or their more immediate successors in the Protestant churches, that their system of discipline, with its public rebukes and enforced humiliations of various kinds—as the wearing of a sackcloth robe, and sitting on a particular seat in church—was liable to be interpreted in a sense very different from that of a mere expression of sorrow for sin; but the belief is now very general among the most zealous adherents of their doctrinal opinions, that in all this they adopted practices incongruous with their creed, and in harmony rather with that of the Church of Rome. Nor do they seem to have perceived that Church-Discipline (q. v.), in its proper sense, as relating to ecclesiastical rights and privileges, is wholly distinct from the imposition of penalties by churches or church courts. Penitential humiliations, imposed by ecclesiastical authority, are now no more in favour where church discipline is most strict, than where the utmost laxity prevails. The commutation of penalties deemed shameful, for a fine to the poor of the parish, was an abuse once prevalent in Scotland, but never sanctioned by the higher ecclesiastical authorities.

PENANG. See PULO-PENANG.

PENANG LAWYERS, the commercial name for the stems of a species of palm imported from Penang for walking-sticks. They are small and hard, and have a portion of the root-stock attached, which is left to form the handle.

PENATES. See LARES, MANES, and PENATES.

PENCILS are instruments for writing, drawing, and painting, and they differ as much in their construction as in the uses to which they are applied. Probably the pencil was the first instrument used by artists, and consisted then of lumps of coloured earth or chalk simply cut into a form convenient for holding in the hand. With such pencils were executed the line-drawings of Aridices the Corinthian, and Telephanes the Sicyonian, and also the early one-coloured pictures, or *monochromata*, of the Greeks and Egyptians; but as wet colours began to be used, small fine-pointed brushes would be required, and we find it recorded that as early as the 4th a. b. c., several Greek artists had rendered the art of painting with hair-pencils so famous, that some of their pictures sold for vast sums of money. There are now in use the following kinds of pencils: hair-pencils, black-lead pencils, chalk-pencils, and slate-pencils. The first are used for painting or writing with fluid colours, either oil or water, and in China and Japan are employed almost entirely instead of pens for writing; the colour used being the black or brown pigment obtained from various species of sepia or cuttlefish. The manufacture of hair-pencils is of great importance, and requires much care and skill. The hairs employed are chiefly those of the camel, badger, sable, mink, kolinski, fitch, goat, and the bristles of hogs; and the art of pencil-making requires that these hairs shall be tied up in cylindrical bundles, so nicely arranged that all their naturally fine points shall be in one direction, and that the central one shall project the furthest, and the others in succession shall recede,

so that, collectively, the whole shall form a beautifully smooth cone, the apex of which is a sharp point. Black-lead pencils are made of graphite or plumbago, which contains no lead whatever in its composition, but is in reality almost pure carbon. See **BLACK-LEAD**. The misnomer is probably owing to the fact, that, previous to the employment of graphite for making pencils, common lead was used, and this was the case even within the present century. Consequently, as the plumbago, with its black streak, offered a contrast to the pale one of the lead, it was called in contradistinction *black-lead*.

The best graphite for drawing-pencils is found in the Cumberland mines, which have long been celebrated. Within the last three years, however, vast deposits of this mineral, of a very fine quality, have been discovered in Siberia and other parts of the Russian empire. Inferior qualities are found in Austria and Prussia, in Ceylon, and various parts of North America; but they are rarely used in pencil-making, except for very inferior kinds. Black-lead is rarely sufficiently free from sand and other foreign ingredients to be used without preparation; it is therefore generally ground fine, and levigated or washed until it is pure, and again formed into solid blocks by means of enormous pressure, generally in hydraulic presses; these blocks are then sawn into thin plates about the sixteenth of an inch in thickness, which are again cut across, so as to form them into small square sticks.

It may appear a very simple process to press the powdered graphite into blocks, but it was found so difficult in practice as almost to prevent the employment of this method, which has led to immense improvement in pencil-making. It was found at first that the difficulty of pressing out the contained air was so great that the presses were broken under the weight required; pressure in a vacuum was then tried, but the difficulty of applying it was found almost insurmountable, and it was certainly unprofitable. Mr Brokedon of London, who has long been famous for his pencils, at last surmounted the difficulty by an ingenious and very simple process. This consists in compressing the black-lead into blocks two or three inches square, with only moderate pressure; these are then coated over with paper, well glued, so that, when dry, the covering is air-tight. A small hole is now made through this coating on one side, and several of these cubes of black-lead are put under the receiver of an air-pump, and the air being exhausted completely from them, the orifice in each is closed by an adhesive wafer, which prevents the return of the air when they are taken out of the receiver. They are next placed under the hydraulic press, and a well-sustained and regular pressure is brought to bear upon them for twenty-four hours, after which they are found to be so completely consolidated, that in cutting them the substance is equal in density to the best specimens of unprepared graphite. There is so large a variation in the colour of various qualities of black-lead, that, by a judicious mixture of them, when in the powdered state, almost any shade of darkness can be procured; but instead of thus carefully combining different qualities of graphite, it is a common practice to add sulphur or sulphuret of antimony, and by heating to procure the desired degree of blackness. For very inferior pencils, the worst quality of black-lead is mixed with black chalk and size, or gum-water, and formed into a paste, of which the pencil is made.

It is usual to enclose the material constituting the essential part of the pencil in a case of wood, for

its protection from breakage, and to prevent soiling the hands. The wood (generally cedar) is first sawn into thin boards, about half the thickness of the intended pencils; these are then cut into small pieces about ten inches long, the width, which are placed in the cutting and rounding machine. This machine consists principally of circular saws—one very thin, and so set that it cuts through the board; the other revolving, and set to cut the eighth of an inch of it, so set as only to cut a fine square groove in the wood. By means of this machine, the little boards are cut into square sticks, each having a groove on one surface. Into these grooves, the little pieces of sticks of black-lead are laid and covered with a similar piece of wood, but not grooved. A wafer, who is called the 'fastener-up,' having glued the inner faces of the two pieces of wood, presses them together, and sets them to dry; after which they are passed through the rounding-machine, and then with a semi-circular smoothing-plane, cut to the ends, and then polished by rubbing them with a piece of shark-skin. The last process is signed by them with the maker's name and the letter which designates their peculiar quality. These letters are H, HH, HHH, B, BB, BBB, HB, FS. H means *hard*; repeated twice and thrice, it means *very hard*. B means *black*, HB hard and black, and so on. FS signifies *fine stroke*.

Chalk-pencils are made in a similar manner, but finely-powdered coloured chalks, such as are used for crayons, are substituted for the black. Previous to pressing and cutting the chalk is mixed with a little hot melted wax, which gives softness and adhesiveness.

Slate-pencils for writing on slate are made by cutting slate into thin sticks, and rounding them, or by cutting it into fine square slabs, and enclosing them in wood, as in the case of lead, &c

**PENDANT**, or **PENNANT**, is a narrow flag of great length, tapering to a point, and carried at the head of the principal mast in a royal ship, and at the fore-mast in a man-of-war, and is so called, that she is in commission. In the British navy, the pendants are borne of three colours—red, white, and blue—according to the colour to which the commanding the fleet pertains. See **FLAG-OFFICER**. A *broad-pennant* is a blue pennant, shorter than the above, and broader than the above, carried at the mast-head of a commodore's ship, to denote that her captain is the commodore on the station. A first-class commodore hoists his broad-pennant at the fore; if of the second-class, his flag flies at the mizzen.

The *rudder-pendants* are strong ropes spliced in the rings of the rudder-chain, to prevent the loss of the rudder, should it by any accident become unshipped.

**PENDANT**, a hanging ornament, used in ceilings, vaults, staircases, timber-rooms, &c. It is sometimes a simple ball, and sometimes elaborately ornamented, and is chiefly used in the later Gothic and Elizabethan styles.

**PENDENTIVE**, the portion of a vault or dome which rests on one pier, and extending from the spring to the apex.—The word *pendentive* is also applied to a



Pendant

PENDLETON—PENDULUM.

ons of vaults introduced in the angles of  
ar compartments, in order to reduce them  
ular or other suitable form to receive

PLETON, a township of Lancashire, with a  
of the Lancashire and Yorkshire Railway, is  
of Manchester, and is 2½ miles west-north-  
the town of that name. In 1851, it contained  
and in 1861, 20,900 inhabitants. Since then,  
ation has slightly increased. P. is part of  
mentary borough of Salford, and since 1852  
is incorporated with the municipality of the  
ough. The rapid increase of its population  
the immense industry of the locality. The  
ts are employed in the numerous cotton  
mills, print and dye-works, iron found-  
p, and chemical works, in operation here.  
of the population are also employed in  
known P. collieries, which are conducted  
h enterprise by the lessees. P. is also the  
of a portion of the mercantile community  
Manchester, whose large mansions, with their  
gardens, are dotted at intervals along the  
s leading from the township westward to

ULUM, in its widest scientific sense,  
body of any form or material which, under  
of some force, vibrates about a position  
equilibrium. In its more usual application,  
this term is restricted, in conformity  
ymology (Lat. *pendeo*, to hang), to bodies  
from a point, or oscillating about an axis,  
e action of gravity, so that, although the  
eir motion are the same, Rocking Stones,  
agnetic Needles, Tuning-forks, Balance  
a watch, &c., are not included in the

ple pendulum consists (in theory) of a heavy  
particle, suspended by a flexible string  
weight, and therefore constrained to move  
re always on the inner surface of a smooth  
bowl. If such a pendulum be drawn aside  
ghtly-inclined position, and allowed to fall  
vidently will oscillate from side to side of  
n of equilibrium, the motion being confined  
cal plane. If, instead of being allowed to  
it be projected horizontally in a direction  
lar to that in which gravity tends to  
the bob will revolve about its lowest posi-  
there is a particular velocity with which,  
projected, it describes a circle about that  
is then called a *conical pendulum*. As  
of the simple pendulum can be very easily

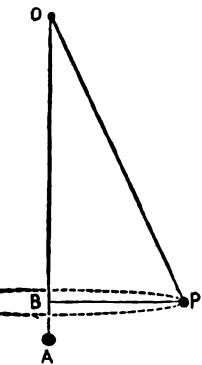

Fig. 1.

suspension, OA the pendulum in its lowest  
P the bob in any position in the (dotted)

circle which it describes when revolving as a  
conical pendulum; PB, a radius of the dotted  
circle, is evidently perpendicular to OA. Now, the  
centrifugal force is directly as the radius PB of  
the circle, and inversely as the square of the time  
of revolution. Also the radius PB is  $PO \sin$   
BOP, the length of the string multiplied by the sine  
of the angle it makes with the vertical; and the force  
towards the vertical is proportional to the earth's  
attraction, and to the tangent of the above angle—  
as may be at once seen from the consideration that  
the three forces acting on the bob at P are parallel,  
and therefore proportional, to the sides of the tri-  
angle OBP. Hence the square of the time of revolu-  
tion is directly as the length of the string and the  
sine of the angle BOP, and inversely as the earth's  
attraction and the tangent of the same angle; or  
(what is easily seen to be equivalent) to the length  
of the string and the cosine of its inclination to the  
vertical directly, and to the earth's attraction  
inversely. Hence, in any given locality, all conical  
pendulums revolve in equal times, whatever be the  
lengths of their strings, so long as their heights are  
equal; the height being the product of the length  
of the string by the cosine of its inclination to the  
vertical. Also the squares of the times of revolu-  
tion of conical pendulums are as their heights  
directly, and as the earth's attraction inversely.

Now, so long as a conical pendulum is deflected  
only through a very small angle from the vertical, the  
motion of its bob may be considered as com-  
pounded of two equal simple pendulum oscilla-  
tions in directions perpendicular to each other, such  
as it appears to make to an eye on a level with it  
and viewing it at some distance, first from one  
point, say on the north, and then from another 90°  
round, say on the east. And these motions take  
place, by Newton's second law (see MOTION, LAWS  
OF), independently. Also the time of a (double)  
oscillation in either of these directions is evidently  
the same as that of the rotation of the conical pen-  
dulum. Hence, for *small arcs of vibration*, the square  
of the time of oscillation of a simple pendulum is  
directly as its length, and inversely as the earth's  
attraction. Thus, the length of the second's pen-  
dulum at London being 39.1393 inches, that of the  
half-second's pendulum is 9.7848 inches, or one-  
fourth; that of the two seconds' pendulum 156.5572  
inches, or four times that length. It follows from  
the principle now demonstrated, that so long as the  
arcs of vibration of a pendulum are all small rela-  
tively to the length of the string, they may differ  
considerably in length among themselves without  
differing appreciably in time. It  
is to this property of pendulum  
oscillations, known as Isochron-  
ism (q. v.), that they owe their  
value in measuring time. See  
HOROLOGY.

That the times of vibration of  
different pendulums are as the  
square roots of their lengths, may  
be demonstrated to the eye by  
a very simple experiment. Sus-  
pend three musket balls on  
double threads as in the figure,  
so that the heights in the dotted  
line may be as 1, 4, and 9. When  
they are made to vibrate simul-  
taneously, while the lowest ball  
makes one oscillation the highest  
will be found to make three, and  
the middle ball one and a half.

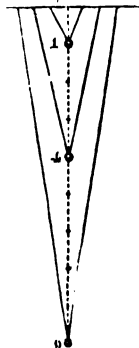

Fig. 2.

A pendulum of given length is a most delicate  
instrument for the measurement of the relative  
amounts of the earth's attraction at different

places. Practically, it gives the kinetic measurement of gravity, which is not only by far the most convenient, but also the true measure. By this application of the pendulum, the oblateness of the earth has been determined, in terms of the law of decrease of gravity from the poles to the equator. The instrument has also been employed to determine the mean density of the earth (from which its mass is directly derivable), by the observation of its times of vibration at the mouth and at the bottom of a coal-pit. It was shewn by Newton, that the force of attraction at the bottom of a pit depends only upon the internal nucleus which remains when a shell, everywhere of thickness equal to the depth of the pit, has been supposed to be removed from the whole surface of the earth. The latest observations by this method were made by Airy, the present astronomer-royal, in the Harton coal-pit, and gave for the mean density of the earth a result nearly equivalent to that deduced by Cavendish and Maskelyne from experiments of a totally different nature. See EARTH.

If the bob of the simple pendulum be slightly displaced in any manner, it describes an ellipse about its lowest position as centre. This ellipse may, of course, become a straight line or a circle, as in the cases already considered. The bob does not accurately describe the same curve in successive revolutions; in fact, the elliptic orbit just mentioned rotates in its own plane about its centre, in the same direction as the bob moves, with an angular velocity nearly proportional to the area of the ellipse. This is an interesting case of *progression of the apse* (Apsides, q. v.), which can be watched by any one who will attach a small bullet to a fine thread; or, still better, attach to the lower end of a long string fixed to the ceiling a funnel full of fine sand or ink which is allowed to escape from a small orifice. By this process, a more or less permanent trace of the motion of the pendulum is recorded, by which the elliptic form of the path and the phenomena of progression are well shewn.

According to what is stated above, there ought to be no progression if the pendulum could be made to vibrate simply in a straight line, as then the area of its elliptic orbit vanishes. It is, however, found to be almost impossible in practice to render the path absolutely straight; so that there always is from this cause a slight rate of change in the position of the line of oscillation. But as the direction of this change depends on the direction of rotation in the ellipse, it is as likely to affect the motion in one way as in the opposite, and is thus easily separable from the very curious result obtained by Foucault, that on account of the earth's rotation, the plane of vibration of the pendulum *appears to turn* in the same direction as the sun, that is, in the opposite direction to the earth's rotation about its axis. To illustrate this now well-known case, consider for a moment a simple pendulum vibrating at the *pole* of the earth. Here, if the pendulum vibrates in a straight line, the direction of that line remains absolutely fixed in space, while the earth turns round below it once in 24 hours. To a spectator on the earth, it appears, of course, as if the plane of motion of the pendulum were turning once round in 24 hours, but in the opposite direction. To find the amount of the corresponding phenomenon in any other latitude, all that is required is to know the rate of the earth's rotation about the vertical in that latitude. This is easy, for velocities of rotation are resolved and compounded by the same process as forces, hence the rate at which the earth rotates about the vertical in latitude  $\lambda$  is less than that of rotation about the polar axis in the ratio of  $\sin. \lambda$

to 1. Hence the time of the apparent rotation of the plane of the pendulum's motion is  $\frac{24 \text{ hours}}{\sin. \lambda}$ .

At the pole, this is simply 24 hours; at the equator it is infinitely great, or there is no effect of this rotation. At the latitude of Edinburgh ( $56^\circ 57' 23.2''$ ) it is 28.63 h., or 28 h. 37 m. 48 s.

We have not yet alluded to the obvious fact, that a *simple* pendulum, such as we have described, does not exist in theory only, since we cannot procure a single heavy particle, or a perfectly li-  
flexible string. But it is easily shewn, although the process cannot be given here, that a rigid body of any form whatever vibrates about an axis under the action of gravity, according to the same law as a hypothetical simple pendulum. The length of the equivalent simple pendulum depends upon the Radius of Gyration (q. v.) of the body. Its property is simply this, that the whole mass of the body were collected at a point whose distance from the axis is the radius of gyration, the moment (q. v.) of inertia of this body (about the axis) would be the same as that of the complex body. The square of the radius of gyration of a body about any axis, is greater than that of the radius of gyration about a parallel axis through the centre of gravity, by the square of the distance between those lines. Now, the length of the simple pendulum equivalent to a body vibrating about any axis is directly as the square of the radius of gyration, and inversely as the distance of the centre of gravity from the axis. Hence the radius of gyration of a body about a parallel axis through the centre of gravity,  $\sqrt{k^2 + h^2}$ , is about a parallel axis whose distance from the centre of gravity is  $h$ ; and the length,  $l$ , of the equivalent simple pendulum is  $l = \frac{k^2 + h^2}{h}$ .

This expression becomes infinitely great as  $h$  becomes very large, and also if  $h$  be very small (the body vibrates very slowly about an axis whose distance from, or near to, its centre of gravity). It therefore has a minimum value. By solving the equation above as a quadratic in  $h$ , we find that  $h$  cannot be less than  $2k$ , which is, therefore, the length of the simple pendulum corresponding to the minimum vibrations which the body can execute about an axis parallel to the given one. In this case the value of  $h$  is equal to  $k$ . Hence, if a circular cylinder be described in a body, its axis passing through the centre of gravity, and its radius being the length of gyration about the axis, the times of oscillation about all generating lines of this cylinder are equal, and less than the times of oscillation about any other axes parallel to the given one. All that is required for the formula for  $l$ , above given, may be thus put for  $h$ . Hence, if any value  $l$  (of course less than  $2k$ ) be assigned as the length of the equivalent simple pendulum, there are *two* values of  $h$  which will satisfy the conditions; that is, two concentric cylinders, about a generating line of which the time of oscillation is the same as that assigned simple pendulum. When  $l = 2k$ , the two cylinders coincide, and form that above described. And, since the sum of the radii of these cylinders is equal to  $l$ , it is obvious that if we can find experiments on two parallel axes about which a body oscillates equal times, and if the centre of gravity and the body lie between these axes, and in their plane, the distance between these axes is the length of the equivalent simple pendulum. This result is of great importance, because it enabled Kater (who was the first to employ it) to use the complex pendulum in the determination of the length of the

PENELOPÉ—PENGUIN.

nd's pendulum in any locality. The simple pen-  
um is perfect in theory, but cannot be con-  
ted; and thus the method which enables us to  
in its results by the help of such a pendulum as  
an construct, is especially valuable.

mpensation Pendulum.—As the length of a rod  
of any material depends on its temperature

HEAT), a clock with an ordinary pendulum  
faster in cold, and slower in hot, weather.  
ous contrivances have been devised for the  
ose of diminishing, if not destroying, these

ts. The most perfect in theory, though per-  
not the most available in practice, is that

r D. Brewster (q. v.), founded upon the experi-  
al discovery of Mitscherlich, that some crystals

nd by heat in one direction, while contracting

he perpendicular one; and therefore that a

may be cut out of the crystal in such a direc-  
as not to alter in length by any change of

erature. In the method of correction usually

oyed, and called compensation, advantage is

n of the fact that different substances have dif-  
ferent coefficients of linear dilatation; so that if the

of the pendulum be so suspended as to be raised

the expansion of one substance, and depressed

the expansion of another, the lengths of the

ative portions of these substances may be so

ated that the raising and depression, taking

place simultaneously, may leave the

osition of the bob unaffected. There

are two common methods of effecting

this, differing a little in construction,

but ultimately depending on the same

inciple. Of these, the mercurial pen-  
dulum is the more easily described.

The rod AC, and the framework CB,

are of steel. Inside the framework is

placed a cylindrical glass jar, nearly

full of mercury, which can be raised or

depressed by turning a nut at B. By

increase of temperature, the steel por-  
tion AB is lengthened by an amount

proportional to its length, its coefficient

of linear dilatation, and the change of

erature, conjointly—and thus the jar of mercury

moved from the axis of suspension. But neglect-

the expansion of the glass, which is very small,

mercury rises in the jar by an amount propor-

l to its bulk, its coefficient of cubical dilatation,

the change of temperature, conjointly. Now,

creasing or diminishing the quantity of mer-

it is obvious that we may so adjust the instru-

that the length  $\left(\frac{k^2}{h}\right)$  of the equivalent simple

ulum shall be unaltered by the change of tem-

perature, whatever be its amount, so long as it is not

enough to sensibly change the coefficients of

ation of the two metals. The screw at B has

ing to do with the compensation, its use is to

t the length of the pendulum so that it shall

te in one second.

he construction of the gridiron pendulum will

easily understood from the cut. The black bars

steel, the shaded ones are brass, copper, or some

nance whose coefficient of linear dilatation is

than double that of steel. It is obvious from

gure that the horizontal bars are merely con-

ers, and that their expansion has nothing to do

with the vibration of the pendulum, so they may be

of any substance. It is easily seen that an

ase of temperature lowers the bob by expand-

ing steel rods, whose effective length consists of

sum of the lengths of Aa, BC, and the steel bar

which the bob is attached; while it raises the

bob by expanding the brass bars, whose effective

length is that of one of them only; the other, as well

as the steel rod bc, being added to the instrument for  
the sake of symmetry, strength, and stiffness only.

If the effective lengths of steel and brass be  
inversely as their respective dilatation

coefficients, the position of the bob is  
unaltered by temperature; and there-

fore the pendulum will vibrate in the  
same period as before heating. This

is on the supposition that the weight  
of the framework may be neglected

in comparison with that of the bob;  
if this weight must be taken into

account, the requisite adjustments,  
though possible, are greatly more

complex, and can only be alluded to  
here. Practically, it is found that a

strip of dry fir-wood, carefully var-  
nished, to prevent the absorption of

moisture, and consequent hygrometric  
alterations of its length, is very little

affected by change of temperature;  
and, in many excellent clocks, this is used as a very

effective substitute for the more elaborate forms  
just described. To give an idea of the nicety which

modern astronomy requires in the construction of  
an observing clock, we may mention that the Rus-

sian astronomers find the gridiron superior to the  
mercurial pendulum; because differences of tem-

perature at different parts of the clock case (though  
almost imperceptible in a properly protected instru-

ment), may heat the steel or the mercury unduly in  
the latter; while, in the former, the steel and brass

bars run side by side through the greater part of the  
length of the pendulum, and are thus simultane-  
ously affected by any such alterations of temperature.

It would lead us into details of a character far too  
abstruse for the present work to treat of the effects

of the hydrostatic pressure and viscosity of the air  
upon the motion of a pendulum.

PENELOPÉ, in Homeric legend, the wife of  
Ulysses (Odysseus), and mother of Telemachus,

who was still an infant when Ulysses went to the  
Trojan war. During his long wanderings after

the fall of Troy, he was generally regarded as  
dead, and P. was vexed by the urgent suits of

many lovers, whom she put off on the pretext  
that she must first weave a shroud for Laertes,

her aged father-in-law. To protract the time, she

undid by night the portion of the web which  
she had woven by day. When the suitors had

discovered this device, her position became more  
difficult than before; but fortunately Ulysses

returned in time to rescue his chaste spouse from  
their distasteful importunities. Later tradition

represents P. in a very different light, asserting  
that by Hermes (Mercury), or by all her suitors

together, she became the mother of Pan (q. v.), and  
that Ulysses, on his return, divorced her in conse-

quence. But the older Homeric legend is the  
simpler and more genuine version of the story.

PENGUIN (*Aptenodytes*), a genus of birds of the  
family *Alcidae* (see AUK), or constituting the family

*Aptenodilæ*, regarded by many as a sub-family of  
*Alcidae*, and divided into several genera or sub-

genera. They have short wings, quite unfit for  
flight, but covered with short rigid scale-like

feathers, admirably adapted for swimming, and  
much like the flippers of turtles. The legs are very

short, and are placed very far back, so that on land  
penguins rest on the tarsus, which is widened like

the sole of the foot of a quadruped, and maintain a  
perfectly erect posture. Their bones, unlike those

of birds in general, are hard, compact, and heavy,  
and have no air-cavities; those of the extremities

contain an oily marrow. The body is of an elliptical



Fig. 4



Fig. 3



form; the neck of moderate length; the head small; the bill moderately long, straight, more or less compressed; the tail very short. Some of them have a long, slender, and pointed bill, the upper mandible a little curved at the tip, and



Penguin (*Aptenodytes pennatis*).

feathered for about a third of its length; some, sometimes called Gorfews or Gorfous (*Chrysocoma*) have a stout and pointed bill, a little curved at the tip; some, Sphenisques or Spheniscans (*Spheniscus*), have a straight and compressed bill, irregularly furrowed at the base. The Penguins are all among the most aquatic birds, although they are seldom seen very far out at sea; but it is only in the breeding season that they spend much time on shore. They are found only in the southern hemisphere, and chiefly in high southern latitudes, although some of the species extend into warm regions, as *Spheniscus Humboldtii* to the coast of Peru. Of this species, which is called *Pazaro niño*, or Child Bird, by the Peruvians, Tschudi states that it is easily tamed, becomes very sociable, and follows its master like a dog, waddling along in a very amusing manner with its plump body and short legs, keeping its balance by motions of its little wings. It displays considerable intelligence, and learns to answer to its name. In some of the furthest antarctic regions, penguins are prodigiously numerous, appearing on the shore like regiments of soldiers, or, according to another similitude which has been used by a voyager, like bands of little children in white aprons. They often occupy for their breeding ground a space of several acres, which is laid out and levelled and divided into squares, as nicely as if it had been done by a surveyor; whilst between the compartments they march as accurately as soldiers on parade. The KING P. (*A. Patagonica*), a large species, of the size of the great auk, dark grayish-blue above, white beneath, with a black head and a yellow curved band on the throat, is found in such numbers on some of the sandy antarctic coasts, that Mr Bennett describes one breeding ground on Maoquarie Island as covering thirty or forty acres, and, to give some notion of the multitudes, speaks of 30,000 or 40,000 birds as continually landing and as many putting to sea. On many of the antarctic shores, the penguins do not flee from nor seem to dread the presence of man, remaining as if stupidly indifferent, even when their companions are knocked on the head; their very indifference, it is said, suggesting

the idea of loneliness and desolation more fully than if there were a total absence of them. When attacked, however, they often shew courage in self-defence, and are ready to run with open arms against an invader. The young are reckoned on eating; the old are said to be black and tattered. The name P. is said to be derived from the Latin *pinguis*, fat.—Penguins make no nest, but lay a single egg in a chosen place on the shore; and the egg is carefully tended both by male and female. The female P. keeps charge of her young for twelve months.—Many of the penguins are brightly plumaged.—Cuttlefish, and other *Cephalopoda* form a great part of their food. Their voices are loud and harsh, between a quack and a bray; and there are many diversities in the different species.

PENICILLARIA. See GUINEA CORN MILLET.

PENITENTIAL PSALMS, seven of the Psalms of David, so called as being specially expressive of sorrow for sin, and accepted by Christian devotion as forms of prayer suitable for the repentant sinner. They are Psalms vi., xxxii., xxxviii., li., ciii., and cxliii. according to the Authorised Version, which correspond with vi., xxxi., xxxvii., l., ci., and cxlii. of the Vulgate. These Psalms have been set apart from a very early period, and are referred to as such by Origen (Hom. ii. in Leviticum). Innocent III. ordered that they should be read in Lent. They have a special place in the Roman Breviary, and more than one of the popes attained an indulgence to the recital of them. The most deeply penitential, and the most frequent in both public and private, is the 51st Psalm, or *Miserere* (50th in the Vulgate).

PENITENTIARIES, strictly so called, are institutions for the reception of penitent women in which confinement is purely voluntary. The name has also been applied to prisons under a separate system, having been adopted by the Quakers of Pennsylvania in 1786, when they caused the legislature of that state to abolish the punishments of death, mutilation, and the whip, and substitute solitary confinement as a reformatory process. Of penitentiaries, in the first instance, there are 63 in Great Britain and Ireland, capable of receiving 2657 inmates, besides numerous small private 'Homes.' The single condition of admission to most of the institutions is 'penitence,' a desire and endeavour to return to a virtuous life. The inmates remain in the strictest seclusion, the periods varying from a few months to two years, the average time being about a year; they return to their friends, or to situations proposed for them. It is an invariable rule not to disclose any one without seeing that she is provided with the means of honest subsistence. During seclusion they are employed in needlework, spinning, and housework. The ages at which women are received vary from 14 to 40. In the metropolis there are 19 institutions, accommodating 1155 women; in other towns of England, 34 institutions, accommodating 1116; and in the towns of Scotland and Ireland, 10 institutions with accommodation for 386. One third of the provincial, and one half of the metropolitan establishments have been created in the last ten years. The oldest institution in existence is the London Magdalen Hospital, opened in 1758; the next, of Dublin, 1767; Edinburgh follows in 1797; and none of the others date earlier than the present century. The results of these penitentiaries, as far as they can be ascertained, are excellent. During the last 100 years, 8983 women have passed through the London Magdalen, and the same

## PENITENTIARY—PENN.

that they have found, from their extensive experience, that 70 per cent. are permanently cured. All the institutions can shew a very high percentage restored to their friends and to

**PENITENTIARY** (Lat. and Ital. *penitentiaria*), is given to one of the offices of the Roman Church and also to the dignity (a cardinal, called *penitentiarius*) who presides over it. The cardinal penitentiary must be a priest and a doctor of divinity or canon law. He is named by the pope and should the penitentiary die while the office is vacant, the cardinals must be specially summoned to elect by secret scrutiny a pro-penitentiary to act for the time. The officials of the penitentiary, under the cardinal penitentiary, are three secretaries, three clerks, a corrector, a professor in theology, and another in canon law, or two minor officers. The subjects which come under the notice of the penitentiary are all relating to the confessional, especially the confession from sins and from canonical censures, appeals to the pope, and in certain cases dispensations from the impediments of marriage.

**PENN., WILLIAM**, a celebrated English Quaker philanthropist, the founder of the colony of Pennsylvania, was the son of Sir William Penn, an eminent English admiral, and was born at Weymouth on the 14th October 1644. His early years were spent partly in Essex and partly in Ireland, where he had several estates. P. studied at Christ Church, Oxford, and while here was converted to Quakerism by the preaching of a disciple of George Fox named Thomas Loe. His enthusiasm for his new faith assumed a pugnacious form. Not only did he attend personally to attend the services of the church of England, and to wear the surplice of that church—both of which he considered eminently proper—but, along with some companions who had become Quakers, he attacked several of the law-students, and tore the obnoxious robes from their backs. For this unseemly procedure he was expelled from the university. His father was excessively annoyed at his conduct, that he gave him a beating, and turned him out of doors; soon afterwards mollified, and sent his son to the continent, in the hope that change of air and the gaiety of French life would change the course of his mind. They failed, however, to do so, but the youth certainly acquired a grace and civility of address that he did not before possess. In 1666 the admiral sent him to Ireland to manage his estates in the county of Cork, which was to his father's complete satisfaction; for in the management of business he was as practical an Englishman as in religion he was an out-and-out mystic. In the county of Cork, however, he again fell in with Thomas Loe, and for attending a Quaker meeting and going with some others, imprisoned by the admiral, he was immediately afterwards released on his return to the lord president of the Council of Ireland, who was personally acquainted with him. On his return to England, P. and his father again fell out, because the 'conscience' of the former would not allow him to take off his hat to anybody, even to the king, the Duke of York, or the Duke of Devonshire himself. P. was again turned out of doors by his father, but assuredly provoked parent. The admiral, however, stepped in, and smoothed matters so that P. was allowed to return home, and the admiral even exerted his influence with the government to wink at his son's attendance at the illegal meetings of the Quakers, which nothing would induce him to give up. In 1668, however, he was committed to the Tower, on account of a publication

entitled *The Sandy Foundation Shaken*, in which he attacked the ordinary doctrines of the Trinity, God's 'satisfaction' in the death of Christ, and justification by the imputation of Christ's righteousness. While in prison he wrote the most famous and popular of his books, *No Cross, no Crown*, and *Innocency with her Open Face*, a vindication of himself, which contributed to his liberation, which was obtained through the interference of the Duke of York. In September 1670, Admiral Penn died, leaving his son an estate of £1500 a year, together with claims upon government for £16,000. In 1671, the upright but incorrigible sectary was again committed to the Tower for preaching, and as he would not take an oath at his trial, he was sent to Newgate for six months. Here he wrote four treatises; one of them, entitled *The Great Cause of Liberty of Conscience*, is an admirable defence of the doctrine of toleration. After regaining his liberty he visited Holland and Germany, along with Fox and Barclay, for the advancement of Quakerism. The Countess Palatine Elizabeth, the granddaughter of James I., shewed him particular favour. On his return, he married, in the beginning of 1672, Gulielma Maria Springett, daughter of Sir William Springett, and for some years thereafter continued to propagate, by preaching and writing, the doctrines of his sect. Circumstances having turned his attention to the New World, he, in 1681, obtained from the crown, in lieu of his monetary claim upon it, a grant of the territory now forming the state of Pennsylvania. P. wanted to call it Sylvania, on account of its forests; but the king (Charles II.) good-humouredly insisted on the prefix Penn. His great desire was to establish a home for his co-religionists in the distant West, where they might preach and practise their convictions in unmolested peace. P., with several friends, sailed for the Delaware in August 1682, was well received by the settlers, and on the 30th of November held his famous interview with the Indian tribes, under a large elm-tree at Shackamaxon, now Kensington. He next planned and named the city of Philadelphia, and for two years governed the colony in the wisest, most benevolent, and liberal manner. Not only Quakers, but persecuted members of other religious sects, sought refuge in his new colony, where, from the first, the principle of toleration was established by law. Having called the colonists together, he gave the infant state a constitution in twenty-four articles. Towards the end of the reign of Charles II., P. returned to England to exert himself in favour of his persecuted brethren at home. His influence with James II.—an old friend of his father's—was so great, that many people then, and some even yet, do not feel quite satisfied about the nature of their relations; but the suspicion that he allowed himself to be used as a tool by the court is really not justified by any known facts. It is possible, for his position was equivocal, but it is not proven, and Lord Macaulay—who has urged the view of his complicity in some of the disgraceful incidents that followed Monmouth's rebellion, with an ungracious animosity—has been convicted of haste and inaccuracy in several important particulars. At any rate, his exertions in favour of the Quakers were so far successful, that in 1686 a proclamation was issued to release all persons imprisoned on account of their religious opinions, and more than 1200 Quakers were set free. In the April following, James issued an edict for the repeal of all religious tests and penalties, but the mass of Nonconformists mistrusted his sincerity, and refused to avail themselves of it. After the accession of the Prince of

Orange as William III, P. was twice accused of treason, and of corresponding with the exiled monarch, but was acquitted. In 1690 he was arrested on a charge of conspiracy, but was again acquitted. Nevertheless, in the following year, the charge was renewed. Nothing appears to have been done for some time, but P. at last, through the kindly offices of his friends, Locke, Tillotson, and others, had the matter thoroughly investigated, and he was finally and honourably acquitted, November 1693. Shortly after, his wife died, but in less than two years he married again. His second wife, Hannah Callowhill, was a Bristol lady. In 1699 he paid a second visit to the New World, and found Pennsylvania in a prosperous condition. His stay, which lasted two years, was marked by many useful measures, and by efforts to ameliorate the condition both of the Indians and Negroes. P. departed for England towards the end of 1701, leaving the management of his affairs to a Quaker agent named Ford, whose villany virtually ruined Penn. When the rogue died, he left to his widow and son false claims against his master, and these were so ruthlessly pressed, that P. allowed himself to be thrown into the Fleet in 1708, to avoid extortion. His friends afterwards procured his release, but not till his constitution was fatally impaired. P. died at Ruscombe, in Berkshire, July 30, 1718. He left issue by both marriages. Upon the P. controversy it is unnecessary further to enter. We refer our readers to Macaulay's *History of England* (1849—1855); Hepworth Dixon's *Life of Penn* (new edit. 1856); J. Paget's *Inquiry into the Evidence of the Charges brought by Lord Macaulay against William Penn* (Edin. 1858).

PENNALISM, the name given to a practice once prevalent in the Protestant universities of Germany, which seems to have been essentially the same as the Fagging (q. v.) of the English public schools. The freshmen or students of the first year (called *pennals*—i. e., *pen-cases*; fags) were considered by the elder students ('schorists') as virtually their servants. Whatever property the pennals had they must give up to the schorists, who now employed them in the meanest offices, made laughing-stocks of them, and beat and ill-used them—all which had to be endured without complaint. After a year of this discipline followed the ceremony of 'deposition'—a practice older than pennalism itself, and borrowed probably from knightly consecration—in which the pennal underwent a number of symbolical trials, indicative generally of purgation from impurity and consecration to an intellectual life. Pennalism is said to have been introduced in the beginning of the 17th c., and to have been mostly confined to the Protestant universities of Germany. But although the full development of the system may have been thus restricted, germs and modifications of it were much earlier and more general, as is manifest from the prevalence of names of contempt for first year's students (see BEAN), and from statutes passed by French universities as early as the middle of the 14th c., against levying payments for first footing from them. See also FAGGING. The servitude imposed on the pennals was probably an aping of the usage of chivalry, by which a candidate for knighthood had to serve for a time as page to one already a knight. All attempts to check the evils of pennalism were long unavailing, as the pennals took part with the schorists in resisting all regulations of the authorities, which would have deprived them of the hope of exercising in their turn a like tyranny upon others. Edicts against the practice were issued in Jena and other universities about the beginning of

the 17th c., but it was not till the last half-century that the universities, by uniting in measures, were able to check the evil; and of it survived for a long time afterwards. The tation of the students, a kind of pennalism adopted by other bodies, more particularly printers, who retained the ceremony of 'deposition' after it had disappeared from the universities. Schöttgen, *Historie des Pennalwesens* (Dresd.

PENNANT, THOMAS, LL.D., tourist, naturalist, and antiquary, was born June 14, 1726, at Downham, in Flintshire, and educated at Queen's and Brasenose Colleges, Oxford. His first important publication was the *British Zoology* (1761—1769), which contained in all 132 plates on imperial paper, engraved by Mazel, and established his reputation. His literary work was in course of publication, P. made several tours to the continent, and saw some of the scientific and literary celebrities of the time, as Buffon, who favourably mentioned him in his great work *Natural History*, Voltaire, Haller, the two Georges, and Pallas. In 1769, he made the first of his tours in Scotland, penetrating to the remotest parts of the country, which, he says, was then 'almost entirely unknown as Kamtschatka.' He returned to England with a very good opinion of it, and published his *History of Scotland* in 1771, in consequence of which (according to the same author) Scotland has 'ever since been inondée with sojourners.' The year before, he added 103 new species to his *British Zoology*, with descriptive notices in 1771, printed at Chester his *Synopsis of the British Insects*, subsequently enlarged and improved under the title of *History of Quadrupeds*. Of this work Cuvier says: 'It is still indispensable to those who wish to study the history of quadrupeds.' In the same year the university of Oxford conferred on him the degree of LL.D. Next year he undertook a second and most important tour in Scotland, which included a voyage to the Hebrides (an account of which appeared in 3 vols. 1775). P. was warmly welcomed by the inhabitants. Almost everywhere he was received with some formal compliments, and he returned 'rich in civic honour.' In 1771 he published his *Genera of Birds*, and made a subsequent tour through the north of England. His subsequent tours through Wales do not require special notice. In 1777 appeared a fourth volume of his *British Zoology*, containing the Vermes, Crustaceans and the Testaceous Animals of Great Britain. Among a great variety of later publications, we may mention in particular an amusing life of himself (*The Literary Tour of the late Thomas Pennant, Esq., by himself*, 1798). He died December 16, 1798.

PENNA'TULA, a genus of zoophytes (*Animalia*) allied to *Gorgonia* (q. v.) and *Acyonium* (q. v.), having very similar polypes; but the polype is not fixed by its base, has a fleshy stem strengthened by a bone, and a skin containing calcareous matter. The upper part of the stem winged on two sides with numerous pinnae, along the upper margin of which the polype-cells are ranged. The form somewhat resembles a quill, so that the name *SEA PEN* is very often given to zoophytes. One species, *P. phosphorea*, is common on the northern parts of the British coast, and grows from two to four inches in length, of a purple colour, and like many—perhaps all—of the species, is sometimes brilliantly phosphorescent, emitting flashes of light when disturbed, but is not luminous on relapsing into quiescence. The stalk is hollow in the centre, and the bone which it contains—and which is composed of phosphate and carbonate of lime, like the bones of the brachiopods—is a very remarkable part

structure, not extending the whole length of the stalk, slender, straight, and perfectly simple, but bent backwards at each end into a hook. Other species are found in the Mediterranean and other seas, some of them more pen-like than even the



*Pennatula (Virgularia mirabilis).*

fish one. It has been alleged that they swim by contractions and dilatations of their common substance, or by movements of the pinnæ; there is no good evidence of their possessing such power of locomotion, which is very contrary to the analogy of all similar zoophytes, and is probably the opinion prevalent among the fishermen of the Scottish coasts is the correct one, their natural place is at the bottom of the sea, and the somewhat flexible lower end of the stalk is buried in mud. Nearly allied to the pennatulæ is another genus of extremely beautiful zoophytes, *Virgularia*, ranked with them in the family Pennatulæ, and sometimes receiving the popular name SEA RUSH. One species, *V. mirabilis*, is found on the British coasts. It resembles a slender rod, bearing throughout the greater part of its length two rows of lobes, along the margin of which the polypes are arranged. The whole length is from six to ten inches.

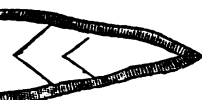

Pennon.

the charge. The accompanying example is the brass to Sir John D'Aubernoun at Stoke Newington, Surrey; it is azure, charged with a pennon and fringed gules.

**PENNONCELLE**, a long streamer-like flag, the native of the Pennon (q. v.).

**PENNSYLVANIA**, one of the thirteen original States of America, now the second in population, and called from its position and importance 'Keystone State,' is in lat. 39° 43'—42° 15' N., 74° 75'—80° 37' W. It is bounded N. by Lake Erie and New York; E. by New York and New Jersey, from which it is separated by the Delaware River; S. by Maryland and Virginia; and W. by Pennsylvania and Ohio. The small state of Delaware borders for a few miles on its south-eastern angle. Its form is very regular, the boundaries of three degrees being lines of latitude and longitude. It is 340 miles long, 160 wide, containing an area of 46,000 square miles, or 29,440,000 acres, divided into 27 counties. The state is divided near the middle of the Alleghanies into an eastern region, whose

waters fall into the Delaware and Chesapeake Bays, and a western, in which the principal rivers are the Alleghany, the Monongahela, and other important affluents of the Ohio. These, with the Delaware and Susquehanna, Lehigh, Schuylkill, and Juniatta, are the principal rivers. The chief towns are Philadelphia, on its south-eastern border; Pittsburgh, at the head of the Ohio; and Harrisburgh, the capital, on the Susquehanna. The Blue Ridge, which enters the south-eastern portion of the state, rises to the height of 1500 feet; the passes of the Alleghanies are 2000 feet high, and single peaks 3000 feet. Lake Erie is 650 feet above the ocean. The geological formations range from the Potsdam sandstone to the coal-measures. There is middle secondary red sandstone and drift in the north-east; gneiss and red sandstone in the south-east; the centre of the state is a rich and fertile limestone valley. Near Philadelphia are fine quarries of white marble. The great anthracite and semi-anthracite deposits of coal are east of the Alleghanies; west are the great beds of bituminous coal, which largely supply the Mississippi valley. Salt is found beneath the coal, and in the bituminous districts great deposits of petroleum. Adjacent to the coal-measures are rich beds of iron ore, also lead, copper, nickel, and chrome ores. The climate is mild, and the soil fertile, producing abundance of wheat, Indian corn, oats, rye, buckwheat, potatoes, flax, hemp, tobacco, hay and pasturage, with apples, pears, peaches, grapes, &c. While one of the best agricultural states, P. has also a large industry engaged in mines and manufactures, coal, iron, woollen, and cotton. The state has more than 3000 miles of railways, 1030 of canals, 26 colleges, 8 schools of medicine, 20 state academies, 335 public schools, having 14,000 teachers and 647,414 pupils, 4000 churches, 400 public and school libraries, 310 periodicals—of which 27 are daily papers, and 71 literary publications—2 state penitentiaries at Philadelphia and Pittsburg on the solitary system, asylums for insane, blind, &c., Girard College for orphan boys. In 1627 a colony of Swedes and Finns settled on the river Delaware. In 1631 the territory was granted by Charles II. to William Penn, who, by the industry of his co-religionists, the Society of Friends, by cultivating peace with the Indians and encouraging emigration, founded a rich and flourishing state. It was the scene of Braddock's defeat in the French war; and in the revolution of 1776, Philadelphia was the chief city and capital of the Federation, near which were the actions of Germantown, Brandywine, &c. The population, largely Scottish and German in its origin, was in 1800, 602,361; 1820, 1,049,458; 1840, 1,724,033; 1860, 2,906,370.

**PENNY**, a British coin and money of account. After the Sceattas (q. v.) it is the most ancient of the English coins, and was the only one generally current among the Anglo-Saxons. The name is evidently the same as the German *pfennig*, and both words seem to be intimately connected with the old German *pfant*, a pledge, and the Latin *pendo*, to weigh or to pay. Both in Britain and on the continent the word was anciently used for money in general, hence we have such phrases as, 'he has got his penny-worth,' i. e., he has got value for his money, &c. The penny is first mentioned in the laws of Ina, king of the West Saxons, about the close of the 7th century. It was at this time a silver coin, and weighed about 22½ troy grains, being thus about 1/15th of the Saxon pound-weight. This relation to the pound-weight is evidently derived from the usage of the early Franks, who retained the Roman division of the *libra* into 20 *solidi*, and the *solidus* into 12 *denarii*

(the denarius being thus the 240th part of the libra or pound. See MARK. Halfpence and farthings were not coined in England till the time of Edward I., but the practice previously prevailed of so deeply indenting the penny with a cross mark, that the coin could be easily broken into two or four parts as required. Silver farthings ceased to be coined under Edward VI., and silver halfpennies under the Commonwealth. By this time the penny had steadily decreased in weight; it was 18 grains under Edward III., 15 and 12 under Edward IV., 8 under Edward VI., and under Elizabeth it was finally fixed at  $7\frac{1}{2}$  grains, or  $\frac{1}{4}$  of an ounce of silver, a value to which the subsequent copper pennies, which till 1860 were the circulating medium, closely approximated. In 1672 an authorised copper coinage was established, and halfpence and farthings were struck in copper. The penny was not introduced till 1797, and at the same period the coinage of twopenny pieces was begun; but these latter, being found unsuitable, were withdrawn. The penny of the present bronze coinage is of only about half the value of the old copper penny. The German *pfennig* was also originally a silver coin, bearing the same relation to the German pound of silver as the English penny to its pound. And in the 12th c. it was made so broad, in imitation of the Byzantine coins, that it would no longer bear to be struck with a die on each side as before, but was struck on one side only. In the beginning of the 14th c. the mark of silver was anew divided into 60 parts or coins, which, to distinguish them from the old coins, were called *grossi denarii*, whence the term *groschen*. In the modern money system of Prussia, the pfennig is a copper coin, the twelfth part of a groschen.

**PENNYROY'AL**, a species of Mint (q. v.). The name P. is given in North America to a small plant, *Hedeosma pulegioides*, allied to the mints, and having,



Pennyroyal.

like them, a pleasant aromatic smell, and a warm pungent taste; which is much in use in domestic medicine, in the form of a warm infusion, to promote perspiration and as an emmenagogue.

**PENNY WEDDINGS, or PENNY BRIDALS**, was the name given to festive marriage ceremonials

in Scotland, at which the invited guests made contributions in money (seldom more than 1s. each), to pay the general expenses, and leave over a small sum, which would assist the newly-married pair in furnishing their dwelling. This practice, now disused, was prevalent in the 17th c.; and, as leading to 'profane minstrelsing and promiscuous dancing,' was denounced by an Act of the General Assembly of the Kirk, 1645, as well as by numerous acts of presbyteries and kirk-sessions about the same period.

**PENOBSCOT**, a river of Maine, U.S., rises near the centre of the state by two branches, from a chain of lakes extending north-westerly; and after a south by west course of 135 miles from the junction, or 275 in all, empties into Penobscot Bay, a broad and sheltered opening into the Atlantic Ocean, 20 miles wide, with several large islands. Its chief towns are Belfast, at its mouth; Bangor, 50 miles above, where falls supply power to saw-mills and factories; Castine, and Bucksport. It is navigable to Bangor, where there is a tide of 20 feet. The chief trade is pine timber.

**PENRITH**, a market town of Cumberland, in a picturesque and fertile valley, with rich and striking scenery in the vicinity, stands on the Carlisle and Lancaster Railway, 17 miles south-south-east of Carlisle. In the parish churchyard is a monument of great antiquity, formed of two pyramidal stones about 12 feet high, and known as the 'Giant's Grave.' The town contains an ancient free grammar-school, and other educational institutions. A new and beautiful church, built in the style of the 13th c., was consecrated here in 1850. Cotton, linen, and woollen goods are manufactured. Pop. (1861) 7139.

**PENRY'N**, a municipal and parliamentary borough and market town of England, in the county of Cornwall, in a warm, sheltered, and richly productive valley, on the Plymouth and Falmouth Railway, two miles west-north-west of Falmouth. It stands on a low hill projecting eastward into Falmouth Harbour. Trade is carried on to some extent with the mining district of Redruth, and there are several quarries in the vicinity, from which the famous P. granite—the material of which Waterloo Bridge, the Chatham Docks, and a great number of other important public works are constructed—is obtained: 20,000 tons of granite have been exported in the year, but the quantity varies much. Pop. (1861) of municipal borough, 3547. Together with Falmouth, it forms a parliamentary borough, which returns two members to parliament, and the population of which, in 1861, was 14,485.

**PENSACOLA**, a town and port of entry, on a deep bay opening into the Gulf of Mexico, at the south-western extremity of West Florida, U.S. Lat. 30° 24' N., long. 87° 10' W. The town, nearly destroyed during the war of 1861, is on the north shore of the bay, and is connected by railway with Montgomery, Alabama. Near the entrance were the navy yard, hospital, and Fort Barrancas. The entrance is further defended by Fort Pickens, at the west end of Santa Rosa Island, and Fort M'Rae on the opposite point. The bay branches into two divisions, receiving the Escambia and Yellow Rivers. As one of the best harbours on the gulf, P. was settled by the Spaniards, occupied by the British in 1814, and acquired by the United States in 1821.

**PENSION** (Lat. *pensio*, from *pendo*, to weigh out, to pay), an allowance paid annually by government to an individual in consideration of past services, civil or military. See CIVIL LIST.

**PENSIONS AND PENSIONERS, MILITARY AND NAVAL**. There are pensions for good service,

PENSIONS AND PENSIONERS -PENTACRINUS.

ere faithful ordinary service, for wounds, and representatives of deceased officers.

*Widow-Service Pensions* are rewards to selected in the British navy for distinguished service. 34 they are as follow: 7 admirals have £300 21 captains £150, 1 general of marines £300, 3 lieutenants £150, and 3 medical officers £100; the charge being £6150. The corresponding in the army is called a **REWARD FOR DISTINGUISHED SERVICE** (q. v.).

*Pensions for Long Service* are awarded in the to non-commissioned officers and soldiers who served 21 years in the infantry, or 24 years in cavalry, or earlier if disabled from further service, owing to the wounds, loss of health, and conduct of a pensioner. The amount is fixed by the Commis- sioners of Chelsea Hospital, and varies from 1½d. to 6d. a day, the lower rates being mainly con- sidered for negro pensioners from the West India Regiments.

Pensioners are either *in-pensioners* of Chelsea (q. v.) or Kilmainham Hospitals, in which they forego their proper pension, and receive a small sum for tobacco-money, and for pensioners residing where they please, and for their pensions from the staff officers of the Regiments, of whom there is one in every com- pany. These men can follow other pursuits, often with great success, as their military habits and regularity stand them in good stead in civil life. The railways give employment to great numbers of pensioners, as signalmen, guards, &c. Pensioners who are in good health, and are willing to do such service, are enrolled in a force called the *Retained Pensioners*, which forms a defensive corps of 1000 men. This gives the men, as an adjunct to their pension, an annual retaining fee of £1 each, and a pay during the yearly training, of 8 days at the rate of 2s. a day for privates, 2s. 6d. for corporals, and 3s. for sergeants. The veterans are officered by their respective staff officers, and, in case of emer- gency, would be embodied for service. As garrison troops, these old soldiers would doubtless prove themselves valuable. A pension is forfeited if the holder is convicted of felony. The number of pensioners in 1864 is 61,917, and their pensions amount to £1,198,000. These are exclusive of 538 in-pensioners of Chelsea, and about 130 of Kilmainham; the cost of these establishments together being £33,260. The most of the enrolled pensioners is £40,000 in pension, and that of the 1500 men composing the reserve (see RESERVE) £10,000 more.

*Naval Pensions for Long Service* are given to officers, seamen, and marines, under principles generally similar to those for the army; the pensioners of Greenwich Hospital awarding the pensions, Greenwich Hospital being the home of the pensioner, and the out-pensioners drawing their pensions through the staff officers of military regiments. In 1864, 7536 petty-officers and sea- men and 5201 marines receive pensions, producing a total of £245,082, 10s.

Under this section should be mentioned pensions for special bravery in action, granted with the Victoria Cross (q. v.).

Pensions for wounds are common to both services, and are limited to officers. They are awarded annually by the Secretary for War and Lords of the Admiralty, for serious bodily injury, as the loss of an eye, or ear, and vary according to the rank of the officer and other circumstances. In cases of less serious injury, temporary pensions are sometimes granted, or gratuities. The charge for pensions for the year 1864 is—army, 290 recipients, £29,663; navy, 570 recipients, £36,858; total, £66,521. In the case of common soldiers and sailors, wounds are given to hasten or augment the pension for

service (see above); but they have no distinctive pension for wounds.

Widows of commissioned and warrant officers in the army and navy receive pensions so long as they remain unmarried, provided they have been married severally twelve months when their husbands die, and that the latter were under 60 years of age (50 for warrant officers) when they married the claimants. Such pension is not granted if the widow be left in wealthy circumstances, and lies dormant during a second marriage, though it may be revived should she again become a widow. The amount of pension varies according to rank, and there are three distinct classes for each rank: 1st, When the husband was killed in battle, or died within six months of wounds received therein; 2d, When he died from some cause distinctly falling within the sphere of his duty, but not from wounds in action; 3d, When he died in the course of nature. The following table shows the amount of pension to widows of combatant ranks, civil ranks receiving similar rates according to relative standing. See RELATIVE RANK.

Widow of	PER ANNUM.		
	1st Class.	2d Class.	3d Class.
Flag-Officer, or General Officer,	According to circumstances. £120		
Captains in Navy; Col- onels in Army,	£200	{105 Cptns. } {150 Cois. }	80 & 90
Lieutenant-Colonels in Army,	200	140	80
Commanders in Navy; Majors in Army,	120	100	70
Lieutenants, Navy; Captains, Army,	80	65	50
Sub-Lieutenants, Navy, Lieutenants, Army,	60	50	40
Ensigns, Army,	50	40	36
Gunners, Boatwains, Carpenters, Navy,	35	30	25

Compassionate allowances are small additional pensions granted to the children of deceased officers, left in indifferent or bad circumstances. They vary from £5 to £40 each, and can be held by boys till 18 (unless earlier provided for), and by girls until 21, or an earlier marriage. If an officer fall in action, without leaving a widow or orphans, but leaving a parent who had been more or less dependent on him, such parent may be granted the pension or a portion of it, and is sometimes allowed to commute the pension into a single payment. In very special cases, the sisters of an officer, who had been more or less dependent on him, are granted com- passionate allowances. The cost of widows', &c., pensions for 1864 stand as follows:

Army—Pensions to 2330 widows,	£127,912
Compassionate allowance to 1527 orphans,	22,153
Royal bounty allowances to 213 widows, mothers, and children, and relief fund,	20,921
	£170,986
Navy—Pensions to 3619 widows,	£180,414
Compassionate allowances to orphans,	15,000
	£195,414
	£366,400

**PENSIONARY, GRAND, OF HOLLAND.** See GRAND PENSIONARY.

**PENTA'CRINUS**, a genus of *Echinodermata*, of the order or family *Crinoidea* (q. v.), remarkable as containing the only permanently stalked Crinoidea, or Crinoidea believed to be permanently stalked, known now to exist, and thus the only true living representative of the fossil Encrinites (q. v.). The genus P. has a long pentangular column of numerous

joints, from which there arise at intervals many whorls of unbranched arms, and which bears at its summit a disc at first divided into five radiating members, and afterwards branching into ten arms, each further subdivided. The whole of this skeleton is calcareous, but it is united by cartilages, and covered with a fleshy integument. *P. Caput Medusa*, the MEDUSA'S HEAD, is found in the West Indian seas, and is very rare in collections, being only dredged up from waters of considerable depth; from which cause also the nature of the base of the column is not certainly known. The stem is more than a foot long.—The fossil species of *P.* are numerous in the Lias and Oolite formations. They gradually become fewer in the newer rocks.—The stalked young of *Comatula rosacea* was at one time regarded as a *P.*, and described under the name of *P. Europæus*. See CRINOIDEÆ.

**PENTADESMA**, a genus of trees of the natural order *Guttifera*, to which belongs the BUTTER-AND-TALLOW TREE of Sierra Leone, *P. butyracea*. It is a tree sixty feet high, and produces a conical fruit of the size of a very large pear, the pulp of which abounds in a yellow oily substance, with a strong flavour, somewhat resembling that of turpentine, yet much used by the natives as an article of food. The 'country butter,' brought to the market of Freetown, is supposed to be procured from this fruit.

**PENTASTYLE**, a building with a portico of five columns.

**PENTATEUCH** (Gr. fivefold book), a name given by Greek translators to the five books ascribed to Moses, which are in Hebrew called collectively *Torah* (Law), by way of eminence, or *Chamisha Chumshe Torah* (five-fifths of the Torah). *Law* is also the general name by which the work or portions of it are referred to and quoted (the words 'of Moses' or 'of the Lord' being added occasionally) both in the Old and New Testament.

The division into five portions (further divided into 50, 40, 27, 36, 34 chapters, or 12, 11, 10, 10, 11 Parshioth or Sidras respectively, by the Masoretes) is, if not original, at all events of a very remote date, and certainly anterior to the Septuagint. Genesis, Leviticus, and Deuteronomy, the first, third, and fifth books, form clearly defined and internally complete parts of the work as a whole, and thus, also, fix the limits of the intermediate second (Exodus) and the commencement of the concluding fifth (Deuteronomy). The chief aim of the Pentateuch being to give a description of the origin and history of the Hebrew people up to the conquest of Canaan, together with the theocracy founded among them, the centre is formed by the person of Moses himself, the regenerator and lawgiver of the nation. Genesis, beginning with the history of the creation and antediluvian genealogy from Adam to Noah, in rapid outlines sketches the propagation of the various tribes that descended from the one man who was saved in the Deluge, but dwells with special emphasis upon Shem, from whom sprang, in the tenth generation, Abraham, the progenitor of the 'people of the covenant.' The salient events in the lives of his descendants, the Patriarchs, are minutely described; and a fitting close is found in the benediction of Jacob, who, as it were, inaugurates and confirms all his twelve sons in the covenant made between Abraham and God. Exodus, treating of the liberation of the people from Egypt; their wanderings in the desert; the promulgation of the Law, by which they became emphatically the 'holy nation' and the 'people of the Lord;' and the erection of a visible sanctuary; may be regarded as the nucleus of

the work; while Leviticus, the following fittingly enters into the details of the legal and the mode of worship; chiefly concerning priests and Levites, the expositors of the Law, and, in a manner, the spiritual representatives of the other tribes. The historical thread is up again in Numbers, the fourth book, which side by side with the relation of the events belongs to the Sinaitic period and the beginning of the fortieth year after the Exodus, contains laws explanatory of, or complementary to, those of the former books, together with such circumstances had called into existence. A recapitulation of the preceding portions; the most impressive and reiterated exhortations to obey that Law, which was now completed, and so transmitted to the Levites; and the death of the legislator himself; form the chief contents of the fifth book, or Deuteronomy. Thus, the cratic plan of the work is carried through to the beginning to end, coming out more prominently in the three intermediate books, but never lost of entirely. Nothing is dwelt on or even touched upon save that which in some way illustrates either the relation of God to the people, or of the people to God; the political, civil, and domestic laws themselves, being enumerated only as bearing upon the main aim and object of the work.

The special books being treated separately under their respective heads, we have here only to consider some questions relating to the work as a whole, and principally that of its authorship. In history, as far as these points have not been touched upon already under GENESIS. Tradition, as embodied in the earliest historical records, mentions Moses as the writer of the complete Pentateuch, such as we have before us: with the exception of a few verses, dating the last moments of the lawgiver, &c., which are ascribed to Joshua. This tradition has for many long centuries been almost universally adhered to, and that there have not at different periods suspicions been raised respecting this 'authenticity,' Pseudo-Clementines, for instance, assumed that the Law, orally delivered by Moses to the Elders before and after its being committed to writing, had undergone innumerable changes, nay, corrupted among these the too personal and human modifications of God, and the unworthy traits recollections of the Patriarchs. Jerome expresses himself in a somewhat doubtful manner on the relation of Ezra as the 'redactor,' or rather 'restorer,' of the Pentateuch. Aben Ezra boldly calls some of the passages later interpolations, and speaks of them still more poignantly as a *Saad*, or a 'Myth,' i. e., as containing difficulties not to be cleared up in consonance with the common belief, which, however, was too pious wantonly to disturb. His voices, vaguely lifted up by more or less competent scholars, remained unheard. It was not until after the Reformation, at the dawn of the exegetical and critical modern age, that the question whether this codex was the work of one man, or even of one age, and what share, if any, Moses had in its composition, began to be discussed seriously on scientific grounds. Hobbes held that the Pentateuch was rather a work on, than by Moses. Spinoza came to the conclusion, that it was to Ezra that it was indebted for the book in its present shape, and that it embodies certain genuine portions, collected in a late period, together with a vast amount of material, added at various periods subsequent to the time of the supposed author. Vitringa, Le Clericus, Rich., Simon, and others, followed, raising and enlarging the discussion chiefly respecting the difficulties which presented themselves in the accounts of the creation, and the like, cont-

sis. The next, and indeed the most important—because the one which at once removed the question from the field of hazy and timid notions to that scientific basis upon which rests, was taken by Astruc, who, from the marked difference of the Divine names used in Genesis and the beginning of Exodus—noticed CALMUD and the FATHERS OF THE CHURCH—led to the conclusion, that these books had been worked up from different original documents, the one called Jehovistic and Elohistie respectively. See article GENESIS, where the development of this speculation is described. At the present stage of investigation, the view very generally adopted is ‘complementary theory,’ which assumes, with certainty, two or more authors—Jehovistic and Elohistie—for the whole of the first four chapters at least; the fifth being by some (Delitzsch, Kurz, &c.) still ascribed chiefly to Moses’s hand. Only a small apologetic school, of which the chief spokesman is Hengstenberg, still upholds the integrity and authenticity of the work, naming Moses its sole author. The contemporary discussions on these points, which, up to a very recent period, were chiefly confined to Germany, have now also found their way into England. The impulse to the controversy in this country was principally given by Dr Davidson, ‘Lectures on the Pentateuch,’ and Bishop Colenso, ‘The Pentateuch,’ on the basis of these German investigations, which raised some new points. Innumerable articles by more or less competent champions, have since been published; but as yet, so far from either of the parties having declared themselves convinced by the arguments from the other side, the controversy continues new publications uninterruptedly. The chief objections raised against Mosaic authorship, and the replies given thereto, must remind the reader that ours is only a fragment of epitomisers, as it were, and that the nature of our task precludes us from giving an opinion whatsoever about the superior force of the arguments on either side. The Pentateuch, alleged to be the production of one man, ought, first of all, ought to contain neither unnecessary repetitions of considerable length, nor contradictions, nor anachronisms. There ought to be an unity. Yet, there can be no doubt, from the fragmentary character of the work. Many portions, evidently complete in themselves, are strung together without the slightest sequence, nay, in an unchronological order. Repetitions and contradictions, there is, with, the very history of the creation, which is given twice in the first chapters of Genesis, is each given differently, and in each account the name is consistently mentioned in a different way. The same is to be said with regard to the account of the Deluge, and several incidents in the lives of the Patriarchs; the important conversation between God and Moses respecting Aaron (Exod. x. 1-16, and vi. 9); the descriptions of the tabernacle, the priestly vestments; the story of the golden calf as given in Exodus and Numbers; the account of the appointment of the council of the elders in the same books; &c. Again, the work sometimes seems to indicate an author who was the legislator himself, such as the phrase ‘I am the Lord,’ being the humblest of men; and the account of the death; the passage in Genesis ‘before I came down to Egypt,’ signed any king over the children of Israel’ (Gen. xiv. 14, Deut. xxxiv. 1), so called only of the conquest by that tribe. In Numb. xxxii. 1-31, we have an enumeration of a certain

number of towns and villages built by the tribes of Gad and Reuben—an event which could not have happened during Moses’s lifetime; further, the frequent occurrence of the formula ‘unto this day’ (e. g., Deut. x. 8, where the author speaks of the institution of the Levites as being still in force ‘up to this day’), &c. It is contended, also, that the language of the Pentateuch varies very little from that of the last prophets, and that it can hardly be assumed that a thousand years should have made no perceptible difference in the idiom; more particularly has Deuteronomy been supposed to bear a striking resemblance, in style and language, to Jeremiah. The Pentateuch is further said to contain many facts palpably contradictory to natural laws, as they are established in the experience of the whole historical human race, and systematised by science.

Of the many ways to get rid of these and similar—old and new—exceptions, the most generally adopted is that which we mentioned as the method of ‘interpolation,’ by which the Apologetic School strikes out some fifty or more passages, as not belonging to the original work, but having crept in, by way of commentary, note, or explanation, in post-Mosaic times—the body of the work being thus saved, so to say, by a most extensive amputation. As to the argument from the language, it is said that the Pentateuch, being the divine book, by way of eminence, and embodying the very phrases (to the letter) made use of by the Almighty, must needs have served as a model for the next thousand years, and priests and Levites, the teachers of the people, were enjoined constantly to study and read it: hence the small difference in the later writers. Arabic and Syriac, it is argued, did likewise not change essentially for many centuries—an assertion, however, which only holds good if ‘many’ is taken in a very vague sense indeed. That Deuteronomy differs in style and manner, is verbose, &c., is explained by Moses’s advanced age. On the other hand, events which are not in harmony with the ‘natural laws,’ are accepted by the orthodox simply and literally as ‘miracles,’ while ‘conservative’ rationalists of the school of Eichhorn, Rosenmüller, and others, who stand by the authenticity of the Pentateuch, have been at great pains to find some kind of poetical interpretation for them.

The most recent attacks on the authenticity are chiefly founded upon arithmetical grounds. The numbers of the people, their cattle, and the like, at various periods, do not seem to conform to the laws of natural increase, or even to the geometrical limits within which they were at times stated to have been confined. Among the direct proofs, however, proffered by the defenders of the authenticity, the following chiefly deserve attention. Deuteronomy, it is averred, can only be the work of Moses. He speaks in it to the men whom he has led for many years, as one who has lived through all the events himself. There is no possibility of any one imitating the local colouring in such a manner. If, then, Deuteronomy must be allowed to be the work of Moses, the three preceding books, to the contents of which frequent allusion is made, must equally be supposed to be finally redacted, if not written, by the same hand; and it further follows naturally, that the introduction to these books, which is Genesis, must have emanated from it. Again, any one writing after Moses, could not possibly have possessed the extraordinarily correct knowledge of contemporary Egypt and Arabia, which appears throughout the Pentateuch. A writer who might be supposed to have acquired it by dint of study of antiquities, must, it is said, have betrayed himself on every page by inaccuracies and



anachronisms. Nineveh is in Genesis a city of as yet little importance; while Resen, of which no trace is to be found in any other part of the Bible, is the great metropolis of Assyria of the time. Tyre, great in the days of David, and mentioned already in Joshua, is not to be met with in the Pentateuch, where a later writer would certainly have spoken of it in connection with Sidon. The Canaanite gods and altars are often spoken of; never their temples, of which yet we read in Joshua. Why, then, should that very ancient author, to whom must needs be traced the Pentateuch, not be Moses himself, rather than some contemporary of his? The fragmentary, abrupt, and, as it were, confused character of the work, the apologists further urge, so far from testifying against Moses, confirm the tradition of his authorship. Would not a later historian have worked the mixed mass of historical, geographical, legal, and personal material into a methodical and systematical whole? Who else could have imparted to the book the impress of a diary, so to say, but the man who was in the midst of the events, jotting down all the items important either in his own individual or the national career? And who but one standing in its very centre could depict with such glowing colours the life that moved around him?—But a further direct argument for the authenticity is found by them in the very item of the language of the Pentateuch. True, they say, it resembles as much as can be that of the later books, because, as we said before, it remained the classical language for all later generations; but, on the other hand, it offers certain peculiarities—such as the use of a common pronoun of the third person singular for both the masculine and feminine genders; the same term for boy and girl; and the like archaisms—all of which distinctly prove it to be a work of a very much older date. The existence of an ancient Mosaic code of laws would further appear proved beyond any doubt by the constant recurrence of quotations from ‘the Law of Jehovah’ or ‘the Law of Moses’ throughout the other books of the Old Testament from Joshua to Hosea. Had there in reality been no such code in existence, the authors of the different biblical works could not possibly have so unanimously spoken of it without betraying a conscious forgery somewhere. That Ezra should have been the author, or, at all events, the refounder of the Pentateuch, is equally improbable, on account of the spirit, tone, language, and all those smaller peculiarities of which mention has been made; and he would, on the other hand, never have been able so skilfully to avoid his own individual manner and style, as it appears in his own book. The Samaritan P., it is further said, which, with a very few characteristic alterations, is an accurate transcript of our Pentateuch, would have been an utter impossibility, considering the hostile relations between the Samaritans and the Jews, if it had not been well known as a genuine document before the division of the empire. That Hilkiah, who is said to have found the Book of the Law in the temple in the days of Josiah (2 Kings, xxii.; 2 Chron. xxxiv.) should have been its real author—an opinion first advanced by De Wette—would imply a complicity in the forgery not only on the part of Jeremiah, Huldah, and the elders, but almost of the whole people, among whom, on the contrary, there certainly seems to have been living a very vivid tradition of the former existence of the book or some of its portions at least. Moreover, had it been first written in those days, there surely would have been introduced some kind of prophetic allusion to the royal house of David, or, at all events, a pedigree and origin differing from the incestuous

one given in Gen. xxxviii. Deuteronomy altogether have changed its language about (xvii. 15—20) very considerably; and it would not have stood out so prominently favoured tribe. The alleged difficulties respecting the numbers are explained away more or less convincingly—in the most difficult cases, by minor interference. Corruptions, interpolations, many fates that befall ancient documents allowed to have crept in, in some places; and this argument is given up by those who hold a special providence watched over the divine. In all other respects, they hold these books exactly as they were written by Moses under ‘Inspiration.’—Thus far, in swiftest outline pros and contras most commonly adduced worthy of some consideration.

A few rationalistic critics, however, have far as to deny the very possibility of Moses giving the laws contained in the Pentateuch, founding their objections upon the ground that was not likely to have been versed in the writing to an extent which the composition of laws would presuppose. Egyptian characters which he might have been familiar, could not have been used for Hebrew composition; and the Hebrews themselves, uncultivated as they were, not possess any characters of their own. They reply, in reply to these objections, that fact stated, that a soberer criticism of more recent times has found itself obliged, in deference to paleographical and other scientific truths, to forego most of these points, or, at all events, to forego such sweeping condemnation upon those who remain. On the contrary, whichever of the theses enumerated at the beginning is assumed as the groundwork of the legislation is traced by almost unanimous consent, to the historical person of Moses, who is no longer the mythical demigod of barbarous hordes, but a man, such as we endeavour to sketch under that head. The redaction of these laws, however, as of the Pentateuch, is almost as unanimously held, especially by German critics—placed in agreement after him.

In the contemporary ‘moderate’ school of thought, so far as we have been able to glean from their writings, the following seems to be the prevailing opinion on the point of the Mosaic authorship: it is allowed, that Moses did not write the whole of the Pentateuch, but portions of Exodus, Leviticus, Numbers, and the whole of Deuteronomy, with the exception of the account of his death, and some portions as palpably shew an author who presided over the imminent dissolution of the empire. The fundamental Law (Decalogue) should be traced to two varying versions, they hold, strengthening the assumption of their genuine Mosaic authorship to some original shape. The later editor, finding different recensions made by contemporaries in subsequent ages, embodied them both, on account of their paramount importance, literally. Genesis worked up from ancient documents, composed by various writers, living at various periods, either by Moses himself, or under his supervision, by some of the elders. The first redaction of the five books as a whole took place at the conquest of Canaan, through Joshua and the elders; the second and final redaction, however, in which the Pentateuch received its present shape, is to be dated from the time of Ezra, after the return from the exile.

The majority of continental modern critics, however, of a more moderate stamp—who repudiate the notion of their belonging to the advanced rationalistic school, hold opinions of a very different kind; and they have found professed partisans in England

of whom is Dr Davidson, we will make his own words (*Introduction to the Old Testament*): 'There is little external evidence of Mosaic authorship; and what little there does not stand the test of criticism. The succeeding writers of the Old Testament do not confirm the venerable authority of Christ himself has ever bearing on the question. The objections from internal structure are conclusive against the Mosaic authorship. Various contradictions are irreconcilable. The traces of a later date are everywhere. The narratives of the Pentateuch are generally trustworthy, though partly mythical and partly legendary. The miracles recorded are the creations of a later age. The voice of God without profanity, he said to have externally all the precepts attributed to him. Moses's was the foundation of the edifice of God's word, which has grown into the proportions in which we possess it; but he was not the first writer who has written parts of the national legends and history. He is emphatically a *lawgiver*, not a historian, a *spiritual actor* in the life-drama of the nation, who founded their theocratic constitution under the direct guidance of the Supreme.'

Additional words must be added respecting the use of the Pentateuch. According to Deut. xxxi. 24 the Law was preserved in the Ark of the Covenant. In the seventh year, it had to be read to the people; and probably the Schools of Prophets, which flourished at the time of Samuel, propagated its use. Moreover, certain priestly, sanitary, and domestic laws required constant reference to it, so that certain portions of it seem to have been in constant use at an early period. Every synagogue, according to the traditional Law, has a copy of the roll of the Torah, written on parchment, and certain strictly-insisted-upon regulations, which roll certain portions are read on Sabbaths and feast-days; and, according to the custom in Palestine, when Monday and Tuesday were the market-days—when the country-people came to town and the judges sat—also on Sabbaths. A smaller portion (*Parasha*) is read on Sabbaths on the afternoon service of the Sabbath. On the Sabbath morning service, when a *Levite* reads, or rather chanted, according to the custom, which is note and accent at the same time as the Samaritans have, of all biblical books, the Pentateuch, with slight variations (see SAMARITANS), their Book of Joshua being a very different work from ours; and certain very recent editions of their possessing also other adaptations of the Pentateuch, require confirmation. For the translations of the Pentateuch, ancient and modern, see VERSIONS. The first printed edition of the Pentateuch dates Bologna, 1482, fol. The commentators and writers on the whole of the Pentateuch, both in and out of the Church, is very numerous. We mention among the foremost, besides the Church Fathers (Augustine, Jerome, Ephraim, etc.) and the medieval Jewish commentators (Rashi, Kimchi, Aben Ezra), Calvin, Luther, Le Clerc, Spence, Michaelis, Eichhorn, Jahn, Keil, Hävernich, Bleek, Hengstenberg, Kurtz, Stähelin, Bertheau, Colenso, Graves, and others, &c.

**PENTECOST** (Gr. *pentecostē*, fiftieth) was the name given to the feast among the Jews, held on the fiftieth day after the passover, in celebration of the 'gathering,' and in thanksgiving for the giving of the Law. See FESTIVALS. From the Jewish use it was introduced into the Christian, and with special reference to the Pentecost, as being the day of the descent of the Holy Spirit on the apostles, and of the first solemn festival of the Christian religion. From early

times, pentecost has been regarded as one of the great festivals of the Christian year, and it was chosen as one of the times for the solemn administration of baptism; and the English name of the festival, *Whit-Sunday*, is derived from the *white robes* in which the newly-baptised were clad. It is regarded as specially sacred to the Third Person of the Blessed Trinity, to whose honour the services of the day are directly addressed. Many curious usages were anciently connected with the celebration. The dove, being held as an emblem of the Holy Ghost in some churches, a figure of a dove, suspended by a cord from the ceiling, was lowered so as to alight on the high altar during the service. In others, figures of cloven tongues, or red rose-leaves, were similarly introduced. The latter practice is said to be still retained at Messina, but in general these scenical representations have been discontinued. In some places, however, in the East as well as in the West, the practice prevails of decorating the churches with evergreens and flowers, as is done in England at Christmas. The whole time intervening between Easter and Pentecost is celebrated in the Roman Catholic church with special solemnity, and with some peculiar usages, and of this something is retained in the Church of England.

**PENTHOUSE**, a projection forming an open roof or shed, protecting a doorway, gate, window, &c.

**PENTLAND FIRTH**, a channel or strait between the Atlantic and German Oceans, separating the mainland of Scotland from the Orkney Islands. It is 17 miles long, and from 6 to 8 miles wide. About a mile west of Duncansbay Head is a ferry station, whence boats cross to Burwick, in the island of South Ronaldshay, a distance of 7 miles. The Pentland Skerries, 5 miles north-east of Duncansbay Head, consist of two islets, and of several contiguous rocks. On the larger of the islets is a light-house with two lights, one of which is 170, and the other 140 feet above sea-level. The latitude of the light-house is 58° 41' N., long. 2° 55' W. Off the coast of Caithness, and separated from it by a channel called the Inner Sound (about 2 miles in width), is the island of Stroma; and 3 miles north-north-east of Stroma is the islet of Swona, one of the Orkneys. On the north side of Stroma is the small vortex or whirlpool of Swalchie, and west of it are the breakers called the 'Men of Mey,' which are supposed to be produced by a current setting strongly on a concealed reef. The navigation of the P. F. is more dangerous than that of any other portion of the Scottish seas. A current setting from west to east flows through the Firth with a velocity of from 3 to 9 miles an hour, and causes numerous eddies and whirlpools. It is estimated that about 4000 vessels with cargoes pass through the Firth annually.

**PENTLAND HILLS**, in the Lowlands of Scotland, extend north-east from the border of Lanarkshire to the centre of the county of Edinburgh, and to within 4 miles of the city of that name. Mean height upwards of 1000 feet; highest summit, East Cairn, near the middle of the range, 1839 feet.

**PENUMBRA**. When the shadow of an opaque object is thrown upon a surface at some little distance by a light of considerable apparent size, it is observed that the shadow is divided into two portions, a dark portion in the centre, and a lighter portion surrounding it. The former is known as the *umbra*, or complete shadow; the latter as the *penumbra*, or partial shadow. A reference to the

figure will at once make plain their origin and relation, for if S be the illuminating body, E the object whose shadow is cast on the surface,

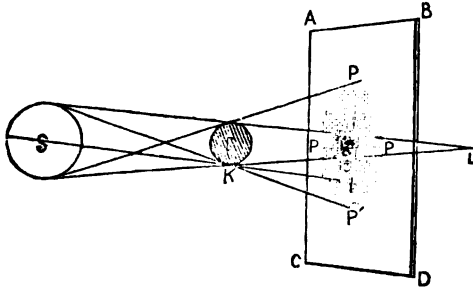

ABCD, it is seen that the small portion, *uu*, receives (omitting all consideration of refraction, dispersion, &c., of light) *no* light from S, while the whole surface outside of PPPP' is completely illuminated. The point P' receives light from the whole of S; the point F is only half illumined, and that by the lower part of S, the illumination of the points becoming less and less as they approach *u'*, which is unilluminated. The portion within *uu'* is the umbra, and that between the boundaries PPPP' and *uu'* is the penumbra, which, as we have seen, gradually shades from perfect light at the outer boundary to perfect darkness at the inner, so that it is almost impossible exactly to note its limits on either side. This phenomenon, it is evident, can only occur when the illuminating body is of such a size, real or apparent, as to make the angle, P'Ku', of sensible magnitude; and it is equally evident that the nearer the body E approaches the plane on which its shadow is cast, the larger is the umbra and the smaller the penumbra; while by increasing the distance between E and the plane, so that the point L shall fall between them, the umbra is made to vanish, and the penumbra is increased. This is well illustrated by natural phenomena: the shadow of a man cast by the sun on the ground presents almost no penumbra; the shadow of the earth thrown by the sun upon space at the distance of the moon gives a penumbra many times as large as the umbra; and sometimes, when the moon is new at her apogee, for instance, her shadow cast upon the earth exhibits no umbra. Spectators on the earth who see a partial eclipse of the sun, are situated within the penumbra, but within the umbra when they observe a total eclipse; while if the eclipse be annular, the umbra does not exist in the shadow cast by the moon on the earth's surface. See ECLIPSES.

**PENZA**, a central government of European Russia, between the government of Nijni-Novgorod on the north, and that of Tambov on the west. Area 14,670 square miles, pop. 1,161,575. The surface is in extensive and elevated plains, marked occasionally with ridges of low hills. The rivers are tributaries of the Don and Volga, and three of them, the Khofer, the Soura, and the Moksha, are navigable. The climate, though rather cold in winter, is temperate, agreeable, and healthy. The soil, consisting, for the most part, of black earth, is extremely fertile, and agriculture is the principal employment of the inhabitants. Grain of different kinds, leguminous plants, beet-root, flax, hemp, tobacco, and hops are the principal products. Much of the grain is used in the numerous distilleries, and considerable quantities of it are exported to the neighbouring governments. About one-third of the entire area is covered with forests, some of

which consist entirely of oak-trees. The manufactures are centred chiefly in the towns; cloth and leather are the principal articles made. The commercial improvement of the government is hindered by the want of direct means of communication with the consuming districts. The principal towns are Penza, Mokshansk, and Saransk.

**PENZA**, a town of European Russia, capital of the government of the same name, on the Southern coast, 220 miles south-south-east of Nijni-Novgorod. It was founded in the middle of the 17th c., as a defence against Tartar invasion, is a handsome town, occupying an elevation, and containing several churches, 2 convents, many gardens, & a large park with a beautiful fruit-garden and a horticultural school. It possesses 2 cloth-factories, 4 iron-works, several soap-boiling and candle-making establishments. The principal articles of commerce are corn and timber, which is floated down the Southern coast during spring. Pop. 22,280.

**PENZA'NOE**, a market and sea-port town, and municipal borough of England, in the county of Cornwall, stands on the north-west shore of Mount Bay, 22 miles west-south-west of Falmouth. It is the most westerly town in England—the light-house on its pier being in lat. 50° 7' N., and in lon. 5° 28' W. The town, standing on a finely-curved shore, surrounded by rocky eminences, and in a fertile district, is exceedingly picturesque in situation, and is famous for its mild, though somewhat moist climate. Its esplanade, one of the finest in the west of England, commands charming land and sea views. The chief buildings, most of which are constructed of granite, are the town-hall and corn-market, surmounted by a dome, and the chapels of St Paul and St Mary. There are numerous boarding-houses for the accommodation of the visitors attracted hither by the temperate and equal climate, by the beauty of the neighbouring scenery, and the curiosities of the district of Land's End. Woollen yarns and cloths are manufactured; the fishery employs upwards of 2000 persons; agricultural produce, pitchards, and tin and copper ores produced from the mines of the vicinity are exported; and timber, iron, hemp, and hides are the chief imports. The harbour is accessible to vessels of considerable burden, and is furnished with a pier 800 feet in length. In 1863, 3732 vessels of 360,511 tons entered and cleared the port. P. (1861) of municipal borough, 9414.

P. was laid in ashes by a party of marauding Spaniards in 1595, and was sacked by Fairfax in 1646.

**PE'ON**. See CALOPHYLLUM.

**PEO'RIA**, a city and port of entry in Illinois, U.S., on the west bank of the Illinois River, which is crossed by two bridges of 2500 feet, at the outlet of Peoria Lake, 70 miles north of Springfield, and 160 miles south-west of Chicago. It is connected by steamboat navigation with the Ohio and Mississippi, by canal with Lake Michigan, and is an important station on the great network of western railways. Bluffs of bituminous coal, opening up the river banks, supply numerous manufacturing establishments. There are 24 churches, and numerous schools and public institutions. Pop. (1860) 14,425.

**PEPÉ**. Three Neapolitans of this name have played an important part in history. The first of these was GABRIELE PEPE, who was born in 1781 at Bojano, in the present province of Campobasso, Italy, and was a student of law in 1797, when, on the proclamation of the Parthenopean Republic, he took service in the Franco-Neapolitan army, and was consequently exiled on the fall

PEPERINO—PEPIN.

government. Subsequently he served in a legion in the French army under King Louis XVIII. In 1815, he was raised by the latter to the rank of colonel, a grade confirmed by Ferdinand I. He gave him the command of a province, and was deputed to the garrison of Syracuse. He espoused with great zeal the cause of the revolutionary party and was deputed to the national parliament. On the downfall of the constitutional government, he was seized by the Austrians, and imprisoned at Olomouc in Moravia; but was released at the end of 1813, and retired to Tuscany; where, feeling some remarks of M. de Lamartine, then minister of affairs in that country, on Italian patriots, he in turn wielded the pen in defence of his countrymen with such severity that a duel resulted between him and the poet, followed by an apology on the latter's part. From this time he took no part in public affairs, but devoted himself to science and literature, and died at Bojano, August 1849.—His son, GIUGLIAMO PEPE, born in 1782 at Squillace, was a man of equal note. After serving in the army of Catalonia, and attaining to high rank and honour, he returned to Naples to support the king, and after the flight of that chief, was one of the leaders of the 'Muratist' party, yet, after the restoration, the Bourbon Ferdinand allowed him to retain his honours. P. rendered valuable service in routing out (1818) the nests of brigands who infested the provinces of Avellino and Foggia, and in the insurrection of 1820, was for some time the most influential man in Naples; but, on his defeat by the Austrians at Rieti, 7th August 1821, he was forced to flee the country, and took refuge in Spain, whence he retired to Madrid, where he lived many years, afterwards returning to Paris. In 1848, on the proclamation of the republic, he returned to Naples, welcomed with enthusiasm by the people and the court; and, constrained by the public voice, gave him the command of the Neapolitan contingent which he sent to aid the Lombards against Austria; and for the suppression of revolution in Naples (1849), P. was ordered to return and put down the insurgents of Calabria. Disregarding these orders, P., with as many of the Neapolitans as adhered to him (2000 men), devoted himself to the defence of Venice, of whose army he had been elected commander-in-chief. His prudent courage, joined to an untiring energy, enabled him greatly to retard the operations of the Austrians; but the force under his command was not equal to effecting anything of importance. His most remarkable exploit was the sortie he effected in person (October 1849) from the citadel of Padua. After the fall of Venice, P. fled to France on board a French ship, and subsequently returned to Paris. He had, however, an antipathy to the republic, and speedily removed to Turin, where he died August 1855. He has left several works, some of which are, *Relation des Evénements Militaires de Naples en 1820 et 1821* (1822, in Italian and French), and *Histoire des Evénements et des Guerres d'Italie en 1847, 1848, et 1849* (Paris, 1850). A statue of him has been erected in Turin.—His elder brother, FLORESTANO (born 1780, died 1851), was also a Muratist, but devoted to Ferdinand. He was a mild and conservative, but feeble liberal.

PEPERINO, an Italian term, applied by some geologists to the brown volcanic tuff derived from the rocks, to distinguish them from the ordinary trachyte, which name they confine to the lighter-pumiceous rocks that have more trachyte composition.

PEPIN, the name of several distinguished members of the Carolingian family; the first of whom in order was PEPIŒ LE VIEUX or PEPIŒ DE LANDEN, the founder of the family. He was of a Brabant family, and took his designation from Landen (now in Liege, Belgium). Rebelling with others of the great lords of Austrasia against the rule of Brunehaut, who was regent for the youthful king, he offered the crown to Clotaire II., king of Neustria, who, in reward of his services, created P. *maire du palais* of Austrasia, an office which he continued to hold during the two following reigns, and died in 639. His administration was directed to the preservation of the power and integrity of the Austrasian kingdom, and though, by opposing the various schemes of centralisation proposed by the king, he fell under the royal displeasure, his conduct gained for him favour and influence with the Austrasian chiefs; his power and wealth were greatly increased, and a broad and firm path to political supremacy laid for his descendants. His son, Grimoald, who succeeded him as *maire du palais*, incautiously attempted to gather the fruits of his father's schemes before they were quite ripe, and accordingly suffered for his folly. Both he and his son Childeburt were strangled in prison (656) by order of Clovis II. Pepin 'the Old' left by his daughter a grandson, PEPIŒ LE GROS or PEPIŒ D'HERISTAL, who was elected by the Austrasian nobility as their chief, to protect Austrasia against the machinations of Elroin, the able *maire* of Neustria. His first step was to rid himself of the Merovingian king, who nominally ruled over Austrasia; which was effected by obtaining the condemnation of the unfortunate monarch, Dagobert II., by a council of bishops, and then putting him to death. From this time the Merovingian rule in Austrasia ceased. P. was now sole ruler, but his ambition did not stop here; he had resolved on the ruin of the Merovingian monarchs, and accordingly levied a large army for the invasion of Neustria. Elroin, on his side, was equally resolved to humble the territorial aristocracy, and support the throne; and advancing into Austrasia, his army came in sight of P.'s at Loix. In the battle (680) which ensued, P.'s army was totally defeated, his brother and co-ruler, Martin, was taken prisoner and put to death, and he himself narrowly escaped. Luckily for him, however, Elroin was soon afterwards assassinated, and his successor, Warato, signed a treaty of peace. The incapacity and tyranny of Warato and his successor, Berthaire, discontented the Neustrian nobles, who went over to P., and by this accession of power enabled him to resume the offensive. Neustria was immediately invaded, and a bloody but decisive battle at Testry (687) freed P. of his opponent Berthaire, who was left dead on the field, and placed Neustria at his feet. Full of moderation in the midst of triumph, and satisfied that he could not place on the throne a more obedient slave than Thierry III., the then king of Neustria, P. caused him to be also proclaimed king of Austrasia, but reserved for himself the sovereign power, wielding the sceptre though declining the crown. From this time he ruled the whole of France (Austrasia in his own right by his election as Duke, and Neustria as *maire du palais*) with energy, and undisturbed by any internal commotion, during the lives of three other 'faincant' kings, till his death in 714. He had made several campaigns (689—708) against the Frisians, but that valiant and independent race was not thoroughly subdued for some time afterwards. P. had two legitimate sons who died before him, and an illegitimate son, Charles, subsequently known as Charles Martel (q. v.), who succeeded to his power.—The third who bore this name was PEPIŒ LE BREF, the

younger son of Charles Martel, who, on the death of his father in 741, received Neustria and Burgundy; Austrasia, Thuringia, and Suabia being the heritage of his elder brother Carloman. Aquitaine was nominally a part of P.'s dominions, though, as it was really independent under its own duke, he made several attempts to subdue it; but the duke was quite able to hold his own against both P. on the one hand and the Arabs (from Spain) on the other. The farce of governing the country in the name and as the chief minister of the Merovingian sovereign was still kept up, though P. was eagerly longing for an opportunity to assume the crown; but the present time was inopportune, as no sooner was the restraint of Charles Martel's iron hand removed by death, than revolts broke out in all quarters among the Franks, Germans, Bavarians, and Gascons. The country, by the united exertions of P. and Carloman, was restored to tranquillity about 745. Those princes who had excited the insurrection were mostly deposed, and otherwise punished, and the Duke of Aquitaine was compelled to acknowledge at least the nominal sovereignty of Pepin. In 747, Carloman bade adieu to power, and retired into a convent, leaving his government to his sons, who were immediately dispossessed by Pepin. After crushing a rebellion of Saxons and Bavarians, P. began to carry out his favourite project of dispossessing the Merovingian dynasty of even the semblance of authority, and of originating in person a new royal dynasty. To gain his point he flattered the clergy, then the most influential body in France; and as they had been despoiled by Charles Martel for the behoof of his warriors, a moderate degree of kindness and generosity on the part of P. contrasted him so favourably with his father, that the clergy at once became his partisans. So did the pope, who felt the importance of securing the aid of the powerful Frankish chief against the Lombards, who were then masters of Italy, and released the Franks from their oath of fidelity to Childeric, the Merovingian monarch. On learning this, P. at once caused himself to be elected king by the assembly of estates at Soissons, and was consecrated by the Bishop of Mayence (March 752). Childeric retired to a convent, where he died in 755. P. was the first Frankish monarch whose election received the sanction of the pope, and who was consecrated to his high dignity; and these solemn ceremonies put the crown to a great extent at the mercy of the clergy, who from this time took a political rank in the state. The practice, too, followed by P. and his predecessors in office, of gaining partisans by granting particular fiefs to various chiefs, greatly strengthened the feudal system, and proportionally weakened the royal power. This effect, however, did not shew itself till after the subsequent reign of Charlemagne, on account of the personal genius of these two rulers. P. was soon called upon to aid the pope against the Lombards, and marching into Italy at the head of a large army, he compelled Astulf, the Lombard king, to retire from the siege of Rome, and restore several cities which had previously belonged to the Greeks; these were now handed over to the pope. He had hardly returned to France, when he was anew summoned (755) to Italy, the Lombards having broken their engagements. This time he took Ravenna, Emilia, the Pentapolis, and the duchy of Rome from the Lombards, reuniting them to the Holy See. After the settlement of affairs in Italy, the turbulent nations on his eastern frontier demanded his attention. The Saxons and other German tribes were defeated (757), their country cruelly ravaged, a heavy tribute exacted, and numbers of captives and hostages taken. Resolved to unite the whole of Gaul under his authority, he

eagerly accepted the invitation of the Visigoths of Septimania to aid them against the Arabs, who had taken possession of the country; and a war of many years' duration, Narbonne, the chief Arab stronghold, was taken, and the country freed of these invaders, at once acknowledged P.'s authority. The remaining years of his reign were occupied in reducing the independent monarchs of Aquitaine, which was not accomplished till the ninth year (760—768) of desolating war, when he obtained the assassination of his opponent, Waifre, whose partisans then laid down their arms, surrendering to the Frankish monarch the provinces which stretch from the Loire to the Pyrenees. Shortly after this conquest P. died of dropsy, September 768. He was an active, enterprising, and in general fortunate monarch; he established the unity of the Gallic nation, protected it as far as could be done by arms, and ravaging the territories of the neighbouring nations, though he also introduced those elements of weakness into its constitution which reduced the authority of his successors to such a deplorable state. The others of this name, though in some personages at the time, make little figure in history.

**PEPPER** (*Piper*), a genus of plants of the order *Piperaceæ* (q. v.), which once included the whole of that order; but, as now limited, consists of plants with woody stems, solitary spikes of flowers on the leaves, and covered with flowers on the leaf axils; the flowers mostly hermaphrodite. The most important species is COMMON P. or BLACK PEPPER (*Piper nigrum*), a native of the East Indies, now cultivated also in many tropical countries, and extensively in some parts of the New World; its fruit is the most common and largely used of all spices. It is a rambling and climbing shrub, with smooth, spongy stems, sometimes twelve feet in length, the leaves broadly ovate, acuminate, leathery, and the fruit is about the size of a pea, of a bright red colour when ripe, not crowded on the stem. In cultivation, the P. plant is supported by a trellis of small trees planted for the purpose, as it requires a certain degree of shade, and different kinds of trees are often planted for this purpose in India. The P. propagated by cuttings, comes into bearing in one or four years after it is planted, and yields crops annually for about twelve years. When the fruit of the 'berries' of a spike begin to change from green to red, all are gathered, as when more ripe they are less pungent, besides being more liable to drop off. They are spread on mats and so dried from the spikes by rubbing with the hands, and treading with the feet, after which they are winnowed. The *Black P.* of commerce is made of the berries thus dried, and become wrinkled and black; *White P.* is the seed freed from the fleshy part of the fruit, to effect which the fruit is soaked in water and then rubbed. *White P.* thus prepared is of a whitish-gray colour, and unfrequently undergoes a bleaching by which improves its appearance at the expense of its quality. *Black P.* is much more pungent than *White P.*, the essential constituents of the former being more abundant in the outer parts of the fruit than in the seed. P. depends for its pungency chiefly on an acrid resin and an acrid volatile oil; it contains also a crystalline substance called *Piperin*.—The fruit of *Piper tricoicum*, a very similar to the Common P., is more pungent, and it is cultivated in some parts of India. Other species of *Piperaceæ* which are called pepper in their native countries; that of *Bryonia* *Cupense* at the Cape of Good Hope; that of *Pellobryon longifolium*, of *Artanthe* *crucifera*, *A. trichostachya*, and of *Serronia jaborandi* in

PEPPERMINT—PERAMBULATION OF PARISHES.

—*Chavica Roxburghii* and *C. officinarum* LONG PEPPER of druggists. They have climbing stems, solitary spikes opposite to a, dioecious flowers, and the fruits so close on the spikes as in ripening to become a mass. The spikes are gathered when and dried in the sun. They are used in same purposes as Common Pepper. They are usually reputed to be more pungent than Pepper. *C. Roxburghii* is cultivated in and the Circars, where it is called *Pippul*; *urum* in the Dutch East Indian colonies. and thickest part of the stem of *C. Rox-* are extensively used in India as a stimulant; and are cut into small pieces, dried, and to the market under the name of *pippula*

on the skin as a rubefacient and vesicant, often used for this purpose in a powdered ointment with some kind of alcoholic spirit. It is employed as a local stimulant in relaxation of the uvula, and is applied in the form of an ointment to ringworm. Taken into the stomach in small quantities it is a pleasant stimulant, but in large quantities it produces great pain and irritation. It is used, however, by the natives of hot countries, and much exceeds anything known among Europeans, and the effects are evidently beneficial and not injurious. The chief use of P. is as a condiment.

It is known to the ancients; Hippocrates mentions it as a medicine; and Pliny expresses his opinion that it should have come into general use, owing to its want of flavour. In the middle ages it was one of the most costly spices, and in the 16th century few pounds of it were reckoned a princely gift.

The quantity now imported into Europe is small; but there are no means of exactly ascertaining how much of the P. of commerce is the produce of *Piper nigrum*, or indeed of the *Piperaceae*, or how much—although certainly it is not a large part of the whole—is the produce of species other than *nigrum*.

The name P. is popularly given to substances which possess a pungency resembling that of P., but which are produced by very different plants. Thus, the name P. is the produce of species of *Capsicum*, of the natural order *Solanaceae*; JAMAICA P. (or ALLSPICE) is a species of *Eugenia*, of the natural order *Myrtaceae*; and GUINEA P., or MELLEQUETTA PEPPER, is a species of the natural order *Scitamineae* and not of the *Piperaceae*. See CAPSICUM, PIMENTO, GRAINS OF PEPPER, and GUINEA PEPPER.

PEPPERMINT. See MINT.

PEPPER-POT, a celebrated West Indian dish, the principal ingredient of which is the Casareep (q. v.) is a principal ingredient; it is made with it flesh or dried fish, vegetables, and the unripe pods of the ochro (see HIBISCUS), and is served with rice (see CAPSICUM).

PEPPER-ROOT (*Dentaria diphylla*), a perennial herbaceous plant, of the natural order *Cruciferae*, a native of North America, with pairs of ternate leaves and racemes of white flowers; the root of it has a pungent mustard-like taste, and is used as a stimulant.

PEPPER has been already described (in the article on DIGESTION) as one of the essential constituents of the gastric juice. Various modes of extracting it from the walls of the stomach of the calf, sheep, and goat have been proposed by different chemists (see GAY-LUSSAC, Frerichs, Schmidt, Boudault, and others), but it is unnecessary to enter. According to Gay-Lussac's analysis, it contains 53.0 per cent. of carbon, 7.7 of hydrogen, 17.8 of nitrogen, and 22.5

of oxygen, and hence in its ultimate composition it is closely allied to albumen. This substance, either as a powder or in solution, has been employed of late years to a considerable extent in medical practice, in cases of disordered digestion from deficient or imperfect secretion of gastric juice, and of convalescence from typhoid and other debilitating fevers. Pepsine wine is perhaps the best form in which to prescribe this substance; a teaspoonful being the ordinary dose. The fact that pepsine has not been thought deserving of a place in the British pharmacopoeia, seems to indicate that its efficiency as a remedy is not generally recognised in this country.

PEPYS, SAMUEL, a distinguished officer of the Admiralty during the reigns of Charles II. and James II., was born February 23, 1632—1633. He was the son of a London citizen, a tailor, but was well educated, first at St Paul's School, and afterwards at Magdalen College, Cambridge. His cousin, Sir Edward Montagu (the first Earl of Sandwich), introduced him to public employment. In 1660 he was appointed Clerk of the Acts of the Navy, and in 1673 Secretary for the Affairs of the Navy. He was an excellent public servant, acute, diligent, and laborious; but during the fanatical excitement of the Popish Plot he was committed to the Tower, on an unfounded and absurd charge of aiding in the design to dethrone the king and extirpate the Protestant religion. Having been discharged without a trial, P. was replaced at his post in the Admiralty, which he retained till the abdication of James II. For two years he held the honourable station of President of the Royal Society. He died May 26, 1703. P. wrote *Memoirs of the Royal Navy*, 1690. He left to Magdalen College his large collection of books, MSS., and prints, including about 2000 ancient English ballads, forming five folio volumes. This curious collection was begun, he says, by Selden, and continued down to the year 1700, when the form peculiar to the old ballads, namely, the black letter with pictures, was laid aside for the simpler modern fashion. P. is now best remembered for his *Diary*, deciphered by the Rev. J. Smith from the original shorthand MS. in the Pepysian Library, Cambridge, and first published, under the editorial care of Lord Braybrooke, in 1825. It commences on the 1st of January 1659—1660, and is continued for above nine years, when the diarist was obliged from defective eyesight to abandon his daily task. As a picture of the court and times of Charles II. this *Diary* is invaluable; it was written in perfect confidence and secrecy; the events, characters, follies, vices, and peculiarities of the age are presented in true and lively colours, and the work altogether is one of the most racy, unique, and amusing books in the language.

PE'RA, a suburb of CONSTANTINOPLE (q. v.).

PERAMBULATION OF PARISHES. The ancient custom in England of perambulating parishes in Rogation week had a twofold object. It was designed to supplicate the Divine blessing on the fruits of the earth; and to preserve in all classes of the community a correct knowledge of, and due respect for, the bounds of parochial and individual property. It appears to have been derived from a still older custom among the ancient Romans, called Terminalia, and Ambarvalia, which were festivals in honour of the god Terminus and the goddess Ceres. On its becoming a Christian custom the heathen rites and ceremonies were of course discarded, and those of Christianity substituted. It was appointed to be observed on one of the Rogation (q. v.) days, which were the three days next before Ascension Day.

Before the Reformation parochial perambulations were conducted with great ceremony. The lord of the manor, with a large banner, priests in surplices and with crosses, and other persons with hand-bells, banners and staves, followed by most of the parishioners, walked in procession round the parish, stopping at crosses, forming crosses on the ground, 'saying or singing gospels to the corn,' and allowing 'drinkings and good cheer' (Grindal's *Remains*, pp. 141, 241, and *Note*; Whitgift's Works, iii. 266—267; Tindal's Works, iii. 62, 234, Parker Society's Edition), which was remarkable, as the Rogation days were appointed fasts. From the different practices observed on the occasion the custom received the various names of *processioning*, *rogationing*, *perambulating*, and *ganjnyng the boundaries*; and the week in which it was observed was called *Rogation week*; *Cross week*, because crosses were borne in the processions; and *Grass week*, because the Rogation days being fasts, vegetables formed the chief portion of diet.

At the Reformation, the ceremonies and practices deemed objectionable were abolished, and only 'the useful and harmless part of the custom retained.' Yet its observance was considered so desirable, that a homily was prepared for the occasion; and injunctions were issued requiring that for 'the perambulation of the circuits of parishes, the people should once in the year, at the time accustomed, with the rector, vicar, or curate, and the substantial men of the parish, walk about the parishes, as they were accustomed, and at their return to the church make their common prayer. And the curate, in their said common perambulations, was at certain convenient places to admonish the people to give thanks to God (while beholding of his benefits), and for the increase and abundance of his fruits upon the face of the earth, with the saying of the 103rd Psalm. At which time also the said minister was required to inculcate these, or such like sentences, Cursed be he which translateth the bounds and doles of his neighbour; or such other order of prayers as should be lawfully appointed.' (Burn's *Ecclesiastical Law*, vol. iii. 61; Grindal's *Remains*, p. 168.)

Those engaged in the processions usually had refreshments provided for them at certain parts of the parish, which, from the extent of the circuit of some parishes, was necessary; yet the cost of such refreshment was not to be defrayed by the parish, nor could such refreshment be claimed as a custom from any particular house or family. But small annuities were often bequeathed to provide such refreshments. In the parish of Edgcott, Buckinghamshire, there was about an acre of land, let at £3 a year, called 'Gang Monday Land,' which was left to the parish-officers to provide cakes and beer for those who took part in the annual perambulation of the parish.

To this day, questions of disputed boundary between parishes are invariably settled by the evidence afforded by these perambulations; for in such questions, immemorial custom is conclusive. And so far are they recognised in law, that the parishioners on such occasions are entitled to trespass on lands, and even to enter private houses if these stand on the boundary line. In Scotland, where the parochial principle has never been developed as in England, there seem to be few traces of a similar practice. But, as between neighbouring landowners, a brief of perambulation is the technical remedy for setting right a dispute as to boundaries or marches; and perambulating or 'riding' the bounds of boroughs is a common practice.

The necessity or determination to perambulate along the old track often occasioned curious

incidents. If a canal had been cut through the boundary of a parish, it was deemed necessary that some of the parishioners should pass through the water. Where a river formed part of the boundary line, the procession either passed along it, or some of the party stripped and swam across. Boys were thrown into it at customary places. A house had been erected on the boundary line, the procession claimed the right to pass through it. A house in Buckinghamshire, still existing, was often passing over the boundary line. It was customary in the perambulations to put a boy into the recess to preserve the integrity of the boundary line.

At various parts of the parish boundaries were marked. Three of the village boys were 'bumped' over a certain part of the person was swung over a stone wall, a tree, a post, or any other high object, which happened to be near the parish boundary. This, it will scarcely be doubted, was an ancient method of recording the boundaries in the case of these *battering-rams*, and of those who were thus the subject of this curious mode of registration.

The custom of perambulating parishes was not universal in some parts of the kingdom to a late period. The religious portion of it was general, but the secular, universally, omitted. The custom has, however, in late years been revived in its integrity in many parishes.

**PERCEPTION.** This word refers to the acquisition of knowledge through the senses, and is that to the common understanding seen and felt. It is not, however, enough, but, viewed philosophically, is a process with much difficulty. Perception, considered as a source of knowledge, refers exclusively to the external or the object world—the world of extended matter and its properties. The names for the act of acting upon one's own mind—the feelings and thoughts of the individual—are Self-consciousness and introspection. The word 'consciousness,' however, is sometimes improperly limited to this significance, and the term 'Reflection' for the same, but this is ambiguous, and is now disused. Perception of knowledge is thus said (by those that do not) to spring from two sources—Perception and Self-consciousness.

Two great disputes connect themselves with Perception, both raised into their full prominence by the philosophical world by Bishop Berkeley. The first is the origin of our judgments of truth and falsehood, and real Magnitudes of visible bodies. In opposition to the common opinion on this subject, Berkeley maintained that these were learned from experience, and not known by the mere act of vision. See VISION.

The second question relates to the ground we have for asserting the existence of an external material world, which, in the view of Berkeley, is bound up with the other. Inasmuch as perception is a mental act, and knowledge is sometimes said to be contained in a mind, what reason have we for asserting the existence of objects apart from our perception, or what is the mode of existence of the external world?

The following sentences shew in what manner Berkeley opened up the question: 'The objects of our thoughts, nor passions, nor ideas, formed by the imagination, exist without the mind, in which they only body will allow; and it seems no less evident that the various sensations or ideas imprinted on the mind, sense, however blended or combined together, (whatever objects they compose), cannot exist in any other way than in a mind perceiving them. Intuitive knowledge may be obtained of the existence of one that shall attend to what is meant by the term *exist* when applied to sensible things. This

on, I say, exists—i. e., I see and feel it; and ere out of my study, I should say it existed, and thereby that if I was in my study I might not see it, or that some other spirit actually does perceive it. There was an odour—i. e., it was odoured; there was a sound—that is to say, it was heard; a colour or figure, and it was perceived by sight or touch. This is all I can understand by such and the like expressions. For as to what is meant by the absolute existence of unthinking things, and any relation to their being perceived, that is perfectly unintelligible. Their *esse* is *percipi*, and it is possible they should have any existence in the minds or thinking things which perceive

the doctrine of Berkeley, amounting, it was shown to be a denial of the existence of a material world (as far from a correct view of it), was followed by Hume, who, on similar reasoning, denied the existence of mind, and resolved the universe into a mere flow of ideas and impressions without any substratum to be impressed, acknowledging, nevertheless, that he felt himself unable, practically, to object to his own unanswerable arguments. He was obviously some great mistake in a mode of reasoning that brought about a dead-lock of this kind; and hence it has been the work of modern physical philosophy since that time to endeavour to show that the perception of the world on an admissible

ground. Reid reclaimed against Berkeley and Hume, appealing to Common Sense, or Unreasoning Nature, as a sufficient foundation for our belief in the existence of a world apart from our own minds. Dr. Hamilton has expounded the same view with greater clearness and precision. He considers our consciousness tells us at once that in the act of perceiving there is both a *perceiving subject*—the mind—and an *external reality*, in relation to the sense, as the *object perceived*. 'Of the existence of both these things,' he says, 'I am convinced; because I am conscious of knowing each of them, immediately in something else, as represented, but not immediately in itself, as existing. Of their mutual dependence I am no less convinced; because each is apprehended equally and at once, in the same sensible energy, the one not preceding or determining the other not following or determined; and because each is apprehended out of, and in direct contrast to the other.'—*Reid*, p. 747.

Such as Hamilton has laboured to elucidate this doctrine in all its bearings, it has not been universally accepted as satisfactory. Many believe that it should be regarded as an ultimate fact of our constitution, which admits of being still further resolved, but is mistaken in an acquisition of the mature mind to primitive or instinctive revelation.

Professor Ferrier, in his *Institutes of Metaphysics*, enters more thoroughly into the question with extraordinary clearness and elaboration. His main position is the inseparability of the subject and the object in the act of perception (a position also maintained by Hamilton in the above extract), which is not reconcilable with the common assumption as to the independent existence of matter. Indeed, he reduces the received doctrine of the existence of matter *per se* to a self-contradiction, and builds up a system in strict conformity with the correlation, or necessary connection, of the mind perceiving with the object perceived. Thus he approaches nearer to Berkeley than to Reid.

Those who would endeavour to shew that our perception of the outer world is a complex fact, and an act of construction, and not a simple apprehension of the pre-constituted mind, explain themselves to the following effect. It is in the exercise of force that we

have to look for the peculiar feeling of the externality of sensible things, or the distinction that we make between what impresses from without, and impressions not recognised as outward. Any impression that rouses a stroke of energy within us, and that varies exactly and constantly as that energy varies, we call an outward impression. Dr Johnson refuted Berkeley, as he thought, by kicking a stone. But in fact it was his own action with its consequences, and not the optical impression of a stone in the eye, that satisfied him as to the existence of something outward. The sum-total of all the occasions for putting forth active energy, or for conceiving this as possible to be put forth, is our external world.

We experience certain uniformly recurring sensations, and certain uniform changes in these, when we exert particular energies. Thus the visible picture of our dwelling is a permanent and habitual experience, and the variations of appearance that it is subject to correspond principally to our own conscious movements. As we move from one end of a room to another, we experience a change of the visible aspect at every step, and this regularly happens as often as we repeat the movement. But at times the appearance exists in another shape, to which we give the name of memory or *idea*. We draw a marked distinction between these two modes of presentation, the actual and the ideal, and we assign a superiority to the one over the other. The superiority we find connects itself with the relation to our own movements; a mere idea or mental picture remains the same whatever be our bodily position or bodily exertions; the sensation that we call the *actual* is entirely at the mercy of our movements, shifting in every possible way (but uniformly) according to the varieties of action that we go through. With a forward movement the visible impression enlarges, with a backward movement it diminishes. A certain movement of the eye shuts it out, another restores it. The raising of the head and the bending of the body are followed by an altered spectacle. We cannot but draw a broad distinction between the mental scenery that is thus shifted by all our movements, and the ideas and dreams that vary of themselves while we are still. To express the one fact, we use the terms externality, the material world, independent existence; to express the other we employ the opposite language, internality, the world of mind, &c. Even if sensation were only in ourselves, we should still have to distinguish between present sensation and remembered or revived sensation; the reference of the one to our voluntary movements, and of the other to no such modifying causes, would oblige us to note a vital difference in the two classes of facts. Such is the uniformity of connection between certain appearances and certain movements, that we come to anticipate the one through the other. We know that in some one position, as when lying in bed, certain movements of the limbs and back will bring us to the sensation of a solid contact in the feet; that another series of movements will bring on a particular view to the sight; that a third movement will give the sound of a bell in the ear, and so forth. We cannot avoid regarding those various sensible effects, brought uniformly into play by a regular series of waking voluntary actions, as totally different from our ideas, recollections, and dreams.

As our belief in the externality of the causes of our sensations means that certain actions of ours will bring the sensations into play, or modify them in a known manner, this belief is readily furnished by experience, and is no more than our experience entitles us to entertain. When we have been



repeatedly conscious that a tree becomes larger and larger to the eye in connection with a definite locomotion on our part, called the forward advance; that this movement brings on at last a sensation of touch; that this sensation of touch varies with definite movements of the arms, and so on; the repetition of all this train of experience fixes it on the mind, so that from one thing alone, as from the distant vision of the tree, we can anticipate, or as it is otherwise called, *perceive* all the other consequences. We then know, without going through the steps, that the specified movements will bring about all the sensations above described, and we know nothing else; this knowledge, however, is to us the recognition of external existence, the actual fact that is meant when a material world is spoken of. Belief in external reality is the sure anticipation of certain sensations on the performance of certain movements; everything else said to be implied in it is but a convenient hypothesis for aiding the mind in holding together those multifarious connections that our experience has established in the mind. In order to account for the fact that the conscious movement of elevating the upper eyelid is followed with the sensation of light, to us and to other minds, we suppose a luminous agency always existing even when not affecting us or any other person; we cannot know or verify this supposition—it is a generalisation founded upon particular experiences, and serving to sum up those experiences in a convenient form, but no such perennial independent substance can be absolutely proved.

PERCEVAL, SPENCER, RIGHT HON., English minister, was the second son of John, Earl of Egmont; born November 1, 1762; educated at Harrow, and at Trinity College, Cambridge. He was called to the bar, and soon obtained a reputation as a diligent lawyer. A clever pamphlet on the abatement of the impeachment of Warren Hastings, made him known to Pitt. Obtaining a seat in parliament for Northampton, he was soon conspicuous for his extreme horror of popery, and his violent advocacy of what was called by his party the 'Protestant interest.' In the Addington administration, he was made Solicitor-general in 1801, and Attorney-general in 1802. He was afterwards induced to abandon his profession, and adopt a political career. In the Portland administration of 1807, he was made Chancellor of the Exchequer, and was even then the real head of the government, his influence with George III. being obtained by the depth of his bigotry and his pertinacious opposition to the Catholic claims. On the death of the Duke of Portland in 1809, P. became Premier, uniting to his office of Chancellor of the Exchequer that of First Lord of the Treasury. He was retained in power by the Prince of Wales on his accession to the regency. On the 11th May 1812, about 5 P.M., as P. was entering the lobby of the House of Commons, a man named Bellingham fired a pistol at him, the ball pierced his heart, and he instantly expired. The assassin made no attempt to escape. He was a Liverpool broker, trading with Russia, who, having sustained some losses and injuries, which he had vainly applied to the government to redress, determined to avenge himself by taking the life of the prime minister. P.'s assassination shocked the public mind, and parliament hastened to make an ample provision for his widow and numerous family. His death was, however, rather a private than a public calamity. 'With all my respect for the virtues and excellences of the late minister,' said the Marquis of Wellesley, who had held the office of Foreign Secretary in his administration, 'I still feel it my duty to say that I did not consider him a

fit man to lead the councils of this great country. He was ready in debate, a placid and not a full speaker, and led the House of Commons with much tact; but he was superficial and imprudent. Sydney Smith, in his *Letters of Peter Plym*, conferred a species of immortality upon his wit and sarcasm. It was the fashion, with the public policy was attacked, to laud his virtues. 'Peter' said, if he had to choose between public and private virtues, he should prefer the private. P. 'owed for the zeal of the preceding year, his boys, and saved his country.'

PERCH (*Perca*), a genus of acanthopteron of the family *Percidae*, to which it gives its name, and which includes many genera and a very large number of species both of marine and fresh-water fishes. The *Percidae*, or P. family, have the body somewhat oblong and more or less compressed; scales rather large; the bones of the gills toothed or otherwise armed; the mouth with barbels; the *vomer* toothed, and generally with a sharp *palate*; there are sometimes two dorsals, so called, only one. To this family belong not only the perches, all of which are fresh-water fishes, but also the Lates (q. v.) of the Nile, the Basse (q. v.) of the Nile, and their congeners the Pike Perches, the *Serrani*, and many other fishes. The perches (*Perca*) have two dorsal fins, disti-



Perch (*Perca fluviatilis*).

separate, the rays of the first spinous and the second flexible; the tongue is smooth; the gill-covers are bony, notched, and sharply serrated. The COMMON P. (*P. fluviatilis*) is an inhabitant of the lakes, ponds, and still rivers of almost all parts of Europe. It is very common in England, Ireland, and is found in many of the water-courses of the south of Scotland, although in the north it is said to exist only where it has been introduced. But it is found in Scandinavia, and in Lapland. It is of a greenish-brown colour, passing into golden yellow on the under parts, and marked with six or seven indistinct blackish bands. Its height is about one-third of its length. It often attains a length of 16 or 18 inches, and a weight of 2 or 3 pounds, but perches have been taken of 8 pounds weight or more. The perch is found in still waters, and is easily reared in ponds, but is not a desirable inmate of ponds intended for the supply of fish, because it is very voracious, and devours its own fry. It is readily caught by almost any bait, and sometimes takes a small artificial fly. It is much esteemed for the table. It lives a long time out of the water if kept moist, and in some cases is thus brought to market, and carried to distant parts of the pond if not sold. The female P. deposits her eggs in long strings, united by a viscid matter. A species of P. (*P. Italica*), found in the south of Europe, differs from the Common P. in its more slender and deeper form, and want of black bands. The species are natives of the rivers and lakes of

ca, and are among the most esteemed of its water fishes.

CH. See POLE.

CLOSE, a railing or other enclosure separating tomb or chapel from the rest of a church.

CLOSE, or DEMI-GARTER, in Heraldry, the lower half of a garter with the buckle.

PERCOLATION, a process much used in Pharmacy, and in some other arts, for extracting certain soluble properties of various bodies by filtering a liquid through them. In the new British pharmacopœia, 39 tinctures and 9 extracts are ordered to be prepared by

ion. As the fluid soaks in and passes through the material acted upon, it displaces with it the soluble parts, hence percolation is sometimes called the *Method of Distillation*. The forms of apparatus for percolation are numerous, but the principle is the same, viz. a vessel with a porous bottom, and in the form of a truncated cone inverted, receives the liquid first, and over it is poured the water or fluid which is to extract its virtues. One of the eminent French pharmaciens, M. Bejot, has an effective and complete. A is a long funneled glass, with a glass stop-cock (b) in the

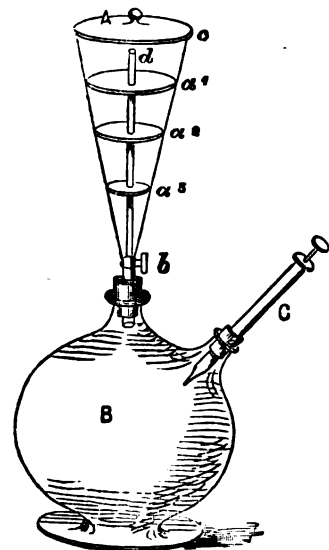

Percolator.

which narrows to an inch diameter; this the neck of a large globular vessel B, both justed by grinding. C is a syringe of brass the glass B as shewn, and made air-tight with a grommet or outchouch washer. a<sup>1</sup>, a<sup>2</sup>, a<sup>3</sup> are three layers of porous felt, pierced by the tube d, which allows air bubbles to escape from the bottom without disturbing the fluid. The material to be percolated, as wood, bark, root, leaves, &c., is first cut into small pieces, and is then laid on the top of the uppermost layer, a<sup>1</sup>, so as to half fill the space between the layers and the glass-cover c; water, or any other required fluid, is then poured in until it is level with the top of the glass-cover. The stop-cock b is opened, and the operator draws the air from the outer vessel by means of the

air-pump C, the fluid is thus rapidly drawn through the material, and displaces its soluble parts. a<sup>1</sup> and a<sup>2</sup> arrest the fine solid particles which are carried through the first diaphragm with the liquid, and form sediments which are also acted upon by the liquid which is checked at each division for a time. The fluid, when it reaches the globular glass, however dark coloured, is beautifully bright and clear, and the preparations so made are remarkable for their good quality and uniformity of strength. Within the present year (1864), Dr Redwood, of the Pharmaceutical Institution of Great Britain, has invented a new percolator of great efficacy. It consists of a tinned-copper cylinder, with a cylinder of flannel inside, in which the materials are put. The whole is filled with the fluid menstruum, and as that which is in more immediate contact with the solid materials becomes charged with the soluble matter displaced, it gives rise, as its density is increased, to an endosmotic action through the flannel walls of the inner cylinder until the whole is equalised, when it is drawn off by the tap, and fresh fluid added until it comes away colourless. The outer cylinder has a tight cover to prevent loss by evaporation.

PERCUSSION, in Medicine, is the method of eliciting sounds by tapping, or gently striking the surface of the body; its object being to determine by the nature of the sound the comparative density of the subjacent parts. This means of diagnosis was first employed by Avenbrugger in the middle of last century, and it was afterwards adopted by Corvisart in the investigation of heart diseases; but its value was not fully appreciated till Laennec made the diseases of the chest his peculiar study; and since his time, its application and various uses have been considerably extended by the labours of Piorry, Hughes Bennett, and other physicians.

Percussion is chiefly employed in the diagnosis of diseases of the lungs, heart, and abdominal organs. It may be *direct* (or, as some writers term it, *immediate*), or it may be *mediate*. In the former case, the part to be examined is struck with the ends of the three first fingers set close together on the same level, or with a small hammer tipped with India-rubber; while in the latter, which is now almost universally adopted, a flat body is placed upon the chest, or other part to be examined, and is then struck by the fingers or hammer. The flat intervening body is termed a *Pleximeter* (from the Gr. *plexis*, a blow, and *metron*, a measure). The instrument usually sold as a pleximeter is a flat oval piece of ivory, but the left index or middle finger of the physician, with its flat surface fitted accurately to the part to be examined, acts equally well. The force of the stroke on the pleximeter—whether the stroke be made with the fingers or the hammer—must vary according as it is desired to elicit the sound from a superficial or a deep-seated part. The surface to be percussed should be exposed, or, at most, only covered with one layer of clothing; and the blow should fall perpendicularly on the pleximeter. When percussion is made over a considerable cavity filled with air—as the stomach or intestines—a hollow, drum-like, or (as it is usually termed by medical writers) a *tympanic* sound is produced. When any part of the surface of the chest is struck, below which there is a considerable depth of healthy lung-tissue, consisting of small cells filled with air, a clear sound, less loud and hollow than the tympanic sound, and termed the *pulmonary percussion note*, depending partly on the vibrations of air in the lung-cells, and partly on the vibrations of the walls of the chest, is evolved. When the subjacent substance is solid (as the heart, liver, or spleen) or fluid (as when there is effusion into a closed sac),

the sound is *dull* in proportion to the density and want of elasticity of the part struck. The first thing that must be acquired in order to make percussion useful in the diagnosis of disease, is an accurate knowledge of the sounds elicited from the different parts in their normal condition. When, for example, the healthy pulmonary percussion note is known, increased resonance of the walls of the chest will indicate a dilatation of the air-cells (or Pulmonary Emphysema), while various degrees of dullness will afford evidence of such morbid changes as the effusion of fluid into the pleura (Hydrothorax), or inflammatory solidification of the lung-tissue (the Hepatisation of Pneumonia), or tubercular deposition. The use of percussion in relation to diagnosis is further shewn in the articles PERICARDITIS and PLEURISY.

**PERCUSSION CAPS** are small copper cylinders, closed at one end, for conveniently holding the detonating powder which is exploded by the act of percussion in percussion-arms. Caps were not used with the earliest percussion-arms, which the Rev. Mr Forsyth of Balhelvie, Aberdeenshire, patented in 1807; but they became tolerably general between 1820 and 1830, and were adopted for the army by 1840. The manufacture is extremely simple: A sheet of thin copper is stamped into pieces of appropriate shape, which are bent into the form of caps by stamping-apparatus closing round a mandril, the whole being done in one machine by two operations. The caps are then placed in a tray, mouths upward; and the inside of each is touched with a strongly adhesive varnish. Over this is dusted the detonating powder, all the particles which fail to adhere being blown, dusted, or shaken out. A stamper once more is forced into the cap, to fix and compress the powder, and the operation is completed. Large numbers are filled and stamped together, so that many thousands per hour may be turned out by one machine. Admirable mechanism, for the manufacture of caps, is employed in the Royal Laboratory at Woolwich.

For muskets, the caps are charged with equal parts of fulminating mercury and chlorate of potash; for cannon, with a mixture composed of two parts of chlorate of potash, two parts of native sulphuret of antimony, and one of powdered glass; the last ingredient taking no part in the chemical action, and being added merely to increase the friction. For the manner in which a cap is used, see LOCK.

**PERCUSSION, CENTRE OF.** See CENTRE OF PERCUSSION.

**PERCY.** This is the name of a noble Norman family who accompanied the Conqueror to England, and whose head, William de Percy, obtained from his sovereign thirty Knights' Fees in the north of England. The representation of the house devolved (temp. Henry I.) on Agnes, daughter of the 3d baron, who married Josceline of Lovain, brother-in-law of the king, only on condition that he adopted either the surname or the arms of P.; he chose to retain his paternal arms and to assume the P. name. The head of the family at the time was one of the chief barons who extorted Magna Charta from King John; and the 9th feudal lord (temp. Edward I.) shewed a similar spirit towards the pope, against whose demands he maintained, with others of the greater barons, the spiritual independence of the English crown. This nobleman's great-grandson was a distinguished military commander under Edward III., and acting as Marshal of England at the coronation of Richard II., was created Earl of Northumberland. He subsequently, however, took up arms against Richard, and placed the crown on

the head of Henry of Lancaster, who became IV. Again dissatisfied with the government, he joined in rebellion with his son Hotspur, purpose of transferring the crown to Mortimer of March. The earl, with the other leaders of the rebellion, fell at Bramham Moor (1407—1414), his titles became forfeited. These, however, were revived in favour of his grandson, who became High Constable of England, and who was killed at the battle of St Alban's. This earl's son and successor (the third earl) met a like fate on the field, fighting in the van of the Lancastrians. The 4th earl (who obtained a reversal of his attainder) was murdered by the populace in Cumberland, when ordered by the avarice of Edward VII. to enforce a subsidy. The executions of the 5th and 7th earls by Edward VI. and Elizabeth I. form a part of the history of England. The 8th earl was committed to the Tower, on a charge of being concerned in a plot in favour of Mary Queen of Scots, and died a violent death in prison. The 9th earl fought in the civil wars against Charles I., but he took no part with the regicides, and eventually joined in the general effort to bring about the Restoration. The 11th earl left an only child, who succeeded to the ancient barony of P., and his son, King Charles, Duke of Somerset, became the Duke of Algonquin, Duke of Somerset, who was Earl of Northumberland, with remainder to his son-in-law, Sir Hugh Smithson, of Stanwick, county of York, a gentleman of respectable family. Sir Hugh, succeeding to the earldom, obtained in 1766 his advancement to the dukedom of Northumberland, which title is now held by his grandson, the present duke, who thus represents the house of P. only in the female line.

**PERCY, THOMAS, D.D.**, an eminent antiquary, collector, and scholar, was born at Bridgenorth, Shropshire, in 1728; was educated at Christchurch, Oxford; and having entered the church, rose to be Bishop of Dromore, in 1782. He died in 1811. This amiable and accomplished prelate, the friend of Johnson, Goldsmith, and other distinguished contemporaries, published translations from the Icelandic, a new version of the *Song of Solomon*, the *Northumberland Household Book*, a translation of Mallet's *North English Antiquities*, &c. His most popular and valuable contribution to our literature was the *Reliquiæ of Ancient English Poetry*, consisting of old ballads and songs, with some modern imitations, which the editor himself displayed the true feeling of a poet. This work appeared in 1765. P. lived to see four editions of it called for by the public, and to receive the warm commendations of all poetical readers and critics. The *Reliquiæ* were chiefly obtained from an old folio MS. that had fallen into P.'s hands, with the addition of others from the Pepys collection at Cambridge, the Ashmole Library at Oxford, the British Museum, and the works of our earlier poets. P. was not without liberties were taken with some of the ballads, softening touches, repairs, and renovations, which the editor was severely censured by antiquaries and other antiquaries; but the collection is of great value to our literature, recalling the taste to the rude energy, picturesque and pathetic passion of the old chivalrous minstrels and bethan songsters. It captivated the imagination of Walter Scott, and was the germ and model of his *Minstrelsy of the Scottish Border*. The memory of P. has been still further perpetuated by a Club Book Association, called the PERCY SOCIETY. See CLUB BOOKS, in Supplement.

**PERDIDO**, a bay and river of Alabama

PEREGRINE FALCON—PERENNIAL.

bay, 20 miles long by 6 to 10 miles wide, opens a narrow channel into the Gulf of Mexico, 18 miles west of the entrance to Pensacola Bay; the river rises in South-Western Alabama, and bay and river form the boundary between Alabama and Florida.

**PEREGRINE FALCON** (*Falco peregrinus*), a species of Falcon (q. v.) found in almost all parts of the world. The female is larger than the male, measuring about 18 inches in length from the tip of the bill to the tip of the tail, whilst the male is about 15 inches. The female is the *Falcon* of the ancients, and the male the *Tercel*. The plumage of the two sexes is very similar. The back, wings, and tail are bluish-slate or ash-gray, the feathers barred with a darker tint; the crown of the head, back of the neck, and a spot below the eye, nearly black; the front of the neck white, with dark longitudinal streaks; the breast, belly, and plumage of the legs, buffish, with dark-brown transverse bars. The tail-feathers are very long, reaching almost to the tip of the tail; and the bird is remarkable for its power of flight, being capable of maintaining for a considerable time a rate of more than 100 miles an hour, so that it is often seen far from any haunts or breeding-places; whence the name peregrine, from the Latin *peregrinus*, a wanderer. Its swoop, when rushing on its quarry, is wonderful for rapidity and force. The P. F. can easily fly through the air a bird or quadruped fully its own weight. Its ordinary prey consists of grouse, woodcocks, rabbits, &c. The woodcock in vain attempts to escape from it by threading its way among the branches of trees and brushwood; the falcon follows, and exhibits at least an equal power of flying with great rapidity in the thicket without being entangled or stayed. Sometimes the quarry rises into the air, and seeks safety by trying to rise above the falcon, till both are lost to ordinary sight; but the falcon generally gets uppermost, and strikes it at last. The quantity of game destroyed by the P. F. is very great. It is supposed that a single nest of peregrine falcons will consume nearly 300 brace of grouse in a season, besides much other prey. The P. F. is a bird as remarkable for its swiftness as for power of flight. It has sometimes been seen to pounce on game shot by a sportsman, where it could fall to the ground; and an instance occurred in Yorkshire of a P. F. dashing through the glass of an aviary in a town, and carrying off a bird. It makes its nest on ledges of high rocks, or on the sea-coast or in inland precipices and caves, and lays from two to four eggs. Numerous instances in Britain have long been noted as breeding-places of the P. F., and some of them were early visited, whilst falconry was a favourite sport, for young birds, which were not procured without danger and difficulty. The bird, caught when an adult, although more difficult to train, was, however, believed to possess superior qualities. The P. F. is more docile, and becomes more gentle than the Gyr-falcon. The young female of the P. F. has been by mistake described by Pennant and others under the name of the Lanner (q. v.), a species not found in Britain. For fig. of P. F., see **PLATE XXXV.**

**PEREIRA, JONATHAN**, the pharmacologist, was born in the parish of Shoreditch, London, May 1804. After a distinguished career at the classical academy in Finsbury, where he resided for four years, he devoted himself to the study of medicine, and in 1823 was appointed assistant medical officer of the General Dispensary in Aldersgate Street, at which institution he became, three years afterwards, lecturer on

chemistry. His attention was early attracted to the study in which he has become famous. In 1824, he published a translation of the *London Pharmacopœia*; which was followed by *A Manual for the Use of Students; A General Table of Atomic Numbers, with an Introduction to the Atomic Theory*; and other text-books for the use of those who were preparing for medical examinations. He contributed numerous papers to the professional journals on the properties and adulteration of drugs, and laid the foundation of those researches which issued in his great work on *Materia Medica*. In 1832, he resigned the office of lecturer for that of Professor of *Materia Medica* in the New Medical School in Aldersgate Street, and at the same time he succeeded Dr Gordon as Lecturer on Chemistry at the London Hospital. His *Elements of Materia Medica* (first published in the form of lectures contributed to the *Medical Times and Gazette*) appeared as a separate work in 1839—1840, and at once established his reputation as a pharmacologist. The treatise is remarkable for the extent of its research, the variety of its information, whether scientific, commercial, or practical, and the scrupulous exactness of its statements. In 1841, he procured the licence to practise in London from the College of Physicians; in 1845, he was elected a Fellow of that body; and on the establishment of the London University, he was appointed Examiner in *Materia Medica* and Pharmacy, a post which he filled with admirable efficiency till his death. Among his other contributions to science, the best known are his excellent treatises on *Diet* and on *Polarised Light*, both of which appeared in 1843. His death, which took place on January 20, 1853, was the result of a fall down a flight of steps in the College of Surgeons, and was deeply felt, not only by his professional brethren, but by the numerous scientific bodies, such as the Royal, the Linnæan, and the other societies of which he was a distinguished Fellow.

**PEREKOP, ISTHMUS OF**, in South Russia, government of Taurida, 18 miles long, 16 miles broad at its southern, and 5 miles broad at its northern extremity, connects the peninsula of the Crimea with the mainland of European Russia. It is an arid waste of mere sand, or sand combined with clay. There are, however, numerous salt lakes, and salt is extensively made. In the north of the isthmus, and forming the key to the Crimea, is the small town of Perekop. Notwithstanding its advantageous position at the convergence of the numerous roads leading from South Russia into the Crimea, P. is of little commercial importance. Pop. of town 3397.

**PERE-LA-CHAISE.** See **LA-CHAISE**.

**PEREMPTORY DEFENCES**, in Scotch Law, mean defences to an action or suit, which amount to an entire negative of the right of action, as distinguished from a preliminary or temporary defence.

**PERENNIAL**, in Botany, a term employed in contradistinction to Annual (q. v.) and Biennial (q. v.), to designate plants which subsist for a number of years. Some plants, however, which are annual in cold climates, are perennial in warmer regions. The term perennial is in general applied only to herbaceous plants, and indicates a property only of their roots, the stems of most of them dying at the end of each summer. Perennial herbaceous plants, like shrubs and trees, are capable of producing flowers and fruit time after time, in which they differ from annual and biennial plants, which are fruitful only once. Those plants which are capable of being propagated by cloves, offset bulbs, or tubers, are all perennial. Thus the potato is a perennial plant, although the crop is planted in spring and reaped in autumn, like

that of corn, whilst all the corn plants are annuals. —There is great diversity in the duration of life of perennial plants.

**PERESLAV**, or **PEREIASLAVLE-ZALIE-SKY**, a district town in the middle of Great Russia, in the government of Vladimir, and 70 miles north-west of the city of that name. It was founded in 1052 by George, Prince of Soustal. It possesses upwards of 30 churches and religious institutions; but is principally noteworthy for its factories, which are nine in number, and of which the most important are cotton-mills and print-works for cotton goods. The factories yield in all an annual profit of about £3,000,000. The cotton manufactures of P. are exported to the fairs of Nijni-Novgorod and Irbit, and even to China by way of Siberia. Pop. 6783, employed in the factories and in the productive fishery of Lake Plestcheiff.

**PEREZ, ANTONIO**, minister of Philip II. of Spain, was born in Aragon in 1539. His father was Secretary of State under Charles I. and Philip II., and he himself was appointed to this office when only 25 years of age, and acquired the entire confidence of the king. Don Juan D'Austria, having sent his confidant, Juan de Escovedo, to Spain, to solicit aid against the party of Orange; and Escovedo having rendered himself an object of hatred both to the king and to P., the former resolved to put him out of the way by murder, and intrusted P. with the accomplishment of this design, which P., to gratify his own revenge, accomplished accordingly, 31st March 1578. The family of Escovedo denounced P. as the murderer, and all his enemies joined against him. The king at first sought to shield him; but in July 1581 he was arrested, and by torture forced to confess. He succeeded, however, in making his escape to Aragon, where he put himself under protection of its laws. After a long and severe inquiry into his conduct, he was found guilty of many acts of fraud and corruption, and condemned to death in Madrid; but the *Justicia Mayor*, or highest court of justice in Saragossa, refused to deliver him up. The king applied for aid in May 1591 to the Inquisition, and the Aragonese court delivered him up to its agents, but the people rose in tumult, and liberated him. This happened repeatedly; and at last, in September 1591, Philip II. entered Aragon with an army powerful enough to subdue all opposition, abolished the old constitutional privileges of the country, and caused a number of the principal people to be executed. P., however, made his escape, avoiding the many plots which the king laid for his assassination. He was condemned in Spain as a heretic, but was treated with great kindness in Paris and London. He spent the latter years of his life in Paris, and died there in 1611 in great poverty. P. wrote an account of his misfortunes, which was published at Paris in 1598, under the title of *Relaciones*.

**PERFECTIBILITY OF CHRISTIANS**, a doctrine held by the Wesleyan Methodists (see **METHODISTS**) of a *Christian perfection* attainable in this life. It is not a perfection of *justification*, but a perfection of *sanctification*; which John Wesley, in a sermon on Christian Perfection, from the text Heb. vi. 1, 'Let us go on to perfection,' earnestly contends for as attainable in this life by believers, by arguments founded chiefly on the commandments and promises of Scripture concerning sanctification; guarding his doctrine, however, by saying that it is neither an *angelic* nor an *Adamic* perfection, and does not exclude ignorance and error of judgment, with consequent wrong affections, such as 'needless fear or ill-grounded hope, unreasonable love, or unreasonable aversion.' He admits, also, that even in

this sense it is a rare attainment, but asserts 'several persons have enjoyed this blessing, without interruption, for many years, several enjoy it every day, and not a few have enjoyed it unto their death, as they have declared with their latest breath, calmly witnessing that God had saved them from all sin, till their spirit returned to God.' Conceding all which, the general belief of Protestant Christians is, that these persons were merely self-complacent and less sensible of their corruptions than is usual, and that the commandments and promises concerning sanctification are not acceptable of an explanation consistent with removal of corruption in believers, and a need of further sanctification, or a continued going on unto perfection, whilst this life endures.

That perfection is attainable in this life, is denied by the Franciscans, Jesuits, and Molinists of the Church of Rome, but denied by the Dominicans and Jansenists. In advocating the doctrine, its supporters generally rest much on the distinction between mortal and venial sins.

**PERFORMANCE OF CONTRACTS** is the modes of satisfying the contract, which may be either by doing some specific thing, or by not doing something, or by payment of money. It is a good answer to any action brought by one party against another for breach of contract, that what was contracted for has been performed.

**PERFUMERY, PERFUMES** (Fr. *parfumerie*, from Lat. *fumus*, smoke or vapour), delicate fragrant smells. Perfumes are of three distinct classes, derived from plants, and there is a fourth class, which are of animal origin.

**CLASS I.**—These are the most ancient, and have been in use from the earliest period of which history is record. They consist of the various odorous gum-resins, which exude naturally from the plants which yield them; and to increase the production of these plants are often purposely wounded. The most important are benzoin, olibanum, myrrh, and storace. No less than 5000 cwt. of these together are annually imported into Britain. Gum-resins are the chief ingredients in 'Incense,' (q. v.), and Pastilles (q. v.).

**CLASS II.** are those perfumes which are produced by distillation. As soon as the Greeks and Romans learned the use of the still, which was an invention imported by them from Egypt, they adapted it to the separation of the odorous principle from the numerous fragrance-bearing plants which are indigenous to Greece and Italy. An essential oil, or otto thus procured from orange-flowers, was in commerce to this day the name of *Neroly*, supposed to be so named after the Emperor Nero. Before that time, however, fragrant waters were in use in Arabia. Odour-bearing plants contain a fragrant principle in minute glands or sacs; these are found sometimes in the rind of the lemon, as the lemon and orange; in others, it is in the leaves, as sage, mint, and thyme; in wood, as rosewood and sandal-wood; in the bark, as cinnamon and cinnamon; in seeds, as caraway and nutmeg. These glands or bags of fragrance may be plainly seen in a thin cut stratum of orange peel; so also in a bay leaf, if it be held to the sunlight, all the oil cells may be seen like specks. All these fragrant-bearing substances yield by distillation an essential oil peculiar to each; thus is procured oil of patchouly from the leaves of the patchouly plant, *Pogonias patchouly*, a native of Burmah; oil of caraway from the caraway seed; oil of geranium from the leaves of the *Geranium rosea*; oil of lemon,

on-peel; and a hundred of others of more  
ite variety.

ne old name for these pure odoriferous principles  
Quintessence. Latterly, they have been  
ed Essential Oils; they are now, in modern  
tific works, often termed Ottos, from the  
kish word attar, which is applied to the well-  
wn otto or attar of roses. See OIL.

l the various essential oils or ottos are very  
ly soluble in water, so that in the process of  
llation the water which comes over is always  
rant. Thus, elder water, roes water, orange  
n, or bergamot fruit peel will yield about 10  
es of the fragrant oil; 100 pounds of cedar  
will give about 15 ounces of oil of cedar;  
ounds of nutmeg will yield 60 to 70 ounces  
l of nutmeg; 100 pounds of geranium leaves  
ield 2 ounces of oil.

ery fragrant substance varies in yield of  
tial oil. The variety of essential oils is end-  
ut there are a certain relationship among  
rs as among tints. The lemon-like odours are  
most numerous, such as verbena, lemon, berga-  
orange, citron, citronella; then the almond-  
odours, such as heliotrope, vanilla, violet;  
spice odours, cloves, cinnamon, cassia. The  
e may be classified into twelve well-defined  
s. All these ottos are very soluble in alcohol,  
t, butter, and fixed oils. They also mix with  
snuff, starch, sugar, chalk, and other bodies,  
ich they impart their fragrance.

he principal consumption of the various frag-  
ottos is for scenting soap. Windsor soap,  
d soap, rose soap, and a great variety of others,  
st of various soaps made of oil and tallow,  
med while in a melted state with the several  
d ottos or mixtures of them.

ough snuff is by no means so popular an article  
e reign of Victoria as it was in Anne's time,  
ne increased population, and still more increased  
ts to colonies, cause a positive increased pro-  
n in scented snuff now than fifty years past,  
; is especially in demand in the fur countries  
rthern Canada. There is a large consumption  
yrrant essential oils in the manufacture of toilet  
ers; under the various names of rose powder,  
powder, &c., a mixture of starch and orris,  
ntly scented, is in general demand for drying  
kin of infants after the bath.

ipitated chalk and powdered cuttle-fish bone,  
perfumed with otto of roses, powdered myrrh,  
amphor, become 'Dentifrice.' The ottos of  
rminit, lavender, rose, and others, are exten-  
used in scenting sweetmeats and lozenges.

re than 200,000 pounds-weight of various ottos  
imported into Britain in 1860, and valued at  
£180,000; to this must be added at least one-  
as much again distilled in England. Of the  
ted articles enumerated, oils of lemon and  
not, from the Two Sicilies, reached 128,809  
s, valued at £57,054.

ss III.—These are the perfumes proper, such  
e used for perfuming handkerchiefs, &c.  
ary to the general belief, nearly all the per-  
derived from flowers are not made by dis-  
on, but by the processes of *enfleurage* and  
ution. Although this mode of obtaining the

odours from flowers has certainly been in practice  
for two centuries in the valley of the Var, in the  
south of France, it is only by the publication of  
a recent work\* that the method has been made  
generally known. The odours of flowers do not, as  
a general rule, exist in them as a store or in a gland,  
but are developed as an exhalation. While the  
flower breathes it yields fragrance, but kill the  
flower, and fragrance ceases. It has not been  
ascertained when the discovery was made of con-  
densing, as it were, the breath of the flower  
during life; what we know now is, that if a  
living flower be placed near to grease, animal  
fat, butter, or oil, these bodies absorb the odour  
given off by the blossom, and in turn them-  
selves become fragrant. If we spread fresh  
unsalted butter upon the bottom of two dessert-  
plates, and then fill one of the plates with gathered  
fragrant blossoms of clematis, covering them over  
with the second greased plate, we shall find that  
after 24 hours the grease has become fragrant.  
The blossoms, though separated from the parent  
stem, do not die for some time, but live and  
exhale odour; which is absorbed by the fat.  
To remove the odour from the fat, the fat must be  
scraped off the plates and put into alcohol; the  
odour then leaves the grease and enters into the  
spirit, which thus becomes 'scent,' and the grease  
again becomes odourless.

The flower farmers of the Var follow precisely  
this method on a very large scale, with but a little  
practical variation, with the following flowers—rose,  
orange, acacia, violet, jasmine, tuberose, and jonquil.  
The process is termed *enfleurage*. In the valley of  
the Var, there are acres of jasmine, of tuberose, of  
violets, and the other flowers named; in due season  
the air is laden with fragrance, the flower harvest  
is at hand. Women and children gather the  
blossoms, which they place in little panniers like  
fishermen's baskets hung over the shoulders. They  
are then carried to the laboratory of flowers  
and weighed. In the laboratory the harvest of  
flowers has been anticipated. During the previous  
winter great quantities of grease, lard, and beef-suet  
have been collected, melted, washed, and clarified.  
In each laboratory there are several thousand  
*châssis* (sashes), or framed glasses, upon which the  
grease to be scented is spread, and upon this grease  
the blossoms are sprinkled or laid. The *châsse en  
verre* is, in fact, a frame with a glass in it as near  
as possible like a window-sash, only that the frame  
is two inches thicker, so that when one *châsse* is  
placed on another, there is a space of four inches  
between every two glasses, thus allowing space for  
blossoms. The illustration shows the *châsse* with  
grease and flowers upon it (fig. 1), also a pile of the  
same as in use. The flower blossoms are changed  
every day, or every other day, as is convenient in  
regard to the general work of the laboratory or flower-  
ing of the plants. The same grease, however, remains  
in the *châsse* so long as the particular plant being  
used yields blossoms. Each time the fresh flowers  
are put on, the grease is 'worked'—that is, serrated  
with a knife—so as to offer a fresh surface of grease  
to absorb odour. The grease being *enfleurée* in  
this way for three weeks or more—in fact, so long as  
the plants produce blossoms—is at last scraped  
off the *châsse*, melted, strained, and poured into  
tin canisters, and is now fit for exportation. Fat  
or oil is perfumed with these same flowers by the  
process of maceration; that is, infusion of the flowers  
in oil or melted fat. For this end, purified fat is  
melted in a *bain marie*, or warm bath, and the fresh

\* *Art of Perfumery*, by Septimus Piesse, Ph.D., 8vo,  
50 cuts. Longman.

blossoms are infused in it for several hours. Fresh flowers being procured, the spent blossoms are strained away, and new flowers added repeatedly, so long as they can be procured. The *bain marie* is used in order to prevent the grease becoming too

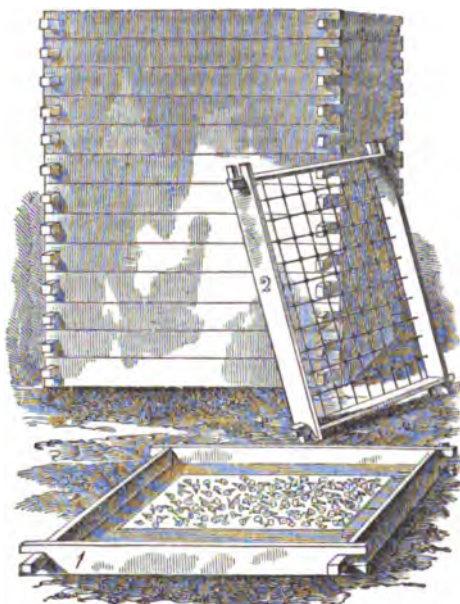

Fig. 1.  
1, Châssis en Verre; 2, Châssis en Fer.

hot from exposure to the naked fire; so long as the grease is fluid, it is warm enough. Oil does not require to be warmed, but improved results are obtained when it is slightly heated.

Jasmine and tuberose produce best perfumed grease by enfleurage, but rose, orange, and acacia

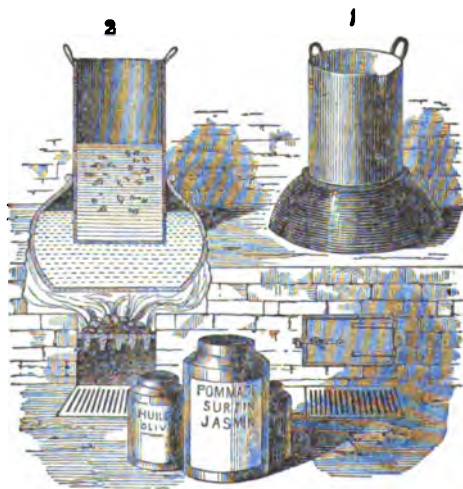

Fig. 2.  
1, Bain Marie; 2, Section of Bain Marie.

give more satisfactory products by maceration; while violet and jonquil grease is best obtained by the joint processes—enfleurage followed by

maceration. In the engraving a *châsse en fer* (is shewn; this is for enfleurage of oil. In place of glass, the space is filled with a wool on which is laid a *molleton*, or thick cotton moleskin, soaked with oil; on this the flowers are laid, just as with solid grease. In due time, after repeated changing the flowers, the grease becomes fragrant, and it is then pressed out on a moleskin cloth. Oil of jasmine, tuberose, prepared in this way. In order now to obtain perfume of these flowers in the form of scented handkerchiefs, we have only to use the scented fat or oil, made by any of the methods, in strong alcohol.

In extracting the odour from solid fat it is chopped up fine as suet is chopped, put in spirit, and left to infuse for about a month. In case of scented oil it has to be repeatedly washed with the spirit. The result is, that the spirit contains all the odour, becoming itself 'perfume,' while the grease again becomes odourless; thus is produced essence of jasmine, essence of orange flowers, of violets, and others already named, rose, tuberose, acacia, and jonquil.

It is remarkable that these flowers yield perfume which, either separate or mixed in various proportions, are the types of nearly all flower odours; when jasmine and orange flowers are blended, the scent produced is like sweet-pea; when jasmine and tuberose are mixed, the perfume is that of hyacinth. Violet and tuberose resemble lily of the valley. All the various bouquets and notes such as 'frangipanni,' 'white roses,' 'sweet orange' are made upon this principle.

The commercial importance of this branch of perfumery may be indicated by the quantity of flowers annually grown in the district of the Var. Harvest: orange blossoms, 1,475,000 lbs.; tuberose, 530,000 lbs.; jasmine, 100,000 lbs.; violets, 45,000 lbs.; acacia, 45,000 lbs.; geranium, 30,000 lbs.; tuberose, 24,000 lbs.; jonquil, 5000 lbs.

CLASS IV. Perfumes of animal origin. The principal are Musk (q. v.), Ambergris (q. v.), Castor (q. v.). The aroma of musk is the most universally admired of all perfumes, and freely imparts odour to every body with which it comes in contact. Its power to impart odour is such that polished steel will become fragrant of it if the steel be shut in a box where there is musk, containing being necessary.

In perfumery manufacture, musk is mixed with other odorous bodies to give permanence to the scent. The usual statement as to the length of time that musk continues to give out odour has been called in question. If fine musk be laid in thin layers upon any surface, and exposed to a changing current of air, all fragrance it is said, will be gone in from six to twelve months.

Civet is exceedingly potent as an odour, and pure, and smelled at in the bulk of an ounce is utterly insupportable from its nauseousness; in this respect it exceeds musk. When, however, civet is diluted so as to offer but minute quantities to the olfactory, then its perfume is generally admitted; this is so with gas-tar; but the principle is the same as that breathed by the beautiful narcissus. Castor is in our day almost obsolete as a perfume.

The average importation of musk per annum for the past five years is 9388 ounces, value £12,143; leaving for export 1578 ounces, value £2143; leaving for domestic consumption every year 7810 ounces, value £10,000. Average importation per annum for the past five years: otto of roses 1117 ounces, value £12,143; vanilla 3525 pounds, value £12,568; ambergris

PERGAMUS—PERICARDITIS.

es, value £225; civet 355 ounces, value £300; root 420 hundredweight. The works on perfumes are very few; that of name Celnart, in the Librairie Roret, is most rich of notice among the French; a translation of it has been made by Mr C. Morfit of Philadelphia, England, *The British Perfumer*, by C. Lilly (1822), was the only work of the kind published in England prior to the *Art of Perfumery* by Septimus Piesse (1855).

PERGAMUS, or PERGAMUM, anciently a city of Mysia in Asia Minor, on the navigable river Euxine, at the distance of 120 stadia from the sea. According to tradition, the place was of Greek origin, but its early history is quite insignificant. It first acquired prominence when Lysimachus, one of Alexander's generals, chose it as a stronghold in which to keep his treasures. Under Philetærus it became the capital of a state, 283 B.C. His successor, Eumenes I., maintained its independence against the Seleucids, although the title of king was first conferred by Attalus I., who reigned from 241 to 197 B.C.

He intimately allied himself with the Romans under Philip of Macedon, and this alliance subsisted throughout succeeding reigns, in which the kingdom increased in extent and importance, till at last Attalus III., surnamed Philometor, who died in 133 B.C., left it with all his treasures to the Romans, who successfully maintained the right thus acquired, under whom the city continued to flourish. It was the focus of all the great military and commercial interests of Asia Minor, and Pliny describes it as *longe summum Asiæ Pergamum*. The Attali collected a library only inferior to that of Alexandria. It was also the seat of a famous grammar-school, which gave its name to Parchment (q. v.). P. sank under the Byzantine emperors, but the place still flourishes under the name *Bergamah*, and is noted for its splendour and magnificence of its ruins, which include palaces, temples, aqueducts, gymnasia, theatres, and city walls.

PERGOLESE, GIOVANNI BATTISTA, an eminent Neapolitan of the Neapolitan school. Evidence regarding the date and place of his birth is conflicting; probably the correct account is that of these di Villarsosa, his latest biographer, who states that he was born at Jesi, near Ancona, on the 10th of January 1710. In 1717 he was admitted into the Conservatorio dei Poveri di Gesù Cristo at Naples, where he studied the violin under Domenico Monteleone, and musical composition under Gaetano Cappone and Durante. Under the conviction that his talents and taste were sacrificed to learning by the neglect of the masters of his time, he abandoned the study of the violin and Greco for that of Vinci and Corelli. His first great work was the oratorio of *Guiglielmo d'Aquitania*, composed in 1731. In 1732 and the following year appeared his operas of *Il Servo Padrone*, *Il Prigionier Superbo*, and *Lo Schiavo Innamorato*; in 1734, *Adriano in Siria*; in 1735, *Il Flaminio* and *L'Olimpiade*. In 1734, he received the appointment of *maestro di capella* of the church of Loretto. In consequence of delicate health, he removed to Pozzuoli, where he composed the *Antata di Orfeo*, and his pathetic *Stabat Mater*. He died there of consumption in 1736. Besides the above-mentioned works, P. composed a number of songs for the church, which were better appreciated during his lifetime than his secular compositions, including a violin concerto, and thirty trios for violin, cello, and harpsichord. His works are all characterised by sweetness and freedom of style.

PERI (Fairy), according to the mythical lore of the East, a being begotten by fallen spirits, which spends its life in all imaginable delights, is

immortal, but is for ever excluded from the joys of Paradise. It takes an intermediate place between angels and demons, and is either male or female. So far from there being only female Peris, as is supposed by some, and these the wives of the Devas, the Peris live, on the contrary, in constant warfare with these Devas. Otherwise, they are of the most innocuous character to mankind, and, exactly as the fairies, with whom our own popular mythology has made us familiar, are, when female, of surpassing beauty. One of the finest compliments to be paid to a Persian lady is to speak of her as Perizadeh (born of a Peri; Greek, Parisatis). They belong to the great family of genii, or jin: a belief in whom is enjoined in the Koran, and for whose conversion, as well as for that of man, Mohammed was sent (cf. Koran, chaps. lv., lxxii., and lxxiv.).

PERIA'GUA, a large canoe composed of the trunks of two trees, hollowed and united into one fabric; whereas an ordinary canoe is formed of the body of one tree only. Periguas are used in the Pacific, and were formerly employed among the West India Islands, whence the frequent allusion to them in *Robinson Crusoe*.

PERIANTH (Gr. *peri*, around, *anthos*, a flower), in Botany, the floral envelope (see FLOWER) of those plants in which the calyx and corolla are not easily distinguished. The term is convenient, as it can be applied indifferently to the calyx and corolla; thus, when there is either a calyx or corolla existing, but not both, the perianth is said to be *single*; when both are present, *double*. Both are really present in many endogenous plants, to which the use of the term perianth is confined by some botanists; the single floral envelope of exogenous plants being regarded as a calyx, and the corolla supposed to be wanting. The perianth is *regular* in some plants, *irregular* in others. It often displays great beauty, as in tulips, crocuses, lilies, &c.

PERICARDI'TIS, or Inflammation of the Pericardium (q. v.), is a disease of frequent occurrence; the result of a very large number of post-mortem examinations being to shew that about 1 in 23 of all who die at an adult age exhibits traces of recent or old attacks of this disorder.

For reasons which will be obvious when we come to speak of the physical signs of this disease, we shall commence with a notice of the anatomical changes which take place in the inflamed membrane. Very soon after symptoms of pericarditis begin to shew themselves there is an abnormal dryness of the serous membrane, which is speedily followed by an increased secretion of fluid. The secreted fluid is sometimes almost entirely fibrinous, in which case it coagulates, and gives rise to adhesions between the heart and the pericardium; or it may consist almost entirely of serum, which remains liquid; or it may be, and it most frequently is a mixture of the two. When there is a large amount of liquid effusion (as, for instance, a third of a pint or more) which is not re-absorbed, death usually takes place in the course of a few days, in consequence of the interference of the fluid with the heart's actions; but when there is not much liquid effusion, or when the liquid part is absorbed, the pericardium becomes more or less adherent, and apparent recovery usually takes place.

In the cases that prove fatal when fibrinous fluid has been effused, but has not coagulated to such an extent as to cause complete adhesion of the heart to the pericardium, the partially coagulated fibrin (or lymph, as the older authors styled it) is seen to be of a yellowish-white colour, and to occur in a rugged, shaggy, or cellular form. Laennec compared the



surface on which the lymph is deposited to that which would be produced by suddenly separating two flat pieces of wood between which a thin layer of butter had been compressed. Dr Watson regards the appearance as more like the rough side of pieces of uncooked tripe than anything else; while others have compared it to lace-work, cut sponge, a honey-comb, a congeries of earthworms, &c. When the patient dies at a more advanced stage of the disease—viz., soon after the whole of the membrane has become adherent—imperfect blood-vessels, in the form of red points and branching lines, are seen, indicating that organisation is commencing in the deposit, which if death had not ensued would have been finally converted into cellular or areolar tissue, and have occasioned the complete obliteration of the pericardial cavity.

The symptoms of pericarditis are pain in the situation of the heart, increased by a full inspiration, by pressure upon or between the ribs in the cardiac region, and especially by pressure upwards against the diaphragm by thrusting the fingers beneath the cartilages of the false ribs; palpitations; a dry cough and hurried respiration; discomfort or pain on lying on the left side; restlessness; great anxiety of countenance; and sometimes delirium. The pulse usually beats from 110 to 120 in a minute, and is sometimes intermittent; and febrile symptoms are always present. These symptoms are seldom collectively present in any individual case, and until the time of Louis the diagnosis of this disease was uncertain and obscure. The physical signs, dependent on the anatomical changes which have been described, are, however, generally so distinct that by their aid the disease can be readily detected. They are three in number. 1. In consequence of irritation propagated to the muscular tissue of the heart at the commencement of the inflammation of its investing membrane, the ventricles contract with increased force, rendering the sounds of the heart louder and its impulse stronger than in health, or than in the more advanced stages of the disease. 2. When much fluid is effused into the pericardium, dulness on percussion is always observable to a greater degree than in health. This sign, which is very characteristic, is seldom perceived till the disease has continued for two or three days. In relation to this increased dulness, we must premise that in the healthy condition of the heart and lungs there is an irregular roundish space with a diameter of somewhat less than two inches, extending from the sternum (or breast-bone) between the level of the fourth and fifth ribs towards the left nipple, in which a portion of the surface of the heart is not overlapped by the lungs, but lies in contact with the walls of the chest. This space should normally be dull on percussion. In pericarditis the extent of the dulness beyond the normal limit indicates the amount of effusion. In extreme cases the dulness may extend over a space whose diameter is seven inches or more. Simultaneous with the increased dulness, there is a diminution of the heart's sounds in consequence of the intervening fluid, and the impulse is often scarcely perceptible. 3. The rubbing of the inflamed and roughened surfaces upon each other gives rise to a sound which is commonly called the *friction sound*, but which has received various names. Thus Dr Watson calls it a *to and fro* sound, and observes regarding its variations that, 'like all the other morbid sounds heard within the chest, it is capable of much variety in tone and degree. Sometimes it very closely resembles the noise made by a saw in cutting through a board; sometimes it is more like that occasioned by the action of a file or of a rasp; but its essential character is that of *alternate rubbing*; it is a *to and fro*

sound.' This sound is heard early in the disease, before the surfaces of the pericardium are separated by the effusion of fluid; and it is due either to the dryness of the membrane, or to its roughness from the deposition of lymph. When the two surfaces are either separated by fluid, or become adherent, the sound disappears; but when it has been lost from the first of these causes, it reappears after the fluid has been so far absorbed as to allow the surfaces again to come in contact. But when, again, its duration is brief, for the surfaces do not become adherent and cease to rub upon each other.

Pericarditis is a disease which occasionally takes a very rapid course, and terminates fatally in eight hours or less. In ordinary cases, however, which terminate in apparent recovery, the disease generally begins to yield in a week or ten days, but excepting that adhesion remains, the cure is not to be complete in three weeks or less. But although these patients *apparently* recover, the pericardial adhesion commonly occasions other structural changes of the heart sooner or later to the detriment of themselves; and in those cases that the physician has the opportunity of subsequently watching, he has observed that fatal disease of the heart, produced by the pericarditis, almost always supervenes. In slight cases it is probable that a true cure without adhesion, may take place.

Pericarditis frequently arises from exposure to cold when the body is warm and perspiring. It is no uncommon result of a contaminated state of blood, such as occurs in the exanthematous diseases, especially scarlatina, and in Bright's disease of the kidney; but beyond all comparison, it is of frequent occurrence in association with Rheumatism (q. v.), of which it forms by far the most dangerous complication.

At the commencement of the disease, blood should be freely taken (if the patient is tolerably strong) from the region of the heart either by cupping or repeated leeching; and at the same time a purgative attempt must be made to get the system cleared of the influence of mercury to the extent of rendering the gums tender and of affecting the breath. Mercury only should calomel in small doses, and combined with opium with the view of preventing purgation frequently given, but mercurial ointment should be rubbed into the arm-pits and inner sides of the thighs, and the mouth should be kept slightly open for some time. After three or four days, if the dulness should be much fluid effusion, a large blister should be applied over the heart; and if the patient is already under the influence of mercury, the surface may be dressed with mercurial ointment. Perfect rest both of body and mind is of great importance, and all possible causes of excitement should be excluded. The diet should be made chiefly farinaceous, and little or no animal food should be allowed till the beginning of convalescence. Cooling drinks are agreeable to the patient, and may be taken freely with advantage throughout the disease.

**PERICARDIUM, THE,** is a conical membrane, containing the heart and the commencement of the great vessels, to the extent of about two inches from their origin. It is placed with its greater surface upwards behind the sternum, and to its left is the interval between the pleuræ—the serous membrane in which the lungs are enclosed; while its lower surface is attached to the diaphragm. It is a fibrous membrane, consisting of an external fibrous layer and an internal serous layer. The fibrous layer is a dense, fibrous membrane; the serous layer is the serous membrane of the heart, and is then reflected on the inner surface of the fibrous layer. Like all serous membranes, it is a closed sac; its inner surface is smooth

g, and secretes a thin fluid which serves to the natural movements of the heart. Its name of this serous sac which constitutes is known as pericardium.

PERICARP. See FRUIT.

PERICLES (Gr. PERIKLES), the most accomplished statesman of ancient Greece, was born of distinguished parentage in the early part of the 5th c. His father was that Xanthippus who won the victory over the Persians at Mycale, and his mother, Agariste, was the niece of the great Athenian reformer Cleisthenes. P. received an elaborate education; but of all his teachers the one whom he most revered, and whose instructions he derived most benefit, was the philosopher Anaxagoras (q. v.). P. was successful all through his career for the singularly high quality of his manners, the 'Olympian' thunder of his voice, his sagacity, probity, and profound knowledge of his country, and his patriotic patriotism. When he entered on public life, the tyrants had only recently died, Themistocles was still in exile, and Cimon was fighting the battles of Greece for its freedom abroad. Although the family to which P. belonged was good, it did not rank among the first families of either wealth or influence, yet so eminent were the abilities of P., that he rapidly rose to the highest power in the state as the leader of the dominant democracy. The sincerity of his attachment to the 'popular' party has been questioned without the shadow of evidence. At the time of the measures which either personally or through his adherents he brought forward and which were passed, were always in favour of the preservation of the privileges of the poorer class of the state. P. seems to have grasped very clearly, and to have held as firmly, the modern 'radical' idea, that the state is supported by the taxation of the property of the citizens, it must govern with a view to the interests and not to *caste* interests. In 461 B.C., through the agency of his follower, Ephialtes, P. dealt a great blow at the influence of the oligarchy, by proposing the decree to be passed which deprived the aristocracy of its most important political rights. Shortly after, the democracy obtained a triumph in the ostracism of Cimon. During the next few years the political course pursued by P. was very clearly discernible, but in general his policy was hostile to the desire for foreign territorial aggrandisement, so prevalent among his ambitious fellow-citizens. In 454 B.C., the year after, he magnanimously proposed the ostracism (which was carried) for the recall of Cimon, and at the same time commenced negotiations with the other Hellenic states with the view of forming a grand Hellenic confederation, the design of which was to put an end to the mutually destructive wars of kindred peoples—to make of Greece a united nation, fit to front the outlying world. P. was not less sagacious than noble. Had he accomplished, the semi-barbarous Macedonians would have menaced the civilised Greeks in the East, and even Rome at a later period might perhaps have found the Adriatic, and not the Euphrates, the frontiers of her empire. But the Spartan aristocracy was utterly incapable of morally appreciating the true patriotism, or of understanding the necessity for it, and by their secret intrigues they frustrated the well-planned scheme to naught. Athens and Sparta were already, and indeed had for some time, in that mood towards each other which has characterised the future Peloponnesian war in which they are always found on opposite sides. The Spartans, in 448 B.C., restored to the Athenians the guardianship of the temple and the oracle of Delphi, of which they had been

deprived by the Phocians, the Athenians immediately after marched an army thither, and reinstated the latter. Three years later, an insurrection broke out in the territories tributary to Athens, Megara, Eubœa, &c., and the Spartans again appeared in the field as the allies of the insurgents. The position of Athens was critical. P. wisely declined to fight against all his enemies at once. A bribe of ten talents sent the Spartans home, and the insurgents were then rapidly and thoroughly crushed.

Cimon was now dead, and was succeeded in the leadership of the aristocratical party by Thucydides, son of Milesias, who in 444 B.C. made a strong effort to overthrow the supremacy of P. by attacking him in the popular assembly for squandering the public money on buildings, and in festivals and amusements. Thucydides made an effective speech; but P. immediately rose and offered to execute the buildings at his own expense, if the citizens would allow him to put his own name upon them instead of theirs. The sarcasm was successful, and P. was empowered to do as he pleased in the matter. But P. did not mean to be simply sarcastic; he wished to point out to the Athenians in a delicate way the spirit and aim of his policy, which was to make Athens, as a city, worthy of being the head and crown of Hellas. His victory in the assembly was followed by the ostracism of Thucydides; and during the rest of his career 'there was,' says the historian Thucydides, 'in name a democracy, but in reality a government in the hands of the first man.' The same author, however, informs us that he never did anything unworthy of his high position; that he did not flatter the people, or oppress his adversaries; and that with all his unlimited command of the public purse, he was personally incorruptible. Soon after this the Samian war broke out, in which P. acquired high renown as a naval commander. This war originated in a quarrel between the Milesians and Samians, in which Athens was led to take a part with the former. The Samians, after an obstinate struggle, were beaten, and a peace was concluded in 440 B.C. The position in which Athens then stood towards the other Greek states was peculiar. Since the time of the Persian invasion she had been the leader of the confederacy formed to resist the attacks of the powerful enemy, and the guardian of the confederate treasury kept in the isle of Delos. P. got the treasury removed to Athens, and, commencing the contingents of the allies for money—Athens, of course, herself undertaking to protect the confederacy—enormously increased the contributions to the 'patriotic fund.' The grand charge against P. is, that he applied the money thus obtained to other purposes than those for which it was designed; that, in short, he adorned and enriched Athens with the spoils of the allied states. But the objection is more plausible than solid, for, in point of fact, Athens kept up in admirable discipline a great fleet and a fine army, and P. made the Greek name more respected in his time than it had ever been before. It may be that his conduct is open to criticism in some respects, but a broad and just view of the motives which impelled him to act as he did, and a fair consideration of the political exigencies of the time will, in the main, justify his procedure. It is unnecessary to give a detailed account of all that he did to make his native city the most glorious in the ancient world. Greek architecture and sculpture, under his patronage, reached perfection. To P., Athens owed the Parthenon, the Propylæa, the Odeum, and numberless other public and sacred edifices; he also liberally encouraged music and the drama;

and, during his rule, industry and commerce were in so flourishing a condition, that prosperity was universal in Attica.

At length, in 431 B.C., the long-foreseen and inevitable 'Peloponnesian war' broke out between Athens and Sparta. With the circumstances that led to it we have not here to do, but as it terminated most disastrously for Athens, it is but right to say that P. is not to blame for the result. Had the policy which he recommended been pursued, one can hardly doubt that Athens, with her immense resources, would have been the victor, and not the vanquished, in the struggle. P. himself died in the autumn of 429 B.C., after a lingering sickness. His character has been sufficiently delineated in the outline of his life which we have given. His connection with the brilliant Aspasia (q. v.) is noticed elsewhere.

**PERIER, CASIMIR**, a celebrated French statesman, was born at Grenoble, in the department of Isere, France, 21st October 1777. His father had enriched himself by mercantile and industrial pursuits, into which he initiated his two elder sons; but Casimir was still studying at the college of the Oratory at Lyon when the revolution broke out. He immediately went to Paris, and there associated himself with his father and elder brother Antoine-Scipion in their endeavours to found a banking company. It is sufficient to notice here that the banking company was firmly established, and became the Bank of France. Casimir was drafted into the army in 1798, and served in an engineering corps till 1801, when he returned to Paris, and resumed the position of coadjutor to his brother. The house of P. prospered greatly under the empire; the peace which followed the events of 1815 aided the development of their plans, and gave a wider scope to their enterprises; and the public regarded with special favour men such as these two brothers, who devoted their abilities and fortunes to foster the growth of public, as well as their own, prosperity. In 1817, P. published three tracts, in which he condemned the financial policy of the ministry. These papers made a lively impression on the public, and led to the return of the author to the Chamber of Deputies by the electors of Paris. P., in his political principles, was essentially a Constitutionalist, equally far removed from absolutism on the one hand, and extreme democracy on the other. The elections of 1824, conducted under government influence, resulted in the ousting of the greater portion of the Constitutionals. P., however, and a few others of the chiefs of the party retained their seats; but their opposition to the ministerial measures, though constant and unwearying, was quite ineffective; it, however, raised them greatly in public opinion, and secured their re-election in 1827. In this year, P. had the honour of being elected as representative by both the departments of the Seine and Aube. He defended the loyal and sagacious administration of M. de Martignac, whose representations to the king, Charles X., seemed to have the effect of reconciling the royal party to government in conformity with the charter; but the subsequent rule of the Prince de Polignac reduced this hopeful state of affairs to its former critical condition. The revolution (of July 1830), which P., from his experience of that of 1789, had made every endeavour to prevent, now followed, and it only remained for him to render it as bloodless as possible. In this he was successful, through his great influence with the people of Paris. On August 3, he was elected President of the Chamber of Deputies, but resigned this office on the 11th of the same month to become a member of the ministry. When Laffitte became

President of the Council (November 2), 1831, that the tendencies of the ministry were revolutionary, resigned office, and resumed duty of the Chamber of Deputies. On 15 1831, he succeeded Laffitte as minister, and gave whole attention to the repression of revolutionary maintenance of order at home and of peace originating the political system known as *milieu* (q. v.). His foreign policy was very successful; he greatly contributed to the maintenance of Belgian independence, the suppression of the Miguelite insurrection in Portugal, the balancing of Austrian influence in Italy, and the general, to the spread and progress of constitutional liberty both at home and abroad; but the growth of extreme liberalism in France, partly previous encouragement unwittingly afforded himself, was a source of great annoyance. On the outbreak of cholera in Paris in 1832, P. made the most extraordinary exertions for the enforcement of the necessary measures; but he was attacked by cholera, and his system being already exhausted by his exertion, he died, 16th May 1832. No public monument in France was ever so generally erected by public subscription in the century as that erected by public subscription in the cemetery of Pere-la-Chaise.

**PERIGEE** (Gr. *peri*, near; *gê*, earth), the point in the moon's orbit which is nearest to the earth. The opposite point is the Apogee (q. v.). See PERIHELION.

**PÉRIGUEUX**, a town of France, in the department of Dordogne, and situated on the right bank of the Isle, 68 miles east-north-east of Bordeaux. It consists of the ancient city of Proper—which is gloomy in aspect, and has narrow streets, but large and solidly-built houses—*Puy St Front*, which, until the year 1222, was a separate and a rival town. In the old town are many curious remains of Gothic architecture. The old ramparts have been demolished, and replaced by beautiful and spacious boulevards. The cathedral of St Front is a majestic edifice, the work of the end of the 15th century. Quarries of granite and ing-stone are worked in the vicinity, and hands are employed in cutting and polishing. Paper, woollen cloths, cutlery, and hosiery are manufactured. The celebrated *Pâtés de Périgueux*, made of partridges and truffles, are largely exported. Pop. 16,422.

P., a town of the highest antiquity, is mentioned by Cæsar. In ancient times, it was a city of much importance. It stood at the junction of five Roman roads, and contained a number of splendid edifices. Close to the modern town, still to be seen the remains of a vast amphitheatre in form, and larger in its dimensions than the ancient amphitheatre of Nîmes. There are also remains of ancient aqueducts, baths, and the *Tour de Vésonne* is the most remarkable monument of Roman architecture. It is still 67 feet high, and appears to have been much higher; it is circular in circumference, and has walls 6 feet thick, and has neither doors nor windows. Its purpose is unknown.

**PERIHELION** (Gr. *peri*, and *helios*, sun), that point in its orbit at which a planet is nearest to the sun. The point of the orbit opposite to it is called the Aphelion (q. v.). The position of the perihelion, i. e., its longitude east or west of the equinox, is one of the seven elements of a planet's orbit.

**PERIM**, a small island belonging to the British, situated in the strait of Bab-el-Mandeb, at the entrance to the Red Sea. Lat. of

2° 38' N., long. 43° 12' E. It is 3½ miles long and broad; is about a mile distant from the coast, and about 13 miles from the African coast. The sides of this island, the navigation is easy; the Strait, between the island and Arabia, the passage most generally taken by vessels. The island is bare, destitute of fresh water, and ill supplied with provisions, which are brought for the part from Aden. P. owes its importance to its commanding position at the entrance of the Red Sea. On its south-west side is an excellent harbour, 1½ miles in length, and from a half to three quarters of a mile in breadth. It is easy of access, 7 to 8 fathoms in depth, and is capable of accommodating forty men-of-war. Fortifications were erected on the island since 1857, and the island commands the strait on both sides. It was captured by the English in 1799, and held by the French as a check upon the designs of the French, were then in Egypt. It was abandoned in 1801, but was reoccupied by Great Britain, February 1857, with a view to the protection of her Egyptian possessions, which were thought to be in some chance of danger from the opening of the Suez Canal (q. v.).

**PERIMETER** (Gr. *peri*, around, *metron*, a measure) and **PERIPHERY** (Gr. *phero*, I carry) terms denoting the boundary, or the length of the boundary, of any closed plane figure; though the term 'perimeter' is generally confined to those which are bounded by straight lines.

**PERIOD**, a term used in Chronology in the same sense as Cycle (q. v.), to denote an interval of time in which the astronomical phenomena to which it refers recur in the same order. It is also employed to denote a cycle of cycles. Various periods have been invented by astronomers, but we can only mention a few of the most important.

The Chaldeans invented the *Chaldean Period*, or *of Eclipses*, from observing that, after a number of revolutions of the moon round the earth, her eclipses recurred in the same order of the same magnitude. This period consists of 6585 days, or 6793-23 days, and corresponds exactly to a complete revolution of the zodiac. The Egyptians made use of the *Dogriacal*, or *Sothic Period*, as it is variously called, to compare their civil year of 365 days with the Julian year of 365½ days. The period originally consisted of 1460 Julian years, corresponding to 1461 Egyptian years, after the lapse of which the dates in both reckonings coincided. By comparing the solar and lunar years, Meton, an Athenian, invented (432 B. C.) a lunar period of 6940 days, called from him the *Metonic Cycle* (q. v.), also called the *lunar Cycle*. About a century afterwards, the discovery of Meton was discovered to be an insufficient approximation to the truth, and as he had made the solar year too long by about ¼ of a day, and of 4 Metonic cycles the solar reckoning advanced of the lunar by about 1 day 6 hours. To remedy this, a new period, called the *Calippic* period, was invented by Calippus, and consisted of 76 solar cycles less by 1 day, or 27,759 days. This period still gave a difference of 6 hours between the solar and lunar reckonings, it was corrected by Hipparchus, who invented the *Hipparchic Period* of 4 Calippic periods less by 1 day, 111,035 days, or about 304 Julian years, an exceedingly close approximation, being only a few minutes too long, when measured by the Julian year; and too short but by an almost inappreciable quantity, when measured by the *Month* (see MONTH). The *period of the Moon* or *Solar Cycle*, after which the same

day of the month falls upon the same day of the week, consists of 28 Julian years. If the year had regularly consisted of 365 days, that is, one day more than an exact number of weeks, it is evident that, at the end of seven years, the days of the month and week would again correspond; but the introduction of an intercalary day into every fourth year causes this coincidence to recur at irregular periods of 6, 11, 6, and 5 years successively. However, by choosing a period such as will preserve the leap-years in the same relative position to the other years, and at the same time consist of an exact number of weeks (both of which objects are effected by using the number 28, which is the least common multiple of 4 and 7), we insure the regular recurrence of the coincidence between the days of the week and of the month. The solar cycle is supposed to have been invented about the time of the Council of Nice (325 A. D.), but it is arranged so that the first year of the first cycle corresponds to 9 B. C. In calculating the position of any year in the solar cycle, care must be taken to allow for the omission of the intercalary day at the beginning of each century, and its insertion in the first year of every fourth century. See LEAP-YEAR. The present year (1864) is the 25th of the solar cycle. The *Julian Period* is a cycle of cycles, and consists of 7980 (= 28 × 19 × 15) years, after the lapse of which the solar cycle, lunar cycle, and the Indiction (q. v.) commence together. The period of its commencement has been arranged so that it will expire at the same time as the other three periods from which it has been derived. The year 4713 B. C. is taken as the first year of the first period, consequently, 1 A. D. was the 4714th of it, and the present year (1864) the 6577th.

**PERIODICAL**, a publication which appears continuously at regular intervals, and whose contents may be devoted to criticism, politics, religion, literature, science, arts, amusement, or general and miscellaneous subjects. Those periodicals which consist of a collection of critical essays are called *Reviews*.

The earliest periodical in Great Britain seems to have been the *Philosophical Transactions of the Royal Society*, which first appeared in 1665, and contained notices of books as well as original papers. Periodicals professing to notice the books that were being published appeared soon after from time to time under the name of *All the Works of the Learned*; and in 1692 appeared the *Gentlemen's Journal*, or *Monthly Miscellany*, properly speaking, the first English magazine. The *Gentleman's Magazine* was founded in 1731 by Cave the printer, a periodical which secured a fortune for its proprietor, and, after surviving all its competitors, still continues to flourish. The periodical literature of Scotland was long represented by the *Scots Magazine*, founded in 1739. The first English periodical that attempted anything like criticism was the *Monthly Review*, begun in 1749. It was followed in 1756 by the *Critical Review*, founded by Smollett; and these two were long the leading periodicals of their class, though their criticism was but meagre and unsatisfactory, according to our present notions. Another critical journal, called the *Anti-Jacobin*, was established in 1798. In 1802, a new era in criticism was inaugurated by the establishment in Scotland of the *Edinburgh Review* (q. v.); which was followed in London by the *Quarterly Review*, of about equal merit and opposite politics, supported by Sir Walter Scott, Southey, S. T. Coleridge, Heber, and at a later period by Hartley Coleridge, Lord Mahon, and Gladstone. Another very important periodical, *Blackwood's Magazine*, sprung up in Edinburgh in 1817, under the auspices of John Wilson and Lockhart, as much above the literary mark of former magazines, as the

*Edinburgh and Quarterly* were above the mark of preceding reviews, strongly devoted to the interests of conservatism, and, in its early years, somewhat violent in its politics. The review, in the course of time, became the favourite medium for all parties to disseminate their views on political, literary, or theological subjects. Among the most important periodicals of this class, besides the *Edinburgh and Quarterly*, are the *Westminster Review*, established 1824, characterised by freedom in handling philosophical and theological topics, and containing essays by J. S. Mill, Carlyle, Grote, John Sterling, and Lord Houghton; the *Dublin Review*, Roman Catholic, founded in 1836; the *North British Review*, which first appeared in Edinburgh in 1844; the *National Review*, which began in 1855; and the *Home and Foreign Review*, in 1862 (ceased to appear in 1864). All these periodicals preserve to a great extent the form of their two predecessors, and like them, appear four times in the year. A few reviews have of late appeared monthly, or even weekly; of this last class, the most widely-circulated and influential are the *Athenæum*, established in 1823, and the *Saturday Review*, in 1856. The management of a review is placed in the hands of an editor. Each article has at its head the title of a work or works, which either are directly the subject of the reviewer's criticism, or at least indicate the general subject of the article. Review articles are generally anonymous.

The greater part of magazines or periodicals of a more miscellaneous character appear monthly, and their system of management is somewhat similar to that of reviews; but the articles are generally shorter, the subjects more varied, consisting often of tales and novels, which appear there as serials, continued from number to number. Some of the most popular novels of the present day have first been published in magazines. *Blackwood* was the precursor of various monthly magazines of repute, the most important being *Fraser's Magazine*, established in 1830, which still preserves a high literary character. The usual price of these periodicals is 2s. 6d.; but in 1859 and 1860, several new magazines, *Macmillan's Magazine*, the *Cornhill*, *Temple Bar*, *London Society*, and the *St James's Magazine*, were started at the cheaper price of a shilling, under favourable auspices. In Great Britain there are now many weekly periodicals, chiefly of an instructive and amusing kind, price from a penny to three-pence each. This class of publications received an impetus and proper direction by the issue of *Chambers's Journal* and the *Penny Magazine* of the 'Society for the Diffusion of Useful Knowledge' in 1832. To the first mentioned, which still exists, have since been added *All the Year Round*, conducted by Charles Dickens, and various others enjoying a high degree of popularity. It is customary for the publishers of these weekly sheets to issue them accumulatively in parts monthly under a cover, wherefore they largely answer the purpose of monthly magazines. The rate of payment for writing in the higher class reviews is usually £10, 10s. per sheet of 16 demy 8vo pages; in the weekly periodicals, half a guinea to a guinea per column is ordinarily paid, but in some instances the price paid is very much greater; such particularly is the case as regards novels or stories, given chapter by chapter, through a series of numbers; for some tales in this form the payment amounts to hundreds, if not thousands of pounds—a striking proof of the eager demand for sensational fiction.

At present, there are in Britain about 82 quarterly periodicals, of which hardly more than 16 come under the common idea of a review; many are

devoted to special departments, literary, commercial, or theological; and some consist of an account of the transactions of particular literary or scientific. About 400 periodicals are published monthly, and from 50 to 100 weekly.

France possessed as far back as 1665 a review called the *Journal des Savants*, which, after a lengthened interruption, began again in 1763, and holds a respectable position as a scientific journal. A number of literary and scientific journals appeared in last century, as the *Nouveau Journal des Savants*, *Journal Littéraire*, *Journal Encyclopédique*, &c. Among the best was the *Magasin pittoresque*, begun in 1795, and from 1819 combined with the *Revue Encyclopédique*. The most noted critical journals in Europe were published in Paris, the *Revue des Deux Mondes*, which began in 1829, and has, since 1831, appeared nightly. In it and the other French periodicals of the same kind, the review form is not so completely preserved as with us: a proportion of tales, &c., is admitted, and the names of the contributors are required to be attached to their articles. The *Revue des Deux Mondes* has had many imitators, more or less identified with the political parties. The principal French periodicals of more recent date are the *Revue Contemporaine*, *Athénæum Français*, and *Revue d'Europe*.

In Germany, reviews have taken even root than in England. The *Göttinger Anzeiger*, which is the oldest publication of the kind, still preserves a high character. German periodicals, however, hardly be said to have begun till the time of Lessing, who, in conjunction with Nicolai of Berlin, established, in 1757, the *Journal der schönen Wissenschaften*, and afterwards other journals, characterised by an independence of thought unknown before. The *Allgemeine Literaturzeitung*, founded at Jena in 1785, was a periodical of a still higher character, having for contributors the most eminent literary men of the period. It was transferred from Jena to Halle, another periodical called the *Jenaische Allgemeine Literaturzeitung* sprung up at the former place, under the patronage of the celebrated literary circle at Weimar, of which Goethe was the centre. These two periodicals existed till 1848. Of modern German reviews, the *Literarische Centralblatt*, founded in 1850, is the best and most comprehensive. Among other periodicals which do not come under the class of reviews, may be mentioned *Das Deutsche Museum*, and *Das Weimarsche Jahrbuch für Deutsche Literatur und Kunst*, may be favourably named.

Italy possessed a critical journal, *Giornale Letterati*, as far back as 1710, conducted by the Apostle Zeno, which continued for 23 years. A new journal of the same name, founded in 1771, attained considerable repute. From 1830, the *Biblioteca Italiana* and *Antologia*, published at Florence, were reviews of considerable ability. The scientific periodicals of Italy are generally of a high quality. In the dominions of Victor Emmanuel, there are at present 31 literary and scientific periodicals, and a number of miscellaneous periodicals.

The United States of America possess a great variety of periodicals, quarterly and monthly, in a less degree weekly, issuing chiefly from the presses of Boston, New York, and Philadelphia. The most noted critical journal is the *North American Review*, established in 1815. It is mentioned with regret that, owing to the enactment of an international law of Copyright with the United Kingdom, many of the less reputable American periodicals systematically imitate British articles without permission or payment to the authors of Great Britain—a circumstance

## PERIODICITY—PERIOSTEUM.

ly to lower the general character of the trade in the United States. Latterly, it is well known, many of the periodicals, both in Europe and America, have acquired an interest in the introduction of wood-engravings, on the account of which large sums are expended.

**PERIODICITY** (in Physiology and Pathology). A regularity manifested by various phenomena in living animals to recur, after equal or unequal intervals of time, is so marked, that the great French anatomist and physiologist, Bichat, has put it under the title of the *Loi d'Intermittence*. It is seen in the alternation of sleep and waking, the phenomenon of menstruation, and the punctual return of various other functions. Some of the most obvious instances of periodicity that can be suggested as occurring in the human body subject; while less obvious examples are afforded by the apparently regular variations that have been observed in the excretion of carbonic acid from the lungs, and in the number of the contractions of the heart at different periods of the 24 hours. As is well known by experience, periodicity is usefully cultivated and fixed in daily habits, as well exemplified in the case of sleep, but in a special degree by the daily relieving of the bowels at a particular hour, a habit in which it is generally held that all young persons should be carefully instructed with a view to health and convenience.

In certain forms of disease, the law of periodicity is very distinctly seen. The regular recurrence of the paroxysms of intermittent ague, for example, is universally known, although the law of the periodicity has hitherto baffled all attempts to explain it.

Amongst those who have tried to solve the problem, may be mentioned Willis, Keil, Bailly, Cullen (who ascribes periodicity to 'a diurnal variation in affecting the animal economy'), and more recently Laycock, who refers it to the diurnal changes in relation to pressure, electricity, &c.

It often gives rise to periodic diseases which have no close analogy to that disease. Thus intermissions, malaria—is a frequent cause of tic douloureux, recurring at regular intervals; cases are also seen in which periodical vomiting, occurring at intervals, in one case, at an interval of ten days, is held to be due to it; and Mr Moore, surgeon at the Middlesex Hospital, has recently published the history of a woman who experienced a periodical swelling of the right knee, as a consequence of that disorder. Epilepsy is a disease in which the attacks (especially in women) tend to a period. Sir Henry Holland (*Medical Notes and Lectures*, 2d ed., page 341) records a case in which 'six attacks occurred, with intervals of from ten to eighteen minutes between; so exactly regular, as noted by the watch, that it was impossible to suppose it a mere casualty;' and another, in which a spasmodic seizure, more of tetanic than of convulsive character, occurred twice a day for many months successively, and almost exactly at the same hour each day.' For many other examples of periodic or intermittent morbid action, the reader is referred to a memoir by Henle, 'On the Course and Nature of Intermittent Disease,' in his *Pathologische Untersuchungen*; and to Sir Henry Holland's essay (to which we have already referred) in his *Medical and Surgical Reflections*. The most important practical relation to this class of diseases is, that they invariably yield to the action of certain remedies, especially bark and arsenic.

It is interesting to observe, that, in the absence of a beneficial or mischievous influence, the habit of periodicity is to be generally shunned in every instance likely to prove either physically or mentally prejudicial. No more marked

example of the injudicious cultivation of periodicity could be given, than in the evil practice of periodical blood-letting, which once prevailed all over Europe, and was only abandoned in recent times as not only useless, but in all respects injurious.

**PERIE'CI** (Gr. *Perioikoi*, literally, 'dwellers round about,' i. e., round about some particular locality or city) was the name given, in ancient Greece, to the original Achaean inhabitants of Laconia by their Dorian conquerors. The P. were not slaves, like the Helots (q. v.); they were merely a vassal population, personally free, cultivating their own ground, and carrying on most of the home and foreign trade of Laconia, but possessing no political rights, incapable of intermarrying with the Dorians of Sparta, or of holding important state-offices, and subjected to a land-tax in token of their dependent condition. They have been—as regards their political position—compared to the Saxons of England after the Norman conquest, and seldom has a historical parallel been so sound. The P. must have been very numerous, for they occupied at one time upwards of 100 cities, several of which were on the coast, whence the whole seaboard of Laconia bore the name of the *Perioikis*, and they produced capital sailors, which doubtless accounts for the anomalous fact of P. being occasionally invested with the command of the Spartan fleet. They also formed a part of the Spartan army. At the battle of Platæa (479 B.C.), there were 10,000 P. present. These dependent Achæans were not, however, all on a dead level of vassalage; they lived in regularly organised communities, where the social distinctions of rank, refinement, and wealth were as marked as elsewhere. Xenophon speaks of 'accomplished and well-born gentlemen' (*kaloï k'agathoi*) among the P. serving as volunteers in the Spartan army; and such artists and men of culture as Lacedæmon produced, in all probability belonged to this class. P. also existed in the other Dorian communities of the Peloponnesus.

**PERIOSTEUM** (Gr. *peri*, around, and *osteon*, bone), a tough fibrous membrane which surrounds the various bones. It is highly vascular, and is the means by which the outer layers of the shafts and the greater part of the spongy portions of the bones are supplied with blood. 'From the internal surface of the periosteum also is produced a layer of soft blastema (or plastic fluid in which cells are developed), by means of which, additions are made to the exterior of the growing bones. The process of ossification going on in the inner part of this blastema, contributes to the thickness of the bone, while a fresh supply is continually being added to the exterior of the blastema, through the medium of the vessels of the periosteum.'—Humphry *On the Human Skeleton*, page 19. In young bones, this membrane is thick, and in consequence of the intervening blastema, is very easily detached from the bone; but in the bones of the adult it is less thick and vascular, while its connection with the bone becomes closer, in consequence of the blastema being less; while in aged persons it is very thin, its vessels are scanty, and there is no blastema. Numerous experiments shew that the formation of bone is essentially due to the action of this membrane; and that, by transplanting detached portions of periosteum into muscular or other tissues, bony tissue is generated in those parts. In most cases in which this membrane has become detached in consequence of a wound or of disease, the exposed bone (except in the instance of the skull, which derives most of its nutrient matter from the dura mater) perishes; but this is

not invariably the case. Amongst its other offices, it serves, by isolating the bone from the surrounding tissues, to prevent the spread of disease from them to it. The shin-bone or tibia is thus indebted to the periosteum for its ordinary immunity, in cases of ulcer in that region. In those parts in which the bone is not so completely isolated from the surrounding tissues, as at the ends of the bones of the fingers and toes, inflammation of the soft parts not unfrequently extends to the bony structure.

**PERIOSTITIS**, or **INFLAMMATION OF THE PERIOSTEUM**, generally occurs on the surface of thinly-covered bones, such as the tibia, clavicles, and cranial bones. Its chief causes are (1) a *sphilitic taint*, in which oval swellings, called *Nodes* (q. v.), are produced; (2) *rheumatism*; and (3) *scrofula*. In the two latter cases, there is a periosteal swelling around the whole circumference or surface of the bone. The affection, especially when due to the first or second of the above causes, is usually accompanied with considerable nocturnal pain. If the disease occurs in an acute form, it must be treated with leeches, fomentations, and the other ordinary antiphlogistic (or lowering) remedies. When it becomes chronic, the treatment must be mainly directed to the cause which has originated it. In almost all cases, the nocturnal pains are best relieved by somewhat large doses (five to ten grains) of iodide of potassium, taken three times a day on an empty stomach.

**PERIPATE'IC PHILOSOPHY**, a designation of the philosophy of Aristotle (q. v.) and of his followers. It is of doubtful origin, being supposed to have been derived either from his custom of occasionally walking about (*peripatein*) during the delivery of his lectures, or from the place in which they were delivered having been a shaded walk of the Lyceum.

**PERIPNEUMO'NIA**, an inflammation of the membrane which invests the lungs, accompanied with general disturbance of the whole system; remarkably prevalent among horses in South Africa, in a zone from 20° to 27° S. lat. It is very fatal; and to its prevalence and virulence, Dr Livingstone is disposed to ascribe the fact that horses, although so abundant in the more northern parts of Africa, were unknown in the south till introduced by Europeans; this invisible barrier being more insurmountable than mountain ranges, deserts, or rivers. The season during which peripneumonia prevails is from December to April. Zebras, antelopes and oxen are liable to its attacks, but no kind of quadruped suffers so much from it as the horse. The flesh of animals which die of peripneumonia is unwholesome, and produces a malignant carbuncle in persons who eat it.

**PERIPTERAL** (Gr. *peri*; and *pteron*, a wing), a term applied to temples or like buildings having columns all round the cella.

**PERISTALTIC MOTION**. The terms *peristaltic* (Gr. *clasp*ing and *compressing*) and *vermicular* (or worm-like) are applied to the peculiar motion or action of the muscular coat of the intestines, by which the substances contained within it are regularly moved onward.

This action of the intestines is readily seen on opening an animal (a dog, cat, or rabbit, for example) immediately after it has been killed; and in these circumstances, it is perhaps exaggerated, from the stimulating action of the cold air; and it may be shewn in an abnormally active state, although not altered in character, by subjecting the exposed intestines to the influence of the electro-magnetic machine.

It appears, from the observations made by Brinton,

Todd and Bowman, and others on recent animals, that the peristaltic motion commences at the pyloric third of the stomach (see **DIGESTIVE ORGANS OF**), whence successive waves of contraction and relaxation are propagated downwards along the whole length of the intestinal canal. On examining a portion of intestine at the moment of contraction, we perceive a dilatation above the point of contraction; the latter being produced by the pressure of the contents of the now contracted portion of intestine; the former by the relaxation of a previously contracted portion. The rapidity of these contractions and relaxations gives rise to the peristaltic movements of the intestines, the appearance of which is compared to the writhings of a worm, whence they are distinguished by the appellation *vermicular*.—Todd and Bowman, *Physical Anatomy of Man*, vol. ii. p. 233. Numerous observations have been made upon the human subject, indirectly, in cases of disease of the abdominal walls, and of the wounds of the abdomen, and during certain operations. There are differences of opinion as to the cause of the peristaltic action; thus, Todd and Bowman assert that the intestinal movement is partly due to the influence of the stimulation upon the muscular tissue, and partly to the reflex action of the ganglia of the intestine of the sympathetic, stimulated by the contents of the intestinal contents with the mucous membrane. While Carpenter maintains that the intestinal movement from the stomach to the rectum is not due to the nervous centres either for its contraction or for its power of exercising it, but is effected by the contents by its own inherent power.

Numerous observations tend to shew that peristaltic motion has a nearly definite velocity in every individual. Most commonly the act of digestion takes place with perfect regularity every 24 hours (rarely every 12 hours, the quantity discharged being almost constant, if the mode of living does not vary). Heberden (*Commentarii*, p. 14) mentions a case who regularly had a motion once a month (the way of contrast) another who had twelve motions every day during thirty years, and then ceased to have any for seven years, and rather grew weaker otherwise. Ponteau (*Œuvres Posthumes*, p. 27) records the case of a young lady who had a stool for upwards of eight years, although in the last year she ate abundantly of fruit, and drank coffee, milk, and tea, and broth with yellow peas, but she had copious greasy sweats. Such a case is possible, but far from probable.

That the influence of *expectant attention* upon the muscular movements of the intestine (and of its lower portion) is very great, is shewn in various ways. It is, for the most part, thus that the mind operates in producing a readiness for defecation, one special hour in the day, and that the action of one and other equally inert substances act on the mind, if the patient believes them to be purgatives. Carpenter, in his remarks on 'the influence of expectant attention on muscular movements,' chapter of his *Human Physiology* treating of 'Muscular Movements,' mentions two very interesting cases of the kind which have fallen within his knowledge.

**PERISTYLE**, a colonnade around the entrance of a courtyard or other building.

**PERITONEUM** (Gr. *peritonion*, a membrane), a serous membrane, and like the other membranes of this class, a shut sac, which, in the female, is not completely closed. The Fallopian tubes communicate with it by their extremities. The peritoneum more or less invests all the viscera lying in the abdomen.

PERITONEUM—PERITONITIS.

cavities, and is then reflected upon the walls of the abdomen, so that there is a visceral and a parietal layer. Numerous folds are formed by the peritoneal layer as it passes from one organ to another. They serve to hold the parts in position, and at the same time enclose vessels and nerves. Some of these folds are termed *Ligaments*, from their serving to support the organs. Thus, we have ligaments of the liver, spleen, bladder, and uterus formed by peritoneal folds. Others are termed *Mesenteries*—the *Gr. meson*, the middle, and *enteron*, the intestine), and connect the intestines with the vertebral column. They are the Mesentery proper (q. v.), which has been already described, the ascending,

**PERITONITIS, or INFLAMMATION OF THE PERITONEUM**, may be either an acute or a chronic disease.

*Acute Peritonitis* generally presents well-marked symptoms. It sometimes commences with a chill, but severe pain in the abdomen is usually the first symptom. The pain is at first sometimes confined to particular spots (usually in the lower part of the abdomen), but it soon extends over the whole abdominal region. It is increased, on pressure, to such an extent that the patient cannot even bear the weight of the bedclothes; and to avoid, as far as possible, internal pressure upon the peritoneum, he lies perfectly still, on his back, with the legs drawn up, and breathes by means of the ribs, in consequence of the pain occasioned by the descent of the diaphragm in inspiration. The breathing is naturally shallow in these cases, and less air being admitted at each movement of respiration, the number of those movements is increased. There are perhaps forty or even sixty respirations executed in a minute, instead of eighteen or twenty. The pulse is usually very frequent, often 120 or more in the minute, and small and tense, though occasionally strong and full at the commencement of the attack. After the disease has continued for a certain time, the belly becomes tense and swollen; the enlargement being caused at first by flatus, and afterwards also by the effusion of fluid, as may be ascertained by percussion and auscultation.

The progress of the disease is in general rapid. In fatal cases, death usually takes place within a week, and often sooner. The symptoms indicating that the disease is advancing towards a fatal termination are great distention of the abdomen, a very frequent and feeble pulse, a pinched and extremely anxious appearance of the face, and cold sweats.

Peritonitis may arise from any of the ordinary causes of inflammation, such as sudden change of temperature (especially the combined effects of cold and wet on the surface of the body), excessive use of stimulating fluids, the suppression of long-standing discharges, translation of gout and rheumatism, &c. It is frequently the result of local violence, and of wounds penetrating the peritoneal sac, including various surgical operations. Besides the above causes, there are two which give rise to special varieties of peritonitis, viz., contagion or infection, which often prevails epidemically, and produces great mortality amongst women after childbirth, giving rise to puerperal peritonitis, one of the most perilous accompaniments of the awful disorder known as Puerperal Fever (q. v.); and perforation of the stomach, bowels, gall bladder, urinary bladder, &c., by which their contents are allowed to escape into the peritoneal cavity, where they excite the most violent inflammation. *Peritonitis* from *perforation* is characterised by the suddenness of the attack; intense pain, incapable of mitigation by medicine, all at once arising in some part of the abdomen, the whole of which soon becomes tender in every part. This form of the disease is generally fatal, death usually ensuing within two days, and sometimes within a few hours. Perforation of the small intestine, in consequence of ulceration of its glands, is of not uncommon occurrence in continued (typhoid) fever, and sometimes occurs in phthisis. That apparently useless structure, the vermiform appendage of the cæcum, is a comparatively frequent seat of perforation. Sometimes it is the stomach which is perforated, and in these cases the patients are usually unmarried women (especially domestic servants), who had previously appeared in good health, or at most had complained of slight dyspepsia.

The only disease with which peritonitis is likely

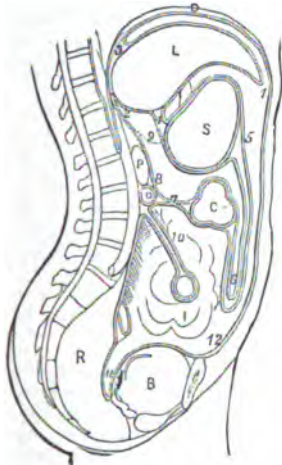

**The Reflections of the Peritoneum :**

Diaphragm; S, the stomach; C, the transverse colon; E, the duodenum; P, the pancreas; I, the small intestine; B, the rectum; 1, the urinary bladder; 1, the anterior, and 2, the posterior layer of peritoneum; 4, the lesser omentum; 6, the greater omentum; 7, the transverse mesocolon; 5, the mesentery encircling the small intestine; 11, the vesical fold; 12, the anterior layer traced upwards upon the internal surface of the abdominal wall to the point (1) at which the examination commenced.—From Wilson's *Tomist's Vade-mecum*.

transverse, and descending meso-colon, and the meso-ventricular. (The mesentery and transverse meso-colon are shown in the figure.) Lastly, there are folds termed *Omenta*, which proceed from one viscus to another. They are three in number—viz., the *Greater* or *Gastro-hepatic Omentum*, which extends from the under-surface of the liver to the lesser curvature of the stomach (No. 4 in fig.); the *Gastro-splenic Omentum*; and the *Great* (or *Gastro-colic*) *Omentum* (Nos. 5 and 6 in fig.), which consists of two layers of peritoneum, the two which descend from the stomach, and the same two returning upon themselves, and ascending as high as the transverse mesocolon, where they separate, and enclose that organ.

The separate layers may be easily seen in the child, but in the adult they are more or less blended. The great omentum always contains a large quantity of adipose tissue, which, in persons inclined to obesity, often accumulates to an enormous extent. Its use appears to be (1) to protect the organs from cold by covering them anteriorly as with an apron, and (2) to facilitate their movement upon each other during their vermicular

movements. All the serous membranes, the peritoneum included, are liable to inflammation from various exciting causes. This inflammation is termed Peritonitis



to be confounded by the well-educated practitioner is a peculiar form of hysteria; but the age and sex of the patient, the presence of hysteria in other forms, and the general history of the patient and of her symptoms, will almost always lead to a correct diagnosis of the disease.

The treatment, in an ordinary case of peritonitis (not arising from mechanical injury, or perforation from disease, or occurring in connection with puerperal fever), consists, if the patient is moderately robust, in bleeding from the arm, till a decided impression has been made on the circulation; after which the abdomen should be covered with twenty or thirty leeches, and the bleeding from their bites should be encouraged by fomenting the belly with flannels wrung out of hot water, or, if the patient can bear its weight, by the application of a light poultice. The system must, at the same time, be got as speedily as possible under the influence of mercury, by the means described in the treatment of Pericarditis (q. v.). Opium may be given freely, not merely to guard against the purgative action of the calomel, but with the view of securing sleep to the patient, and quiet to the inflamed membrane. The patient must be kept on low diet, unless indications of sinking appear. In peritonitis from perforation, the only remedy is opium, which must be given in large and repeated doses, so as to keep the bowels perfectly at rest, in order to promote the formation of adhesion, by which alone the patient can be possibly saved. For the same reason, perfect rest must also be insisted on, and even drinks forbidden, thirst being allayed by the application of ice to the tongue.

*Chronic Peritonitis* occurs in two forms, which differ in their origin and degree of fatality, but are very similar in their symptoms. In the first, the inflammation is of the ordinary character, and although the disease sometimes originates spontaneously, it is more frequently the sequel of an imperfectly cured acute attack; in the second, it depends upon granules (supposed by Louis and most writers to be tubercles) lying in countless numbers in the serous membrane, and serving as a constant source of irritation. The second form is confined almost, if not entirely, to persons of a scrofulous constitution.

The symptoms of chronic peritonitis are more obscure than those of the acute form. There is abdominal pain, often slight, and not always constant, which is increased by pressure, or sometimes is felt only when pressure is made. The patient complains of a sensation of fulness and tension of the belly, although its size is not visibly increased; of a loss of appetite; and of nausea and vomiting; and the bowels are usually more or less out of order. After a time, the abdomen enlarges, and becomes tympanitic, or more or less filled with fluid; and death gradually ensues from debility and emaciation, unless the fatal issue is accelerated by an acute inflammatory attack.

It is not always easy to determine, during life, whether the disease belongs to the first or second form. When its origin cannot be traced to a preceding acute attack, to local abdominal injury, or to chronic affections of the abdominal viscera, there is strong reason to believe it to be of the granular, or, as it is commonly called, the tubercular form, especially if the general constitution and the hereditary tendencies of the patient point in the same direction.

Little can be done in the way of treatment, especially in the tubercular form, further than mitigating the most distressing symptoms, and possibly retarding the final issue. The frequent application of a few leeches to the abdomen, followed

by warm poultices, occasional blisters, and, as to the bowels, which, if costive, should be kept open upon by gentle laxatives, and a mild, but unstimulating diet, are more likely to be of service than remedies of a more energetic nature.

**PERIWINKLE** (*Littorina*), a genus of opodous molluscs of the order *Pectinibranchia*, family *Littorinida*, having a proboscis-shaped siphon, a foot of moderate size, a single gill, and a siphonal canal; the shell turritiform, with few whorls, and no nacreous lining; the aperture of few whorls. A very well-known species is the COMMON P. (*L. littorea*), a snail-like mollusc, most abundant on rocky parts of the British coast, living in the lowest zone of sea-weeds between the low water marks, and feeding on fuci, &c. It is one of the most common molluscs collected and sold for food. Children are generally employed in collecting it. It is boiled in the shell, and so sold in the streets, and chiefly to the poorer classes, where few molluscs are more pleasant. It is estimated that 1900 tons, value £15,000, are annually consumed in London alone. It is called *Whelk* or *Whulk* in Scotland, but is quite different from the *Whelk* (q. v.) of the English, notwithstanding the sameness of name. Other species, *L. rudis* and *L. rudis*, are common on all rocky parts of the British coasts, but are less esteemed. *L. littorea* is viviparous, and the shells of the young with the mantle of the parent often make it quite unpleasant to eat.

**PERIWINKLE** (*Vinca*), a genus of plants of the natural order *Apocynaceae*, having a 5-cleft corolla, a salver-shaped corolla bearded at the throat, and five obliquely truncated segments. The leaves are opposite and evergreen; the flowers grow in pairs from the axils of the leaves. The SMALL P. (*V. minor*), a native of many parts of Europe, and of the southern parts of Britain, grows in woods and thickets, is a half-shrubby plant with trailing stems, rooting at their extremities, lanceolate leaves, and pale-blue—sometimes reddish-purple—salver-shaped flowers. The GREATER P. (*V. major*), which has much larger flowers and ovato-cordate ciliated leaves, is native of the south of Europe, and is found in a few places in the south of England. Both of these species are very commonly planted in shrubberies and flower gardens, and rapidly cover unsightly objects with pleasing foliage, and produce their beautiful flowers at all seasons of the year, even in winter weather is mild. The HERBACEOUS P. (*V. herbacea*), a Hungarian species, is remarkable for the size and beauty of its flowers. The YELLOW P. (*V. flavida*), a native of the southern parts of North America, is a very common greenhouse plant. The ROSE-COLOURED P. (*V. rosea*), a native of Madagascar, is a favourite greenhouse plant.—The name *Periwinkle* was formerly applied to the P. was formerly *Periwinké*. Chaucer speaks of 'fresh periwinké rich of hue.' It is probably derived from the French *pervenche*, and that from the Latin *perwincula*.

**PERJURY** is the crime committed by a witness when giving evidence on oath as a witness in a court of justice, or before some constituted authority, of the same kind, gives evidence which he knows to be false. But in order to make the giving of false evidence liable to criminal punishment, it must be not only false to the knowledge of the witness, but the matter must have been material to the issue raised. If the falsehood occurred as to some immaterial fact, no crime is committed. If, however, it is necessary, in proving the crime, to prove that at least two persons should be able to testify to the truth of the matter, so that there might be a majority of oaths on the matter—there be two oaths to one. But this rule is satisfied

**PERKIN WARBECK—PERMIAN, MAGNESIAN LIMESTONE.**

witnesses do not testify to one point. The jury must also have taken place before some tribunal which had power to administer the law. See OATH. Though in some courts affirmations are allowed instead of oaths, yet the punishment for false affirmation is made precisely the same as for false swearing. The punishment for perjury before the Conquest, sometimes death or cutting the tongue; but latterly, it was confined to fine and imprisonment, and at present the latter is the punishment, with the addition of hard labour. Crime of Subornation of Perjury—i. e., the leading or procuring a person to give false evidence, is also punishable as a distinct offence.

**PERKIN WARBECK.** See HENRY VII.

**PERM,** the most eastern government of European Russia, is bounded on the E. by Siberia, and on the N., and S. by the governments of Vologda, Yaroslavl, and Orenburg respectively. Area, 128,623 square miles—more than twice the area of England and Wales. Population, 2,117,945. It is divided by the Ural Mountains into two unequal parts, of which the smaller portion is on the eastern or Asiatic side of the mountains, although, for administrative purposes, it is reckoned as a part of European Russia. About three-fourths of the government are occupied by the Ural range, which in some places reaches the height of 4000 feet; but the slope so gradually toward the plain, that the traveller reaches their summit before he is aware he has made any unusual ascent. About three-fourths of the entire surface, comprising all the northern districts, are covered with forests, the remainder of the area is in meadows, and about the same extent is under cultivation. The more important rivers belong to the systems of the Volga and the Obi. The Kama, together with the Tshousovaia and other affluents from the Ural Mountains, flow westward, join the Volga, and thus form an important means of communication between the two great districts of P. and Europe. The Tura, the Tobol, and the Losva communicate with the Obi; access is opened up to the White Sea and the Arctic Ocean by the rivers Dwina and Petchora. The climate is healthy, though somewhat rigorous. In the end of July, the nights are cold; in the middle of September, falls the first snow. In November, when the whole face of nature is covered with snow, the transport of goods by sledges is carried on everywhere. In January, the cold is so great that quicksilver sometimes freezes. At the end of March, the snow begins to melt, and in the middle of May, although the cold is still great, the country is clothed in the green of spring. The chief products are gold, copper, magnetic iron ore, rock-crystal, jasper, agate, topaz, emerald, sapphire, malachite, porcelain clay, salt (obtained from salt springs), coal, alabaster, marble, &c., and diamonds in small quantities. The inhabitants are chiefly Russians, but there are also numbers of Bashkirs, and Finns. The agricultural produce of the government, consisting chiefly of corn, wheat, flax, and hemp, is more than sufficient for consumption, and is exported to some extent to the neighbouring governments. The immense forests of the country yield wood for fuel, and timber for the construction of the barges which, in summer, are floated down the rivers, freighted with the products of the mines. In 1861, the number of works and manufactories in the government amounted to 1383, and employed 100,000 men. Their produce amounted to £6,000,000 in value, of which the value of the iron was £2,000,000, that of copper and gold was £200,000 each, and also, is a platina mine, said on good authority

to be the richest in the world. The iron of P. is famous over Europe. The commerce of the government is important. The fair of Irbit (q. v.) is, after that of Nijni-Novgorod, the most important in the Russian empire. The transit trade, however, is much more considerable than the local trade. The great highway from Siberia to European Russia passes through P., and the government communicates by means of the Volga, Petchora, and the Obi, with the Baltic, White, and Caspian Seas. The central administration of mines has its seat in Ekaterinburg.

The government of P. once formed a portion of the ancient Biarmia, inhabited in the earliest historical times by Finnish tribes, and even then famous for the commerce which it carried on, especially with Asia. In the 11th c., it became connected commercially with the principality of Novgorod, which, little by little, conquered and took possession of the country. At the close of the 15th c., both it and Novgorod were annexed to the territories of the Prince of Moscow, and about the same time the Christian religion was introduced.

**PERM,** a town of European Russia, capital of the government of the same name, on the Kama, 1357 miles east-south-east of St Petersburg. It was founded in 1729, under the name of the Egotinsky copper-work, and was the first colony in the government from which it derives its name. It is not in itself important for its commerce, but it is the seat of a most extensive transit trade. Here goods floated down the Tshousovaia from the Ural Mountains, are transferred to larger vessels, and forwarded by the Kama and Volga past Nijni-Novgorod and Rybinsk, and thence to St Petersburg. Goods from the sources of the Kama, metals, corn, tallow, and leathers, as well as articles of the Siberian and China trade, are also sent from P. to the Russian interior, and to Europe generally. At present (1864), a large steel foundry is in process of being built by government. Pop. 13,472.

**PERMIAN, MAGNESIAN LIMESTONE,** or DIAS group, is the lower division of the New Red Sandstone rocks, which were separated, chiefly on palæontological grounds, from the upper portion, and being, in 1841, without a collective name, were called Permian by Murchison, because he found them largely developed in that portion of Russia which composed the ancient kingdom of Permia, or Biarmia. The name Magnesian limestone is given to them because of the predominant deposit; and Dias has been proposed by some German geologists, to correspond with Trias, the name universally accepted for the upper section of the New Red Sandstone series.

The Permian strata occupy in Russia an area twice the size of France, and contain an abundant and varied suite of fossils. They are also largely developed in Germany, and as they have been there carefully studied, and described by numerous geologists, the rocks of that country may be considered as the types of the group. They have been thus grouped: 1. Bunterschiefer. 2. Zechstein. 3. Kupferschiefer or Mergel. 4. Rothe-todtliegende.

The Bunterschiefer consists of red and mottled marl and sandstone, which have been separated from the Triassic Bunter Sandstein, because of the occurrence in them of fossils which have a palæozoic facies. The Zechstein is chiefly a compact limestone with beds of coloured clays, and cellular magnesian limestone. The well-known Stinkstein belongs to this series; it is a dark-coloured and highly bituminous limestone, which gives out an offensive odour when struck or rubbed. The name Zechstein (literally, minestone) was given to these

beds, because they must be mined or cut through to reach the Kupferschiefer below. This latter is a marl slate, richly impregnated with copper pyrites, for which it was extensively wrought. It contains numerous beautifully preserved fossil fish belonging to the genera Palænicus, Cælacanthus, Platysorus, &c. The strange name of Rothe-todtliegende (red dead-layers) was given to a large deposit of red sandstone and conglomerate, by the miners, because the copper obtained from the beds above died out when they reached these red rocks.

The succession of rocks given by Murchison as occurring in Permian, are easily co-related with those of Germany. They are (1), conglomerates and sandstones, containing the remains of plants; (2), red sandstones and shales, with copper ore and vegetable remains; and (3), sandstones, grits, and fossiliferous limestones, with interstratified beds of marl and gypsum, the marls occasionally containing plants, and also seams of impure coal.

In England, the Permian rocks are somewhat extensively developed in Durham, where they have been described by Sedgwick and King. From this county, they continue in a narrow strip bordering the Carboniferous beds down the centre of England, until they are lost near Nottingham. In Cheshire, Shropshire, Stafford, and Warwick, they underlie the salt-bearing triassic rocks. The Durham strata are grouped as follow:

- |  |                     |
|--|---------------------|
| 1. Concretionary and amorphous limestone, . . . . .      | } = Bunterschiefer. |
| 2. Brecciated and pseudo-brecciated limestone, . . . . . |                     |
| 3. Fossiliferous limestone, . . . . .                    | } = Zechstein.      |
| 4. Compact limestone, . . . . .                          |                     |
| 5. Marl slate, . . . . .                                 | } = Kupferschiefer. |
| Inferior various-coloured sandstone, . . . . .           |                     |

The fractured bones and teeth of saurians found in the basement bed of the sixth group, were considered the earliest evidence of the existence of reptiles, until the discovery of the Archegosaurus in the Carboniferous rocks.

The known organic remains of this period are neither remarkable nor abundant. Many palæozoic forms became extinct within this period; among them are the remarkable Sigillaria and the Neuropteris of the coal-beds, the well-known brachiopod, Producta, and several genera of heterocercal-tailed fish. Some new forms appear, the most important of which are the labyrinthodont reptiles, which, though beginning in the upper Carboniferous beds, increase in number in the Permian, and reach their maximum development in the succeeding Triassic group.

**PERMUTATIONS AND COMBINATIONS.**

A combination, in Mathematics, is a selection of a number of objects from a given set of objects, without any regard to the order in which they are placed. The objects are called elements, and the combinations are divided into classes, according to the number of elements in each. Let the given elements be the four letters *a, b, c, d*; the binary combinations, or selections of two, are *ab, ac, ad, bc, bd, cd*—six in all, the combinations of three are *abc, abd, acd, bcd*—four in all; while there is only one combination of four, namely, *abcd*.

Permutation, again, has reference to the order of arrangement; thus, the two elements, *a* and *b*, may stand *ab* or *ba*, so that every combination of two gives two permutations; the three elements, *a, b, c*, and *c*, may stand *abc, acb, bac, bca, cab, cba*, one combination of three thus affording six permutations. The combinations of any order with all their permutations are called the *Variations*. Formulas are given in works of algebra for calculating the

number of permutations or combinations given case. Suppose seven lottery-tickets 1, 2, 3, to 7, and that two are to be drawn asked, how many possible pairs of numbers are, this is a question of the number combinations of seven elements, *two* together is found to be 21. If we want to know many times the same seven persons could be taken together with a different arrangement each time, this is to ask how many permutations seven objects admit of, and the formula  $7 \times 6 \times 5 \times 4 \times 3 \times 2 = 5040$ . The probabilities is founded on the laws of combinations. Thus, in the case of drawing two tickets seven, since there are 21 possible pairs, the probability of drawing any particular pair is  $\frac{1}{21}$ , or  $\frac{1}{7}$ . In working out questions in 'combinations,' advantage is often taken of the fact, whatever number of elements be taken from to form a combination, the number left gives the same number of combinations; thus the number of combinations of 10 elements *three* together is the same as that of 10 elements *seven* together,

**PERN.** See HONEY BUZZARD.

**PERNAMBUCO**, the most eastern state of Brazil, stands at the mouths of the Biboca, Capeberibe, in lat. 8° 4' S., long. 34° 52' W., south of Parahiba. It is the greatest sugar-producing state of the empire. It consists of two portions, connected by roads and bridges, the chief seat of commerce, on a peninsula, Antonio, the middle district, on an island, and the peninsula and the mainland; and Bahia on the mainland. The inner harbour, with a depth of from 10 to 30 feet, is formed by a reef which extends along the coast at a distance of from a quarter to half a mile from the shore. This reef serves the purposes of a breakwater. Opposite the northern extremity of the city is an opening in the reef, resembling a cut, and forming a passage of sufficient width to admit of the entrance of vessels drawing 12 feet of water. No port is more easily accessible than the outer harbour of Pernambuco. There is a light in the harbour, and it is defended by several batteries. Formerly, the city was extremely dirty, the streets unpaved, and much inconvenience was suffered from want of a proper supply of water. Of late years, however, many improvements have been effected; water-works have been erected, and spacious quays formed along the margins of the rivers, and the streets have, in most instances, been paved and lighted. Numerous colleges and educational institutions have been established, and the growing wealth and commercial prosperity of the city has been accompanied by an increase in the degree of comfort and refinement. The principal exports are sugar, cotton, rum, hides, and dyestuffs. In 1859, 654,642 tons of sugar were exported, and imports are woollen and cotton cloths, hats, silks, wines, and flour. Pop. from 80,000 to 100,000.

**PERNAMBUCO**, a maritime province of Brazil, is bounded on the south-east by Bahia and on the north-west by Piauhí, Ceará, and Parahiba. It contains 61,068 square miles, and has a population of 950,000. The coast is fringed with coral reefs, which render navigation dangerous. The chief river is the San Francisco, which forms the southern boundary, and the greater portion of the area of the province is in its basin. The banks of this river are many rich, expansive meadows, and here tobacco is reared which, in the form of bales, hides, form an important article of export.

PERNAMBUCO WOOD—PERPENDICULAR FORTIFICATION.

port of Pernambuco. Much of the cotton and sugar brought to the market of the capital is reared about 300 miles inland, in regions fertilized by streams that rise at the base of the Santa Barbara Hills, the first hill-range in this district that arrests the trade-wind from the Atlantic, laden with rain. From the capital to Joazeiro, a distance of about 400 miles, across a district covered with valuable sugar-plantations, a railway is in course of construction in 1861. The province comprises immense tracts of rich and fertile soil, productive in sugar-cane, cotton, maize, fruits, vegetables, and medicinal herbs. From the forests, gums, and dye-woods are obtained.

PERNAMBUCO WOOD. See BRAZIL WOOD.

PERNOW (Germ. *Pernau*), a seaport of the Baltic Provinces, Russia, in the government of Livonia, stands on a sandy heath at the mouth of a river of the same name, on the Gulf of Riga, 102 miles north of the port of Riga, and 350 miles west-west of St Petersburg by sea. The mouth of the river is so shallow that large vessels are obliged to anchor in the roads. The exports are chiefly flax, linseed, corn, and timber; the principal imports are salt and herrings. In 1859, 204 vessels, 29,356 tons, entered and cleared the port. Pop. 4,000.

PERPENDICULAR. A straight line standing at right angles to another straight line is said to be perpendicular to that other when the angles it makes on both sides are equal (see ANGLE). A line is said to be perpendicular to a plane when it is at right angles to any line in that plane meeting it. Planes are said to be perpendicular to each other when any line in one plane perpendicular to their common line of intersection is also perpendicular to all lines lying in the other plane.

The word 'perpendicular,' in common usage, refers to a direction at right angles to the surface of still water, and is synonymous with vertical.

PERPENDICULAR, the name given to the style of Gothic architecture in England which succeeded the Decorated Style. It prevailed from about the middle of the 14th c. to the middle of the 16th c., and thus contemporary with the Flamboyant Style in France. These styles have much in common, and they derive their names from the features peculiar to each. Thus, the Flamboyant (q. v.) is distinguished by the flowing lines of its tracery; but the Perpendicular is remarkable for its stiff rectilinear lines. The lines of the window-work are chiefly vertical, and the mullions are usually crossed by horizontal bars. The mouldings are usually thin and hard. The same feeling pervades the other features of the style; the pinnacles, piers, towers, &c., are all drawn up and unadorned, and present in their shallow recesses a meagre lines a great contrast to the deep shadows and bold mouldings of the earlier styles. The art of masonry was well understood during the Perpendicular period, and the vaulting was admirably built. Fan-tracery Vaulting (q. v.) belongs to this style. The depressed or four-centre arch is one of its peculiar features. This arch, over doorways, has the mouldings generally arranged in a square form over the arch, with spandrels containing shields, quatrefoils, &c. Panelling was also much used, the walls being frequently almost entirely covered with it, as in Henry VII.'s Chapel at Westminster. There are many well-known buildings of this style. Most of the colleges at Oxford and Cambridge belong to it, and in almost every cathedral and church of importance, there are some specimens of it. Open timber-roofs are

very common in the Perpendicular Style, and are amongst the peculiar and beautiful features of the



Nave of Winchester Cathedral.

architecture of this country. The roof of Westminster Hall, built by Richard II., is the largest example ever erected.

PERPENDICULAR FORTIFICATION owes its origin to the Marquis de Montalembert, a distinguished French general, who published his work upon the subject in 1776. Vauban had, it was admitted, rendered the art of attack superior to that of defence. Montalembert strove to reverse this relation, and, in his endeavours, rejected entirely the bastion system of the older engineers. Instead of the occasional bastions, with intervening curtains (see FORTIFICATION), with which they surrounded their *enceinte*, he broke the whole polygon into salient and re-entering angles, the latter being generally right angles. Before the connected redans thus formed were counterguards of low elevation and ravelins, to which the approaches were through casemated *caponnières*. In the salient angle of each redan, he built a brick tower, 40 feet in diameter, twelve-sided, and four stories high. The second and third tiers were built for heavy guns, and the upper loopholed for musketry. In the centre of the tower was a circular *réduit*, intended as a last refuge for the garrison. Montalembert maintained that from

these towers every possible approach could be commanded, which to a great extent is true; but it must be also remembered that the greater space a gun commands, by so much the more is it raised above the plain, and rendered visible. These towers would have little chance against the rifled ordnance of the present day. Montalembert's system was violently attacked by the French engineers, but Carnot subsequently adopted it, with some modifications, and it enters largely into the modern German defensive works. The system has never, however, found favour with British engineers.

**PERPETUAL CURE**, a form of ecclesiastical benefice which grew out of the abuse of lay Impropriation (q. v.), the impropriator appointing a clergyman to discharge the spiritual functions of which he himself was not capable. The substituted clergyman, in ordinary cases, is appointed by the bishop, and called a vicar; but when no provision is made for a vicar, the impropriator appoints the clergyman, who is called a perpetual curate. The perpetual curate enters on his office without induction or institution, and requires only the bishop's licence. Perpetual cures are also created by the erection and endowment of a chapel subject to the principal church of a parish. Such cures, however, are not benefices, unless endowed out of the fund called Queen Anne's Bounty. Churches so endowed are, by 2 and 3 Vict. c. 49, recognised as benefices. The district churches which have been erected under several recent acts are made perpetual cures, and their incumbents are corporations.

**PERPETUAL MOTION, THE** According to Newton's First Law (see MOTION, LAWS OF), all unresisted motion continues for ever unchanged. Thus, if friction could be avoided, a top or a gyroscope spinning in vacuo is an instance of motion which would be unchanged for ever, and which, therefore, might be called perpetual. The motion of the sun in space, the earth's rotation about its axis, and numerous other common motions, are in this popular sense perpetual. [It is necessary to remark here, that even these motions are subject to retardation; for instance, those of the bodies of the solar system, by the resistance of the luminiferous medium, which we know to be matter, and which fills all space. This was remarked by Newton himself, for he says, 'the larger bodies, planets and comets, preserve their motions longer (than terrestrial objects), because they move in less resisting media.' The same cause influences the motion of the gyroscope, but in its case there is another retarding influence at work, due to the production of electric currents by the magnetism of the earth.] But this is not what is technically understood by the title *The Perpetual Motion*. It means an engine which, without any supply of power from without, can not only maintain its own motion for ever, or as long as its materials last, but can also be applied to drive machinery, and therefore to do external work. In other words, it means a device for creating power or energy without corresponding expenditure. This is now known to be absolutely impossible, no matter what physical forces be employed. In fact, the modern physical axiom, the Conservation of Energy, (see FORCE), founded on experimental basis as certain as those which convince us of the truth of the Laws of Motion, may be expressed, in the negative, thus: *The perpetual motion is impossible.* Helmholtz's beautiful investigations regarding Conservation of Energy (referred to in FORCE), are founded on this axiom. So is the recent application, by Clausius, of Carnot's remarkable investigation of the 'Motive-power of Fire' to the true Theory of Heat. Other instances will be mentioned at the end of the article.

The complete statement of the impossibility of procuring the perpetual motion with the ordinary mechanical arrangements, in which it was most commonly sought, is to be found in the *Principia* (q. v.), as a deduction from Newton's Third Law of Motion. The equivalent principle of Conservation of Energy is there stated in a manner which leaves nothing to be desired; although not given in anything like the modern phraseology. Yet it is usually said, in works on the Perpetual Motion, that De La Hire (in 1678) gave the first proof of its impossibility in ordinary mechanics. This proof, published long after Newton's, is by no means so complete, as it exposes only some of the more patent absurdities which had been propounded for the solution of the problem. It is certain, and worthy of particular notice, that Newton was far in advance of the greatest of his contemporaries and their immediate successors, in even the fundamental notions of mechanics. Thus, we find John Bernouilli seriously propounding a form of the perpetual motion, depending upon the alternate mixture, and separation by a filter, of two liquids of different densities; an arrangement which is as preposterous as the very common suggestion of a water-wheel which should pump up its own supply of water; and whose absurdity must be evident to any one acquainted with Newton's chapter on the Laws of Motion.

It is curious that, long before Newton's time, the physical axiom, that the perpetual motion is impossible, was assumed by Stevinus as a foundation for the science of Statics. This is particularly interesting when we compare it with the magnificent discoveries which have been evolved in our own day from the same principle applied to the physical forces generally, and not to gravitation alone, as contemplated by Stevinus. His process is as follows: Let an endless chain of uniform weight be passed round a smooth triangular prism ABC, of which the face BC is horizontal. The free portion of the chain BDC will hang in a symmetrical curve (CATENARY, q. v.), and its tension will therefore be the same at B and at C. Hence the other portion BAC of the chain will be free to move, unless the resolved part of the weight of AB, acting down the inclined plane AB, just balance that of the corresponding portion of the chain down AC. If these balance, the parallelogram of forces is proved; if not, one side will preponderate, and we shall evidently obtain the perpetual motion.

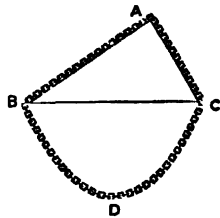

We will briefly sketch the history of the simpler part of the problem, where mechanical and hydrostatical arrangements alone are contemplated, and where the impossibility of procuring the perpetual motion had been completely shewn by Newton.

The leading features of the various devices suggested as self-moving engines are three: 1. The machine being a combination of mechanical powers driven by weights, was to be constructed so as constantly to wind up those weights as they fell, and therefore to be constantly in the same circumstances as to power in each successive complete revolution. The ideal of this, in its simplest form, is that of a wheel moving about a horizontal axis, and so adjusting certain heavy sliding pieces on its surface, as to have always a preponderance on one particular side. 2. The type of the second class differs from that of the first only in the substitution of liquids for the weights in the first class, and the consequent introduction (often in most extravagant forms) of

PERPETUAL MOTION.

hydrostatical laws, which the inventors seem to have considered less certain and more pliable than the stern facts of common mechanics. 3. The machine depends on some natural power, such as rain, change of temperature, wind, fluctuations of the barometer, tides, &c. The consideration of this third class is very interesting, but we will defer it for a little.

Of the first class, the only machines that seem ever to have succeeded in permanently deceiving any but their inventors are those of the Marquis of Worcester and of Councillor Orffyreus. Contemporary with the former was Bishop Wilkins, who candidly and ingeniously points out the fallacies of various devices of his own, depending severally on weights, on magnets, and on Archimedes's screw. His first attempt seems to have been closely allied to that of the Marquis of Worcester, of whose engine we have no drawing, and only a very vague description. The following figures give us, however, some

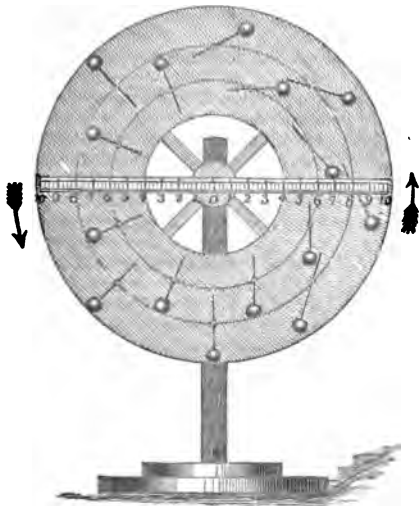

Bishop Wilkins's First Form.

notion of its probable nature. The first is one of Wilkins's, the second that of Jackson, the third that

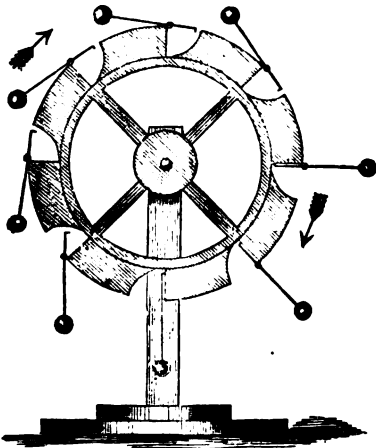

Jackson's Perpetual Motion.

of Merlin. Their construction is evident from the figures.

In all three, the attempt is by the sliding of the balls in their cells, or by the turning of the levers to give the preponderance to the descending side of

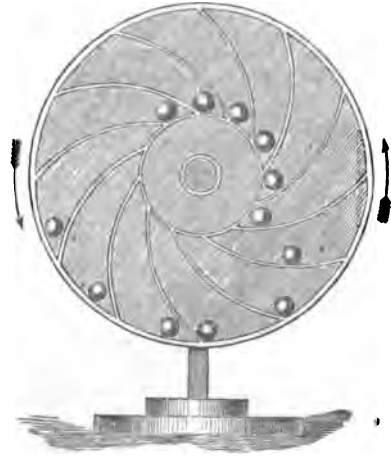

Merlin's Perpetual Motion.

the wheel. But even the cuts shew that, though the weights on the descending side are on the whole further from the axis of the wheel than those on the ascending side, yet there are more balls on the latter than on the former side; and a careful examination, like that made by Wilkins, shews that their moments in opposite directions about the axis balance each other. With reference to the invention of the Marquis of Worcester—who is otherwise well known as one of the first to foresee, and even in part to realise experimentally, the advantage of steam as a motive-power—we find the following in his *Century of Inventions*: 'An Advantageous Change of Centers.—To provide and make that all y<sup>e</sup> weights of y<sup>e</sup> descending syde of a wheele shal be perpetually further from y<sup>e</sup> center, then those of y<sup>e</sup> mounting syde, and yett equal in number and heft of y<sup>e</sup> one syde as y<sup>e</sup> other. A most incredible thing if not seene, butt tryed before y<sup>e</sup> late King of happy and glorious memorye in y<sup>e</sup> Tower by my directions, two Extraordinary Embassadors accompanying his Ma<sup>ty</sup> and y<sup>e</sup> D. of Richmond, D. Hamilton, and most part of y<sup>e</sup> Court attending him. The wheele was 14 foote ouer, and 40 weights of 50 p<sup>ts</sup> apiece; S<sup>r</sup> Wm. Belford, then Lieu<sup>t</sup> of y<sup>e</sup> Tower, and yett liuing can justify it with seuerall others; They all saw that noe sooner these great weights passed y<sup>e</sup> Diameter Line of y<sup>e</sup> vpper syde but they hung a foote further from y<sup>e</sup> center, nor no sooner passed the Diameter Line of the lower syde, butt they hung a foote nearer; bee pleased to judge y<sup>e</sup> consequence.'

The machine of Orffyreus, by which 'S Gravesande was completely taken in, so much so that he wrote to Newton expressing his belief that the perpetual motion was really found, consisted of a large wheel or drum covered with canvas, to prevent the interior from being seen, and rotating about a thick horizontal axle. This machine, when set agoing in either direction, moved with accelerated speed till it reached a rate of twenty-five turns in a minute; and on one occasion was sealed up by the Elector of Cassel for two months, and at the expiration of that time found to be moving as rapidly as ever. This, like the celebrated automaton chess-player, was evidently a case of clever imposition; and but for its strange effect

\* See Harleian MS., No. 2428, in the British Museum.

## PERPETUAL MOTION.

on 'S Gravesande, would probably have been forgotten long ago. Tricks of this kind, more or less ingenious, such as that of Spence of Linlithgow (1818), which many of our readers may recollect, are still common, especially in America.

Bishop Wilkins's third form is a good example of the second class of contrivances above mentioned. Its construction will be readily understood

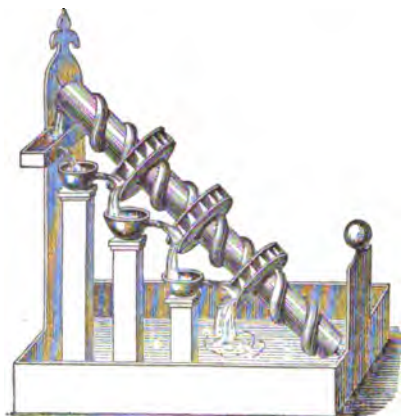

Bishop Wilkins's Third Form.

from the annexed cut. The water-wheels, driven by the descending water, are intended to turn the Archimedean screw, so as constantly to replenish the tank above. Wilkins's calm investigation of the reasons why his device will not succeed, is very interesting and creditable.

As a contrast, let us take a case of special absurdity, that of Norwood. In the figure, it is supposed that, as the weight of the water or



Norwood's Perpetual Motion.

mercury in the large vessel immensely exceeds that in the neck, it will preponderate, and drive the liquid through the spout into the vessel again; thereby furnishing, not only an admirable perpetual motion, but a conclusive disproof of one of the fundamental laws of Hydrostatics.

The second of Wilkins's cases is an instructive one. It depends on magnetism, and will be readily understood from the cut. AB is a loadstone, which draws the iron ball C up the inclined plane to E, where there is a hole through which the ball falls down the curved incline, pushes open a trap at F, and is dragged again up the plane by the loadstone. The error of this is the neglect of the action of the loadstone on the falling ball. There would be an admirable case of the perpetual motion if we could

remove or annihilate (without expenditure of work) the action of the loadstone during the descent. Unfortunately, the law of magnetic attraction is the

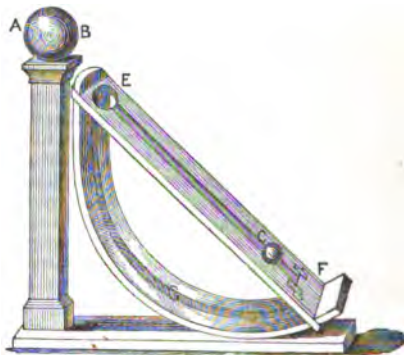

Bishop Wilkins's Second Form.

same as that of gravitation, and what is impossible with the one, must be equally so with the other. A good illustration of this is Addeley's Perpetual Motion, represented in the annexed sketch. The spokes projecting from the wheel are magnets, whose south poles are all turned from the centre. These are attracted by the north poles (N), and

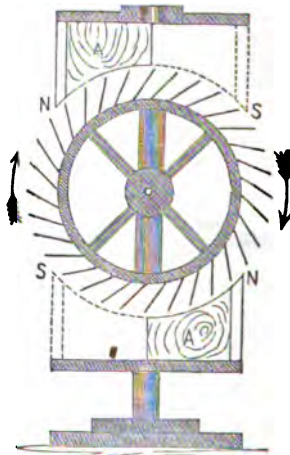

Addeley's Perpetual Motion.

repelled by the south poles (S) of four fixed magnets; and blocks of wood (A) are interposed, to prevent magnetic action where it would tend to stop the machine! If it were possible to find a substance which would deal with gravitation or magnetism as an opaque body does with light (casting a shadow), the perpetual motion would be obtained with the greatest ease.

It would be tedious and unprofitable to go through the various physical forces, shewing how a misconception of their laws has led to hundreds of patented schemes for the production of perpetual motion. We may merely hint at magneto-electric machines turned by electro-magnetic engines, to which they supply the electric currents; electric machines, driven by a gas-engine, the fuel for which is supplied by the decomposition of water by the electricity produced, &c.; and the absurdity of all of which may be imagined from the perfectly analogous case of a steam-engine to which heat might be supposed to

be supplied by the friction of bodies driven by the engine itself. An excellent example of this absurdity is furnished by the writings of one of our ablest geologists. He considers that the internal heat of the earth may be due to chemical combination, that the heat so produced may develop thermo-electric currents, and that these in their turn may decompose the compounds formed, so that the process may go on indefinitely.

But the third class of attempts above described merits a few words. It certainly does *not* give the perpetual motion, but it is capable of furnishing prime-movers which will work uninterruptedly for perhaps hundreds of thousands of years. This is done, however, as we should expect, at the expense of other stores of energy in the universe. Thus, the tide-wheel, or tidal engine, a little-used but most effective source of power, derives its energy entirely from the earth's diurnal rotation. Engines driven by collected rain-water, such as mill-wheels, &c., and others driven by power stored up from winds, &c., depend upon energy radiated from the sun, mainly in the form of heat. None of these can, therefore, in strictness be called the perpetual motion, since the energy of the earth's rotation, or of the sun's heat, is drawn upon in their production.

But the complete proof of the impossibility of procuring the perpetual motion by any arrangement whatever, involving any known forces, was arrived at mainly by the experiments of Joule (q. v.), who shewed that the principle of the Conservation of Energy extends, not alone to the forces for which it was enunciated by Newton, but to every known form of physical action. The date 1840—1845 may thus be said to have finally settled this long-disputed question; at all events, until new forms of physical forces may happen to be discovered; and we are now in a position to do generally, what was wisely done by the French Academy in 1775 for ordinary mechanical contrivances alone—viz., refuse to consider any scheme whatever which pretends to give work without corresponding and equivalent expenditure. The language in which this decision of the French Academy is recorded (*Histoire de l'Académie*, 1775) is well worthy of being quoted, for its calm scientific clearness and brevity, and for its present applicability to physical science in general: 'The construction of a perpetual motion is impossible. Even if the effect of the motive-power were not in the long run destroyed by friction and the resistance of the medium [in which the motion takes place], this power could produce merely an effect equivalent to itself. In order, therefore, to produce a perpetual effect from a finite cause, that effect must be infinitely small in any finite time. Neglecting friction and resistance, a body to which motion has been given will retain it for ever; but only on condition of its not acting on other bodies, and the only perpetual motion possible, on this hypothesis (which, besides, cannot occur in nature), would be useless for the object which the devisers of perpetual motions have in view. This species of research has the inconvenience of being costly; it has ruined many a family; and numerous mechanics, who might have done great service, have wasted on it their means, their time, and their talents.'

'These are the principal motives which have led the Academy to its decision. In resolving that it will no longer notice such speculations, it simply declares its opinion of the uselessness of the labours of those who are devoted to them.'

It has been asserted that the infatuation of the perpetual motionists, who (as may be seen by a glance at the specifications of patents in Britain, France, Belgium, America, &c.) are perhaps more numerous now than ever is due to two causes—

one, the idea that the perpetual motion is a lost but recoverable invention; the other, that some immense government reward has been for years laid aside for the successful discoverer. But, unhappily, these ideas are as fallacious as the grand delusion itself; and any one who, in the present state of science, allows himself to be carried away by this fascinating inquiry, loses his time and wastes his talents, more hopelessly than even a 'squarer of the circle.'

In conclusion, we may mention a few of the cases already hinted at, in which the impossibility of the perpetual motion formed the basis of an investigation. These will shew the great use which may be made of even a negative proposition. Helmholtz has shewn from it that the ultimate particles of matter must exert upon each other forces, whose direction is that of the line joining each pair of particles, and whose magnitude depends solely on their distance. J. Thomson employed it to shew that the freezing-point of water is lowered by pressure, as otherwise work might be created by the freezing of ice-cold water. W. Thomson has employed it to shew that a diamagnetic (see DIAMAGNETISM) body does *not* take the opposite magnetism to iron, when in similar circumstances; for if it did, and if, like iron, it took time for the full development of the action, a perpetual motion might be produced.

The literature of this subject is very extensive, but scattered mainly through Patent Records and ephemeral pamphlets. The *Journal des Savants*, and Montucla's *Histoire des Mathématiques* may be consulted; but especially we would refer the curious reader to a recent work by Mr Dircks (of Patent-Ghost notoriety) entitled *Perpetuum Mobile* (Spon, London, 1861); to which we have been indebted for some of our historical notices. The tenor of the work is such that we cannot easily discover whether the author is a perpetual-motionist or not; but, however this may be, it is extremely complete and interesting as a history.

PERPETUITIES, LAW AGAINST, consists in a rule adopted in England to the effect that property cannot be tied up for a period longer than the lives of some parties already in existence, and 21 years more. Those who have the power of disposing of their property have often attempted to regulate the succession of their estate at distant periods. Such was the object of the original practice of entailing property, and so enforcing the devolution of property on a certain series of heirs to the remotest generations. This power of testators was always looked upon with jealousy, as tending to embarrass future dealings with the property, and frustrate the purposes for which property is established. So early as the reign of Edward IV., a decision was come to by the courts in Taltarum's case, which had the effect of allowing the first tenant in tail in remainder, on arriving at majority, to disentail the estate at discretion. Hence, in England, there has been ever since no mode of settling property in any way so as to tie it up beyond the life of the first who takes an estate of freehold, and the nonage of the tenant in tail next in remainder—i. e., the lives of persons in existence, and 21 years more. This principle applies not only to land, but to personal property. As to the accumulation of the income of property, an attempt was made by the late Mr Thellusson to create an immense fortune by directing the income of his property to be accumulated during the lives of all his children, grandchildren, and great-grandchildren, who were living at the time of his death, for the benefit of some future descendants, to be living at the death of the survivor. The probable amount of the accumulated fund was expected to be 19 millions. The will was in great measure



defeated by the existing law, but in consequence of so conspicuous an attempt, an act of parliament was passed, called the Thellusson Act (39 and 40 Geo. III c. 98), which in future forbids the accumulation of income for any longer time than the life of the grantor or settler, or 21 years from his death. In Scotland, so far from the above doctrines having been early adopted, the contrary doctrine was established. See ENTAIL.

**PERPIGNAN**, a town of France, and a fortress of the first rank, capital of the department of Pyrénées-Orientales, on the right bank of the river Tet, 5 miles from the Mediterranean, and 40 miles by railway south of Narbonne. It commands the passage by the Eastern Pyrenees from Spain into France, and is defended on the south by a citadel and by ramparts flanked with bastions, and protected by raised works. The works underwent a thorough repair in 1823, and P. now ranks as one of the first strongholds in France. Its appearance is exceedingly picturesque. From a distance, its houses are seen in the midst of a forest of orchards; and a closer examination shews a collection of narrow streets, covered with awnings; houses of semi-Moresque construction, with wooden balconies and courts, and other evidences of Spanish influence. The cathedral, a massive building, begun in 1324; the belfry of St Jacques and the Castiller (now used as a military prison), with its battlements and machicolations, give character to the town. P. contains barracks for 5000 men, a council-house, palace of justice, mint, a college, numerous schools, museums, and scientific societies. Good *vin ordinaire* (red) is grown in the vicinity; woollen cloths, playing-cards, leather, &c., are manufactured, and there is a good trade in wine, brandy, wool, and silk. Pop. 18,199.

P., as capital of the former county of Roussillon, remained long in the hands of the kings of Aragon, and in 1349, King Pedro founded a university here. In 1642, it was taken by Louis XIII.; and since that time, the town itself, together with the county of Roussillon, has remained in the possession of the French.

**PERRAULT, CHARLES**, a French writer, born at Paris, 12th January 1628, was the son of an advocate, and received a good education. In 1651, he became a member of the Paris bar, and obtained a considerable measure of success as a pleader; but having made the acquaintance of the minister Colbert, he was ere long diverted from the practice of his profession by receiving the appointment of Controller-general of the Royal Buildings. In 1671, the influence of Colbert procured for him an entrance into the French Academy, into which learned body he introduced several important reforms. What first made his name well known was his famous controversy with Boileau regarding the comparative merits of the ancients and moderns, which originated in a poem of P.'s, entitled *Le Siècle de Louis le Grand*, read before his confrères of the Academy, and intended to prove that modern authors were superior to Homer, Herodotus, Plato, Aristotle, Virgil, &c. It was followed up by an elaborate and methodically written *Parallèle des Anciens et des Modernes* (4 vols. 1638—1698), which, though an able and learned performance, is a complete failure in its logic. Boileau was his keenest opponent, and fiercely, not to say rudely, assailed him in his *Réflexions sur Longin*, to which P. replied with equal acrimony, but not with equal wit, in his *Apologie des Femmes* (1694). One good effect of this quarrel was to turn P.'s attention still more closely and critically to his contemporaries, the result of which was an admirable work, *Hommes*

*Illustres du Siècle de Louis XIV.*, containing critical biographies. But the work that is more than any other preserved his name is his *des Fées*, or Fairy Tales. See NOVELS. Theliveliness, and ingenious child-like fancy displayed in these charming compositions, are beyond praise, and when we remember that their work was far advanced in years when he wrote the feat seems miraculous. 'Second child' is not always so like the 'first,' as that of P. to have been. P. died 16th May 1703.

**PERRY**, an agreeable beverage made by fermenting the juice of pears. It is extensively sold in Worcestershire, Gloucestershire, Herefordshire, Devonshire, and forms, with cider, the chief drink of those districts. It contains from nine per cent. of alcohol. The best pears for perry are those which from their rough texture are least agreeable for eating.

**PERSEA**. See AVOCADO PEAR.

**PERSECUTIONS, THE TEN**, of the Christian Church, is the name by which are known in ecclesiastical history certain periods of special persecution exercised towards the rising community of Christians for the purpose of compelling them to renounce their new creed, and to conform to the established religion of the empire. The Christian community in all times regarded with suspicion and dislike by the Roman empire—the constitution of Rome being essentially intolerant of those new religions which, like the Christian, were directly antagonistic against the established religion of the state, and being particularly hostile to private associations and private assemblages for worship, such as those in which every Christian congregation by its nature presented; and thus there are various periods, during the first three centuries, in which can be said that the church enjoyed every complete immunity from persecution. The name is given particularly to certain periods in which either new enactments were passed against Christians, or the existing ones were enforced with unusual rigour. The notion of *ten* such persecutions is commonly accepted almost as an historical fact, and it is not generally known that this determination of the number is comparatively recent. In the 4th c., no settled theory of the number of persecutions seems to have been adopted; Eusebius reckons up but six; Eusebius does not state what the number was, but his narrative contains data for nine. Sulpicius Severus, in the 5th c., the first who expressly states the number to be ten, but he only enumerates nine in detail, completing the number to ten, he adds the persecution which, at the coming of Antichrist, is to precede the end of the world. The number ten as the number seems to have originated in a mystic allusion to the ten horns of the beast in the Apocalypse (xvii. 12).

It need hardly be said, however, that this is a question of words, the diversity of enumeration arising from the different notions attached to the several historians to the designation *general* persecutions taken quite strictly to comprise the entire empire, the number must fall below ten; if understood loosely of local persecutions, the number might largely increased. The ten persecutions commonly regarded as general are the following: the persecution under Nero, 64 A.D.; under Domitian, 81 A.D.; under Trajan, 107 A.D.; under Hadrian, 117 A.D.; under Marcus Aurelius, 165 A.D.; under Septimius Severus, 202 A.D.; under Maximinus, 235 A.D.; under Decius, 249 A.D.; under Valerianus, 257 A.D.; under Diocletian, 303 A.D. The extent and duration of some of these have been the subject of much controversy.

## PERSEPOLIS.

able controversy, and indeed an animated one was maintained for a long period as to the total number of victims in the pagan persecutions of the church. Such controversies are the scope of this publication. It is quite clear that there have been exaggerations on the one as well as on the adverse side; but it has been shown beyond the possibility of doubt, and the recent explorations have confirmed the argument, that the data on which the estimates of Gibbon, the most prominent advocates of the theory of the small number, were founded, are certain, and even fallacious; and that, not to the many victims of the constantly recurring violence, the number who fell in each of the repeated persecutions was both large in number and spread, in most cases, over a considerable part of the Roman empire. The most violent, as well as the most widely-spread of these persecutions, were those under Nero, Trajan, Maximinus, Decius, and Diocletian. The last-named, though called by his own name, was in reality far less the work of the emperor than of his colleague Galerius; but extremely cruel, and, with occasional intermissions, continued from the year 303 down to the death of Constantine over Maxentius—a period of nearly twenty years.

PERSEPOLIS (Persian City), the Greek translation of the lost name of the capital of ancient Persia (*Parsa-Karta?*), was situated on the river Bendemir, to the east of the river Medus (or River of Murghab), in the plain of Shiraz, about 35 miles to the north-east of

Shiraz, on the road to Ispahan. A certain number of most remarkable ruins is all that now remains of that city, with which, according to ancient writers, 'no other city could be compared either in beauty or in wealth,' and which was generally designated 'The Glory of the East.' Darius Hystaspes, Xerxes, Artaxerxes, and other Achæmenides, each in his turn contributed towards its aggrandisement. Alexander the Great, in his march of conquest, is said to have destroyed P. completely; but this must probably only be understood to apply to some of the chief palaces. It may also be presumed that after the fall of the Achæmenides, that extension of the original town (afterwards known, and important in history up to within a recent period, as Istakhar), on which were situated the royal edifices and temples used as the royal treasuries up to the time of Epiphanes, gradually fell into decay. The situation of these structures, overlooking the vast luxuriant plain of Merdust, is described in terms of rapturous enthusiasm by every traveller from Chardin to our own day. Three groups are chiefly distinguishable in the vast ruins existing on the spot. First, the Chehel Minâr (Forty Pillars), with the Mountain of the Tombs (Rachmed), also called Takht-i-Jamshîd or the structure of Jamshîd, after some fabulous ancient king, popularly supposed to be the founder of Persepolis. The next in order is Naksh-i-Rustam, to the north-west, with its tombs; and the last, the building called the Haram of Jamshîd. The most important is the first group, situated on a vast terrace of cyclopean masonry at the foot of a lofty mountain-range. The extent of this terrace

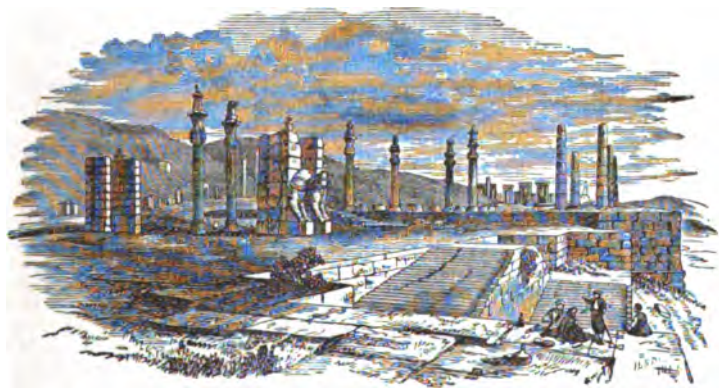

Ruins of Persepolis.

(Copied from Fergusson's *Palaces of Nineveh and Persepolis Restored*.)

is 500 feet north-by-south, and about 800 east-and it was, according to Diodorus Siculus, surrounded by a triple wall of 16, 32, and 60 feet respectively in height, for the triple purpose of strength, inspiring awe, and defence. The internal area is further divided into three terraces—the lowest towards the south; the central one a square, and rising 45 feet above the level of the lowest platform; and the third, the northern, about 550 feet above the level of the lowest platform, and 35 feet high. No traces of structures are to be found on the lowest platform; on the second, only the so-called 'Propylæa' of Xerxes; on the third, the northern platform seems to have been occupied by the most magnificent structures, which again, however, are conjectured to have stood on the same level as the first. The most distinguished here the so-called 'Great Hall' or 'Palace' (Chehel Minâr, by way of eminence), the Palace of Xerxes, and the Palace of Darius, one above the other in successive elevation on the ground. The stone used for the buildings

is dark-gray marble, cut into gigantic square blocks, and in many cases exquisitely polished. The ascent from the plain to the great northern platform is formed by two double flights, the steps of which are nearly 22 feet wide, 3½ inches high, and 15 inches in the tread, so that several travellers have been able to ascend them on horseback. What are called the Propylæa of Xerxes on this platform are two masses of stone-work, which probably formed an entrance-gateway for foot-passengers, paved with gigantic slabs of polished marble. Portals, still standing, bear figures of animals 15 feet high, closely resembling the Assyrian bulls of Nineveh. The building itself, conjectured to have been a hall 82 feet square, is, according to the cuneiform inscriptions, as interpreted by Rawlinson, the work of Xerxes, and reads as follows:

'The great god Auramajda, he it is who has given this world, and who has given life to mankind, who has made Xerxes king, both king and

lawgiver of the people. I am Xerxes the king, the great king, the king of kings, the king of the many-peopled countries, the supporter also of the great world, the son of King Darius, the Achaemenian.

'Says Xerxes the king, by the grace of Auramajda, I have made this gate of entrance; there is many another nobler work besides this Persepolis which I have executed, and which my father has executed;' &c.

An expanse of 162 feet divides this platform from the central one, which still bears many of those columns of the Hall of Xerxes from which the ruins have taken their name. The staircase leading up to the Chehel Minâr, or Forty Pillars, is, if possible, still more magnificent than the first; and the walls are more superbly decorated with sculptures, representing colossal warriors with spears, gigantic bulls, combats with wild beasts, processions and the like; while broken capitals, shafts, pillars, and countless fragments of buildings, with cuneiform inscriptions, cover the whole vast space of this platform, 350 feet from north to south, and 380 from east to west. The Great Hall of Xerxes, perhaps the largest and most magnificent structure the world has ever seen, is computed to have been a rectangle of about 300—350 feet, and to have consequently covered 105,000 square feet, or 2½ acres. The pillars were arranged in four divisions, consisting of a centre group six deep every way, and an advanced body of twelve in two ranks, the same number flanking the centre. Fifteen columns are all that now remain of the number. Their form is very beautiful. Their height is 60 feet, the circumference of the shaft 16, the length from the capital to the torus, 44 feet. The shaft is finely fluted in 52 divisions; at its lower extremity begin a cincture and a torus, the first, two inches in depth, and the latter, one foot, from whence devolves the pedestal, shaped like the cup and leaves of the pendent lotus, the capitals having been surmounted by the double semi-bull. Behind the Hall of Xerxes was the so-called Hall of Hundred Columns, to the south of which are indications of another structure, which Fergusson terms the Central Edifice. Next along the west front stood the Palace of Darius, and to the south the Palace of Xerxes, measuring about 86 feet square, similarly decorated, and of similar grand proportions.—For a further and more minute description, we refer to the travels of Niebuhr, Ker Porter, Rich, and other travellers; to Fergusson's *Palaces of Nineveh and Persepolis Restored*, and to Vaux's *Nineveh and Persepolis*. See also the articles **CYRUS**, **DARIUS**, **XERXES**, **CUNEIFORM**, and **PERSIAN ARCHITECTURE**.

**PERSEUS**, also **PERSES**, the last king of Macedonia, was the eldest son of Philip V., and was born in the latter part of the 3d c. B.C. He was trained to a military life from his earliest years, and after bringing about the death of his younger brother, Demetrius, who was a favourite both with the Macedonians and the Romans, he succeeded his father on the throne 179 B.C. Philip had long foreseen that a contest between Rome and Macedon was inevitable, and he had carefully prepared for it, so that P., on his accession, found himself forearmed. Meanwhile, he governed Macedon with great prudence and moderation, and became decidedly popular with his subjects and neighbours. Selencus IV. (Philopator) gave him his daughter Laodice in marriage; Prusias, the Bithynian king, married his sister; the Greek states looked favourably on his projects, and his envoys were well received even at Carthage. The Romans took the alarm, and—after some delusive negotiations—sent an army into Thessaly (171 B.C.). The war lasted four years; in the first three, the advantages were so little on the side of the Romans, that there was a widespread feeling in P.'s favour in the countries bordering on

the Levant and the Archipelago. In the beginning of the fourth campaign (168 B.C.), L. Aemilius Paulus arrived, and took command of the Roman forces. A great battle was fought at Pydna (June 22), in which the army of P. was utterly routed. The king himself was soon afterwards forced to surrender, and conveyed to Rome, where he adorned the triumph of the conqueror. He died in captivity at Alba, a few years later.

**PERSEUS**, in Grecian Mythology, the son of Zeus and Danaë (q. v.), and grandson of Acrisius. He was brought up at Seriphos, one of the Cyclades, where Polydectes reigned, who, wishing to get rid of him for private reasons, sent him, when yet a youth, to bring the head of the Gorgon Medusa, on the pretence that he wanted to present it as a bridal gift to Hippodamia. P. set forth under the protection of Athene and Hermes, the former of whom gave him a mirror, by which he could see the monster without looking at her (for that would have changed him into stone); the latter, a sickle; while the nymphs provided him with winged sandals, and a helmet of Hades, or invisible cap. After numerous wonderful adventures, he reached the abode of Medusa, who dwelt near Tartessus, on the coast of the ocean, and succeeded in cutting off her head, which he put into a bag, and carried off. On his return, he visited Ethiopia, where he liberated and married Andromeda, by whom he subsequently had a numerous family, and arrived at Seriphos in time to rescue his mother from the annoyance of the too ardent addresses of Polydectes, whom, along with some of his companions, he changed into stone. After this, he went to Argos, from which Acrisius fled to Thessaly, and P. assumed the vacant throne. But this, like many other details of the myth, is differently narrated. P. was worshipped as a hero in various parts of Greece, and, according to Herodotus, in Egypt too. In ancient works of art, the figure of P. much resembles that of Hermes.

**PERSEVERANCE OF SAINTS**, a doctrine necessarily resulting from the most essential parts of the Calvinistic system, and therefore held by almost all who adopt the Calvinistic or Augustinian doctrines. It is advocated not only by arguments from other doctrines, as those of election, atonement, the intercession and mediatorial dominion of Christ, imputed righteousness, and regeneration, but also from many texts of Scripture, as those which declare *eternal life* to be always connected with believing, and those which encourage the believer to depend on the faithfulness, love, and omnipotence of God. To an objection very commonly urged against it, that it tends to make men careless concerning virtue and holiness, its advocates reply, that this objection is only valid against a doctrine very different from theirs, the true doctrine of Perseverance of Saints being one of perseverance in holiness, and giving no encouragement to a confidence of final salvation which is not connected with a present and even an increasing holiness.

**PER'SHORE**, a market-town in the county of Worcester, and 9 miles south-east of the city of that name, on the Avon. It contains two churches—that of St Andrew's, small and ancient; and the church of the Holy Cross, in Norman and Early English, with a lofty square tower. This church is the only remaining portion of the ancient abbey-church of the same name. Pop. (1861) 2905, who are employed in wool-stapling, in manufacturing agricultural implements, and in raising fruits and vegetables for the markets of the large manufacturing towns in the vicinity.

**PE'R'SIA**, called by the natives **IRAN** (see **ARYAN RACE**), the most extensive and powerful

## PERSIA.

native kingdom of Western Asia, is bounded on the N. by the great plain of Khiva, the Caspian Sea, and the Trans-Caucasian provinces of Russia; on the E. by Bokhara, Afghanistan, and Beluchistan; on the S. by the Strait of Ormuz and the Persian Gulf; and on the W. by the Shat-el-Arab and Asiatic Turkey. It contains about 545,000 English square miles, and consists for the most part of a great tableland or elevated plateau, which in the centre and on the east side is almost a dead level; but on the north, west, and south, is covered with a broad belt of mountain-region, here and there interspersed with tracts of desert and small fertile plains. The mountain-system of P. has its root in the north-west corner of the kingdom, and is a continuation of the Taurus, Armenian, and Caucasian chains. The Taurus chain enters P. a little to the north-east of Lake Van (q. v.), and then turns in a south-easterly direction, ramifying into numerous parallel chains, which traverse the west and south of the country, covering it for a width of from 100 to 330 miles. At its south-eastern extremity, this chain joins the Jebel-Abad, which runs eastward through the centre of the province of Kerman, and forms the southern boundary of the plateau. The range is generally limestone, and like all other mountains of the same character, presents many caves and grottoes. The province of Azerbaijan, in the north-west, is almost wholly mountainous. On the east side of Azerbaijan, a spur of the Caucasus, separated from it, however, by the valley of the Kur and Araxes, runs southwards at some little distance from, and parallel to, the shore of the Caspian, at the south-west corner of which it becomes more elevated, and as the majestic range of the Elburz takes an easterly direction, following the line of the Caspian coast at a distance varying from 12 to 60 miles. On reaching Astrabad, it divides into three great parallel ranges of somewhat inferior elevation, which pursue first an east, and then a south-east direction, joining the Paropamisus in Afghanistan. Many of the hills in the Elburz are covered with perpetual snow; and the highest peak, Mount Demavend, is more than 20,000 feet above the sea. The Persian mountains are mostly of a primitive character; granite, porphyry, felspar, and mountain limestone enter largely into their composition; they also, in great part, exhibit indications of volcanic action—Demavend itself being evidently an extinct volcano; and the destructive earthquakes which are still of frequent occurrence in the north and north-west of P., indicate the presence of subterranean fires. The Elburz on the north, the Zagros on the west, the Kerman Mountains on the south, and Afghanistan on the east, are the boundaries of the Persian plateau, which ranges from 2000 to 5000 feet above sea-level, the lowest portion being the Great Salt Desert, in the north-west of Khorassan, which has 2000 feet of elevation above the sea; while the average elevation of the whole plateau above the sea is about 3700 feet. The lower level, out of which the upland rises, is called the *Dushtistan*, or 'Level Country,' and stretches along the coast of the Persian Gulf and Gulf of Ormuz, south of the Bakhtiyari and Kerman ranges, and also along the Caspian Sea, between it and the Elburz. The aspect of the plateau, diversified as it is for the most part with hills and valleys, mountain and plain, is, contrary to what might naturally be expected, dreary and forbidding. The interior mountains are everywhere bare and arid, unrelieved by trees or shrubs, and present the appearance of huge masses of gray rock piled one on the other, or starting in abrupt ridges from the level plain. The plains are equally unattractive; and those which are not deserts,

consist either of gravel which has been washed down from the mountain slopes or accumulated into deep and extensive beds during some former revolution of nature, or of a hard dry clay. To render such a country fertile, requires the presence of abundant water; but unfortunately for P., nature has been remarkably sparing in this respect. The whole of the east and centre of the country is entirely destitute of rivers; the country south of the Kerman Mountains is very meagrely supplied, the rivers, such as they are, being almost wholly confined to the western and the Caspian provinces.

Almost the whole of Khorassan (q. v.), the north half of Kerman (q. v.), the east of Irak-Ajemi (q. v.), which form the great central plain, and detached portions of all the other provinces, with the exception of those on the Caspian Sea, forming more than three-fourths of the surface of P., are desert. In some parts of this waste, the surface is dry, and produces a scanty herbage of saline plants; in other parts, it is covered with salt marshes, or with a dry, hard, salt crust, sometimes of considerable thickness, which glitters and flashes in the sunlight, forcing the traveller on these inhospitable wastes to wear a shade to protect his eyes; but by far the greater portion of this region consists of sand, sometimes so light and impalpable as to be shifted hither and thither by the slightest breeze. This great central desert contains a few oases, but none of great extent. The largest of the salt deserts of P. is the 'Dasht Beyad,' commonly known as the Great Salt Desert of Khorassan, which lies in the north-west of that province, and is 400 miles in length, by 250 miles in breadth.

Some parts of P., however, are of exceeding fertility and beauty; the immense valleys, some of them 100 miles in length, between the various ranges of the Kerman Mountains, abound with the rarest and most valuable vegetable productions; great portions of the provinces of Fars, Khuzistan, Ardelan, and Azerbaijan, have been lavishly endowed by nature with the most luxuriant vegetation; while the Caspian provinces, and the southern slopes of the Elburz, are as beautiful as wood, water, and a fine climate can make them—the mountainsides being clothed with trees and shrubs, and the plains studded with nature's choicest products.

*Rivers.*—P. has hardly one river that can properly be termed navigable, though some of them are several hundred miles in length, and of great width and volume of water; the few that are of sufficient importance to deserve mention are—the Karun, which rises in the mountains to the south of Ispahan, flows first west, and then south-south-west, receiving many tributaries in its course, and falls into the Shat-el-Arab (q. v.), near Mohammerah; the Kerkhah (or Karasu of the Turks), nearly equal to the Karun in size, and rising in the same range, which flows first westward, and then south-south-east, watering the west side of Luristan and Khuzistan, and joins the Tigris a little above its junction with the Euphrates; the Kizil-Usun, or Sefid-Rud ('White River'), which springs from the Sahund range, and flows in an easterly direction, falling into the Caspian Sea a little to the east of Resht. The Aras, or Araxes (q. v.), is by far the largest river in P.; but it can scarcely be considered a Persian river, as it never enters the country, but merely forms, for some distance, the northern boundary towards Russia. The rivers which flow to the southwards receive, in the latter part of their course, few tributaries, and fertilise only a narrow strip of land on each side of them, except when their waters are applied, by means of canals or other works, to the artificial irrigation of the soil. This mode of increasing and extending the

productive powers of the country was much employed in ancient times; but the constant change of masters, and the never-ending disturbances under which P. has so long suffered, led to the neglect of the practice, and most of these specimens of the architectural skill and laborious industry of the ancient Persians, are now in a ruinous condition. The Caspian provinces abound in rivers, but the greater number of them, from the proximity of the Elburz Mountains to the Caspian, are mere mountain torrents, which become dry in summer.

*Lakes.*—P., as a natural consequence of the nature and situation of its surface, abounds with saline lakes, and there are nearly thirty of them having no visible outlets. The chief lake is Lake Urumiah (q. v.), in Azerbaijan. Lake Bakhtegan, in the east of Fars, the receptacle for the drainage of the northern half of that province, is about 60 English miles in length, by 9 in breadth. Lake Shiraz (q. v.) is much smaller.

*Climate and Products.*—The climate is necessarily very varied. What the Younger Cyrus is reported to have said to Xenophon regarding the climate, 'that people perish with cold at the one extremity, while they are suffocated with heat at the other,' is literally true. P. may be considered to possess three climates—that of the southern Dusstistan, of the elevated plateau, and of the Caspian provinces. In the Dusstistan, the autumnal heats are excessive, those of summer more tolerable, while in winter and spring the climate is delightful. The cold is never intense, and snow seldom falls on the southern slope of the Kerman range. The rains are not heavy, and occur in winter and spring. The district is extremely unhealthy. On the plateau, the climate of Fars is temperate, and as we proceed northwards, the climate improves, attaining its greatest perfection about Ispahan. Here the winters and summers are equally mild, and the regularity of the seasons appears remarkable to a stranger. To the north and north-west of this, the winters are severe; and in Kurdistan, the greater part of Azerbaijan, and the region of the Elburz, the climate is quite alpine. The desert region of the centre and east, and the country on its border, endure most oppressive heat during summer, and piercing cold in winter. The Caspian provinces, from their general depression below the sea-level, are exposed to a degree of heat in summer almost equal to that of the West Indies, and their winters are mild. Rains, however, are frequent and heavy, and many tracts of low country are marshy and extremely unhealthy. With the exception of the Caspian provinces, the atmosphere of P. is remarkable above that of all other countries for its dryness and purity, a fact frequently proved by exposing pieces of polished iron to the action of the air, and finding whether or not they rust.

The cultivated portions of P., when supplied with moisture, are very fertile, producing an immense variety of crops. The chief cultivated products are wheat (the best in the world), barley, and other cereals, cotton (of which, according to the statement of the Persian ambassador at London in 1861, enough could be grown in the southern provinces to supply the manufactories of Western Europe), sugar, rice, and tobacco. The vine flourishes in several provinces, and the wines of Shiraz are celebrated in Eastern poetry. Mulberries are also largely cultivated, and silk is one of the most important products of the kingdom. The forests on the slopes of the Elburz abound with wild animals, as wolves, tigers, jackals, boars, buffaloes, foxes, and the Caspian cat. Lions and leopards also abound in Masanderan. Among domestic animals, the horse and camel hold the first place. The horses have always been celebrated as the finest

in the East. They are larger and more handsome but less fleet than the Arabian horses. Immense herds of sheep and goats feed upon the mountain slopes of the southern provinces, and yield their owners a rich product in wool and goat-hair of the very finest quality. The wool of the goat is spun into various fabrics, which, in softness and beauty, almost vie with those of Cashmere. The Caspian rivers abound with fish, especially sturgeon, great quantities of which are cured and exported to Russia. The mineral products of P. are insignificant, with the sole exception of salt. None of the precious metals are found. Iron is abundant in Azerbaijan, but is little worked; copper occurs in considerable quantity in the mountains of Mazanderan and Kerman; and lead, antimony, sulphur, and naphtha also abound. But the most celebrated mineral product of P. is the turquoise, which is found in the Fironz Koh, one of the Elburz Mountains, and in a hill 40 miles west-north-west of Nishapur. The former mine is now worked, but the mines in the latter place still yield these gems in abundance; and if they were properly worked, the yield might be greatly increased. The gems, however, are generally defaced by flaws and do not possess a high mercantile value. Marble of different kinds, coal, freestone, and slate are found in various places. At Dalki, in Fars, are two fountains of bitumen or black naphtha.

*Inhabitants.*—The population of P. is naturally divisible into two classes, the settled and the nomad. The settled population are chiefly Tajiks, the descendants of the ancient Persian race, with an intermixture of foreign blood—Turkish, Tartar, Arab, Armenian, or Georgian. To this class belong the agriculturists, merchants, artisans, &c. From having long been a subject race, they have to a large extent lost their natural independence and manliness of character, and acquired, instead, habits of dishonesty, servility, and cunning. The Tajiks are Mohammedans of the Shiite sect, with the exception of the few remaining Parsees or Guebres (q. v.), who are found in Kerman and Fars, and still retain their purity of race and religious faith. The nomad or pastoral tribes, or eylats (*eylat* clan), are of four distinct races—Turkomans, Kurds, Lûrs, and Arabs. Their organisation is very similar to that which formerly subsisted among the Highland clans of Scotland, with the exception that the former are nomad, while the latter inhabited a fixed locality. Each tribe is ruled by its hereditary chief (*ujak*), and under him by the heads of the cadet branches (*tire*) of his family. Of the four races, the Turkomans are by far the most numerous, and forms at the present day the ruling race in Persia. The Kurds are few in number, the greater part of their country at present being under the sway of Turkey. The Arabs are also few in number, and at the present day can hardly be distinguished from the Persians, having adopted both their manners and language. The Lûrs are of nearly pure Persian blood. The nomad races, especially the Turkomans, profess the Sunnite creed; they are distinguished from the Tajiks by their courage, manliness, and independence of character; but they are inveterate robbers, and since their entrance into the country in the 10th c., it has been continually distracted by civil wars and revolutions. The whole population of P. is estimated at round numbers at 10,000,000, of whom 3,000,000 are nomads (200,000 of these being Arabs). Classed according to their religious belief, they stand thus: 7,500,000 are Shiites; 500,000 are Shiites orthodox; 1,500,000 are Sunnites; while the remaining 500,000 is made up of Christians of various denominations (including 200,000 Armenians, 100,000 Nestorians), along with Jews, Guebres, &c.

## PERSIA.

withstanding its ancient civilisation, almost the barbarism now prevails in P. as in other median countries, and few traces remain of intellectual culture which in ancient times distinguished the country. The insecurity of property prevented the improvement of land, the extension of trade, and public works of every kind. The arts are utterly neglected. The houses, those of the wealthiest people not excepted, appear conical, being generally built of earth or mud, grouped together, even in the principal cities, with little attention to either uniformity or to their arrangement. They scarcely ever rise above a story in height, and they are surrounded by blank walls. The public buildings, such as colleges, and caravansaries, are of similar construction to the ordinary houses, and built of the same materials. The interior, however, of the palaces of the rich are sometimes perfect paradises of splendour and elegance; and however much dwellings of mud may offend a European eye, it is not reasonable to complain whether, with all its disadvantages, it is not a better building material than wood in a country possessing such a climate as Persia. The miserable look of the towns is, however, greatly improved by the beauty of the gardens which surround them. These gardens are planted with forest and fruit trees, and some of them, especially in Irak and Kerman, are of rare beauty.

**Manufactures and Trade.**—The trade of P. is of little importance. Silk is the staple, and is produced in every province, especially in those of the north; cotton and woollen shawls, carpets, and felts are largely manufactured for use and export in Khorassan. The manufactures, which consist of satin, sarcenet, brocades, &c., and are made exceedingly strong and durable, and are of inferior quality, and are chiefly exported to Turkey and Russia. Trade is carried on by caravans with the interior of Asia and the chief cities of P., such as Tebriz, Abu-Shehr, Ispahan, Teheran, and Kazbin. These caravans carry the products of P. for muslin, leather, iron, copper, china, glass, hardware, gums, dyed and un-dyed spices. The trade of the Caspian Sea is carried on by the Russians, who visit periodically the ports of Enzelli, Balfurustah, and Astrabad. Bassorah, and Gombroon are the ports in the Persian Gulf through which trade with India and other countries on the shores of the Indian Ocean is carried on. The exports to India consist of horses, dried fruit, and drugs; and to Europe, from that country and Europe, of silks, cotton goods, jewellery, arms, cutlery, earthen glass, and metal wares, &c. The imports and exports for the last few years by the western frontier, imports, £1,876,812; exports, £1,913,043. By the eastern frontier, imports, £1,159,420; exports, £1,101,450. Total, imports, £3,036,232; exports, £3,014,493.

**Government, Taxation, Education, &c.**—The government of P. is a pure despotism, limited only by domestic intrigues, dread of private vendettas, and an occasional insurrection. The last of these is the principal check against unjust government on the part of the monarch, while the others operate as powerful restraints on his power. The monarch, who has the title of 'Shah' or 'Khan', possesses absolute authority over the lives and property of his subjects; and his governors of provinces and districts, possess similar authority over those under them; but they are, however, liable to revision by the monarch, who may summarily inflict any punishment on them for real or alleged misgovernment. The interests of the working and mercantile classes is

almost a necessity of such a form of government. The capitalists of the country, a numerous class, dare not exhibit their wealth, much less invest it in any mercantile transactions, lest they should thereby excite the cupidity of some rapacious governor. The central government consists of the *Sadri-Azem*, or Grand Vizier, who is inferior in authority to the Shah alone; the *Ilmadod-Dowlet*, or Minister for Foreign Affairs; the *Eminet-Dowlet*, or Minister of Finance; the *Nizamed-Dowlet*, or Minister of the Interior; the *Lesker-nourvis*, or War Minister; and various superintendents of the administration of justice, of commerce, agriculture, industry, and public works, the commander-in-chief, and the master of the ceremonies. The law, which in civil cases is administered by Mollahs (q. v.), in criminal cases by a state court, is founded on the Koran and on tradition. The punishments commonly inflicted are fines, flogging (the bastinado), and death, either by decapitation, stabbing, or torture. The governors of provinces, who are always chosen from the governing race, the Turkomans, and are generally of the blood-royal, though they oppress to the utmost the poor Tajiks, are seldom able to protect their provinces from the ravages of the predatory sylat hordes, who, though nominally subject to the Shah, are governed by their own khans, and are really independent. The revenue is derived from a tax on the gross produce of land, which varies from 10 to 20 per cent. on the whole; from the crown-lands (which are being constantly increased by confiscations); from the church-lands—which since the time of Nadir Shah (q. v.) have been in the hands of the Shah; from a tax on cattle, flocks, and even bees, and many other imposts. There is also a heavy property and income tax; and the various duties which are levied on imports *in transitu* are almost numberless. Besides all these, capitation and door-taxes are levied specially on Armenians, Jews, and Guebres. The revenue derived from these exactions is greatly increased by presents, which all those who are in any way dependent on court-favour are bound to make to the Shah on certain days, and which amount annually to nearly £1,000,000. The revenue is divided into two portions, one of which goes into the 'Spiritual Treasury,' or *Beit-ul-Mal*, and is expended on mosques, payment of judges and clergy, assistance of poor Moelems, public works and institutions, such as roads, bridges, schools, &c., subsidies to pilgrims to holy places, and to the Prophet's descendants, &c.; the other, which is by far the larger, goes into the crown treasury, which is charged with the maintenance of the Shah, his family, servants, and court, and the defraying of all public expenses, salaries, &c., unconnected with religion. The receipts for the year 1858 were, to the spiritual treasury, 2,500,000 tomans = £1,250,000; to the crown treasury (not including the gifts to the Shah), 7,000,000 tomans = £3,500,000. There is no public debt, and all extra expenses are at once met by extra taxation. The proportion of the revenue which is applied to the support of schools for public instruction, is small, and education is thus necessarily in a very low state. The sciences of astronomy, metaphysics, physics, and mathematics, are nominally studied; but the astronomy consists of the Ptolemaic system, largely intermixed with astrology, and the other sciences as taught are similarly composed of the debris of effete systems and ancient superstitions.

**Political Divisions, &c.**—From the earliest times down to the present century, P. was divided into seven or eight great divisions; but about the time when it was attempted to introduce European

civilisation into the country, and discipline into the army, the country was anew divided into 25 provinces—viz., the three Caspian provinces of Gilan, Mazanderan, and Astrabad, in the north; Azerbijan, Ardalan or Persian Kurdistan, Luristan, and Khuzistan, in the west; Fars, Laristan, and Kermañ with Mogistan, in the south; while the great province of Irak-Ajemi in the centre was divided into Khamsah, Kaabin, Teheran, Hamadan, Kûm, and Ispahan; and that of Khorassan in the east into Yezd, Tabas, Ghayn and Birjun, Turshiz, Meshid, Damghan, Semnun, and the Dasht Beyad, or the Great Salt Desert. The western and northern provinces are well sprinkled with towns and large villages, but the most of the others consist of little more than the chief town and its suburbs, the rest being either desert, or in the hands of the wild pastoral tribes. There are many interesting ruins of ancient, populous, and celebrated cities in Persia, for example, Persepolis (q. v.), Rhages or Rhé, Shahpur, Istakhar, Tôs, Merv, Shushan, Hamadan, &c.; and the monuments and inscriptions found at some of these places form a highly-interesting study to the historian and the antiquary. See BEHISTUN. In modern times, Tabriz or Tauris, Kazbin, Ispahan, and Shiraz, have been in succession the seats of royalty, and at present Teheran is the favoured city.

*Army.*—The army consists (1860) of 80,000 regular infantry, 4000 regular cavalry, 2000 engineers and artillerymen, and a large body of irregular cavalry, which generally numbers about 30,000 men, and is contributed by the nomad tribes, being almost their sole acknowledgment of subjection to the Shah. This irregular cavalry, which forms the bravest portion of the Persian army, is equal to the Cossacks in the Russian army, and much superior to the Turkish Sultan's Bashi-Bazouks. Abbas Pasha, the grandfather of the present Shah, attempted to organise a portion of the army according to European tactics, but he was unsuccessful.

*History.*—According to the *Shah Nameh* of Firdusi (q. v.), the history of P. begins some thousands of years before the Christian era. Little has yet been done towards extracting the grains of historical truth that may be contained in the mass of fable that constitutes the native Persian annals; although hopes are cherished that by aid of the many inscriptions and monuments that are being daily discovered, light may yet be thrown upon many points. In the meantime, we must rest contented with the accounts derived from Greek writers. The north-western part of Iran, anciently called Media (q. v.), was, at the earliest period known to the Greeks, a part of the Assyrian empire, but the Medes revolted, and (708 B. C.), under Dejoces, established an empire which subdued both that of Assyria and their own kindred tribes of Persia. See MEDIA. About 537 B. C., the Persians under CYRUS (q. v.)—the Kai-Khusru of the Persians—(559—529 B. C.) rebelled, subdued their former masters, the Medes (who from this time became amalgamated with them), and established a mighty empire, which included, besides P., as far as the Oxus and Indus, Asia Minor, Syria, Palestine, and Mesopotamia. His son, CAMBYSES, a most ferocious and blood-thirsty tyrant (529—522 B. C.), subdued Tyre, Cyprus, and Egypt. After the brief rule of the usurper SMERDIS (522—521 B. C.), DARIUS I. (q. v.), surnamed HYSTAMPES—the Gushtasp of the Persians—(521—485 B. C.), mounted the throne. He was a politic and energetic prince, and succeeded in firmly establishing his dynasty, and adding Thrace and Macedonia to his empire; but his two attempts to subdue Greece were completely foiled, the first by the Thracians, and the second by the Athenians at

Marathon (490 B. C.). His son, XERXES I. (485—465 B. C.)—the Isfunder of the Persians—renewed the attempt to subdue the Greek states, and though at first successful, the defeats of Salamis and Platae compelled him to limit himself to a defensive warfare, which exhausted the resources of his kingdom. His son, ARTAXERXES I. (465—425 B. C.), surnamed LONGIMANUS (the Bahman of the Persians, better known as Ardeshir Diradust), was a valiant prince, but he was unable to stay the decadence of P., which had now commenced. He, however, crushed a formidable rebellion in Egypt, though his wars with the Greeks and Ionians were unsuccessful. The empire now became a prey to intestine dissensions, which continued during the reigns of his successors, Xerxes II., Sogdianus, Darius II., Artaxerxes II., and Artaxerxes III. DARIUS III. CODOMANUS (336—329) (the Darab II. of the Persians), the last of the dynasty, was compelled to yield his throne to Alexander (q. v.) the Great, king of Macedon (known as Secunder by the Persians), who reconquered all the former provinces of P., and founded a vast empire, which, at his death in 324 B. C., was divided into four parts, P. along with Syria falling to the share of the Seleucids (q. v.), and its old dependency, Egypt, to the Ptolemies (q. v.). The Seleucids soon lost Bactria (now Balkh), which became independent under a series of Greek sovereigns; and about 246 B. C., Parthia (q. v.)—now Northern Khorassan—also rebelled under ARSACES I. (the Ashk of the Persian writers), who founded the dynasty of the Arsacids, under whom the greater part of P. was wrested from the Greeks, and maintained against both the Greeks and Romans. The Greek empire of Bactria, which is said to have included a great part of Hindustan, was overthrown by an influx of nomad tribes from Turkestan, and these invaders having been driven out by the Parthians, Bactria was added to their empire. But the dynasty of the Arsacids was brought to an end by a Persian named Ardeshir Babegan, who managed to gain possession of Fars, Kermañ, and nearly the whole of Irak, before Arduan, the Parthian king, took the field against him. At last, a great battle was fought (218 A. D.) on the plain of Hormuz, in which the Persians were completely victorious. Babegan was now hailed as Ardeshir, king of P., and 'Shahan Shah,' or king of kings. The history of this dynasty will be found under the head of SASSANIDE. The Sassanian kings raised P. to a height of power and prosperity such as it never before attained, and more than once perilled the existence of the Eastern Empire. The last king was driven from the throne by the Arabs (636 A. D.), who now began to extend their dominion in all directions; and from this period may be dated the gradual change of character in the native Persian race, for they have been from this time constantly subject to the domination of alien races. During the reigns of Omar (the first of the Arab rulers of P.), Othman, Ali, and the Ommiads (634—750), P. was regarded as an outlying province of the empire, and was ruled by deputy governors; but after the accession of the Abbasside dynasty (750 A. D.), Bagdad became the capital, and Khorassan the favourite province of the early and more energetic rulers of this race, and P. consequently came to be considered as the centre and nucleus of the califate. But the rule of the califs soon became merely nominal, and ambitious governors, or other aspiring individuals, established independent principalities in various parts of the country. Many of these dynasties were transitory, others lasted for centuries, and created extensive and powerful empires. The chief were the THURATIS

## PERSIA.

(820—872), a Turkish dynasty in Khorassan; the SOFFARIDES (Persian, 869—903), in Seistan, Fars, Irak, and Mazanderan; the SAMANI, in Transoxiana, Khorassan, and Seistan; the DILEMI (Persian, 933—1056), in Western Persia; and the GHIZNEVIDES (q. v.), in Eastern Persia. These dynasties supplanted each other, and were finally rooted out by the Seljuks (q. v.), whose dominion extended from the Hellespont to Afghanistan. A branch of this dynasty, which ruled in Khaurezm (now Khiva, q. v.) gradually acquired the greater part of Persia, driving out the Ghiznevides and their successors, the GHURIDES (q. v.); but they, along with the numerous petty dynasties which had established themselves in the south-western provinces, were all swept away by the Mongols (q. v.) under GENGHIS-KHAN (q. v.) and his grandson, Hulaku-khan, the latter of whom founded a new dynasty, the PERSO-MONGOL (1253—1335). This race becoming effeminate, was supplanted by the EYLKANIANS in 1335, but an irruption of the Tartars of Turkestan under TIMŪR (q. v.) again freed P. from the petty dynasties which misruled it. After the death of TimŪr's son and successor, Shah Rokh, the Turkomans took possession of the western part of the country, which, however, they rather preyed upon than governed; while the eastern portion was divided and subdivided among TimŪr's descendants, till, at the close of the 15th c., they were swept away by the Uzbeks (q. v.), who joined the whole of Eastern P. to their newly-founded khanate of Khiva. A new dynasty now arose (1500) in Western P., the first prince of which (Ismail, the descendant of a long line of devotees and saints, the objects of the highest reverence throughout Western P.), having become the leader of a number of Turkish tribes who were attached by strong ties of gratitude to his family, overthrew the power of the Turkomans, and seized Azerbaijan, which was the seat of their power. Ismail rapidly subdued the western provinces, and in 1511 took Khorassan and Balch from the Uzbeks; but in 1514, he had to encounter a much more formidable enemy—to wit, the mighty Selim (q. v.), the Sultan of Turkey, whose zeal for conquest was further inflamed by religious animosity against the Shiites, or 'Secretaries,' as the followers of Ismail were termed. The Persians were totally defeated in a battle on the frontiers; but Selim reaped no benefit from his victory, and after his retreat, Ismail attacked and subdued Georgia. The Persians dwell with rapture on the character of this monarch, whom they deem not only to be the restorer of P. to a prosperous condition, and the founder of a great dynasty, but the establisher of the faith in which they glory as the national religion. His son Tamasp (1523—1576), a prudent and spirited ruler, repeatedly drove out the predatory Uzbeks from Khorassan, sustained without loss a war with the Turks, and assisted Homayun, the son of Baber, to regain the throne of Delhi. After a considerable period of internal revolution, during which the Turks and Uzbeks attacked the empire without hindrance, Shah Abbas I. the Great (1585—1628), ascended the throne, restored internal tranquillity, and repelled the invasions of the Uzbeks and Turks. In 1605, he inflicted on the Turks such a terrible defeat as kept them quiet during the rest of his reign, and enabled him to recover the whole of Kurdistan, Mosul, and Diarbekir, which had for a long time been separated from P.; and in the east, Candahar was taken from the Great Mogul. Abbas's government was strict, but just and equitable; roads, bridges, caravansaries, and other conveniences for trade, were constructed at immense expense, and the improvement and ornamentation of the towns

were not neglected. Ispahan more than doubled its population during his reign. His tolerance was remarkable, considering both the opinions of his ancestors and subjects; for he encouraged the Armenian Christians to settle in the country, well knowing that their peaceable and industrious habits would help to advance the prosperity of his kingdom. His successors, Shah Sufi (1628—1611), Shah Abbas II. (1641—1666), and Shah Soliman (1666—1694), were undistinguished by any remarkable talents, but the former two were sensible and judicious rulers, and advanced the prosperity of their subjects. During the reign of Sultan Hussein (1694—1722), a weak and bigoted fool, priests and slaves were elevated to the most important and responsible offices of the empire, and all who rejected the tenets of the Shiites were persecuted. The consequence was a general discontent, of which the Afghans (q. v.) took advantage by declaring their independence, and seizing Candahar (1709). Their able leader, Meer Vais, died in 1715; but his successors were worthy of him, and one of them, Mahmud, invaded P. (1722), defeated Hussein's armies, and besieged the king in Ispahan, till the inhabitants were reduced to the extremity of distress. Hussein then abdicated the throne in favour of his conqueror, who, on his accession, immediately devoted his energies to alleviate the distresses and gain the confidence of his new subjects, in both of which objects he thoroughly succeeded. Becoming insane, he was deposed in 1725 by his brother Ashraf (1725—1729); but the atrocious tyranny of the latter was speedily put an end to by the celebrated Nadir Shah (q. v.), who first raised Tamasp (1729—1732) and his son, Abbas II. (1732—1736), of the Suffavean race, to the throne, and then, on some frivolous pretext, deposed him, and seized the sceptre (1736—1747). But on his death, anarchy again returned; the country was horribly devastated by the rival claimants for the throne; Afghanistan (q. v.) and Beloochistan (q. v.) finally separated from P., and the country was split up into a number of small independent states till 1755, when a Kurd, named Kerim Khan (1755—1779), abolished this state of affairs, re-established peace and unity in Western Persia, and by his wisdom, justice, and warlike talents, acquired the esteem of his subjects, and the respect of neighbouring states. After the usual contests for the succession, accompanied with the usual barbarities and devastations, Kerim was succeeded in 1784 by Ali-Murad, Jaafar, and Luft-Ali, during whose reigns Mazanderan became independent under Aga-Mohammed, a Turkoman eunuch of the Kajar race, who repeatedly defeated the royal armies, and ended by depriving Luft-Ali of his crown (1795). The great eunuch-king (as he is frequently called), who founded the present dynasty, on his accession announced his intention of restoring the kingdom as it had been established by Kerim Khan, and accordingly invaded Khorassan and Georgia, subduing the former country almost without effort. The Georgians besought the aid of Russia; but the Persian monarch, with terrible promptitude, poured his army like a torrent into the country, and devastated it with fire and sword; his conquest was, however, hardly completed, when he was assassinated, May 14, 1797. His nephew, Futteh-Ali (1797—1834), after numerous conflicts, fully established his authority, and completely subdued the rebellious tribes in Khorassan, but the great commotions in Western Europe produced for him bitter fruits. He was dragged into a war with Russia soon after his accession, and by a treaty, concluded in 1797, surrendered to that power Derbend and several districts on the Kur. In 1802, Georgia was declared



to be a Russian province. War with Russia was recommenced by P., at the instigation of France; and, after two years of conflicts disastrous to the Persians, the treaty of Gulistan (October 12, 1813) gave to Russia all the Persian possessions to the north of Armenia, and the right of navigation in the Caspian Sea. In 1826, a third war, equally unfortunate for P., was commenced with the same power, and cost P. the remainder of its possessions in Armenia, with Erivan, and a sum of 18,000,000 rubles for the expenses of the war. The severity exercised in procuring this sum by taxation, so exasperated the people, that they rose in insurrection (October 12, 1829), and murdered the Russian ambassador, his wife, and almost all who belonged to, or were connected with the Russian legation. The most humiliating concessions to Russia, and the punishment by mutilation of 1500 of the rioters, alone averted war. The death of the crown-prince, Abbas-Mirza (q. v.), in 1833, seemed to give the final blow to the declining fortunes of P., for he was the only man who seriously attempted to raise his country from the state of abasement into which it had fallen. By the assistance of Russia and Britain, Mohammed Shah (1834—1848), the son of Abbas-Mirza, obtained the crown, but the rebellions of his uncles, and the rivalry of Russia and Britain (the former being generally successful) at the Persian court, hastened the demoralisation of the country. Mohammed was compelled to grant (1846) to Russia the privilege of building ships of war at Resht and Astrabad, and to agree to surrender all Russian deserters, and P. became thus more and more dependent on its powerful neighbour. Nazir-uddin succeeded to the throne on his father's death in 1848; and the new government announced energetic reforms, reduction of imposts, &c., but limited itself to these fine promises, and on the contrary, augmented the taxes, suffered the roads, bridges, and other public works to go to ruin, squandered the public money, and summarily disposed of all who protested against their acts. In October 1856, the Persians took Herat (q. v.), a town for the permanent possession of which they had striven for a long series of years; and having thus violated the terms of a treaty with Britain, war was declared against them, and a British army was landed on the coast of the Gulf, which, under Generals Outram and Havelock, repeatedly defeated the Persians, and compelled them to restore Herat (July 1857). Since this time, treaties of commerce have been concluded with the leading European powers; and Russia, Great Britain, Turkey, France, and Italy, have consuls in the chief towns, and, with the exception of Italy, are represented by ministers at the court of Teheran.

#### PERSIAN ARCHITECTURE.

The architecture of Persia is of considerable interest, both on its own account, and as supplementary to and explanatory of that of Assyria, which, together with the similar edifices in Egypt, is the earliest architecture of which we have any knowledge. The buildings of Persia and Assyria closely resemble one another, and, owing to the mode and the materials in which they were constructed, their remains serve to illustrate and complete each other's history. In Assyria, where no solid building-materials exist, the walls are composed of masses of sun-dried brickwork, lined on the inside, to a certain height from the floor, with large sculptured slabs of alabaster. These have been preserved to us by the falling in of the heavy earthen roofs, with

which, as the later Persian buildings explain, the Assyrian palaces were covered. The exploits of Layard and Botta, and the specimens brought home by the former, and now in the British Museum, have made these sculptures familiar to us. The subjects usually are large bulls with human heads; priests with human bodies, and eunuchs with lions' heads, performing religious service before a 'sacred tree.' The Assyrian remains are not only palace-temples, buildings somewhat resembling Egyptian temples (which were also palaces), but many of the sculptures represent the exploits of kings in war and in peace. The palaces are raised on lofty artificial mounds, and approached by magnificent flights of steps.

The buildings of Assyria extend over a wide period, the oldest at Nimroud being from 900 to 800 B.C., and the more recent at Khorsabad and Koyunjik from 800 to 600 B.C. To these succeeds Babylon in the reign of Nebuchadnezzar, and Birz Nimroud; but these are mere masses of unglazed brickwork, without any sculptures or other material.

After Babylon came Pasargadae—where the splendid palaces of Cyrus and Cambyses still exist in ruins—and Persepolis, the capital of Darius I. Xerxes (560—523 B.C.), and some remains of his palace are to be found at Susa, Ecbatana, and Teheran. At Persepolis, we find the very parts preserved at Nimroud and Khorsabad are wanting; there is abundance of stone, and the pillars, doorways, &c. (which, in the early examples, were of wood, and have decayed), being still preserved. This has enabled Mr Fergusson to 'restore' these buildings, and to produce some interesting designs, shewing not only the general palaces of Persia were constructed and lighted from them to suggest how the arrangements of the ancient architecture of Egypt and Syria have been designed.

The halls at Persepolis were square in plan, having an equal number of pillars in each side for the support of the roof, which was flat. In the centre, a portion was left open for the admission of light, and sheltered by another row raised on pillars. The accompanying section (fig. 1) of the Great Hall of Xerxes (from Fergusson's *Handbook of Architecture*) will explain this arrangement.



Fig. 1.—Section of Hall of Xerxes at Persepolis.

(*Architecture*) will explain this arrangement. The hall is the most splendid building whose remains exist in this part of the world. The remaining part of the hall was adorned with 72 columns with which it was adorned in extent (fig. 2). The hall had 36 columns, six on each side, and on three sides had an external portico with two rows of six columns. These columns had capitals, composed of bulls' heads and scrolls (fig. 3), between which the beams of the roof were ornamented with scrolls of the Ionic order (fig. 4). The bases also are suggestive of the origin of that Greek style. This hall

by 300, and covered more ground than any other buildings of antiquity, or any medieval cathedral except that of Milan. The palaces of

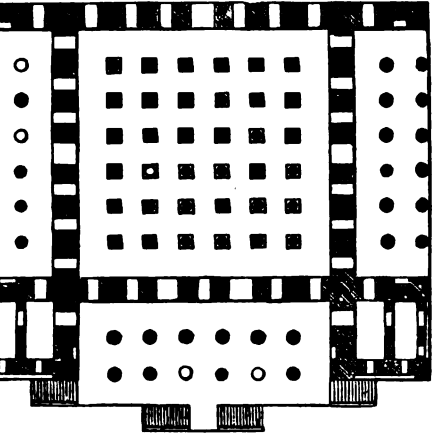

Fig. 2—Plan of Great Hall of Xerxes at Persepolis.

Persepolis stand on lofty platforms, built with walls of Cyclopean masonry, and approached by magnificent flights of stairs, adorned, like the palaces, with

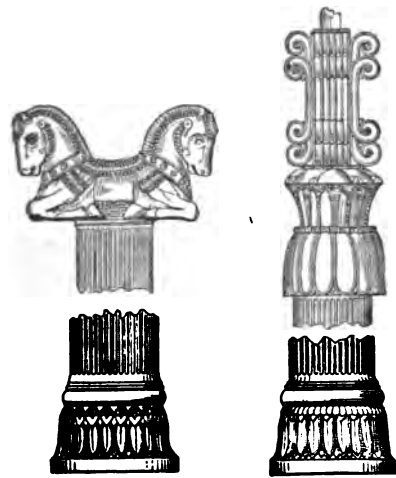

Fig. 3. Fig. 4.  
Details of Persian Architecture.

sculptures somewhat similar to those of Assyria. The interiors were ornamented with paintings. The use of the arch was known in Assyria, as has been shown by the subterranean arched conduits discovered by Layard, and the gates of Khorsabad discovered by M. Place. The arches of the latter are supported from the backs of sculptured bulls, and are richly ornamented with enamelled bricks.

**PERSIAN GULF**, an arm of the Indian Ocean which penetrates between Arabia and Persia to the extent of 650 English miles in a general northerly direction. Its breadth varies from 55 miles at the mouth to 250 miles, and the area is estimated at 117,300 square miles, from which about 1930 square miles must be subtracted for the islands, which are scattered over the western half, or lie close inshore along the eastern side. The chief

of these islands are Ormuz (q. v.), at the mouth, Kishm, 810 square miles in extent; and the Bahrein Islands (q. v.), chief of which is Samak. The Great Pearl Bank stretches along the western side from Ras Hassan to nearly half-way up the gulf. The coast is mostly formed of calcareous rocks. On the Arabian side, it is low and sandy, occasionally broken by mountains and cliffs; while, on the Persian side, it is higher and abrupt, with deep water close inshore, owing to the mountain-ranges of Fars and Laristan running close to the water's edge. The islands are partly of limestone and partly of ironstone, and are generally destitute of springs, barren, desolate, and presenting numerous traces of volcanic eruptions. With the exception of the Shat-el-Arab (q. v.), the P. G. receives only insignificant streams. Its eastern side presents abundance of good anchorage, either in the numerous bays or in the lee of islands. The greater portion of its shores now belongs to the Imaum of Muscat. The coasts of the gulf have been explored by successive British expeditions, the last of which, in 1821—1825, made a complete trigonometric survey of the Arabian shore. The order of the periodic currents in this gulf is precisely the reverse of that of the Red Sea (q. v.) currents, as they ascend from May to October, and descend from October to May.

Oriental geographers give to this gulf the name of the 'Green Sea,' from a remarkable strip of water, of a green colour, which lies along the Arabian coast. It is strange that from the time of Nearchus, the admiral of Alexander the Great, who was the first to make the P. G. known to Europeans, the Persians have never ruled supreme over its surface.

**PERSIAN LANGUAGE AND LITERATURE.**

The ancient and modern idioms of Persia, which are in general designated as Iranian or West Aryan, belong to the great class of the Indo-Germanic languages; but the term Persian itself applies more particularly to the language as it is now spoken, with a few exceptions, throughout Persia, and in a few other places, formerly under Persian dominion, like Bokhara, &c. The more important and better-known of the ancient idioms are (1) the *Zend* (the East Iranian or Bactrian language, in two dialects—the 'Gátha idiom,' and the 'ancient' or 'classical *Zend*'), which died out in the 3d c. a. c.—one of the most highly-developed idioms, rich in inflections, in the verbs as well as in the nouns, and in the former almost completely agreeing with Vedic Sanscrit; yet such as we find it in the small remains which have survived, it is no longer in the full vigour of life, but almost decaying, and grammatically somewhat neglected; it is in fact held by a great authority on the subject (Haug), that the grammar was never fixed in any way by law. To increase the difficulty still more, the texts—the Zoroastrian books—never seem to have been copied with proper care, or by men who had any correct knowledge of the language; so that the critical restoration of the literary remains is matter of extreme difficulty, and *Zend* studies in general may be said to be in their infancy yet. Geographically, this idiom may be placed in Northern Persia. Its alphabet is of Semitic origin, and the writing goes from right to left (see *ZEND*, *ZEND-AVESTA*). (2) *Ancient Persian*, the chief remnants of which are found in the cuneiform inscriptions of the time of the Achæmenides, discovered in the ruins of Persepolis, on the rock of Behistun, and some other places of Persia (see *CUNEIFORM*). Some relics, chiefly consisting of proper names for gods and men, and terms for vessels and garments, have survived in the writings of the classical period, and in the Bible, chiefly in Daniel. This idiom is much

nearer to Zend and Sanscrit than to modern Persian. It has still the structure of an ancient organic Indo-Germanic language, with the distinct peculiarities of an Iranian tongue. (3) *Pehlevi* (q. v.) (West Iranian, Median, and Persian), in use during the period of the Sassanides (3d to 7th c. A. D.), an idiom largely mixed with Semitic words, and poorer in inflections and terminations than Zend. Its remnants consist of a certain number of books relating to the Zoroastrian religion, of coins and inscriptions; and the language is not quite the same in all cases—according to the larger or smaller infusion of foreign words. The non-Iranian element is known as Huzvareh, and is simply Chaldee; while the Iranian element is but little different from modern Persian. There are three distinct idioms to be distinguished in Pehlevi, and the writing varies accordingly, yet it is not certain whether the difference arises from their belonging to different districts or periods. When, however, Pehlevi ceased to be a living language, and the restoration of the pure Iranian had begun, people, not daring to change the writings, chiefly of a sacred nature, as they had descended to them from the Sassanian times, began to substitute, in reading, the Persian equivalents to the Huzvareh words. At last a new form of commentaries to the sacred writings sprang up, in which more distinct and clear Zend characters were used, where each sign has but one phonetical value, and where all the foreign Huzvareh words were replaced by pure Persian ones; and this new form was called (4) *Pâzend*. The transition from the ancient to the modern Persian is formed by the *Parsee*, or, as the Arabs call it, *Farsi*, in use from 700 to 1100 A. D., once the language purely of the south-western provinces, and distinguished chiefly by a peculiarity of style, rigid exclusion of Semitic words, and certain now obsolete forms and words retained in liturgic formulas. It is the Persian once written by the Parsees or fire-worshippers, and is in other respects very similar to the present or *modern Persian*, the language of Jâmi, Nizâmi, and Hâfiz—from 1100 to the present time—with its numerous dialects. The purest dialect is said to be that spoken in Shiraz and Ispahan and their neighbourhood. In general, the language is pronounced by universal consent to be the richest and most elegant of those spoken in modern Asia. It is the most sonorous and muscular, while at the same time it is the most elegant and most flexible of idioms; and it is not to be wondered at, that, throughout the Moslem and Hindu realm, it should have become the court language, and that of the educated world in general; holding a position somewhat similar to that which the French language held up to within a recent period in Europe. Its chief characteristic, however, is the enormous intermixture of Arabic words, which, indeed, almost make up half its vocabulary. Respecting its analytical and grammatical structure, it exhibits traces only of that of the ancient dialects of Zend and Achæmenian, of which it is a direct descendant. The elaborate system of forms and inflections characteristic of those dialects has been utterly abandoned for combinations of auxiliary words, which form independent connective links, and which impart fulness and an incredible ease to speech and composition, but which, at the same time, correspond as little to the classical notion of inflection. The grammar of the Persian language has been called 'regular;' but the fact is, that there is hardly any grammar worth mentioning—at all events, no grammar the rules of which could not be mastered in the briefest possible period. To begin with: there is no gender

distinguished in declension; the plural is formed in the same manner, the only distinction consists in animate beings receiving *ân*, while the inanimate are terminated further, that instead of the inflection in the present cases found in the ancient language a *mar* (hitherto unexplained) is prefixed, (*râh* = way, by reason of, Pehlevi, *Parai*) Between the genitive and the word which it, also between a noun and its following, an *i* is inserted. This is the whole declension of the noun, but also of the adjective and pronoun. The comparative is formed, a mother-tongue, by the addition of *ter*; the superlative adds *terta*, which is New-Persian *terta*. Not even the pronouns have a gender of their own, the distinction between masculine and feminine must be expressed by a special word, denoting male or female. There is no article, either definite or indefinite. Singularity of a noun is expressed by an appended *ê*, a remnant of *âeva*, one. The termination of the verb is equally simple. There is no personal terminations for all tenses:—*am*, *ast*; *em*, *ed*, *nd*; the infinitive ends in *tan*, the past participle in *tah* or *dah*. The imperative is formed by adding to the root the termination *ad*; *em*, *ed*, *and*; the preterite by dropping the *tan* of the infinitive, and substituting the usual termination *am*. The prefix *mi* or *hami* (*Parai* and *Huzvareh* always) transforms the preterite into the imperfect, while the prefix *bi* or *bâh* (the present of 'to will') alters the aorist into the simple future. The other tenses are compounds of the principle and auxiliary verbs, as in the Teutonic and other modern tongues. The passive is formed by the various tenses of the verb *shu*, 'to be, to go, to beware,' being placed after the active participle. As to syntax, there is none, of course, of events, none which would not come almost intuitively to any student acquainted with the laws of speech and composition. As the time of its greatest brilliancy may be designated that of Firdusi wrote, when Arabic words had not yet entered it to the vast degree in which it is now for the most part were still, as far as they had crept in, and were to whatever rules the Persian grammar is now upon the words of its own language.

In the history of the Persian writing, three systems are to be distinguished. First, we have the old form (q. v.), by the side of which there has, however, to have been in use a kind of alphabet for common purposes. This, in the 10th period, appears to have split into several alphabets, all related to each other, and pointing to a common Syriac origin (such as the different kinds of characters and the Zend alphabet) cleverly adapted to the use of a non-Semitic language. In the 11th period, we find the Arabic alphabet employed in Persian use by the addition of diacritical points for such sounds as are not to be found in Arabic (*p*, *ch*, *zh*, *g*). The characters are written in a somewhat more pending manner (*Falikh*) than in Arabic, and the writing is thus slightly different from usual Arabic Neshki.

The much-spoken-of close connection between German and Persian—both of Indo-Germanic origin—is neither more nor less than a popular delusion caused by a misunderstood dictum of the philosopher 'Integri versus Persice scribi possunt quos Germani intelligat,' which was enthusiastically taken up and 'proved' by Adelung, Hammer-Purgstall, and others, and which has even led to the assumption that the Germans came direct from Persia, or that the Persians once were mixed with the Germans. We can only regard it as a philological absurdity of bygone times.

Of the Literature of the Persians be

Mohammedan conquest, we shall not speak here, but  
 to the special articles ZEND, PEHLEVI, PARSEES,  
 The literary period now under consideration  
 distinguishable by the above-mentioned infusion  
 Arabic words into the Persian language, imported  
 ther with the Koran and its teachings. The  
 Pers are, in fact, one and all, Mohammedians.  
 the fanaticism peculiar to conquering religions,  
 particularly to Islam, all the representatives  
 old Persian literature and science, men and  
 ter, were ruthlessly persecuted by Omar's general,  
 Ibn Abi Wakkas. The consequence was, that  
 the first two or three centuries after the con-  
 t, all was silence. The scholars and priests who  
 did not bow to Allah and his Prophet and to  
 new order of things, and who had found means  
 migrate, took with them what had not been  
 troved of the written monuments of their  
 ent culture; while those that remained at home  
 were forced to abandon their wonted studies.  
 by slow degrees, as is invariably the case  
 er such circumstances, the conquered race  
 rformed the culture of the conquerors to such  
 degree, that native influence soon became pre-  
 dominant in Persia, even in the matter of theo-  
 —the supreme science. It is readily granted  
 later Mohammedan writers, that it was out  
 the body of the Persians exclusively that sprang  
 foremost, if not all, the greatest scholars and  
 rors on religious as well as grammatical sub-  
 jects, historians and poets, philosophers and men of  
 science; and the only concession they made con-  
 cerned in their use of the newly-imported Arabic  
 language. A further step was taken when, after the  
 Moslem sway had ceased, the Persians, under upstart  
 Turkish dynasties, returned also to the ancient lan-  
 guage of their fathers during the first centuries of  
 Mohammedanism. The revived national feeling,  
 which must have been stirring for a long time pre-  
 viously among the masses, then suddenly burst forth  
 in prose and in verse, from the lips of a thousand  
 writers and poets. The literary life of Persia, the  
 commencement of which is thus to be placed in  
 the 9th c. A.D., continued to flourish with unabated  
 vigour for five centuries, and produced a  
 host of writers in every branch of science and  
 letters, of whom we can only here give the  
 names to the special articles throughout this  
 work. Beginning with poetry, we hear, under the  
 name of the third of the Samanides, Nasr (about 952),  
 Abul Hasan Rudegi, the blind, who rose by the  
 favour of such an eminence that he had 200  
 slaves to wait upon him. But little has remained  
 of his 1,300,000 distichs, and of his metrical trans-  
 lation of Bidpai's Fables. About 1000 A.D., we  
 find of Kabus, the Dilemite prince, as the author  
 of *The Perfection of Rhetoric*, and Poems. In the  
 reign of the Gasnevides, chiefly under Mahmud,  
 he surrounded himself with no less than 400  
 poets, we find those stars of Persian song,  
 Anvari (1039), the author of *Wamik and Aera*, and  
 100 other distichs and Kassidahs in honour and  
 praise of the king; further, Ferruchi, who, besides  
 his own poems, also wrote the first work on the  
 art of the Persian metrical art; and above all  
 Rumi (q. v.), that greatest epic poet, the author of  
*Shah-Nameh*, or Book of Kings; who led one  
 of the most brilliant and romantic lives that ever  
 shone in the lot of genius, and ended it forgotten  
 in misery. With him, but darkened by his  
 brightness, flourished Eesdi, his countryman, from  
 the time of the Seljuks.  
 Among the poets who flourished under the  
 Mongol dynasty, we find that most brilliant Persian  
 satirist, Anhad Addin Enveri, who, with his  
 wit, well knew how to handle satire. The best

of the older mystic poets of that period is Senavi  
 author of 30,000 distichs, who for his poem *Hadi-  
 kat* was nominated official singer of the Sufis. Nizami  
 (about 1200) is founder of the romantic epics; the  
 greater part of his *Chamshe*, or collection of five  
 romantic poems (*Chosru and Shirin*, *Mejnun and  
 Leila*, &c.), being almost as well known in Europe  
 as it is in the East; and to whom Kislarlan the  
 king presented for one of these poems no less  
 than fourteen estates. His grave at Gendsheh  
 is still visited by many a pious pilgrim. And  
 here we must mention that the branch of eastern  
 theosophical literature pre-eminently cultivated in  
 Persia is the mystic (Sufistic) poetry, which, under  
 Anacreontic allegories, in glowing songs of wine  
 and love, represented the mystery of divine love  
 and of the union of the soul with God (see  
 SUFISM). In this province we find chiefly eminent  
 poets like Senâji (about beginning of 13th c.),  
 and Ferid Eddin Attar (born 1216), the renowned  
 author of *Pend Nameh* (Book of Counsel), a work  
 containing the biographies of saints up to his day.  
 His principal strength, however, lay in his mystic  
 poems; and such is the depth and hidden meaning  
 of his rhymes, that for centuries after him, the  
 whole Moslem world has busied itself with com-  
 mentaries and conjectures on the meaning of a  
 great part of his sacred poetry. He died about  
 1330, more than a hundred years old, as a martyr.  
 Greater still, in this peculiar field, is Djâlal Eddin  
 Rumi, born at Balkh (died 1266), the founder of  
 a still existing most popular order of dervishes  
 (Mewlewi). His poem on *Contemplative Life* has  
 made him the oracle of oriental mysticism up to  
 this day. He wrote also a great number of lyrical  
 poems, which form, as far as they have been col-  
 lected for this special purpose, a breviary for the  
 faithful Sufi. Anhadi of Meraga (died 1297) also  
 deserves mention.

The 13th c. cannot better be closed than with  
 Sheik Muslih Eddin Sadi of Shiraz (died 1291),  
 the first and unrivalled Persian didactic poet. His  
*Bostan* and *Gulistan* (Rose- and Fruit-Garden) are  
 not only of Eastern but also of European celebrity,  
 and most deservedly, embodying as they do all the  
 mature wisdom, the grace and happiness of com-  
 position of a true poet, ripe in years as in experience.  
 At the beginning of the 14th c., we meet several  
 meritorious imitators of Sadi in didactic poetry.

But far above all these, as above all other  
 Persian lyrical and erotic poets, shines Hâfiz  
 (q. v.), the 'Sugar-lip,' who sang of wine and  
 love, and nightingales and flowers, and who so  
 offended mock-piety, that it even would have tried  
 to refuse him a proper burial, had not the oracle  
 of the Koran interposed. After him, the full glory  
 of Persian poetry begins to wane. Among those  
 that came after him, stands highest Djâmi, who  
 died in 1492, a poet of most varied genius, second  
 only in every one of the manifold branches to its  
 chief master—in panegyric to Enveri, in didactic to  
 Sâdi, in romance to Nizami, in mysticism to Jelal-  
 ed-din, in lyric to Sâdi; and he, with these and  
 Firdusi, form the brightest representatives of  
 Persian poetry. Most brilliant, however, is Djâmi as  
 a romantic poet. Of prose works, we have by him  
 a history of Sufis, and an exceedingly valuable  
 collection of epistolary models. Before concluding  
 this branch of literature, we must take notice of the  
 dramatic poetry of the Persians, which is not with-  
 out merit, but of small extent, and to be compared  
 principally with the ancient French mysteries.

The numerous tales, stories, novels, anecdotes,  
 anthologies, and all the miscellaneous entertaining  
 literature in which Persia abounds—and of which the  
 best known, perhaps, are the adaptation of Bidpai's

Fables; *Anvari Suheili*, by Husein Vais Kashifi; the *Tutinameh*, or Book of Parrots, a collection of fairy tales, by Nechshebi; the *Behari-Danish*, by Inajeth Allah, &c.—form a fit transition from poetry to prose, for little more is to be said of Persian poetry after the 15th century. Modern imitations of ancient classical works, such as the New Book of Kings, the *Shahinshah-Nameh*, which treats of modern Persian history; the *George Nameh*, which sings the English conquests in India, &c., are hardly worth pointing out in so brief a summary as ours. Of native writers on the poets, are to be named Dewlet Shah (who describes the poets from the 10th to the 15th centuries), Sam Mirsa (the poets of the 16th), and Luft Ali Beg (the poets of modern time). In prose, it is chiefly history which deserves our attention. Able rivals of the great Arabic historiographers sprang up at an early period. For the mythical times, or those of which no knowledge, save through a medium of half-legend, has reached later generations, Firdusi's gigantic epos remains the only source. But after the chroniclers we find Fadhl Allah Reshid Eddin, the vizier of Ghazan, born 1247 at Hamadan, who was executed in 1320. He wrote the *Collector of Histories*, in three volumes, to which he afterwards added a fourth geographical volume: a summary of the history of all Mohammedan countries and times, containing besides a complete history of sects. Worthy and contemporaneous rivals are Fachr Eddin Mohammed Bina Kiti, author of a universal history; and Khodja Abdallah Wassaf, the panegyrist, the model of grand and rhetorical style. His most successful imitator in the 14th c. is Abdel Reesak; and in the 15th, Sheref Eddin Ali Yezdi, who wrote the history of Timur. Up to that period, pomposity of diction was considered the principal beauty, if not the chief merit, of a classical Persian history. From the 15th c. downwards, a healthy reaction set in, and simplicity and the striving after the real representation of facts, became the predominant fashion. As the *facile princeps* among these modern historians is to be mentioned Mirkhond, whose *Universal History (Ranset Essafa)* comprises the period from creation to the reign of Sultan Hasan Beikara, in seven books. After him are to be mentioned his son Khondemir, Gaffari, Moslih Eddin Mohammed Lari, and Abu Tahir of Tortosa in Spain, who wrote the *Derab Nameh*, a biographical work on the Persian and Macedonian kings, and the ancient Greek physicians and philosophers.

Among Indian historians—and they form a most important class—who wrote in Persian, we have Mohammed Kasim Ferishtah (1640), who wrote the ancient history of India up to the European conquest; Mohammed Hashim, Abul Fadel Mobarrek (*Akbar Nameh*); further, Abdel Reesak (*History of the Padishahs*), Mirza Mehdi, Gholam Hussein Khan, and others. One of the most recent works of this description is the *Measiri Sultaniye*, which contains the history of the present dynasty of Persia, and which was published in Teheran, 1825, and translated by Bridges (Lond. 1833).

Biographies, legends, histories of martyrs, and the like are legion. Most of the biographies of the Prophet, however, are taken from the Arabic.

Little is to be said of Persian productions on special branches of exact science. There are a few works on geography—more generally treated together with history—such as those of Mestafi, Ahmin Ahmed Rasi, Berdashendi, &c. In theology, little beyond translations of the Koran, and a few commentaries on single chapters, and of some portions of the Traditions (*Sunnah*), has been produced—the Arabic works being completely sufficient, in religious matters, for all Mohammedans.

For the history of early Persian religion of importance the *Ulemai Islam* and the *Dabul* description of all the creeds of the East. prudence has likewise to shew little that is original and not mere translation, partial comments and adaptation in Persian. The *Hedadshah*, the *shah*, the *Futawa Alemgiri*, are the most important legal works to be mentioned here. A great deal has been done in the field of medicine, surgery, pharmacy, physical sciences, by Persians; but all their chief works being written in Arabic do not concern us here. Mathematics, astronomy and philosophy, have received due attention; and the art of letter-writing, metrical and poetical, have likewise been cultivated with great assiduity, but few standard works are to be enumerated. Grammar and lexicography found their principal devotees in India; and of dictionaries, the *Pershiuri*, *Burhani Katiu*, and principally the *Kutzum* (the Seven Seas), by the Sultan of Persia, deserve attention. Translations from Greek, Latin, Arabic, Turkish, and other works into Persian exist in great abundance, and some of them have paved the way to the knowledge of the original sources in Europe.—Chief authorities and works on the subject of Persian Language and Literature are Meninsky, Richardson, Lumsden, Forbes, and him De Lacy, Hammer-Purgstall, Briggs, Duperron, Stewart, Quatremere, Wilken, Defrere, Vullers, Iken, Kosegarten, Ouseley, Chardin, Land, Sprenger, Graff, Brockhaus, Dorn.

**PERSIAN POWDER**, a preparation of the flowers of the composite plant, *Pyrethrum caucasicum* or *roseum*, which are dried and pulverised. The powder has wonderful efficacy in destroying noxious insects, and is extensively used for this purpose in Russia, Persia, and Turkey. It was lately introduced into France and England, and promises to be of great use, not only in the houses of their insect pests, but in aiding the horticulturist in protecting his plants. The plant is a native of the Caucasus, where the flowers gathered wild, and sent to be manufactured at Teflis. It might readily be cultivated in any country, where its value for destroying insects alone would render it a profitable crop. Its odor is very similar to that of camomile.

**PERSIGNY**, JEAN GILBERT VICTOR, COMTE, whose proper name is FIALIN, a noted aide-de-camp of the Emperor Napoleon III., was born at Germain-Lespinnasse, in the department of the Moselle, on the 11th January 1808, entered the *École de Cavalerie* at Saumur in 1826, and obtained an appointment in the 4th regiment of hussars in 1828. At this time Fialin was royalist in his politics; but he changed to a liberal, and took an active part in the July revolution. Insubordination, however, his final expulsion from the army in 1833. A brief trial of Saint-Simonianism, Fialin was converted to the Bonapartist cause, dropped the name of Fialin, and took up that of P. (from an 'hereditary estate'), with the title of Vicomte. Introduced into the service of Louis Napoleon by the ex-king Joseph, he formed the most intimate relations with the Emperor, and commenced a career of Bonapartist proselytism throughout France and Germany, in which he displayed extraordinary energy, pertinacity, and fertility of resource. He had the chief hand in the affair of Strasburg, and subsequently apologised for its humiliating failure in a pamphlet entitled *l'Enterprize du Prince Napoleon Louis Napoleon* (1837), in which he throws the blame of the disaster on 'Fate.' He also took part in the descent on Boulogne, where, like his master, he had the misfortune to be captured, and was condemned to twenty

isonment. His confinement, however, after a time, became almost nominal, and he beguiled leisure by literary study, a partial result of which he seen in his voluminous memoir, addressed to the Institute, on the *Utilité des Pyramides Egypte* (1844). On the breaking out of the revolution in 1848, P. hurried to Paris, and set himself, with all his accustomed vigour and swiftness, to organise the Bonapartists. It is hardly too much to affirm that it was this dexterous agitator who was his master President of the Republic. He was then appointed aide-de-camp to the President, Major-general of the Parisian National Guard, perhaps with a view to future contingencies. In 1850 he was chosen a member of the Legislative Assembly, and immediately signalled himself in that assembly, as he had previously done out of France, by his absolute devotion to the policy of the Emperor. He was sent to Berlin as ambassador extraordinary in the close of the same year, and afterwards held several high diplomatic offices; took a prominent part in the *coup d'état* of December 1851; and, in January 1852, succeeded M. de Morny as Minister of the Interior. On the 27th of May following, he married a grand-daughter of Marshal Ney, when the Emperor conferred on him the title of *Comte*, and presented him with 500,000 francs. In 1855, he was named ambassador at the English court, which office he held till 1858, and again during 1859—leaving on both occasions the most favourable impression on English statesmen, by his valent diplomatic tact. In all political emergencies, he was always the most confidential and the soundest adviser of the emperor; he has also entered heartily into all his liberal commercial reforms; and though an able opponent of the extreme or anarchic opinions, he is (like a true disciple of Bonaparte) well disposed to let the ultramontane party of the Church have things their own way, as his sharp denunciation of the *Société de Saint-Vincent de Paul* (October 1861) demonstrated.

**PERSIMON.** See DATE PLUM.

**PERSIUS** (Aulus Persius Flaccus), one of the famous Roman satirists, was born at Volaterræ in Etruria, 34 A. D. He was of a distinguished Etrurian family, was educated under the care of Lucius Cornutus, lived on terms of intimacy with the most distinguished personages of his time in Rome, among whom were Lucan and Seneca, and died on the 4th November 62 A. D., in the 28th year of his life. The principal authority for the life of P. is an account of a 'commentary' by one Probus, which presents the character of the satirist in a most amiable light. Modest and gentle in his manners, virtuous and pure in his whole conduct and relations, he stands out conspicuously from the class of corrupt and profligate persons who formed the 'society' of his age; and vindicated for himself the right to be severe, by leading a blameless and solitary life. His six Satires are very commonly read with those of Juvenal. They were immensely popular in P.'s own day, and long after, all down to the middle ages. The Church Fathers, Lactantius, and Jerome, were particularly fond of him—the latter, it is said, has quite imitated his style with the expressions of the Roman satirist; but the estimate which moderns have formed of his writings, in a literary point of view, is not quite so high. They are remarkable for the sternness with which they expose the corruption of morals then prevalent in Rome, contrasting it with the old Roman simplicity and with the Stoic ideal of virtue. The language is terse, homely, and sometimes obscure, and the nature of the allusions and the expressions

used, but his dialogues are the most dramatic in the Latin tongue. The *editio princeps* appeared at Rome in 1470; later editions are those of Isaac Casaubon (Par. 1605), Passow (Leip. 1809), Jahn (Leip. 1843), and Heinrich (Leip. 1844). P. has been frequently translated; as many as fourteen English, twenty French, and considerably more German versions, being known. The two best English ones are those by Dryden and Gifford.

**PERSON** (Lat. *persona*, a mask) has come, from its original signification, to be applied to the individual wearing the mask, and thus to mean in general an individual, or a numerically distinct being. Beyond the idea of individuality, it involves that of a sentient or intelligent nature, in which it differs from 'substance' or 'thing.' The theological use of the word, although strictly identical with its philosophical signification, is made difficult of apprehension from its being applied to the Christian doctrine of the Trinity, which in itself involves a mystery. Nevertheless, when theologians declare that there are Three Persons in one God, they intend to strictly convey that each of the Three Persons is a Being individually subsisting and numerically distinct; and the difficulty of apprehension is derived, not from these terms, but from the reconciliation of the numerical distinction of Persons with the unity of the Divine Nature.

The name *Persona*, Person, was first applied to the Trinity by the Latins; the corresponding Greek word, *Πρόσωπον*, being of later use. The earlier Greek Fathers used the word *Hypostasis*, substance, where the Latins used *Persona*, and considerable controversy for a time grew out of this diverse use. It became apparent, however, that the difference was but of words; and after the condemnation of the Sabellian heresy (see SABELLIANISM), and still more after the council of Nicæa, all ambiguity of words being at an end, the controversy turned upon the substance of the doctrine, in the well-known form of the Arian controversy. See ARIUS.

**PERSONAL ACTIONS**, in English Law, are actions which are brought to try the right to damages for breach of contract, or for injuries to the person or personal estate; in contradistinction to real actions, which were designed to try the right and title to real property.

**PERSONAL EXCEPTION** means, in the Roman law, a ground of objection which applies to an individual, and prevents him doing something which, but for his conduct or situation, he might do. The term is adopted in the law of Scotland. In England, it is generally called an estoppel. Thus, a person who executes a deed is prevented by personal exception or estoppel from disputing the obligation thereby contracted, unless a case of fraud be made out.

**PERSONALTY**, in English Law, means all the property which, when a man dies, goes to his executor or administrator, as distinguished from the realty, which goes to his heir-at-law. Personality consists of money, furniture, stock in the funds; while realty consists of freehold land and rights connected with land. See **INTESTACY**, **KIN**, **NEXT OF**.

**PERSONIFICATION** (called by the Greeks *Προσωποποιεα*) is a figure of rhetoric by which inanimate objects, or mere abstract conceptions, are invested with the forms and attributes of conscious life. Oratory and poetry often derive great power and beauty from the employment of this figure. Nowhere do we find more sublime examples than in the Hebrew Scriptures, e. g., 'The sea saw it, and fled.' Such abstract conceptions as Wisdom, Justice,

## PERSONNEL—PERSPECTIVE.

Charity, are often personified in the gravest and most argumentative compositions.

**PERSONNEL**, in speaking of an army, represents the officers and soldiers, as opposed to the *matériel*, in which are comprised the guns, provisions, wagons, and stores of every description.

**PERSPECTIVE** (Lat. *persepicio*, I look through), is the art of representing natural objects upon a plane surface in such a manner that the representation shall affect the eye in the same way as the objects themselves. The distance and position of objects affect both their distinctness and apparent form, giving rise to a subdivision of perspective into *linear perspective*, which, as its name denotes, considers exclusively the effect produced by the position and distance of the observer upon the apparent form and grouping of objects; while *aerial perspective* confines itself to their *distinctness*, as modified by distance and light. The necessity of attending to the principles of perspective in all pictorial drawing is apparent when we consider, for instance, that a circle, when seen obliquely, appears to be not a circle, but an ellipse, with its shortest diameter in line with the spectator, and its longest at right angles to this. A square, when looked at from a position opposite the centre

of one of its sides, appears as a trapezoid, the sides which are perpendicular to the direction of vision appearing to be parallel, while the other two appear to converge to a point in front of the spectator, &c. For the same reason, two rows of parallel pillars of equal height, seen from a point between and equidistant from each row, appear not only to converge at the further end, but to become gradually smaller and smaller. An excellent idea of a perspective plan can be easily obtained by interposing a vertical transparent plane (as of glass—a window, for instance) between the observer and the objects of his vision, and supposing that the objects he sees are not seen *through* the glass, but painted *on* it. A sketch made on a glass plane in this position by following with a pencil all the lines and shades of the objects seen through it, the eye being all the time kept quite steady, would form a picture in perfect perspective. In practice, however, it is found, unfortunately, that glass is not a suitable material for sketching on, and that the vertical position is not the most convenient; it is therefore preferable to make a careful study of the effects produced by change of position and distance on the appearance of objects in nature, and from the results of this to compile a body of rules, by the observance of which painters may be enabled to produce an effect true to nature. After the 'scope' (i. e., the number of objects to be introduced, and the distance at which they are to be viewed) of the picture has been determined, and before the design is commenced, it is necessary to draw upon the perspective plan three lines: 1. The *base line*, or *ground line*, which limits the sketch towards the operator, and is the base line of the picture. 2. The *horizontal line*, which represents the ordinary position of the sensible horizon. The height of the horizontal line is about one-third of the height of the picture, when the sketcher is placed at or little above the level of the horizon; but it may rise in a degree corresponding to his increase of elevation till it reaches near to the top of the perspective plan. The general rule is to have a high horizontal line when the view is taken, or supposed to be

taken, from an eminence; but when the station is on a level, either actual or assumed, as is the case when a statue or a mountainous landscape is figured, the horizontal line must be low. The horizontal line in nearly all cases is supposed to be level with the spectator's eye. 3. The *vertical line*, which is drawn from the supposed position of the sketcher, perpendicular to the *ground* and *horizontal* lines, meeting the latter in a point which is called the *point of sight*, or centre of the picture. The vertical line has no representative in nature, and is merely a mechanical adjunct to the construction of the picture, all vertical lines in nature being parallel to it in the picture. The point of sight being the point directly opposite to the observer, is properly placed in the centre of the picture, for it is most natural that the view should lie symmetrically on each side of the principal visual line; but this is not by any means a universal rule, for we very frequently find it on the right or left side, but always, of course, on the horizontal line. All lines which in nature are perpendicular to the ground line, or to a vertical plane which is raised upon it as a base, meet in the point of sight, which is thus their *vanishing point* (see the line of the tops and bottoms of the pillars in fig. 1). The *points of distance* are two points in the

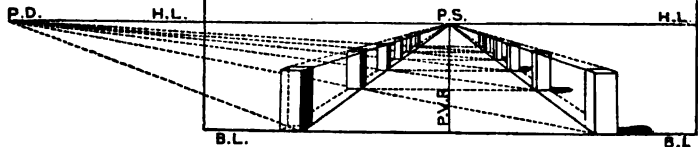

Fig. 1.

Illustrating the more important points and lines; P.V.E. is the principal visual ray.

horizontal line on each side of the point of sight, and in a 'direct' sketch are at a distance from it equal to the horizontal distance of the sketcher's eye from the ground line. The equality of distance of these points from the point of sight is not, however, necessary, as it occurs only in those cases where the lines, of which the points of distance are the *vanishing points*, are inclined (in nature) at an angle of  $45^\circ$  to the base line; but, in all cases, the two points of distance are about twice as far apart as the eye is from the picture. One important use of the points of distance is to define the distance of objects in a row (fig. 1) from each other. For this purpose, two points of distance are not necessary, as, when the position of one pillar is found, that of the one opposite is at once obtained by drawing a line parallel to the base or ground line. We have seen that the point of sight is the vanishing point of all level lines which meet the ground line or a vertical plane on it at right angles, and that the points of distance (in a *direct* picture) are the vanishing points of all lines which cut the ground line at an angle of  $45^\circ$ ; but there are many other groups of parallel lines in a picture which have different situations, and therefore different vanishing points. Such lines with their vanishing points (called, for distinction's sake, *accidental points*) are represented in fig. 2. If the accidental point is above the horizontal line, it is called the *accidental point aerial*—if below, the *accidental point terrestrial*; and a little consideration makes it evident that these points may or may not be situated within the plane of the picture. Such are the points and lines necessary for the construction of a plan in true perspective; and from the above explanation, we may deduce the two general principles: 1. That all parallel straight lines in nature are no longer parallel when projected on the

PERSPIRATION—PERTH.

perspective plane, but meet in a point which is called the vanishing point, and is some one of the three above described, unless these lines happen to be also parallel to the ground line or the vertical line, in which case they remain parallel when transferred

PERTH, a city, royal, municipal, and parliamentary burgh, and capital of the county of the same name, is situated on the right bank of the Tay, 45 miles north-north-west of Edinburgh by railway (through Fife). The charming scenery of the

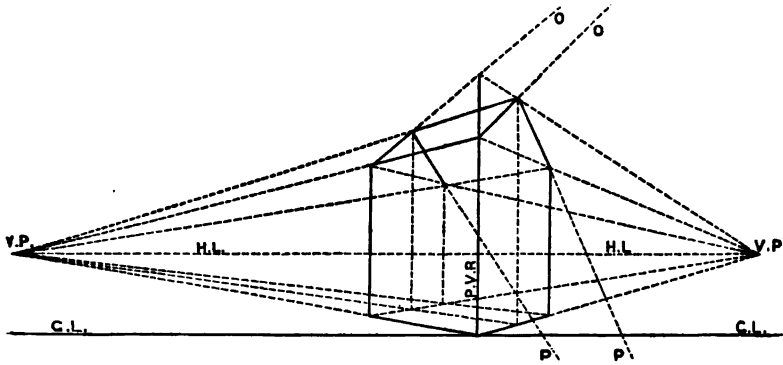

Fig. 2

The lines O O converge to the accidental point aerial, and P P to the accidental point terrestrial.

to the picture; and 2. That since the bodies drawn below the horizontal line are seen as if from above, those above as if from below, and those to the right and left of the point of sight as if observed from the left and right, it follows, that straight lines which in the picture are above the horizontal line lower themselves, those below raise themselves to it; those to the left, following the same law, direct themselves to the right, and *vice versa*.

*Aerial perspective*, consists in a modulation of the brightness and colours of objects in accordance with the state of the atmosphere, the depth of the body in the perspective plane (i. e., distance in nature from the ground line), and other accidents of place and time. As the distance of objects increases, their illuminated parts are made less brilliant, and their shaded parts more feeble. The bluish tint imparted by a large mass of the atmosphere to the bodies seen through it, is frequently imitated by the mixing of a slight tint of blue with the colours to be applied; a yellow object thus assumes a greenish tint; a red one, a violet tint, &c. The air, when charged with vapour, is represented by a diminution of the brightness of colours, and by the grayish tint imparted to them. But in this part of the subject, rules are of little avail, for experience alone can guide the painter in faithfully copying the myriad aspects presented by nature.

A thorough knowledge of perspective is a *sine qua non* to the painter or designer, and though many are inclined to think it a superfluity, and that the sketcher has only to make use of his eyes, and copy justly, the very fact that such is their opinion, shews that they have never made the attempt; for it is impossible for the painter, and much more so for the designer, to execute a copy of nature with sufficient accuracy by the sole aid of the eye and hand, a fact that is unfortunately much too frequently proved by many of the sketches exhibited in fine-art collections. Perspective was known to the ancients, but seems to have become extinct during the disturbances that convulsed Italy, and was revived by Albert Dürer, Pietro del Borgo, and Bramantino of Milan (1440), whose body of rules was extended and completed by Peruzzi and Ubaldi about 1600. Dr Brook Taylor was the first Englishman who discussed the subject scientifically. Works on perspective are now abundant in every language.

PERSPIRATION. See SWEAT.

immediate vicinity; the Tay, a broad and noble river, sweeping southward along its eastern side; and the superb background of the Grampians on the north, render the site of the 'Fair City' exceedingly interesting and beautiful; while its rank as in some sort the ancient metropolis of Scotland, the important rôle it has played in the history of the

country, and the picturesque associations with which history and fiction have invested it, claim for it a high rank among the cities of Scotland. A handsome bridge of nine arches, 880 feet in length, and stretching over a water-way 590 feet in width, connects the town with the suburb of Bridgend, on the left bank of the river. Further down, the Perth and Dundee Railway crosses the river on a fine stone and iron bridge (opened in 1864), which also admits foot-passengers. The appearance of P. is much enhanced by two beautiful public parks, called the North and South Inches. The water-supply, obtained from the Tay, is filtered, raised by steam into two elevated reservoirs, and thence distributed over the town, rising to the upper stories of the highest houses. Among the most interesting public buildings are the church of St John, an ancient structure in the Pointed Style, surmounted by a massive square tower; the County Buildings, a Grecian edifice; the local prison, and the Penitentiary or General Prison, formerly used as a dépôt for French prisoners, and now one of the largest buildings of the kind in Scotland. The Penitentiary is the General Prison for Scotland, and all criminals sentenced to imprisonment for long periods are confined here. The town also contains a statue of the late Prince Consort, erected in 1864; Marshall's Monument, erected in honour of a former lord provost, and containing a public library and the Museum of the Antiquarian and Natural History Society; Sharp's, and other educational institutions. The river is navigable to P. for vessels of considerable burden. Wincey and striped shirting are manufactured; gloves, which at one time were a staple manufacture, are no longer made. There are dye-works, iron-foundries, breweries, &c.; and ship-building is also carried on. The salmon-fishery on the Tay is very valuable (250 tons of fish being exported annually to London alone). In 1863, 372 vessels, of 25,301 tons, entered and cleared the port. Five fairs are held annually, and horse-races take place every year on the North Inch. P. has a charter as a royal burgh from King William the Lion (1165—1214). It returns a member to the House of Commons. Pop. (1861) of royal burgh, 13,814; of parliamentary burgh, 25,250.

PERTH, THE FIVE ARTICLES of, memorable in the ecclesiastical history of Scotland, were five articles agreed upon in a meeting of the General Assembly of the Church of Scotland, convened at



Perth, by command of James VI., on 25th August 1618. These Articles enjoined kneeling at the Lord's Supper, the observance of Christmas, Good Friday, Easter, and Pentecost, and confirmation, and sanctioned the private administration of baptism and of the Lord's Supper. They were highly obnoxious to the Presbyterians of Scotland, not only on their own account, but as part of an attempt to change the whole constitution of the church; and because they were adopted without free discussion in the Assembly, and in mere compliance with the will of the king, who was also regarded as having unduly interfered with the constitution of the Assembly itself. They were, however, ratified by the parliament on 4th August 1621—a day long remembered in Scotland as *Black Saturday*—were enforced by the Court of High Commission, and became one of the chief subjects of that contention between the king and the people, which produced results so grave and sad for both, in the subsequent reign. The General Assembly of Glasgow, in 1638, declared that of Perth to have been 'unfree, unlawful, and null,' and condemned the Five Articles.

PERTHES, FRIEDRICH CHRISTOPH, an eminent German publisher, distinguished not only in his professional capacity, but for his sincere piety and ardent patriotism, was born at Rudolstadt, 21st April 1772. In his 15th year, he was apprenticed to a Leipzig bookseller, with whom he remained six years, devoting much of his leisure time to the acquisition of knowledge. In 1793, he passed into the establishment of Hoffmann, the Hamburg bookseller; and in 1796, started business on his own account; and, by his keen and wide appreciation of the public wants, his untiring diligence, and his honourable reputation, he ultimately made it the most extensive of the kind in modern Germany. During the first few years or so of his Hamburg apprenticeship, his more intimate friends had been either Kantian or sceptical in their opinions, and P., who was not distinguished for either learning or speculative talent, had learned to think with his friends; but a friendship which he subsequently formed with Jacobi (q. v.), and the Holstein poet and humorist, Matthias Claudius, led him into a serious but liberal Christianity. The iron rule of the French in Northern Germany, and the prohibition of intercourse with England, nearly ruined trade, yet P., even in this great crisis of affairs, found ways and means to extend his. He endeavoured to enlist the intellect of Germany on the side of patriotism, and in 1810 started the *National Museum*, with contributions from Jean Paul Richter, Count Stolberg, Claudius, Fouqué, Heeren, Sartorius, Schlegel, Görres, Arndt, and other eminent men. Its success was far beyond P.'s expectations, and encouraged him to continue his patriotic activity, till Hamburg was formally incorporated with the French empire. He subsequently took a prominent part in forcing the French garrison to evacuate Hamburg, 12th March 1813; and on its re-occupation by the French, he was one of the *ten* Hamburgers who were specially excepted from pardon. After peace had been restored to Europe, P. steadily devoted himself to the extension of his business, and to the consolidation of the sentiment of German national unity, as far as that could be accomplished by literature and speech. In 1822, he removed to Gotha, transferring his Hamburg business to his partner Besser. Here he laid himself out mainly for the publication of great historical and theological works. His subsequent correspondence with literary, political, and theological notabilities—such as Niebuhr (one of his dearest friends), Neander, Schleiermacher, Lücke, Nitzsch, Tholuck, Schelling, and Umbreit—

is extremely interesting, and throws a rich light upon the recent inner life of Germany. P. died 18th May 1843.—See *Friedrich Perthes Leben* (Leipzig, edit. 1853), written by his second son, C. Perthes, Theodor Perthes, Professor of Law at Bonn, and uncle of Friedrich Christoph P. was JOHANN JUSTUS PERTHES, who established a publishing and bookselling house at Gotha in 1785, which was acquired, in the hands of his sons, a great reputation, and from which issues the famous *Atlas de Gotha*.

PERTHSHIRE, one of the most important counties in Scotland, is bounded on the north by the shires of Stirling and Clackmannan; on the N. by Inverness and Aberdeen; on the W. by the Argyle and Dumbarton; and on the E. by Fifeshire and Kinross. It extends from east to west about 70 miles, and from north to south about 40 miles. Its area is 2834 miles, or 1,814,063 acres, of which above 32,000 are covered with water. The county is divided into the Highland and Lowland districts, the former occupying much the larger portion, and these are subdivided into 10 divisions: Menteith, Strathearn, Gowrie, Stormont, Perth, Arde, Glenshee, Athole, Breadalbane, Rannoch, and Balquidder. P., from its insular position and its advantages, has a comparatively mild climate, and fertile soil, in Strathearn, Cars of Gowrie, and other less extensive tracts, being mostly composed of rich loam, crops of all kinds are brought to the utmost perfection. These districts are also well adapted for their fruit and floral productions. P. is distinguished for its magnificent mountains and river scenery. The Grampians here attain nearly their maximum height, Ben Lawers, within a few feet of 4000 in altitude; while Ben More is 3818; and several others above 3000 feet. There are numerous lakes, the principal of which are Lochs Tay, Ericht, Rannoch, Tummel, Loch Garry, Lyon, and Dochart. There are several streams of note, the principal being the Tay, which is fed by numerous other streams, and discharges as much water into the sea as any other river in the kingdom. These lakes and streams afford excellent fishing, and the Tay is valuable for its salmon, yielding in rent about £12,000 a year.

According to the last agricultural statistics published in 1857, the number of occupants was 361,000; the acreage under rotation of grass and herbage was 99,656, and under crops 267,397; of which there were in wheat, 25,638 acres, averaging 25 1/2 bushels 3/4 pecks per acre; in barley, 18,802 acres, averaging 31 bushels 1/4 peck per acre; in oats, 100,000 acres, averaging 35 bushels 1/4 peck per acre; in corn, 655 acres, averaging 30 bushels 3/4 pecks per acre; in beans and peas, 4250 acres, averaging 21 bushels 3/4 pecks per acre; in turnips, 100,000 acres, averaging 13 tons per acre; in potatoes, 17,482 acres, averaging 2 tons 11 1/4 cwt. per acre. Of live stock there were—horses, 15,953; oxen, 80,716; sheep, 544,742; swine, 9369.—Total value, £650,780.

The above statistics show that there are more occupants or tenants in this county than in any other in Scotland with the exception of Aberdeenshire, where there are more than double the number. The acreage under crop is also greater, with the above exception; while the average production of wheat, barley, and turnips is less than in 24 of the 32 counties. Of oats the average is less than in 14 counties, and of potatoes less than in 22. The stock exceeds in value any other county, Aberdeen excepted, and outnumbers all except Argyle, which possesses 827,000 sheep. The old valuation of the county was £28,330; the new valuation for 1862 was £732,766, exclusive of railways. The

ments on the land for 1863—1864 amounted to £100.

Old Red Sandstone, granite, and slate abound. The county is situated some of the steepest hills in Scotland, but, except Scone Palace, none contain any historical memorials; and the objects of interest to the antiquarian are confined to the ruins of Dunblane and Dunkeld, the Abbey of St. Andrews, and a few Druidical and Roman remains. There are two royal burghs, Perth and Culross, in which there are several villages of considerable size, where trade in flax, &c. is carried on to a great extent. The population in 1861 was 133,500; in 1863, 132,035; parliamentary constituencies in 1863, was 3541.

**P**ERTINAX, HELVIUS, Roman emperor, was according to Dio Cassius, at Alba-Pompeia, a colony of Liguria, August 1, 126 A. D. He received a good education, and, entering the military service, rose through the various grades till he obtained the command of the first legion, at which he signalised himself in Rhetia and against the native tribes. In 179, he was consul, aided to repress the revolt of Avitus, and was governor successively of the provinces of Moesia, Dacia, and Syria. Being sent Emperor Commodus to take the command of the turbulent legions in Britain, these troops, at his will, proclaimed him emperor; on which he was recalled, and was appointed consul of Africa, prefect of Rome, and consul for the second time in 192. On the death of Commodus, his assassins almost forced P. to accept the purple, which with great hesitation he did; in spite of his promise of a large donation, he was unable to gain over the pretorian guard. His accession was, however, hailed with delight by the senate and people, who were rejoiced to see a ruler, an able captain, instead of a debauchee; and P., encouraged by this reception, announced his intention of carrying out an extensive series of reforms, having directed chiefly to the army, in which he hoped to re-establish the ancient Roman discipline. Unforeseen by his reforms and himself, he was attacked by a revolt of the rebellious prætorians, two months and a half after his accession; and, after a bloody struggle, he was slain, and his head carried in triumph through the streets of Rome in triumph. From his military talents and talents (except in military affairs); the respect and esteem in which he was held by the senate and people of Rome, argue well in his disposition.

**P**ERTURBATIONS, in Physical Astronomy, are disturbances produced in the simple elliptic motion of one heavenly body about another, by the attraction of a third body, or by the non-sphericity of the principal body. Thus, for instance, were there no disturbing forces in space except the earth and moon, the moon would describe accurately an ellipse about the earth as focus, and its radius-vector would sweep equal areas in equal times; but only if the earth were homogeneous and truly spherical, or if its constituent matter otherwise so arranged as to attract each other as if each were at some definite point of its mass. The irregularities of the earth's figure, therefore, produces perturbations in what would otherwise be the fixed orbit of the moon. Again, when we consider the action, it is obvious that in no position of the moon can the sun act equally upon both earth and moon; for at new moon, the moon is nearer to the sun than the earth is, and is therefore more (in proportion to its mass) than the earth

—that is, the *difference* of the sun's actions on the earth and moon is equivalent to a force tending to draw the moon away from the earth. At full moon, on the other hand, the earth (in proportion to its mass) is more attracted than the moon is by the sun; and the perturbing influence of the sun is again of the nature of a force tending to separate the earth and moon. About the quarters, on the other hand, the sun's attraction (mass for mass) is nearly the same in amount on the earth and moon, but the *direction* of its action is not the same on the two bodies, and it is easy to see that in this case the perturbing force tends to bring the earth and moon nearer to each other. For any given position of the moon, with reference to the earth and sun, the *difference* of the accelerating effects of the sun on the earth and moon is a disturbing force; and it is to this that the perturbations of the moon's orbit, which are the most important, and amongst the most considerable, in the solar system, are due. [By the word *difference*, just employed, we are of course to understand, not the arithmetical difference, but the resultant of the sun's direct acceleration of the moon, combined with that on the earth reversed in direction and magnitude; as it is only with the *relative* motions of the earth and moon that we are concerned.] This disturbing force may be resolved into three components; for instance, we may have one in the line joining the earth and moon, another parallel to the plane of the ecliptic, and perpendicular to the moon's radius-vector, and a third perpendicular to the plane of the ecliptic. The first component, as we have already seen, tends to separate the earth and moon at new and full, and to bring them closer at the quarters; but during a whole revolution of the moon, the latter tendency is more than neutralised by the former; that is, in consequence of the sun's disturbing force, the moon is virtually less attracted by the earth than it would have been had the sun been absent. The second component mainly tends to accelerate the moon's motion in some parts of its orbit, and to retard it at others. The third component tends, on the whole, to draw the moon towards the plane of the ecliptic. We cannot, of course, enter here into even a complete sketch of the analysis of such a question as this; but we may give one or two very simple considerations which will, at all events, indicate the nature of the grand problem of perturbations.

The method, originally suggested by Newton, which is found on the whole to be the most satisfactory in these investigations, is what is called the *Variation of Parameters*, and admits of very simple explanation. The path which a disturbed body pursues is, of course, no longer an ellipse, nor is it in general either a plane curve or re-entrant. But *it may be considered to be an ellipse which is undergoing slow modifications in form, position, and dimensions, by the agency of the disturbing forces.* In fact, it is obvious that any small arc of the actual orbit is a portion of the elliptic orbit which the body would pursue for ever afterwards, if the disturbing forces were suddenly to cease as it moved in that arc. The *parameters*, then, are the elements of the orbit; that is, its major axis, eccentricity, longitude of apse, longitude of node, inclination to the ecliptic, and epoch; the latter quantity indicating the time at which the body passed through a particular point, as the apse, of its orbit. If these be given, the orbit is completely known, with the body's position in it at any given instant. If there be no disturbing forces, all these quantities are constant; and therefore, when the disturbing forces are taken into account, they change very slowly, as the disturbing forces are in most cases very small. To give an instance of the nature of their

PERTURBATIONS.

changes, let us roughly consider one or two simple cases. First, to find the nature of some of the effects of a disturbing force acting in the radius-vector, and tending to draw the disturbed, from the central, body. Let  $S$  be the focus,  $P$  the nearer apse, of the undisturbed elliptic orbit. When the moving body passes the point  $M$ , the tendency of the disturbing force is to make it describe the dotted curve in the figure—i. e., the new direction

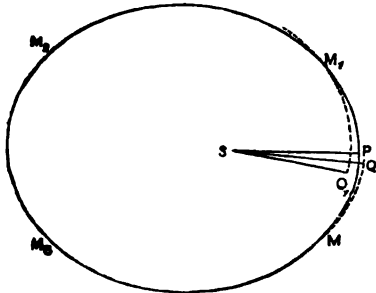

Fig. 1.

of motion will make with the line  $MS$  an angle more nearly equal to a right angle than before; and therefore the apse  $Q$  in the disturbed orbit will be sooner arrived at than  $P$  would have been in the undisturbed orbit—that is, the apse *regre-des*, or revolves in the contrary sense to that of  $M$ 's motion. Similarly, the effect at  $M_1$  is also to make the apse *regre-de* to  $Q_1$ . At  $M_2$  and  $M_3$ , on the other hand, the tendency is to make the apse *progre-de*. Also, as the velocity is scarcely altered by such a force, the major axis remains unaltered. Thus at  $M$  the eccentricity is diminished, and at  $M_1$  increased, since the apsidal distance is increased at  $M$ , and diminished at  $M_1$ .

Next, consider a tangential accelerating force. Here the immediate effect is to increase the velocity at any point of the orbit, and therefore to make it correspond to a larger orbit, and, consequently, a longer periodic time. Conversely, a retarding force, such as the resistance of a medium, diminishes the velocity at each point, and thus makes the motion correspond to that in an ellipse with a less major axis, and therefore with a diminished periodic time. This singular result, that the periodic time of a body is *diminished* by resistance, is realised in the case of Encke's comet, and this observed effect furnishes one of the most convincing proofs of the existence of a resisting medium in interplanetary space.

Again, the effect of a disturbing force continually directed towards the plane of the ecliptic, is to make the node *regre-de*. Thus, if  $N'N$  represent

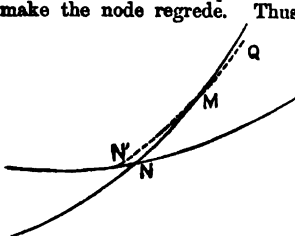

Fig. 2.

the ecliptic is diminished, when the planet has just passed the ascending node. In the second figure, let  $M_1$  be a position of the planet near the descending node  $N_1$ . The effect of the disturbing force is to alter the orbit to  $MN_1'$ . Thus, again,

the node *regre-des*, but the inclination is increased. If  $NN'$  and  $N_1N_1'$  in these figures represent the

earth's equator, the above rough sketch applies exactly to the case of the moon as disturbed by the oblateness of the earth. The reaction of the moon on the earth

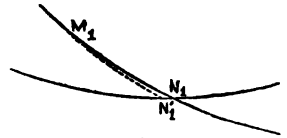

Fig. 3.

gives rise to the Precession of the Equinoxes (q. v.).

By processes of this nature, Newton subjected the variation of the elements of the moon's orbit to calculation, and obtained the complete explanation of some of the most important of the lunar inequalities. See MOON. Others of them—for instance, the rate of progression of the apse—cannot be deduced with any accuracy by these rough investigations, but tax, in some cases, the utmost resources of analysis. Newton's calculation of the rate of the moon's apse was only about half the observed value; and Clairaut was on the point of publishing a pamphlet, in which a new form was suggested for the law of gravitation, in order to account for the deficiency of this estimate; when he found, by carrying his analysis further, that the expression sought is obtainable in the form of a slowly converging series, of which the second term is nearly as large as the first. The error of the modern Lunar Tables, founded almost entirely on analysis, with the necessary introduction of a few data from observation, rarely amounts to a *second* of arc; and the moon's place is predicted four years beforehand, in the *Nautical Almanac*, with a degree of precision which no mere observer could attain even from one day to the next. This is the true proof, not only of the law of gravitation, but of the Laws of Motion (q. v.), upon which, of course, the analytical investigation is based.

With respect to the mutual perturbations of the planets, we may merely mention that they are divisible into two classes, called *periodic* and *secular*. The former depend upon the configurations of the system—such, for instance, is the diminution of the inclination of the moon's orbit, after passing the ascending node on the earth's equator, already mentioned, or its increase as the moon comes to the descending node. The secular perturbations depend upon the period in which a complete series of such alternations have been gone through, and have, in the case of the planets, complete cycles measured by hundreds of years.

A very curious kind of perturbation is seen in the *indirect* action of the planets on the moon. There is a secular change of the eccentricity of the earth's orbit, due to planetary action, and this brings the sun, on the average, nearer to the earth and moon for a long period of years, then for an equal period takes it further off. One of the effects of the sun's disturbing force being, as we have seen, to diminish, on the whole, the moon's gravity towards the earth, this diminution will vary in the same period as the eccentricity of the earth's orbit; and therefore the moon's mean motion will be alternately accelerated and retarded, each process occupying an immense period.

With special reference to the planetary motions, we may notice that the major axis of each planetary orbit is free from all secular variations; and those affecting the inclination and eccentricity are confined within small limits, and ultimately compensate themselves. These facts, which have been clearly and beautifully demonstrated by Laplace and Lagrange, assure the stability of the planetary orbits, if we neglect the effects of resistance due to

## PERU.

the interplanetary matter; which, however, must, in the long run, bring all the bodies of the system into collision with the sun, and finally stop the rotation of the sun itself.

Newton commenced the investigation of perturbations by considering those of the moon; Euler followed with a calculation of Saturn's inequalities; while Clairaut, D'Alembert, and others successively gave those of the other planets.

Every one knows that it was by observing the perturbations of Uranus, and thence discovering the direction of the disturbing force, that Adams and Leverrier were led to their great and simultaneous discovery of the planet Neptune.

**PERU**, an important maritime republic of South America, bounded on the N. by Ecuador, on the W. by the Pacific, on the S. and S.E. by Bolivia, and on the E. by Brazil. It lies in lat.  $3^{\circ} 25' - 21^{\circ} 30' S.$ , and in long.  $68^{\circ} - 81^{\circ} 20' W.$  The general outline resembles a triangle, the base of which is formed by the boundary-line between P. and Ecuador on the north. Its area is estimated at upwards of 500,000 square miles; and its population at 2,200,000. The area of P., however, can only be given approximately, as, on the east side of the Andes, and between the Amazon and the Purus, there is a wide and unexplored expanse of country, upon which both P. and Brazil have claims, which have not yet been determined. The country is 1100 miles in length, 780 miles in extreme breadth along the northern boundary, but is little more than 50 miles wide in the extreme south. Following the general direction, and not including windings, the coast-line is 1660 miles in length. The shores are in general rocky and steep; in the south, lofty cliffs rise from the sea, and, in some places, the water close inshore has a depth of from 70 to 80 fathoms. Further north, however, sandy beaches occur, and in the extreme north, the shores are often low and sandy, and covered with brushwood. Owing to the comparative unfrequency of bays and inlets along the coast, the harbours are few and unimportant. Those of Callao (the port of Lima) and Payta afford the most secure anchorage, and the others are Trujillo, Cañete, Pisco, Camaná, Islay, Ilo, Arica, and Iniquique. Landing by boats is always dangerous, on account of the dreaded surf, occasioned by the swell of the Pacific, which perpetually beats upon the coast; and when goods or passengers require to be landed on unsheltered shores, recourse is had to the primitive *balsa*, or rafts, worked by the natives, and capable of carrying two or three persons.

**Islands.**—The islands on the Peruvian coast, although valuable, are extremely few in number, and small in extent. In the north, are the Lobos (i. e., *Seal*) Islands, forming a group of three, and so called from the seals which frequent them. The largest of them, Lobos de Tierra, is 5 miles long by 2 miles broad, and the others, lying 30 miles south-west, are much smaller. On their eastern and more sheltered sides, they are covered with guano, and the quantity on the whole group is stated at 4,000,000 tons. The Chincha Islands, famous as the source from which Europe has been supplied with Peruvian guano (see **GUANO**) since 1841, also form a group of three, and are situated in the Bay of Pisco, about 12 miles from the mainland, and in lat.  $13^{\circ} - 14^{\circ} S.$ , long.  $76^{\circ} - 77^{\circ} W.$  They lie in a line running north and south, and are called the North, Middle, and South Islands respectively. They closely resemble each other in size, formation, and general character. Each island presents, on the eastern side, a wall of precipitous rock, with rocky pinnacles in the centre, and with a general slope towards the western shore. The cavities and

inequalities of the surface are filled with guano, and this material covers the western slopes of the islands to within a few feet of the water's edge. There is no vegetation. The North Island has an area of 20½ acres. It is formed of felspar and quartz, and is slowly but certainly decreasing in size. This island is wholly covered with thick layers of guano, which is quarried in some places to a depth of 80 feet. Two hundred convicts are employed here in cutting the guano and loading the vessels. The Middle Island, on which there are 140 acres occupied by guano, has been worked to some extent, and in this case the labourers are Chinese. It was estimated that in 1861, there were still lying on the islands about 9,538,735 tons of guano, which, at the present rate of consumption, will last until the year 1883. The island of San Lorenzo forms the harbour of Callao.

The grand physical feature of the country, and the source of all its mineral wealth, is the great mountain system of the Andes. A general description of the formation and character of the Peruvian Andes is given under the article **ANDES** (q. v.).

**Surface, Soil, and Climate.**—The surface of P. is divided into three distinct and well-defined tracts or belts, the climates of which are of every variety from torrid heat to arctic cold, and the productions of which range from the stunted herbage of the high mountain-slopes, to the oranges and citrons, the sugar-canes and cottons, of the luxuriant tropical valleys. These three regions are the *Coast*, the *Sierra*, and the *Montaña*.—The *Coast* is a narrow strip of sandy desert between the base of the Western Cordillera and the sea, and extending along the whole length of the country. This tract, varying in breadth from 30 to 60 miles, slopes to the shore with an uneven surface, marked by arid ridges from the Cordillera, and with a rapid descent. It is for the most part a barren waste of sand, traversed, however, by numerous valleys of astonishing fertility, most of which are watered by streams, that have their sources high on the slopes of the Cordillera. Many of the streams are dry during the greater part of the year. Between these valleys extend deserts, which are sometimes 90 miles in width. These are perfectly trackless, being covered with a fine, shifting, yellow sand, which is often carried about by the wind in pillars of from 80 to 100 feet in height. In the coast-region, properly so called, rain is unknown. This is caused by the coast of P. being within the region of perpetual south-east trade-winds. These winds, charged with vapours from the Atlantic, strike upon the east coast of South America, and traverse that continent obliquely, distributing rains over Brazil. But their vapour is thoroughly condensed by the lofty Cordilleras, and their last particles of moisture are exhausted in powdering the summits of these ranges with snow, after which they fall down upon the coast of P., cool and dry. The want of rain, however, is compensated for to some extent by abundant and refreshing dews, which fall during the night. The climate of the coast is modified by the cool winds. In the valleys, the heat, though considerable, is not oppressive. The highest temperature observed at Lima in summer is  $85^{\circ}$ , the lowest in winter is  $61^{\circ} F.$

The *Sierra* embraces all the mountainous region between the western base of the maritime Cordillera and the eastern base of the Andes, or the Eastern Cordillera. These ranges are, in this country, about 100 miles apart on an average, and have been estimated to cover an area of 200,000 square miles. Transverse branches connect the one range with the other, and high plateaux, fertile plains, and deep tropical valleys lie between the lofty outer barriers.

The superiority in elevation alternates between the two principal ranges. The east range, or, as it is generally called, the Andes, has the superiority in height in the southern half of this mountain system. It abuts upon the plain, from the Bolivian frontier, in a majestic mass, surmounted by stupendous pinnacles, rugged in outline, and most frequently rising in splintered needle-like peaks, covered with snow. North of lat. 13° S., however, the Western Cordillera assumes the grander character, and preserves it until it crosses the northern frontier. The scenery of the Western Cordillera is broader and more massive in character, and its summits less pointed than those of the Andes. Rugged paths, sometimes so narrow as barely to afford footing to the mules which are invariably used in such ascents, lead up its steep sides. Occasionally, from these narrow passes, gaping and apparently bottomless precipices slide perpendicularly downward from the very feet of the traveller, and the prospect is rendered still more hideous by the distant roar of a torrent, hidden by mists, at the bottom of the ravine. Occasionally, also, the mountain route leads over abysses 500 feet in depth, across which, by way of bridge, a few poles are thrown, which roll about in an uncomfortable manner under the feet. In traversing these dangerous passes, which line the huge rocks like aerial threads, the traveller often comes upon scenery of the most picturesque and beautiful description. The clefts and sides of the hills, even at altitudes which might be called alpine, are clothed with wild-flowers, many of which, now long cultivated in Britain, have become highly prized among us as garden-plants. Verbenas, lupines, blue and scarlet salvias, fuchsias, calceolarias, and the fragrant heliotrope, add a sense of beauty to the sense of power which the stupendous scenery imparts. The following are the most striking and distinctive physical features of the Sierra, beginning from the south: 1. The plain of Titicaca, partly in P., and partly in Bolivia, is enclosed between the two main ridges of the Andes, and is said to have an area of 30,000 miles—greater than that of Ireland. In its centre is the great Lake Titicaca, 12,846 feet above sea-level, or 1600 feet above the loftiest mountain pass (the Col of Mont Cervin) of Europe. The lake is 115 miles long, from 30 to 60 miles broad, from 70 to 180 feet deep, and 400 miles in circumference. Its shape is irregular; it contains many islands, and several peninsulas abut upon its waters. 2. The Knot of Cuzco. The mountain-chains which girdle the plain of Titicaca trend toward the north-west, and form what is called the Knot of Cuzco. The Knot comprises six minor mountain-chains, and has an area thrice larger than that of Switzerland. Here the valleys enjoy an Indian climate, and are rich in tropical productions; to the north and east of the Knot extend luxuriant tropical forests, while the numberless mountain-slopes are covered with waving crops of wheat, barley, and other cereals, and with potatoes; and higher up, extend pasture-lands, where the vicuña and alpaca feed. 3. The valley of the Apurimac, 30 miles in average breadth, and extending north-west for about 300 miles. This valley is the most populous region of Peru. 4. The Knot of Pasco. From Cuzco proceed two chains toward the north-west; they unite again in the Knot of Pasco. This Knot contains the table-land of Bombon, 12,300 feet above sea-level; as well as other table-lands at a height of 14,000 feet, the highest in the Andes; otherwise, however, the physical features of the country resemble those of the vicinity of Cuzco. 5. The vale of the river Marañon. This valley, which is upwards of 300 miles in length, is narrow, deep, and nearer the equator than any

other valley of the Sierra, and consequently the hottest portion of this region; and its position is thoroughly tropical in character. The formation of the surface of the Sierra is of wonderful description. After the table-lands of Tibet, those of the Peruvian Andes are the most wonderful in the world; but, unlike those of Tibet, they are mere grassy uplands, the table-lands are the seat of a comparatively high civilization, and are studded over with towns and villages on heights exceeding in elevation the summits of Jungfrau and the Wetterhorn. Nor are they the mere cryeries of miners who are tempted to such heights in search of the precious metals, even at this elevation, the climate is pleasant. Wheat, maize, barley, rye, and potatoes grow well. The city of Cuzco, situated in a rare beauty, and enjoying a temperate climate, is 11,380 feet above sea-level, or 2000 feet higher than the Great St Bernard. The climate of the Cordillera, however, is not always so charming. In some terms, it may be described as mild and healthy, with moderate rains. In the district of Tumbuco, rain falls 300 days in the year. A climate, however, of such an uneven surface, of snow-capped peaks and tropical valleys, embraces every variety of climate. In all the lower regions of the Cordillera the climate is warm, but healthy; in the higher, and on the highest plateaux, it is often violent. Violent storms beat upon the plain of Titicaca, terrific tempests, accompanied with thunder and lightning, roll frequently around the table-lands of Pasco (q. v.); where, indeed, the climate is so high that but for the mines, which have attracted a numerous population, this region might have remained uninhabited. At the height of 9,000 feet above sea-level, the mean temperature is 60° F., and the variation throughout the year is not more than 10°. The highest peaks of the country reach to a height of 22,000 feet, and many peaks in both ranges rise from 17,000 to 20,000 feet high. In the Western Cordillera, and in the south of the country, are four volcanoes—Candarave, Ubinas, Omas, and Arequipa. The soil of the Sierra is of great fertility, but wherever it is cultivated, it is productive.

The *Montaña*, forming two-thirds of the area of the country, stretches away for hundreds of leagues eastward from the Andes to the coast of Brazil. On the N., it is bounded by the Cordillera, on the S. by Bolivia. It consists of vast tracts of fertile forests and alluvial plains, is rich in productions of tropical latitudes, is of inexhaustible fertility, and teems with animal and vegetable life. It is still, however, almost wholly unproductive. The silence of its central forests has never been disturbed by the civilised explorer, and human inhabitants are a few scattered tribes of Indians. The *Montaña* is watered by numerous streams, and by a large number of important rivers. It belongs wholly to the basin of the Amazon. Along the head-waters of the Purus, which flows through beautiful forest-covered plains, about 60 miles from Cuzco, there were at one time numerous Spanish farms, where great tracts of forest had been cleared, and where crops of cocoa, sugar, and other tropical productions were regularly raised. These farms have since been abandoned, and the encroaching forest has obliterated their sites. The upper waters of the Purus are the headquarters of a savage and barbarously cruel tribe of wild Indians called Cuzco. These untamable savages have shewn the most hostility to the advance of civilisation, and have murdered the settlers, or drove them to take refuge in some less advanced settlement. W. Markham visited this region in 1873. A few

PERU.

isted; from a paper, however, which he com-  
 ates to the *Journal of the Royal Geographical*  
 , and which is dated 1861, it would appear  
 the Chunchos have finished their barbarous  
 for the settlers have either all been massacred  
 ven back from the forest, so that now not a  
 settlement remains. The rich valleys of Pau-  
 abo, once covered with flourishing Spanish  
 have again become one vast tropical forest.  
 The virgin soil of the Montaña is of amazing  
 y; while its climate, though not oppressively  
 healthy. The forests consist of huge trees,  
 hich some are remarkable for the beauty of  
 wood, others for their valuable gums and  
 and others as timber trees. A rank under-  
 of vegetation covers the country, and the  
 are often chained together and festooned with  
 es and closely-matted creepers. In this  
 for the most part undisturbed by the voice  
 , civilised or savage, animal life flourishes in  
 a variety, and birds of the brightest plumage  
 ong the foliage. Among the products which  
 elded here in spontaneous abundance, are the  
 ble Peruvian bark (see CIPCCHONA), India-  
 , gum-copal, vanilla, indigo, copaiaba, balsam,  
 on, sarsaparilla, ipecacuanha, vegetable wax,  
 n the western fringe of the Montaña, where  
 are still a few settlements, tobacco, sugar,  
 cotton, and chocolate, are cultivated with  
 te success.

*Hydrography.*—The hydrography of P. may be  
 o be divided into three systems—those of  
 Titicaca, the Pacific, and the Amazon. The  
 s that flow into Lake Titicaca are few and  
 derable. The rivers which, having their  
 in the Western Cordillera, flow west into  
 ific, are about 60 in number; but many of  
 re dry in summer, and even the more import-  
 rapid and shallow, have a short course, are  
 rrigable even for canoes, and are mainly used  
 purpose of irrigation. All the great rivers  
 u are tributaries of the Amazon. The  
 on, rising between the Eastern and Western  
 eras, and flowing tortuously to the north-  
 west, is generally considered to be the head-  
 of the Amazon (q. v.). The Huallaga rises  
 e town of Huanuco, and flows northward to  
 amazon. It is navigable for 600 miles, the  
 f its navigation (for canoes) being at Tingo  
 within 100 miles of its source. The Yuca-  
 Ucayali, an immense river, enters the Amazon  
 les below the Huallaga. Its tributaries and  
 waters, among which are the Pampas and the  
 ac, drain the greater portion of the Peruvian  
 The Purus, which reaches to the valleys of  
 canbo, within 60 miles of Cuzco, has not yet  
 xplored. We know several of its sources,  
 at it enters the Amazon by four mouths, a  
 ove Barra. It flows through what is per-  
 e richest and most beautiful region of Peru.  
 attempts have been made to explore this  
 one of which, however, down to 1862, appear  
 met with any success. The facilities which  
 to afford for the transport of most valuable  
 s, have long been acknowledged by the  
 n government. One of the chief head-waters  
 Purus is the Madre de Dios. In 1861—1862,  
 dition, consisting of a company of young men  
 ity of Cuzco, was organised, with the view of  
 ting to the Madre de Dios, and establishing  
 n of navigation thence by the Purus to the  
 l. Should they meet with success in their  
 ur to open up the great fluvial highways  
 region, most important agricultural and  
 cial results may be expected.

*Productions, Exports and Imports, Revenue, &c.*—

The wealth and resources of P. consist, not in manu-  
 factures, but entirely in mineral, vegetable, and  
 animal products. As no statistics are taken in the  
 country it is impossible to give the quantity and  
 value of the productions, and of the exports and  
 imports, even approximately. Of the precious  
 metals, the production has greatly fallen off since  
 P. became an independent state; and this country,  
 which once stood in the same relation to Spain that  
 Australia does to Great Britain, now contributes  
 little to the metallic wealth of the world. The  
 immense stores of gold and silver found here by the  
 Spanish invaders represented the accumulation of  
 centuries, and that among a people who used the  
 precious metals only for the purposes of ornamenta-  
 tion. Nevertheless, P. possesses vast metallic riches.  
 The Andes abound in mines of gold, silver, copper,  
 lead, bismuth, &c.; and in the Montaña, gold is  
 said to exist in abundance in veins and in pools on  
 the margins of rivers. The export of specie, of  
 which a portion consisted in coined money and  
 plate, amounted in 1859, according to Mr Mark-  
 ham, to only £200,000. This comparatively insigni-  
 ficant amount of produce in a country so rich in  
 the precious metals, is to be accounted for chiefly  
 by the unscientific and improvident manner in  
 which the mining operations are carried on. A  
 grievance, from which this republic suffers much, is  
 the want of good coinage. It can hardly be said  
 that Peruvian coinage exists, inasmuch as that in  
 circulation is from the mint of Bolivia. The British  
 acting-consul at the Peruvian port of Islay, writing  
 in 1863, says, however, that a new Peruvian coinage  
 is in contemplation, and will no doubt be promptly  
 introduced. But besides the precious metals, P.  
 possesses other most important mineral resources.  
 In addition to the guano to which allusion has  
 already been made, another important article of  
 national wealth is nitrate of soda, which is found in  
 immense quantities in the province of Tarapaca.  
 This substance, which is a powerful fertiliser (see  
 NITRE), is calculated to cover, in this province  
 alone, an area of 50 square leagues, and the quantity  
 has been estimated at 63,000,000 tons. In 1860  
 (from the port of Iniquique alone), 1,370,248 cwts.  
 were exported. Here also great quantities of  
 borax are found. The working of this valuable  
 substance, however, is interdicted by government,  
 which has made a monopoly of it, as it has of  
 the guano; but such small parcels of it as have  
 been exported bring about £30 per ton in the  
 English market.

The vegetable productions of P. are of every  
 variety, embracing all the products both of temper-  
 ate and tropical climates. The European cereals  
 and vegetables are grown with perfect success,  
 together with maize, rice, pumpkins, tobacco,  
 coffee, sugar-cane, cotton, &c. Fruits of the most  
 delicious flavour are grown in endless variety.  
 Cotton, for which the soil and climate of P. are  
 admirably adapted, is now produced here in gradu-  
 ally increasing quantity. The land suited to the  
 cultivation of this plant is of immense extent, and  
 the quality of the cotton grown is excellent. The  
 animals comprise those of Europe, together with  
 the Lama (q. v.) and its allied species. In 1859,  
 2,501,634 lbs. of lama and alpaca wool were im-  
 ported into Great Britain. Although P. produces  
 so much excellent wool, almost the whole of the  
 woollen fabrics used as clothing by the Indians are  
 manufactured in Yorkshire, England.

*Ancient Civilisation and History.*—P., the origin  
 of whose name is unknown, is now passing through  
 its third historical era, and is manifesting its  
 third phase of civilisation. The present era may  
 be said to date from the conquest of the country

by the Spaniards in the early part of the 16th c.; the middle era embraces the rule of the Incas; and the earliest era, about which exceedingly little is known, is that Pre-Incarial period, of unknown duration, during which a nation or nations living in large cities flourished in the country, and had a civilisation, a language, and a religion different, and perhaps in some cases even more advanced than those of the Incas who succeeded them, and overran their territories. Whence these Pre-Incarial nations came, and to what branch of the human family they belonged, still remain unanswered questions. Their existence, however, is clearly attested by the architectural remains, sculptures, carvings, &c., which they have left behind them. Ruins of edifices constructed both before the advent of the Incas, and contemporary with, and independently of, them, are found everywhere throughout the country. On the shores of Lake Titicaca, for example, are the ruins of Tia-Huanacu, consisting of sculptured monolithic doorways, one of which is 10 feet high, and 13 feet wide; of pillars, 21 feet high, placed in lines at regular distances; and of immense masses of hewn stone, some 38 feet long by 18 broad. In 1846, several colossal idols were excavated, some being 30 feet long, 18 wide, and 6 thick. The idols are in the form of statues, and the ears are not enlarged by the insertion in the lobes of silver rings, as those of sculptured figures, executed in Incarial times invariably are. The ancient fragments of buildings on these shores were beheld with astonishment by the earliest of the Incas, who, by their own confession, accepted them as models for their own architecture. The name Tia-Huanacu is comparatively modern, having been conferred by one of the Incas; neither history nor tradition has handed down the original name. The ruins stand at a height of 12,930 feet above sea-level, and one of the many mysteries which have crowded around this ancient site is, that this spot, in the midst of what is now generally a frozen desert, and where the rarity of the air must be so great as to be hurtful, should have been chosen as the seat, as it is generally believed to have been, of an ancient government. Of the character and degree of the civilisation of the Pre-Incarial races, almost nothing is known. It is worthy of note, however, that at Pachacamac, 25 miles south of Lima, where there are the remains of a now wholly deserted city, and of a great temple, the religion seems to have been a pure Theism; for when the Peruvians of Cuzco carried their victorious arms across the Cordilleras to this district, they beheld this temple (the doors of which are said to have been of gold inlaid with precious stones) with astonishment, not only because it rivalled if not surpassed in splendour the famous Temple of the Sun at Cuzco, but because it contained no image or visible symbol of a god. It was raised in honour of an invisible and mysterious deity, whom the inhabitants called Pachacamac, the Creator of the World (from two words of the ancient Peruvian language, *Pacha*, the earth; and *Camac*, participle of the verb *Camani*, to create). The Peruvians did not dare to destroy this temple, but contented themselves with building by its side a Temple of the Sun, to the worship of which they gradually won over the inhabitants.—For further information regarding Pre-Incarial times and races, see W. Bollaert's *Antiquities, Ethnology, &c. of South America* (Lond. 1860).

Regarding the origin of the Incas, nothing definite can be said. We have no authorities on the subject save the traditions of the Indians, and these, besides being outrageously fabulous in character, are also conflicting. It appears, however, from all the traditions, that Manco, the first Inca, first appeared

on the shores of Lake Titicaca, with his wife Mama Oello. He announced that he and his children of the Sun, and were sent by the Sun (Inti) to instruct the simple tribes of the country, and said to have carried with him a golden wand, as it is sometimes called, a wand. When the golden wedge, on being struck upon the ground, sank into the earth, and disappear for ever, it was decreed Manco should build his city. Marching northward, he came to the plain of Cuzco, where the wedge disappeared. Here he founded the city of Cuzco, became the first Inca, and said to be derived from the Peruvian word *Cuzco* (Sun), and founded the Peruvian race, the first ruler, called Manco, or Manco Capac (i. e., Manco the Ruler), instructed the men in agriculture, and the arts, gave them a comparatively pure religion, and a social and national organisation; while his wife, Mama Oello, who is also represented as his sister, taught the women to sew, to spin, and to weave. Thus, the Inca was not only ruler of his people, but also the father and the high priest. The territory held by Manco Capac was extensive, extending about 90 miles from east to west, and about 80 miles from north to south. After founding laws among his people, and bringing them into regularly organised communities, 'he left the government to his father, the Sun.' The year generally reckoned as that of his death, after a reign of forty years, is 1062 A. D. The progress of the Peruvian civilisation at first so slow as to be almost imperceptible. Gradually, however, by their wise and just laws, and policy, they won over the neighbouring tribes, and readily appreciated the benefits of a powerful and a fostering government. Little is clearly known regarding the early history of the Peruvian empire, and the lists given of its early sovereigns are of no means to be trusted. They invited no records, and therefore could keep no written records of their affairs, so that almost all we can know of the early history is derived from the traditions of the people, collected by the early Spaniards. Many of these were indeed kept by the Peruvians, and, in some cases, even full historical records, by means of a quipu, a twisted woollen cord, upon which other cords of different colours were tied. Of the threads, the colour, the length, the number, and the position upon them, and the distance of one from another, all had their significance; but after the invasion of the Spaniards, when the whole Peruvian empire, government and civilisation underwent a complete revolution, the art of reading the quipus, seen to have been lost, or was effectually forgotten. Thus it is that we have no exact knowledge of the Peruvian history further back than the 16th century before the coming of the Spaniards. In 1453, Tupac Inca Yupanqui, the eleventh Inca, according to the list given by Garcilaso de la Vega, greatly enlarged his already wide dominions. He led his armies southward into Chili, marched over the terrible Andes of Atacama, and penetrating as far south as the Maule (lat. 36° S.), fixed there the southern boundary of Peru. Returning, he crossed the Chilean Andes by a pass of unequalled difficulty, and at length regained his capital, where he entered in triumph. While thus engaged, his son, the young Huayna Capac, heir to the throne, as well as the throne of his father, had advanced northward to the Amazon, crossed that river, and conquered the kingdom of Quito. Huayna Capac ascended the throne, and was succeeded by his empire of the Incas attained to its greatest extent, and the height of its glory. It was bounded on the equatorial valleys of the north to the temperate plains of Chili, and

## PERU.

sandy shores of the Pacific to the marshy sources of the Paraguay. Of this immense territory, Cuzco, as its name implies (the word signifies navel), was the great centre; great roads branched off from it to the north, south, east, and west, and ramified through every part of the kingdom. The greatest highway of the country was that which led from Quito through Cuzco into the Chilean dominions. In its construction, galleries were cut for leagues through the living rock; rivers were crossed by bridges of plaited osiers, that swung in the air; precipices were ascended by staircases artificially cut, and valleys were filled up with solid masonry. It was from 1500 to 2000 miles long, was about 20 feet broad, and was built of heavy flags of freestone. Upon all the great routes were posts or small buildings, about five miles apart, attached to which were a number of runners, whose business it was to carry forward the dispatches of government. By means of these messengers, fresh fish caught on one day at Lurin, on the Pacific, is said to have been eaten the next day at Cuzco. The distance between these places is 300 miles, and the road traverses the wildest and most mountainous country in the world. Order and civilisation accompanied conquest among the Peruvians, and each tribe that was vanquished found itself under a careful paternal government, which provided for it, and fostered it in every way.

The government of P. was a pure but a mild despotism. The Inca, as the representative of the Sun, was the head of the priesthood, and presided at the great religious festivals. He imposed taxes, made laws, and was the source of all dignity and power. He wore a peculiar head-dress, of which the tasselled fringe, with two feathers placed upright in it, were the proper insignia of royalty. Of the nobility, all those descended by the male line from the founder of the monarchy, shared, in common with the ruling monarch, the sacred name of Inca. They wore a peculiar dress, enjoyed special privileges, and lived at court; but none of them could enter the presence of the Inca except with bare feet, and bearing a burden on the shoulders, in token of allegiance and homage. They formed, however, the real strength of the empire, and, being superior to the other races in intellectual power, they were the fountain whence flowed that civilisation and social organisation which gave P. a position above every other state of South America. Prior to the arrival of the Spaniards, P. contained a population of 30,000,000—twelve times greater than it is at the present day. The empire was divided into four parts, into each of which one of the great roads branched from Cuzco. Each of the four provinces was administered by a viceroy or governor. The nation was further subdivided into departments of 10,000 inhabitants, each also administered by a governor; and there were other subdivisions into various numbers, the lowest of which was ten, and every one of which was ruled by head-men, who were responsible for offenders, and were required to see that those under them enjoyed the rights to which they were entitled. The governors and chief rulers were selected from the Inca aristocracy. The laws related almost wholly to criminal matters, and were few, and remarkably severe. Theft, adultery, murder, blasphemy against the Sun, and burning of bridges, were all capital crimes. The territory of the empire was divided into three portions, and from these portions were derived the revenue that supported the Sun, the Inca, and the people respectively. The numerous priesthood, and the costly ceremonial of the national worship, were supported by the first; the royal household and the government expenditure were defrayed out of the second; and

the people, at so much per head, divided the third of these portions. There was a new division of the soil every year, and the extent of land apportioned to each householder was regulated by the numbers in his family. It might be supposed that this arrangement would be fatal to improvement of the soil, and to the pride in and love of home; but this was not the case; and it is probable that at each partition of the soil, the tenant was, as a rule, confirmed in his occupation. The three divisions were cultivated by the people, the territory apportioned to the Sun being attended to first, that belonging to the people themselves next, and lastly, the division belonging to the Inca. The labour on the Inca's share of the land was engaged in by the whole population at the same time, and the work was lightened by the national songs and ballads, and the scene made picturesque by the holiday attire of the workers. The manufactures of the country were managed in the same way, the people labouring first in making clothes for themselves, and afterwards giving their work to the Inca. The mines were worked by the people, but no one gave more than a certain amount of time to the government service (during which time he was maintained at the government expense), and after discharging the stipulated amount of duty, he was succeeded by another. Money was unknown among the Peruvians. They were a nation of workers, but they wrought as the members of one family, labour being enforced on all for the benefit of all.

The national policy of the Peruvians had its imperfections and drawbacks, and though capable of unlimited extension, it was not capable of advancement. It was in the last degree conservative, and was of such a nature that the introduction of reform in any vital particular must have overturned the whole constitution. Nevertheless, the wants of the people were few, and these were satisfied. Their labour was not more than they could easily perform, and it was pleasantly diversified with frequent holidays and festivals. They lived contentedly and securely under a government strong enough to protect them; and a sufficiency of the necessaries of life was obtained by every individual. Still, in the valleys of the Cordilleras and on the plain of Cuzco, may be heard numberless songs, in which the Peruvian mourns the happy days of peace, security, and comfort enjoyed by his ancestors. Further, they revered and loved their monarch, and considered it a pleasure to serve him. With subjects of such a temper and inclination, the Incas might direct the entire energies of the nation as they chose; and it is thus that they were able to construct those gigantic public works which would have been wonderful even had they been performed with the assistance of European machinery and appliances.

The Peruvian system of agriculture was brought to its highest perfection only by the prodigious labour of several centuries. Not only was the fertile soil cultivated with the utmost care, but the sandy wastes of the coast, unvisited by any rains, and but scantily watered by brooks, were rendered productive by means of an artificial system of irrigation, the most stupendous, perhaps, that the world has ever seen. Water was collected in lakes among the mountains, led down the slopes and through the sands of the coast, apparently doomed to sterility, by canals and subterranean passages constructed on a vast scale, and the ruins of which, to be seen at the present day, attest the industry, ingenuity, and admirable patience of the Peruvians. The aqueducts, which were sometimes between 400 and 500 miles in length, were in some cases



tunnelled through massive rocks, and carried across rivers and marshes. They were constructed of large slabs of freestone, fitting so closely as to require no cement, and answering perfectly the purpose for which they were intended, for the sandy wastes were converted into productive fields and rich pasture-lands, and the coast teemed with industrious inhabitants. In the valley of Santa, there were once 700,000 inhabitants; there are now only 12,000: in that of Ancullama, there were 30,000 individuals; there are now only 425. The fields on the coast were also enriched with the manure of sea-fowls, which has since come to be known as guano. Fragments of the aqueducts still remain, and are surveyed with astonishment by the traveller, who wonders that such works could have been constructed by a people who appear to have employed no machinery, had no beasts of burden, who did not know the secret of the true arch, and who did not use tools or instruments of iron. But the triumphs of industry were not more decided on the coast than they were in the *Sierra*. Here, at elevations visited now only by the eagle and the condor, the rocky heights, riven by innumerable chasms and deeply-cut precipices, were crowned with waving crops of wheat, and maize. Where the mountain-slopes were too steep to admit of cultivation, terraces were cut, soil was accumulated on them, and the level surfaces converted into a species of hanging-gardens. Large flocks of llamas were grazed on the plateaux; while the more hardy vicuñas and alpacas roamed the upper heights in freedom, to be driven together, however, at stated periods, to be shorn or killed. The wool yielded by these animals, and the cotton grown in the plains and valleys, were woven into fabrics equally remarkable for fineness of texture and brilliancy of colour.

The character of the architecture of the Peruvians has already been alluded to. The edifices of Incaian times are oblong in shape and cyclopean in construction. The materials used were granite, porphyry, and other varieties of stone; but in the more rainless regions, sun-dried bricks were also much used. The walls were most frequently built of stones of irregular size, but cut with such accuracy, and fitting into each other so closely at the sides, that neither knife nor needle can be inserted in the seams. Though the buildings were not, as a rule, more than from 12 to 14 feet high, they were characterised by simplicity, symmetry, and solidity. The Peruvian architects did not indulge much in external decoration; but the interior of all the great edifices was extremely rich in ornament. In the royal palaces and temples, the most ordinary utensils were of silver and gold; the walls were thickly studded with plates and bosses of the same metals; and exquisite imitations of human and other figures, and also of plants, fashioned with perfect accuracy in gold and silver, were always seen in the houses of the great. Hidden among the metallic foliage, or creeping among the roots, were many brilliantly-coloured birds, serpents, lizards, &c., made chiefly of precious stones; while in the gardens, interspersed among the natural plants and flowers, were imitations of them, in gold and silver, of such truth and beauty as to rival nature. The Temple of the Sun at Cuzco, called *Coricancha*, or 'Place of Gold,' was the most magnificent edifice in the empire. On the western wall, and opposite the eastern portal, was a splendid representation of the Sun, the god of the nation. It consisted of a human face in gold, with innumerable golden rays emanating from it in every direction; and when the early beams of the morning sun fell upon this brilliant golden disc, they were reflected from it as from a mirror, and again reflected throughout the whole temple by the numberless

plates, cornices, bands, and images of gold, until the temple seemed to glow with a sunshine more intense than that of nature.

The religion of the Peruvians, in the later ages of the empire, was far in advance of that of most barbarous nations. They believed in a Great Spirit, the Creator of the universe, who, being a spirit, could not be represented by any image or symbol, nor be made to dwell in a temple made with hands. They also believed in the existence of the soul hereafter, and in the resurrection of the body. The after-life, they considered to be a condition of ease and tranquillity for the good, and of continual wearisome labour, extending over ages, for the wicked. But while they believed in the Creator of the world, they also believed in other deities, who were of some subordinate rank to the Great Spirit. Of these secondary gods, the Sun was the chief. They revered the Sun as the source of their royal dynasty; and everywhere throughout the land, altars smoked with offerings burned in his worship.

About the year 1516, and ten years before the death of Huayna Capac, the first white man had landed on the western shores of South America; but it was not till the year 1532, that Pizarro (q. v.), at the head of a small band of Spanish adventurers, actually invaded Peru. On his death-bed, the great Inca expressed a wish that the kingdom of Quito should pass to Atahualpa, one of his sons by a princess of Quito whom he had received among his concubines, and that all his other territories should fall to his son Huascar, the heir to the crown, and who, according to the custom of the Incas, should have inherited all its dependencies. Between these two princes, quarrels, resulting in war, arose; and when Pizarro entered P., he found the country occupied by two rival factions, a circumstance of which he took full advantage. Atahualpa had completely defeated the forces of his brother, had taken Huascar prisoner, and was now stationed at Caxamalca, on the eastern side of the Andes, whither, with a force of 177 men, of whom 27 were cavalry, the dauntless Spanish leader, in September 1532, set out to meet him. For the capture of Atahualpa by the Spaniards, his subsequent life and violent death, see article ATAHUALPA. Shortly after the execution of the Inca at Caxamalca, the adventurers set out for Cuzco. Their strength had been recently increased by reinforcements, and they now numbered nearly 500 men, of whom about a third were cavalry. They entered the Peruvian capital, 15th November 1533, having in the course of their progress toward the city of the Incas, had many sharp, and sometimes serious encounters with the Indians, in all of which, however, their armour, artillery, and cavalry gave them the advantage. At Cuzco they obtained a vast amount of gold, the one object for which the conquest of P. was undertaken. As at Caxamalca, the articles of gold were for the most part melted down into ingots, and divided among the band. Their sudden wealth, however, did many of them little good, as it afforded them the means of gambling, and many of them, rich at night, found themselves again penniless adventurers in the morning. One cavalier having obtained the splendid golden image of the Sun as his share of the booty, lost it in play in a single night. After stripping the palaces and temples of their treasures, Pizarro placed Manco, a son of the great Huayna Capac, on the throne of the Incas. Leaving a garrison in the capital, he then marched west to the sea-coast, with the intention of building a town, from which he could the more easily repel invasion from without, and which should be the future capital of the kingdom.

## PERU.

Choosing the banks of the river Rimac, he founded, about six miles from its mouth, the *Ciudad de los Reyes*, 'City of the Kings.' Subsequently, its name was changed into Lima, the modified form of the name of the river on which it was placed. But the progress of a higher civilisation thus begun, was interrupted by an event which overturned the plans of the general, and entailed the severest sufferings on many of his followers. The Inca Manco, insulted on every hand, and in the most contemptuous manner, by the proud Castilian soldiers, effected his escape, and headed a formidable rising of the natives. Gathering round Cuzco in immense numbers, the natives laid siege to the city, and set it on fire. An Indian force also invested Xauxa, and another detachment threatened Lima. The siege of Cuzco was maintained for five months, after which time the Peruvians were commanded by their Inca to retire to their farms, and cultivate the soil, that the country might be saved from famine. The advantages, many, though unimportant, which the Inca gained in the course of this siege, were his last triumphs. He afterwards retired to the mountains, where he was massacred by a party of Spaniards. More formidable, however, to Pizarro than any rising of the natives, was the quarrel between himself and Almagro, a soldier of generous disposition, but of fiery temper, who, after Pizarro, held the highest rank among the conquerors. For the insurrection, trial, and execution of this chief, see article ALMAGRO. The condition of the country was now in every sense deplorable. The natives, astonished not more by the appearance of cavalry than by the flash, the sound, and the deadly execution of artillery, had succumbed to forces which they had no means of successfully encountering. Meantime, the Almagro faction had not died out with the death of its leader, and they still cherished schemes of vengeance against the Pizarros. It was resolved to assassinate the General as he returned from mass on Sunday, 26th June 1541. Hearing of the conspiracy, but attaching little importance to the information, Pizarro nevertheless deemed it prudent not to go to mass that day. His house was assaulted by the conspirators, who, murdering his servants, broke in upon the great leader, overwhelmed him by numbers, and killed him (see PIZARRO). The son of Almagro then proclaimed himself governor, but was soon defeated in battle, and put to death. In 1542, a council was called at Valladolid, at the instigation of the ecclesiastic Las Casas, who felt shocked and humiliated at the excesses committed on the natives. The result of this council was, that a code of laws was framed for P., according to one clause of which, the Indians who had been enslaved by the Spaniards were virtually declared free men. It was also enacted that the Indians were not to be forced to labour in unhealthy localities, and that in whatever cases they were desired to work in any particular locality, they were to be fairly paid. These and similar clauses enraged the adventurers. Blasco Nuñez Vela, sent from Spain to enforce the new laws, rendered himself unpopular, and was seized, and thrown into prison. He had come from Spain, accompanied by an 'audience' of four, who now undertook the government. Gonzalo Pizarro (the last in this country of the family of that name), who had been elected captain-general of P., now marched threateningly upon Lima. He was too powerful to withstand, and the audience received him in a friendly manner, and after the administration of oaths, elected him governor as well as captain-general of the country. The career of this adventurer was cut short by Pedro de la Gasca, who, invested with the powers

of the sovereign, arrived from Spain, collected a large army, and pursued Pizarro, who was eventually taken and executed.

A series of petty quarrels, and the tiresome story of the substitution of one ruling functionary for another, make up a great part of the subsequent history. The country became one of the four vice-royalties of Spanish America, and the Spanish authority was fully established and administered by successive viceroys. The province of Quito was separated from P. in 1718; and in 1788, considerable territories in the south were detached, and formed into the government of Buenos Ayres. At the outbreak of the War of Independence in South America, the Spanish government, besides having much declined in internal strength, was distracted with the dissensions of a regency, and torn by civil war; nevertheless, in 1820, the Spanish viceroy had an army of 23,000 men in Peru, and all the large towns were completely in the hands of Spanish officials. P. was the last of the Spanish South American possessions to set up the standard of independence. In August 1820, a rebel army, under General San Martin, one of the liberators of Chili, sailed for P., and after a number of successes both on sea and land, in which the patriots were most effectively assisted by English volunteers, the independence of the country was proclaimed 28th July 1821, and San Martin assumed the protectorate of the young republic. From this date to the year 1860, 21 rulers, under various titles, have held sway. For the first 24 years of its existence as an independent republic, the country was distracted and devastated by wars and revolutions. In 1845, Don Ramon Castilla was elected president; and under his firm and sagacious guidance, the country enjoyed an unwonted measure of peace, and became regularly organised. Commerce began to be developed, and important public works were undertaken. The term of his presidency ended in 1851, in which year General Rufino José Echenique was elected president. The country, however, was discontented with his government, and Castilla, after raising an insurrection in the south, again found himself in 1855 at the head of affairs. Slavery, which, although abolished by the charter of independence, still existed, was put an end to by a decree dated October 1854. In August 1863, a quarrel had taken place at the estate of Talambo, in the north, between some Basque emigrants and the natives, in which several of the disputants were killed or wounded. Taking advantage of this occurrence, the Spanish government sent out a 'special commissioner' in the spring of 1864, who delivered a memorandum to the Peruvian minister, complaining of injuries sustained by the Spaniards, and accompanied by a letter threatening prompt and energetic reprisals, should Spain be insulted or her flag disgraced. The 'commissioner' left Lima on the 12th April, the day on which his memorandum and letter were delivered; and on the 14th, a Spanish squadron, under Admiral Pinzon, who had been joined by the 'commissioner,' took forcible possession of the Chincha Islands, the principal source of the revenue of Peru. The quarrel has not yet (August 1864) come to a termination.

The government of P. is republican; but hitherto it has borne for the most part the character of a military despotism. Its president is elected for a term of six years. He is assisted by a Senate, consisting of two members from each province, and a House of Representatives, of whom there is one member for every 20,000 inhabitants. In 1863, General Pezet succeeded to the presidency. The ministers, together with senators chosen by the congress, form the cabinet. In 1860, the Senate consisted of 36 members, and the House of 86

members. The receipts in 1861 amounted to 21,245,832 dollars, of which 16,921,751 dollars were derived from the sale of guano; the expenditure for the same year amounted to 21,446,466 dollars. The public debt in 1862 amounted to 23,458,761 dollars. The army in the same year consisted of 16,000 men, and the navy of 17 vessels, carrying 84 guns. The country is divided into 11 departments, and two provinces with the constitution of departments; and the departments are subdivided into provinces, the provinces into districts, and the districts into parishes. Of the whole pop., 240,000 are whites, 300,000 Mestizos and dark, 40,000 Negroes, and 1,620,000 Indians.

PERUGIA, a city of Central Italy, capital of the province of the same name, stands on a lofty elevation, 800 feet high, on the right bank of the Tiber, ten miles east of the lake of the same name (ancient *Lacus Trasimenus*), and 84 miles north of Rome. It is surrounded with walls pierced with numerous gates, of which the *Arch of Augustus* (so called from the inscription *Augusta Perusia* over it, inscribed by Augustus) is the finest. It is the see of a bishop, and contains upwards of 100 churches, and about 50 monastic establishments. Its streets are wide, and there are several squares lined with massive buildings. The broad Corso, which contains the finest edifices, unites two squares, one of which is occupied by the Duomo, or cathedral, dedicated to San Lorenzo, and dating from the end of the 15th century. It is in a fine bold Gothic style, and contains many excellent paintings, carvings, &c. Many of the churches and convents are noble Gothic structures, and all of them are more or less famous for their pictures, some of which are by Raphael, Perugino, and other great masters. In the vicinity of the city, a number of tombs, supposed to mark the site of the necropolis of ancient P., were discovered in 1840. The tombs contain numerous beautiful *cinerary urns*, in marble and travertine; and lamps, vases, bronze armour, ornaments, paterae, &c., were also found, but have for the most part been removed to a neighbouring villa. The university of P., founded in 1320, and liberally endowed, contains a botanic garden, a cabinet of mineralogy, a museum of antiquities, and a library of 30,000 vols, with some valuable manuscripts. It is attended by from 300 to 400 students. Besides the picture-gallery of the Academy of Fine Arts, there are numerous private art-collections. P. contains also many interesting palaces, a beautiful fountain, an exchange, theatres, &c. Velvets, silk-stuffs, woollen goods, soap, brandy, and liqueurs are manufactured; and a considerable trade is carried on in corn, oil, wool, wine, and cattle. Pop. (1862), inclusive of suburbs, 44,130.

P., the ancient *Perusia*, was one of the twelve Etrurian republics. It became tributary to Rome 294 B.C. During the war between Mark Antony and Augustus, it was taken by the latter, and was burned down. It was captured by the Goths under Totila at the fall of the Western Empire. Under Pope Paul III., it was united to the Papal States. In 1860, it became a part of the Kingdom of Italy under Victor Emmanuel.

PERUGIA, LAKE OF. See TRASIMENUS-LACUS.

PERUGINO, a celebrated Italian painter, whose real name was PIERRO VANNUCCI, was born at Citta della Pieve in Umbria, about 1446, but having afterwards established himself in the neighbouring and more important city of Perugia, where he had the right of citizenship, he is commonly called Il Perugino. It is generally thought that he studied under Andrea Verocchio at Florence. He executed numerous excellent works in various cities, particularly in

Florence, Siena, Pavia, Naples, Bologna, Rome, and Perugia. Sixtus IV. employed him in the Cappella Sistina; and his fresco of 'Christ giving the Keys to Peter' is by far the best of those painted on the side-walls of that chapel. He also, along with other contemporary painters, decorated the Stanze of the Vatican; and his works there are the only frescoes that were spared when Raphael was commissioned to substitute his works for those formerly painted on the walls and ceilings. The fact of his having had Raphael for his pupil, has no doubt in one way increased the reputation of P., but it has also in some degree tended to lessen it, as, in many of P.'s best productions, the work of Raphael is confidently pointed out by connoisseurs, and, indeed, many important pictures, at one time acknowledged as his, are now ascribed to his great pupil. His high standing as a painter, however, is established by many admirable works, in which no hand superior to his own could have operated; and, with the exception, perhaps, of Francia, who in some respects is esteemed his equal, he is now acknowledged as the ablest of the masters of that section of the early Italian school in which religious feeling is expressed with great tenderness, in pictures remarkable for delicate execution. P.'s works are also distinguished by rich and warm colouring. An excellent example of this master's work may be studied in the collection of the National Gallery, London—'No. 238. The Virgin Adoring the Infant Christ.' P.'s reputation was high, when the introduction of the cinquecento style, by Leonardo and Michael Angelo, tended to throw into the shade the art of the earlier masters. Disputes ran high between the leaders of the old and new styles, and Michael Angelo is said to have spoken contemptuously of P.'s powers. This, of course, has biassed Vasari's opinion in his estimate of the opponent of his idol, but P.'s reputation now stands very high, and his works are greatly esteemed. Raphael was about twelve years of age when he was entered as a pupil with P., who was then (1495) engaged on the frescoes in the Sala del Cambio (the Exchange) at Perugia. P. died at Castello di Fontignano, near Perugia, in 1524.

PERUVIAN ARCHITECTURE. Although the buildings of Peru were erected probably about the 12th c. A.D., they possess an extraordinary likeness to those of the Pelasgi in Europe. This resemblance in style must be accidental, arising probably from the circumstance, that both nations used bronze tools, and were unacquainted with iron. The Peruvian walls are built with large polygonal blocks of stone, exactly like what we call 'Cyclopean masonry.' The jambs of the doorways slope inwards, like those of Etruscan tombs, and have similar lintels. The walls of Cuzco are good examples of this style. It is further remarkable, that these walls are built with re-entering angles, like the fortifications which were adopted in Europe only after the invention of gunpowder.

PERUVIAN BARK. See CINCHONA.—But whilst the article Cinchona was passing through the press, an important event was taking place in the introduction of cinchonas, or Peruvian Bark trees into British India. This had long been urged on the East India Company by Dr Royle, but was not undertaken till after his death. The same thing had been attempted a year or two before by the Dutch in Java, on the urgent representations of the botanist Blume, but with very imperfect success, owing to their having procured chiefly plants of a species which produces bark of very inferior quality, and yields little quinine. But Mr Markham, who

## PERUVIAN GOOSEBERRY—PESHITO.

was sent to South America by the East India Company to procure seeds and plants, was successful in introducing into British India, in the latter part of 1861, a number of the very best species, which were planted chiefly on the Neigherry Hills, and partly also on the mountains of Ceylon and the Himalaya, and from these stations have begun to be diffused so that their cultivation for economical use has fairly begun. Young trees are already sold by thousands; and there is every prospect that, ere many years have elapsed, an abundant supply of Peruvian bark, and consequently of quinine, will be secured at a very moderate price, and yet with profit to the East Indian cultivator. In procuring the young trees and seeds which he conveyed to India, Mr Markham experienced great difficulty from the jealousy of the South American governments, anxious to maintain a rigid monopoly in this precious commodity, and yet taking no effectual means to prevent the rapidly-extending waste of the trees in their native forests; whilst such is the want of enterprise among the people, that Mr Markham in all his travels saw only one Peruvian Bark tree which had been planted by the hand of man. (See Markham's *Travels in Peru and India*, Lond. 1862.)

**PERUVIAN GOOSEBERRY.** See **PHYSALIS**.

**PESARO** (the ancient *Pisaurum*), a town of Central Italy, capital of the province of the same name, on a rocky wooded hill, on the right bank of the Foglia, and one mile from the mouth of that river in the Adriatic—20 miles north-east of Urbino. Its streets are broad, and it is surrounded by walls and defended by a citadel. It is a bishop's seat, and contains a cathedral and other churches. The country in the vicinity is fruitful and beautiful; the figs of the district being esteemed the best in Italy. The port cannot now accommodate vessels of more than 70 tons burden; but is large enough to contain 200 vessels of light draught. Silks, pottery, glass, and leather are manufactured; and an active trade in silk, hemp, and woollen goods is carried on. Pop. 20,000.

**PESCHIERA**, a frontier town and fortress of Austrian Italy, and a member of the famous Quadrilateral (q. v.), stands partly on an island in the channel of the Mincio, and partly on the right bank of that river, at its outlet from the Lake of Garda. The town itself is a poor place of less than 2000 inhabitants. P. commands the right bank of the river, and in connection with it is the extensive work called the 'Salvi,' which covers the approaches of the river in that direction. During the French republican war, P. was a simple pentagon. Its fortifications, however, have been greatly strengthened by the Austrians. It is defended by walls and by forts, lunettes, fosses, and a covered-way; and the purpose which it is mainly intended to serve, besides that of forming an entrenched camp capable of accommodating a considerable number of troops, is to harass an army attempting to cross the Mincio by Goito or Valeggio. In the island portion of the town are extensive barracks, forming three sides of a square. P. is a station on the Milan and Venice Railway, and is also a station of the Austrian government steamers that ply on the Lake of Garda. P. was taken by the Piedmontese under King Charles Albert in 1848, and was again invested by them in June 1859, after the battle of Solferino. The conclusion of the treaty of Villafranca, however (July 11, 1859), relieved P. from a siege.

**PESHAWER**, or **PESHAWUR**, an important town, or the north-west frontier of India, capital of a province of the same name, 18 miles east of the

eastern extremity of Khyber Pass, and 150 miles east-south-east of Cabul. It is defended by a bastioned wall, and commanded by a fort, the fear of which prevents internal disturbances. At the commencement of the present century, P. had 100,000 inhabitants. Under the stern rule of the Sikhs, however, its trade languished, and its splendid mosques, many of them in the richest style of oriental architecture, fell into decay. It is on the route from Hindustan to Cabul and Khorassan by the Khyber Pass, and is the seat of a British garrison, maintained here for the purpose of preserving the security of the route. Under British protection, the town is reviving, trade is becoming more active, and the appearance of the suburbs and environs is improved. Pop. 53,295. The province of P., included in the Punjab, and formerly forming a portion of Afghanistan, is about 2300 square miles in extent, and has 450,000 inhabitants. It is exceedingly fruitful. It is well watered, and produces rice and fruits of the finest quality, and in the greatest abundance.

**PESHITO**, or rather **PESHITTO** (Syr., not, as generally supposed, 'simple,' 'faithful,' scil. Version, but the 'explained,' i. e., translated, Bible), is the name given to the authorised Syriac Version of the Old. and the greatest part of the New Testament. This version holds among the Syrian Christians the same place as the Vulgate in the Roman, and the 'Authorised Version' in the English Church. Many are the traditions about its origin. Thus, the translation of the Old Testament is supposed to date from the time of Solomon and Hiram; or to have been done by Asa, the priest; or, again, that it belongs to the time of the Apostle Thaddæus (Adasus), and Abgar, the king of Osrhene, in the 1st c. after Christ. To the same period is also supposed to belong the translation of the New Testament, which is ascribed to Achæus, a disciple of Thaddæus, the first Edessian bishop and martyr. Recent investigation has not as yet come to any nearer result than to place the latter vaguely in the 2d, and the former in the 3d c., and to make Judaic-Christians the authors of both. Ephræm Syrus (q. v.), who wrote in the 4th c., certainly speaks of the P. as *Our* Version, and finds it already necessary to explain some of its terms, which had become obsolete. Five books of the New Testament (the Apocalypse and four of the Epistles) are wanting in all the MSS., having probably not yet formed part of the canon when the translation was made. The version of the Old Testament was made direct from the Hebrew, and by men imbued with the Palestinian mode of explanation. It is extremely faithful, and astonishingly free from any of those paraphrastic tendencies which pervade more or less all the Targums or Aramaic versions. Its renderings are mostly very happy, and coincide in many places with those of the Septuagint, a circumstance which has given rise to the erroneous supposition, that the latter itself had been drawn upon. Its use for the Old Testament is more of an exegetical, for the New Testament, more of a critical, nature. Anything like an edition of the P. worthy of its name, is still as much a desideratum as is a critical edition of the Septuagint or the Targums, and consequently investigators have as yet been unable to come to anything but very hazy conclusions respecting some very important questions connected with it. The *editio princeps* of the New Testament part dates Vienna 1555, that of the Old Testament is contained in the Paris Polyglot of 1645. Several portions of the P. have been translated again into Arabic. The Syriac translation of those parts of the New Testament which are not to be found in the P., but are now

incorporated into our Syriac Bibles, are of late and uncertain date.

PESTALOZZI, JOHANN-HEINRICH, was born at Zürich, 12th January 1745. His family belonged to the middle-class gentry. He was destined for the Christian ministry, but turned aside, however, from this profession, and betook himself to the study of law. To this pursuit he did not long remain constant. The perusal of Rousseau's *Emile*, and the unsatisfactory political condition in which he found Europe, united to disgust him with the artificial life of cities, and he accordingly removed to the country, to devote his life to farming. Purchasing some waste land (after he had acquired the necessary experience), he applied himself successfully to its cultivation, marrying about the same time the daughter of a wealthy merchant. His mind continuing to be afflicted by the contemplation of the unhappy condition of the masses of the people, he devoted himself, during the intervals of his work, to the consideration of the means best suited to promote their elevation. He was convinced that, by means of a sound education, a remedy might be found for the many evils by which he was surrounded, and by which society was infected. To give effect to his theories, he converted his own house into an orphan asylum, and endeavoured, by a judicious blending of industrial, intellectual, and moral training, to afford a specimen of sound education, and one so contrived as to be practicable as a national scheme. Meanwhile, the pursuit of his benevolent enterprises involved him, after the lapse of fifteen years (1775—1790), in bankruptcy. The failure of his plans, and the democratic tendency of his opinions, brought upon him a good deal of contempt and opposition. His only consolation was having saved from degradation and neglect upwards of 100 children, and having issued several volumes on education, containing the results of his experience, and his hopes for the future of the masses. Many subsequent attempts to found schools and to give a specimen of rational scholastic training, were made by P., with varying educational success, but with invariable pecuniary embarrassment. His writings, meanwhile, increased in number and importance. The great idea which lay at the basis of his method of intellectual instruction was, that nothing should be treated of except in a concrete way. *Objects themselves* became in his hands the subject of lessons tending to the development of the observing and reasoning powers—not lessons about objects. In arithmetic, he began with the concrete, and proceeded to the abstract; and into the teaching of writing, he for the first time introduced graduation. His special attention, however, was directed to the moral and religious *training* of children, as distinct from their mere *instruction*; and here, too, graduation and a regard to the nature and susceptibilities of children, were conspicuous features of his system. Almost all P.'s methods are now substantially adopted by the instructors of elementary teachers in the Normal Schools of Europe, and to no man perhaps has primary instruction been so largely indebted. He died in 1827 at Brugg, in the canton of Basel, overwhelmed with mortifications and disappointments.

PESTH, the most populous and important commercial city of Hungary, on the left bank of the Danube, opposite Buda (q. v.), and 171 miles east-south-east of Vienna by railway. It occupies a low and level site, and contrasts strongly with the antique, picturesque, and rock-built Buda, on the other side of the river. The two cities are connected by a magnificent suspension-bridge, erected in 1849, and

which spans a water-way of about 1500 feet. Communication is also facilitated by steam-ferries, which cross the river every hour. Along the P. side of the river runs a wide quay, paved and terraced, and backed by a handsome row of buildings,  $1\frac{1}{2}$  miles long. The city consists of five divisions—the Inner, Leopold, Theresa, Joseph, and Francis towns. The Inner town, on the bank of the Danube, is the oldest, and the other divisions surround it in the form of a semicircle. P. is the seat of the chief judicial courts of Hungary. Its university, founded at Tyrnau, was transferred to Buda in 1780, and thence was removed hither in 1784. It is attended by upwards of 1000 students, who are taught by 50 professors, and is richly endowed. Attached to it are a museum, a botanic garden, an observatory, and a library of 75,000 volumes. Of the chief buildings and institutions, the principal are the synagogue, a large and beautiful structure, completed in 1857; the New Buildings (*Neugebäude*)—an immense edifice, now used as barracks and as an artillery dépôt; the gymnasium; military school; academy of arts; national museum, with a library of 120,000 volumes, and valuable collections of coins, medals, and antiquities; veterinary school; the national and other theatres; and the Hungarian scientific society. The town contains several important silk-spinning factories, and the principal articles of manufacture are silk, cotton, leather, jewellery, and musical instruments. The distilling of brandy, and the grinding of grain into meal and flour, are among the most important branches of industry. There are 168 flour-mills driven by water, 8 driven by wind, and 4 by steam. Four great fairs take place here annually, which draw together a concourse of more than 30,000 strangers, and at which exchanges, amounting in value to upwards of 32,000,000 florins, are made. In the course of the year, about 8000 barges unload at the quay, and the trade is chiefly in wines, raw hides, honey, wax, and an inferior spirit made from plums. After Vienna, P. has the greatest trade of any city on the Danube. Pop. 130,000, made up of the most various nationalities—Germans, Magyars, Slovaks, Greeks, and Turks—the majority of whom are Roman Catholics.

P. is mentioned for the first time in the 12th c.; but although one of the oldest towns in Hungary, its importance dates only from the reigns of Maria Theresa and Joseph II. It was desolated by the Mongols in the 13th c.; and after the battle of Mohacs (q. v.), it fell into the hands of the Turks, who held it till 1686. At the beginning of the 18th c., it was an inconsiderable town, and has only risen into importance within the last 100 years. It has suffered much from inundations of the Danube on several occasions, on one of which, in 1838, 2280 houses were destroyed. In May 1849, while Görgei, with an army of 40,000 Hungarians, occupied the heights above Buda, and bombarded the fortress, which was held for the imperial government by General Hentzi, the latter general retaliated by bombarding P.; but on the night of the 20th May, the Hungarians stormed and took the fortress; and on the following morning, raised above its battlements the standard of revolt. On the field of Rákos, in the vicinity, where the great national assemblies of the Magyars used to be held, horse-races, on the English model, now take place annually.

PESTILENCE. The terms Plague and Pestilence, corresponding to the Greek *Loimos* and the Latin *Pestis*, have, until recent times, been used indiscriminately to denote any diseases of an epidemic character which affected large masses of the community, and were remarkable for their fatality,

such as the oriental plague, the sweating sickness, cholera, certain virulent forms of fever, &c. 'Thus,' says Dr Craigie, in his learned work on *The Practice of Physic* (vol. i. p. 349), 'the term *Loimos* was applied by the Greeks to designate a species of epidemic remittent fever; and the plague of Athens described by Thucydides is manifestly an epidemic form of the same disease, which has been at all times in the summer season endemic on the coasts and islands of the Mediterranean and Archipelago. The instances of *Loimos*, so frequently mentioned by Dionysius of Halicarnassus, and of *Pestis*, so often mentioned by Livy and other Roman historians in the early history of Rome, are manifestly the remittent or remittent-continuous fever, which has been at all times the native product of that district, and which acquired, after inundations of the Tiber, or a certain train of weather, the characters of a very generally diffused, a very malignant, and a very mortal distemper. Numerous instances of a similar inaccurate mode of expression occur in designating the remittent fevers of the middle ages and of modern times; and we find, even in the early history of the colonisation of the West Indian Islands and the United States, frequent examples of the term plague being applied to the remittent fever of these regions, and especially to epidemic attacks of yellow fever.' During the middle ages, we find the term *Pestis* applied to numerous disorders, such as syphilis, small-pox, erysipelas, epidemic sore throat, petechial fever, the sweating sickness, gangrenous pneumonia, ergotism, &c.

Several Hebrew words are translated *pestilence* or *plague*, in the authorised version of the Old Testament. Some of these pestilences were sent as special judgments, and are beyond the reach of inquiry; others have the characteristics of modern epidemics, in so far as their action was not unnaturally rapid, and they were general in their attacks. Sufficient data are not in our possession to enable us to identify with certainty any of these epidemics. It has been supposed by some critics that in some of these cases (as in Deuteronomy, xxviii. 27; Amos, iv. 10; and Zechariah, xiv. 18; and in the case of Hezekiah) the oriental plague is referred to; but Mr Poole (Smith's *Dictionary of the Bible*, vol. ii. p. 883) is of opinion that there is not any distinct notice of this disease in the Bible.

PESTO. See PASTUM.

PETAL. See COROLLA.

PETARD, an instrument for blowing open gates, demolishing palisades, &c. It consists of a half-cone of thick iron filled with powder and ball; this is firmly fastened to a plank, and the latter is provided with hooks, to allow of its being attached securely to a gate, &c. The engineers attached the petard, lighted the slow-match by which it was to be fired, and fled. When the explosion took effect, a supporting column charged through the breach, while the defenders were yet in consternation. The petard has been almost universally superseded by the use of powder-bags. Large petards contained as much as 13 lbs. of powder.

PE'TCHARY, the popular name of a number of species of the genus *Tyrannus*, sometimes ranked with the Shrikes (*Laniidae*), and sometimes with the Fly-catchers (*Muscicapidae*). The name seems to be derived from the cry of the GRAY P. (*T. Dominicensis*), a bird very common in the warm parts of America and in some of the islands of the West Indies, gregarious and migratory, spending the spring and summer in the islands, and retiring to the hottest parts of the mainland from the end of September to the beginning of January. Its cry is a kind of shriek, consisting of three or four shrill

notes, incessantly repeated. The entire length of the Gray P. is about 9½ inches. It is a very bold and strong bird, and in defence of its young, will maintain the battle against any hawk. It feeds partly on insects, sometimes on humming-birds, and partly on berries. When fat, it is much esteemed for the table, and great numbers are shot on this account.—The COMMON P. (*T. caudifasciatus*) is one of the most common birds of the West Indies. At certain seasons of the year, when very fat, it is in great request for the table. This bird has been observed to play with a large beetle, as a cat does with a mouse, letting it drop, and catching it before it can reach the ground. It is a very bold bird, and does not scruple to attack a dog passing near its nest.

PETCHO'RA, a large river in the north of European Russia, rises on the western slope of the Ural Mountains, flows north through the eastern parts of the governments of Vologda and Archangel to about 66° 25' N., then south-east for about 150 miles, and finally sweeping toward the north, and expanding into an estuary 30 miles wide and full of islands, falls into the Arctic Ocean, after a course of 940 miles. It is said to be navigable for large river-boats for upwards of 700 miles. The estuary, which is open from the middle of June till the middle of September, has a depth of from 20 to 30 feet. The country through which this river flows is still quite uncultivated; dense forests extend on both sides, and the character of the scenery is wild, sombre, and melancholy. The forests abound in larchwood, now largely used in the construction of iron-clad vessels. Within recent years, a colony has settled at the mouth of the P., for the purpose of felling, dressing, and exporting timber.

PETE'CHLÆ. This term is given to spots of a dusky crimson or purple colour, quite flat, with a well-defined margin, and unaffected by pressure, which closely resemble flea-bites. These spots result from a minute extravasation of blood beneath the cuticle. They occur most frequently on the back, at the bend of the elbow, and in the groin. They indicate an altered state of the blood, and are often symptoms of very serious diseases, as of typhus fever, plague, scurvy, &c. They likewise occur in very severe cases of small-pox, measles, and scarlet fever, when their presence must be regarded as indicative of extreme danger.

PETER, Sr, apostle, named originally SIMON, was a native of Bethsaida, on the Lake of Gennesaret. His father was called Jonas; and the name by which P. is known in Christian history was given to him by our Lord, who changed his name of origin (Bar-Jona) into *Cephas*, a Syro-Chaldaic word, which means 'rock' or stone, and for which *Petra*, or, in the masculine form, *Petros*, is the Greek equivalent. He was a fisherman by occupation, and, together with his brother Andrew, was actually engaged in this occupation on the Sea of Galilee when our Lord called both to be his disciples, promising to 'make them fishers of men.' For this invitation they had been prepared by the preaching of John the Baptist, and they accepted it without hesitation. For the incidents recorded of P.'s life as a disciple, we must refer to the gospel narrative. These incidents all chiefly evince a warm and impulsive character, even down to the hour of weakness in which he denied his Master. It is plain from the gospel narrative that he was regarded by our Lord with special favour and affection, and the events which followed the ascension of our Lord fall in with this inference from that narrative. He was the first mover of the election

of a new apostle in the room of Judas Iscariot; he was the spokesman of the rest on the day of Pentecost; he it was who answered to the charges when they were brought before the council; he is the chief actor in the tragic scene of the death of Ananias and Sapphira; he was the first to break down the wall of the prejudice of race by receiving a Gentile convert into the church; he was the first to propound in the council of Jerusalem the question to be discussed as to the obligation of the Mosaic observances. The last incident of P.'s life supplied by the Scripture narrative is his presence in the council of Jerusalem, 49 A.D. Of his subsequent career, our only knowledge is derived from tradition. His special mission was to the Hebrew race, as Paul's to the Gentile; and he is supposed to have preached through Pontus, Galatia, Cappadocia, Asia, and Bithynia, chiefly to those of his own nation dispersed in these countries, all which are named in the address of the first of the two Epistles which he has left. Another tradition which, until the 16th c., met general acceptance, reports that he preached at Rome, that he took up his residence there as bishop, and that he there suffered martyrdom. This tradition is the main foundation of the Roman claim to supremacy in the church. It early encountered the opposition of the reformers; its first antagonist being a writer named Velerius, whose work was published in 1520, and who was followed by Flacchius, Salmasius, and, above all, Spanheim. This view has found a few supporters even down to our own time; but the whole current of scholarship, Protestant as well as Catholic—from Scaliger, Casaubon, Usher, Pearson, Cave, &c., down to Neander, Gieseler, Bertholdt, Olshausen, and others in our own country—has accepted the Roman tradition without hesitation. The time of his going to Rome has also been the subject of much discussion. By some, he is alleged not to have gone to Rome till the year 63, or, at all events, a short time before his martyrdom; others date his first visit as early as 42 or 43, without, however, supposing his residence after this date to have been continuous. In his first Epistle, it is implied that at the time of writing it he was at Babylon; and the name Babylon by many critics held to be employed as a mystic designation of Rome, in accordance with a practice not unusual with the Hebrews and other orientals; but there is nothing to fix very conclusively the date of this Epistle. He is held by Roman Catholic writers to have fixed his see at Antioch before his coming to Rome; but of this supposed event also, the date is uncertain. His martyrdom is fixed in, with much probability, the year 66, and is supposed to have been at the same time and place with that of St Paul. P. was sentenced to be crucified, and, according to the tradition (preserved by Eusebius from Origen), prayed that he might be crucified with his head downwards, in order that his death might exceed in ignominy that of his Divine Master.

PETER, EPISTLES GENERAL OF, the name given to two Epistles contained in the canon of the New Testament. They are called *general*, because they are not addressed to particular churches or persons, like those of St Paul; but (as in the case of the 1st Epistle) to all the Christians scattered throughout Asia Minor, or (as in the case of the 2d) to the entire body of Christians without exception. The objects of the 1st Epistle are to strengthen believers under trials; to exhort them to the earnest performance of all duties—personal, social, and domestic; and to demonstrate how thoroughly that performance depends on a spiritual recognition of Christ and his work. There is a strong eschatological tendency

in the Epistle; the apostle seems to grow more intensely serious, under the conviction that 'the end of all things is at hand' (chap. iv. 7). That the Epistle is the composition of Peter is very generally admitted. The external evidence is singularly strong; while the internal, derived from a consideration of style, sentiment, and doctrine, is equally so. We see in every sentence the ardent, impassioned, practical, unspeculative character of Peter, who held with a fine Hebraic vehemence of faith the great facts and principles of Christianity, but could not, like the more subtle and logical Paul, give them a systematic representation. Many critics have warmly praised the beauty and strength of the language.—The *Second Epistle* stands in a very different position from the first. So far as external authority is concerned, it has hardly any. The most critical and competent of the Fathers were suspicious of its authenticity; it was rarely if ever quoted, and was not formally admitted into the canon till the Council of Hippo, 393 A.D. The internal evidence is just as unsatisfactory. The great difference of style between it and the 1st Epistle is universally admitted. Bunsen, Ullmann, and Lange hold indeed that the second chapter is an interpolation, but consider the first and third genuine. Many of the ablest critics, however, regard the whole Epistle as a fabrication, and believe that its contents prove it was meant as an attack on the Gnosticism of the 2d century. [See the remarks on the Second Epistle of Peter in Neander's *Geschichte der Pflanzung und Leitung der Kirche durch die Apostel*.] The principal arguments adduced for maintaining its apostolic character are—1, that its rejection would endanger the authority of the canon; 2, that it is inexplicable how the church should have received it if it had not thought that Peter was the author.

PETER LOMBARD. See LOMBARD, PETER.

PETER-PENCE, the name given to a tribute which was collected in several of the western kingdoms, and offered to the Roman pontiff, in reverence of the memory of St Peter, of whom that bishop was believed to be the successor. From an early period, the Roman see had been richly endowed; and although its first endowments were chiefly local, yet as early as the days of Gregory the Great, large estates were held by the Roman bishops in Campania, in Calabria, and even in the island of Sicily. The first idea, however, of an annual tribute appears to have come from England, and is by some ascribed to Ina (721 A.D.), king of the West Saxons, who went as a pilgrim to Rome, and there founded a hospice for Anglo-Saxon pilgrims, to be maintained by an annual contribution from England; by others, to Offa and Ethelwulf, at least in the sense of their having extended it to the entire of the Saxon territory. But this seems very uncertain; and although the usage was certainly long anterior to the Norman Conquest, Dr Lingard is disposed not to place it higher than the time of Alfred. The tribute consisted in the payment of a silver penny by every family possessing land or cattle of the yearly value of 30 pence, and was collected in the five weeks between St Peter's and St Paul's Day and August 1. In the time of King John, the total annual payment was £199, 8s., contributed by the several dioceses in proportion, which will be found in Lingard's *History of England*, vol. ii. p. 330. The tax called Romescot, with some variation, continued to be paid till the reign of Henry VIII., when it was abolished. By Gregory VII., it was sought to establish it for France; and other partial or transient tributes are recorded from Denmark, Sweden, Norway, and Poland. This tribute,

however, is quite different from the payments made annually to Rome by the kingdoms which were held to be feudatory to the Roman see—as Naples, Aragon, England under the reign of John, and several other kingdoms, at least for a time.

The pope having suffered a considerable diminution of his own revenue since the revolution of 1848, an effort has been made in several parts of Europe to revive this tribute. In some countries, it has been very successful, and the proceeds have been among the chief of the resources by which Pius IX. has been enabled to meet the pressure of pecuniary embarrassments under which, with his diminished territorial possessions, it was supposed that he must necessarily have succumbed.

**PETER THE HERMIT**, the first mover of the great mediæval drama of the **CRUSADES** (q. v.), was of gentle birth, and a native of Amiens, where he was born about the middle of the 11th century. Having been educated at Paris, and afterwards in Italy, he became a soldier. After serving in Flanders without much distinction, he retired from the army, married, and had several children; but on the death of his wife, he became a monk, and ultimately a hermit. In the course of a pilgrimage to the Holy Land about 1093, he was moved by observing that the Holy Sepulchre was in the hands of the Infidel, as well as by the oppressed condition of the Christian residents or pilgrims under the Moslem rule; and on his return, spoke so earnestly on the subject to Pope Urban II., that that pontiff warmly adopted his views, and commissioned him to preach throughout the West an armed confederation of Christians for the deliverance of the Holy City. Mean in figure, and diminutive in stature, his enthusiasm lent him a power which no external advantages of form could have commanded. 'He traversed Italy,' writes the historian of Latin Christianity, 'crossed the Alps, from province to province, from city to city. He rode on a mule, with a crucifix in his hand, his head and feet bare; his dress was a long robe, girt with a cord, and a hermit's cloak of the coarsest stuff. He preached in the pulpits, on the roads, in the market-places. His eloquence was that which stirs the heart of the people, for it came from his own—brief, figurative, full of bold apostrophes; it was mingled with his own tears, with his own groans; he beat his breast: the contagion spread throughout his audience. His preaching appealed to every passion—to valour and shame, to indignation and pity, to the pride of the warrior, to the compassion of the man, the religion of the Christian, to the love of the brethren, to the hatred of the unbeliever aggravated by his insulting tyranny, to reverence for the Redeemer and the saints, to the desire of expiating sin, to the hope of eternal life.' The results are well known, as among those moral marvels of enthusiasm of which history presents occasional examples. All France, especially, was stirred from its very depths; and just at the time when the enthusiasm of that country had been already kindled to its full fervour, it received a sacredness and an authority from the decree of a council held at Clermont, in which Urban himself was present, and in which his celebrated harangue was but the signal for the outpouring, through all Western Christendom, of the same chivalrous emotions by which France had been borne away under the rude eloquence of the Hermit. For the details of the expedition, we must refer to the article **CRUSADES**; our sole present concern being with the personal history of Peter. Of the enormous but undisciplined army which assembled from all parts of Europe, one portion was committed to his conduct; the other being under the command of a far more skilful leader, Walter the Pennyless. P.

placed himself at their head, mounted upon his ass, with his coarse woollen mantle and his rude sandals. On the march through Hungary, they became involved in hostilities with the Hungarians, and suffered a severe defeat at Semlin, whence they proceeded with much difficulty to Constantinople. There the Emperor Alexius, filled with dismay at the want of discipline which they exhibited, was but too happy to give them supplies for their onward march; and near Nice, they encountered the army of the Sultan Solyman, from whom they suffered a terrible defeat. P. accompanied the subsequent expedition under Godfrey; but worn out by the delays and difficulties of the siege of Antioch, he was about to withdraw from the expedition, and was only retained in it by the influence of the other leaders, who foresaw the worst results from his departure. Accordingly, he had a share, although not marked by any signal distinction, in the siege and capture of the Holy City in 1099, and the closing incident of his history as a crusader was an address to the victorious army delivered on the Mount of Olives. He returned to Europe, and founded a monastery at Huy, in the diocese of Liege. In this monastery, he died, July 7, 1115.

**PETER (DON PEDRO) THE CRUEL**, King of Castile and Leon, was the son of Alfonso XI. and Maria of Portugal, and was born at Burgos, 30th August 1334. On his father's death (1350), P. succeeded to the throne without opposition, but left the whole exercise of power to his mother, Donna Maria, and Albuérque, his father's prime minister and chancellor. But by the instigation of his mistress (afterwards his queen), Marie de Padilla, P. emancipated himself (1353) from the guidance of the queen-mother and her coadjutor Albuérque, taking the reins of government in his own hands. His rule being much more impartial than that of the regency, obtained exceeding popularity, which was increased by his affable manner towards the mass of his subjects; but the strict justice with which he decided all causes between the rich and poor, the clergy and the laity, combined with a haughty and imperious carriage towards them, alienated from him the nobles and clergy. The plottings of Albuérque, who had fled to Portugal, having culminated (1354) in an outbreak in the province of Estremadura, P. marched against the rebels, but was betrayed by his brother, Henry of Trastamare, and taken prisoner (December 1354). Popular opinion now declared loudly in his favour; and having escaped from prison, he found himself speedily at the head of a powerful army, with which, despite the excommunication of the pope, he speedily reduced his opponents to submission. But this episode in his career had a disastrous influence on his character for the rest of his life. Betrayed by his relatives, and even by his mother, he became suspicious of every one; and having experienced to the full the power of his enemies, he scrupled not as to the weapons to be employed against them. The rest of his reign was devoted to the destruction of the power of the great vassals, the establishment of his own authority on the ruins of their feudal tyranny, and long continued and bloody wars with the kingdoms of Aragon and Granada. As the people, however, were in general well and justly governed, it is not improbable that he might have retained his throne in spite of his numerous enemies, had not the heavy taxes which were imposed to maintain the cost of his long wars with Aragon and Granada dissipated his popularity. Henry, who had fled to France, now seizing the favourable opportunity, returned (1366) at the head of a body of exiles, backed by Bertrand du Guesclin (q. v.) with an army of mercenaries,



and aided by Aragon, France, and the pope. P., however, by promising to England the sea-board of Biscay, with the provinces of Guipuzcoa and Logrono, and supplying a contribution of 56,000 florins, prevailed upon Edward the Black Prince to espouse his cause. Edward invaded Castile in the spring of 1367, totally defeated Henry and Du Guesclin at Navarette (April), taking the latter prisoner (releasing him almost immediately after), and speedily restoring P. to the throne. But the king disgusted his chivalrous ally by his cruelty to the vanquished, and paid no heed to his remonstrances; Edward accordingly repossessed the Pyrenees, and left the misguided monarch to his fate. The whole kingdom groaned under his cruelties; rebellions broke out everywhere; and, in autumn 1367, Henry returned with 400 lances, the people immediately flocking to his standard. P.'s scanty and ill-disciplined forces were routed at Montiel (14th March 1369), and himself compelled to retire for safety within the town, whence he was treacherously decoyed and captured by Du Guesclin. He was carried to a tent, where a single combat took place between him and Henry, in which the latter would have been slain, had not some of his followers come to his aid, and slain the unfortunate P., 23d March 1369.

**PETER I., ALEXIEVITCH**, Czar of Russia, generally denominated **PETER THE GREAT**, was the son of the Czar Alexei Mikailovitch by his second wife, Natalia Naryskine, and was born at Moscow, 9th June 1672. His father, Alexei, died in 1676, leaving the throne to his eldest son, Feodor, P.'s half-brother. This prince, however, died in 1682 without issue, after naming P. as his successor, to the exclusion of his own full brother, Ivan. This step immediately provoked an insurrection, fomented by the children of the Czar Alexei's first marriage, the most prominent among whom was the grand-duchess Sophia, a woman of great ability and energy, but of unbounded ambition. Disdaining the seclusion customary among the females of the royal family, she shewed herself to the *Strelitz* (q.v.), excited them to fury by an ingenious story of the assassination of her brother Ivan, and then let them loose on the supporters of P.'s claims. After a carnage of three days, during which more than sixty members of the most noble families of Russia were massacred, she succeeded in obtaining the coronation (July 1682) of Ivan and P. as joint rulers, and her own appointment as regent. Up to P.'s coronation his education had been greatly neglected, but after this time he became acquainted with Lieutenant Franz Timmerman, a native of Strasburg, who gave him lessons in the military art and in mathematics; after which he had the good fortune to fall under the guidance of Lefort (q.v.), a Genoese, who initiated him into the sciences and arts of civilisation, and by shewing him how much Muscovy was in these respects behind the rest of Europe, influenced the whole of his future career. Lefort also formed a small military company out of the young men of noble family who attended P., and caused P. himself to pass, by regular steps, from the lowest (that of drummer) to the highest grade in it, rendering him all the while amenable to strict discipline. This course of training, in all probability, saved P. from becoming the mere savage despot, which his brutal and passionate disposition, and indomitable energy inclined him to be; it also protected him from the jealousy of his half-sister, the regent Sophia, who, seeing him absorbed in military exercises and other studies, imagined that he had wholly given himself up to amusement. She, however, soon discovered her error, for P., contrary to her wishes, married (February 1689), by his mother's advice, Eudoxia

Feodorowna, of the family of Lapoukin; and in October of the same year, called upon his sister to resign the government. In the ensuing contest, P. was at first worsted, and compelled to flee for his life; but he was speedily joined by the foreigners in the Russian service, with a Scotchman named Patrick Gordon (q.v.) and the Swiss Lefort at their head; and the *Strelitz*, who were his antagonist's mainstay, flocking to his standard, she resigned the contest, and was shut up in a convent, whence, till her death, in 1704, she did not cease to annoy him by her intrigues. On October 11, 1689, P. made his public entry into Moscow, where he was met by Ivan, to whom he gave the nominal supremacy and precedence, reserving the sole exercise of power for himself. Ivan only enjoyed his puppet sovereignty till 1696. Though P. was all his life under the dominion of ungovernable passions and sensual habits, yet during great part of his reign he was so exclusively engaged in projecting and carrying out his schemes for the regeneration of Russia, that his gross animal nature had little opportunity of displaying itself.

His first care, on assuming the government, was to form an army disciplined according to European tactics, in which labour he was greatly aided by the valuable instructions of Gordon and Lefort, both of whom were military men, and had served in some of the best disciplined armies of Western Europe. He also laboured to create a navy, both armed and mercantile; but at this period Russia presented few facilities for such an attempt, for she was shut out from the Baltic by Sweden and Poland (the former of whom possessed Finland, St Petersburg (then called Ingria), and the Baltic provinces), and from the Black Sea by Turkey, which, extending along the whole of the north coast, had reduced that sea to the rank of an inland lake; leaving only the White Sea and the Arctic Ocean, with the solitary port of Archangel, available for the Russian navy. P. thinking the possession of a portion of the Black Sea would best supply the required facilities of accessible sea-board and port, declared war against Turkey, and took (1696) the city of Azof at the mouth of the Don, after a long siege, which the ineffective condition of his newly-disciplined army compelled him to convert into a blockade. Skilled engineers, architects, and artillerymen were now invited from Austria, Venice, Prussia, and Holland; ships were constructed; the army further improved both in arms and discipline; and many of the young nobility ordered to travel in foreign countries, chiefly in Holland and Italy, for the purpose of acquiring such information as might be useful in the modernisation and civilisation of their country. They were ordered to take special notice of all matters in connection with ship-building and naval equipments. Others were sent to Germany to study the military art. Not quite satisfied with this arrangement, P. was eager to see for himself the countries for which civilisation had done so much, and which had so highly developed the military art, science, trade, and industrial pursuits; so after repressing a revolt of the *Strelitz* (February 1697), and dispersing them among the various provinces, he intrusted the reins of government to Prince Romonadofski, assisted by a council of three, and left Russia in April 1697, in the train of an embassy of which Lefort was the head. In the guise of an inferior official of the embassy he visited the three Baltic provinces, Prussia, and Hanover, reaching Amsterdam, where, and subsequently at Saardam, he worked for some time as a common shipwright. His curiosity was excessive; he demanded explanations of everything which he did not understand; and to his practice of ship-building

and kindred trades, he added the study of astronomy, natural philosophy, geography, and even anatomy and surgery. On receipt of an invitation from William III., king of England, he visited that country, and for three months, spent partly in London and partly at Deptford, laboured to amass all sorts of useful information. While in England he received an honorary degree of D.C.L. from the university of Oxford! He left England in April 1698, carrying with him English engineers, artificers, surgeons, musicians, artillerymen, &c., to the number of 500, and next visited Vienna, for the purpose of inspecting the emperor of Austria's army, then the best in Europe. He was about to visit Venice also, when the news of a formidable rebellion of the Strelitz called him to Russia, which he reached by way of Poland, arriving at Moscow 4th September 1708. General Gordon had already crushed the revolt, but the turbulent soldiers had so enraged P. against them by their frequent outbreaks, that he ordered the whole of them to be executed, even occasionally existing in person on the scaffold. A few, however, were pardoned, and sent to settle at Astrakhan. The zarina Eudoxia, who was suspected of complicity in the conspiracy, which had been the work of the Russian or anti-reform party, was divorced, and shut up in a convent; the czar's own sister, Catharine, was likewise compelled to take the veil. P. shewed his gratitude to his faithful adherents, conferred upon the chief of them the Order of St Andrew, now first instituted. He put the press on a proper footing, caused translations of the most celebrated works of foreign authors to be made and published, and established naval and other schools. During this period, the ordinary arithmetic was first introduced for the management of accounts, these having been previously kept by means of balls strung on a wire (the Tartar method). P. also introduced the mode of raising revenue by taxation of commodities in common use. Trade with foreign countries, which was formerly punished as a capital crime, was now permitted, or rather, in the case of the principal merchants, insisted upon. Many improvements in dress, manners, and etiquette were introduced authoritatively among the public functionaries, and recommended to the people at large. Even the organisation of the national church did not escape P.'s reforming zeal. In 1700, P., desirous of gaining possession of Livonia and Ingria, provinces of Sweden, which had formerly belonged to Russia, entered into an alliance with the kings of Poland and Denmark to make a combined attack on Sweden, taking advantage of the tender age of its monarch, Charles XII.; but was shamefully defeated at Narva, his raw troops being wholly unable to cope with the Swedish veterans. P. was by no means disheartened, for, taking advantage of the Swedes being employed elsewhere, he quietly appropriated a portion of Livonia, in which he laid the foundation of the new capital, St Petersburg, 27th May 1703. Great settlements were held out to those who would settle in it, and in a few years it became the Russian commercial dépôt for the Baltic. In the contest with Sweden, the Russians were almost always defeated, but P. rather rejoiced at this, as he thought that these reverses were administering to his subjects a more lasting and effective discipline than he could have hoped to give them in any other way. He had his revenge at last, in totally routing the Swedish king at Poltava (q. v.), 8th July 1709, and seizing the whole of the Baltic provinces and a portion of Finland in the following year. His success against Sweden helped much to consolidate his empire, and to render his subjects more favourably disposed towards the new order of things. After

re-organising his army, he prepared for strife with the Turks, who, at the instigation of Charles XII (then residing at Bender), had declared war against him. See OTTOMAN EMPIRE. In this contest, P. was reduced to such straits that he despaired of escape, and, looking forward to death or captivity, wrote a letter to his chief nobles, cautioning them against obeying any orders he might give them while a captive, and advising them regarding a successor to the throne in case of his death. But the finesse and ability of his mistress, Catharine, afterwards his wife and successor (see CATHARINE I.), extricated him from his difficulties; and a treaty was concluded (23d July 1711) by which Peter lost only his previous conquest—the port of Azof and the territory belonging to it. Shut out from the Black Sea, the possession of a good sea-board on the Baltic became the more necessary to him, and the war against Sweden in Pomerania was accordingly pushed on with the utmost vigour. On 2d March 1712, his marriage with his mistress, Catharine, was celebrated at St Petersburg; and two months afterwards, the offices of the central government were transferred to the new capital. His arms in Pomerania and Finland were crowned with success, and in 1713 the latter province was completely subdued. P. neglected nothing to develop the naval power of the empire, and the strictness with which he enforced the discharge of their duties on his ministers and officers, appears from the refusal, by the court of admiralty, of the czar's own application for the grade of vice-admiral, until by defeating the Swedish fleet at Hangoend, and taking the Aland Isles, and several coast-forts in Finland, he had merited the honour. In the end of 1716, and beginning of 1717, in company with the zarina, he made another tour of Europe, this time visiting Paris, where he was received with great empressement, and returned to Russia in October 1717, carrying with him books, paintings, statues, &c., to a large amount. It was soon after this time that he ordered his son Alexei (q. v.) to be executed, and many of the nobles who had been implicated in his treasonable plans were punished with savage barbarity. In 1721 peace was made with Sweden, and on condition of that power giving up the Baltic provinces, Ingria (now government of St Petersburg), Viborg, and Kexholm, and a small portion of Finland, with all the islands along the coast from Courland to Viborg, she received back the rest of Finland, with a sum of £400,000. In 1722 P. commenced a war with Persia, in order to open up the Caspian Sea to Russian commerce (see PERSIA). The internal troubles of Persia compelled the shah to yield to the demands of his formidable opponent, and to hand over the three Caspian provinces along with the towns of Derbend and Baku. On P.'s return to his capital, he inquired into the conduct of his finance ministers, and punished with fines, imprisonment, and even death, those whom he detected in fraudulent acts. To save the empire which he had established and constituted from being abandoned to the weak government of a minor, he, in February 1722, promulgated his celebrated law of succession (see PETER II.). For the last years of his life he was chiefly engaged in beautifying and improving his new capital, and carrying out plans for the more general diffusion of knowledge and education among his subjects. In the autumn of 1724 he was seized with a serious illness, the result of his imprudence and now habitual excesses; and after enduring much agony, he expired, 8th February 1725, in the arms of the empress.

**PETER II., ALEXEIVITCH**, Czar of Russia, was the sole male representative of Peter the Great, being the son of the unfortunate Alexei (see

## PETER III.—PETERBOROUGH.

PETER I.) by his wife the Princess Charlotte of Brunswick-Wolfenbützel, and was born 23d October 1715 at St Petersburg. On the death of the Czarina Catharine I, he ascended the throne, May 17, 1727, in accordance with a decree of Peter the Great, which enjoined that each czar should name his successor; and the ambitious Menchikoff, who hoped to govern more easily in the name of a minor, prompted the empress to choose P. In order to secure himself in his high position, Menchikoff affianced one of his daughters to the youthful czar, and compelled his relative, Anna, Petrowna, and her husband, the Duke of Holstein, to retire to their own estates. But, notwithstanding these and other precautions, his power was overturned by a mere child, a playfellow of the boy-ruler, who was of the powerful family of Dolgorouki. Instigated by his friends, this boy, Ivan Dolgorouki, opened the eyes of his sovereign to the humiliating dependence in which he was held by Menchikoff, and inspired him with a strong desire to free himself. The plan succeeded, and the minister and his family were exiled to Siberia, the Dolgorouki family taking their place as favourites. The marriage of a lady of this family with P. had been arranged, and was almost on the point of being celebrated, when he was seized with small-pox, and died at St Petersburg, January 29, 1730. During his reign, the three Caspian provinces, Asterabad, Ghilan, and Mazanderan, which had been seized by Peter the Great, were recovered by Persia.

PETER III. FEODOROVITCH, Czar of Russia, grandson of Peter the Great (being the son of his eldest daughter Anna Petrowna, wife of Karl Friedrich, Duke of Holstein-Gottorp), was born at Kiel, March 4, 1728, and on November 18, 1742, was declared by the czarina Elizabeth (q. v.), her successor on the throne of Russia. From the time of his being publicly proclaimed heir, he lived at the Russian court; and, in obedience to the wishes of the czarina, married Sophia-Augusta, a princess of Anhalt-Zerbst, who, on entering the Greek Church (a necessary condition of marriage of a foreigner with the czar present or presumptive), assumed the name of Catharina Alexiowna. P. succeeded Elizabeth on her death, June 5, 1762; and his first act of authority was to withdraw from the confederate league of France, Austria, and Russia against Prussia, restoring to the heroic monarch of the latter kingdom, Frederic II, the provinces of Prussia Proper, which had been conquered during the Seven Years' War, and sending to his aid a force of 15,000 men; a line of conduct which seems to have been prompted solely by his admiration for the Prussian sovereign. He also recalled many of the political exiles from Siberia, among whom were L'Estocq, Munnich, and the Duke of Courland; abolished the sanguinary law which proscribed any one who should utter a word against the Greek church, the czar, or the government; and then attempted the realisation of his favourite project, which was to recover from Denmark that portion of Slesvig which had been ceded to her in 1713, and to avenge the tyranny and annoyances to which his family—that of Holstein-Gottorp—had been subjected. But before the army he had despatched could reach its destination, a formidable conspiracy, headed by his wife, and supported by the principal nobles, had broken out against him. This conspiracy originated in the general discontent which was felt at the czar's conduct and government; for the nobility were offended at his liberal innovations, and the preference he shewed for Germans; the people and clergy, at his indifference to the national religion, and his ill-concealed contempt for Russian manners and customs; while the whole nation

murmured at his servility to Frederic II. of Prussia. His wife had still deeper cause for dislike; for though he was himself addicted to drunkenness and debauchery, he never ceased to reproach her with her infidelities, and had even planned to divorce her, disinherit her son Paul (q. v.), and elevate his mistress Elizabeth Woronzof to the conjugal throne. The revolution broke out on the night of the 8th July 1762; P. was declared to have forfeited his crown, and his wife Catharine was proclaimed czarina as Catharine II. (q. v.) by the Guards, the clergy, and the nobility. P., who was then at Oranienbaum, neglecting the counsels of Field-marshal Munnich, who proposed to march at once on the capital at the head of the regiments which were still faithful, or at any rate to take secure possession of Cronstadt and the fleet, soon found even the opportunity of flight cut off, and was compelled to submit. He abdicated the crown on 10th July, and on the 14th of the same month was put to death by Orlof (q. v.), to secure the safety of the conspirators.

PETERBOROUGH, an episcopal city and parliamentary borough of Northamptonshire, stands on the left bank of the Nen—which is thus far navigable for boats—37 miles north-east of Northampton, and 76 miles north-north-west of London by railway. The Great Northern, the Eastern Counties, the Northampton and Peterborough, and the Midland Counties' railways pass the city, and have stations here. P. is regularly laid out, has an excellent grammar-school with an endowment, a corn-exchange in the Italian style, a jail and house of correction, a handsome parish-church, and a number of chapels and meeting-houses, schools, and charitable institutions.

But the great edifice of P. is the famous cathedral, which holds a high, if not the highest rank among English cathedrals of the second class. The choir and eastern aisles of the transept (built 1118—1133) are early Norman; the transept (1155—1177) is middle Norman; the nave (1177—1193) is late Norman; the western transept (dating from the same period), is transition Norman; the west front, which, as a portico (using that term in its classical sense), is said to be the grandest and finest in Europe, is early English; and the eastern aisle (begun in 1438, but not completed till 1528), is Perpendicular. The beautiful western front consists of three arches 81 feet in height, supported by triangular piers detached from the west wall. Each arch is surmounted by a beautiful pediment and cross. The front is flanked on each side with turrets 156 feet high, and crowned with pinnacles. The roof of the nave is painted in lozenge-shaped divisions, containing figures of kings, bishops, grotesques, &c., in colours. A central tower, lantern-shaped, rises at the intersection of the nave and transept. In the north-choir aisle, a slab of blue stone still covers the remains of Catharine of Aragon. On the stone is carved the simple inscription, 'Queen Catharine, A. D. 1536.' In July 1537, the remains of Mary, Queen of Scots, were brought here from Fotheringay for interment, and here they rested until, twenty-five years after, they were removed to Westminster Abbey. The entire length of the cathedral is 476 feet 5 inches; the breadth of nave and aisles, 78 feet; height of the ceiling of the church, 78 feet; breadth of the church at the great transepts, 203 feet; height of lantern, 135 feet; length of western front, 156 feet; height of central tower from the ground, 150 feet.

P. carries on an active trade in corn, coal, timber, lime, bricks, and stone. The borough returns two members to the House of Commons. Pop. of parliamentary borough (1851), 8672; (1861), 11,735.

PETERBOROUGH—PETER'S, ST, CHURCH

city had its origin in a great Benedictine monastery, founded in 655 by Oswy, king of Northumbria, and Peada, son of Penda, king of Mercia. This monastery, which became one of the richest and most important in England, was in honour of St Peter; but it was not until 1066 being destroyed by the Danes in 807, and about 966, that the town was called Peterborough. On the dissolution of the monasteries, the magnificent edifice was spared, owing, it is said, to its containing the remains of Queen Isabella of Aragon.—Murray's *Handbook to the Cathedrals*.

PETERBOROUGH, LORD. See MORDAUNT.

PETERHEAD, a seaport and municipal and sanitary borough, Aberdeenshire, stands on a peninsula, the most eastern point of land in Scotland, 4 miles north-north-east of Aberdeen, by the North of Scotland Railway. It is irregularly shaped, clean, and is paved in many cases with the granite, which receives its name from the town. A large portion of the parish, and the superior part of the town of P. formerly belonged to the Stuart family, 1715. This valuable possession, in process of time, by purchase the property of the Merchant Maiden Hospital of Edinburgh, the donors of which have latterly done much in the improvement both for the town and port. It contains no very striking edifices. Its parish has a granite spire, 118 feet in height, and a pillar of the Tuscan order stands on the west cross. There are Episcopal, Free Church, Catholic, and other chapels; an academy and other schools, and two libraries. Recently, and woiney manufactures have been introduced. Ship-building is carried on to a considerable extent; herrings, cod-fish, butter, grain, and granite are exported, and lime, wool, and general merchandise are imported. P. was long famous as the dépôt of the seal and whale-fisheries in the north; but within recent years the fisheries have generally unprofitable, and this interest has declined. In 1864 about 20 vessels, a larger number than sent out by any other British port, were engaged in the different branches of this trade. The east-fisheries are still vigorously prosecuted, and the season a fleet of 300 herring-boats put out from the harbours in the evening. P. is the principal fishing-station in Scotland. In 1863, upwards of 100 barrels of cured herrings were exported to the continent. In 1863, 1064 vessels of 68,550 tons entered and cleared the port. The two harbours are respectively on the north and south side of the tip of the peninsula on which the town is situated, and a passage connecting them has been cut through the isthmus, so that vessels can leave harbour in any state of the wind. This town has often been designated as a Harbour of Refuge. On the south side of the bay of P., and about 2½ miles from Peterhead, is Buchanness, and near it are the picturesque ruins of Boddam Castle. Inverurie and Craig castles, now mere ruins, are finely situated on the banks of the Ugie, which enters the sea a mile north of the town. P. unites with other (q. v.) boroughs in sending a member to parliament. Pop. of parliamentary borough (1851) 18,611; (1861), 7541.

PETERLOO MASSACRE, the name popularly given to the dispersal of a large meeting by armed troops at St Peter's Field, Manchester, Monday, July 19, 1819. The assemblage, consisting chiefly of volunteers of operatives from different parts of Lancashire, was called to consider the question of parliamentary reform, and the chair, on open hustings, was occupied by Mr Henry Hunt. The dispersal

took place by order of the magistrates; several troops of horse, including the Manchester Yeomanry, being concerned in the affair, of which an account will be found in *History of the Peace*, by Harriet Martineau, edition of 1858, p. 107. Five or six persons were killed and many wounded. St Peter's Field is now covered by buildings. Peterloo was a fanciful term, suggested by Waterloo.

PETER'S, ST, CHURCH, at Rome, is the largest cathedral in Christendom. It stands on the site of a much older basilica, founded by Constantine, A. D. 306, over the reputed grave of St Peter, and near the spot where he is said to have suffered martyrdom. This basilica was of great size and magnificence; but had fallen into decay, when Pope Nicholas V., in 1450, resolved to erect a new cathedral, worthy of the dignity and importance of the Roman pontificate, then in the zenith of its power. A design was accordingly prepared by Rossellini on a very grand scale, and the tribune was begun, when the pope died. The new building remained neglected for about half a century, when Julius II. resolved to carry out the building, and employed Bramanté, then celebrated as an architect, to make a new design. This design still exists. The foundation stone was laid, in 1469; and the works carried on with great activity till the death of the pope in 1513. Bramanté, who died the following year, was succeeded by Baldussare Peruzzi. Almost every architect who was employed during the long course of time required for the erection of this great edifice, proposed a new design. That of San Gallo, who succeeded Peruzzi, is one of the best, and is still preserved. It was not till his death in 1546, when the superintendence devolved on Michael Angelo, then seventy-two years of age, that much progress was made. He designed the dome; and had the satisfaction, before his death in his ninetieth year (1564), of seeing the most arduous part of the task completed; and he left such complete models of the remainder that it was carried out exactly in conformity with his design by his successors, Vignola and Giacomo della Porta, and successfully terminated by the latter in 1590 in the pontificate of Sixtus V. The design of Michael Angelo was in the form of a Greek cross, but the building was actually completed as originally designed by Bramanté as a Latin cross, under Paul V., by the architect Carlo Maderno. The portico and façade were also by him. He is much blamed for altering Michael Angelo's plan, because the result is that the projecting nave prevents the dome (the *great* part of the work) from being well seen. The façade is considered paltry, and too much cut up into small pieces. It is observable that this entrance façade is at the *east* end of the church, not the west, as it would certainly have been north of the Alps. But in Italy the principle of orientation was little regarded.

Maderno's nave was finished in 1612, and the façade in 1614, and the church dedicated by Urban VIII in 1626. In the front of the portico is a magnificent atrium in the form of a piazza, enclosed on two sides by grand semicircular colonnades. This was erected under Alexander VII by the architect Bernini.

The façade of the cathedral is 368 feet long and 145 feet high. As already mentioned, the design is not generally approved, but some allowance must be made for the necessities of the case. The balconies in the front were required, as the pope, at Easter, always bestows his blessing on the people from them. Five open arches lead into a magnificent vestibule, 439 feet long, 47 feet wide, and 65 feet high, and adorned with statues and mosaics. Here is preserved a celebrated mosaic of St Peter

walking on the sea, called the Navicella, designed by Giotto in 1298, and preserved from the old basilica. The central bronze doors are also relics saved from the old church. On entering the interior of the cathedral, its enormous size does not produce the impression its grandeur of proportions should do on the spectator. This arises from the details being all of an excessive size. The pilasters of the nave, the niches, statues, mouldings, &c., are all such as they might have been in a much smaller church, magnified. There is nothing to mark the scale, and give expression to the magnitude of the building. The figures supporting the holy water fountain, for example, appear to be those of cherubs of a natural size, but when more closely approached, turn out to be six feet in height, and the figures in the niches are on a still more colossal scale. The cathedral is 613 feet long, and 450 feet across the transepts. The arch of the nave is 90 feet wide, and 162 feet high. The diameter of the dome is 195½ feet. From the pavement to the base of the lantern is 405 feet, and to the top of the cross 434½ feet. The dome is thus 50 feet wider, and 64 feet higher than that of St Paul's (q. v.) in London.

The walls of the interior are adorned with plates of the richest marbles, and copies of the most celebrated paintings executed in mosaic. The arch piers have two stories of niches with statues of saints, but these, unfortunately, are in a debased style of art. The pavement is all in marbles of different colours, arranged in beautiful patterns designed by Giacomo della Porta. The dome is, however, the finest part of the cathedral; it is supported on four great arches. Immediately under the dome stands the high altar over the grave of St Peter. It is surmounted by a magnificent baldacchino or canopy, in bronze, which was designed by Bernini in 1633, and executed with bronze stripped from the Pantheon by Pope Urban VIII. Beneath the high altar is the shrine, in which 112 lamps burn day and night. The building is adorned with many remarkable monuments and statues, some of them by Michael Angelo, Canova, and Thorwaldsen. The most of the monuments are erected in memory of the popes, but there is one to 'James III., Charles III., and Henry IX., kings of England,' the remains of the exiled Stuarts being buried in the vaults beneath. The 'Grotte Vaticane,' or crypt, has been most carefully and religiously preserved during all the changes and works of the cathedral; so much so, that the ancient pavement remains undisturbed.

As a work of architectural art, St Peter's is the greatest opportunity which has occurred in modern times; but, notwithstanding the great names of the men who were engaged upon the work, it is universally admitted to be a grand and lamentable failure.

**PETER'S, St, COLLEGE**, Cambridge, commonly called Peter-House, was founded before any other college now existing in England—viz., in 1257, by Hugh de Balsham, Bishop of Ely, and was endowed by him in 1282, with a maintenance for a master and 14 fellows. In addition to the 14 original foundation-fellows, there are eight by-fellows on different foundations, and 23 scholars. The master is elected by the society.

**PETERSBURG**, a city and port of entry of Virginia, U. S., on the south bank of the Appomattox river, 12 miles above its junction with James River, at City Point. It is 30 miles south of Richmond. Five railways contribute to make it the third city in the state. It has gas and waterworks, custom-house, court-house, mechanics'

hall, public library of 5000 vols.; 4 banks of issue; 4 savings banks; 3 daily and 2 weekly papers; 14 churches, 4 of which are for people of colour; 50 manufacturing establishments, among which 20 manufacture 26,000,000 lbs. of tobacco, the chief staple. In the campaign of 1864, Lieutenant-General Grant, commander of the Federal army, failing to take Richmond, besieged P., and was repulsed in several attacks by General Beauregard, with heavy loss. Pop. (1860) 18,266.

**PETERSBURG, St.** See **St PETERSBURG**.

**PETERSFIELD**, a parliamentary borough and market-town in Hampshire, 23 miles east-north-east of Southampton, and 55 miles south-west of London by railway. It is a pleasant country-town, and contains a Norman parish chapel of the 12th c., and an educational institution, called Churcher's College. An equestrian statue of William III., once richly gilt, stands in the market-place. P. returns a member to the House of Commons. Pop. (1861) of town, 1466; of borough, 5655.

**PETERWARDEIN**, the capital of the Slavonic-Servian military frontier, and one of the strongest fortresses in the Austrian dominions, is situated in a marshy, unhealthy locality on the right bank of the Danube, 50 miles north-west of Belgrade. The ordinary garrison consists of 2000 men, besides which the town and suburbs contain a population of about 4600, mostly Germans. The most ancient part of the fortifications, the Upper Fortress, is situated on a rock of serpentine, which on three sides rises abruptly from the plain. P., situated on a narrow peninsula formed by a loop of the Danube, occupies the site of the Roman *Acumincum* (*acumen*, point), and is said to have been named in honour of Peter the Hermit, who marshalled here the soldiers of the first crusade. In 1688, the fortifications were blown up by the imperialists, and the town was soon after burned to the ground by the Turks; but at the Peace of Passarowitz, on 21st July 1718, it remained in the possession of the emperor. It was here that, on 5th August, 1716, Prince Eugene obtained a great victory over the Grand Vizier Ali.

**PÉTIOLÉ.** See **LEAVES**.

**PÉTION DE VILLENEUVE, JÉRÔME**, noted for the part he played in the first French Revolution, was the son of a procurator at Chartres, and was born there in 1753. He was practising as an advocate in his native city, when he was elected in 1789 a deputy of the *Tiers Etat* to the States-General. His out-and-out republican principles, and his facile oratory, sonorous rather than eloquent, quickly made him popular, though he had an essentially mediocre understanding, and was altogether a windy, verbose personage. He was a prominent member of the Jacobin Club, and a great ally of Robespierre; the latter was called the 'Incorruptible,' and P. the 'Virtuous.' He was sent along with Barnave and Latour-Maubourg to bring back the fugitive royal family from Varennes, and in the execution of this commission he acted in an extremely unfeeling manner. He afterwards advocated the deposition of the king, and the appointment of a popularly elected regency, and along with Robespierre received, 30th September 1791, the honours of a public triumph. On the 18th of November, he was elected *Maire de Paris* in Bailly's stead, the court favouring his election, to prevent that of Lafayette. In this capacity he encouraged the demonstrations of the lowest classes, and the arming of the populace. But as the catastrophe drew near, he awoke to a sense of its terrible nature, and sought in vain to arrest the torrent. On the triumph of the

**Terrorists.** P.'s popularity declined, and he joined the Girondists. On the king's trial, he voted for death, but with delay of execution and appeal to the people, upon which he became suspected of being a royalist, and of partaking in the treason of Dumouriez. He was thrown into prison, 2d June 1793, on the fall of the Gironde, but escaped from prison, and joined the other Girondists at Caen. Upon the defeat of their army by that of the Convention, he fled, in July 1793, into Bretagne, and in company with Buzot reached the neighbourhood of Bourdeaux, which, however, had already submitted. A short time after, P.'s and Buzot's corpses were found in a corn-field near St Emilion, partly devoured by wolves. They were supposed to have died by their own hands. P.'s character has been defended by Madame de Genlis and Madame Roland. It appears that he was extremely virtuous in all his domestic relations; but, on the other hand, his public career shews him to have been weak, shallow, ostentatious, and vain. *Les Œuvres de Pétion*, containing his speeches, and some small political treatises, were published in 1793.

**PETITIO PRINCIPII** ('a begging of the principle or question') is the name given in Logic to that species of vicious reasoning in which the proposition to be proved is assumed in the premises of the syllogism.

**PETITION** (Lat. *peto*, I ask), a supplication preferred to one capable of granting it. The right of the British subject to petition the sovereign or either House of Parliament for the redress of grievances is a fundamental principle of the British constitution, and has been exercised from very early times. The earliest petitions were generally for the redress of private wrongs, and the mode of trying them was judicial rather than legislative. Receivers and triers of petitions were appointed, and proclamation was made inviting all persons to resort to the receivers. The receivers, who were clerks or masters in Chancery, transmitted the petitions to the triers, who were committees of prelates, peers, and judges, who examined into the alleged wrong, sometimes leaving the matter to the remedy of the ordinary courts, and sometimes transmitting the petition to the chancellor or the judges, or, if the common law afforded no redress, to parliament. Receivers and triers of petitions are still appointed by the House of Lords at the opening of every parliament, though their functions have long since been transferred to parliament itself. The earlier petitions were generally addressed to the House of Lords; the practice of petitioning the House of Commons first became frequent in the reign of Henry IV.

Since the Revolution of 1688, the practice has been gradually introduced of petitioning parliament, not so much for the redress of specific grievances, as regarding general questions of public policy. Petitions must be in proper form and respectful in language; and there are cases where petitions to the House of Commons will only be received if recommended by the crown, as where an advance of public money, the relinquishment of debts due to the crown, the remission of duties payable by any person, or a charge on the revenues of India have been prayed for. The same is the case with petitions praying for compensation for losses out of the public funds. A petition must, in ordinary cases, be presented by a member of the House to which it is addressed; but petitions from the corporation of London may be presented by the sheriffs or lord mayor. Petitions from the corporation of Dublin have also been allowed to be presented by the lord mayor of that city, and it is believed that

a similar privilege would be acceded to the lord provost of Edinburgh.

The practice of the House of Lords is to allow a petition to be made the subject of a debate when it is presented; and unless a debate has arisen on it, no public record is kept of its substance, or the parties by whom it is signed. In the House of Commons, petitions not relating to matters of urgency are referred to the Committee on Public Petitions, and in certain cases ordered to be printed.

In 1837, there were presented to parliament 10,831 petitions with 2,905,905 signatures; in 1859, 24,386 petitions, with 2,290,579 signatures.

**PETITION OF RIGHTS**, a declaration of certain rights and privileges of the subject obtained from King Charles I. in his first parliament. It was so called because the Commons stated their grievances in the form of a petition, refusing to accord the supplies till its prayer was granted. The petition professes to be a mere corroboration and explanation of the ancient constitution of the kingdom; and after reciting various statutes, recognising the rights contended for, prays 'that no man be compelled to make or yield any gift, loan, benevolence, tax, or such like charge, without common consent by act of parliament; that none be called upon to make answer for refusal so to do; that freemen be imprisoned or detained only by the law of the land, or by due process of law, and not by the king's special command, without any charge; that persons be not compelled to receive soldiers and mariners into their houses against the laws and customs of the realm; that commissions for proceeding by martial law be revoked.' The king at first eluded the petition, expressing in general terms his wish that right should be done according to the laws, and that his subjects should have no reason to complain of wrongs or oppressions; but at length, on both Houses of Parliament insisting on a fuller answer, he pronounced an unqualified assent in the usual form of words, '*Soit fait comme il est désiré*,' on the 26th of June 1628.

**PETRA** (Heb. SELA, both names signify 'Rock') was anciently the capital of the Nabatheans, and was situated in the 'desert of Edom' in Northern Arabia, about 72 miles north-east of Akabah—a town at the head of the Gulf of Akabah, an arm of the Red Sea. It occupied a narrow rocky valley overhung by mountains, the highest and most celebrated of which is Mount Hor, where Aaron, the first Hebrew high-priest, died, and was thus in the very heart of the region hallowed by the forty years' wanderings of the Israelites. The aboriginal inhabitants were called *Horim* ('dwellers in caves'). It was then conquered by the Edomites or Idumeans (but it never became their capital); and, in the 3d or 4th c. B. C., it fell into the hands of the Nabatheans, an Arab tribe, who carried on a great transit-trade between the eastern and western parts of the world. It was finally subdued by the Romans in 105 A. D., and afterwards became the seat of a metropolitan; but was destroyed by the Mohammedans, and for 1200 years its very site remained unknown to Europeans. In 1812, Burckhardt first entered the valley of ruins, and suggested that they were the remains of ancient Petra. Six years later, it was visited by Messrs Irby, Mangles, Banks, and Leigh, and in 1828 by M.M. Laborde and Linant, and since then by numerous travellers and tourists to the East, as Bartlett, Porter, and Dean Stanley. Laborde's drawings give us a more vivid impression of the ruins of P. than any descriptions, however picturesque. These ruins stand in a small open irregular basin, about half a mile square, through which runs a brook, and are best approached

## PETRA—PETRARCA.

by an extraordinary chasm or ravine, called the *Sik*, narrowing as it proceeds till in some places the width is only 12 feet, while the rocky walls of red-sandstone tower to the height of 300 feet. Hardly a ray of light can pierce this gloomy gorge, yet it was once the highway to P., and the remains of an ancient pavement can be traced beneath the brilliant oleanders that now cover the pathway. All along the face of the rocky walls are

rows of cave-tombs, hewn out of the solid stone, and ornamented with façades. These are also numerous elsewhere. Originally, they were probably dwellings of the living, not of the dead—a supposition justified by an examination of their interior; but when the Nabathæans built the city proper in the little basin of the hills, they were in all likelihood abandoned, and then set apart as the family-sepulchres of those who had formerly been dwellers in the clefts of



Petra—Mount Seir.—From Laborde.

the rocks.' The principal ruins are—1. *El-Khuzneh* ('the Treasure-house'), believed by the natives to contain, buried somewhere in its sacred enclosure, the treasures of Pharaoh. It directly faces the mouth of the gorge we have described, and was the great temple of the Petreans. 2. *The Theatre*, a magnificent building, capable of containing from 3000 to 4000 spectators. 3. *The Tomb with the Triple Range of Columns*. 4. *The Tomb with Latin Inscription*. 5. *The Deer* or *Convent*, a huge monolithic temple, hewn out of the side of a cliff, and facing Mount Hor. 6. *The Acropolis*. 7. *Kusr Farôn*, or Pharaoh's palace, the least incomplete ruin of Petra. Most of the architecture is Greek, but there are also examples of the influence of Egypt, pyramidal forms being not unknown.

**PETRARCA, FRANCESCO**, the first and greatest lyric poet of Italy, was the son of a Florentine notary named Petracco, who belonged to the same political faction as the poet Dante, and went into exile along with him and others in 1302. Petracco took up his residence at Arezzo, and here the future poet was born in the month of July 1304. His original name was Francesco di Petracco, which he subsequently changed to that by which he is now known. When P. was about eight years of age, his father removed to Avignon, where the papal court was then held; and here, and at the neighbouring town of Carpentras, the youth studied grammar, rhetoric, and dialectics. Contrary to his own inclination, but in compliance with the wish of his father, he spent seven years in the study of law at Montpellier and Bologna; but in 1326 his father

died, and P. now devoted himself partly to the gaieties of Avignon, and partly to classical studies, or rather to the study of the Latin classics, as it was only towards the end of his life that he attempted to master Greek. At this time, he ranked among his friends, the jurist Soranzo, John of Florence, the apostolic secretary, Jacopo Colonna, Bishop of Lombes in Gascony, and his brother, the Cardinal Giovanni, Azzo da Corregio, lord of Parma, and many other noble and learned personages. His illustrious admirers—among whom were emperors, popes, dukes, kings, and sovereign-dukes—obviously thought themselves honoured by their intimacy with the son of a poor notary, and some were even forward in proffering him their favour. But the great event in P.'s life (viewed in the light of its literary consequences) was his tenderly romantic and ultimately pure passion for Laura—the golden-haired, beautiful Frenchwoman. Some slight obscurity still hangs over his relation to this lady, but it is almost certain that she was no less a paragon of virtue than of loveliness. He met her on the 6th of April 1327 in the church of St Clara in Avignon, and at once and for ever fell deeply in love with her. The lady was then 19, and had been married for two years to a gentleman of Avignon, named Hugues de Sade. For ten years P. lived near her in the papal city, and frequently met her at church, in society, at festivities, &c. He sung her beauty and his love in those sonnets whose mellifluous conceits ravished the ears of his contemporaries, and have not yet ceased to charm. Laura was not insensible to a worship, which made a

emperor (Charles IV.) beg to be introduced to her, and to be allowed to kiss her forehead; but she seems to have kept the too-passionate poet at a proper distance. Only once did he dare to make an avowal of his love in her presence, and then he was sternly reproved. In 1333, P. withdrew from Avignon to the romantic valley of Vaucluse, where he lived for some years, spending his time almost solely in literary pursuits. A most brilliant honour awaited him at Rome, in 1341, where, on Easter-day, he was crowned in the Capitol with the laurel-wreath of the poet. The ceremonies which marked this coronation were a grotesque medley of pagan and Christian representations. P. was, however, as ardent a scholar as he was a poet; and throughout his whole life, he was occupied in the collection of Latin MSS., even copying some with his own hand. To obtain these, he travelled frequently throughout France, Germany, Italy, and Spain. His own Latin works were the first in modern times in which the language was classically written. The principal are his *Epistola*, consisting of letters to his numerous friends and acquaintances, and which rank as the best of his prose works; *De Vitiis Virorum Illustrum*; *De Remedijs utriusque Fortunæ*; *De Vita Solitaria*; *Remum Memorandarum Libri IV.*; *De Contemptu Mundi*, &c. P. wrote numerous epistles in Latin verse, eclogues, and an epic poem called *Africa*, on the subject of the second Punic War. It was this last production which obtained for him the laurel-wreath at Rome. P. it may be mentioned, displayed little solicitude about the fate of his beautiful Italian verse, but built his hope of his name being remembered on his Latin poems, which, it has been said, are now only remembered by his name. In 1353 he finally left Avignon, and passed the remainder of his life in Italy—partly at Milan, where he spent nearly ten years, and partly at Parma, Mantua, Padua, Verona, Venice, and Rome. At last, in 1370, he removed to Arquà, a little village prettily situated among the Euganean Hills, where he spent his closing years in hard scholarly work, much annoyed by visitors, troubled with epileptic fits, not overly rich, but serene in heart, and displaying in his life and correspondence a rational and beautiful piety. He was found dead in his library on the morning of the 18th July 1374, his head dropped on a book!—P. was not only far beyond his age in learning, but had risen above many of its prejudices and superstitions. He despised astrology, and the childish medicine of his times; but, on the other hand, he had no liking for the conceited scepticism of the medieval savants; and, in his *De sui Ipsius et multorum aliorum Ignorantia*, he sharply attacked the irreligious speculations of those who had acquired a shallow free-thinking habit from the study of the Arabico-Aristotelian school of writers, such as Averrhoes. P. became an ecclesiastic, but was contented with one or two inconsiderable benefices, and refused all offers of higher ecclesiastical appointment.—The Italian lyrics of P.—the chief of which are the *Rime*, or *Canzoniere*, in honour of Laura—have done far more to perpetuate his fame than all his other works. Of Italian prose, he has not left a line. The *Rime*, consisting of sonnets, canzonets, madrigals, were composed during a period of more than forty years; and the later ones—in which P.'s love for Laura, long since laid in her grave, appears purified from all earthly taint, and beautiful with something of a beatific grace—have done as much to refine the Italian language as the *Divina Commedia* of Dante. Of his *Rime*, there have been probably more than 300 editions. The first is that of Venice, 1470; the most accurate is that by Marsand (2 vols., Padua,

1819). Collective editions of his whole works have also been published (Basel, 1495, 1554, and 1581, *et seq.*) His life has employed many writers, among whom may be mentioned Bellutello, Beccadelli, Tomasini, De la Bastie, De Sades, Tiraboschi, Baldelli, and Ugo Foscolo.

**PETREL** (*Procellaria*), a genus of birds, sometimes ranked among *Laridæ* (q. v.), and sometimes constituted into a separate family, *Procellaridæ*, which is now subdivided into several genera, and distinguished by having the bill hooked at the tip, the extremity of the upper mandible being a hard nail, which appears as if it were articulated to the rest, the nostrils united into a tube which lies along the back of the upper mandible, and the hind-toe merely rudimentary. They possess great power of wing, and are among the most strictly oceanic of birds, being often seen at great distances from land. Among the *Procellaridæ* are reckoned the Fulmars (q. v.), Shearwaters (q. v.), &c., and the small birds designated STORM PETRELS, STORM BIRDS, and MOTHER CAREY'S CHICKENS. These form the genus *Thalassidroma* of recent ornithological systems, the name (Gr. sea-runner) being given to them in allusion to their apparent running along the surface of the waves, which they do in a remarkable manner, and with great rapidity, particularly when the sea is stormy, and the molluscs and other animals forming their food are brought in abundance to the surface—now descending into the very depth of the hollow between two waves, now touching their highest foamy crests, and flitting about with perfect safety and apparent delight. Hence also their name Petrel, a diminutive of Peter, from the apostle Peter's walking on the water. From the frequency with which flocks of these birds are seen in stormy weather, or as heralds of a storm, they are very unfavourably regarded by sailors. They have very long and pointed wings, passing beyond the point of the tail; and the tail is square in some, slightly forked in others. Their flight much resembles that of a swallow. They are to be seen in the seas of all parts of the world, but are more abundant in the southern than in the northern hemisphere. The names Storm P. and Mother Carey's Chicken are sometimes more particularly appropriated to *Thalassidroma pelagica*, a bird scarcely larger than a lark, and the smallest web-footed bird known, of a sooty black colour, with a little white on the wings and some near the tail. Two or three other species are occasionally found on the British shores; but this is the most common, breeding in crevices of the rocks of the Scilly Isles, St Kilda, the Orkneys, Shetland Isles, &c. Like many others of the family, it generally has a quantity of oil in its stomach, which, when wounded or seized, it discharges by the mouth or nostrils; and of this the people of St Kilda take advantage, by seizing the birds during incubation, when they sit so closely as to allow themselves to be taken with the hand, and collecting the oil in a vessel.

**PETRIFICATION**, a name given to organic remains found in the strata of the earth, because they are generally more or less mineralised or made into stone. The word has fallen very much into disuse, having given place to the terms Fossil (q. v.) and Organic Remains.

**PETROICA**, a genus of birds of the family *Sylviada*, natives of Australia, nearly allied to the Redbreast, and to which its familiar name *Robin* has been given by the colonists. The song, call-note, and manners of *P. multicolor*, a species abundant in all the southern parts of Australia, very much resemble those of the European bird, but its plumage is very different: the male having the



head, throat, and back jet-black, the forehead snowy-white, one longitudinal and two oblique bands of white on the wings, and the breast bright scarlet; the female is brown, with red breast. There are several other species, birds of beautiful plumage.

**PETRO'LEUM.** See **NAPHTHA**. In consequence of the danger attending the storing and keeping of petroleum, an act of parliament was passed in 1861 (25 and 26 Vict. c. 66) to regulate the subject, putting it on a similar footing to gunpowder. A licence is required to keep large quantities, which is obtained in England from the aldermen of the city of London, the metropolitan board, the mayor and aldermen of boroughs, or the harbour commissioners, according to the locality where it is proposed to be kept; and in other places, in England and Scotland, from two justices of the peace. If the licence is refused, the party may appeal to the Home Secretary. Not more than forty gallons must be kept within fifty yards of a dwelling-house or a warehouse for goods, except in pursuance of a licence, under a penalty of £20 per day. One moiety of the penalty is given to the informer. A search-warrant may be obtained from justices, in case it is suspected that the act is violated.

**PETRO'LOGY** (Gr. science of rocks), a term recently introduced into geology to designate particular aspects of the study of rocks, apart from their organic contents. By some, it is confined to an examination of their structure and composition; by others, it is extended to the study of rock-masses, their planes of division, their forms, their position and mutual relations, and other characters not bearing on the question of the geological time of their production.

**PETROMY'ZON.** See **LAMPREY**.

**PETRONEL**, an ancient and clumsy description of pistol.

**PETRO'NIUS, C.**, a Roman voluptuary at the court of Nero, whose profligacy is said to have been of the most superb and elegant description. We know, however, very little about him. He was at one time proconsul of Bithynia, was subsequently appointed consul, and is certified as having performed his official duties with energy and prudence. But his grand ambition was to shine as a court-exquisite. He was a kind of Roman *Brummell*, and Nero thought as highly of him as did the Prince Regent of the famous Beau. He was entrusted by his imperial master and companion with the charge of the royal entertainments, and thus obtained (according to Tacitus) the title of *Arbiter Elegantie*. Nero would not venture to pronounce anything *comme il faut*, until it had received the approval of the oracle of Roman fashion. The influence which he thus acquired was the cause of his ruin. Tigellinus, another favourite of Nero, conceived a hatred of P., brought false accusations against him, and succeeded in getting his whole household arrested. P. saw that his destruction was inevitable, and committed suicide (66 B. C.), but in a languid and graceful style, such, he thought, as became his life. He opened some veins, but every now and then applied bandages to them, and thus stopped the flow of blood, so that he was for a while enabled to gossip gaily with his friends, and even to appear in the streets of Cumæ before he died. We are told that he wrote, sealed, and despatched to Nero, a few hours before his death, a paper containing an account of the tyrant's crimes and flagitious deeds. It has been generally supposed that P. is the author of a well-known work entitled, in the oldest MSS., *Petronii Arbitri Satyricon*, a series of fragments belonging apparently

to a very extensive comic novel or romance (see **NOVELS**), the greater portion of which has perished, but there is really no satisfactory evidence to shew whether or not he was so. It is probable, however, that the work belongs to the 1st c. A. D. The fragments exhibit a horrible picture of the depravity of the times; but there is no indication that the author disapproves of what he describes. The *editio princeps* of the fragments appeared at Venice in 1499; later editions are those of Burmann (Traj. ad Rhen. 1709; 2d edit. Amst. 1743), and of Antonius (Leip. 1781).

**PETROPAVLO'VSK**, a small port of Russian Siberia, near the mouth of the river Avatcha, on the east coast of the peninsula of Kamtchatka. Lat. 53° N., long. 158° 44' E. It has only 691 inhabitants, and has lost much of its former importance since its desertion by the Russians in 1855, and the removal of its garrison to Nikolaevsk.

**PETROZAVODSK**, an important mining-town in the north of European Russia, capital of the government of Olonetz, stands on the western shore of Lake Onega, 300 miles by water north-east of St Petersburg. A cannon-foundry was erected here in 1701 by Peter the Great, who himself had discovered the rich resources of this northern region in iron and copper ores. The town itself dates from the year 1703; and from that to the present time, it has been the great centre of the mining industry of the government. The Alexandrovsky arms-factory is specially deserving of notice. It was founded in 1773, and, besides other arms, it has produced in all 30,000 pieces of cast-iron ordnance. Works are also fitted up for the preparation of steel. Wood abounds in the vicinity, and there is easy communication by water with St Petersburg. Pop. 10,648.

**PETSH**, or **IPEK** (i. e., silk), a town of European Turkey, in Albania, stands on the Bistritza, or White Drin, 65 miles north-east of Scutari. It is a pleasant town; the houses are large and handsome, and, as a rule, have gardens attached, in which fruit and mulberry-trees are cultivated. Water, from the river, is led up into all the houses. Silk is extensively made, tobacco and fruits are largely cultivated, and arms manufactured. P. was formerly the residence of the Servian patriarcha. Pop. 8000.

**PETTY BAG OFFICE**, one of the branches of the Court of Chancery, now regulated by statutes 11 and 12 Vict. c. 48, and 12 and 13 Vict. c. 109. The clerk of the petty bag, an officer appointed by the Master of the Rolls, draws up writs of summons to parliament, *Congès d'élire* for bishops, writs of *Scire facias*, and all original writs. A great deal of miscellaneous business is also transacted in the petty bag office, which the Lord Chancellor and Master of the Rolls are empowered to regulate and transfer from time to time. In the petty bag office may be brought any personal action by or against any officer of the Court of Chancery, in respect of his service or attendance.

**PETTY OFFICERS** in the royal navy are an upper class of seamen, analogous to the non-commissioned officers in the army. They comprise the men responsible for the proper care of the several portions of the ship, the foremen of artificers, the signalmen, and many others. They are divided into three classes: chief petty officers, at 2s. 3d. a day; 1st class working petty officers, at 2s. a day; and 2d class working petty officers, at 1s. 10d. a day. Petty officers are appointed and can be degraded by the captain of the ship. Her efficiency much depends on this useful class of sailors.

**PETTY SESSIONS** is the court constituted by two or more justices of the peace in England, when sitting in the administration of their ordinary jurisdiction. Though for many purposes statutes enable one justice to do acts auxiliary to the hearing and adjudication of a matter, yet the jurisdiction to adjudicate is generally conferred upon the justices in petty sessions, in which case there must be at least two justices present, and this is called a petty sessions, as distinguished from quarter sessions, which generally may entertain an appeal from petty sessions. For the purpose of securing always sufficient justices, the whole of the counties of England are subdivided into what are called petty sessional divisions, those justices who live in the immediate neighbourhood being the members who form the court of such division. This subdivision of counties is confirmed by statute, and the justices at quarter sessions have power from time to time to alter it. Each petty sessions is held in some town or village which gives it a name, and a police-court or place is appropriated for the purpose of the sittings of the court. There is a clerk of each petty sessions, usually a local attorney, who advises the justices, and issues the summons and receives the fees made payable for steps of the process. The justices in petty sessions have a multifarious jurisdiction, which they exercise chiefly by imposing penalties authorised by various acts of parliament, as penalties against poachers, vagrants, absconding workmen and apprentices, &c. They also have jurisdiction to hear charges for all indictable offences, to take depositions of witnesses, and, if they think a case of suspicion is made out, to commit the party for trial at the quarter sessions or assizes, and to bind over the witnesses to attend. See also **JUSTICE OF THE PEACE**.

**PETUNIA**, a genus of plants of the natural order *Solanaceæ*, natives of the warmer parts of America. They are herbaceous plants, very nearly allied to Tobacco, and with a certain similarity to it in the general appearance of the foliage, which has also a slight viscidness, and emits when handled a disagreeable smell, but the flowers are very beautiful, and varieties improved by cultivation are amongst the favourite ornaments of our greenhouses and flower-borders. The petunias, although perennial, are very often treated as annuals, sown on a hot-bed in spring, and planted out in summer, in which way they succeed very well even in Scotland. They are tall plants, with branching weak stems, and may readily be made to cover a trellis. Although, when treated as greenhouse plants, they become half-shrubby, they do not live more than two or three years. The name P. is from the Brazilian *Petun*. The first P. was introduced into Britain in 1825.

**PETUNTZE**, a white earth used by the Chinese in the manufacture of porcelain, and said to consist of comminuted but undecomposed felspar. It is fusible, and is used for glazing porcelain.

**PETWORTH**, or **SUSSEX MARBLE**, is a thin layer of limestone, composed of the shells of fresh-water *Paludina*. It has been long, but not extensively used for ornamental purposes. A polished slab of it was found in a Roman building at Chichester, and pillars formed of it exist in the cathedrals of Chichester and Canterbury.

**PEWS** (anciently *pues*; Old Fr. *puys*; Dutch, *puys*; Lat. *podium*, 'anything on which to lean'; *s'appuyer*), enclosed seats in churches. Church-seats were in use in England some time before the Reformation, as is proved by numerous examples still extant, the carving on some of which is as early as the Decorated Period, i. e., before 1400 A. D.;

and records as old as 1450, speak of such seats by the name of *pues*. They were originally plain fixed benches, all facing east, with partitions of wainscoting about three feet high, and sides of the width of the seat, panelled or carved; the sides sometimes rising above the wainscoting, and ending in finials or poppies, or else ranging with it and finished with a moulding. After the Reformation, probably under the influence of the Puritans, who, objecting to some parts of the service which they were compelled to attend, sought means to conceal their nonconformity, pews grew into large and high enclosures, containing two or four seats, lined with baize, and fitted with doors, desks, and cushions. Pews were early assigned to particular owners, but at first only to the patrons of churches. A canon made at Exeter, in 1287, rebukes quarrelling for a seat in church, and decrees that none shall claim a seat as his own except noblemen and the patrons. Gradually, however, the system of appropriation was extended to other inhabitants of the parish, to the injury of the poor, and the multiplication of disputes.

The law of pews in England is briefly this. All church-seats are at the disposal of the bishop, and may be assigned by him, either (1) directly by faculty to the holders of any property in the parish; or (2) through the churchwardens, whose duty it is, as officers under the bishop, to 'seat the parishioners according to their degree.' In the former case, the right descends with the property, if the faculty can be shewn, or immemorial occupation proved. In the latter, the right can at any time be recalled, and lapses on the party ceasing to be a regular occupant of the seat. It appears that by common law every parishioner has a right to a seat in the church, and the churchwardens are bound to place each one as best they can. The practice of *letting* pews, except under the church-building acts, or special local acts of parliament, and, much more, of *selling* them, has been declared illegal.

In Scotland, pews in the parish churches are assigned by the heritors (q. v.) to the parishioners, who have accordingly the preferable claim on them; but when not so occupied, they are legally open to all. As is well known, pews in dissenting churches are rented as a means of revenue to sustain general charges. In some parts of the United States, pews in churches are a matter of annual competition, and bring large sums. Latterly, in England, there has been some discussion as to the injuriously exclusive character of the 'pew system,' and a disposition has been manifested to abolish pews altogether, and substitute movable seats available by all indiscriminately. Several pamphlets have appeared on the subject. In the Roman Catholic churches on the Continent pews are seldom to be seen.

**PEW'TER**, a common and very useful alloy of the metals, tin and lead. Two other kinds of pewter have a more compound character. Common, or *ley-pewter*, consists of 4 parts of tin and 1 part of lead; *plate-pewter* is made of 100 parts of tin, 8 parts of antimony, 2 parts each of bismuth and copper; another kind, called *trifle*, is composed of 83 parts of tin and 17 parts of antimony. Although these are the standard formulas, each kind is often much varied to suit the purposes of the manufacturer; the chief alteration being the addition of a large proportion of lead to the last, and a large increase of the same metal in the other two.

**PEZÉNAS**, a manufacturing town of France, in the department of Herault, on the left bank of the river of that name, 25 miles west-south-west of Montpellier. It stands in a district remarkable for its beauty, and so well cultivated as to have received

the name of the Garden of Herault. It is famous for its healthy climate and clear sky. The vicinity produces excellent wine, and woollen and linen goods are manufactured. The trade, however, is chiefly in liquors, and P. is known as one of the principal brandy-markets of Europe. Pop. 6609.

PFEFFERS an extraordinary and much-visited locality in the Canton of St Gall, Switzerland, five miles south-east of Sargana. It has been famous since the middle of the 11th c. for its hot baths, situated 2180 feet above sea-level, and 520 feet above the village of Ragatz. The old baths of P. are built on a ledge of rock a few feet above the roaring torrent of the Tamina, and are hemmed in by walls of rock towering above them to the height of 600 feet, and so far burying the baths within the gorge, that even in the height of summer, sunlight appears above them only from ten to four. Above the old baths, the walls of the ravine of the Tamina contract until they meet, covering up the river, which is there seen from a cavernous gap. The hot-springs are reached from the baths by means of a railed platform. This platform, leading to the hot spring, is secured to the rocks, and the Tamina churns its way through the cleft 30 or 40 feet below. The waters of the hot spring are now conveyed to Ragatz (about two miles below P.) by wooden pipes, 12,500 feet long. The waters, as they issue from the spring, have a temperature of 100° Fahr. A pint of the water, which is used both for drinking and bathing, contains only about three grains of saline particles.

PFEIFFER, IDA (*née* REYER), a celebrated female traveller, was born at Vienna, October 15, 1797, and from her earliest years shewed a resolute and fearless, but not unfeminine disposition. In 1820, she married an advocate, named Pfeiffer, from whom she was obliged to obtain a separation, after she had borne him two sons, Oscar and Alfred, whose education devolved on herself. When she had settled them in life, and was free to act as she pleased, she at once proceeded to gratify, at the age of 45, her long-cherished inclination for a life of travel and adventure. Her first expedition was to the Holy Land. She left Vienna in March 1842, and returned in December of the same year, having traversed, alone and without guide, European and Asiatic Turkey, Palestine, and Egypt. She published an account of her eastern rambles in the following year (*Reise einer Wienerin in das Heilige Land*), which, like all her other works, has gone through many editions, and been translated into French and English. In 1845, she visited Northern Europe—Sweden, Norway, Lapland, and Iceland—and recorded her impressions in her *Reise nach dem Skandinavisch, Norden und der Insel Island* (2 vols. 1846). But these journeys, which would have satisfied most women, were but little excursions in the eyes of this insatiable nomade, and only served to whet her appetite for something vaster. She resolved on a voyage round the world; and on the 28th of June 1846, sailed from Hamburg in a Danish brig for Brazil. Her descriptions of the scenery of that country and of the inhabitants—both native Indians and Brazilians—are exceedingly interesting. She then sailed round Cape Horn to Chile, and thence, after some time, across the Pacific to Otaheite, China, and Calcutta; crossed the Indian peninsula to Bombay, whence she took ship for the Persian Gulf, landed at Bassora, traversed a great part of Western Asia, Southern Russia, and Greece, and re-entered Vienna, November 4, 1848. Two years later, she published a narrative of her travels and adventures, entitled *Eine Frauenfahrt um die Welt* (Vienna, 1850, 3 vols.). As a small recognition

of her services, and of the singular energy, fortitude, and perseverance of her character, the Austrian government granted Madame P. a sum of £100. She now determined to go round the world again, but by a different route. Proceeding to England, she, in May 1851, took ship for Sarawak, rounding the Cape of Good Hope, penetrated alone to the heart of Borneo, visited Java and Sumatra, lived for a time with some cannibal tribes, and sailed from the Moluccas to California, thence to Peru, scaled the peaks of Chimborazo and Cotopaxi, made a run through the principal of the United States, and returned to London in 1854. This second voyage, signalised by several scientific observations, is described in *Meine Zweite Weltreise* (Vien. 1856). But the more she travelled, the fiercer became her hunger for movement. In September 1856, she set out on what was to be her last expedition—namely, to Madagascar. After enduring terrible hardships, she got away, and came home to Vienna—to die. Her death took place October 28, 1858.

PFO'RZHEIM, an important manufacturing town of the Grand Duchy of Baden, on the northern border of the Black Forest, stands on the Ens, at its confluence with the Nagold and Wurm, 55 miles south-south-east of Mannheim, and on a recently-constructed branch of the Mannheim and Bale Railway. It consists of the town proper—surrounded with a wall and ditch—and the suburbs; contains the remains of an ancient castle, formerly the residence of the Markgrafs of Baden-Durlach; several churches, one of which, the *Schlosskirche*, on a height, contains a number of monuments, with marble statues of the princes of Baden; a convent for noble ladies; industrial and other schools; chemical and iron-works; machine-shops, tanneries, and cloth and other factories. The principal articles of manufacture are gold and silver wares and trinkets, the chief markets for which are Germany and America. An important trade is carried on in timber, which is cut in the neighbouring forests, and is floated down to Holland by the Neckar and Rhine. Pop. of town and suburbs, about 9000.

PHÆDRUS, a Latin poet, whose works consist of fables. He was probably a Thracian or Macedonian, carried to Rome as a slave in his childhood, and brought up at the court of Augustus, who emancipated him. Under Tiberius, he was exposed to great danger from the hostility of Sejanus, but lived to see that general's overthrow, and died at an advanced age, probably in the reign of Claudius. Five books of fables, after the manner of Æsop, and called *Fabula Æsopica*, have been usually ascribed to him. The faults of the style have led, however, to the suspicion, not merely of alterations at a later date, but of later, and even much later, composition. The dry 'morals' have been supposed to indicate the Middle Ages as the period to which the work should probably be referred; but its authenticity is generally admitted. The first edition was published at Troyes in 1596. The text has subsequently occupied the attention of some of the greatest scholars and critics, from the days of Burmann and Bentley to the present time. A sixth book, containing 32 fables, has recently been discovered and published, of the authenticity of which, however, there are greater doubts than of that of the other books. The best edition is that of J. C. Orelli (Zürich, 1831).

PHÆNO'GAMOUS PLANTS. See PHANEROGAMOUS PLANTS.

PHÆTHON (i.e., the shining), in the writings of Homer and Hesiod, a frequent title of Helios the sun-god, and subsequently employed as his name.—P., in Greek mythology, is also the name of a son of

Heli<sup>os</sup>, famous for his unfortunate attempt to drive his father's chariot. Scarcely had the presumptuous youth seized the reins, when the horses, perceiving his weakness, ran off, and approaching too near the Earth, almost set it on fire. Whereupon the Earth cried to Jupiter for help, and Jupiter struck down P. with a thunderbolt into the Eridanus or Po. His sisters, the Heliades, who had harnessed the horses of the Sun, were changed into poplars, and their tears into amber.

**PHAËTON.** See TROPIC BIRD.

**PHAGEDÆNA** (Gr., from *phagein*, to eat or corrode), designates a variety of ulceration in which there is much infiltration, and at the same time rapid destruction of the affected part. The sore presents an irregular outline, and a yellowish surface; it gives off a profuse bloody or ichorish discharge, and is extremely painful. It usually attacks persons whose constitutions are vitiated by scrofula, by the syphilitic virus, by the abuse of mercury, by intemperance, &c. It not very unfrequently appears in the throat after scarlatina in a severe form. If relief is not afforded by the internal administration of opium (to allay the pain), and of quinia, or some other preparation of bark, wine, beef-tea, &c. to improve the tone of the constitution, together with astringent and sedative local applications, recourse must be had to the destruction of the part by strong nitric acid, or some other caustic.

The terrible disease known in civil practice as SLOGGING PHAGEDÆNA, and in military and naval practice as HOSPITAL GANGRENE, is merely, according to some of our highest surgical authorities, a state of phagedæna in its fullest development. This disorder requires for its development the influence of some of those undefined causes which regulate the outbreak of epidemics, and is peculiarly characterised by its contagious and infectious nature. It is usually engendered by the overcrowding of sick and wounded men, and some idea of its virulence may be formed from the fact that on the return of the French fleet from the Crimean war, no less than 60 deaths from it occurred in one ship in the course of 38 hours. It is not of frequent occurrence in the London Hospitals; but it broke out in the Middlesex Hospital in 1835, in University College Hospital in 1844, and in St Bartholomew's and St George's Hospitals in 1847 (Druitt's *Surgeon's Vade-mecum*, 8th ed., p. 72, note). For details respecting this disorder the reader is referred to Hennen's *Principles of Military Surgery*, Boggie's *Hospital Gangrene*, and the article on 'Gangrene,' by Mr Holmes Cootie in Holmes's *System of Surgery*, vol. I.

**PHALACROCORAX.** See CORMORANT.

**PHALÆNA.** See MOTH.

**PHALANGER** or **PHALANGIST** (*Phalangista*), a genus of marsupial quadrupeds, having a rather short head, short ears, short woolly fur, a long prehensile tail, sometimes completely covered with hair, and sometimes only at the base, and acaly towards the extremity; the dentition somewhat various as to the number of premolars, the incisors always six in the upper jaw and two in the lower, the true molars eight in each jaw, the canines of the lower jaw very small, and close to the incisors. The fore-paws are strong, and capable of much use in grasping food and bringing it to the mouth. A number of species inhabit Australia and the islands to the north of it. They live chiefly in trees, and feed on insects, small animals of various kinds, eggs, and fruits. The SOOTY P. or TAPOA (*P. fuliginosa*) is pretty common in Van Diemen's Land, and is much sought after on account of its fur, which is of a uniform smoky-black colour, or tinged with chestnut, warm and beautiful. The tail

is very bushy. It is nocturnal in its habits.—The VULPINE P. (*P. vulpina*), also called the VULPINE OPOSSUM, is very plentiful and widely diffused in Australia. The length of the animal from the point of the muzzle to the root of the tail is about 26 inches; the tail is about 15 inches long, and is bushy; the colour is grayish-yellow on the upper



Vulpine Phalanger (*P. vulpina*).

parts, and tawny-buff below. The fur is not so much valued as that of the last species, but is used for various purposes. The flesh, although it has a strong peculiar flavour, is a favourite food of the Australian aborigines.—Nearly allied to this genus, is the genus *Cuscus*, of which one species, whitish-gray, spotted with brown, is plentiful in the Molucca and Papuan Islands.—Allied to the phalangers also are the Flying Phalangers (q. v.).

**PHALANGIDÆ**, a family of Trachearian Arachnida, popularly called *Harvest-men*, some of the species appearing in great numbers in fields during the hay and corn harvests. They resemble spiders in their general form, although their organs of respiration are very different. Their legs are extremely long and slender. Most of the species are very agile.

**PHALANSTERIANISM** (from Gr. signifying phalanx and solid), the system of living in communities called phalansteries, as suggested by Fourier, the French socialist. See FOURIERISM.

**PHALANX**, the ancient Greek formation for heavy infantry, which won for itself a reputation of invincibility, may be described as a line of parallel columns, rendered by its depth and solidity capable of penetrating any line of troops. The oldest phalanx was the Lacedæmonian or Spartan, in which the soldiers stood eight deep; the Athenian phalanx had been the same, until, at the battle of Marathon, (490 B.C.) Miltiades reduced the depth to four men in order to increase his front. When Epaminondas organised the Theban army against Sparta, he felt that the Spartan line of battle would be impregnable to troops organised in their own manner. He therefore increased the depth and lessened the front of his phalanx, which enabled him to burst through the Spartan line, inflicting the sanguinary defeat of Leuctra (371 B.C.). Philip of Macedon had learned the art of war under Epaminondas, and when he resolved to make his state a military power, he formed the celebrated Macedonian phalanx (359 B.C.), which enabled him to conquer Greece, and with which his son Alexander subdued the eastern world. The Macedonian phalanx, as the latest form that organisation assumed, and as the shape in which the phalanx encountered the

military skill of the west, is deserving of description. The line was 16 deep: a grand-phalanx comprising 16,384 *hoplites*, or heavy-armed soldiers, subdivided as follows: the grand-phalanx was composed of four phalanxes or divisions, each under a general officer, called a *phalangarch*; his command was divided into two brigades or *merarchies* (sometimes called *telarchies*), each of these comprising two regiments, or *chiliarchies*, of four battalions or *syntagmata* each. A *syntagma* answered accurately to a modern battalion, except that it was smaller. It was a perfect square, with 16 men each way, was commanded by a *syntagmatarch* or *zenagos*; and had an adjutant, with one or two other staff-officers who stood behind. Eight files united were under a *taxiarch*, four under a *tetrarch*, corresponding probably to a modern captain, two files were under a *dilochite* or subaltern. A single file of 16 men was called a *lochos*, and the best man was placed at its head; a picked man, the *ouragos*, also marching in the rear. The arms of all these phalanx-men were pikes or spears, 24 feet long, of which 6 feet were behind and 18 feet held in front of the combatant. As each man occupied with his shield three feet, the phalanx, when it advanced, had six tiers of spear-points in front, a wall of steel which no troops could withstand, especially as the bearers of the spears were pressed on by the ten ranks in their rear. By rapid movements the phalanx could change front, form in close column of *syntagmata*, and execute other critical manœuvres.—The heavy-armed phalanx was ordinarily flanked by *pellastes* or light infantry, similarly formed, but only eight deep, while the cavalry were but four deep. The phalanx, as representative of the heavy formation, came in contact with the lighter legion of Rome during the wars of Pyrrhus in Italy.—At the great battle of Heraclea (279 B.C.), the phalanx won the day; but the victory was attributable to other causes as much as to any superiority of formation.

**PHALARIS**, a tyrant of Agrigentum in Sicily, who flourished about the middle of the 6th c. B.C. According to the prevalent tradition, he was infamous for his cruelty. He maintained his power for 16 years by the aid of foreign hirelings, and, it is said, by putting to death all persons of eminence in his dominions; but at last he fell a victim to popular indignation. He gratified, we are told, his love of cruelty by causing persons to be roasted alive in a brazen bull, which was made for that purpose—the first victim being the maker, Perillus. Cicero calls him the 'most cruel of all tyrants' (*crudelissimus omnium tyrannorum*). But some doubt attaches to this view of his character, partly because many of the crimes laid to his charge are intrinsically improbable, and partly because later traditions represent him as fond of literature and philosophy, and a patron of learned men. Lucian affirms that he was naturally a man of a mild and humane disposition. How far the later view should be allowed to modify the earlier, it is—in the absence of all reliable knowledge—impossible to say. It is under the later aspect that he is shewn to us in the famous but spurious *Epistles of Phalaris*. See BENTLEY.

**PHALAROPE** (*Phalaropus*), a genus of birds of the family *Lobipedidae* (q. v.); having a rather long, slender, weak, straight bill, resembling that of the sandpipers, which, indeed, they otherwise much resemble, although differing in their aquatic habits; the greater part of their time being passed in swimming on the sea, where they seek molluscs and other small marine animals for their food. The GRAY P. (*P. lobatus*), although formerly so rare a bird in Britain that Pennant says he only knew of two instances of its occurrence in his time, is now

not unfrequently seen in its autumn migration from its northern abode to its southern winter-quarters. It breeds in the Arctic regions both of the old and new world, migrating southward in both on the approach of winter. Its entire length is rather more than eight inches. The tail is short. It is a beautiful bird, and remarkable for the great difference of its summer and winter plumage, the prevailing tint in winter being a delicate gray, whilst in summer

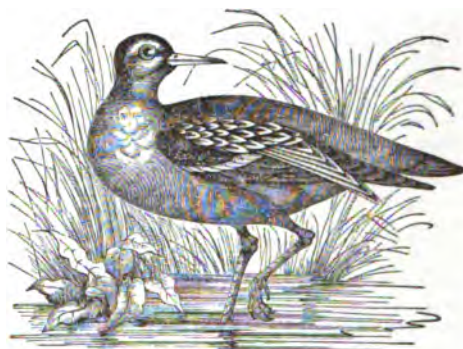

Gray Phalarope (*P. lobatus*).

the upper parts exhibit a fine mixture of black, white, and yellow, and the breast and under parts are reddish chestnut.—The RED-NECKED P. (*P. hyperboreus*, or *Lobipes hyperboreus*, a generic distinction being made by Cuvier and others, on account of the sharper and more slender bill), breeds in some of the northern Scottish islands, although it is more common in more northern regions, and, like the former, is found in all the northern parts of the world. It is rather smaller than the Gray P., and is, like it, very graceful in form and movements, and finely coloured. The phalaropes are very fearless of man, and very easily tamed. Their flesh is oily and unpalatable.

**PHALLUS**, a representation of the male generative organs, used at certain Dionysian festivals in ancient Greece, as a symbol of the powers of procreation. It was an object of common worship throughout the nature-religion of the East, and was called by manifold names, such as *Linga* (q. v.), *Joni*, *Pollear*, &c. Originally, it had no other meaning than the allegorical one of that mysterious union between the male and female, which throughout nature seems to be the sole condition of the continuation of the existence of animated beings; but at a later period, more particularly when ancient Rome had become the hot-bed of all natural and unnatural vices, its worship became an intolerable nuisance, and was put down by the senate on account of the more than usual immorality to which it gave rise. Its origin has given rise to much speculation, but no certainty has been arrived at by investigators. The Phœnicians traced its introduction into their worship to Adonis, the Egyptians to Osiris, the Phrygians to Attys, the Greeks to Dionysus. The common myth concerning it was the story of some god deprived of his powers of generation—an allusion to the sun, which in autumn loses its fructifying influence. The procession in which it was carried about was called *Phallagogia*, or *Periphallia*, and a certain hymn was sung on that occasion, called the *Phalikon Melos*. The bearers of the phallus, which generally consisted of red leather, and was attached to an enormous pole, were the *Phallophoroi*. Phalli were on those occasions worn as ornaments round the neck, or attached to the

body. Aristotle traces the origin of comedy to the ribaldry and the improvised jokes customary on those festivals. Phalli were often attached to statues, and of a prodigious size; sometimes they were even movable. At a procession of Ptolemy Philadelphus, a phallus was carried about made of gold, and 120 yards long. Before the temple of Venus at Hierapolis there stood two phalli, 180 feet high, upon which a priest mounted annually, and remained there in prayer for seven days. The phallus was an attribute of Pan, Priapus, and to a certain extent also of Hermes.

**PHALLUS**, a genus of fungi of the division *Gasteromycetes*, egg-shaped, the outer covering at length bursting to permit the growth of a stem, the receptacle which produces the spores, and which is surmounted by a rudimentary *pileo*. The most common British species, *P. impudicus* or *fetidus*, popularly called *Stinkhorn*, is as large as a hen's egg, growing underground in thickets, and finally sending up a stem 4—6 inches high, the fetid smell of which is felt for many yards around. The egg is full of a jelly-like substance. The growth of the stem is very rapid, and it soon decays.

**PHANEROGAMOUS** (Gr. *phaneros*, manifest; *gamé*, marriage) **PLANTS**, or **PHÆNOGAMOUS** (Gr. *phaino*, to shew) **PLANTS**, are those plants which have true flowers, and in which the sexual organs (stamens and pistils) are distinctly notable. They are also called **FLOWERING PLANTS**, being by all these names contradistinguished to Cryptogamous Plants (q. v.). The seeds of P. P. originate from Ovules (q. v.), and already contain the young plant, more or less perfectly formed, which is called the *embryo*. P. P. are about three-fourths of all known plants. Among them are included all the larger plants, and all plants of great importance in an economic point of view. They are generally divided into *Monocotyledonous* or *Endogenous Plants*, and *Dicotyledonous* or *Exogenous Plants*.

**PHARAOH**. The name given by the Hebrews to the monarch ruling in Egypt at the time, in the same manner as Cæsar was applied to the Roman emperors, and as Khan is to the Tartar and Shah to the Persian rulers. The word is of uncertain etymology, being capable of two derivations—viz., either *Pa ra*, 'the Sun,' which is the leading or first title of all Egyptian monarchs, or the popular expression, *Pi ouro*, or *Phouro*, 'the King.' It is even possible to derive it from *Pa har*, 'the Horus,' another title of Egyptian monarchs. The greatest difficulties have been encountered in attempting to determine the particular monarchs who pass under this name in the Scriptures. The first-mentioned P. is the one in whose reign Abraham visited Egypt, who is supposed by some chronologists to have been one of the Shepherd Monarchs, but nothing can be offered beyond mere conjecture in support of this theory. Another P. is the one in whose reign Joseph was brought to Egypt, and who was supposed by Eusebius to be Apophis, one of the later Shepherd Kings of the seventeenth dynasty, who are known from the monuments to have immediately preceded the eighteenth. Bunsen indeed places the arrival of Joseph in the reign of Usertesen, or, as he reads his name, Sesertesen I. of the 12th dynasty, in which indeed a famine is stated in the hieroglyphical texts to have happened, and in which it appears numerous officers were established to take charge of the grain. Arguments, however, may be adduced for Joseph having arrived in the time of the 12th dynasty, from the fact of the establishment of the family of Jacob in the land of Goshen, the importance to which Joseph had risen, and the omission of the name of any of the

principal Egyptian cities in the narrative, and the fact of Joseph having married Asenath, the daughter of Potipherah, priest of Heliopolis, a city evidently the seat of the court under the 12th dynasty, as Ouar or Avaris was under the Shepherds. Equal difficulty is experienced in determining the P. who reduced the Israelites to bondage, employed them in the labours of the brick-field, and compelled them to build the treasure-cities of Pithom and Rameses. He appears to have meditated the total absorption of the Hebrews into the Egyptian race. All that is clear from the narrative is that the city of Rameses was called after his name, in the same manner as modern forts have been by contemporary rulers. Now frequent mention occurs in the Papyri and other texts of the *Makatalu en Ramesu*, or Tower of Rameses II., which is represented on the walls of Medinat-Abu; and this has induced Lepsius and Bunsen to depress the date of the Exodus from 1491 B. C. to the close of the nineteenth dynasty, or after Rameses II., a point controverted by other chronologists, who wish to elevate it to the middle of the 18th dynasty, or 1732 B. C. To synchronise the former date, Lepsius takes the rabbinical date of 1314 B. C. for the Exodus, or 1340 B. C. for the birth of Moses. The P. of the Exodus is supposed to be Merientah or Menephtes, the son and successor of Rameses II. Philologically, this explanation is preferable, as the fixed point in the inquiry is the name of the Migdol of Rameses found both in the Scriptures and on the monuments of Egypt. Other Pharaohs are mentioned; as the father of Tahpena, wife of Hadad and mother of Genuboth; the P. whose daughter Solomon married; P. Nechao, or Necho II., who gave battle to Josiah, king of Judah, whom he slew at Megiddo, and who made war against the Syrians, defeated them at Magdulus, and took Cadytus or *Kateh*, on the *Arunata* or *Orontes*. He was subsequently defeated by Nebuchadnezzar at Carchemish, 607 B. C. P. Hophra, was the Uaphris or Apries of the Greeks whose destruction was prophesied by Jeremiah, and who was strangled 570 B. C.—Bunsen, *Ægyptens Stelle*, iii. p. 109; Lepsius, *Einleit.*, p. 317; Nash, *The Pharaoh of the Exodus* (8vo, Lond. 1862).

**PHARISEES** (*Perishin* or *Perushim*, Separatists), a so-called 'Jewish sect,' more correctly, however, a certain Jewish school, which probably dates as a distinct body or party from the time of the Syrian troubles, and whose chief tendency it was to resist all foreign, chiefly Greek, influences that threatened to undermine the sacred religion of their fathers. They most emphatically took their stand upon the Law, together with those inferences drawn from its written letter which had, partly from time immemorial, been current as a sacred tradition among the people. Out of the small band of the Chasidim (q. v.), the P. had taken their rise originally as *Chaberim*, Friends, Colleagues, Scholars—in contradistinction to the *Am-Haarez*, or common people—and their chief object in life was the Divine Law, its study and further development. Principally distinguished by their most scrupulous observance of certain ordinances relating to things clean and unclean, they further adopted among themselves various degrees of purity, the highest of which, however, was scarcely ever reached by any member of their community. For every degree, a special course of instruction, a solemn initiation, and a novitiate was necessary; all of which, together with a certain distinction in dress, seems to have been imitated from them by the Essenes (q. v.). The name of P. or Perushim was probably at first bestowed upon them in derision by the Sadducees or Zadokites, the priestly aristocracy and their party, the Patricians, who differed from them politically,

## PHARISEES.

and to some extent also in religious matters. The P. had no special 'Confession of Faith,' or articles of creed different from the whole body of Jews. The Bible, as interpreted by the traditional Law, was their only code. Obedience to this Law, strictest observance of all religious and moral duties, submission to the Divine will, full confidence in the wisdom and justice of Providence, firm belief in future reward and punishment, chastity, meekness, and forbearance—these were the doctrines inculcated in their schools. They were, in fact, nothing more or less than the educated part of the people, who saw in the rigid adherence to the ancient religion, such as it had developed itself in the course of centuries, the only means of saving and preserving the commonwealth, notwithstanding all its internal and external troubles. Hence, they wished the public affairs, the state and all its political doings, to be directed and measured by the standard of this same Divine Law; without any regard for those aristocratic families who ruled, or at all events greatly influenced the commonwealth. These consisted of the priestly families, the Zadokites (Sadducees, q. v.), and of the valiant heroes and sagacious statesmen, who had brought the Syrian wars to a successful issue, and had, by prudent negotiations with other courts, restored the nation to its former greatness, and, on their own part, had acquired wealth and fame, and freer and wider views of life and religion. The latter held the modern doctrine, that religion and state were two totally different things; that God had given man the power of taking his matters into his own hands; and that it was foolish to wait for a supernatural interference, where energy and will were all that was required. Naturally enough, the political difference between the two parties by degrees grew into a religious one, since the Jewish State was one still completely pervaded by the religious element—as indeed it had begun as a theocracy, and could still, to a certain extent, be called by that name. And the more the Sadducees lost their influence—the people siding with the P.—the more the religious gulf must have widened between them; although the divergence between them, as far as our authorities—Josephus, the New Testament, and the Talmud—go, does not seem to have been of a very grave nature. Thus, the P. assumed the dogma of immortality, chiefly with a view to a future reward of good and evil deeds in this world; while the Sadducees, without rejecting—as we are erroneously informed by Josephus—this dogma in the least, yet held that there was nothing in the Scripture to warrant it, and, above all, that there was no need of any future reward; at any rate, that a pious life with a view to this was not meritorious. While the P. held all the traditional ordinances in equal reverence with the Mosaic ones, tracing, in fact, most of the former to Sinai itself, the Sadducees rejected, or rather varied some of these according to the traditions of their own families: these ordinances chiefly relating to priestly and sacrificial observances, certain laws of purity, and some parts of the civil law. It may perhaps even be assumed, with the most recent investigators (chiefly Geiger), that the P. were the representatives of a newer Halacha, dictated by an oppositional and religious and national zeal which carried them far beyond the original boundaries. Certain other legal differences between the two parties, such as the application of the laws of inheritance to daughters, or of the responsibility of the master for his servants, are nothing more than political party-views in a religious mask, which were meant to meet certain special isolated cases only. In general, the P. handled justice in a

much milder manner than their antagonists, who took their stand upon the rigid letter, and would hear of no mercy where a violation of the code was clearly made out. Out of the midst of the P. rose the great doctors and masters of the Law (*Soferim*, Scribes, *Nomodivulskaloi*, teachers of the Law), and to them were intrusted by the later rulers the most important offices.

Until recently, the greatest misconception has prevailed even among scholars respecting this self-sacrificing, patriotic, pious, learned, and national party of progress. That there were among them those who were a disgrace to any party, and, still more, to their strict one, no one knew better than the P. themselves, and in bitterer words than were ever used by Christ and the apostles, the Talmud castigates certain hyperpious members of their own community as the 'plague of Pharisaism.' These hypocrites were characteristically styled *Zebubim* [dyed, painted ones], 'who do evil deeds like Zimri, and require a godly reward like Phinehas.' Seven kinds of P. are enumerated in the Talmud, six of whom were not to be counted as real Pharisees—viz. (1) they who did the will of God for earthly motives; (2) those who made very small steps, or said: Wait for me—I have still some good deed to do; (3) those who knocked their heads against walls, lest they might look at a woman; (4) *ex officio* Saints; (5) those who say: tell me of another duty; (6) those who are pious, because they fear God. The only genuine Pharisee was he 'who did the will of his Father in Heaven, because he loved Him.' Josephus's accounts, distortions in themselves, have, to add to the confusion, been misunderstood (thus, for example, the word which he uses to designate the three parties, never meant 'sect,' as it has invariably been interpreted); and the position of Christ, in relation to the P., can never be understood properly without a full acquaintance with the circumstances of the time, to which there is no other way than a knowledge of that literature (the Talmud and Midrash) which has so long been neglected. Christ found the influence of the P. predominant among the people, although the Sadducees (and the Boethusians) were in reality the ruling classes and allies of the reigning dynasty. He naturally sided with the democratic party of the P. against that of the proud opposite camp. As for the religious tendencies of the latter, the Sadducees (q. v.)—the people had decided that point already practically, by siding with the Pharisees. Once only an allusion is made also to the leaven of Herod = the Sadducees (Mark viii. 15, cf. Matt. xvi. 6). But it was, above all things, necessary to combat the ever-growing tendency to choke up, as it were, all real piety and genuine virtue of heart under external ceremonies and observances, which, unless guarded against, will appear, instead of a mere symbol and memento, the essence of religion itself, and thus become in time a delusion and bondage, and end in that vile hypocrisy, against which the Talmud fights with all its powers of derision, and Christ inveighs in much more vehement terms than is his wont. It was not in themselves that these 'oral laws' were held up to scorn. They were a necessary and natural growth, and acted, in the main, beneficially; as is now fully recognised by scholars of eminence. (For some further remarks on the subject, see TALMUD.)

Pharisaism—from which gradually branched off the wild democratical party of *Zealots* (Kannaim), and which for the last time represented political opinions in the revolution of Bar Cochba—has, from the downfall of the sanctuary, and the final destruction of the commonwealth to this day, remained the

principal representative of Judaism as a creed only, Sadduceism dying out, or, at all events, producing only one such sterile plant as Karaism. See JEWISH SECTS, SADDUCEES.

**PHARMACOPŒIA.** This term has been applied to various works, consisting for the most part of (1) a list of the articles of the *Materia Medica*, whether simple or compound, with their characters, and the tests for the determination of their purity; and (2) a collection of approved receipts or prescriptions, together with the processes for articles in the *Materia Medica*, obtained by chemical operations. Almost every civilised country of importance has its national pharmacopœia, amongst which those of the United States, France, and Prussia deserve specially honourable notice. The first pharmacopœia published under authority appears to have been that of Nuremberg in the year 1542. A student named Valerius Cordus, who was staying for a short time at Nuremberg, shewed a collection of medical receipts, which he had selected from the works of the most eminent writers, to the physicians of that city, who were so struck with its value that they urged him to print it for the benefit of the apothecaries, and obtained for his work the sanction of the senatus. Before this time, the books chiefly in use amongst apothecaries were the treatises: *On Simples* by Avicenna and Serapion; the *Liber Servitoris* of Balchasim ben Aberazerim; the *Antidotarium* of Johannes Damascenus or Mezue, arranged in classes; and the *Antidotarium* of Nicolaus de Salerno, which was arranged alphabetically. This work was commonly called *Nicolaus Magnus*, to distinguish it from an abridgment known as *Nicolaus Parvus*.

Confining our remarks to the British Pharmacopœias, we may notice that the first edition of the London Pharmacopœia (or, more correctly speaking, of the Pharmacopœia of the London College of Physicians) appeared in 1618, and was chiefly founded on the works of Mezue and Nicolaus de Salerno. Successive editions appeared in 1627, 1635, 1650, 1697, 1721, 1746, 1787, 1809, 1824, 1836, and 1851; and form an important contribution to the history of the progress of pharmacy and therapeutics during the last two centuries and a half. The nature and the number of the ingredients that entered into the composition of many of the pharmaceutical preparations of the 17th and 18th centuries, would equally astonish most of the practitioners and patients of the present day. In the earlier editions we find enumerated earth-worms, snails, wood-lice, frogs, toads, puppy dogs, foxes ('a fat fox of middle age, if you can get such a one'), the skull of a man who had been hanged, the blood of the cat, the urine and excrements of various animals, &c.; and electuaries were ordered, containing 50, 62, and in one instance—Mathiolus, his Great Antidote against Poison and Pestilence—124 different ingredients.

The Edinburgh Pharmacopœia is more modern than the London, the first edition having appeared in 1699; while the Dublin Pharmacopœia does not date further back than 1807. The latest editions of these works appeared in the years 1841 and 1850 respectively.

Until the Medical Act passed in 1858, the right of publishing the pharmacopœias for England, Scotland, and Ireland was vested in the Colleges of Physicians of London, Edinburgh, and Dublin respectively; and as these three pharmacopœias contained many important preparations, similar in name but totally different in strength (as, for example, dilute hydrocyanic acid, solution of hydrochlorate of morphia, &c.), dangerous complications arose from a London prescription being made

up in Edinburgh or Dublin, or *vice versa*. By that act it is ordained that 'the General [Medical] Council shall cause to be published, under their direction, a book containing a list of medicines and compounds, and the manner of preparing them, together with the true weights and measures by which they are to be prepared and mixed; and containing such other matter and things relating thereto as the General Council shall think fit, to be called *British Pharmacopœia*, which shall for all purposes be deemed to be substituted throughout *Great Britain and Ireland*, for the several above-mentioned pharmacopœias.' We regret to add, that the *British Pharmacopœia*, which appeared in the beginning of the present year (1864), has given rise to such a general feeling of disappointment throughout the whole ranks of the profession (including even the chemists and druggists), that at a meeting of the General Council (May 1864) it was resolved that a new and amended edition shall be brought out with the least possible delay. For further information on this subject, the reader is referred to 'Critical and Explanatory Comments on the New Pharmacopœia,' published in the *Lancet*.

**PHARMACY** (from the Gr. *pharmakon*, a medicine) is that department of *Materia Medica* (q. v.) which treats of the collection, preparation, preservation, and dispensing of medicines. It is synonymous with *Pharmaceutical Chemistry*.

**PHAROS.** See LIGHT-HOUSE.

**PHARSA'LUS**, now FERSALA, anciently a town of Thessaly, to the south of Larissa, on the river Enipeus, a branch of the Peneus (now the Salambrina), and historically notable mainly for the great battle fought here between Cæsar and Pompey, August 9, 48 B. C. Pompey had about 45,000 legionaries, 7000 cavalry, and a great number of light-armed auxiliaries. Cæsar had 22,000 legionaries and 1000 German and Gallic cavalry. The battle-cry of Cæsar's army was '*Venus victrix*,' that of Pompey's, '*Hercules invictus*.' Cæsar's right wing began the battle by an attack on the left wing of Pompey, which was speedily routed. Pompey fled into the camp, and his army broke up; Cæsar's troops stormed his camp about mid-day, and he himself, awaking as from stupefaction, fled to Larissa, whither Cæsar followed him next day. Cæsar, according to his own account, lost only 30 centurions and 200 soldiers; other accounts make his loss 1200. On Pompey's side about 6000 legionaries fell in battle, and more than 24,000, who had fled, were taken, whom Cæsar pardoned, and distributed among his troops.

**PHARYNGOBRA'NCHII**, a sub-order of Dermopterous (q. v.) fishes, characterised by respiratory processes projecting from above the pharynx into the large cavity of the mouth. The P. have no heart, and are the lowest in organisation of all fishes. The species are very few. See LANCELET.

**PHARYNGOGNATHI**, an order of fishes, in the system of Müller and Owen; partly *Acanthopterous* and partly *Malacopterous* in the system of Cuvier; some of them also *Cycloid*, and some *Ctenoid*. Their common characteristic is the union of the lower pharyngeals into one bone.

**PHARYNX** (Gr.) is the name of that part of the alimentary canal which lies behind the nose, mouth, and larynx. It is a musculo-membranous sac, situated upon the cervical portion of the vertebral column, and extending from the base of the skull to the level of the fifth cervical vertebra, where it becomes continuous with the Oesophagus (q. v.). Its length is about four inches and a half, it is broader in its transverse than in its antero-



## PHASCOGALÉ—PHASES.

posterior diameter, and its narrowest point is at its termination in the œsophagus. Seven *foramina* or openings communicate with it—viz., the two



**Fig. 1.**—The Pharynx laid open from behind : 1, a section of the base of the skull; 2, 2, the walls of the pharynx drawn to either side; 3, 3, the posterior nares, separated by the vomer; 4, 4, the extremities of the Eustachian tubes; 5, the soft palate; 6, 6, 7, 7, its posterior and anterior pillars; 8, the root of the tongue; 9, the epiglottis overhanging; 10, the opening of the larynx; 11, the posterior part of the larynx; 12, the opening into the œsophagus, whose external surface is seen at 13; 14, the trachea.—(From Wilson.)

*posterior nares* or nostrils, at the upper and front part of the P.; the two *Eustachian tubes*, opening on the outer surface of the preceding orifices; the *mouth*; the *larynx*; and the *œsophagus*.

The P. is composed of an external *muscular coat*;

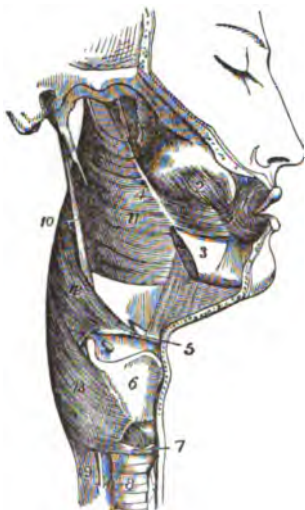

**Fig. 2.**—External View of the Muscles of Pharynx : 1, the orbicularis oris muscle; 2, the Buccinator muscle; 3, portion of lower jaw, part of which is cut away; 4, pyriform-mazillary ligament; 5, the hyoid bone; 6, the thyroid cartilage; 7, the bicoid cartilage; 8, the trachea; 9, the œsophagus, with the recurrent laryngeal nerve lying between it and the trachea; 10, the stylo-pharyngeal muscle; 11, 12, 13, the superior, middle, and inferior constrictor muscles.

a middle *fibrous coat* called the *pharyngeal apo-neurosis*, thick above where the muscular coat is absent, and gradually thinning as it descends;

and a *mucous coat*, continuous with the mucous membrane of the mouth and nostrils. The muscular coat requires special notice. It is composed of a *superior, middle, and inferior constrictor* muscle on either side, together with two less important muscles, termed the *stylo-pharyngeal* and *palato-pharyngeal* muscles. When the food, after being sufficiently masticated and mixed with saliva, is thrown, by the action of the tongue, into the P., the latter is drawn upwards and dilated in different directions; the elevator muscles (the stylo-pharyngeal and palato-pharyngeal) then relax, and the P. descends; and as soon as the morsel is fairly within the sphere of action of the constrictor muscles, they successively contract upon it, and gradually pass it onwards to the œsophagus. Independently of its importance in the act of swallowing, the P. exerts an influence on the modulation of the voice, especially in the production of the higher notes.

The P. is not so frequent a seat of disease as many other parts of the intestinal tube. In cases of Diphtheria (q. v.) it is usually the chief seat of the disease. It is liable to ordinary inflammation or *pharyngitis*—an affection characterised by pain, especially in swallowing, without redness in the fauces or change of voice. Little in the way of treatment, except low diet and attention to the bowels, is required; and the inflammation usually terminates in resolution. Sometimes, however, it proceeds to suppuration, and abscesses—dangerous partly from inanition consequent on inability to take food, but chiefly from suffocation due to pressure on the larynx—are formed. These abscesses are more dangerous in the lower than in the upper part of the P., and are more common in young children than in adults. The treatment consists in opening the abscess, which gives immediate relief; but the operation must be conducted with great care, and the incision made as nearly as possible to the mesial line, in consequence of the large adjacent blood-vessels.

**PHASCO'GALÉ**, a genus of marsupial quadrupeds, of which one species, *P. penicillata*, about the size of a rat, gray, with long soft hair, and a long tufted tail, is common in most parts of Australia, lives chiefly in the hollows of decayed trees, and preys on small animals of every kind. It is much disliked by the colonists, to whom it is known as the *Tapoa Tafa*, on account of its depredations in poultry-yards and larders. It is very agile and audacious.

**PHASE'OLUS.** See KIDNEY-BEAN.

**PHASES** (Gr. *phasis*, appearance), the different luminous appearances presented by the moon and several of the planets, sometimes the whole, a part, or none, of the luminous surface being seen from the earth. The various phases of the moon, and the reasons of them, are mentioned under the article Moon. Mercury and Venus, being inferior planets, present to an observer on the earth exactly similar phases to those of the moon; but the former require, instead of a month, periods of 116 and 584 days respectively to pass through a complete series of phases. The superior planets, to a certain extent, exhibit phases, but the luminous surface, as seen from the earth, only varies from the full illumination seen when they are in conjunction with the earth to a slightly gibbous appearance when they attain their greatest elongation; and their distance from the sun is so great in comparison with that of the earth, as to render the variation in the form of their luminous surface not observable, except in the case of Mars and occasionally of Jupiter. Galileo was the first to observe the phases of Venus, and he considered them as one of the most satisfactory proofs

## PHASIANIDÆ—PHEASANT.

of the truth of the Copernican system. The great brilliancy of Mercury, and its nearness to the sun, prevented its phases from being so easily noticed, but they were at last observed by Masius, and since by many other astronomers. The term phases is frequently applied to designate the successive stages of an eclipse, lunar or solar.

**PHASIA'NIDÆ**, a family of gallinaceous birds, including pheasants, argus, Macartney cock, fowls, impeyans, tragopans, &c.; its limits, however, being extended by some ornithologists to include peacocks and turkeys (*Pavonidæ*), which differ from it by no very considerable character. The hind-toe is placed higher on the tarsus than the front toes, so that only the tip touches the ground. The wings are short.

**PHA'SIS**, a river in Colchis, now called the RION. It rises in the mountains of Caucasus, flows in a generally western direction, and enters the Euxine near the ancient city of Phasis.

**PHA'SMIDÆ** (Gr. *phasma*, a spectre), a family of orthopterous insects, allied to *Mantidæ*, but differing in having the fore-legs similar to the other legs, and used like them for locomotion, not for combat and prehension, in the want of stemmatic eyes, and in the similarity of the first joint of the thorax to the other joints. They are insects of very extraordinary appearance, inhabiting tropical countries, and spending their lives upon trees and shrubs, the tender shoots of which they devour. Some of them resemble green leaves; some resemble brown and withered leaves; whilst others, wingless, or nearly so, and with much elongated bodies—one species nine inches in length—resemble dried twigs. To these peculiarities they owe their safety from enemies, eluding observation, for their motions are sluggish. Some are known as Leaf Insects, Spectre Insects, Walking-sticks, &c. The larvæ of the P. much resemble the perfect insect.

**PHEA'SANT** (*Phasianus*), a genus of gallinaceous birds of the family *Phasianidæ*; having a rather short strong bill, a little curved; the cheeks and skin surrounding the eyes destitute of feathers, and warty; the wings short; the tail long, its feathers so placed as to slope down, roof-like, on either side, the middle feathers longest; the tarsus of the male furnished with a spur. The males of all the species are birds of splendid plumage; the females have shorter tails and dull or sombre colours. There are numerous species, natives of the warm and temperate parts of Asia. The Common P. (*P. Colchicus*) is said to have been brought from the banks of the Phasis, in Colchis, to the south of Europe, at a very remote period, its introduction being ascribed in classic legend to the Argonauts. From the Phasis it derived its Greek name *Phasianos*, the origin of its name in English and other modern languages. It was soon naturalised in Europe, and is now diffused over almost all the temperate parts of it. The date of its introduction into Britain is not known, but was certainly before the end of the 13th c.: it has long been plentiful in plantations and game-preserves, and has been introduced into almost every part of the country suitable to its habits. The abundance of pheasants in Britain, however, is to be ascribed chiefly to careful game-preservation, without which the race would in all probability soon be extirpated. No kind of game falls so easy a prey to the poacher.

A minute description of the Common P. is unnecessary. The head and neck of the male are steel-blue, reflecting brown, green, and purple in different lights; the back and wings exhibit a fine mixture of orange-red, black, brown, and light yellow; the breast and belly are golden-red, each feather

marginated with black, and reflecting tints of gold and purple. The whole length of a male P. is about three feet, of which the tail often measures two feet. The entire length of the female is about two feet. The general colour of the female is pale yellowish-brown, varied with darker brown, the sides of the neck tinged with red and green. The ordinary weight of a P. is about two pounds and a half; but when pheasants are abundantly supplied with food, and kept undisturbed, they are sometimes four pounds or four pounds and a half in weight.

The nest of the P. is on the ground, and is a rude heap of leaves and grasses, in which eleven or twelve olive-brown eggs are laid. But in the half-domesticated state in which it exists in many English preserves, the P. does not pay that attention to its eggs and young which it does when more wild, and not unfrequently continues to lay eggs for a considerable time, like the domestic fowl; the eggs being removed by the gamekeeper, and hatched by hens, along with eggs from nests found among clover and hay in the season of mowing. Very young pheasants must be carefully supplied with ants' eggs, maggots, &c., and the whole difficulty of rearing them is in their earliest stage. Pheasants feed very indiscriminately on berries, seeds, roots, young shoots of plants, worms, insects, &c. Beans, pease, corn, and buckwheat are not unfrequently sown for them in open places in woods; and they scrape up bulbous and tuberous roots in winter. They roost in trees at no great height from the ground, and poachers sometimes capture them by burning sulphur below them. During the moulting season, they do not ascend trees to roost, but spend the night on the ground, when they fall a ready prey to foxes. They are fond of woods with a thick undergrowth, in which, when disturbed, they naturally seek shelter, running whilst it is possible, rather than taking flight. The male P. takes flight much more readily than the female, which, apparently trusting to her brown colour to escape observation, often remains still until the sportsman is almost upon her. The males and females do not associate together except during the breeding season, but small numbers of one sex are often found in company. The 'short crow' of the males begins to be heard in March. In England and Scotland pheasant-shooting legally begins on the 1st of October, and ends on the 3d of February. The pheasants turned out from the gamekeeper's breeding-yard into a preserve, are in general supplied with abundance of food during winter, and come to the accustomed call as readily as any kind of poultry, so that the sportsmanship of a *battue*, in which they are killed by scores or hundreds, is of the lowest kind. It is scarcely necessary to mention that the flesh of the P. is in very high esteem for the table.

The female P., in old age, or when from any cause incapable of the functions of reproduction, sometimes assumes the plumage of the male. The P. exhibits a remarkable readiness to hybridise with other gallinaceous birds. A hybrid between it and the common fowl is not unfrequent, and is called a *Pero*. Hybrids between the P. and Black Grouse have also occurred; and hybrids are supposed to have been produced between the P. and Guinea-fowl, and the P. and turkey. None of these hybrids, however, have ever been known to be fertile, except with one of the original species. On the contrary, the offspring of the Common P. and the RING-NECKED P. (*P. torquatus*) is perfectly fertile, a circumstance which is urged in argument by those who regard them as mere varieties of one species. The Ring-necked P. is now almost as plentiful in Britain as the Common P.: it is a native

## PHEASANT-SHELL—PHENYL.

of the forests of India and China, and is said not to breed with the Common P. in a truly wild state, but in Britain they readily intermix. It is distinguished by a white ring almost surrounding the neck, and is of smaller size than the Common P., somewhat different in markings, and has a shorter tail.—The BOHEMIAN P. is another variety of a silvery-gray colour.—White pheasants are of not very unfrequent occurrence.—Of other species of P. may be mentioned DIARD'S P. (*P. versicolor*), a native of Java, in which the prevailing colour is green; and REEVES'S P. (*P. Reevesii*), a native of the north of China, in which white is the prevailing colour, and the tail is of extraordinary length, so that a bird not larger than the Common P. measures eight feet in entire length. Of somewhat different type, and more nearly approaching to the common fowl, are the GOLDEN P. (*P. pictus*, or *Thaumalia picta*) and the SILVER P. (*P. or Gallophasias nyctemerus*), both natives of China, and both hardy birds, the introduction of which into British preserves has been attempted with good prospect of success. Both have long been kept in a state of domestication by the Chinese. The Golden P. is one of the most splendid of the tribe. It has a fine crest, and a ruff of orange and black, capable of being erected at pleasure. The tail is very long. The crest and ruff are held in great estimation by anglers for making artificial flies.—LADY AMHERST'S P. (*P. or Thaumalia Amherstii*) is a native of China, resembling the Golden P., and with an extremely long tail.—The Silver P. is one of the largest and most powerful of the tribe, and very combative, driving the Common P. from preserves into which it is introduced. The prevailing colour of the upper parts and tail of the male is white, finely pencilled with black, the breast and belly purplish-black.—The name P. is sometimes extended to gallinaceous birds of allied genera.

**PHEASANT-SHELL** (*Phasianella*), a genus of gasteropodous molluscs of the family *Turbinidae*, of which the shells are much valued for their beauty, and when they were rare in collections, were sometimes sold for extraordinary prices. They are now comparatively cheap and plentiful, being found in great numbers on some parts of the Australian coast.

**PHEIDIAS** (Lat. *Phidias*), son of Charmides, the greatest sculptor of ancient Greece, born at Athens probably between 500—490 B.C. His first instructor in art was Hegias of Athens; he afterwards studied under a more famous master, Ageladas of Argos. He appears to have first acquired distinction in his profession soon after the battle of Salamis, and indeed his great works were all executed during a period most favourable for the development and encouragement of genius, when Greece was triumphant over external enemies, and her people enjoyed a more perfect liberty than almost at any other period of their history. With the character of the age correspond the works of its poets, particularly of the tragedians Æschylus, Sophocles, and Euripides, and of its sculptors, particularly of Pheidias. Under Cimon's administration the Athenians began the work of restoring their city, which the Persians had destroyed, in more than its former magnificence, and to fill it with noble works of art. P. was accordingly employed in making the colossal brazen statue of Minerva, *Athena Promachos*, which was placed upon the citadel, and was executed probably about 460 B.C. To the government of Cimon succeeded that of Pericles, still more brilliant, and signalised by an extraordinary development of art. Pericles not only gave to P. a commission to execute all the

more splendid statues that were to be erected, but made him general superintendent of all works of art going on in the city. Plutarch tells us that P. had under him architects, staturaries, workers in copper and bronze, stone-cutters, gold and ivory beaters, &c. To P., as director-general of all the skilled artists and artificers of Athens, we owe, among other glorious edifices, the Propylæa and the Parthenon, the sculptured ornaments of which were executed under his direct superintendence, while the statue of the goddess Athena, the materials for which were ivory and gold, was the work of P. himself (circa 438 B.C.). This statue was clothed with a golden robe, which alone was worth 44 talents of gold. The statue is gone for ever, and the Parthenon is now only a magnificent wreck, but we still possess some splendid evidence of the genius of P., in the sculptures of the metopes, and friezes of the temple of Athena. See ELGIN MARBLES. Next year P. went to Elis, where he executed a colossal statue of Zeus for the Olympeum at Olympia (q. v.), also of ivory and gold (about 433 B.C.). This was reckoned his masterpiece. On his return to Athens, political passions were running high. There was a strong—at least a violent—party inimical to Pericles, but as they did not dare to attack the great statesman, they assailed him through his friends P., Anaxagoras, Aspasia, &c. P. was accused of having appropriated to himself some portion of the gold destined for the robe of Athena. This accusation he repelled by taking off the robe and weighing it. He was then accused of impiety, for having introduced his own likeness and that of Pericles on the shield of the goddess. On this most frivolous and contemptible pretext he was thrown into prison, and died there, but whether of sickness or poison is uncertain. His death took place about 432 B.C. The works executed by, or ascribed to P., were numerous, but we have mentioned the most celebrated. Their prevailing characteristic appears to have been an ideal sublimity, and even the imperfect relics that we possess are the most noble specimens of sculpture in the world.

**PHENOMENON** (Gr. appearance), the name given in philosophy to an object or fact as it is perceived by us, as distinguished from what it is in itself. In the philosophy of Kant, that, whatever it may be, which is behind the phenomenon, and causes it, is called the *noumenon*, as being merely assumed or thought of in the mind. See METAPHYSICS, PERCEPTION.

**PHENYL**, AND THE PHENYLIC GROUP. Phenyl ( $C_6H_5$ ) is an organic radical, which has not yet been isolated. Its most important compounds are: (1.) Carbolic or Phenic Acid ( $HO, C_6H_4, O$ ), known also as Phenol, Hydrated Oxide of Phenyl, and Phenyl-Alcohol. See CARBOLIC ACID. (2.) Hydride of Phenyl ( $C_6H_5$ ), known also as Benzole, Benzine, and Phenene. See BENZOLE. (3.) Phenylamine or Phenylia ( $C_6H_5, H, N$ , or  $C_6H_4, N$ ), better known under the name of Aniline, one of the most important of the artificially formed bases.

Aniline derives its name from *anil*, an obsolete name for indigo, which is one of the sources from which it is most readily procured. It exists amongst the products of the distillation of coal, and probably other organic compounds, but is always obtained by the manufacturing chemist either from indigo or from nitro-benzole. Dr Hofmann, to whom we are mainly indebted for our knowledge of the chemistry of this substance, gives the following directions for obtaining it from indigo: 'Powdered indigo boiled with a highly-concentrated solution of hydrate of potassa, dissolves with evolution of hydrogen gas

PHEON—PHIGALIAN MARBLES.

to a brownish-red liquid, containing a peculiar acid, called the *anthranilic* acid. If this matter be transferred to a retort, and still further heated, it swells up, and disengages aniline, which condenses in the form of oily drops in the neck of the retort and in the receiver. Separated from the ammoniacal water by which it is accompanied, and re-distilled, it is obtained nearly colourless. The formation of aniline from indigo is represented by the following equation :

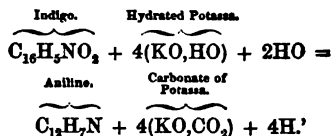

By this process, the indigo is made to yield about one-fifth of its weight of pure aniline. Nitro-benzole is converted into aniline by the action of various reducing agents, such as hydrosulphate of ammonia, or acetate of protoxide of iron; and the distillation of one part of nitro-benzole, one part of acetic acid, and one and a half parts of iron filings, is regarded by Hofmann as the best means of preparing aniline, which is now required in large quantities for the dyes.

'When pure,' says Dr Hofmann, 'aniline forms a thin, oily, colourless liquid, of faint vinous odour, and aromatic burning taste. It is very volatile, but has nevertheless a high boiling-point, 359° 6. In the air, it gradually becomes yellow or brown, and acquires a resinous consistency. Its density is 1.028. It is destitute of alkaline re-action on test-paper, but is remarkable for the number and beauty of the crystallisable compounds it forms with acids. Two extraordinary re-actions characterise this body, and distinguish it from all others—viz., that with chromic acid, and that with solution of hypochlorite of lime. The former gives with aniline a deep-greenish or bluish-black precipitate; and the latter, an extremely beautiful violet-coloured compound, the fine tint of which is, however, very soon destroyed.' In the manufacture of aniline on a large scale, several bases having higher boiling-points than aniline are formed. To one of these—a beautiful crystalline compound, represented by the formula  $\text{C}_{21}\text{H}_{11}\text{N}_3$ —the name of *Paraniline* has been given, from its being isomeric with aniline. Aniline is a substance of the greatest importance in theoretical organic chemistry, from the large number of derivatives and substitution-products which it yields, and for the knowledge of which we are almost entirely indebted to Hofmann, whose investigations originally appeared in a series of papers in the *Transactions of the Philosophical Society*. These compounds are, however, for the most part of too complicated a nature to be noticed in these pages. But, independently of its theoretical importance, this substance has recently been extensively employed in the arts, a series of pigments of unequalled beauty having been obtained from it by the action of oxidising agents. It is to Mr W. Perkin that we are indebted for the idea of applying practically the property possessed by aniline of forming violet and blue solutions with chromic acid and with hypochloride of lime, to which we have already referred; and he succeeded in fixing these colours, and adapting them to the use of the dyer. The most important of these colouring matters are described in the article DYE-STUFFS (q. v.).

(4.) Trinitrophenic Acid [ $\text{HO, C}_6\text{H}_3(\text{NO}_2)_3\text{O}$ ], in which three of the equivalents of the hydrogen of phenic acid are replaced by three equivalents of the group,  $\text{NO}_2$ ; known also as Carbazotic Acid (q. v.) and Picric Acid. In addition to the remarks

contained in the article on CARBAZOTIC ACID, it may be noticed that while a solution of this acid communicates a bright-yellow tint to animal textures, as the skin, wool, and silk, it has no such effect on tissues composed of vegetable fibres, such as cotton and linen, and hence it may be employed to ascertain whether the materials of any tissue belong to the animal or to the vegetable kingdom. A solution of a salt of this acid, when treated with indigo, yields a beautiful green colour, which is employed in the manufacture of artificial flowers, and for various other purposes. In doses of from 1 to 10 grains, it acts on rabbits as a strong poison, occasioning convulsions and speedy death. It has been prescribed in small doses, with moderate success, in cases of intermittent fever; but patients to whom it is given should be previously informed that it possesses the property of giving to the eye a yellow and, as it were, a jaundiced appearance. All the salts of this acid are of a beautiful red or yellow tint, and most of them form brilliant crystals. When heated, or in some cases when only struck, they explode with considerable violence.

PHEON, in Heraldry, the barbed head of a dart. It is represented as engrailed on the inner side, and its position is with the point downwards, unless otherwise blazoned.

PHERÆ, a powerful city of Thessaly, near Mount Pelion; according to legend, the ancient royal seat of Admetus and Alcestis; and afterwards of political consequence under 'tyrants' of its own, who long made their influence felt in the affairs of Greece, and repeatedly attempted to make themselves masters of Thessaly. One of these tyrants named Alexander, is particularly celebrated for his cruelties. It was one of his practices to bury innocent persons alive, and another to sew them up in the skins of wild beasts and set his hounds upon them. After a bloody reign of thirteen years, he was slain by his wife and her brother, 357 B. C. Five years later, P., with the rest of Thessaly, became subject to Philip of Macedon.—At P. there was a mineral spring, named Hyperia, famous for its healing virtues. A few ruins at Velestino still mark the site of the city.

PHERECYDÉS, an ancient Greek writer, born in the island of Syros, one of the Cyclades, in the 6th c. B. C. He is said by Diogenes Laertius to have been a rival of Thales, and to have learned his wisdom from the Egyptians and Chaldeans. He wrote a *Cosmogony* in a kind of prose much resembling poetry, under the title *Heptamychos*, the meaning of which is doubtful. In a manner rather poetic than philosophic, he endeavoured in this work to shew the origin of all things from three eternal principles, *Time* or *Kronos*; *Earth*, as the formless and passive mass; and *Ether* or *Zeus*, as the formative principle. He taught the doctrine of the existence of the human soul after death; but it is uncertain if he held the doctrine of the transmigration of souls, afterwards promulgated by his disciple, Pythagoras. Of his work, only fragments are extant, which have been collected and elucidated by Sturtz (*Gera*, 1798; 2d ed., Leip. 1824).—Another P., who lived in the 5th c. B. C., compiled the mythical histories of Athens and other states, but, except a few fragments, the work is lost. See Sturtz, *Pherecydis Fragmenta* (Leip. 1824).

PHIGALIAN MARBLES, the name now given to the sculptured frieze taken from the cello of the temple of Apollo at Phigalia in Arcadia in 1814, and transferred to the British Museum. It represents the contests between the Centaurs and Lapithæ. The Phigalian temple of Apollo is, next to the Theseium at Athens, the most perfect architectural

ruir. in all Greece; but owing to its sequestered position at the head of a lonely and rocky glen among the Arcadian hills, it long remained unknown in modern times, except to the shepherds of the district; and to the same circumstance it probably owes, in part, its preservation. Chandler first visited and described it in 1765; he was followed by Gell, Dodwell, and others; and in 1812 it was very carefully examined by a body of artists and scholars, the results of whose investigations are given in Stackelberg's *Der Apollo-tempel zu Bassæ in Arkadien* (Rome, 1826). The temple is built of a hard yellowish-brown limestone, stands north and south, was originally about 125 feet long and 48 broad, and had 15 columns on either side, and 6 on either front, in all 42, of which 36 still remain.

PHILADELPHIA, the chief city and seaport of Pennsylvania, U.S., and the second city in population and importance in America, is situated on the west bank of the Delaware River, at the mouth of the Schuylkill, on a plain 2 to 4 miles wide between the two rivers; lat. 39° 56' 59" N., long. 75° 9' 54" W.; 136 miles north-east of Washington, 87 miles south-west of New York. It is 5 miles long by 3½ wide, having 12 square miles, laid out by its founder, William Penn, in streets crossing each other at right angles. The city is neatly but plainly built of red bricks and marble, with 7 squares laid out as parks. The picturesque eminence of Fairmount, with its reservoirs of water raised from the Schuylkill, and the Laurel Hill and other ornamental cemeteries, are favourite public resorts. Among the finest edifices are the Custom-House (formerly United States Bank), Mint, and the buildings of the Girard College, all built of white marble, the latter, in the Corinthian style, having cost, with the surrounding buildings, 2,000,000 dollars. There are 4 or 5 theatres, and an 'Academy of Music' capable of seating about 8500 persons, some 850 churches, about 60 of which are Episcopal, 70 Presbyterian, and 80 Roman Catholic, among which is a magnificent Cathedral, just completed; numerous and magnificent hotels, markets, and public institutions. The most noted building is Independence Hall, occupied in the revolution of 1776 by the Continental Congress, in which was voted and signed the Declaration of Independence. The Philadelphia Library, founded by Benjamin Franklin, contains 80,000 volumes. There are also an Academy of Fine Arts, an Academy of Natural Sciences, Girard College, the University of Pennsylvania, and several flourishing medical colleges. The public schools of Philadelphia comprise 2 high schools, 60 grammar-schools, and more than 800 schools of lower grades. The Girard College, founded by Stephen Girard, a Philadelphia merchant, supports and educates 600 orphans. Next to New York, P. is the largest publishing emporium in the country, issuing, besides books, about a dozen daily papers, 40 weekly papers, and 50 periodicals. Among the charitable institutions, for which the city is noted, are 22 hospitals and dispensaries, 14 asylums, 4 lying-in charities, and 14 for the relief of the poor; a city almshouse, with 8000 inmates; house of refuge, &c. There are 15 military hospitals, with beds for over 18,000 patients. The Eastern State Penitentiary is a model institution on the system of solitary confinement. The city, divided into 26 wards, is governed by a mayor, a select council of 26, and common council of 44 members. The city revenue is 2,724,709 dollars; its debt, 21,000,000 dollars. The United States mint, established 1791, had, up to 1862, coined 404,928,876 dollars in gold and 97,725,589 dollars

in silver. There are several fine brick market-buildings; some 25 banks of issue; 7 or 8 savings banks; board of trade; merchants' exchange; corn exchange; an excellent harbour; imports, direct and by New York, of 45,000,000 dollars per annum; a large coal trade; railways which in 1860 conveyed goods to the interior to the value of 140,000,000 dollars; manufactures of iron, machinery, cotton, woollen, clothing, chemicals, boots and shoes, furniture, &c., amounting to 175,000,000 dollars a year. P. was founded in 1682 by William Penn, on 'a spot that seemed to have been appointed for a town,' and of which he wrote, 'Of all places in the world, I remember not one better seated.' Its early settlers were mostly of the Society of Friends. In 1684 it had 2500 inhabitants. It grew rapidly by large immigrations from Germany and the North of Ireland. In 1729 was established the *Pennsylvania Gazette*, afterwards edited by Franklin. The first colonial congress met here in 1774; in 1777 the town was occupied by the British forces under General Lord Howe, when the city contained 21,767 inhabitants. It was the seat of the United States bank, the capital till 1800, and the first city in America, until surpassed by New York. Pop. (1860) 566,581.

PHILÆ, the name of a celebrated island lying in the midst of the Nile, south of Syene, beyond the frontier of Egypt, in 24° 1' 28" N. lat. It was called by the Egyptians Menlak, the place of the Cataract; or *Menuab*, the Abaton or Sanctuary; and by the Copts, Pilak or 'Cataracts.' It is a small granite rock, about 1000 feet long, and 200 feet broad, on which is placed a suite of buildings, not of the most remote antiquity, but distinguished for great architectural beauty. The oldest of these, consisting of a hypæthral or roofless hall, was built in the reign of Nectanebus I., 377—357 B.C. A second mention of the same monarch occurs on the first propylon, where a door, constructed in his reign, has been incorporated into the constructions by a later Ptolemy. Both these are dedicated to the goddess Isis, who in P. was venerated as Athor or the Egyptian Veuus. The principal remains consist of the great temple of Isis, erected by Ptolemy II. or Philadelphus, and continued by his successors, especially by Ptolemy III., Euergetes, 247—222 B.C.

The temple consists of a shrine or sekos, a pronaos, an open portico, and two pylons or gateways. Both of the propylons were constructed by Ptolemy VII., or Philometer, and Lathyrus; but the first was added to by Ptolemy IX., or Euergetes II., 145—141 B.C. On the second pylon, the monarch is represented slaying the hostile nations. The colonnade was principally erected by Tiberius. The charming little temple, the Mastabat el Pharaoun, or Pharaoh's Bed of the Arabs, was made in the reign of Trajan, 100 A.D. The temples are particularly important as containing the principal representations of the story of Osiris, his birth, bringing up, death, and embalmment by Isis. Commenced in the reign of Nectanebus I., and continued by the Ptolemies and Romans, the worship of Isis lingered here till 453 A.D., or sixty years later than the edict of Theodosius. After the subjection of the Blemmyes to the Nubian Christians, the temple was converted into a church, and the paintings daubed with mud; and, in 577 A.D., the bishop Theodorus changed the pronaos of the temple of Isis into the church of St. Stephen; and a Coptic church, at a later period, was built out of the ruins. The whole area of the ancient temple was about 435 feet long by 135 broad, in the centre of the dromos. At the present day the island is deserted. It is a favourite resort of travellers

ascending to Nubia, and is one of the best of the remaining ruined sites of ancient Egypt.

Pliny, N. H., v., c. 29; Servius, *Æneid*, v. 154; Jones and Gourry, *Views on the Nile*; Wilkinson, *Modern Egypt*, ii. 295—303; Brugsch, *Reiseberichte aus Ägypten*, p. 256; Lepsius, *Reise*, p. 262.

**PHILANTHROPY**, a word formed from the Greek, and signifying the 'love of mankind.' In the history of German school education it has acquired a special meaning. The influence exercised by Rousseau was not less great on education than on politics, and was as visible in the pedagogues of Germany and Switzerland as in the men of the French Revolution. It is to the brilliant and one-sided advocacy by the author of *Emile*, of a return to nature in social life and in the training of the young, that Basedow owed his novel and enthusiastic educationalism. A brief notice of the institution, which was opened under his auspices at Dessau in 1774, and which was called *Philanthropin*, is given in the article on Basedow. Other establishments of the same kind were founded in different parts of Germany, but the only one which still survives is Salzmann's Institute at Schnepfenthal, in Gotha, opened in 1784.

**PHILEMON AND BAUCIS**, according to a classic myth, finely poetised by Ovid in his *Metamorphoses*, were a married pair, remarkable for their mutual love. Jupiter and Mercury, wandering through Phrygia in human form, were refused hospitality by every one, till this aged pair took them in, washed their feet, and gave them such humble fare as they could provide. On going away, the gods took them with them to a neighbouring mountain, on looking from which they saw their village covered with a flood, but their own cottage changed into a splendid temple. Jupiter permitted them to make any request they chose, but they only asked to be servants of his temple, and that they might die at the same time. When, accordingly, they were seated at the door of the temple, being now of great age, they were changed, Philemon into an oak, and Baucis into a linden. They felt the change taking place, and as long as the power remained with them, looked most tenderly upon one another.

**PHILEMON**, EPISTLE OF PAUL TO, is the shortest of the four extant letters which the apostle wrote from Rome during his captivity. We either directly learn, or legitimately infer from its contents, that Philemon, who probably lived at Colosse, was a man of considerable wealth, the head of a numerous household, and liberal to the poor. He had possessed a slave called Onesimus, who had run away from him, after—it has been thought (verse 18)—robbing or defrauding him. Onesimus, however, coming to Rome, had been brought into contact with Paul, and converted to Christianity. At first the apostle thought to retain him as his personal attendant, for he was now, as he tells us (verse 9), 'Paul the aged;' but on further consideration, he resolved to send him back to his former master. The epistle is simply a brief letter, begging Philemon to pardon Onesimus, and to receive him 'not now as a servant, but above a servant, a brother beloved.' It exhibits an exquisite tenderness and delicacy of feeling, with all that tact and subtlety of address, by which Paul was wont to find his way into the innermost heart of men. The historical evidence of its authenticity is complete. Even Baur has remarked that modern criticism in assailing this particular book runs a greater risk of exposing itself to the imputation of an excessive distrust—a morbid sensibility to doubt and denial—than in questioning the claims of any other epistle ascribed to Paul.

**PHILIDOR**, the assumed name of a French family, which has produced many distinguished musicians, and one celebrated composer. The real name of the family was DANIGAN, and the additional appellation P. was assumed by Michel Danigan, the hautboist to Louis XIII., on account of his having equalled a celebrated player on the same instrument, named Filidori. The name was transmitted to his descendants, the most famous of whom was his grandson, FRANÇOIS ANDRÉ DANIGAN, who was born at Dreux, in the department of Eure et Loir, 1726, studied music, and produced a great many comic operas, all long forgotten. It may be noticed that, while residing in London—whither he had fled on the outbreak of the revolution—(1779), he set to music the 'Carmen Sæculare' of Horace, a work which is considered by many as a masterpiece of musical art. He died in London, 31st August 1795. P.'s modern reputation rests exclusively on his skill in the game of chess, the principles of which he has laid down with exceeding clearness. It was in great measure his passion for this game which prompted him to visit Germany and Holland, where at that time the most distinguished players were to be found, in order to measure his strength with theirs. He was one of the founders of the London Chess Club. Here it was that in 1777 he published his *Analyse du Jeu des Echecs* (Analysis of the Game of Chess). One principle, then unique, seems to lie at the root of all P.'s games—i. e., to maintain and support carefully the pieces in the centre of the board—and rather than deviate from this principle, he rejects the opportunity of making an effective and advantageous move. He practised with success the playing of games blindfold; but in this particular he has been far surpassed in recent times by Harrwitz, and more recently by Morphy.

**PHILIP II.**, king of Macedonia, and father of Alexander the Great, was born at Pella in 382 B. C. He was the youngest son of Amyntas II. and Eurydice. At Thebes, whither he was taken as a hostage by Pelopidas, he spent part of his early life, employing his exile in studying the art of war, and the constitution and laws of the Greek states, as well as the literature and the character of the people—pursuits which were of the greatest service to him afterwards, when called on to administer the government of the Macedonian kingdom. The assassination of his eldest brother, Alexander II., by Ptolemy Alorites, after a short reign of two years (369—367 B. C.), and the death of his second brother, Perdicas III., in battle (360 B. C.), placed him at the head of affairs in Macedonia, as guardian to his nephew Amyntas, still an infant. In a few months, P. made himself king, the rights of Amyntas being set aside. Dangers soon beset him from without and from within. The Illyrians and other neighbouring tribes assailed his kingdom on different sides; while two pretenders to the throne, urged on by the Athenians and Thracians, stirred up civil commotion. But foreign and domestic enemies soon disappeared before the decision, the energy, and the wise policy of the young king. In the brief space of a year he had secured the safety of his kingdom, and had gained for himself a dreaded name. At this time he was only 24 years of age. Henceforward his policy was one of aggression, and his every thought was directed to the extension of his empire and the spread of Macedonian influence. The Greek towns on the coast of Macedonia were the first objects of attack. After possessing himself of Amphipolis and Pydna, by means little consistent with the faith of treaties, he handed over to the Olynthians the city of Potidæa, which he had taken from the Athenians. In Thrace he captured the small town Creuides, which, under its new name,

PHILIPP, soon acquired great wealth and fame, and ultimately became celebrated in profane as well as in sacred history. The surrounding district was rich in gold-mines, which proved a source of great revenue to P. (about, say, £250,000 annually), and supplied him plentifully with the means of paying his armies, of bribing traitorous Greeks, and of opening the gates of many cities, the sieges of which might otherwise have cost the blood of thousands. After a few years of comparative leisure, he turned his ambitious views southward; and capturing Methone (at the siege of which he lost an eye), he advanced into Thessaly, and ultimately to the Strait of Thermopylæ, which, however, he did not attempt to force, as it was strongly guarded by the Athenians. He therefore returned into Macedonia, and directed his arms against the Thracians, waiting for a more fitting occasion to carry out his darling project. Such an opportunity was not long wanting. After capturing all the towns of Chalcidice—the last of which was the important city of Olynthus—he made peace with the Thracians, and next year with the Athenians, who had been at war with him in defence of their allies the Olynthians. It was this siege of Olynthus by P. which called forth these Olynthiac orations of Demosthenes, which are still admired as efforts of oratorical genius hitherto unequalled in any country. P. was now requested by the Thebans to interfere in the war ('the Sacred War') which was raging between them and the Phocians. He marched into Phocis, destroyed its cities, and sent as colonists to Thrace many of the inhabitants (346 B.C.). The place which the Phocians had occupied in the Amphictyonic Council was transferred to P., and he was appointed, jointly with the Thebans and Thessalians, as president of the Pythian games. His next step was to secure a footing in the Peloponnese, by espousing the cause of the Argives, Messenians, and others, against the Spartans. In 339 B.C. the Amphictyonic Council declared war against the Locrians of Amphissa; and, in the following year, appointed P. commander-in-chief of their forces. The Athenians were alarmed at his approach into Greece in this capacity, and formed a league with the Thebans against him; but their united army was utterly defeated at the battle of Cheronea (338 B.C.), and all Greece was at the feet of the conqueror. He was now in a position to enter on the great dream of his later years—viz., to invade the Persian empire, and revenge the injuries of Greece. Deputies from the different states of Greece assembled in congress at Corinth; and after resolving to make war on the Persian king, chose P. as leader of their armies. Preparations were in progress for this great expedition when he was suddenly cut off by the hand of the assassin Pausanias, at a festival celebrating the marriage of his daughter with Alexander of Epirus (336 B.C.). A private grudge at P., for neglect to punish an insult offered to Pausanias by Attalus, was said to be the motive which inspired the murderer, though suspicion is not wanting that the deed was done at the instigation of Alexander and his mother Olympias, who had retired from the court in disgust at P.'s marriage, the year previous, with Cleopatra, daughter of Attalus, one of his generals. P. was a man given to self-indulgence and sensuality; he was faithless in the observance of treaty obligations, and unscrupulous as to the means by which he gained his ends; but he had to deal with factious and faithless opponents, which may help to explain, if it does not justify his policy; while his clemency as a victor has won the admiration even of the virtuous Cicero, who pronounces him 'always great.' Of his force and energy of

character, his acuteness, fertility of invention, and eloquence, it is impossible to speak too highly. He was at the same time a lover of learning, and a liberal patron of learned men. He reigned from 359 to 336 B.C.

**PHILIP III., OF MACEDON.** On the death of Alexander the Great at Babylon in 323 B.C., the army elected as king, under the name of Philip III., Arrhidæus, son of Philip and Philina of Larissa, one of his many wives. He was a youth of weak understanding, and was totally unfit for the duties of government. His wife Eurydice (daughter of Amyntas, son of Perdiccas III.), whom he married in 322 B.C., endeavoured, on their return to Macedonia, to oppose the measures of Polyperchon and Olympias in support of the young Alexander, posthumous son of Alexander the Great and Roxana. But her army was defeated; she herself was taken prisoner; and, along with her husband, was put to death in 317 B.C.

**PHILIP II., KING OF SPAIN,** the only son of the Emperor Charles V. (q. v.) and Isabella of Portugal, was born at Valladolid, 21st May 1527. He was brought up in Spain, and carefully educated under the superintendance of able tutors, by whose instructions he greatly profited, becoming an accomplished linguist and mathematician, and a connoisseur in architecture and the fine arts. But all attempts to indoctrinate him with the chivalric ideas of the time were utterly futile. From his very childhood he was distrustful and reserved; he invariably spoke with slowness and an air of deep reflection which was too marked to be wholly real, and exhibited in his manners a *sang-froid* which even in his early years was rarely disturbed by ebullitions of passion. While still very young he was intrusted, under the direction of a council, with the government of Spain, and in 1543 he espoused Mary of Portugal, who died three years after. In 1548 he went to join his father at Brussels, and there adopted the multitudinous equipage and minute and pompous etiquette of the late Burgundian court, which from this time he retained. While at Brussels, P. was presented to his future subjects, and was at the same time fully initiated into his father's policy, the two chief items of which were the maintenance and extension of absolute rule throughout his dominions, and the support and propagation of the Catholic religion. In 1554 he married Mary Tudor, Queen of England, and to gain the support of that country to his political projects, and at the same time restore it to the Roman Catholic pale, he laid aside his ordinarily cold and haughty demeanour, and laboured to ingratiate himself with his wife's subjects, taking the utmost care to avoid exciting the national jealousy of foreign influence. But his plans were discovered and frustrated, and this disappointment, combined with the annoyance to which he was subjected by the jealousy of his wife, prompted him to leave England (which he did for ever), and return to Brussels (September 1555). In the following month he became, by the abdication of his father, the most powerful potentate of Europe, having under his sway, Spain, the Two Sicilies, the Milanese, the Low Countries, Franche Comté, Mexico, and Peru; his European territories being more fertile, and their inhabitants more wealthy and prosperous, than any others on the continent, while his army was the best disciplined, and headed by the greatest generals of the age. The treasury alone was deficient, having been drained by the enormous expenditure of his father's wars. P. was eager to begin the crusade in favour of Catholicism, but he was compelled to postpone

it, owing to a league which had been formed between France, the Pope, and the Sultan, to deprive him of his Italian dominions. He soon got over his religious scruples at engaging in warfare with the pope, and intrusted the defence of the Sicilies to Alva (q. v.), who speedily drove out the pope and the French, and conquered the papal territories, while P. himself vigorously prosecuted the war against France in the north, and defeated the French at St Quentin (q. v.) (August 10, 1557) and Gravelines (July 13, 1558). These reverses forced the French (the pope having already made a separate treaty) to agree to terms of peace at Chateau-Cambresis (April 2, 1559). P.'s wife was now dead, and after an unsuccessful attempt to obtain the hand of her successor, Queen Elizabeth, he espoused Isabella of France, and returned to Spain, where from this time he always resided. Before leaving the Low Countries, he solemnly promised to withdraw almost the whole of his Spanish troops who preyed upon the peaceful Flemings, but he firmly refused to annul or modify the rigorous edicts of his father against heretics. His realm being now at peace, he resolved, as a necessary preliminary to the carrying out of his great proselytising scheme, to replenish his treasury, a thing impossible without forced contributions, which, at that time, could only be obtained in those countries over which he held absolute rule—viz., Spain and America. He therefore set about establishing absolute government in those of his states that were in possession of something like free institutions, and with this view sought to introduce the Inquisition into the Low Countries and Italy. But the introduction of this instrument of tyranny was successfully resisted in Naples and the Milanese; in Sicily its powers were so shackled as to render it quite a harmless institution; but these failures only stimulated him the more to establish it in all its pride and power in the Low Countries. For a number of years it continued in vigorous action in that country; but the natural result of such a course of conduct was a formidable rebellion of all classes, Catholic and Protestant, which was partially successful—the northern portion (the 'seven united provinces') establishing its independence in 1579. In this conflict the resources of Spain were largely expended, and to replenish his treasury in the speediest manner possible, P. exacted enormous contributions from Spain, abolishing all special communal or provincial privileges and rights which might interfere with his actions, and suppressing all insurrection and discontent by force of arms or the Inquisition. During the first half of his reign he engaged in a desultory warfare with the Barbary corsairs, who were supported by the Turks—the only memorable incident of which was the famous naval victory of Lepanto (q. v.), won September 16, 1571. In 1580 the direct male line of Portugal having become extinct, P. laid claim to the throne, and after the Duke of Alva had occupied the kingdom with an army, the Spanish monarch's title was recognised by the Portuguese estates. His enmity to England on account of the anti-Spanish policy of Queen Elizabeth incited him to attempt the conquest of that country, but his most formidable attempt failed signally. See ARMADA. After the accession of Catharine de Medicis to power, France and Spain drew closer the bonds of amity which had previously subsisted between the two countries; but the refusal of Catharine to adopt P.'s plans for the wholesale slaughter of heretics produced a coolness in their relations. However, when Henry, king of Navarre, a Huguenot, became heir-presumptive to the throne, P. allied himself with the Guises and the other chiefs of the Catholic party who were in rebellion, and his

obstinate persistence in these intrigues after the cause of the Guises was shewn to be hopeless, prompted Henry to declare war against him. The Spaniards had the worst of it, and P. was glad to conclude the treaty of Vervius (2d May 1598). He died in the Escorial at Madrid, on 13th September of the same year. It cannot be denied that P. was gifted with great abilities, but he was also a visionary, especially in politics, and engaged in so many grand enterprises at once as to overtask his resources without leading to any good or profitable result. No single kingdom in Europe could have long stood against him, but he was always at war with at least two at a time; and even the splendid opportunity which the extinction of the direct Capetian line in 1589 gave him for uniting France, Spain, and Portugal in one great monarchy, could not restrain this unfortunate peculiarity. His fanatical enthusiasm for Catholicism, in which he was surpassed by no man who ever lived, and the zeal with which he persecuted all heretics through the Inquisition, combined with the odious tyranny of his secular government to degrade Spain, by breaking the proud and chivalrous spirit which had been the source of its pre-eminence among European nations, while his virulent persecutions of the industrious Moriscos, and his oppressive exactions, put a stop to the commerce of the country. By his fourth wife, Anne of Austria, he had a son, Philip III.

PHILIP V., king of Spain, and the founder of the Bourbon dynasty in that country, was the second son of the Dauphin Louis (son of Louis XIV.) of France, and was born at Versailles, December 19, 1683. The last king of Spain of the Hapsburg dynasty, Charles II., had successively promised the succession to the throne to Charles, archduke of Austria, the great grandson of Philip III. of Spain, and to P., then Duke of Anjou, the son of his own eldest sister; but becoming cognizant of a secret treaty which had been agreed to between England, France, and Holland for the partition of Spain, he, to prevent the dismemberment of his kingdom, left by will the succession to P. of Anjou. France immediately seceded from the partition treaty, and, on the death of Charles II. in 1700, P., who was the favourite candidate among the Spaniards, with the exception of those in the eastern provinces, took possession of the kingdom (April 21, 1701); and, to gain over Savoy to his side, and thus create a diversion in Italy against Austria, he married Maria Louisa, daughter of Victor Amadeus. War almost immediately broke out between the rival claimants, Charles being supported by the 'grand alliance,' which included England, Austria, and Holland, and subsequently (January 1702) Prussia, Denmark, and Hanover (May 1703), Portugal, and (October 1703) Savoy. See SUCCESSION, WAR OF SPANISH. The fortune of war was mostly on the side of the allies; but France and Spain carried on the contest heroically, and, though at great sacrifices, the throne was secured to P. by the peace of Utrecht (April 11, 1713). In the following year the queen died, and P. espoused Elizabeth Farnese of Parma, who immediately induced her husband to commit the reins of government to Alberoni (q. v.); in fact, so much was the weak-minded king under the influence of his talented young wife, that he granted everything she asked. 'He was,' says Sismondi, 'remarkable for good nature, he had few faults and as few virtues, his sentiments were just and honourable, but he was wholly deficient in energy; he had no taste for anything beyond devotional exercises and the chase; he was made to be governed, and he was so all his life.' Alberoni's adventurous foreign policy, which at first succeeded in restoring the



Spanish rule in Sicily and Sardinia, brought down upon Spain the wrath of the Quadruple Alliance (France, England, Holland, and Austria), and was only averted by his being dismissed; but his dismissal was really produced by his neglecting to further the queen's pet scheme of providing sovereignties in Italy for her sons, who seemed to have little chance of obtaining the throne of Spain. The strong bond of union which had hitherto subsisted between Spain and France was broken, in 1725, by the refusal of the regent of the latter country to fulfil certain matrimonial agreements; but four years afterwards the two countries joined with England and Holland against the emperor, and in 1731 P. took measures to recover the old Spanish possessions in Italy. The war which followed at last satisfied the queen by giving the kingdom of the Two Sicilies to her son Charles (1736), but P., in attempting to obtain still greater advantages over Austria, was led into a war of which he was not destined to see the result. He died at Madrid, July 9, 1746.

**PHILIPPE II.**, better known as **PHILIPPE AUGUSTE**, king of France, was the son of Louis VII. and Alix of Champagne, and was born in August 1165. He was crowned, in 1179, during the life of his father, succeeded him in 1180, and proved one of the greatest monarchs of the Capetian dynasty. His marriage with Isabella of Hainault, a descendant of the Carolingians, established more completely the right of his family to the throne of France. He first made war upon the Count of Flanders, to obtain the districts of Vermandois, Valois, Amienois, and Artois, which belonged to his wife, and, after various fortune, obtained Amienois and part of Vermandois at once, and the rest after the count's death in 1185. By the advice of St Bernard (q. v.) he rigorously punished heretics, despoiled the Jews, absolving their debtors of all obligations, excepting one-fifth, which he transferred to himself; put down with vigour the numerous bands of brigands and priest-haters who devastated the country and burned the churches and monasteries, compelling their chief leader, the Duke of Burgundy, to submit (1186) to his authority—acts which gave him great popularity among his subjects. He sustained the sons of Henry II. of England in their rebellions against their father, and conquered, in conjunction with Richard Cœur-de-Lion, many of the English possessions in France. After the accession (1282) of Richard to the throne, P. and he set out together on the third crusade; but quarrelled while wintering in Sicily, and this dissension continuing, P., after a sojourn of 34 months in Syria, set out (31st July 1190) on his return to France, after taking a solemn oath to respect the integrity of Richard's dominions; but no sooner had he returned than he entered into an arrangement for the partition of Richard's territories in France with his unworthy brother John. Some acquisitions were made, but Richard's sudden return upset the calculations of the conspirators, and a war immediately commenced between the two monarchs, in which P. had at one and the same time to defend his territories from the English, and the Counts of Champagne, Boulogne, Bretagne, and Hainault, who attacked them on all sides. In order to obtain money, he was obliged to rescind his edicts against the Jews; but the mediation of Pope Innocent put an end (13th January 1199) to a war which was productive of no other result than the exhaustion of the strength of the combatants. Richard of England died within two months after; but war almost immediately recommenced with England, regarding the respective claims of King John of England and his nephew

Arthur of Bretagne to the French heritage of Richard Cœur-de-Lion, which consisted chiefly of Anjou, Maine, and Touraine. Arthur had applied for aid to P., and the French king immediately responded by causing the young duke to be recognised in the above-mentioned provinces; but a quarrel in which he became involved with the pope on account of his having divorced his second wife, Ingelburga of Denmark, to marry Agnes of Meran, a Tyrolese princess, compelled him to leave the English in possession for a little time longer. The defeat, capture, and subsequent murder of Arthur, however, again brought him into the field. The English provinces in France were attacked by the combined French and Bretons; Normandy and Poitou, with the three disputed provinces, were annexed to France; and the English dynasty in Bretagne dispossessed by a French one (26th October 1206). During 1211—1214, P. was engaged in a war with King John of England and the Emperor Otho of Germany, who had leagued themselves against him, in which he was on the whole successful. During the rest of his reign, P. was occupied in consolidating his new possessions, and took no part either in the war with the Albigenses or that in England, though his son Louis (q. v.) went to the latter with an army. P. succeeded in establishing the unity of his dominions, and in emancipating the royal authority from the trammels of the papacy and clergy, and vindicated his sovereign authority over the latter as his subjects, irrespective of the pope. His measures, without alienating the great feudal lords, tended firmly to establish his authority over them, and to emancipate the larger towns from their sway. To increase the unity of the kingdom, and strengthen the central power, he established at Paris a chamber of twelve peers, six lay and six ecclesiastical, who almost always supported his plans, even against the court of Rome. Finally, he largely improved and embellished Paris, built many churches and other institutions, and encouraged commercial associations; he also fortified many of the chief towns, including the capital. He died at Mantes, July 14, 1223.

**PHILIPPE IV.**, surnamed *Le Bel* or '*Fair*,' king of France, the son of Philippe III., king of France, and Isabella of Aragon, was born at Fontainebleau in 1268, and succeeded his father in 1285. By his marriage with Queen Joanna of Navarre, he obtained Navarre, Champagne, and Brie. For several years he carried on a struggle with the Count of Flanders to obtain possession of that country, and also seized Guienne from the English; but was, in the end, obliged to restore Guienne and Flanders beyond the Lys. The great events of P.'s reign were his war with the papacy and the extermination of the Knights Templars; the former had its origin in the attempt of the king to tax the clergy as well as the laity for the heavy expenses of his numerous wars. Boniface forbade the clergy to submit to taxation, while P., on his side, ordered that neither money nor valuables were to be exported, thus cutting off a main supply of papal revenue; and on the pope's legate insolently reprimanding him, he threw him into prison. P. now called an assembly of states, in which deputies of towns appeared—though not for the first time—and obtained assurance of their support, even in case of excommunication and interdict. Boniface, in turn, assembled a council at Rome (1302), which supported his view, and the celebrated bull, *Unam Sanctam* (q. v.) was issued. P. caused the bull to be publicly burned, and with the consent of the states-general confiscated the property of those prelates who had sided with the pope. Boniface now excommunicated him,

PHILIPPE VI.—PHILIPPE LE BON.

but the king, nothing daunted, sent to Rome his general, William de Nogaret, who seized and imprisoned the pope; and though he was released after a few days by a popular rising, he soon afterwards died. In 1304, P. obtained the elevation of one of his own creatures to the papal chair as Clement V., on condition of his residing at Avignon, and giving up the Knights Templars (q. v.). In accordance with this agreement, the Templars were seized (1306—1314), and burned by hundreds, and their wealth appropriated by Philip. The grandmaster, Jacques Molay, was burned, 18th March 1314, and when dying he summoned P. to compare within a year and a day, and the pope within forty days, before the judgment-seat of God; strange to say, both the pope and king died within the time mentioned, the latter at Fontainebleau, November 29, 1314. P. during his whole reign steadily strove for the suppression of feudalism and the introduction of the Roman law; but while thus increasing the power of the crown, and also that of the third estate, he converted royalty, which was formerly protecting, kind, and popular to the mass of the people, into a hard, avaricious, and pitiless taskmaster. Under him the taxes were greatly increased, the Jews persecuted, and their property confiscated; and when these means were insufficient to satisfy P.'s avarice, he caused the coinage to be greatly debased; yet he was an able monarch, and under him France was extended almost to its present limits on the north and east.

PHILIPPE VI., OF VALOIS, king of France, was the son of Charles of Valois, younger brother of Philippe IV., and succeeded to the regency of France on the death of Charles IV., the proclamation of a king being deferred on account of the pregnancy of Charles IV.'s widow; but on her giving birth to a daughter, P. caused himself to be crowned king at Reims (May 29, 1328), and assumed royal authority. His right to the throne was denied by Edward III. of England, the grandson of Philippe IV., who declared that females, though excludable by the Salic law, could transmit their rights to their children, and therefore insisted upon the superiority of his own claims. P., however, was not only already crowned king, but he had the support of the people. His reign commenced gloriously, for marching into Flanders to support the count against his rebellious subjects, he wiped out the disgrace of Courtrai by vanquishing the Flemings at Cassel (August 23, 1328). He was obliged to give up Navarre (q. v.), as the Salic law of succession did not apply to it, but he retained Champagne and Brie, paying for them a considerable annual stipend. P. seems to have had no settled plan of government, and no systematic political action; his acts were regulated by the whim of the hour, and were mostly calculated to gratify his own vanity and love of show. From 1330 to 1336, constant encroachments had been made upon the English possessions in France, till at last Edward III.'s patience was exhausted; and, on August 21, 1337, he formally declared war, and a commencement of this terrible hundred years' contest was made both in Guienne and Flanders; it was carried on languidly for several years, the only prominent incident being the destruction of the French fleet off Sluys (June 24, 1340). In March 1343, P. established the 'gabelle,' or monopoly of salt, a heavy percentage tax on all mercantile transactions. The constant round of fêtes and tournaments at court was never interrupted, even when the war had well-nigh exhausted the wealth of the country, for the money to carry them on was immediately provided by some new tax or fresh confiscation. In 1346, Edward III. landed in Normandy, ravaged the whole country to the environs of Paris, and

totally defeated P. at Crécy (q. v.). A truce was then concluded, but the devoted kingdom had no sooner been released from war, than destruction in another and a more terrible form, that of the 'Black Death' (q. v.), threatened it. The wild extravagance of the court was nothing lessened by this visitation; but the financial embarrassments in which P. found himself, compelled him to agree to the passing of a law (1336) which gave to the assembly of the states the sole power of imposing taxes. He received Dauphiné in gift in 1349, purchased Majorca from its unfortunate king, and died August 22, 1350, neither loved nor respected. He was a despiser of learning, and a bigot.

PHILIPPE LE HARDI (*Philip the Bold*), the founder of the second and last ducal house of Burgundy, was the third son of Jean, king of France, and his wife Bonne of Luxemburg, and was born January 15, 1342. He was present at the battle of Poitiers (1356), and displayed such heroic courage, venturing his own life to save that of his father, as gained for him the sobriquet of *le Hardi*, or 'the Bold.' He shared his father's captivity in England, and on returning to France in 1360, received in reward of his bravery the duchy of Touraine, and subsequently (1363) also that of Burgundy, being created at the same time the first peer of France. On the accession of his brother, Charles V., to the throne of France, P. had to resign Touraine, but, as a compensation, obtained in marriage Margaret, the heiress of Flanders. In 1372, he commanded the French army opposed to the English, and took from them many of their possessions. In 1380, he exerted himself to suppress the sedition of the Flemish towns against their count, and succeeded with some of the malcontents; but the citizens of some of the populous places, especially Ghent, were possessed with such a fever of independence, that after many fruitless attempts to induce them to return to their allegiance, P. raised an army, and inflicted upon them the bloody defeat of Rosbeck (November 27, 1382), leaving 26,000 of them on the field. Flanders, the county of Burgundy, Artois, Rethel, and Nevers fell to him by the death of the count in 1384, and the influence of his power, combined with prudence and good management on his part, soon won the affection and esteem of his new subjects. Energy and wisdom characterised his government; arts, manufactures, and commerce were much and judiciously encouraged, and his territory (a kingdom in extent) was one of the best governed in Europe. During the minority and subsequent imbecility of his nephew Charles VI. of France, he was obliged to take the helm of affairs, and preserve the state from insurrection and sedition within, and the attacks of the English without. He was on his way to repel an attack of the latter on Flanders when he died at the chateau of Hall in Brabant, a little to the southwest of Brussels, April 27, 1404.

PHILIPPE LE BON, i. e., 'the Good,' Duke of Burgundy, the son of Jean 'Sans-peur' by Margaret of Bavaria, and grandson of Philippe the Bold, was born at Dijon (the capital of the duchy), June 13, 1396, and on the assassination of his father on the bridge of Montereau at the instigation of the dauphin (afterwards Charles VII.), succeeded to the duchy of Burgundy. Bent on avenging the murder of his father, he entered into an offensive and defensive alliance with Henry V. of England at Arras in 1419, at the same time recognising him as the rightful regent of France, and heir to the throne after Charles VI.'s death. This agreement, which disregarded the Salic law, was sanctioned by the king, parliament, university, and

## PHILIPPEVILLE—PHILIPPINE ISLANDS.

status-general of France by the treaty of Troyes, but the dauphin declined to resign his rights, and took to arms; he was, however, defeated at Crevant (1423) and Verneuil (1424), and driven beyond the Loire. Some disputes with the English prompted P. to conclude a treaty with the king of France in 1429. However, the English, by ceding to P. the province of Champagne, and paying him a large sum of money, restored him to their side. At this time, by becoming heir to Brabant, Holland, Zealand, and the rest of the Low Countries, he was at the head of the most flourishing and powerful realm in Western Europe; but though much more powerful than his superior, the king of France, he preferred to continue in nominal subjection. Smarting under some fresh insults of the English viceroy, and being strongly urged by the pope, he made a final peace (1435) with Charles, who gladly accepted it even on the hard conditions which P. prescribed. The English, in revenge, committed great havoc among the merchant navies of Flanders, which irritated P. to such an extent that he declared war against them, and, in conjunction with the king of France, gradually expelled them from their French possessions. The imposition of taxes, which were necessarily heavy, excited a rebellion, headed, as usual, by the citizens of Ghent, but the duke inflicted upon them a terrible defeat (July 1454), though he wept over a victory bought with the blood of 20,000 of his subjects. The latter part of his reign was filled with trouble caused by the quarrels between Charles VII. and his son, the Dauphin Louis (afterwards Louis XI.), who had fled from his father's court, and sought shelter from P., although, after ascending the throne, far from shewing gratitude, he tried, in the most dishonourable manner, to injure his benefactor. P. died at Bruges, July 15, 1467, deeply lamented by his subjects. Under him, Burgundy was the most wealthy, prosperous, and tranquil state in Europe; its ruler was the most feared and admired sovereign of his time, and his court far surpassed in brilliancy those of his contemporaries. Knights and nobles from all parts of Europe flocked to his jousts and tournaments.

**PHILIPPEVILLE**, a thriving town and seaport of Algeria, in the province of Constantine, and forty miles north-north-east of the city of that name, on the Gulf of Stora, between Cape Bonjaroun and Cape de Fer. It was laid out in 1838 by Marshal Valée, on the ruins of the ancient Russicada, and is one of the prettiest towns in Algeria, and thoroughly French in its character. It is an important entrepôt of the commerce of the east of Algeria, and the country in the vicinity is picturesque and fertile, producing grain, tobacco, cotton, flax, and fruits. It contains numerous public offices, a large hospital and dispensary, Catholic and Protestant churches, public library and museum, theatre, &c. In the vicinity are quarries of the famous Filfila marble. A harbour is at present (1864) in course of construction, and a pier and dock, which afford shelter to small merchant ships in bad weather, have already been completed. There are here several establishments for curing fish, and trade is carried on in grain and in fabrics of native manufacture. P. will be the chief station of the railway for the province of Constantine. Pop. (1864) 12,191.

**PHILIPPI**, a city of Macedonia. It was named after Philip II. of Macedon, who conquered it from Thrace (up to which time it had been called Crenides, or the 'Place of Fountains'), and enlarged it because of the gold-mines in its neighbourhood. Philip worked the mines so well, that he got from them 1000 talents a year. It is famous on account

of the two battles fought in 42 B. C. between Antony and Octavianus on the one side, and the republicans under Brutus and Cassius on the other. The first engagement was undecided; in the second, 20 days after, the republic finally perished. The apostle Paul founded a Christian church here in 53 A. D., to which one of his epistles is addressed. The ruins of the city still bear the name of Philippi, or Feliba.

**PHILIPPIANS**, **EPISTLE TO THE**, one of the latest of the Pauline epistles. It was transmitted from Rome probably about the year 63 A. D., through Epaphroditus, apparently a pastor of the Philippian church, who had been sent to minister to the necessities of the apostle. The Philippian church was looked upon with peculiar tenderness and affection by Paul. It was the first fruits of his evangelisation in Europe; its members were singularly kind towards him; again and again, when he was labouring in other cities, such as Thessalonica and Corinth, they sent him contributions that he might not be burdensome to his new converts, and now they had sent one of the brethren all the way to Rome with presents for him, knowing that he was in bonds, and suspecting—what was in fact the case—that he might be in sore straits for his daily bread. His letter to them is deeply affecting. It contains not so much of doctrinal matter, as of a warm outpouring of his personal feelings towards his friends at Philippi. The historical evidence in favour of the authenticity of the Epistle is so strong, that it could hardly give way to any internal criticism; and the objections of this kind, urged by Baur, Schwegler, and others of the Tübingen school, who regard it as a Gnostic composition of the 2d c., are regarded as preposterous even by many Biblical scholars who do not profess to be orthodox.

**PHILIPPICS**, originally the three orations of Demosthenes against Philip of Macedon. The name was afterwards applied to Cicero's orations against the ambitious and dangerous designs of Mark Antony. It is now commonly employed to designate any severe and violent invective, whether oral or written.

**PHILIPPINE ISLANDS**, lie to the north of Borneo and Celebes, in 5° 30'—19° 42' N. lat., and 117° 14'—126° 4' E. long. They are more than 1200 in number, with an area of about 150,000 square miles. Pop. over 5,000,000, three-fourths of whom are subject to Spain, the remainder governed, according to their own laws and customs, by independent native princes.

Luzon, in the north, has an area of 51,300 square miles, and Mindanao, or Magindanao, in the south, fully 25,000. The islands lying between Luzon and Mindanao are called the Bissayas, the largest of which are—Samar, area 13,020 square miles; Mindoro, 12,600; Panay, 11,340; Leyte, 10,080; Negros, 6300; Masbate, 4200; and Zebu, 2352. There are upwards of a thousand lesser islands of which little is known. To the south-west of the Bissayas lies the long, narrow island of Paragos or Palawan, formed of a mountain-chain with low coast-lines, cut with numerous streams, and exceedingly fertile. The forests abound in ebony, log-wood, gum-trees, and bamboos. Area, 8820 square miles. To the north of Luzon lie the Batanen, Bashee, and Babuyan Islands, the two first groups having about 8000 inhabitants, the last unpeopled.

The Sooloo Islands form a long chain from Mindanao to Borneo, having the same mountainous and volcanic structure as the P. I., and all are probably fragments of a submerged continent. Many active volcanoes are scattered through the islands; Mayon, in Luzon, and Buhayan, in Mindanao, often

## PHILIPPINE ISLANDS.

causing great devastation. The mountain-chains run north and south, and never attain a greater elevation than 7000 feet. The islands have many rivers, the coasts are indented with deep bays, and there are many lakes in the interior. Earthquakes are frequent and destructive, Manila, the capital, having been nearly destroyed by one in 1863. On February 3, 1864, another terrific earthquake visited the province of Zamboango, in Mindanao, levelling all the houses to the ground, and causing some of the smaller islands to disappear. The soil is extremely fertile, except where extensive marshes occur. In Mindanao are numerous lakes, which expand during the rainy seasons into inland seas. Rain may be expected from May to December, and from June to November the land is flooded. Violent hurricanes are experienced in the north of Luzon and west coast of Mindanao. Especially during the changes of the monsoons, storms of wind, rain, thunder and lightning prevail. The weather is very fine, and heat moderate, from December to May, when the temperature rapidly rises and becomes oppressive, except for a short time after a fall of rain. The fertility of the soil and humid atmosphere produce a richness of vegetation which is nowhere surpassed. Blossoms and fruit hang together on the trees, and the cultivated fields yield a constant succession of crops.

Immense forests spread over the P. I., clothing the mountains to their summits; ebony, iron-wood, cedar, sapan-wood, gum-trees, &c., being laced together and garlanded by the bush-ropes or palasan, which attains a length of several hundred feet. The variety of fruit-trees is great, including the orange, citron, bread-fruit, mango, cocoa-nut, guava, tamarind, rose-apple, &c.; other important products of the vegetable kingdom being the banana, plantain, pine-apple, sugar-cane, cotton, tobacco, indigo, coffee, cocoa, cinnamon, vanilla, cassia, the areca-nut, ginger, pepper, &c., with rice, wheat, maize, and various other cereals.

Gold is found in river-beds and detrital deposits, being used, in form of dust, as the medium of exchange in Mindanao. Iron is plentiful, and fine coal-beds, from one to four feet thick, have been found. Copper has long been worked in Luzon. There are also limestone, a fine variegated marble, sulphur in unlimited quantity, quicksilver, vermilion, and saltpetre—the sulphur being found both native and in combination with copper, arsenic, and iron.

Except the wild cat, beasts of prey are unknown. There are oxen, buffaloes, sheep, goats, swine, harts, squirrels, and a great variety of monkeys. The jungles swarm with lizards, snakes, and other reptilia; the rivers and lakes with crocodiles. Huge spiders, tarantulas, white ants, mosquitoes, and locusts are plagues which form a set-off to the beautiful fireflies, the brilliant queen-beetle (*Elater noctilucus*), the melody of myriads of birds, the turtle-doves, pheasants, birds of paradise, and many lovely species of paroquets, with which the forests are alive. 'Hives of wild bees hang from the branches, and alongside of them are the nests of humming-birds dangling in the wind.'

The caverns along the shores are frequented by the swallow, whose edible nest is esteemed by the Chinese a rich delicacy. Some of them are also tenanted by multitudes of bats of immense size. Buffaloes are used for tillage and draught; a small horse for riding. Fowls are plentiful, and incredible numbers of ducks are artificially hatched. Fish is in great abundance and variety. Mother-of-pearl, coral, amber, and tortoise-shell are important articles of commerce.

The Tagals and Bisayers are the most numerous

native races. They dwell in the cities and cultivated lowlands; 2,500,000 being converts to Roman Catholicism, and a considerable number, especially of the Bisayers, Mohammedan. The mountain districts are inhabited by a negro race, who, in features, stature, and savage mode of living, closely resemble the Alfours of the interior of Papua, and are probably the aborigines driven back before the inroads of the Malays. A few of the negroes are Christian, but they are chiefly idolaters, or without any manifest form of religion, and roaming about in families, without fixed dwelling. The Mestizos form an influential part of the population; by their activity engrossing the greatest share of the trade. These are mostly of Chinese fathers and native mothers. Few Spaniards reside in the P. I., and the leading mercantile houses are English and American. The Chinese exercise various trades and callings, remaining only for a time, and never bringing their wives with them. The principal languages are the Tagalese and Bisayan. Rice, sweet potatoes, fish, flesh, and fruits form the food of the Tagals and Bisayers, who usually drink only water, though sometimes indulging in cocoa-wine. Tobacco is used by all. They are gentle, hospitable, fond of dancing and cock-fighting.

With the exception of two Spanish brigades of artillery and a corps of engineers, the army is composed of natives, and consists of seven regiments of infantry and one of cavalry. There is also a body of Spanish militia in Manila, whom the governor, as commander of the naval and land forces, may call out in an emergency. The navy has four steamships, one brig, six gun-boats, and a great number of feluccas for coast service.

Education is far behind, and similar to what it was in Europe during the middle ages. There is an archbishop of Manila and bishops of New Segovia, Nueva Caceres, and Zebu. Religious processions are the pride of the people, and are formed with great parade, thousands of persons carrying wax-candles, &c.

The natives not only build canoes, but ships of considerable tonnage. They weave various textile fabrics of silk, cotton, abaca, and very fine shawls and handkerchiefs from the fibre of pine-apple leaves. These are called pinas, and often sell for one or two ounces of gold apiece. The pinilian is the finest sort, and is only made to order—one for the queen of Spain costing 500 dollars. They work in horn, make silver and gold chains, fine hats and cigar-cases of fibres, and beautiful mats in different colours, ornamented with gold and silver.

The governor-general is appointed by the sovereign of Spain, and resides at Manila. There are also a lieutenant-governor, governors of provinces, and chiefs of pueblos or townships, who are elected yearly. Acting governors reside also at Zamboanga in Mindanao, and Iloilo in Panay. They are appointed for six years by the governor-general.

The revenue amounts to about £2,100,000, and the expenditure, including subsidies to Spain, nearly the same. In 1859 the budget was—receipts £2,086,946; expenditure, £2,177,652. The personal tax produced £401,793, and the government monopolies, of which tobacco is the chief, £1,499,990. To Spain was remitted £210,802. The gross receipts of the tobacco monopoly were £1,062,041, of which 63 per cent. was expended in paying for tobacco, manufacturing it, and other charges, leaving 37 per cent. of clear profit.

The principal exports are sugar, tobacco, cigars, indigo, Manila hemp, or Abaca (q. v.)—of which 25,000 tons are annually exported—coffee, rice, dyewoods, hides, gold-dust, and bees-wax. Cotton, woollen, and silk goods, agricultural implements,

watches, jewellery, &c., are imported. British and American merchants enjoy the largest share of the business, the imports to Great Britain being upwards of £1,500,000 sterling yearly, and the exports thither nearly of the same value. There are seven British houses established at Manila, and one at Iloilo in the populous and productive island of Panay, which is the centre of an increasing trade. The total exports and imports of the P. I. have a value of about £6,000,000 yearly.

The Sooloo Islands have a population of 150,000; are governed by a sultan, whose capital is Sung, in 66° 1' N. lat., and 120° 55' 51" E. long., who also rules over the greatest part of Paragoa, the northern corner only being subject to Spain.

Luzon has a population of 2,500,000, one-fifth part being independent; the Bissayas islands, 2,000,000, of whom three-fourths are under Spanish rule. The population of Pasay amounts to 750,000, and that of Zebu to 150,000. Of the numbers in Mindanao nothing is known; the districts of Zamboanga, Misamis, and Caragan, with 100,000 inhabitants, being all that is subject to Spain. The greater part of the island is under the sultan of Mindanao, resident at Selanga, in 7° 9' N. lat. and 124° 38' E. long., who, with his feudatory chiefs, can bring together an army of 100,000 men. He is on friendly terms with the Spaniards. Besides Manila, there are very many large and important cities, especially in Luzon, Panay, and Zebu. The great centres of trade are Manila in Luzon, and Iloilo in Panay.

The P. I. were discovered in 1521 by Magellan, who, after visiting Mindanao, sailed to Zebu, where, taking part with the king in a war, he was wounded, and died at Mactan, 26th April 1521. Some years later the Spanish court sent an expedition under Villaboa, who named the islands in honour of the Prince of Asturias, afterwards Philip II. For some time the chief Spanish settlement was on Zebu; but in 1581 Manila was built, and has since continued to be the seat of government.

PHILIPPINS, a Russian sect, so called from the founder, Philip Pustoswiät, under whose leadership they emigrated from Russia in the end of the 17th c., are a branch of the RASKOLNIKS (q. v.). They call themselves Starowerski, or 'Old Faith Men,' because they cling with the utmost tenacity to the old service-books, the old version of the Bible, and the old hymn and prayer-books of the Russo-Greek Church, in the exact form in which these books stood before the revision which they underwent at the hands of the patriarch Nekon in the middle of the 17th century. There are two classes of the Raskolniks—one which recognises popes (or priests); the other, which admits no priest or other clerical functionary. The P. are of the latter class; and they not only themselves refuse all priestly ministrations, but they regard all such ministrations—baptism, marriage, sacraments—as invalid; and they rebaptise all who join their sect from other Russian communities. All their own ministerial offices are discharged by the Starik, or parish elder, who for the time takes the title of pope, and is required to observe celibacy. Among the P. the spirit of fanaticism at times has run to the wildest excesses. They refuse oaths, and decline to enter military service; and having, on account of this, and many other incompatibilities of the system with the Russian practice, encountered much persecution, they resolved to emigrate. Accordingly, in 1700, under the leadership of Philip Pustoswiät, they settled partly in Polish Lithuania, partly afterwards in East Prussia, where they still have several small settlements with churches of their own rite. They are reported to be a peaceable and orderly race. Their principal pursuit is agriculture; and their

thrifty and industrious habits have secured for them the goodwill of the proprietors, as well as of the government.

PHILIPS, AMBROSE, was born in Shropshire in 1675. He studied at St John's College, Cambridge, and took his degree of M.A. in 1700. In 1709 his Pastorals appeared, along with those of Pope, in *Tonson's Miscellany*; and the same year, having gone on a diplomatic mission to Copenhagen, he addressed from thence a 'Poetical Letter' to the Earl of Dorset, which was published, with a warm eulogium from Steele, in the *Tatler*. In 1712, he brought on the stage *The Distressed Mother*, a tragedy adapted from Racine's *Andromaque*, which had great success. He subsequently wrote two other tragedies, but they proved failures. Some translations from Sappho, which appeared in the *Spectator*, added greatly to P.'s reputation, but Addison is believed to have assisted in these classic fragments. Some exaggerated praise of P. having appeared in the *Guardian*, Pope ridiculed his Pastorals in a piece of exquisite irony, which led to a bitter feud between the poets. P. even threatened personal chastisement, and hung up a rod in Button's Coffee-house, but no encounter took place. One of the names fastened upon P. was that of 'Namy Pamby,' arising from a peculiar style of verse adopted by him in complimentary effusions, consisting of short lines and a sort of infantine simplicity of diction, yet not destitute of grace or melody. The accession of the House of Hanover proved favourable to the poet; he was appointed paymaster, and afterwards a commissioner of the lottery; and going to Ireland as secretary to Archbishop Boulter, he became secretary to the Lord Chancellor, M.P. for Armagh, and registrar of the Prerogative Court. He died in 1749. P. is somewhat conspicuous in literary history from the friendship of Addison and the enmity of Pope; but his poetry, wanting energy and passion, has fallen out of view.

PHILIPSTOWN, a market and post town (formerly the assize town) of King's County, province of Leinster, Ireland, 47 miles south-west from Dublin. Its charter dates from 1567; and in the reign of James II. it obtained the privilege of sending two members to parliament. This privilege was withdrawn at the Union. It is at present, and has long been a place of hardly any trade and entirely without manufacture, and the town has fallen still more into decay since the withdrawal of the assizes (1833) to the neighbouring and more flourishing town of Tullamore. Pop. in 1861, 918, of whom 830 were Catholics and 88 Protestants.

PHILISTINES (*LXX.*, *Aluphuloi*, Strangers), a word either derived from a root *phalasa* (.Eth.), to emigrate, wander about, or identified with *Pelasi* (q. v.), or compared by others with *Shefela* (Heb.), lowlanders; designates a certain population mentioned in the Bible as being in frequent contact with the Jews, and who lived on the coast of the Mediterranean, to the south-west of Judea, from Ekra towards the Egyptian frontier, bordering principally on the tribes of Dan, Simeon, and Judah. Our information about the origin of the P. is extremely obscure and contradictory. The genealogical table in Genesis (x. 14) counts them among the Egyptian colonies (the 'Casluhim, out of whom came Philistim'); according to Amos ix. 7, Jeremiah xvii. 4, and Deuteronomy ii. 23, they came from Caphtor. But supposing that the Casluhim were some separate tribe, and yet Caphtorian colonists, the question still remains, whether Caphtor can be identified with Cappadocia in Asia Minor, as the early versions (*LXX.*, *Targ.*, *Peah Pulq.*)

have it; or whether it be Pelusium, Cyprus, or the Isle of Crete. The latter opinion seems not the least probable among them. At what time they first immigrated, and drove out the Canaanitish inhabitants, the Avvim, is difficult to conjecture. They would appear to have been in the country as early as the time of Abraham; and in the history of Isaac, Abimelech, king of Gerar, is distinctly called king of the Philistines. Yet, even supposing that in Genesis the country is designated by the name which it bore at a later period, there can yet be no doubt of the people being firmly established at the time of Moses (Exodus xv. 14, &c.). Thus the date of their immigration would have to be placed at about 1800 B. C. At the Exodus, Moses, evidently fearing an encounter with the warlike colony for his undisciplined band, did not choose the shorter way to Canaan through their territory, but preferred the well-known circuitous route. At a later period, however, Joshua, having triumphed over 31 Canaanite princes, also conceived the plan of making himself master of the possessions of the P.; but his intended disposal of their country for the benefit of the tribe of Judah was never carried out. At this time, they were subject to five princes (Seranim = axes, pivots), who ruled over the provinces of Gaza, Ashdod, Askalon, Gath, and Ekron. Not before the period of the Judges did they come into open collision with the Israelites; and the strength and importance in which they suddenly appear then, contrast so strangely with their insignificance at the time of the patriarchs, that many theories—a double immigration principally—have been propounded to explain the circumstance. We find them daring powerful nations like the Sidonians, whom, about 1209 B. C., they forced to transfer their capital to a more secure position on the island of Tyre; or the Egyptians, with whom they engaged in naval warfare at the same time, under Rameses III. With the Israelites their war assumed the air of guerrilla raids, sometimes into the very heart of the country. Under Shamgar (about 1370 B. C.), they were repulsed, with a loss of 600 men; however, about 200 years later, the Israelites were tributary to them, and continued to groan under their yoke, with occasional pauses only, until Samson first commenced to humiliate them. But they were still so powerful at the time of Eli, that they carried away the ark itself. Under Samuel, their rule was terminated by the battle of Mizpah. Saul was constantly engaged in warding off their new encroachments, and at Gilboa, he and his sons fell in a disastrous battle against them. At this time, they seem to have returned to their primitive form of a monarchy, limited, however, by a powerful aristocracy, the king's formal title again being 'Abimelech' = 'Father-king,' as we find it in Genesis. David succeeded in routing them repeatedly; and under Solomon their whole country seems to have been incorporated in the Jewish empire. The interual troubles of Judæa emboldened the P. once more to open resistance. Under Joram, in union with the Arabians, they invaded Judæa, and not only carried away the royal property, but also the serail and the royal children. Uzziah, however, recovered the lost ground; he overthrew them, and dismantled some of their most powerful fortresses—Gath, Yabne, and Ashdod, and erected forts in different parts of their country. Under Ahaz, they rose again, and attacked the border-cities of the 'plain' on the south of Judah; and a few years later, renewed their attacks, in league with the Syrians and Assyrians. Hezekiah, in the first years of his reign, subjected their whole country again, by the aid of the Egyptians, whom we find in the possession of five cities. The Assyrians, however, took Ashdod, under Tartan,

which was retaken again by Psammetich, after 29 years' siege. About this time, Philistæa was traversed by a Scythian horde on their way to Egypt, who pillaged the temple of Venus at Askalon. In the terrible struggles for supremacy which raged between the Chaldeans and Egyptians, Philistæa was the constant battle-ground of both—her fortresses being taken and retaken by each of them in turn; so that the country soon sank into ruin and insignificance. Yet a shadow of independence seems to have been left to it, to judge from the threats which Zechariah (ix. 5), after the exile, utters against Gaza and Askalon, and their pride. In the time of the Maccabees, the P. were Syrian subjects, and had to suffer occasionally from the Jews, although intermarriages between the two nations were of no rare occurrence. Alexander Balas transferred part of the country to Judæa; another part was taken by Alexander Jannæus; Pompey incorporated some of the cities with Roman Syria; Augustus transferred another portion to Herod; and finally, Salome, his sister, received a small principality of it, consisting of Jamnia, Ashdod, and Askalon. But by this time the name of the country had long been lost in that of Palestine, which designated all the territory between the Lebanon and Egypt.

Of their state of culture, institutions, &c., we know very little indeed. They appear as a civilised, agricultural, commercial, and warlike nation. They traded largely, and their wares seem to have been much sought after. Their worship was much akin to that of the Phœnicians—a nature-religion, of which Dagon, Ashtaroth, Baalzebub, and Derceto were the chief deities. Priests and soothsayers abounded; their oracles were consulted even by people from afar. They carried their charms about their persons, and their deities had to accompany them to the wars. They do not seem to have practised circumcision. As to their language, so little is known about it, that conjectures seem more than usually vain. Those who take them to have been Semites, conclude that their language, too, was Semitic; others, who would identify them with the Pelasgians, differ also respecting their language. Thus much is certain, that their proper names, as they are recorded in the Bible, are mostly Semitic, and that there always remained a difference of dialect between the Hebrew and the Philistæan idiom.

The name of Philistines is given by German students to all non-students in general, and the citizens of the special university-place in particular.

PHILLIP, JOHN, R.A., was born, 22d May 1817, at Aberdeen. At a very early age he gave indication of the talent which has since so distinguished him; and before he had attained his fifteenth year, had painted various pictures shewing his feeling for colour. He thus procured an introduction to the late Lord Panmure, by whom he was enabled to go to London to pursue his studies. He began by copying from the Elgin marbles at the British Museum, and after a few months was admitted as a student at the Royal Academy.

All his early subjects were of Scotch character, such as a 'Scotch Fair,' 'Baptism in Scotland,' a 'Scotch Washing,' 'The Offering,' &c. In the year 1851 he went to Spain in search of health, which he found, and with it a change in the character of his subjects. On his return home he established himself at the head of the painters of the habits and customs of the Spanish people. In 1853 he exhibited at the Royal Academy 'Life among the Gipsies at Seville.' His pictures for 1854—1855, 'A Letter Writer of Seville,' and 'El Paseo,' were both purchased by Her Majesty the Queen. In 1857, he attained the rank of Associate of the Royal

Academy, and the following year exhibited a most powerful picture of 'Spanish Contrabandistas,' which was purchased by the late Prince Consort, of whom he also painted a portrait the same year for the town-hall of his native city. In 1859, he received the full honour of Royal Academician. His work for exhibition in 1860 was certainly the most difficult he had yet tried, and his success was proportionably great. 'The Marriage of the Princess Royal' was pronounced by both his fellow-artists and the public as a decided success. His next portrait subject (exhibited 1863) was, if possible, a still more difficult task, being the 'House of Commons,' 1860, containing upwards of thirty portraits of the leading members of both sides of the House; in it he was equally successful. However much he excels in portraiture, his heart is more in his Spanish subjects, of which he is understood to have in progress more works (the fruits of his last two visits to Spain) than he can finish in several years.

The characteristics of Mr P.'s style are rich powerful colour, broad light and shade, strong bold outline, and great variety and truthfulness of texture; there is no living artist who has more power over his brush, or whose example has produced a greater effect on the colorists of the present British school.

PHILO JUDÆUS, the *Philosopher* (there being another Jewish Greek writer of this name), was born at Alexandria, about the time of the birth of Christ. Belonging to one of the most wealthy and aristocratic families—his brother was the Alabarch Alexander—he received the most liberal education; and, impelled by a rare zeal for learning, he, at a very early age, had passed the ordinary course of Greek studies which were deemed necessary for one of his station. Although every one of the different free sciences and arts included in the *Encyclica*, he says, attracted him like so many beautiful slaves, he yet aimed higher, to embrace the mistress of them all—Philosophy. Metaphysical investigation was the only thing which, according to his own confession, could give him anything like satisfaction or pleasure. The extraordinary brilliancy of his style, which, by his contemporaries, was likened to that of Plato—his rare power of thought and imagination, and an erudition which displayed the most astonishing familiarity with all the works of the classical Greek poets and philosophers, while at the same time it made him an adept in the fields of history, geography, mathematics, astronomy, physiology, natural history, music, &c.—could not but be of vast influence both upon his co-religionists and those beyond the pale of his ancestral creed. He had completely mastered the literature of his nation; but, strange to say, he chiefly knew it, as far as it was Hebrew, from translations. Thus, the Bible was only familiar to him through the Septuagint version, with all its shortcomings. When about 40 years of age, he went to Rome as the advocate of his Alexandrian brethren, who had refused to worship Caligula in obedience to the imperial edict. He has left an account of this embassy, into the result of which we need not enter here. Of his life we know little except what is recorded above, and that he once went to Jerusalem. His second mission to Rome, to the Emperor Claudius, on which occasion he is said to have made the acquaintance of the Apostle Peter, as reported by Eusebius, is doubtful.

The religious and philosophical system of P., however, which is really the thing of most consequence, is most minutely known, and is deserving of the profoundest study, on account of the vast

influence which it has exercised both on the Jewish and Christian world. To understand his system aright, it will be necessary to remember the strange mental atmosphere of his days, which we have endeavoured briefly to sketch in our introduction to Gnostics (q. v.). The Alexandrines had endeavoured to make Judaism palatable to the refined Greeks, by proving it to be identical with the grandest conceptions of their philosophers and poets, and had quite allegorised away its distinctive characteristics. P. was the first man who, although himself to a great extent imbued with allegorising tendencies, made a bold and successful stand against a like evaporation of the revealed religion of his fathers: which, indeed, in many cases had led people to throw off its yoke also outwardly. A most zealous champion of Judaism, his bitterness in rebuking those co-religionists who tried to defend their secret or overt apostacy by scoffing at the Law itself, who were 'impatient of their religious institutions, ever on the look-out for matter of censure and complaint against the laws of religion, who, in excuse of their ungodliness, thoughtlessly argue all manner of objections'—knows no bounds. He cannot understand how Jews, 'destined by divine authority to be the priests and prophets for all mankind,' could be found so utterly blind to the fact, that that which is the position only of a few disciples of a truly genuine philosophy—viz., the knowledge of the Highest, had by law and custom become the inheritance of every individual of their own people; whose real calling, in fact, it was to invoke the blessing of God on mankind, and who, when they offered up sacrifices 'for the people,' offered them up in reality for all men.

To P., the divinity of the Jewish Law is the basis and test of all true philosophy. Although, like his contemporaries, he holds that the greater part of the Pentateuch, both in its historical and legal portions, may be explained allegorically, nay, goes so far even as to call only the Ten Commandments, the fundamental rules of the Jewish theocracy, direct and immediate revelations, while the other parts of the Book are owing to Moses: he yet holds the latter to be the interpreter specially selected by God, to whose dicta in so far also divine veneration and strict obedience are due; and again, although many explanations of a metaphysical nature could be given to single passages, yet their literal meaning must not be tampered with. This literal meaning, according to him, is the essential part, the other explanations are mere speculation—exactly as the Midrash and some Church Fathers hold. Only that allegorical method differed in so far from that of his contemporaries, that to him these interpretations—for which he did not disdain sometimes even to use the numbers symbolically, or to derive Hebrew words from Greek roots, and the like—were not a mere play of fancy, in which he could exercise his powers of imagination, but, to a certain extent, a reality, an inner necessity. He clung to philosophy, as combined with the Law. If the former could be shewn, somehow or other, to be hinted at in the latter, then only he could be that which all his soul yearned to be—viz., the disciple of both: a Greek, with all the refinement of Greek culture; and a Jew—a faithful, pious, religious Jew. Nay, he even urged the necessity of allegory from the twofold reason of the anthropomorphisms current in Scripture and from certain apparent superfluities, repetitions, and the like, which, in a record that emanated from the Deity, must needs have a special meaning of their own, which required investigation and a peculiar interpretation. See MIDRASH, HAGGADA. Yet this fanciful method never for

one moment interfered with his real object of pointing out how Judaism most plainly and unmistakably was based upon the highest ethical principles.

His writings develop his ideas and his system in the two directions indicated. In that division of his writings principally, which treats of the Creation (*Kosmopoia*), he allows allegory to take the reins out of his hands; in that on the Laws (*Nomoi*), on the other hand, he remains remarkably sober and clear, extolling the Mosaic legislation throughout, at the expense of every other known to him. In a very few instances only he is induced to find fault, or to alter slightly, by way of allegory, the existing ordinances.

His idea of God is a pre-eminently religious, not a philosophical one. He alone is the real Good, the Perfect; the world has only an apparent existence, and is the source of all evil. God is only to be imagined as the primeval light, which cannot be seen by itself, but which may be known from its rays, that fill the whole world. Being infinite and uncreated, He is not to be compared with any created thing. He has therefore no name, and reveals Himself only in designations expressive of this 'inexpressibility.' He is also named the Place (the talmudical *Makom*), because He comprises all space, and there is nothing anywhere besides Him. He is better than Virtue and Knowledge, better than the Beautiful and the Good (*Kalokagathia*), simpler than the One, more blissful than bliss. Thus, He has, properly speaking, no quality, or only negative ones. He is the existing Unity or Existence itself (*Ōn*, or *Ōn*), comprised in the unpronounceable Tetragrammaton. As Creator, God manifests Himself to man, and He is then called 'The Beginning, the Name, the Word, the Primeval Angel.' In this phase of active revelation of God, which is as natural to Him as burning is to the heat, and cold to the snow, we notice two distinct sides, the Power and the Grace, to which correspond the two names of Elohim and Adonai, used in the Bible. The *Power* also gives the laws, and punishes the offender; while the *Grace* is the beneficent, forgiving, merciful quality. Yet, since there is not to be assumed an immediate influence of God upon the world, their respective natures being so different, that a point of contact cannot be found, an intermediate class of beings had to be created to stand between both, through whom He could act in and upon creation—viz., the spiritual world of ideas, which are not only 'Ideals,' or types, in the Platonic sense, but real, active powers, surrounding God like a number of attendant Beings. They are His messengers, who work His will, and by the Greeks are called good demons; by Moses, angels. There are very many different degrees of perfection among them. Some are immediate 'serving angels;' others are the souls of the pious, of the prophets, and the people of Israel, who rise higher up to the Deity; others, again, are the heads and chief representatives of the different nations, such as Israel does not need, since they conceive and acknowledge the Everlasting Head of all beings, Himself. The *Logos* comprises all these intermediate spiritual powers in His own essence. See article *Logos* for P.'s views on this part of his system. Man is a microcosm, a little world in himself, a creation of *Logos*, through whom he participates in the Deity, or, as Scripture has it, 'he is created in the image of God.' He stands between the higher and lower beings—in the middle of creation. The ethical principles of Stoicism, P. identified with the Mosaic ethics, in which the ideal is most exalted moral perfectibility or sanctity, and man's duties consist in veneration of God, and love and righteousness towards fellow men. P.

holds firmly the belief in immortality. Man is immortal by his heavenly nature; but 'as there are degrees in his divine nature, so there are degrees in his immortality, which only then deserves this name when it has been acquired by an eminence of virtue. There is a vast difference between the mere living after death, which is common to all mankind, and the future existence of the perfect ones. Future recompense and punishment are not taken by him in the ordinary sense of the word. Virtue and sin both have all their rewards within themselves; but the soul, which is 'pre-existing,' having finished its course in the sublunar world, carries this consciousness with it in a more intense and exalted manner. Paradise is Oneness with God; there is no hell with bodily punishments for souls without a body, and no Devil in the Philonic system.—Philo's Messianic notions are vague in the extreme, and he partly even interprets certain scriptural passages alluding to some future Redeemer as referring to the soul. Yet he indicates his belief in a distant time when some hero will arise out of the midst of the nation, who will gather all the dispersed together; and these, purified by long punishments, will henceforth form a happy, sinless, most prosperous community, to which all the other nations will be eager to belong.

We have only been able to indicate, in the slightest of outlines, the principal features of P.'s theology and philosophy, without endeavouring to follow any one of the manifold systematic schemes into which his scattered half-obscure dicta have been pressed. The influence P. has exercised upon Christianity and Judaism (in the later writings of which his name occurs as 'Yedidyah the Alexandrine') is enormous, and the various articles in the course of this work (GNOSTICISM, JEWS, LOGOS, &c.) dwell more or less upon this point. What he has done for the development of Philosophy, is discussed under that head, and in the articles PLATO, NEO-PLATONISM, &c. Of the many works left under his name, several have been declared spurious, but in some cases, without much show of reason. His writings are generally brought under three chief divisions, the first of which comprises those of a more general and metaphysical nature, such as, *De Mundi Incorruptibilitate, Quod Omnis Probus Liber, De Vita Contemplativa*. The second contains those written in defence of his compatriots, *Adversus Flaccum, Legatio ad Caium, De Nobilitate*. The third and most important is devoted to the interpretation and explanation of Scripture in the philosophical manner indicated, *De Mundi Opificio, Legis Allegoriarum Libri III.*; containing also a number of special treatises, *De Circumcisione, De Monarchia, De Præmiis Sacerdotum, De Posteritate Caini, De Cherubim, &c.*; five books *On the History of Abraham, De Josepho, Vita Moysis, De Caritate, De Penitentia, &c.*; to which also belong *De Parentibus Colendis, De Virtute eiusque Partibus*, first published by A. Mai; and certain very doubtful fragments, first discovered in an Armenian translation, such as *De Providentiâ* and *De Animalibus, &c.* Many of his works, however, seem irredeemably lost. The *editio princeps* by Turnebus, dates Paris, 1552; reprinted Geneva, 1613; Paris, 1640; &c. Mangey published a more critical edition (Lond. 1742, 2 vols. fol.), and Richter a slightly improved one (Leip. 1828—1830, 8 vols.). An edition of Pfeiffer (1785, &c.) remained incomplete. Another edition was published by Tauchnitz (1851, &c.). As yet, there are several codd. in the Escurial, in Rome, in St Petersburg, which have never been collated, and which promise, to judge from the few readings known, to furnish an immense



## PHILOLOGY.

help for that really critical edition, which as yet is a desideratum.—Of the scholars who have written on P., we mention principally Dahl, Bryant, Gfrörer, Creuzer, Grosmann, Wolff, Ritter, Beer, &c. The English translation of P. in 4 vols., forms part of Bohn's *Ecclesiastical Library*.

**PHILO'LOGY.** This word, as a technical name for a branch of knowledge, has gone through various phases of meaning. Originally signifying the love of talk or discourse, and then, in a more restricted sense, the love of philosophical conversation such as is exhibited in the dialogues of Plato, it came, in the later period of Greek literature, to mean the study and knowledge of books, and of the history and other science contained in them. In this sense it passed over to the Romans, under whom the name of philologists was applied to men distinguished for universal learning, more especially to the *grammatici*, whose chief occupation of editing and illustrating the classic poets, naturally led them to this multifarious knowledge; and when Martianus Capella (q. v.) in the 5th c. composed his *Encyclopaedia* (q. v.) or curriculum of education, embracing the 'seven liberal arts' (Grammar, Dialectic, Rhetoric, Music, Arithmetic, Geometry, and Astronomy), he designates the collective whole by the name of philology. What is known as the Revival of Literature after the dark ages, is nothing else than the revival of the ancient philology. But when men, instead of looking only at what had been written, began to examine the world for themselves, and enlarge the bounds of science, it became impossible for one man to cultivate the whole round of knowledge, and the term philology was by degrees restricted to a knowledge of the languages, history, laws, &c. of the ancient world (by which the Greek and Roman world was chiefly thought of), or, more narrowly still, to the study merely of the languages—of grammar, criticism, and interpretation. A more complete conception of philology, as an independent branch of knowledge, was that of F. A. Wolf, who assigned as its field all that belongs to the life of the ancient peoples; and the conception is still further extended by Böckh, who makes it almost synonymous with history—its problem being the reproduction of the past; in this sense, the word is applicable to all peoples at all periods of their history, so that we are beginning to have an Indian philology, a German philology, a Slavic philology, no less than a classic philology. The fullest and most systematic exposition of what philology in this sense ought to embrace, has been given by G. Haase in Ersch and Grüber's *Ency.*, 3d sect., vol. xxiii.

Of philology, even in its widest sense, the study of language was always, and necessarily, a fundamental part; and, in the usual sense of the word, it has been the chief part—often nearly the whole. For a long time after the revival of learning, the classic writers were studied chiefly for their language and style, and those of them that did not come up to an imaginary standard of purity were despised and neglected, however valuable they might be for their matter. But although great and even undue attention was thus given to language, it was only as an instrument, as means to an end. The philologist studied a language in order to be able to understand it and use it—to get at the thoughts conveyed in it, or to convey his own thoughts with force and elegance to others. This is the object of the grammars, dictionaries, annotated editions, and criticisms, which constitute the chief part of philological literature. But within recent years, philology has entered upon a new phase, or rather a new study has sprung up alongside of the old. As the naturalist investigates a class of objects not with a view to turn them to use, but to understand

their nature, and classify them; so the new school of philologists examine and compare the structures of the various languages, and arrange them in classes and families, with the ultimate view of arriving at some theory of language in general—its mode of origin and growth. The comparison of the structure of two or more languages is called Comparative Grammar, and the whole of this new branch of study is sometimes designated as Comparative Philology; but it seems better to leave the old field in possession of the old name, and in contradistinction to philology as the practical knowledge of languages, to speak of the study of language as a phenomenon *per se*, as the Science of Language. The German term *Sprachenkunde*, and the French *Linguistique*, have more especial reference to the naturalist, or classificatory aspect of the study.

So long as the view prevailed that language was a human invention, anything like a science of it was impossible. According to that view, which was early started, and was especially elaborated and discussed by Locke, Adam Smith, and Dugald Stewart, it was only after men found that their rapidly increasing ideas could be no longer conveyed by gestures of the body and changes of the countenance, that they set about inventing a set of artificial vocal signs, the meaning of which was fixed by mutual agreement. On this theory, there might be a history of the subsequent course of the different languages, but inquiries into the nature and laws of language after the manner of the physical sciences would be absurd. In opposition to the philosophers who attributed the origin of language to human invention, some theologians claimed a divine origin for it, representing the Deity as having created the names of things, and directly taught them to Adam. Both these theories may now be considered as given up by all who are entitled to speak on the subject. Everything, in fact, tends to shew that language is a spontaneous product of human nature—a necessary result of man's physical and mental constitution (including his social instincts), as natural to him as to walk, eat, or sleep, and as independent of his will as his stature or the colour of his hair.

Language was an object of speculation among the Greek philosophers; but as was the case with their inquiries into the outward world generally, they began at the wrong end; they speculated on the origin of things before they had examined the things themselves. They knew no language but their own, and all others were indiscriminately classed as 'barbarous' or foreign; they had no test of affinity among tongues except mutual intelligibility. The theories of the modern philosophers of the 18th c. were nearly as baseless; they were mere *a priori* speculations, akin to Burnet's (q. v.) 'theory of the earth,' which was constructed before the strata of the earth's crust had been explored. The great obstruction to the true course of inquiry was the assumption, first made by the Church Fathers, and for a long time unquestioned, that Hebrew was the primitive language of man, and that therefore all languages must be derived from Hebrew. A prodigious amount of learning and labour was wasted during the 17th and 18th centuries, in trying to trace this imaginary connection. Leibnitz was the first to set aside this notion, and to establish the principle that the study of languages must be conducted in the same way as that of the exact sciences, by first collecting as many facts as possible, and then proceeding by inductive reasoning. It was owing to his appeals and exertions that missionaries, travellers, and others, now began making those collections of vocabularies and specimens of languages and dialects which form the *Herbarium*,

as it were, of human speech. A valuable Catalogue of Languages in six volumes was published in Spanish in 1800, by Hervas, a Jesuit missionary. It contains specimens and notices of more than 300 languages, and many of the true affinities are happily traced. A similar work was Adlung's *Mithridates* (4 vols. Berlin, 1806—1817), based on the catalogue of Hervas, and also on the collections which the Russian government had caused to be made. In none of these efforts, however, although much truth was struck out, were there anything like fixed principles of scientific classification. The light that brought order into the chaos rose with the study of Sanscrit (q. v.), first made accessible to European scholars by Sir William Jones, Colebrooke, and other members of the Asiatic Society, founded in Calcutta in 1784. The similarity of Sanscrit to Greek and Latin, especially in the grammatical forms, struck every one with surprise. Sir William Jones declared that 'no philologist could examine the Sanscrit, Greek, and Latin without believing them to have sprung from the same source, which perhaps no longer exists. There is a similar reason, though not quite so forcible, for supposing that both the Gothic and the Celtic had the same origin with the Sanscrit. The old Persian may be added to the same family.' Rather than admit this relation, which it was seen would involve also ethnological affinities, some, as Dugald Stewart, denied that Sanscrit had ever been the language of a people, and held that it was an invention of the Brahmans, who had constructed it on the model of the Greek and Latin. Fr. Schlegel's work, *On the Language and Wisdom of the Indians* (1808), although defective and erroneous in point of scholarship, has the merit of boldly embracing the languages of India, Persia, and Europe in one family group, by the comprehensive name of Indo-Germanic. It was this work that called the attention of German scholars to a field of labour which they have since made specially their own.

The successive publications of Bopp (q. v.), beginning in 1816, and culminating in his great work on the grammar of the Aryan languages, *Vergleichende Grammatik* (Berl. 1833—1852; a 2d ed. recast and enlarged, 3 vols., Berl. 1857; an English translation of 1st ed. was published in 3 vols., 1845—1850, and, revised, in 1854), created the new science of Comparative Grammar, and laid a sure and broad foundation for the science of language generally. Concurrent with the labours of Bopp, were those of Pott in his *Etymological Researches* (*Etymologische Forschungen*, 2 vols., 1833—1836; 2d ed. 1859) and other works. Not less important, though confined to one stock of the Aryan family, the Teutonic, was the great German Grammar (*Deutsche Grammatik*, 4 vols. 1818—1837) of J. Grimm (q. v.). William von Humboldt (q. v.) did much to establish a philosophy of language—the relations and interactions of mind and speech; a department of the subject which has been further cultivated in recent years by Steinthal. The method of investigation, thus invented and perfected in the field of the Aryan tongues, has been applied to other languages, and considerable progress has been made in grouping the principal varieties of human speech into families, which again fall into subdivisions or branches, according to the different degrees of nearness in the relationship. In establishing these relationships, although a comparison of the vocabularies—the numerals, pronouns, and more essential nouns and verbs—may establish a general affinity, and render a common origin probable; yet the surer test lies in the grammatical forms. For when those elements of a language which express the relations of things—case, number, tense—have

once become mere terminations, and lost their original form and independent meaning, they can only be transmitted by tradition; and when the same grammatical forms are found possessed in common by two or more tongues, they must be an inheritance from a common ancestor. It follows from this that the 'genealogical' classification, as it is called, cannot be carried out with great surety or rigour except in the case of languages in which grammatical forms had become in some degree fixed before their divergence—in other words, of the inflectional languages. Accordingly, the only two well-defined genealogical families are the Aryan and the Semitic, which embrace the whole of the languages of the inflectional type.

Besides the division of languages into families bearing traces of a common origin, there is a division into three orders, as they may be called, depending upon a radical difference of structure. Speech, as the expression of thought, contains two elements: ideas or conceptions, which constitute the substance or material part; and the relations of these ideas to one another, which constitute the formal part; and the nature of a language depends upon the particular way in which the vocal expression of these two elements is combined. At the foundation of all words lie Roots (q. v.), or simple sounds expressive of meaning. Now, some languages, as the Chinese (q. v.), use these roots in their naked form as words, the same syllable, according to its position, serving as noun, adjective, verb, &c.—e. g., *ta* means great, greatness, to be or to make great, greatly or very. The relational part of the thought, for the most part, gets no vocal expression, it is only indicated by position, as when *min*, people, and *li*, power, are simply put together (*min li*) to signify the people's power. Relations not readily indicated by position are expressed in a round-about way by using additional significant words: thus, *tachung* (mass or multitude) *jin* (man) = men; *niu* (woman) *tsè* (child) = daughter; *ÿ min li* (employ people power) = with the people's power. Even in such cases, each root preserves its independence, and is felt to express its own radical meaning. Languages like the Chinese, whose development has been arrested at this rudimentary stage, are called *Monosyllabic* or *Isolating*.

The next stage of development is that of the *Agglutinate* languages, which are by far the most numerous, including the Turanian and American families. In these, the relational part of thought obtains prominent vocal expression by separate roots joined or *glued* on to the significant roots as terminations. These terminations were originally themselves significant roots, and many of them are still used as separate significant words, although the greater part have sunk down to mere signs of cases and other relations. The compound expression thus formed never, however, attains perfect unity; the significant root always remains rigid, unobscured in its sense and unchanged in form, and the termination is felt as something distinct from the body of the word.

Thus, the Finnish declension exhibits a structure of the most mechanical and transparent kind—e. g., *karhu*, bear; *karhu-n*, of the bear; *karhut-to*, without bear; *karhu-sta*, out of the bear; and so on through fifteen cases. The insertion of the plural suffix, *i*, gives *karhu-i-n*, of the bears; *karhu-i-ta*, without bears; *karhu-i-sta*, out of the bears; &c. But this composite mechanical structure reaches its climax—remaining all the while perfectly transparent—in the Turkish verb. Thus, the root *sev* has the indefinite meaning of loving, and the inf. is *sev-mek*, to love; which then, by the insertion of certain suffixes, can take on as many as forty forms or voices—e. g., *sev-me-mek*, not to love; *sev-e-me-mek*

not to be able to love; *sev-dir-mek*, to cause to love; *sev-dir-ish-mek*, to cause one another to love; *sev-il-mek*, to be loved; *sev-ile-me-mek*, not to be able to be loved; &c. Each of these forms, then, runs through a large round of tenses and moods, with their persons and numbers.

The languages of the American Indians are all of this agglutinating type, although they have also got the name Incorporative, or Intercalative, because they run a whole phrase or sentence into one word—e. g., *hoponi*, to wash; *hopocuni*, to wash hands; *hopoaduni*, to wash feet; *ninacaqua*, I (ni) eat (*qua*) fish (*naca*). The Basque language partakes of this character.

It is only in the third or *Inflectional* stage that perfect unity of the two elements is attained. In the Aryan and Semitic tongues, which alone have reached this highest state of development, the significant root and the termination have become blended into one both in effect and form, and phonetic changes have for the most part obliterated the traces of composition. Yet no doubt is felt by philologists that the most highly organised of the inflecting or amalgamating languages began with the radical stage, and passed through the agglutinata. The analytic powers of comparative grammar have succeeded in tracing back the formal elements of the Aryan tongues to original independent words, agglutinated to other words to modify them. See INFLECTION. Against this theory it has been urged, that there is no historical instance of a language so changing its type, and passing from one stage to another. But a sufficient account of this phenomenon may be found in the different mental habits and political positions of the peoples (see Max Müller, *Lectures on the Science of Language*, First Series, page 316). Besides, the languages of the lower types do shew a tendency, under favourable circumstances, to produce grammatical forms of the higher kind. Even in Chinese, in some of its modern dialects, something like cases is to be seen; and Finnish and Turkish, in contact with the inflected languages of Europe, are making approaches to the inflectional type.

On the other hand, the inflectional languages had, before the earliest times of which we have any written monuments, entered on the reverse phase—the *analytic*. By the process of phonetic change and decay, the grammatical forms have been gradually becoming obliterated and losing their power, and their place has been supplied by separate words, in the shape of prepositions and auxiliary verbs. See INFLECTION.

Connected with these radical differences of type, is one of the higher and more speculative problems of the science—the question as to the common origin of all languages. The inherent and apparently inefaceable difference of structure in the three orders above described, as well as the absence of all sure marks of genealogical affinity even between the two families of the inflectional type, the Aryan and the Semitic, are considered by some as insuperable objections to the theory of a common origin. But although it may be fruitless to look for extensive identifications of the roots and grammatical forms of the Aryan tongues, even in the oldest forms to which we can trace them, with those of the Semitic, still more with Chinese or Turkish elements; it seems rash and unscientific to affirm that, going back to the radical stage, the development of all could not have begun from a common stock of monosyllabic roots. The wonderful transformations exhibited by language in the course of its known history, seem sufficient ground for maintaining the *possibility* of a common origin. On the other hand, the nature of the case forbids all hope

of ever being able to *prove* it; for the coincidences that occur (e. g., Chinese *fa*, Tibetan *pha*, Lat and Gr. *pa-ter*, Eng. *fa-ther*; Chin. *mu*, Egyp. *mu*, Lat and Gr. *ma-ter*, Eng. *mo-ther*), even though they were much more numerous than they are, might well arise from the mind and vocal organs of man being everywhere essentially the same.

Languages, like living organisms, are in a state of continual flux or change, and an essential part of the science consists in investigating the laws according to which these changes take place. It is because there are such laws that a science of language is possible. In tracing words to their origin, and identifying them with words in other languages, we are no longer guided by mere similarity of sound, on the contrary, identity of sound is often a proof that a proposed etymology is wrong. It has been established, for instance, by induction (see GRAMM'S LAW), that *c* in Latin is regularly represented by *h* in Gothic and English; while for Gothic or English *c*, the corresponding letter in Latin is *g*. Accordingly, we readily recognise Latin *corn-u* and English *horn* as cognate words; while a suggestion to connect the English *corn* with *cornu*, is immediately rejected. If *corn* has a representative in Latin, it must begin with *g*, which points out *granum* as the word. *Grain* is not the English representative of *granum*; it is *granum*, borrowed from the Latin through the French. The expert etymologist can often identify with certainty two words, although not a letter remains the same. In simple cases, this is done by every one. Who, for instance, doubts that Aberdeenshire *fa*, *filk*, are merely dialectic varieties of Eng. *who*, *which*. Yet the same persons who readily admit such cases, are sceptical when it is proposed, for instance, to identify Fr. *larme*, with Eng. *tear*. The grounds of identification, however, are similar in both instances; the only difference being, that with regard to *larme* and *tear*, they require to be traced historically. No one will dispute that *larme* is a corruption of Lat. *lacrima*; in fact, it can be followed through the successive stages of change. Now we know that the Romans had a peculiarity of letting *d* in some positions degenerate into *l*. Nor is this unaccountable, when we consider that the contact of organs which produces *d*, differs from that which produces *l*, chiefly in being more energetic; a slovenly *d* slides into *l*. Thus the Greek name, Odysseus, became, in the mouth of the Romans, Ulysses; they said *odor* (a smell), but *oleo* (I smell); and, instead of *impedimentum*, *dedicare*, we sometimes find *impelimentum*, *delicare*. These and other instances would warrant us to conclude that *lacri-ma* was a corruption of *dacri-ma* (corresponding to Gr. *dakru*), even if we had not the express statement of Festus that *dacrima* was the older form. After this there is no difficulty in recognising *dacri*, or *dakru*, as identical with Gothic *taqr*, Eng. *tear*.

In order to give a rational account of the phonetic changes now exemplified, the nature of articulate sounds, and of the organs that produce them, must be carefully investigated. The most valuable contributions, in English, to this important preliminary branch of the study (called *Phonetics*), are those of Mr Alex. J. Ellis. See PHONETIC WRITING. An admirable *résumé* of the subject, with diagrams of the organs of voice in the position of pronouncing the different articulations, is given in the second series of Max Müller's *Lectures on the Science of Language* (1864), where the best recent works on phonetics are noted.

The transformations that words exhibit, as they are traced down the stream of history, are of the nature of phonetic decay, and are due to a natural

tendency to economise muscular energy by pronouncing two syllables in one. The dropping of inflections, the shortening of words by internal elision and otherwise (Fr. *père*, from Lat. *pater*; Eng. *fair*, from A. S. *fæger*; *stranger*, from old Fr. *estrangier*, Lat. *extraneus*), are all owing to the action of this force, and the uniformities observable among such changes, can be explained on physiological principles. Dialectic diversification is not so easily accounted for; it is difficult to say why sister nations—as in the case of the Aryan family, or of the nations speaking Romanic tongues—should have given such different forms to the same stock of primitive roots; why, e. g., Gr. *penite* (*Æol. pēmpel, pepo*, should be in Lat. *quintus, coquo*. Max Müller thinks it necessary to go back to a time when many of the articulations were not yet sharply defined; and he appeals, in illustration, to the confusion children make between such sounds as *tut* and *cat*; and, what is still more in point, to the analogy presented by languages like the Polynesian. In the language of the Sandwich Islands, the two consonants, *k* and *t*, run into one another, 'and it seems impossible for a foreigner to say whether what he hears is a guttural or a dental. The same word is written by Protestant missionaries with *k*, by French with *t*. It takes months of patient labour to teach a Hawaiian youth the difference between *k* and *t*, *g* and *d*, *l* and *r*. . . . If colonies started to-morrow from the Hawaiian Islands, the same which took place thousands of years ago, when the Hindus, the Greeks, and Romans left their common home (see ARYAN), would take place again. One colony would elaborate the indistinct, half-guttural, half-dental contact into a pure guttural; another, into a pure dental; a third, into a labial.' Much light is thrown on this question by those phonetic peculiarities—those deficiencies and predilections of articulation which characterise whole tribes and nations, as they often do individuals. They may have originated, perhaps, in the idiosyncrasies of individual ancestors (a lisping patriarch might produce a tribe of lispers, without their inheriting the physical defect which caused the lisp in him), or in a common habit of the organs of speech produced by external circumstances; but once established, they are very persistent and influential. The Mohawks, and several other American tribes, have no *p*, *b*, *m*, *f*, *v*, or *w*; they never articulate with their lips. In Chinese, there is no *d*; *r* is also wanting; and as the habit of the language requires a vowel after every consonant, the nearest approach they can make to the sound of *Christ* is *Ki-li-se-tu*. An analogous habit of articulation transforms the English word *gold* in the mouth of a Kafir into *i-go-li-de*. On this principle can be explained the Fr. *espérer*, from Lat. *sperare*; *établir* or *étudier*, from *stabilire*; *école* (*escole*), from *schola*, &c. In the Celtic tongue, an initial *s* with a consonant after it was an unwonted combination; when it would have occurred, a vowel was always prefixed; and, on adopting the Latin language, the Celtic peoples carried their old habit of pronunciation with them. The effects upon a language of thus coming in contact with another, are important elements in its history. See ENGLISH LANGUAGE AND LITERATURE.

The positive part of the science of language having pushed inquiry back until it arrives at monosyllabic roots that admit of no further analysis, there stops, as at the legitimate boundary of its province. It assumes the existence of a certain store of crude or primary matter, and merely concerns itself with how out of this matter the structure,

as we know it, has been built or has grown up. But a question yet remains, which, although it can never receive but a conjectural answer, has a wonderful fascination for the speculative mind, and was, in fact, the question with which all inquiries into language began; the question, namely: How did language take a beginning at all? how came this primitive material of language, these significant roots, into existence? The answer may be thus conceived: To speak is a necessity of man's rational and emotional nature; he speaks because he thinks and feels. When the mind receives an impression or intuition, by an instinctive impulse, of the nature of reflex action, some outward expression—a gesture or vocal sound—breaks forth, which by association becomes a sign or symbol, to the individual and to his associates, of the impression or idea that gave it birth. Associated at first with individual impressions and objects, these sounds, by the process of abstraction, which is pre-eminently a human faculty, would gradually come to represent more generalised impressions—would become words, as distinguished from mere animal sounds. The necessity of words to think in is much insisted on by speculators on this subject, as being the motive-power in the generation of language; and no doubt it is true that, without language, thought could advance but little, if at all, beyond what is manifested by the brutes. But when they argue as if this necessity of having his ideas objectively depicted, in order to exercise his own reason, would impel an individual man to construct a language for his own use, they make the unwarranted assumption that, under any circumstances, even though he grew up from infancy in solitude, the thinking powers of a human being must necessarily develop themselves. The necessarily few facts that bear on the case look the other way. Kaspar Hauser (q. v.), instead of elaborating a system of symbols of thought for himself, had forgotten what he had once possessed; his faculties of thought and of speech seem to have been simultaneously arrested. Observation seems to favour the opinion, that man in solitude—if he could exist in solitude—would be as mute as the lower animals. The social nature of man helped to give birth to the germs of speech, no less than his rational nature; an instinctive desire to give a sensible sign of his impressions to his fellows, was perhaps the primary impulse; the aid thus given to his own thinking powers, a secondary result. Be this as it may, it seems reasonable to assume, as it has been well put by Steinthal, that 'at the origin of humanity, the soul and the body were in such mutual dependence, that all the emotions of the soul had their echo in the body, principally in the organs of respiration and the voice. This sympathy of soul and body, still found in the infant and the savage, was intimate and fruitful in the primitive man; each intuition woke in him an accent or a sound.'—Farrar, *Origin of Lang.*

Were these sounds, then, guided by chance or caprice? or if not, what determined particular articulations to be associated with particular objects or ideas? Any mystic innate correspondence between sounds and things, is out of the question; but what more reasonable than to suppose that the natural sounds emitted by so many things, animate and inanimate, should suggest the character of the articulations which the ideas of the things called forth—not so as to produce exact imitations, which it is not of the nature of articulate sounds to be, but such resemblances as would suffice for association. See ONOMATOPEIA. In the case of ideas unconnected with any natural sound, names would readily be suggested in many cases by analogies, real or fancied, with things that were attended by

sounds. We can see, again, a physiological fitness in the articulation *etc.*, to stand; with the idea of stability, still more with the attitude, the organs involuntarily assume the position with which this syllable is emitted. Similar instances might be multiplied. We are not to suppose that the same thing would suggest the same sound to all, or even to the same individual at all times. The language-making faculty in the flush of its spring would throw out a multitude of names for the same thing (synonyms), as well as apply the same name to many different things (homonyms); but by a process of natural elimination, those only would survive that were felt best to answer the purposes of speech. The abstracting faculty would also soon dissociate them from the concrete individual objects that first suggested them, and convert them into symbols of the prominent attributes of whole classes. It is these generalised names, syllables significant of such general simple notions as seeing, moving, running, shining, striking, cutting, or being sharp, that, by a kind of inverse process, became the roots of language as it now exists. A syllable expressive of a single prominent attribute forms the foundation of the names of a whole class of objects, the specific differences being marked by other significant syllables joined on to it. See **ROOTS**. In some such way, by the unconscious working of man's intellectual nature, we may conceive language to have grown out of the exclamatory or interjectional stage into the rational structure that we now admire. This theory of the origin of roots, together with the constant operation of phonetic change, accounts for the absence of all traces of onomatopoeia in the great bulk of the words of a language, and seems to meet the objections of Max Müller and other philologists to the onomatopoeic theory.

With regard to these primary or radical words it is only necessary to observe here that they are all significant of sensible or physical ideas, and expressions for immaterial conceptions are derived from them by metaphor. How, from a comparatively few roots of this kind, the vocabulary of the richest language may grow, is further illustrated in the article **ROOT**.

Another speculative question regards the length of time that language must have taken to advance from the rudimentary stage to the state in which it is found in the earliest records. Bunsen assigns 20,000 years as the lowest limit; but it is evident that the same uncertainty must always rest on this question as on the corresponding one in geology.

Separate points of philology will be found treated under a variety of heads. See—besides the articles already referred to—**ALPHABET**; the several letters, **A, B, &c.**; **GENITIVE**; **NOUN**; **ADVERB**; **PRONOUN**; **DIALECT**; **PERSIAN LANGUAGE AND LITERATURE**; **SEMITIC LANGUAGES**; &c.

The literature of the new science of language is already rich; but much of it is scattered through the transactions of societies and periodicals. Of separate works of a comprehensive kind, in addition to those already named, we may mention, in German, Schleicher, *Die Sprachen Europas* (Bonn, 1850), and *Vergleichende Grammatik der Indo-Ger. Sprachen* (2 vols. Weimar, 1861); J. Grimm, *Ueber den Ursprung der Sprache* (Ber. 1852); Diez, *Etymol. Wörterbuch der Romanischen Sprachen* (2d ed. Bonn, 1861), and *Vergleichende Grammatik der Romanischen Sprachen* (3 vols. Bonn, 1836—1842); translations of both works into English have been published by Williams and Norgate (1864). Heyse, *System der Sprachwissenschaft* (Ber. 1856); Steinthal, *Die Classification der Sprachen* (Ber. 1856); and *Der Ursprung der Sprache* (Ber. 1851). In French,

Renan, *Histoire Générale et Système comparé des Langues Semitiques* (3d ed. Paris, 1863); and *De l'Origine du Langage* (3d ed. Paris, 1863); Pictet, *Les Origines Indo-Européennes* (Paris, 1859).

English scholars were late in entering this field of research. Horne Tooke's (q. v.) *Diversions of Purley*, though a work of genius, and though it has been the means of first awakening in many an interest in the nature of language, was written without sufficient acquaintance with the kindred tongues, and before the true key to the inquiry had been obtained, and therefore few of the results can now be accepted. Among the first important contributions were Prichard's *Eastern Origin of the Celtic Nations* (Oxf. 1831), and the contributions of the Rev. Richard Garnett to the *Quarterly Review* in 1835—1848. Mr Garnett's essays in the *Quarterly*, and his subsequent papers printed in the proceedings of the London Philological Society (in the formation of which, in 1842, he took an active part), have been reprinted under the title of *Philological Essays* (Williams and Norgate, 1859), and are models of linguistic research. The philological articles of the *Penny Cyclopædia* also contributed to popularise the study in England. Of substantive works, the most important, though bearing more directly on the Greek and Latin tongues, are *The New Cratylus* (1839, 3d ed. 1859), and the *Varronianus* (1844) of J. W. Donaldson (q. v.). Winning's *Manual of Comparative Philology* (1838) had previously given a popular sketch of the affinities of the Aryan languages. Latham's *English Language* (1841—several new editions) treats its subject from the historic-comparative point of view, and therefore comes in some degree within our scope. A valuable work of the same kind is Marsh's *Lectures on the English Language* (New York, 1860). Latham's *Elements of Comparative Philology* (1862) gives an elaborate classification of the languages of the world, with numerous specimens; only a small part of the work (56 pages out of 752) is given to the general principles of the science. Farrar, *On the Origin of Language* (1860), chiefly deals with the speculative part of the subject; he brings within small compass the views of the leading investigators on the more interesting points. But above all, the writings of Max Müller (*Comparative Mythology*, in the *Oxford Essays*, 1856; *Lectures on the Science of Language*, 1861; Second Series, 1864) have contributed to make the study of this science take root in Britain.

On the principles of classification above sketched, the chief languages of the earth may be thus arranged:

I. *Mono-syllabic or Isolating*.—1. Chinese, the typical language of this order. 2. Tibetan, which shows some beginnings of grammatical forms. 3. The languages of the Eastern Peninsula—Siamese, Anamese, Burman. Japanese and the language of Corea are doubtful.

II. *Agglutinate*.—1. The most important division of this order is the Turanian family, comprising 'all languages spoken in Asia and Europe (including Oceania), and not included under the Aryan and Semitic families, with the exception of Chinese and its cognate dialects.' For the subdivisions of this family, see **TRUNIAN LANGUAGES**. 2. *African Languages*.—Some of the languages of Africa are allied to the Semitic family, and were introduced by immigration, such as the dialect of Tigré in Abyssinia (see **ETHIOPIA**), and the Arabic dialects spoken by the Mohammedan population of the coasts, and which have even penetrated deep into the interior. How far the Berber dialects are of Semitic character, is a disputed question; and the same is the case with the language of the Gallas or

PHILOLOGY.

Abyssinia. Little has as yet been done in investigating and classifying the native Agglutinate languages of Africa, which have been designated by the common name of Hamitic. The ancient Egyptian, from which the modern Coptic is derived, would seem never to have got beyond the isolating stage (see **HIEROGLYPHICS**). Some of the languages adjoining Egypt are thought to be allied to the Coptic. The negro languages, properly so called, of the Sudan, and of the west coast from the Senegal to the Niger, are exceedingly numerous and widely diverse. The languages to the south of the equator are markedly different from those to the north. They fall, according to some, into two great families, the Congo family on the west, and the Kafir family on the east. The Hottentot language is distinct from both. A valuable contribution has recently been made to the study of part of the field by

Bleek's *Comparative Grammar of the South African Languages* (1862). 3. *The Languages of the American Indians*.—The native languages of the New World are numbered by many hundreds, all differing totally in their vocabulary, but still agreeing in the peculiar grammatical structure which has given the name of Incorporative (see above). Their area is fast contracting, and they seem destined to disappear.

III. *Inflectional*.—This order consists of two families, so distinct in their grammatical framework that it is impossible to imagine a language of the one family derived from one of the other. It is the peoples speaking these languages that have been the leaders of civilisation within the historic period. The subdivisions of these families will be best understood from the accompanying tables, taken from Max Müller's Lectures, First Series.

No. I.—GENEALOGICAL TABLE OF THE ARYAN FAMILY OF LANGUAGES.

Living Languages.	Dead Languages.	Branches.	Classes.	
Dialects of India, . . . . .	Prakrit and Pali—Modern Sanscrit.—Vedic Sanscrit		Indie	Southern Division
the Gipsies, . . . . .	Parai—Pehlevi—Cuneiform Inscriptions—Zend			
Persia, . . . . .			Iranic	Southern Division
Afghanistan, . . . . .				
Kurdistan, . . . . .				Iranic
Bokhara, . . . . .				
Armenia, . . . . .	Old Armenian			Iranic
Ossethi, . . . . .				
Wales, . . . . .				Cymric
Brittany, . . . . .				
+ . . . . .				Cymric
Scotland, . . . . .	Cornish			
Ireland, . . . . .				Gadhelic
Man, . . . . .				
Portugal, . . . . .				Celtic
Spain, . . . . .				
Provence, . . . . .				Itallo
France, . . . . .	Langue d'oc	Lingua vulgaris		
Italy, . . . . .	Langue d'oïl			
Walachia, . . . . .		Oscan	Itallo	Itallo
the Gilsons, . . . . .		Latin		
Albania, . . . . .		Umbrian		Illyric
Greece, . . . . .	Koré { Doric—Eolie			Hellenic
	{ Attic—Ionic			
Lithuania, . . . . .	Old Prussian			Lettic
+ . . . . .				
Kurland and Livonia, } (Lettish), . . . . .				Lettic
Bulgaria, . . . . .	Ecclesiastical Slavonic			
Russia (Great, Little, } White Russian), . . . . .				South-East Slavonic
Illyria (Slovenian), } Croatian, Servian), . . . . .				
Poland, . . . . .				West-Slavonic
Bohemian (Slovakian), } Lusatia, . . . . .	Old Bohemian			
Germany, . . . . .	Polabian			West-Slavonic
+ . . . . .				
England, . . . . .	Middle High-German, Old High-German			High-German
Holland, . . . . .				
Friesland, . . . . .	Gothic			Gothic
North of Germany } (Platt-Deutsch), . . . . .	Anglo-Saxon			
Denmark, . . . . .	Old Dutch			Low-German
Sweden, . . . . .	Old Friesian			
Norway, . . . . .	Old Saxon			Teutonic
Joeland, . . . . .	Old Norse			

No. II.—GENEALOGICAL TABLE OF THE SEMITIC FAMILY OF LANGUAGES.

Living Languages.	Dead Languages.	Classes.	
Dialects of Arabic, . . . . .	Ethiopic	Arabic	Southern
Amharic, . . . . .	Himyaritic Inscriptions	Southern	
+ . . . . .			Middle
the Jews, . . . . .	Biblical Hebrew	Hebraic	
+ . . . . .	Samaritan Pentateuch (8d c. A. D.)	or	Middle
+ . . . . .	Carthaginian, Phœnician Inscriptions	Middle	
+ . . . . .	Chaldee (Masora, Talmud, Targum, Biblical Chaldee)	Aramaic	Northern
Nec-Syriac, . . . . .	Syriac (Peshito, 2d c. A. D.)	or	
+ . . . . .	Cuneiform Inscriptions of Babylon and Nineveh	Northern	

**PHILOMELA**, the name of a personage in Greek legend, who was changed according to one account into a swallow, to another into a nightingale. Modern poets are (or rather were, for it was chiefly an 18th c. fashion) fond of calling the nightingale by its classic name.

**PHILOPOMEN**, the most illustrious patriot and general who figures in the later history of Greece, belonged to one of the best families of Arcadia, and was born at Megalopolis about 252 B.C. At an early age he lost his father, and was brought up by a wealthy citizen, named Cleander, who took care that he should receive an excellent education. His earliest experiences of war were confined to the border raids of the Arcadians into Laconia; but in 222 B.C., he was one of the defenders of Megalopolis against Cleomenes, king of Sparta. Next year, when the Macedonian king Antigonus marched to the assistance of the Achæans, P. joined him at the head of 1000 horse, and contributed materially to the terrible defeat which the Spartan king received at Sellasia. As tranquillity was now for a short time restored to Greece, P. went abroad to perfect himself in the art of war, and served in Crete with such distinction, that on his return to the Peloponnesus, in 210, he was appointed general of the Achæan horse, and at once proceeded to discipline his men in a vigorous and masterly style. In the expedition against Elis (209) he slew the Elean leader, Demophantus, with his own hand. In 208 he was raised to the highest military dignity then possible in Greece, being elected *strategus* or commander-in-chief of the Achæan League, and in this capacity signalled himself by the great improvements which he effected in the drill, discipline, and armour of the Achæan soldiery. It seemed as if the ancient heroism of the land were reviving. The battle of Mantinea, which took place in the course of the same year, and in which the Spartans were again utterly routed—their general and king, Machanidas, falling by the sword of P. himself—raised him to the pinnacle of fame, and at the Nemean festival which followed he was proclaimed liberator of Greece. His exalted honours did not in the slightest degree disturb the integrity of his character. So great was his influence over his quarrelsome countrymen, that the Macedonian monarch, Philip, began to fear that Greece would regain its independence, and tried to have him secretly assassinated; but the infamous treachery was discovered in time, and its only effect was to endear P. still more to the Achæans. Another of his determined enemies was Nabis, successor of Machanidas in the 'tyranny' of Sparta, but in 201 he inflicted on the latter a severe defeat at Skotetas on the borders of Laconia. During the next few years he was absent in Crete, partly, it would seem, for political reasons, but returned to the Peloponnesus in 194 to find matters in a serious condition. A new and dreaded power—the Romans—had appeared, and overthrown both Philip and Nabis, and P. foreboded future mischief to all Greece from these ambitious warriors. On the departure of the consul Flaminius, Nabis recommenced hostilities against the Achæans; P. was once more appointed *strategus* (192); and in a pitched battle nearly annihilated the troops of Nabis, who himself was shortly afterwards killed by the Ætolians. He now exerted all his power to heal the divisions among the Achæans, and to prevent them from affording the Romans a pretext for taking away their independence. In 188, he took a fierce revenge on Sparta for having put a number of his friends to death, and was in consequence strongly censured by the Roman senate, and by Q. Cæcilius Metellus, who was sent out as a commissioner to Greece in 185. Two years later P. (now an old man of 70),

was elected *strategus* for the eighth time. When lying ill of a fever at Argos, news was brought to him that the Messenians had broken their connection with the league; P. instantly rose from his sick bed, hastened at the head of some cavalry to quell the revolt, but was overpowered by numbers, and fell into the hands of Deinocrates, the leader of the Messenians, who two nights after sent him a cup of poison, which P. drank off and died. The remains of the hero were brought in solemn procession to his native city—the historian Polybius carrying the urn—and statues were erected to his memory by his grateful and repentant countrymen.

**PHILOSOPHY**. This word meant originally the 'love of knowledge,' and indicated, therefore, a special taste, appetite, or desire, of which the subject-matter was knowledge. At first, man's pursuit of knowledge was subservient to the immediate uses of life; but, in the course of time, an interest was taken in knowing the order of the world, independent of its application to the common utilities. We find that this stage had been reached in Greece especially, about five or six centuries before Christ; at which time the name 'philosophy' took its rise, being attributed to Pythagoras.

The word has had a variety of acceptations, although all pervaded by the one idea of employing the human understanding in the search for increasing knowledge and certainty. It always implies this effort in a distinguished degree, such as only a few persons in any age have ever been able to sustain. The pursuit of knowledge had to become an end in itself, for the mere improvement of practice would not at first have been a sufficient motive for men to undergo the labours of scientific inquiry. Indeed, this improvement was not at all apparent as a consequence of the earliest efforts of speculation. As one celebrated example, the investigation of the properties of the sections of the cone—the ellipse, parabola, and hyperbola—was without any practical use for nearly two thousand years.

As may be readily supposed, the precise aim of philosophy, the statement of what constitutes its end, has varied with the advancement of its study. In modern times, the pursuit of truth has taken a well-defined form, expressed by the name Science (q. v.). But, in the ancient world, this operation was a mixture of speculation, practice, and sentiment—of legitimate inquiry with aspirations after the unattainable; and hence the word 'philosophy,' in its modern employment, often refers to the subjects that have not as yet adopted the strict scientific form. On this view, science is the goal and the grave of philosophy. (See Lewes's *Biographical History of Philosophy*.) It is chiefly with reference to morals, metaphysics, and the human mind generally, that the term is still retained.

The characters that distinguish the highest form of truth are Generality and Certainty or precision; and in proportion as a subject has advanced in these respects, it might be said to have become philosophical, but we now prefer to use the word scientific. The theoretical foundations of a practical subject, as grammar, are sometimes pretentiously called the philosophy of it. So any department of nature or humanity, where explanations by general laws are furnished, is styled 'philosophical'; thus, we have the philosophy of zoology or of history, and a 'philosophical' naturalist or historian.

Again, after definite branches of knowledge have taken a scientific shape, and have been reckoned as distinct 'sciences' (mathematics, &c.) the general principles and views that are supposed to run through the whole, are sometimes called 'philosophy.' This was one of the meanings of the word

## PHILOSOPHY.

in Plato. The great work of Auguste Comte bases its title (*Cours de Philosophie Positive*) upon this consideration.

Professor Ferrier remarks that philosophy is not truth, but 'reasoned truth;' that is, it must be truth presented under the forms and processes that evolve and establish the highest or scientific knowledge. This is merely another mode of stating that philosophy implies a special procedure for attaining truth, the ordinary unregulated operations of the understanding being insufficient.

Among the oldest problems of philosophy, we are to reckon on the attempt to generalise the universe, or to resolve all nature into some great unity, or common substance or principle. Thales considered Water the primordial and fundamental principle. Anaximander adopted as the foundation of the universe something called by him the Infinite or Indeterminate, out of which the various definite substances, air, fire, water, &c., were generated, and to which they were again resolved. Anaximenes assumed Air as the primordial substance, which, by rarefaction, produced fire and ether, and by condensation, water, earth, and stone. These three philosophers all belonged to the Ionic colony of Miletus. Pythagoras was an emigrant from Ionia to Italy; he gave Number as the essence and foundation of all existing things: the different numbers being representative of different natural properties and powers; thus, *five* stood for colour, *six* for life, &c. Xenophanes of Kolophon attacked the popular polytheism, and propounded one great indivisible agency comprehending and identified with the universe, which he would not designate as finite or infinite, in motion or at rest. Parmenides of Elea distinguished between self-existent being, *Eus*, or the absolute, characterised by extension and duration, and phenomenal nature, the region of inferior certainty, or mere opinion. This was the first sketch of what has since been called Ontology, or the science of the *noumenon*, or absolute being. Heraclitus of Ephesus maintained an absolute of a totally different character—a principle of incessant Change, the negation of all substance and stability, a power of perpetual destruction and renovation. Empedocles took his stand upon the Four Elements, out of which all things were constituted by the action of the opposing principles of love, and enmity or discord—a poetical representation of attraction and repulsion. Anaxagoras also treated the world as made up of elements, but indefinite in number. By the attraction of each for its own kind, the primitive chaos was separated, but excepting 'mind,' no element ever was perfectly pure, the character of each substance being determined by the predominance of the proper element. These elements were called the 'homœomeries.' Diogenes of Apollonia, the last of the series called Ionic philosophers, adopted in a modified form the tenet of Anaximenes, that Air was the primordial element. The celebrated Atomic theory originated with Leukippus, but is commonly identified with his pupil Democritus of Abdera. The elements of Anaxagoras were acted on by mind, but with Democritus their activity was inherent in themselves from the beginning.

The grand problem of External Perception (see PERCEPTION) was agitated at an early period, and has been always reckoned a leading question of philosophy. The first attempt at a solution was an application by Democritus of his atomic hypothesis. He supposed that all things were constantly throwing off images of themselves, which enter the soul through the pores of the organs of sense. He was aware that this left us in a state of uncertainty, as to whether the images corresponded to the otherwise unknown originals.

The many difficulties and uncertainties incident to the search for knowledge, could not but be felt by inquirers generally. There was one sect in particular, more especially impressed by this circumstance, and hence called Sceptics, or Doubtters. They were represented in antiquity by Pyrrho. They dwelt on the absence of any sure criterion of truth, and pointed out that what was considered most certain was not free from objections, or counter-arguments.

Philosophical speculation began to take definite shape in the age of Plato and Aristotle, the age of the beginnings of many of the sciences. More especially at this time do we find the distinct enunciation of the Philosophy of Human Life, otherwise called Moral and Ethical Philosophy. The questions concerning the end of life, the pursuit of happiness, and men's duties in various relationships, had been answered by a sort of rule-of-thumb experience, rather than by deep reflection or far-seeing combinations. The distinctions of virtue and vice were determined by political society, and connected more or less with religion. There were tests and maxims of conduct, for the most part merely prudential. The first approach to a moralising strain is found in the poems of Hesiod. He combines a gloomy view of life with much practical wisdom, enjoining justice, energy, temperance, and simplicity of living. The 'Seven Wise Men,' who belonged to the 6th c. B.C., followed in the same course, and uttered a variety of sayings or short maxims, of which the most ordinary subjects were 'the uncertainty of human things, the brevity of life, the unhappiness of the poor, the blessing of friendship, the sanctity of an oath, the force of necessity,' &c., together with the simple rules of prudence. The most celebrated saying of this age was the Delphian inscription (of uncertain authorship), 'Know thyself.' The teaching of the Sophists made another stage in the history of moral philosophy. They opened up discussions on virtue, on justice, on the laws, and on happiness; and framed hortatory addresses with a view to moral culture. Socrates then came forward, and instituted a severe logical analysis of the meaning of ethical terms, asking 'What is piety? What is impiety? What is the noble? What the base? What is just? What is temperance? What is madness? What is a state? What constitutes the character of a citizen? What is rule over man? What makes one able to rule?' The rigid search after strict definitions of these terms may be said to constitute a philosophical method in ethics, and hence Socrates is called the first moral philosopher. He gave the impulse to Plato, his successor, who in his turn acted upon Aristotle, and also to the opposing sects of the Cynics and the Cyrenaics—the one affecting a hard and ascetic life, and a proud superiority of the individual will to all outward conventions and customs; the other avowing pleasure as the chief good, sitting loose to the irksome duties of the citizen, and in despair of attaining happiness, sliding into apathy. The Stoics and the Epicureans afforded a similar contrast, although differently expressed. The Stoic ideal was a being in whom the natural impulses and desires should be absolutely subjected to highly abstract views of the universe: the Epicurean ideal was a being moving harmoniously according to natural impulses—in short, following nature up to the limits of prudence.

The last phase of ancient philosophy is represented by Neo-Platonism (q. v.), or the Alexandrian school. In the middle ages, speculative philosophy took the form called Scholasticism (q. v.). At the revival of learning, Descartes and Bacon led in opposite directions, the one representing what is called *a priori* philosophising; the other, *Induction*



(q. v.). From this time, 'philosophy' comes to mean more exclusively the inquiries connected with the mind, as exemplified in the writings of Hobbes, Locke, Leibnitz, Berkeley, Hume, Reid, Kant, &c. The qualified phrase, Natural Philosophy (in the English sense), was applied to a special department of the outer world, as Moral Philosophy was used in connection with mind and the discussion of moral duties. The chief points in the history of modern philosophy will be found under the heads of GERMAN PHILOSOPHY, ECLECTICISM, COMMON SENSE, PERCEPTION, METAPHYSICS, ETHICS; and in the notices of BERKELEY, LOCKE, HUME, REID, KANT, HEGEL, FICHTE, COUSIN, HAMILTON, &c.

PHILOSTRATUS, the Elder, of Lemnos, a famous Greek sophist and rhetorician, was born probably about 170—180 A.D., studied under Proclus at Athens, and finally established himself at Rome, where he became a member of the brilliant and learned circle that gathered round the 'philosophic' Julia Domna, wife of Severus. He was alive, according to Suidas, in the time of the Emperor Philip (244—249). He is the author of a number of works still extant, and not without value on account of their matter, although the style and arrangement are faulty. Among them are a life of Apollonius (q. v.) of Tyana, a description of a collection of paintings at Naples under the title of *Imagines*, biographies of a number of sophists, *Heroica*, *Letters*, &c. There are complete editions of his works by Morel (Paris, 1608); Olearius (Leip. 1709); and Kayser (Zur. 1844, *et seq.*), of which the last is by far the most correct and critical.—PHILOSTRATUS the Younger, called Philostratus the Lemnian, also a teacher of elocution, was an intimate friend, perhaps a relative of the former, but nothing is known with certainty regarding him.

PHILTHER, PHILTRE (Gr. *philtron*, love-charm, love-potion). A superstitious belief in the efficacy of certain artificial means of inspiring and securing love, seems to have been generally prevalent from very early times; and among the Greeks and Romans (among the latter in the later days of the republic, and under the emperors), love-charms, and especially love-potions, were in continual use. It is not certainly known of what these love-potions were composed—nor can we rely entirely on the details given us on this subject by classic writers, and their commentators in later time—but there is no doubt that certain poisonous or deleterious herbs and drugs were among their chief ingredients, to which other substances, animal as well as vegetable, are said to have been added, coupled with the employment of magic rites. Thessaly had the credit of producing the most potent herbs, and her people were notorious as the most skillful practisers of magic arts, whence the well-known 'Thessala philtre' of Juvenal (vi. 610). These potions were violent and dangerous in operation, and their use resulted often in the weakening of the mental powers, madness, and death, instead of the purpose for which they were intended. Lucretius is said to have been driven mad by a love-potion, and to have died by his own hand in consequence—though the story does not perhaps rest on sufficient authority; and the madness of the Emperor Caligula was attributed by some persons to love-potions given him by his wife Cæsonia—by which also she is said to have preserved his attachment till the end of his life. In the corrupt and licentious days of the Roman empire, the manufacture of love-charms of all kinds seems to have been carried on as a regular trade; the purchasers, if not the makers of them, being chiefly women. The use of philters seems to have been not unknown during the middle ages; and in the

East, the nurse of superstition of all kinds, belief in the power of love-potions lingers probably down to the present day.

PHLEBENTERISM is a term invented by De Quatrefages to designate an anatomical arrangement, existing, as he supposed, in certain of the nudibranchiate mollusca, and characterised by ramified prolongations of the digestive tube, in virtue of which the digestive apparatus, to a certain extent, supplies the place of a complete circulatory apparatus, and aids in the process of respiration. The researches of Alder and Hancock, and other zoologists, seem, however, to shew that in these animals the circulation is as complete as in the gasteropodous mollusca generally, and that these ramified prolongations are of the nature of a rudimentary liver. For further information on this subject, the reader is referred to De Quatrefages's *Rambles of a Naturalist*, vol. i. pp. 348—353.

PHLEBITIS, or INFLAMMATION OF THE VEINS (Gr. *phlebs*, a vein), although seldom an original or *idiopathic* disease, is a frequent sequence of wounds, in which case it is termed *traumatic* phlebitis (from the Greek *trauma*, a wound), and is not uncommon after delivery. The disease is indicated by great tenderness and pain along the course of the affected vessel, which feels like a hard knotted cord, and rolls under the fingers. The hardness is, however, some times obscured by the swelling of the limb beyond and about the seat of the disorder, partly in consequence of the effusion of serum caused by the obstruction to the return of the venous blood (which thus gives rise to a local dropsy), and partly in consequence of the propagation of the inflammation to the surrounding tissues. The inner surface of the inflamed vessel is supposed to throw out fibrinous fluid, which coagulates in layers, and finally closes the tube. If the vessel is small, the consequences of its obstruction may be of little importance, but when a large vein is affected, the consequences are always dangerous, and may be fatal.

There are two modes of recovery: solution of the coagulated fibrine may take place, and the vessel may again become pervious; or, as is more commonly the case, the obstruction may continue, but a collateral venous circulation may be established, and the circulation thus carried on through a circuitous route. With the return of the circulation—in whichever of these two ways it is accomplished—the swelling subsides, and the patient gradually recovers. If, however, the disease advances, suppuration takes place within the coagulum, and one of two things happens; either abscesses are formed along the vein, or the pus gets into the current of blood and contaminates the circulation, giving rise to the perilous disease known as *Pyæmia* (q. v.). Either condition is dangerous; the latter pre-eminently so.

Phlebitis generally originates in some local injury of a vein, and the inflammation, when once established, is readily propagated along the course of the vessel. Sometimes very slight injuries give rise to it. It occasionally occurs after venesection, especially with a dull lancet, or one soiled by contact with diseased matter. Women are peculiarly liable to this disease after delivery, as the veins of the womb are apt to become inflamed, and to communicate the inflammation to the venous trunks connected with them. See PHEGMASTIA.

There is considerable difference of opinion as to the treatment to be pursued; some high authorities (Dr Wood, for example) recommending 'the very free use of leeches along the affected vein,' and that they 'should be repeated over and over again if the

symptoms of inflammation should persevere,' the subsequent application of cold lotions, and the internal use of mercury 'pushed to a moderate salivation;' while others question the utility of such treatment, and recommend 'rest, warm fomentations and poultices, early incision of abscesses, evacuation of bile and fæces by one or two doses of calomel, opium to relieve pain and insure quiet of mind and body, and wine, especially if there has been great loss of blood.'—Druitt's *Surgeon's Vade Mecum*, 8th ed., p. 326. The latter is in most cases the preferable mode of treatment. During convalescence, the patient must be satisfied if the swelling goes down slowly. Time is required for the enlargement of the veins by which the collateral circulation is to be carried on; and active counter-irritation, such as the application of ointments of iodine or mercury, if employed incautiously, frequently does harm by increasing the inflammation. With care, however, they are useful appliances; and if, after giving them a fair trial, much swelling should remain, the practitioner must have recourse to carefully regulated bandaging, and the use of diuretics.

**PHLEBOLITES** (Gr. *phleps*, a vein, and *lithos*, a stone) are calcareous concretions formed by the degeneration of coagulations in veins, or occasionally originating in the coats of the vessel. They are seldom detected till after death, although cases are on record in which, occurring in subcutaneous veins, they have given rise to external tumours of considerable size.

**PHLEBOTOMY.** See BLEEDING.

**PHLE'GÉTHON**, i. e., the Flaming, a river of the infernal regions, whose waves rolled torrents of fire. Nothing would grow on its scorched and desolate shores. After a course contrary to the Cocytus (q. v.), it discharged itself, like the latter stream, into the Lake of Acheron.

**PHLEGMA'SIA ALBA DO'LENS**, or MILK-LEG, is a disease which is most common in women after parturition, especially if they have lost much blood, but sometimes occurs in unmarried women, and occasionally in males. It usually commences about a week or ten days after delivery with a feeling of pain in the loins or lower part of the abdomen, whence it extends to the groin and down the thigh and leg. The pain soon becomes very severe, and principally follows the course of the internal cutaneous and crural nerve of the thigh and of the posterior tibial in the leg. The limb soon begins to swell, and in the course of a couple of days, is sometimes twice its ordinary size, and as the swelling develops itself, the acuteness of the pain considerably diminishes. The limb is partly flexed, and lies motionless; any movement aggravates the pain. The swelling extends uniformly over the limb, which is pale and shining, and hot and firm to the touch, seldom pitting on pressure. The femoral vein may usually be felt like a hard cord, and this symptom, taken with the swelling, clearly indicates that this affection is essentially *crural phlebitis*. The uniformity of the cord is interrupted by nodules, arising either from inflamed cellular tissue, or from clots within the vein. Both legs are seldom attacked at the same time, and the left thigh is the most common seat of the disease.

This affection usually terminates favourably, the acute symptoms disappearing in about ten days or a fortnight. The swelling, however, often continues for a long time, and sometimes lasts for life. Very different opinions have been held regarding the nature of this disease. At one time, it was considered as the result of metastatic secretion of milk (or, in other words, as due to the milk leaving

the breast, and settling in the thigh, and hence the term *milk-leg*). There is now no doubt that the disease is inflammation originating in the veins of the womb, and extending to those of the lower extremity. The treatment is the same as for *Phlebitis* (q. v.) generally. Warm poppy fomentations, or bran poultices sprinkled with laudanum, may be applied externally at the beginning of the attack, after which flannel saturated with a liniment, composed of one part of laudanum to two parts of soap liniment, may be applied round the limb in the form of a bandage, applied not so tightly as to occasion pain. If necessary, the bowels must be gently opened with castor oil, and opium given to allay pain and induce sleep.

**PHLE'UM.** See TIMOTHY GRASS.

**PHLOGI'STON** (Gr. *combustible*) was the term employed by Stahl, professor at Halle, in his *Zymotechnia Fundamentalis*, 1697, to designate a hypothetical element which, by combining with a body, rendered it combustible, and which occasioned combustion by its disengagement, there being left, after its evolution, either an acid or an earth. In the above-named work, he maintains that the processes of obtaining sulphur from sulphuric acid, and of procuring the metals from their earths or *calces*, are analogous, and consist alike in the addition of his phlogiston. Thus, sulphur, according to the phlogistic theory—which held undivided sway in chemistry until the time of Lavoisier, who substituted for it the theory of oxygenation (1775—1781), and was maintained by a few chemists, especially Priestley, till the beginning of the present century—was composed of sulphuric acid and phlogiston; lead, of the *calx* of lead and phlogiston; &c. In consequence of the general adoption of the phlogistic theory, when Priestley, in 1774, discovered oxygen, and when Scheele, a little later, discovered chlorine, the names these chemists gave to their discoveries were *dephlogisticated air* and *dephlogisticated marine acid*. According to modern views, mainly based on Lavoisier's experiments, the addition of oxygen takes place in the formation of acids and of earths, instead of the subtraction of phlogiston. The question whether the process was, in fact, one of addition or subtraction, was finally decided by the balance, an instrument to which chemistry owes most of its marvellous progress during the last three-quarters of a century.

**PHLOX**, a genus of plants of the natural order *Polemoniaceæ*, distinguished by a prismatic calyx, salver-shaped corolla, and unequal filaments. The species are pretty numerous, mostly perennial plants with simple leaves, and mostly natives of North America. A number of species are common in our flower-gardens. This has of late become a favourite genus with florists, and many very fine varieties have been produced.

**PHO'BEROS**, a genus of trees of the natural order *Flacourtiaceæ* or *Bizaceæ*, of which one species, *P. Mundii*, the *Klipdoorn* of the Dutch colonists of South Africa, although only 20—30 feet high, attains a diameter of three feet or more, and is very useful for the purposes of wagon-makers and house-carpenters, the wood being hard and fine-grained; another South African species, *P. Ecklonii*, the *Roodpeer* of the colonists, has a hard, heavy, and fine-grained wood, used by cabinet-makers, mill-wrights, &c.

**PHOCÆ'NA.** See PORPOISE.

**PHO'CAS**, emperor of Constantinople (602—610) was a Cappadocian by birth, and was for some time groom to Priscus, one of the celebrated generals of the Emperor Mauricius (q. v.). His brutal courage

gained him a great reputation among the soldiers, and though only a centurion at the time of the revolt against Mauricius, he was elevated to the throne by the soldiers. To secure himself, he caused Mauricius to be murdered, along with his five sons and his principal adherents; and then, by a treaty disgraceful to the empire, got rid of the Avars. But his troubles were just commencing, for Khusrü II. (q. v.), Shah of Persia, hearing of the death of his friend and benefactor, Mauricius, an event which freed him from the obligation of amity with the Eastern Empire, took up arms to revenge his friend's murder, and to recover for Persia all the territories previously under her sway. The war was fiercely carried on for 24 years, during the first 18 of which the Persian army were uniformly successful, and the Byzantines were almost completely driven out of Asia. See KHUSRÜ II. and HERACLIUS. P. remained in the capital, to overawe his turbulent subjects, conscious of his unfitnes to command the army; and abandoned himself to his animal appetites, tyrannising over the people without the least regard to justice, and putting to death whomsoever he thought dangerous, among others, Narses, the celebrated general in the former Persian war. Constantina, the widow of Mauricius, excited against the tyrant two formidable insurrections, the latter in 607, but both were speedily quelled; and the empress, with her daughters, were beheaded on the same spot where her husband and sons had been slain. Her principal adherents, some of whom were among the highest officers of state, suffered death under the most horrible tortures. These cruelties, and the successes of the Persians, had well-nigh ruined P.'s power and influence. But he gave the *coup de grâce* to it himself by insulting his favourite and son-in-law, Crispus, who had remonstrated with him on his conduct. Crispus revenged himself by forming a conspiracy against him, along with Heraclius, exarch of Africa—the result of which was the overthrow of the tyrant, who was taken prisoner (October 3, 610). After being insulted and tortured, he was beheaded, and his body dragged through the streets by the mob.

PHO'CIDÆ. See SEAL.

PHO'CION (Gr. *Phokion*), an Athenian general, of noble and unselfish character, was born about the end of the 5th c. B.C. Clinton, in his *Fæsti Hellenici*, gives the date 402 B.C. He was of humble origin, but appears to have enjoyed a superior education, and to have studied under Plato, Xenocrates, and perhaps Diogenes also, from the last of whom he may have acquired his habit of indulging in caustic sarcasm. P. first attracted notice in the great sea-fight at Naxos (376), where he commanded a division of the Athenian fleet, and materially helped to secure the victory for his countrymen. Strange to say, however, we scarcely hear of him again for more than 20 years; but in 351, along with Evagoras, he undertook the conquest of Cyprus for the Persian monarch, Artaxerxes III. (Ochus), and was completely successful. About the same time, but the exact date is uncertain, he led an Athenian expedition into the island of Eubœa, where Philip of Macedon was intriguing, and inflicted a severe defeat on that powerful sovereign at Tamynæ. In 341, he was again successful in crushing the Macedonian party in Eubœa, and in restoring the ascendancy of Athens. Two years before this, he had achieved a similar result at Megara; and in 340, when sent to the aid of the Byzantines against Philip, he acted with so much prudence and tact, and inspired the citizens with so much zeal and courage, that Philip was forced to abandon the siege, and even to evacuate the Chersonesus; while P. captured several

of his ships and coast-garrisons, besides making havoc of a good deal of the Macedonian territory. Nevertheless, with just appreciation of the real weakness of Greece Proper, and of the strength of Macedon, he advocated, even in the midst of his triumphs, pacific views, and the establishment of better relations with the enemy. His advice was not taken; but the fatal battle of Chæronea, only two years afterwards, in which the independence of the Greek republics was lost for ever, proved its soundness. The murder of Philip, in 336, occasioned the greatest exultation, and Demosthenes even proposed a public sacrifice of thanksgiving, and the establishment of religious honours to the memory of the assassin, but P. resisted, and prevented so monstrous a proposal. Henceforth, his career is chiefly political. We see him struggling at Athens to repress what appeared to him the reckless desire for war on the part of the fanatical patriots, on account of which he was regarded as a traitor, but his personal honour is above suspicion. After the death of Alexander in 323, the aged P. endeavoured, but in vain, to hinder the Athenians from going to war with Antipater. The battle of Cranon, next year, which prostrated his countrymen, again evinced the wisdom of his counsels; but, though very unhand-somely treated by the Athenians, he used all his influence with the conqueror (who, like Alexander, had a profound respect for him) to mitigate their hardships. After the death of Antipater, P. was involved in the intrigues of Cassander, the rival of Polysperchon, and was forced to flee to Phocia, where Polysperchon delivered him up to the Athenians. He was condemned, by 'a mixed mob of disfranchised citizens, foreigners, and slaves,' to drink hemlock. His body, flung unburied over the borders of the state, was carried by some of his friends to Eleusis, and burned there. The Athenians soon began to raise monuments to his memory. His life has been written by Plutarch and Cornelius Nepos.

PHO'CIS (Gr. *Phókia*), a province of Greece Proper or Hellas, bounded on the W. by the Ozolian Lokri, on the N. by Doris, on the E. by the Opuntian Lokri, and on the S. by the Gulf of Corinth. It was about 792 square miles in extent. The greater part of the country is occupied by the famous mountain-range of Parnassus (q. v.). The principal river is the Cephissus. According to tradition, the most ancient inhabitants were the Leleges, Pelasgians, and Thracians, from the gradual mixture of whom the Phocians were believed to have arisen. These were finally united into a free federal state, which derives its chief historical importance from possessing the famous oracle of Delphi (q. v.). During the Peloponnesian war, the Phocians were close allies of the Athenians. In the time of Philip of Macedon, they were involved in a ten years' war, on account of their opposition to a decree of the Amphictyonic Council, concerning the use of a piece of land belonging to the temple of Delphi. This war, commonly known as the Sacred or Phocian War, ended disastrously for the Phocians, the whole of whose cities (22 in number) were destroyed, with one exception, and the inhabitants parcelled out among the hamlets.

PHŒBUS (i. e., the Bright or Radiant), a title, and subsequently a name, of Apollo. It had reference both to the youthful beauty of the god, and to the radiance of the sun, when, latterly, Apollo became identified with Helios, the sun-god.

PHŒNICIA (Gr. *Phoiniké*, derived either from *Phoinos*, purple, or *Phoinix*, palm-tree—both designations descriptive of the chief produce of the country; the Hebrew term *Kanaan*, Lowland,

referring to its physical condition) is the name given by the Greeks and Romans to a certain territory situated about 34°—36° N. lat., bounded by the Mediterranean on the W., by Syria to the N. and E., and Judæa to the S. Except where the Mediterranean set a natural boundary, the frontiers differed widely at different periods, north, south, and east, according to the gradual rise and decline of the country. Its length may be said to have been about 200 miles, while its breadth never exceeded 20 miles, making a total of about 2000 square miles. We may here mention some of the products of the soil, the exportation of which, to a certain extent, laid the foundation of her greatness. Pine, fir, cypress, cedars, terebinths, palm and fig-trees, sycamores, olive-trees, and acacias, crown the heights; while wheat, rye, and barley are found in the lower regions, together not only with ordinary fruit, but also with apricots, peaches, pomegranates, almonds, citrons, sugar-cane, grapes, bananas—all growing luxuriantly, and forming a forest of finely-tinted foliage. The land further yields silk and cotton, indigo and tobacco; and the modern inhabitants of Shur, like their forefathers of old, drive a profitable traffic with the produce of Mount Lebanon, its timber, wood, and charcoal. Flocks of sheep and goats, and innumerable swarms of bees, supply meat, milk, and honey. The sea furnished shoals of fish, and molluscs for the purple of Tyre. There are no precious metals found anywhere in P.; but it is rich in iron, and the stone-quarries of Lebanon were already worked in Solomon's time.

The question of the origin of the Phœnicians is one which has hitherto not been solved satisfactorily. Their own account, as preserved by Herodotus, speaks of their having immigrated from the 'Sea called Erythra;' a report further confirmed by another passage in his History, and by Justin. Strabo speaks of two islands in the Persian Gulf, called Tyros or Tylos and Aradus, in which temples were found similar to those of the Phœnicians; and the inhabitants of these cities stated that the Phœnicians had left them in order to found new colonies. The Erythrean Sea, in its widest sense, extends from the eastern shores of Egypt to the western shores of India; and since Genesis calls Canaan, the founder of the race, a descendant of Ham, not of Shem, some investigators have come to the conclusion, that the Persian or Arabian Gulf is the original home of the Phœnicians. Against this notion, however, weighty arguments have been brought forward, both from the genuine traditions of the people itself, as preserved, not in a corrupted Greek shape, but in their myths, in the biblical accounts, in their language, which even in its very oldest remnants (Canaan = Lowland; Sidon = Fishing-place; Gîblites = Mountain-people) is purely Semitic. It would be vague to speculate on the time at which the first Phœnician settlers entered the country: as vague as to conjecture—the Erythrean Sea being put out of the question—whence they came. So much seems certain, that they did not enter it from one region, but from several sides, and at various periods; and that only very gradually, in the course of long pre-historic centuries, they grew into one nationality, embracing the tribes that inhabited the sea-coast, or Phœnicia Proper, from Sidon to Gaza, and the cities north of Sidonia. The latter term included the many separate states originally formed by the various *gentes*, who again, originally, had their own political existence, laws, and even worship. Gradually, however, the larger communities extended their rules over the smaller ones, or rather combined with them for the formation of a more imposing and important state, into which the different states were merged,

without, however, giving up their own individual existence or cultus entirely. The most important of these special tribes or states were the inhabitants of Sidonia—a term, however, expressive both of the inhabitants of the city and of the whole country—the Tyrians, whose settlement, according to their own traditions, was prior to any other Phœnician settlement (about 2750 B. C.); and Aradus, founded, according to the native traditions, by Arvadi, 'the brother of Sidon.' From these three tribes—of the Sidonians collectively—are to be distinguished the Gîblites with their two sovereignties of Byblus and Berytus, who differed in many respects from the former, and who, it may be presumed, formed at first the ruling state of P., until they were brought under Sidonian dependency. Several smaller tribes or states are mentioned in Scripture—Arke, Sin, Hamath, &c.—but little is known about them.

Of the government and internal constitution of these states or cities, we know next to nothing. There were hereditary monarchs ruling over Sidon, Tyrus, Byblus, Berytus, and Aradus, for whose confirmation, however, the assent of the people was necessary in all cases. By the side of the king stood a powerful assembly, composed of representatives of the old aristocratic families of the land, whose numbers differed at various periods. When Tripolis was founded by Tyrus, Sidon, and Aradus, as a place of joint meeting for their hegemony, every one of these cities sent 100 senators to watch her special interests at the common meeting; and the senate of Sidon seems, in the 4th c. B. C., at least, to have consisted of 500—600 elders, some of whom were probably selected more for their wealth than for their noble lineage. The king sometimes combined in his person the office of high-priest. The turbulent seething mass of the people, consisting of the poorer families of Phœnician descent, the immigrants of neighbouring tribes, the strangers, and the whole incongruous mass of workmen, tradespeople, sailors, that must have abounded in a commercial and maritime nation like the Phœnicians, and out of whose midst must have arisen at times influential men enough—was governed, as far as we can learn, as 'constitutionally' as possible. The unruly spirits were got rid of in Roman fashion somehow in the colonies, or were made silent by important places being intrusted to their care, under strict supervision from home. Only once or twice do we hear of violent popular outbreaks, in consequence of one of which it was mockingly said that P. had lost all her aristocracy, and what existed of Phœnicians was of the lowest birth, the offspring of slaves. As the wealth of all the world accumulated more and more in the Phœnician ports, luxury, and too great a desire to rest and enjoy their wealth in peace, induced the dauntless old pirates to intrust the guard of their cities to the mariners and mercenary soldiers, to Libyans and Lydians—'they of Persia and of Lud and of Phut,' as Ezekiel has it; although the wild resistance which this small territory offered in her single towns to the enormous armies of Assyria, Babylonia, and Greece, shews that the old spirit had not died out.

The sources for the early Phœnician history are of the scantiest description. Of the annals and state documents which filled the archives of every large city, nothing has survived except a very doubtful record, which Sanchuniatho (q. v.) is said to have compiled, about 1250 B. C., in Phœnician from official documents, and which was translated into Greek by Philo of Byblus, and a fragment of which is preserved by Eusebius. The Bible, principally Ezekiel, Menander of Ephesus, and Dîus, a Phœnician, who wrote the history of Tyre from Tyrian annals, fragments of which are extant in Josephus

and Syncellus, Herodotus, Diodorus, Justinus, and others, together with a very few notes scattered throughout the Church Fathers, contain the sum of all our information. Four great periods, however, are clearly distinguishable in the history of ancient Phœnicia. The first would comprise the earliest beginnings and the gradual development of the single states and tribes, from their immigration to the historical time when Sidon began to take the lead, or about 1500 B. C. The second period dates from the conquest of Palestine by the Hebrews. Sidon had then become already the 'first-born of Kanaan,' as Genesis has it, or 'Sidon Rabbah,' the Great Sidon. The flourishing state of its commerce and manufactures appears likewise from several passages in Homer. The silver vase proposed by Achilles as a prize in the funeral games in honour of Patroclus, was a work of the 'skilful Sidonians;' the garment Hecuba offers as a propitiatory gift to Minerva was the work of Sidonian women. The gold-edged silver bowl given to Telemachus by Menelaos, Hephaistos had received from the king of the Sidonians. Ulysses is left on the island of Ithaca by the Phœnicians, who sail away to 'well-peopled Sidonia.' The gradual ascendancy of the rival city of Tyre marks the beginning of the third period, in which P. reaches the height of its power, in which her ships covered all the seas, her commerce embraced the whole earth, and her innumerable colonies flourished far and near. The first historically-recorded item of Tyre's activity is her foundation of Gades, a few years before that of Utica, in 1100 B. C. The reason of the sudden greatness of Tyre is to be found in the defeat of the Sidonians by the king of 'Askalon'—a term probably meant to represent the whole pentapolis of Philistia—about the year 1209; in consequence of which, the principal families of Sidon 'emigrated in their ships to Tyre, which [viz., the Island-city] they founded.' In the 11th c., in the time of Samuel, 'the princes of the Tyrians' are already spoken of instead of the Sidonians, as the representatives of Phœnicia. During the reigns of David and Solomon—under Hiram (980—917)—the friendliest relations existed between the two nations: both in the full bloom of their power. Each country needed what the other could supply. Hence their close alliance, which led even to common commercial enterprises in ships built by Solomon, the supercargoes of which belonged to him, while the mariners and pilots were Hiram's.

By this time, Phœnician colonisation had reached its utmost extent. In the space of three centuries (1300—1000), the Phœnicians had covered all the islands and coasts of the Mediterranean with their forts, their factories, and their cities; and their ships, which ploughed the main in all directions, everywhere found their own ports. They had colonised Cyprus, thus commanding the waters of the Levant and the coasts of Syria and Cilicia. Kithion, Amathus (Hamath), Karpasia, Paphos, with its magnificent temple of Ashera, Keryneia, and Lapothos, were some of their principal settlements in those regions. Northward, on the coast of Cilicia, they founded the cities of Myriandros, Tarsos, and Soloi. Migrating to the west, they took possession of Rhodes, Crete (cf. the Myth of Zeus and Europe), Melos, Thera, Olios (near Paros), and Cythera, on the coast of the Peloponnese. To the east of the Ægean, we find them at Erythra, and further, as masters of the islands of Samothrace, Lemnos, and Thasos with its wealth of gold mines. The Ægean Sea, with all its islands, being in their hands, they sailed thence further west, to Sicily, where they settled at Motye, on the extreme west point; founded Rus

Melkarth, in the south (Heraclea Minoa); in the north, Machanath (Panormos, Palermo), and further, Melite (Malta) and Gaulos. They owned Caralis (Cagliari) in Sardinia, Minorca, Iviza (Ebusos), Elba; on the opposite, or African coast, Hippo, Utica, Hadrumetum, Leptis, and some minor island states. From Sardinia and Minorca, the indefatigable mariners went still further west—through the Strait of Gibraltar to Tarshish (the California of those days) or Spain, where they founded Gadeir or Cadiz, and in the south, Karteja, Malaka, and Abdarach. From here, having colonised well-nigh the whole of the Spanish coast, they went northwards to the tin islands (Scilly Isles), and to Britain herself. And while they thus explored the regions of the Atlantic, their alliance with the Hebrews had permitted them to find the way to the Indies by the Red Sea.

The impulse given to industry and the arts by this almost unparalleled extension of their commercial sphere, was enormous. Originally, exporters or traders only for the wares of Egypt and Assyria, they soon began to manufacture these wares themselves, and drew the whole world into their circle of commerce. As to the early and most extensive commercial intercourse between P. and Greece and her colonies, nothing can be more striking than the circumstance of nearly all the Greek names for the principal objects of oriental commerce being Phœnician, or rather Semitic—identical almost with the terms found in the Old Testament. Thus, of spices—myrrh, cassia, cinnamon, galbanum, narde, aloe, crocus, nitron, balsam, &c.; of jewels and precious stones, sapphire, jasper, smaragdus; of fine materials, and garments, byssus, karpasos, sindon, &c.; musical instruments—nabla, tympanon, sambyke, &c.; oriental plants, vessels, and even writing implements. The wealth of silver, iron, tin, and lead was chiefly got from Tartessus. The descriptions of the abundance of precious metals there verge on the fabulous. Thus, the Phœnicians are supposed to have made even their anchors of silver, when they first discovered the country, not knowing how to stow away all the silver in their vessel. What must have been the state of these mines is clear from the fact, that, even in the Roman time, 40,000 men were constantly employed as miners, and the state received a clear revenue of 20,500 drachms daily. The 'Fortunate Islands,' which, according to Diodorus, they discovered after many days' sailing along the coast of Africa, beyond the Strait of Hercules, and which, to judge from the name *Purpuraris* given to some islands off the coast of Mauritania, would seem to have been the Canaries, yielded them the shell-fish *purpura*, so useful for their dyeing manufactories. Besides their wholesale commerce carried on by fleets and caravans, they also appear to have gone about the interior of Syria and Palestine, retailing their home or foreign produce.

Although the Phœnicians were erroneously believed, by the western tribes, to manufacture all the wares in which they dealt themselves, yet no inconsiderable number of them was really their own work. None of their manufactures, however, stood in so high repute throughout antiquity as the purple dye prepared from the *muricida*, a shell-fish of its coast; and none excelled more in it than the Tyrians. Purple was an almost indispensable luxury of antiquity, particularly in Asia. In temples and palaces for gods and men, purple garments, hangings, curtains, and veils were needed; and Alexander the Great found in Susa alone a store of purple worth 5000 talents. Sidon's principal production was glass—invented there, it was said, by

accident; but probably the invention was derived from Egypt, where it was in use long before; the Phœnician glass, however, was always supposed to be the best. The Sidonians knew the use of most of our own contrivances—the blowpipe, the lathe, and the graver. Hardly less great was the fame of Phœnician metallurgy. Their mining operations in the Lebanon and Cyprus, where they dug for copper; in Thasos, where, according to Herodotus, they overturned a whole mountain in searching for gold; but more particularly in Iberia, where at first silver was so abundant, that hardly any labour was required to obtain it—were stupendous; and the minute description of the mining-process contained in Job (chap. xxviii. 1—11) has probably been derived from a sight of Phœnician mining-works. That they well understood how to work the metals thus gained, has been observed already. The art of founding brass must, indeed, have reached a high perfection to enable Hiram Abif to execute such works for Solomon's Temple as they are described in the Bible. No less were they familiar with the art of imitating precious stones, and colouring glass by means of metallic oxides. To Sidon is further attributed the pre-eminence in the glyptic and plastic arts; and the artists sent by Hiram to Solomon were skilful workers in gold and silver, in brass, in iron, in purple and in blue, in stone and in timber, in fine linen, and the engraving of precious stones. Their architecture seems to have been of a Cyclopean nature. Their vessels, originally simple rafts, gradually developed—with the aid of the Lebanon, which afforded inexhaustible supplies of timber, and Cyprus, which possessed all the materials necessary for fitting up a ship, from the keel to the sails—into a first-rate fleet, consisting of round ships, or gauli, for short or coasting voyages; war-galleys, or *tirremes*; and fifty-oared craft, long in build, and adapted for rapid sailing or rowing. The internal arrangement of these vessels was perfect, and excited the wonder and admiration of the Greeks, by their being so splendidly adapted at once for navigation, freight, and defence. Their extraordinary three years' voyage of discovery, undertaken in the service of Necho, round Africa, going out of the Red Sea, and returning by the way of the Strait's mouth, is as well known as their voyages in the service of Solomon.

The golden age of P., during which her colonies, her manufactures, and her commerce were in this most brilliant phase, seems to have waned simultaneously almost with that of Judæa. As Solomon in the latter, so does Hiram in the former, mark the end of that peace and happiness which had made their countries rich and glorious, as no other country of their day. According to a fragment preserved in Menander, Hiram was followed by his son Baleastartus, who died after a short reign of seven years, in 940 B. C., and a long series of political calamities and civil wars ensued. The last of Hiram's sons, Pheletus, fell, in 898, by the hands of Ithobaal, the priest of Astarte, into whose family now passed the kingdom of Tyre. He is the Ethbaal mentioned in Scripture as the father of Jezebel, and father-in-law of Ahab; and a peculiar coincidence is the simultaneous mention of the three years' drought in Judæa (to which an end was put by Elijah's prayer) and in P., where relief was obtained by Ithobaal, who seems to have stood in the odour of sanctity. It was during this unhappy period that the celebrated Elissa, better known as Queen Dido (q. v.), fled, together with some of the most aristocratic families of Sidon, to Libya, where they founded a new city (Kartachadata = Carthage), near the spot of an ancient Sidonian settlement, about 813 B. C. The

fourth and last period of Phœnician history may be dated from the middle of the 8th c., when Shalmaneser, the king of Assyria, invaded P., and besieged Tyre for five years, but without result; and there is every reason to believe that the peace concluded at the end of this period was very favourable to Tyre. But soon afterwards, P. was drawn into the struggle for the supremacy then raging between Chaldæa and Egypt, and was conquered by the former power. A further calamity befel P. at the hand of Pharaoh-Apries, who anticipated Nebuchadnezzar's intended attack on Egypt by destroying the Phœnician fleet, conquering the country, and pillaging it. These calamities produced a series of internal troubles, in consequence of which the constitution was constantly changed; and we hear now of a series of kings, and now of provisional *suffetes*—all their respective reigns, however, being of very brief duration. From that time forward, and even before the special histories of Sidon and Tyre, which alternately possessed themselves of the hegemony of Phœnicia, constitute also the history of the country itself, and to these two cities we refer for what momentous events took place in the latter days of the once mighty empire. The battle on the Issus terminated even the shadow of P.'s independent existence, and it shared the fate of Alexander's vast empire. In 65 B. C. it became, under Roman dominion, part of Syria, and has since shared her fate for good or evil. See SYRIA, SIDON, TYRE, CARTHAGE.

*Religion.*—With regard to the Religion of the Phœnicians, its real character has as yet been imperfectly explicated. Deprived of all original and direct information on the subject, we have to cull what scanty notices we may from the works of Greek and Latin writers, or to gather knowledge from some vague allusions contained in the Bible. Not a scrap of native literature has been allowed to survive; and the supposed extracts from a Greek version by Philo of Sanchuniatho's Phœnician works, which we find in Eusebius—hitherto our chief source of information—must be used with more than an ordinary degree of caution. See SANCHUNIATHO. We shall therefore, without entering into futile speculations, confine ourselves to a few general and well ascertained facts; premising, however, that Phœnician theology is far from being a hopeless province, whatever it may appear now. Excavations are on foot in all directions, both in the mother-country and in the colonies, and new discoveries are being brought to light constantly.

The religion of the Phœnicians was, like all ancient Semitic religion—except that of the Hebrews—a kind of pantheistic worship of nature. While Monotheism, with the descendants of Abraham, assumed a supreme power within nature, which, according to its own free will, creates and destroys, the rest of the East assumed a Dualism: two elements, a male and a female; or two highest deities, one of whom begets, and has the power to destroy, and the other conceives and bears. These two supreme beings were sometimes merged in one deity, with male and female attributes, which spread out into immense ramifications: representatives now of the general powers of nature, now of the particular phenomena in nature, or the life of men. They had deities who ruled over the stars, the elements, the seasons; over special localities, or over certain phases of life. No nation of antiquity perhaps possessed a more endless pantheon than the Phœnicians: a circumstance easily explained by their peculiar position and relations. Consisting originally of a variety of tribes, each of whom had had their own special deities—although the supreme

*Numen*, or the principle of their chief Deity, was probably the same with all—those Phœnicians who dwelt in the north differed in some respects, such as the names and attributes of certain gods, from those of the south. Besides this, it must not be forgotten that the period of Phœnician history ranges over 2000 years, and their political career, as well as their commerce, brought them in close and constant contact with nearly all the civilised nations of the then known world; and being both superstitious (as sailors and traders are prone to be), and possessed of an adaptability to which partly they owed their success in other respects, they easily, if not greedily, received into their wide pantheon those who, albeit the special national gods of others, or because of this very reason, could either harm or benefit them. It may be also that a certain easy nonchalance about these things, such as the wealthy and aristocratic classes displayed in ancient Rome and elsewhere, and the interest of the priests, who received very considerable tithes of every sacrifice (oddly enough, our information on that point leaves nothing to be desired), went hand in hand to favour the gradual introduction of as many gods and goddesses as pleased the herd. Their proper divisions, however, their real names and derivations, and the history and time of their nationalisation, are things which will for ever continue to puzzle investigators.

Setting aside such more or less vague and undefined names of deities as were common to the whole Semitic stock, and as they are found in the Hebrew records—like *El* (Mighty One), or (in plural) *Elim*; *Olonim* [*Elyon*] (the Most High); *Adon* (Lord); *Melch* [*Moloch*] (King); &c.—we find in the first rank of gods (of Tyre and Sidon) *Baal* (q. v.) and *Astarte* (q. v.) *Baal* again occurs in two different characters, as it were—as *Baalsamin* (Lord of Heavens), the highest god ruling over the Universe, the Zeus Olympios, and Jupiter Optimus Maximus; and as *Baal Melkarth*, the special national numen. *Baalsamin* is originally identical with the Babylonian *Bel* or *Baal*. The third supreme Tyrian goddess was *Astarte*, worshipped as the very counterpart of the Sidonian *Asarte*. While the latter was considered a pure virgin, whose emblem was the moon, the former (the biblical *Ashera*) was prostituted (as *Venus*, goddess and planet) by prostitution. The Tyrian *Astarte* was principally known under the name of *Tanis* (q. v.), the Assyro-Persian *Tanis*, and was married to *Baalsamin*, and also to *Adonis*, and bore altogether the character of a goddess who delighted in chastity.

The principal deities of Northern P.—the non-Sidonian tribes—consisted of a different trias—*El*, *Baal*, and *Adonis*. The first was the supposed founder of the two oldest Phœnician cities of *Byblus* and *Berytus*, and corresponded to (being originally, perhaps, identical with) both *Baalsamin*, as the highest deity, and *Melkarth*, as the special god of Tyre. *Baal*, *Beltis* (My Lady—*Aphrodite*), worshipped at *Byblus*, *Berytus*, *Aphaka*, *Arke* (*Architis*), &c., was joined to *Adonis* (q. v.), whose cultus had been imported from Assyria, and is therefore unknown in the more ancient Phœnician colonies, in Africa and Spain. *Byblus* called him *Adonis Ganas*, or *Ganan* (perhaps *Gaavan*, the Exalted), near *Byblus*, we find him worshipped as *Elyon* (the Highest); as *Esmun* in *Berytus*, and perhaps also under the name of *Memnon*, at *Apamea*, where an annual mourning-festival was celebrated in his honour; further, near the river *Bandas* at *Paltos*; and at the river *Belus*. As *Serach* (the Brilliant) in Phœnician, and *Kharush* (the Sun) in Persian, he appears to have had some relation to the star-and-planet worship which became, under Assyrian

influence, a prominent feature of the Phœnician religion.

Besides these more or less localised gods and goddesses (*Dii Majores*), a certain number of deities—states and country deities—were worshipped in common by all Phœnician states. They were called the Children of *Sadik* (the Just), or the Children, or the *Pataki* (Descendants of *Phtha*), or the eight *Kabiri* (Strong Ones). They are the maritime gods, and their images were placed on the prows of Phœnician ships. As protectors of navigation, they are identified with the *Dioscuri*; and again, as representatives of heat, breath, and life, they received the names of *Lares* and *Penates*. Their individual names are not generally mentioned; they seem (cf. *Eamun* = eighth) to have been merely counted. Their mode of worship was most mysterious—as indeed some of the earliest mysteries were closely connected with it.

Besides these, they also worshipped certain phenomena, personified attributes, and qualities. Their planetary divinities were the Sun and his four horses—to whose worship belongs, among others, to a certain extent the annual festival of the Resurrection of the (Tyrian) *Herakles*, under the emblem of a column in the form of a rising flame (*Chaman*); the Moon with her chariot drawn by white bulls; the planet *Mars* (*Aziz* or *Nergal*); *Jupiter* (*Kochab* *Baal*); *Venus* (*Astoret* *Naamah* = lovely *Astarte*), with her voluptuous cultus; and *Saturnus* (*Moloch*, *Kronos*), the evil principle. The elements were revered either in conjunction with certain deities or on their own account. The water, to which sacrifices were offered both in the shape of human beings and animals or fruits, was hallowed in all its shapes—as the sea, as rivers, fountains, lakes—by which people took their most solemn oaths; the fire, in connection with the oldest deity of P.; the light (*Moloch*); the air and the winds; the earth and all its plants, its forests, and glens, and trees, and more especially its mountains, as the 'symbols of the High Ones,' or as 'Faces of God,' such as *Mount Carmel*, *Lebanon*, *Antilibanus*, and others. Of animal-worship we have only small traces.

Abstract notions and ideas were not forgotten. The Year and the Months, Day and Night, *Aurora* (*Lilith*), *Age* and *Youth*, *Art* and *Love*, had their altars. Nor were certain professions and trades without their visible patrons. Thus, there are gods of agriculture and horticulture, like *Dagon*, the god of grain; a *Dionysos*, whose Phœnician name is *Is-et*, as the god of wine-growers; a god who is the numen of fruit-growing, of pisciculture, of mines, &c. Chthonian gods are not wanting. The god of Death—the king of the lower regions—is *Muth* = *Death* (*Pluto*), who is represented as a small child. His reign was shared by a goddess whose name is vaguely known as *Eloti* (My Goddess), and who is occasionally identified with *Astarte*, *Dido*, *Anna*, *Persephone*, *Europa*, and a great many other deities.

We have already touched upon the mode of worship of the Phœnicians, and the places chiefly selected for their rites. Mountains, heights, rivers, lakes, fountains, meadows, glens, were, as we said, the favourite habitations of the gods. But the Phœnicians were also amongst the first who erected temples. These were generally divided in two parts, containing the sacred arks (the mystic cists of the Greeks); and the chariots upon which the sacred objects were at times carried about. Not being intended to be prayer-houses, but as dwelling-places for special gods, they were rather small, and did not even contain the altar upon which the sacrifices were offered. This generally stood at the entrance of the temple, and around it the

priests and hierodouloi danced in their service. Pure wells and an everlasting fire were the indispensable conditions of a sanctuary. The sacrifices themselves, as far as they consisted of animals, offer great analogies to those of the Jews; but the P. also offered up human sacrifices—chiefly first-born male children, as that which the suppliant held dearest—chiefly to Baalsamin, Baal Hamon, and Astarte. Such human sacrifices, or burnt-offerings took place annually at the great festivals of expiation, and further on extraordinary occasions, at the beginning of important enterprises, such as a campaign, and in great casualties: in order to expiate by one sacrifice the sin of all. The same fanaticism which fancied the gods best pleased by the offering up of what was most precious, led the Phœnician women, like the Babylonian, to sacrifice their honour in honour of Astarte, on certain occasions, so that certain sanctuaries became hot-beds of prostitution. Circumcision—another kind of sacrifice—was not common among all the Phœnician tribes, it being a rite principally sacred to El, the god of Berytus and Byblus.

Of festivals and pilgrimages in general, we have spoken under FESTIVALS, GREEK RELIGION, &c.; and what has been observed there respecting their character in Polytheism (their being to a great extent connected with the births, deaths, resurrections, and other personal phases of special deities), holds good here. No doubt, these festivals, like those of the Hebrews, and all other ancient nations, had, beside their religious, also their political and commercial significance; and P. was more particularly, by the eminent position she held in the world's trade, a place towards which flocked, on solemn occasions, pilgrims from all parts of Asia and Africa. 'Festival Embassies,' as they were called, were despatched thither from Syria, Arabia, Babylonia, Cappadocia, Cilicia, Egypt, Armenia; nay, from India, Ethiopia, Persia, and Scythia; and not until the 6th c. A.D. did these pilgrimages to P. cease entirely. One festival, is entirely peculiar to Tyre, and strangely enough, it is still celebrated by the present inhabitants of Sur—viz., the 'Wedding of the Land-water with the Sea-water.' On these occasions, the people walk in procession to the well near the town-gate, and pour some pails of sea-water into it, in order to render it clear and sweet again for a long time.

It would be vain to try, with our scanty and adulterated sources, to gain a deeper insight into the ideas attached to the names, attributes, and modes of worship of the deities mentioned, or to speculate upon their moral influence upon the people of Phœnicia. That these were pre-eminently practical; that arts and manufactures flourished among them, more than among any other ancient nation; that they knew how to turn science into money; that they were, in fact, shrewd men of business—all this we know, but little more. Atheists or Pantheists, whichever they must be called in the modern sense of these words, it is extremely doubtful whether they, any more than the bulk of the Hebrews before the Exile, believed, as a body, in immortality. What was their influence upon Greece, Rome, the whole ancient and modern world, in the province of religious thought, we shall never have any means fully to ascertain. Comparative Mythology, has a vast field to explore in this direction.

*Phœnician Language and Literature.*—With the exception of Greek and Latin, no language was so widely known and spoken throughout antiquity as the Phœnician; and monuments of it have been found, and continue to be found, almost all over the ancient world. We can only vaguely speculate on its early history and its various phases, so long

as our materials yield so little information on that point. Its decline seems to date from the 3th c. B.C., when Aramaisms crept in in overwhelming numbers. Finally, the close contact with, and the everywhere preponderating influence of the Greeks, superseded—chiefly after Alexander's time—the ancient language almost completely; and even coins with Phœnician legends occur not later than the 2d c. B.C.—An important Phœnician literature seems to have been extant as late as the 1st c. A.D., but it has disappeared from the face of the earth. After the second half of the 3d c., the language had vanished entirely in the country itself, and Jerome, who lived in Palestine, mentions the Punic, but never the Phœnician. In the west, it survived to a much later period. In Mauritania and Numidia, it remained, in a corrupted form, the reigning tongue as late as the 4th c. A.D.; and Augustine draws his explanations of Scripture from the Punic current in the 5th century. There was a translation of the whole Bible into Punic made for the use of the Punic Churches; and in and near Tripolis and Bizanium, it was the language of the common people up to a late period. From the 6th c., however, it rapidly died out, chiefly in consequence of the Vandals, Goths, Moors, and other foreign tribes overrunning the country, and ingrafting their own idioms upon it.

As a branch of the so-called Semitic family of the Hebrews, Syrians, Arabs, &c., the Phœnicians naturally are closely related to these also with respect to language. The affinity of the 'speech of Canaan,' as the Hebrew is called sometimes, with the Phœnician was indeed remarked at an early period. Augustine, Jerome, and Friscian pointed out already—and sometimes in order to back some very peculiar notions—how closely these two languages and their dialects were allied. Yet it must be obvious at first sight, that however near the two idioms may originally have stood to each other, the peculiar relations and fortunes of the two races who spoke them must have produced substantial changes in their structures in the course of time. While the ancient scriptural monuments of the Hebrews—outwardly and inwardly—exhibit a rare unity of idiom and form, the ancient hallowed utterance becoming a type and model for the later generations; the Phœnicians, on the other hand, not confined within the narrow limits of their home-country, but mixing freely with all the nations of the earth, spreading their own colonies far and near among them, opened a wide field for the 'development' of their language, or rather for its corruption, by its entering into alliance with Libyan in Africa, Sardinia, and Spain, and with Aramaic in Northern Phœnicia, Cilicia, and perhaps even in Cyprus. Thus it came to pass that the two languages which originally may have been identical in old Canaan became more and more widely divergent. To enter into a more detailed disquisition on this or other cognate points, we deem more hazardous now than we should have thought it ten or even five years ago; for the more ample our discoveries in Phœnician literature have become of late, the more it becomes evident that we are only at the commencement, as it were, of Phœnician philology.

What we said of the structure of the Hebrew Language (q. v.), also holds good for Phœnician to a certain extent; and we shall therefore simply point out the most palpable differences between them. In the first instance, we observe the very strange circumstance, that what is considered an archaism or an isolated dictum in Hebrew, appears as a common expression in Phœnician. Certain grammatical terminations, obsolete in Hebrew, are in use in Phœnician—so that it would appear as if the Phœnician had retained more of the ancient Canaanite speech



than the Hebrew, which gradually transformed and refined it by grammatical niceties. Another feature is the preponderance of the Chaldee, or rather Aramaic words and forms—although here again we are on very dubious ground. It might further be questioned whether our Phœnician Inscriptions—all belonging to a very late period—are not rather a faithful reflection of the Hebrew of their period, which, since the 8th c. B.C., had more and more changed into Aramaic. So much is certain, that the original language of Canaan was perfectly free from Chaldaisms, and that these are but a late corruption—such as we also find in the later books of the Old Testament. Yet there are other features quite peculiar to the Phœnician, which—although not of sufficient importance to warrant our separating the dialect entirely from the Hebrew—are of a nature not to be explained by any Semitic analogy; such as certain differences in the pronunciation of vowels, in the treatment of consonants, the formation of pronouns, some verbal forms, and certain words entirely foreign to the Semitic. Again, a distinction is to be made between the Phœnician of P. and that corrupted form of it spoken in the western colonies, called Punic, and further, that idiom peculiar to the inhabitants of Leptis, called Libyo-Phœnician—a mixture of Phœnician and Libyan, with a vast preponderance, however, of the former element.

The difference in the pronunciation may be briefly characterised as a tendency towards an obscuring or lowering, as it were, of the vowels: thus, the Hebrew *a* is changed into *o*, the *e* into *i* or *y*, *i* into *y*, sometimes into *u*, and *o* into *u*. Peculiar is also the use of the Hebrew *Ayin* as a vowel (*mater lectionis*), with the pronunciation of *o* or *u*. On some occasions, however, it is entirely omitted. The gutturals are changed at times, as in the corrupted orthography of Samaritan and Sabian, so that *L* and *R* are sometimes assimilated with the next consonant in the middle of the word, or entirely omitted, &c. As to grammar, our knowledge is extremely limited. A few undoubted facts are the termination of the nominative form in *al* instead of the Hebrew *ah*, the greater variety of genitive forms in Phœnician, the difference in the formation of the pronoun, and the identity of the article with that in Hebrew (*ha*). For the Phœnician alphabet, the model of all European alphabets, see ALPHABET.

The Literature of P., in its original form, has, as we said, perished entirely. What traces and fragments we have of it, have survived in Greek translations. But from even these small remnants, we can easily imagine the extreme antiquity, and the high importance and vast extent of these productions, which, at first, seem to have been chiefly of a theological or theogonical nature. Their authors are the gods themselves, and the writings are only accessible to the priests, and to those initiated in the mysteries. From the allegorical explanations of these exalted personages sprang a new branch of sacred literature, of which those fragments of Cosmogony mentioned above are derived. To the literary age of Taaut, Kadmus, Ophion, Esmun, &c., succeeded Thabion, Isiris, Sanchuniatho, and Mochus, who founded the schools of Priests and Prophets. These cultivated the sciences, chiefly the occult ones, magic, and the like. Nearest to the Sacred Literature stands Didactic Poetry, somewhat related to the Orphic, whose chief representatives are Sido, Jopas, &c. The erotic poetry is characterised as of a very sensuous nature, both in P. and the colonies. Of historians are mentioned Mochus, Hysikrates (Sanchuniatho?), Theodotus, Philostratus, Menander, and others; but these are mere Greek versions of

their Phœnician names, and absolutely nothing has been preserved of their writings. Punic literature is also frequently mentioned by Greek and Roman writers. Geography, history, agriculture, were the fields chiefly cultivated by the colonists of Carthage and the West generally.

The monuments that have come down to us, and which not only have enabled us to judge for ourselves of the religion, the language, and the manners of the Phœnicians, are of twofold kind—they are either legends on coins and lapidary inscriptions, or Phœnician proper nouns and texts imbedded in the works of ancient classical or sacred writers. The principal and ever-growing source for our information, however, are the monumental inscriptions, of whose existence, till the middle of the 18th c., nothing was known. The most numerous Phœnician remnants have been discovered in the colonies. Richard Pococke first found, on the site of ancient Citium (Larnaka of to-day), 31 (not 33, as generally stated) Phœnician inscriptions, which he deposited at Oxford (published by Swinton, 1750). Malta, Sardinia, Carthage, Algiers, Tripolis, Athens, Marseille, have each yielded a considerable number, so that altogether we are now in the possession of about 120 monuments, either votive tablets, or tomb inscriptions. The latest and most remarkable are those now in the British Museum, discovered at Carthage a few years ago by N. Davis, consisting of votive tablets, a (doubtful) tombstone, and a sacrificial tariff, which completes another stone found some years ago at Marseille of the same nature; both setting forth the amount of taxes, or rather the proportionate share the priest was entitled to receive for each sacrifice. Another exceedingly valuable (trilingual) inscription, referring to the gift of an altar vowed to Eshmun-Asklepios, has been discovered a year or two ago in Sardinia. See below. One of the most important historical monuments is the sarcophagus of Ashmanasar II., king of Sidon (son of Tennes?), found at Tyre in 1855, the age of which has variously been conjectured between the 11th c. B.C. (Ewald)—a most incongruous guess indeed—the 7th (Hitzig), the 6th (Duc de Luynes), and the 4th (Levy), of which we shall add the commencement, literally translated: 'In the month of Bul, in the fourteenth year that I reigned, King Ashmanasar, king of the Sidonians, son of King Tebnith, king of the Sidonians—spake King Ashmanasar, king of the Sidonians, saying: Carried away before my time, in the flood of days—in dumbness ceases the son of gods. Dead do I lie in this tomb, in the grave, on the place which I have built. I myself ordain that all the nobles and all the people shall not open this place of rest; they shall not seek for treasures and not carry away the sarcophagus of my resting-place, and not disturb me by mounting the couch of my slumbers. If people should speak to thee [and persuade thee to the contrary], do not listen to them. For all the nobles and all the people who shall open this sarcophagus of the place of rest, or carry away the sarcophagus of my couch, or disturb me upon this resting-place, may they find no rest with the departed; may they not be buried in a tomb, and may no son and successor live after them in their place;' &c.

The votive tablets bear the same character throughout, differing only with respect to the name of the man or woman who placed it in a certain sanctuary in accordance with his or her vow. Their material is mostly limestone or fine sandstone, rarely marble, and they vary from 5 to 15 inches in height, from 4 to 7 in width, and from 1½ to 4 in thickness. Beginning in most cases with the dedication to the god or goddess, or both, thus: '[Sacred] To the god . . . [this tablet]



## PHENICOPTERUS—PHONETIC WRITING.

Carthaginian votive tablets with which the British Museum (now the wealthiest in Phœnician monuments) has lately been enriched, as mentioned before.

The emblems on it are symbolical, and refer to the deities invoked. The lower part is mutilated, but easily supplied. The date is uncertain, perhaps the 2d or 3d c. B. C.

The second is a trilingual inscription from a base of an altar, recently found at Pauli Gerrei, in Sardinia, and has been first fully explained by Deutsch. (See *Transactions of the Royal Society of Literature*, 1864.)

Its contents are briefly this: A certain Cleon, Phœnician by religion, Greek by name, Roman by nationality, a salt-farmer, vows an altar—material and weight of which are only given in Phœnician; viz., copper, a hundred pounds in weight—to Eshmun-Æsculapius 'the Healer' (the Phœnician *Mearrach*, clumsily transcribed *Merre* in Latin, and *Mirre* in Greek), in consideration for a cure to be performed. The date, given in Phœnician, viz., the year of two, apparently annual, entirely unknown judges, gives no clue to the time. Palæographical reasons, however, would place it in about the 1st c. B. C.

Among those who have more or less successfully occupied themselves with Phœnician antiquities, language, and literature, and who have also, in some instances, deciphered inscriptions, we mention Scaliger, Bochart, Pococke, Barthelemy, Swinton, Bayer, Dutens, Hamaker, Gesenius, Movers, Munck, Judas, Barges, De Sauley, Ewald, Levy, Vaux, Renan, De Luynes, De Vogué, Deutsch, and others; to whose writings, contained either in special works or scattered in *Transactions of learned societies*, we refer for further information on the subject of our article. The principal work in German is Movers's *Phœnizier*, unfortunately left unfinished at the author's death. A useful English compilation is Kenrick's *Phœnicia* (Lond. 1855).

**PHENICOPTERUS.** See **FLAMINGO.**

**PHŒNIX**, the name of a mythical Egyptian bird, supposed by some to be a kind of plover, like the *kibitz*, often depicted with human arms, and called in hieroglyphs *rekh*. Others consider it to be the *bennu*, or *nycticorax*, a bird sacred to Osiris, and represented watching in the tamarisk over his coffin. The first of these representations has sometimes a star upon the head, supposed to indicate the astronomical period of its appearance. It visited Egypt after the death of its father, and entered the shrine particularly dedicated to it at Heliopolis, and there buried its parent, putting the body into an egg or case made of myrrh, and then closing up the egg. Another account is, that the P., when about to die, made a nest for itself in Arabia, from which a new P. sprung of itself. This bird proceeded to Heliopolis, and there burned and buried its father. But the more popularly-known version is, that the P. burned itself, and a new and young P. sprung from the ashes. A less received version is, that a worm crawled out of the body of the dead P., and became the future one. The P. was, according to the most authentic accounts, supposed to visit Egypt every 500 years; the precise period, however, was not known at Heliopolis, and was a subject of contention till its appearance. The connection of the Phœnix period with that of the Sothiac cycle, appears to be generally received by chronologists, as well as the statement of Hersepolo, that it designated the soul and the inundation of the Nile. A great difference of opinion has prevailed about the Phœnix period: according to Ælian, it was a cycle of 500 years; Tacitus seems to make it one of 250 years; Lepsius, a cycle of 1500 years. The P. was fabled to have four times appeared in Egypt: 1, under Sesostrius; 2, under Amasis, 569—525 B. C.; 3, under Ptolemy

Philadelphus, 284—246 B. C.; and lastly, 34 or 36 A. D., just prior to the death of Tiberius. The P. also appears upon the coins of Constantine, 334 A. D., viz., 300 years after the death of Christ, who was considered the P. by the monastic writers. It is supposed by the rabbins to be mentioned in Job and the Psalms.—Job xxxix. 18; Psalms ciii. 5; Herodotus, ii. 73; Achilles Tatius, iii. 25; Tacitus, *Ann.* vi. 28; Tselze, *Chil.* v. 397; Lepsius, *Einlei.* p. 183; *Archæologia*, vol. xxx. p. 256.

**PHŒNIX.** See **DATE PALM** and **PALMS.**

**PHO'LAS**, a genus of lamellibranchiate mollusca, of the family *Pholadidæ*. This family, to which the Ship-worm (*Teredo navalis*) also belongs, has the shell gaping at both ends, thin, white, very hard, sometimes with accessory valves; the two principal valves beset with calcareous inequalities, connected by fine transverse parallel ridges, forming a kind of rasp, used by the animal for boring a hole in rock, wood, or other substance, in which it lives. The animal itself is either club-shaped (as in *Pholas*) or

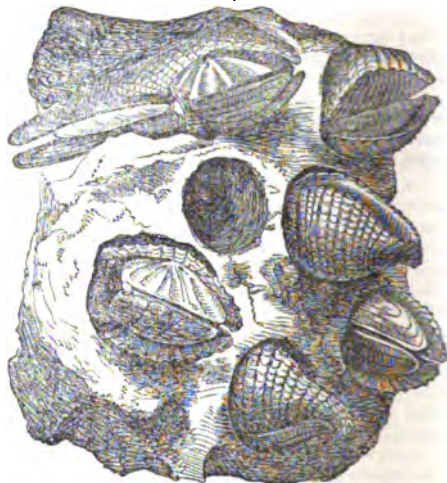

A piece of rock bored by *Pholades*.

worm-shaped (as in *Teredo*), with large long siphons, often united almost to the end, and a short foot. Several species are natives of the British coast. They are popularly called *Piddocks*. They are used for bait, and also for food. How the pholades or piddocks excavate the holes in which they live, sometimes in clay or mud, but often in chalk, and even in much harder rocks, has been the subject of much dispute. An excavating instrument armed with silicious particles, has been ascribed to the animal, but no such instrument exists. The shell is studded with projections, in regular rows, giving it the character of a rasp or file; and the P., fixing itself firmly by its foot, which acts as a sucker, and working itself from side to side, makes use of the rasping power of its shell to enlarge its hole as it has need, so that the hole is always very exactly accommodated to the size of the occupant.

**PHONETIC WRITING** is the representation of speech by means of symbols for the elementary sounds of language. All alphabetic writing is essentially phonetic. The invention of letters was the invention of phonetic writing, as distinguished from the older pictorial, or ideographic, writing. From a variety of causes, however, no language has ever been perfectly represented by its spelling, and with the lapse of time the divergence has gone

on increasing, since the spoken words are constantly undergoing change, while the spelling tends to remain fixed. In English, more especially, this divergence has been allowed to proceed to such an extreme that it is admitted on all hands to be a serious evil, and in recent times various schemes have been projected to remedy it. It is to these schemes of radically reformed spelling that the name of Phonetic Writing is now more especially applied; and what follows, represents the views and arguments of the promoters of the movement, and sketches its history.

The earliest attempts at alphabetic writing were as strictly phonetic as the limited scheme of symbols allowed, or as the limited aim of writers required. The alphabets were confined almost exclusively to consonants; and the analysis of speech on which they were based was of course confined to the languages for which the alphabets were designed. When any old alphabet, therefore, came to be adopted for a new language or dialect, it would be found deficient in the means of writing any sounds which were not used in the language for which the alphabet was originally intended. Unless, then, new symbols were added for the new sounds, these latter must have been represented by conventional combinations of letters; and at this point the writing would cease to be perfectly phonetic.

The Sanscrit language furnishes the most convincing proof of the original phonetic character of alphabetic writing; for not only were words written exactly as they were sounded, but every change which a word underwent in utterance was consistently indicated by a change in the writing. Notwithstanding this fact, there is no language in which the etymological and grammatical relations of words are more clearly exhibited or easily traced than in Sanscrit. Our own language illustrates the same principle. No difficulty is experienced in discovering the relation between *loaf* and *loaves*, *viz* and *wives*, notwithstanding the change of *f* into *v* in the plural; nor would any difficulty be created though the *s* also were changed, as it is in sound, and the words written as they are pronounced—*lovz*, *wivz*.

The English language embraces in its dialects almost all the elementary sounds of all languages; and the Latin alphabet, which was adopted for its writing, was so insufficient in the number of its characters, that many new letters would have been required to adapt it for the representation of Anglo-Saxon and other words. But in place of being extended, the alphabet was reverentially accepted with all its imperfections; its deficiencies were supplemented by the use of servile or silent letters, and by various orthographical expedients; and thus our writing came to be irregular, difficult, and fluctuating. The great inconvenience, however, of representing by the same character the sounds of U and V, led to the introduction of the former as a new letter for the vowel sound, and to the limitation of the latter character to the consonant sound; and the further ambiguity arising from the want of an appropriate sign for the sound of W, led to the invention of that symbol, which, being formed by joining together two of the old V characters, was thence called 'double V'—pronounced, according to the old sound of V, 'double U.' The phonetic principle was fully recognised in these changes, and they furnish precedent for further changes, when a necessity for them shall be sufficiently felt and acknowledged.

There can be no doubt that phonetic writing would greatly facilitate the acquisition of the power of reading, and consequently of the education of children and illiterate adults; as well as tend to

the reduction of dialects to one common standard, and further the diffusion of our language in foreign countries. To learn to read from perfectly phonetic characters, would be merely to learn the alphabet, and to spell would be merely to analyse pronunciation. A child at school might be made a fluent reader in a few weeks. All uncertainty of pronunciation would vanish at the sight of a word, and dictionaries of pronunciation would be superfluous.

Of all the languages which employ the Latin alphabet, the English is the worst represented; in some measure because of the rich variety of its phonic elements, but chiefly because, of all the nations which have adopted Latin letters, the English have done least to make their writing phonetic. Every attempt to correct the anomalies of our orthography has roused a host of prejudices, against which the efforts of private individuals have been powerless. The difference between phoneticians and their opponents seems to be a fundamental difference as to what really constitutes a word. The former, maintaining the *sound* to be the true word, would discard all associations dependent on letters, in order to represent the exact sound in the simplest manner; the latter, clinging to the literal associations of orthography, argue as if the verbal cluster of *letters* in reality constituted the word. The dispute is thus, in effect, between letters and sounds: which are the signs—which the thing signified?

In phonetic writing, the eye would no doubt confound such words as *know* and *no*, *see* and *sea*, *sighs* and *size*, when written separately, as in a vocabulary; but it cannot be supposed that such words would present more ambiguity in contextual usage than they now do in utterance, subject to the same confusion to the ear. At present, we have, in fact, two languages—one purely phonic, addressed to the ear; and the other, in some degree etymological or historical, addressed to the eye. In this respect, we are in a similar position to the Chinese, with their classical ideographic language of literature, and their multitudinous vernacular dialects. In order to establish the assertion, that the phonic word (the sound) written phonetically in a sentence would be less intelligible to the eye than the written word in its present form, it is incumbent on the opponents of phoneticism to shew that the simple phonic word is now less intelligible when pronounced in a sentence, than its written symbol is when read in a sentence.

The principal objection urged against phonetic writing is, that it would obscure the etymological history now discoverable in the orthography of a word. The best answer to this objection is that the traces of etymology, preserved in the present spelling, are so imperfect and inconsistent as to be of little value compared with the embarrassments they occasion in other respects.

The first requisite for the construction of a phonetic alphabet is an exact knowledge of elementary sounds, that every element may be provided with its appropriate symbol, and that no more symbols may be introduced than there are distinct elementary sounds. The latter consideration would be of importance only in connection with a general alphabet available for all languages. An alphabet for any individual language might contain symbols for compound sounds, with no other disadvantage than that of adding to the number of symbols. It would not, for instance, be of any consequence, so far as phonetic writing is concerned, whether the word *sacks* were represented by the letters *saks*, *sacs*, or *sax*, so that the symbols used were invariably appropriated to the same sounds. Orthoepists and phoneticians are not agreed as to what elements compose many of

## PHONETIC WRITING.

our compound sounds, such as those heard in the words *chair, queen, tune, I, out, &c.* Any attempt, therefore, at representing compounds analytically would be premature, until the analysis of the compounds had been settled. This analysis would be absolutely necessary for a general alphabet, but not so for an alphabet for any single language. Phonetic writing, then, should be separately considered, as a means of representing the elementary sounds of all languages, and as a method of symbolising the pronunciation of any one language only. We shall now shew the nature of the attempts that have been made for the phonetic writing of English.

Dr Franklin, in 1768, proposed a phonetic alphabet for English, in which new symbols were introduced for the vowels heard in the words *on* and *up*, and the four consonants heard in the words *she, they, and thing*. Many other schemes have been from time to time proposed; but the only alphabets which have been practically applied on a large scale are those of Dr Comstock in America, and Messrs Ellis and Pitman in England. The object of experimenters in this department has generally been to make use of existing letters as far as possible, and only to supplement deficiencies by new forms. The common alphabet has been made to furnish almost a sufficient number of characters by the inversion of some of its letters—thus, *Δ, Λ, ς, ρ, ε, ϑ, υ, &c.*, as in the 'Anti-absurd' alphabet of Major Beniowski; but the best scheme of phonotypes that has yet been introduced was the joint production of Mr Isaac Pitman, the inventor of the first system of phonetic shorthand writing, and Mr A. J. Ellis, B.A. of Cambridge, a most accomplished mathematician and linguist. This alphabet was completed in 1847; and the experiment of its introduction was carried out with great diligence and perseverance by its promoters, until an army of philanthropic assistants became enlisted in all parts of Great Britain and America. Primers and school-books were issued, and tested on juvenile and adult classes; many works of standard literature, and even the entire Bible, were translated into the new spelling; magazines were published, and ultimately a newspaper, printed in the phonetic character, was started by the enterprising orthographic reformers. In this scheme of phonotypes, diphthongal and articulate compounds were not analysed, and the letters of the ordinary alphabet were retained in their most common signification, seventeen new characters being introduced for unrepresented or ambiguously written sounds. The forms of these were, in most cases, happily suggestive of the displaced orthography, and the general aspect of the writing bore such a resemblance to common typography, that any good reader of the latter could decipher the new printing with ease, after a very brief study of the alphabet. The ordinary vowel letters (A, E, I, O, U) were pronounced as in the words *am, ell, ill, on, up*; the consonants C and G were sounded as in *came* and *game*; the letters K, Q, X were rejected as superfluous, and all the other letters of the common alphabet were retained, with their established sounds. Comparing this scheme of letters with the tabulated elementary sounds of English, we find that it represents all the vowels, except the nice varieties heard in the words *air, ore, err, ask*; and that all the consonants are accurately represented except *wh*. The latter element is written by letters sounding *hoo*, so that the words *where* and *who'er* are made identical to the eye; and the sentence, 'I saw the man *whet* the knife,' is written, 'I saw the man *who* ate the knife.'

Notwithstanding these imperfections, this alphabet was found to work well among those who were disposed for a reform. The phonetic method was

proved to be remarkably simple and easy in comparison with the ordinary system; the time occupied in making fluent readers was greatly reduced; and readers of phonetic printing experienced but little difficulty in the transition to reading from common orthography.

The advantages claimed for the system were chiefly: rapidity of learning to read, certainty of pronunciation, and increased facility in common reading, after the power of phonetic reading had been acquired. The chief disadvantages alleged against the system were: accustoming the eye to a false orthography, and teaching what had to be in great part unlearned after it was acquired. Whether the objectors were right or wrong, they were overpoweringly numerous, and the system failed to do more than prove that phonetic spelling greatly simplifies the acquisition of the power of reading.

The original phonotypic alphabet, described above, has been for some years discarded in the printing issued from the 'Phonetic Institution' (Bath), and a more analytic alphabet has been adopted, in which *eleven*, instead of seventeen, new forms are introduced. The latest edition of this alphabet gives the ordinary vowel letters A, E, I, O for the sounds in the words *am, ell, ill, on*, and the letter U for the sound in *pull*; K is restored, and C rejected; J is used as in French; and the elementary sound of *wh* is still unacknowledged. The eleven new characters represent the consonants in the words *she, oath, they, and (s)ing*; and the vowels in the words *ale, eel, alma, old, all, pool, up*.

The following are the forms of the new letters as printed and written, with a passage exhibiting their appearance in composition.

This Phonetic Alphabet consists of 34 letters, viz., the 23 usual letters of the common alphabet (c, q, and x being rejected), and the 11 new ones below. J is used for the French j (zh), or g in 'edge,' or e in 'vision'; hence *dj* represents J in *John*, and *dg* in *edge*. *Tg* (*t sh*) represents *ch* in *chess*, and *tch* in *catch*. Y and w are consonants; *wh* being replaced by *hw*. The vowels a, e, i, o, u have invariably the short sounds heard in *pat, pet, pit, pot, put*. All the other old letters have their usual signification. The italic letters in the words in the third line denote the SOUNDS of the letters.

### VOWELS.

A a	E e	I i	O o	U u	W w	Y y
a	e	i	o	u	w	y
alma, age, air, sat	all, ope, food		son, bet			
ams, edj, er, it	ol, op, fund	ssn, bst				

### DIPHTHONGS.

si, ei, oi, ou.		C c, H h, I i, J j.
ai, ei, oi, au		L l, N n, O o, P p, Q q, R r.
ay, hy, boy, now.		she, thin, then, sing.
si, bei, boi, nou.		ci, din, den, nig.

### CONSONANTS.

The double letter *u*, as in *suit, ussita, duty, valua*, is written thus: "yunit, yuneit, diuti, valui." When *ai, ei*, &c. make a *dissyllabic* diphthong, the second letter is marked with a diacresis; thus, *sofsay, soiy*.

"'Tiz de meind dat maks de bodi ritq;  
and az de ssn brks dru de darkest klouds,  
so onor 'pireb in de minest habit.  
?Hwot! ?iz de dje mor preqs dan de lark,  
bikos hiz federz ar mor biuntiful;  
or ?iz de ader beter dan de il,  
bikos hiz pentek skin kontents de el.  
O ne, gud Ket; neider art dou de wrrs  
for dis puur fsmritiur and min ara."

## PHONETIC WRITING.

The reduction in the number of letters from that in the Ellis and Pitman alphabet is obtained chiefly at the expense of the phonetic principle, in the attempt to analyse diphthongs in writing, before their correct phonic analysis has been ascertained and settled. Thus, the compound sound in the word *use*, before represented by a single character, is now analysed into the elementary vowels heard in the words *ill* and *pool*; the diphthong in the word *owl* is analysed into the elementary sounds in *on* and *pull*; and the diphthong in the word *isle* is analysed into the elements heard in *ell* and *ill*.

The original phonotypic alphabet was of proved value as an initiatory alphabet, from which the transition to reading from ordinary orthography was easy, and on this ground it had many advocates; the recent modifications, which are doubtful improvements, have been introduced apparently with the view rather of superseding established orthography, and on this ground, it is to be feared, the 'reformed' phonetic alphabet will meet with comparatively few supporters.

But the full advantages of the phonetic principle are not secured to the learner while phonetic writing is used only as introductory to common reading. Phonetic spelling would require to be authoritatively established, so as to be irrefragable in ordinary use, otherwise the learner has still to master the more difficult orthography after the phonetic mode has been learned. At present, spelling is the test of a good vernacular education, and the applicability of this test phonetic writing tends to destroy.

But may not the advantages of phoneticism, so far as simplifying the acquisition of reading is concerned, be obtained by the phonetic teaching of ordinary letters, and without any alphabetic change? Such a result is undoubtedly practicable, as by Mr Bell's method (in his nursery-book of *Letters and Sounds*) of shewing the orthography of a word and its sound together, and teaching the latter only while the learner's eye is accustomed to the former also. Thus, the words *loaf*, *debt*, *wife*, *wreath*, *straight*, &c., are printed *loaf*, *debt*, *wife*, *wreath*, *straight*, &c. The associations of orthography are chiefly fixed by the eye, and this plan for learners preserves the pictorial aspect of words, and shews at once the phonetic spelling and the established orthography.

But the question recurs: Why should established orthography be unphonetic? Or, at least, why should not some national measures be adopted to correct the anomalies of our spelling? A similar work was undertaken by the Spanish Academy in the middle of last century, and carried out so efficiently that, at the present day, the pronunciation of any word in Spanish is immediately determined with certainty by every reader who merely knows the phonetic value of the alphabetic characters. The writing of the Italian, Dutch, and many other languages has also been successfully phoneticised. A similar result would be attained in English, if the work of orthographic revision were submitted to a competent tribunal, and if such changes as might be found necessary were duly sanctioned by authority. New letters should be added to the alphabet for the six unrepresented simple consonant sounds, Sh, Zh, Th, Dh, Wh, Ng; or, at all events, the writing of these elements should be made distinctive; and, with a few rules for distinguishing the vowel sounds, little alteration of spelling would be needed to approximate the writing of English to phonetic accuracy.

A general phonetic alphabet, available for the writing of all the sounds of human speech, is still a scientific desideratum. Such an alphabet would be

of great practical value to travellers, colonists, missionaries, and philologists. Much attention has been paid to this subject of late years. In 1854, a conference of philologists was held in London, at which two rival alphabets were produced, one by Professor Lepsius of Berlin, and another by Professor Max Müller of Oxford. The former has been adopted by the Church Missionary Society, but so many local diversities in the value of the characters have been found necessary in different countries, that this 'Universal Alphabet' has been practically split up into several alphabets. The writing is, besides, overlaid with diacritical points. In the alphabet of Professor Max Müller, the latter difficulty is obviated by a free use of compound letters. The *Lectures on the Science of Language* by this author may be consulted with great advantage, both as to the physiology of speech and the history of words. In the second series of these Lectures, diagrams of the organic formation of many of the elements of speech are given, as well as a comparative table of four alphabets that have been used in the transcription of Sanskrit, and numerous references to the works of continental and other writers who have treated of the science of phonetics.

The most elaborate scheme of a universal alphabet hitherto published is that of Mr A. J. Ellis. In this alphabet 94 sounds are discriminated by means of an ingenious system of compound letters, but the complexity of the writing forbids the possibility of its 'universal' adoption.

The chief difficulty in the construction of a universal alphabet has arisen from the want of a complete classification of elementary sounds; another difficulty has been created by an adherence to the inadequate letters of the Roman alphabet. The resolutions of the alphabetic conference were decidedly in favour of Roman letters as the basis of the proposed 'standard' alphabet. But the wisdom of this decision may be questioned. No existing alphabet exhibits the natural relations of the sounds it represents; and, consequently, although an alphabet physiologically complete were framed, it could not incorporate Roman, Greek, or any other letters at present in use, without sacrificing the most essential qualities of a universal alphabet—simplicity and congruity. Symbols must be devised which would indicate to the eye all the organic relations discoverable by the ear between the various elements, and which would be free from the associations that would attach to adopted letters familiar to the eye with other meanings.

A general or panethnic alphabet must, of course, embody an exhaustive classification of sounds, and its characters should be designed to be *pictorially* suggestive of the organic actions which produce the sounds, so as to be universally intelligible. In this way, a person who had never heard the language or the sound might pronounce it from the physiological writing, if he were only acquainted with the modes of action of the organs of speech, and the representative principle of the alphabet. By means of such a scheme of symbols, all the sounds of every language, including even the laugh, the sigh, the murmur, the groan, the snore, the lisp, the burr, and the imitative sounds practised by ventriloquists, as well as the modulative distinctions of the Chinese, the Hottentot Clicks, and the peculiar inspiratory sounds indulged in by savages, might be represented phonetically with the utmost directive precision, and by a wonderfully small number of radical characters. If ever the utopian dream of a universal language is to be realised, its alphabet must be phonetic, and its elementary symbols not selected from old alphabets, but new, designed from the mouth, pictorial or analogical,

and forming a 'visible speech.' See VISIBLE SPEECH. Phonetic writing on such a basis would not encounter the prejudices that have hitherto defeated the efforts of orthographic reformers; and it would be of considerable immediate service to linguists, besides being a beginning and a promise of the widest utility. For phonetic shorthand writing, see SHORTHAND.

#### PHONOMANIA. See HOMICIDAL MANIA.

**PHOSGENE GAS**, known also as OXYCHLORIDE OF CARBON or CHLOROCARBONIC ACID, is represented by the formula  $\text{COCl}_2$ , or more correctly by its double  $(\text{COCl})_2$ . It is a colourless, suffocating gas, which is formed by exposing equal measures of carbonic oxide and chlorine to the direct action of the sun, when they combine and become condensed into half their volume. It does not possess any acid characters, but water decomposes it into carbonic and hydrochloric acids, as is shewn by the equation  $(\text{COCl})_2 + 2\text{H}_2\text{O} = 2\text{CO}_2 + 2\text{HCl}$ . This gas is of great interest in relation to the artificial production of Urea (q. v.) from inorganic matter.

**PHOSPHATES** (in Physiology). The following phosphates\* play an active part in the chemistry of the animal body.

*Phosphate of Soda*, which may occur under any one of the three forms  $3\text{NaO}, \text{PO}_5$ , or  $2\text{NaO}, \text{HO}, \text{PO}_5$ , or  $\text{NaO}, 2\text{HO}, \text{PO}_5$ . All these salts are soluble in water; and the first two have an alkaline reaction, while the third is acid. By exposure of the second of these salts ( $2\text{NaO}, \text{HO}, \text{PO}_5$ ) to a red heat, it is converted into what is termed *pyrophosphate of soda* ( $2\text{NaO}, \text{PO}_5$ ), in which the phosphoric acid is obviously no longer tribasic, but bibasic; and by similarly treating the third of these salts ( $\text{NaO}, 2\text{HO}, \text{PO}_5$ ), we convert it into the so-called *metaphosphate of soda* ( $\text{NaO}, \text{PO}_5$ ), in which the phosphoric acid is monobasic. It is in consequence of these changes under the action of heat, that the terms *pyrophosphoric* and *metaphosphoric* have been used as synonyms for *bibasic* and *monobasic phosphoric acids*. Phosphate of soda, in one or other of the above forms, occurs as a constituent of all the animal fluids and soft tissues of the body, but is especially abundant in the urine and the bile. There are reasons for believing that it is the second and third of these salts which occur as constituents of the animal body, although the first may possibly sometimes be found. Pyrophosphate and metaphosphate of soda are often found in the ashes of animal fluids or tissues after the process of incineration, but they merely result from the action of heat on the two other salts. The following remarks on the derivation, elimination, and physiological importance of the phosphate of soda, are equally applicable to the corresponding salts of potash, which are always associated with them. The phosphates of the alkalies, which occur in the animal body, obviously owe their origin, either directly or indirectly, to the food; viz., directly, by being ingested as phosphates of the alkalies; or indirectly (within the system), by the action of phosphate of lime on salts of the alkalies. The elimination of these salts from the system is necessary, because they are being constantly supplied by the food; and this process is effected mainly by the kidneys and the intestinal canal. In the carnivorous animals, whose blood is much richer in phosphates than that of herbivora (the ash of the blood of the dog, for example, contains from 12 to 14 per cent. of phosphoric acid, while that of the ox or

sheep does not contain more than from 4 to 6), these salts are carried off by the urine; but in consequence of the formation of free acids as products of the disintegration of the tissues, a portion of the base is abstracted from the originally alkaline phosphates, and a corresponding portion of phosphoric acid is liberated. The originally alkaline salt is thus rendered neutral or even acid; and the occurrence of the acid phosphate of soda,  $\text{NaO}, 2\text{HO}, \text{PO}_5$ , in the urine is thus explained. In the herbivorous animals, on the other hand, the urine contains no phosphates, the whole of the phosphoric acid taken in their food being eliminated by the intestinal canal in the form of the insoluble phosphates of lime and magnesia. Although the general distribution of the phosphates of the alkalies in the nutrient fluids (there is 40 per cent. of them in the ash of the blood-cells; 28.4 per cent. of phosphoric acid and 23.5 of potash in the ash of cow's milk; and about 70 per cent. of phosphoric acid in the ash of the yolk of egg) is in itself an indication of their importance, the exact nature of their functions is not completely understood. Liebig has specially drawn attention to the peculiar grouping of the acid and alkaline fluids of the animal body. The permanence of this grouping is chiefly maintained, especially in herbivorous animals, by the conversion, within the body, of alkaline and neutral phosphates into acid phosphates by the means already described. Moreover, all tissue-forming substances (the protein bodies) are so closely connected with phosphates, that they remain associated during the solution and subsequent re-precipitation of these substances; and the ash of developed tissues (such as muscle, lung, liver, &c.) always affords evidence that acid phosphates existed in the recent tissue; and, further, no exudation from the blood-vessels can undergo transformation into cells and fibres, or, in other words, become organised, unless, in addition to other conditions, phosphates are also present. Another very convincing proof of the share taken by the phosphates in the formation and functions of the tissue, is the fact, that although herbivorous animals take up a very small quantity of phosphates in their food, and although their blood is very poor in these salts, their tissues contain as large a proportion of phosphates as the corresponding parts of carnivora. Lastly, the fact, that one equivalent of the alkaline phosphate of soda ( $2\text{NaO}, \text{HO}, \text{PO}_5$ ) possesses the property of absorbing as much carbonic acid as two equivalents of carbonate of soda, leads us to the belief, that the power of attracting carbonic acid, which the serum of the blood possesses, is due at least as much to the phosphate as to the carbonate of soda, and that, consequently, phosphate of soda plays an important part in the respiratory process.

*Phosphate of Lime* occurs in the organism in two forms, viz., as the neutral or basic phosphate,  $3\text{CaO}, \text{PO}_5$ , and the acid phosphate,  $2\text{CaO}, \text{HO}, \text{PO}_5$ . The neutral phosphate occurs in all the solids and fluids of the body, but is most abundant in the bones, in which it amounts to about 57 per cent.; and in the enamel of the teeth, in which it ranges from 80 to 90 per cent. It may at first sight appear inexplicable how a salt so perfectly insoluble in water as neutral phosphate of lime, can be held in solution in the animal fluids. In some fluids, as the blood, it is probably, in part at least, combined with albumen, with which it forms a soluble compound; while in other fluids, as the urine, it is held in solution by a free acid or by certain salts (as, for example, chloride of sodium), whose watery solutions are more or less able to dissolve it. If any proof is wanted of the functions of this salt in relation to the bones, it is afforded by the well-known experiment

\* The means of distinguishing between the salts of tribasic, bibasic, and monobasic phosphoric acid, are given in the article PHOSPHORUS.

## PHOSPHATIC DIATHESIS--PHOSPHORESCENCE

of Chossat, who shewed that when too small a quantity of it is taken with the food, the bones lose more or less of their hardness and firmness, and fractures do not readily unite. Phosphate of lime, like the phosphates of the alkalis, is indispensable to cell-formation; and as a good illustration of this fact, it may be mentioned that in the mantle of the molluscs (where new cells for the formation of shell abound) this salt is far more abundant than in any other part of the body. Although by far the greater quantity of the phosphate of lime found in the body has doubtless pre-existed in the food, yet it is unquestionable, that a part of it is formed within the organism by the action of carbonate of lime on the phosphoric acid that is formed during the disintegration of the phosphorus-containing tissues, such as the brain, for example. In man and carnivorous animals, a certain portion of the phosphate of lime is eliminated by the kidneys, and the rest is carried off in the excrements; while in herbivorous animals the whole is carried off in the excrements. The acid phosphate of lime is occasionally found in the urine of man and carnivorous animals, but is of no practical importance. For a notice of the amount of earthy phosphates daily eliminated by the kidneys, the reader is referred to the article URINE.

*Basic Phosphate of Magnesia*,  $3MgO, PO_5$ , is analogous, both in its chemical and physiological relations, to the corresponding salt of lime, with which it is always associated. The abundance of this salt in the seeds of the cereals, and in the other ordinary articles of vegetable diet, sufficiently explains its presence in the system. A far less amount of this salt, than of the corresponding lime-salt, seems to be required by the organism, as is shewn by the relative quantities in which they occur in bone (57 of the former to 1.3 of the latter), and as is further indicated by the fact, that, relatively, far more of this than of the lime-salt escapes intestinal absorption, and appears in the excrements.

The only phosphates remaining to be noticed are the *phosphate of ammonia and magnesia*, or, as it is sometimes termed, the triple phosphate,  $2MgO, NH_4O, PO_5 + 2Aq$ , which occurs in beautiful prismatic crystals in alkaline urine, and, indeed, in any specimen of urine that is beginning to putrefy, and the *phosphate of soda and ammonia*, which is occasionally found as a crystalline sediment in putrid urine.

PHOSPHATIC DIATHESIS, in Medicine, designates the condition in which there is a tendency in the urine to deposit *white gravel*. As the deposit of lithates (see LITHIC ACID DIATHESIS) depends upon an excessive acidity of the urine, so that of the phosphates is determined by the opposite condition—namely, by deficient acidity, or by positive alkalescence. Alkalescence of the urine may occur from two distinct causes—viz. (1) from the presence of the carbonate of a fixed alkali (potash, or soda), or of alkaline phosphate of soda (see PHOSPHATES in Physiology); or (2) from the presence of the carbonate of the volatile alkali, ammonia, which is due to the decomposition of urea. This decomposition is due to the fermenting action of the mucus of the bladder on the urea, and is explained

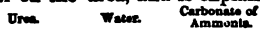

by the equation— $C_2O_4N_2H_4 + 2H_2O = 2(NH_3, CO_2)$ .

The white gravel which is deposited in the second of these conditions—viz, when the urine contains carbonate of ammonia, is composed of minute shining prismatic crystals of the triple phosphate of ammonia and magnesia, whose formula is given in the article PHOSPHATES. This salt is formed as follows: Healthy urine contains phosphate

of magnesia in a state of solution. If, however, the urine become alkaline from the decomposition of the urea, a portion of the ammonia combine with the phosphate of magnesia, and forms the triple salt which is insoluble in the urine, which has now become alkaline. With this triple phosphate, there is almost always an admixture of phosphate of lime ( $3CaO, PO_5$ ) in the form of an amorphous precipitate. The tendency to deposit the mixed phosphates (triple phosphate and amorphous phosphate of lime) is especially observed in cases of disease or injury of the spinal cord, and in disease of the bladder, particularly in chronic inflammation of its mucous coat. Upon allowing urine of this kind, which is usually pale in colour, to stand for some time, an iridescent film or pellicle generally forms upon its surface, which, when examined under the microscope, is found to consist mainly of the salts we have described. Such urine speedily becomes putrid, and evolves a strong ammoniacal odour.

The above is by far the most common form of the phosphatic deposits, but, as has been already stated, the urine may become alkaline from the presence of the carbonate of potash or soda; and then, no ammonia being present, in place of the triple salt, there is a deposition of amorphous phosphate of lime, or in rare cases, of a crystalline stellar phosphate, whose composition, according to Dr Bence Jones, is represented by  $2CaO, HO, PO_5$  (*Journ. of Chem. Soc.* vol. 15). In these cases, the urine is alkaline, pale, copious, slightly turbid, of low specific gravity, and of a peculiar odour. This urine makes reddened litmus paper *permanently* blue; while ammoniacal urine causes only a temporary change in the colour of the same test-paper. As the urine cools, and sometimes even in the bladder, the white sand is deposited, occasionally giving the last portion of the excreted urine a milky appearance. During perfect health, the urine often becomes temporarily alkaline during the act of digestion (when the gastric juice is especially acid); but as a general rule, the tendency to alkalescence from a fixed alkali, and therefore to phosphatic deposits, is associated with general debility. These deposits occur for the most part in sallow, languid, unhealthy-looking persons, whose vital energies have been depressed by mental anxiety, by insufficient food, or by sexual excesses.

In both forms of alkaline urine, and therefore of phosphatic deposits, a generous diet and tonics, such as bark, wine, and the mineral acids (given before meals), are of great service; and opium is usually of great value, if judiciously administered. Small doses of benzoic acid, twice or thrice a day, with the view of restoring the acidity to the urine, and the occasional washing-out of the bladder with tepid injections, have been also found serviceable in the ammoniacal form of the disease.

PHOSPHORESCENCE. Strictly speaking, the term is applied to the phenomenon, exhibited by certain bodies, of remaining luminous in the dark for some time after being exposed to a strong light. In this sense, it is strictly analogous to, perhaps we should say, identical with, the heating of bodies by exposure to light or radiant heat. They absorb part of the energy of the vibrations which fall on them; it becomes motion of their particles; and is again radiated from them as light or heat. Certain preparations, such as Canton's Phosphorus (q. v.), indurated limestone, &c., possess this true phosphorescence in a very high degree. With the great majority of phosphorescent bodies, however, the duration of the phenomenon is very short, rarely more than a small fraction of a second. Becquerel, who has recently studied this phenomenon with great care, has invented a very ingenious instrument



for the purpose, called a *phosphoroscope*. The body to be tried is placed in a small drum, which has an opening at each end. In this drum there revolve two discs, mounted on the same axle, and pierced symmetrically with the same number of holes. They are so adjusted, that when a hole in one disc is opposite to the hole in the corresponding end of the drum, the second disc closes the hole at its end of the drum, and *vice versa*. Light is admitted by one of the holes in the drum, so as to fall on the object, and it is examined through the other hole. It is obvious that when the discs are made to revolve, the object is alternately exposed to light, and presented to the eye. By a train of multiplying wheels, these alternations may be made to succeed each other as rapidly as the observer pleases, and thus the object is presented in the dark to his eye as soon after its exposure to light as may be desired. Almost all bodies are found to be phosphorescent; for instance, some kinds of pink rubies, when exposed to sunshine in this apparatus, appear to glow like live coals in the dark. The phenomenon is, in fact, precisely that which was observed by Brewster and Herschel in quinine and certain crystals of fluor-spar, and thence called *Fluorescence*. Stokes was the first to give the true explanation of these facts, and he shewed it to depend upon the change of refrangibility (i. e., colour) which light suffers on being absorbed and then radiated by the fluorescent substance. The green colouring-matter of leaves, a decoction of the bark of the horse-chestnut, and the common *canary glass* (coloured with oxide of uranium), are bodies which exhibit this phenomenon very well. Perhaps the most striking method of studying the phenomenon is to receive in a darkened room the solar Spectrum (q. v.) on a sheet of white paper; and to pass over the coloured spaces a brush dipped in a solution of sulphate of quinine with sulphuric acid. No change is produced on the less refrangible rays, but in the blue and indigo spaces, a strange change of colour is at once apparent where the liquid has been spread. This appears more strongly in the violet, and vividly in the spaces beyond the violet, where rays fall which excite no luminous sensation in the eye. By this experiment, the visible length of the spectrum may easily be doubled. By using the electric light, which is peculiarly rich in these highly refrangible rays, a prism of quartz, which allows them to pass very freely, and various fluorescent substances, Stokes has obtained spectra six or eight times as long as those otherwise visible. The characteristic of all these rays is, that they are *less* refrangible than those from which they are produced. The entire phenomenon is identical in principle with Leslie's photometer, in which light was measured when changed into heat by absorption, in the coloured glass of which one of the bulbs of his differential thermometer was formed.

Ordinary phosphorus (from which the phenomenon took its name) becomes luminous in the dark by slight friction; whence the common trick of drawing self-luminous figures on doors and walls with a stick of phosphorus, or an ordinary lucifer-match. A similar appearance is presented by putrescent animal matter, such as decaying fish, &c.; but these are effects of slow combustion, or chemical combination, and are not properly classed among the phenomena of phosphorescence. See LUMINOSITY OF ORGANIC BEINGS.

PHOSPHORUS (symb. P, equiv. 31; sp. gr. 1.826) is one of the metalloids, or non-metallic elements, although, in its combining relation, it is more closely connected with the metals arsenic and antimony than with any of the members of the sulphur-group, in which it is commonly placed.

This substance affords an excellent example of allotropy; that is to say, it may be made to occur under different forms presenting different properties. See ALLOTROPY.

Ordinary phosphorus and the red variety are the only important forms. We shall speak of them as phosphorus and red phosphorus respectively.

Phosphorus at ordinary temperatures is an almost colourless or faintly yellow solid substance, having the glistening appearance and the consistence of wax, and evolving a disagreeable alliaceous odour, which, however, is probably due to the action of the oxygen of the air upon it. It fuses at 111.5° into a colourless fluid; and if the air be excluded, it boils at 555°, and is converted into a colourless vapour of sp. gr. 1.826. If, however, it be heated to about 140° in the air, it catches fire, burns with a brilliant white flame, and is converted into phosphoric acid; and, indeed, it is so inflammable that it will catch fire at ordinary temperatures by mere friction. As the burns which it occasions are often severe and dangerous, great caution is required in handling it; and in consequence of the readiness with which it catches fire, and of its tendency to oxidise when exposed to the air at a temperature higher than 32°, it is always kept in water, in which it is insoluble. It is slightly soluble in ether, but dissolves freely in benzol, in the fixed and essential oils, and in bisulphide of carbon; and by allowing its solution in one of these fluids to fall upon filtering paper, the finely divided phosphorus absorbs oxygen so rapidly as spontaneously to catch fire as soon as the solvent has evaporated. One of the most characteristic properties of phosphorus is that it shines in the dark, probably from the slow combustion which it undergoes; and hence its name from the Greek words *phos*, light, and *phoros*, bearing. Its power of forming ozone is noticed in the article on that substance. Taken internally, phosphorus is a very powerful irritant poison; and it is the active ingredient of some of the preparations employed for the destruction of vermin. Its fumes give rise to a peculiar form of necrosis of the jaw, which is very common amongst the makers of lucifer-matches, and is not followed, as in ordinary necrosis, by a formation of new bone.

Red phosphorus differs from the ordinary variety in several important points. It occurs as a deep red amorphous powder, which is perfectly devoid of odour, may be heated to nearly 500° without fusing, has a specific gravity of 2.10, does not shine in the dark, nor take fire when rubbed, undergoes no change on exposure to the air at ordinary temperatures, and is in all respects far less inflammable. Moreover, it is insoluble in bisulphide of carbon and the other fluids in which ordinary phosphorus dissolves, and is not poisonous. On this account, Schrötter (to whom we are mainly indebted for our knowledge of this modification of phosphorus) has attempted, although with imperfect success, to apply it to the formation of lucifer-matches. When red phosphorus is heated in an atmosphere of carbonic acid to a temperature of 500°, it is converted, without loss of weight, into ordinary phosphorus.

Phosphorus is never met with in nature in an uncombined state, but it occurs in small proportion as phosphate of lime in the primitive and volcanic rocks (as was first shewn by Fownes in 1844), by the gradual decay of which it passes into the soil; it is also found abundantly in the minerals known as *apatite* and *phosphorite*, and in the brown rounded pebbles which abound in the Norfolk Crag, and which, under the name of *codrolites*, are much employed, when crushed, for manure. From the soil, it is extracted by plants, which accumulate it

## PHOSPHORUS.

(especially in the seeds of the cereals) in quantity sufficient for the wants of the animals which they supply with food. In the animal system, phosphate of lime forms 57 per cent. of the bones; phosphates of the alkalis, especially of soda, occur freely in the animal fluids; and in fibrine, albumen, and nervous matter, phosphorus is universally present, although we do not clearly know in what form of combination it occurs.

Phosphorus was originally discovered in 1669 by Brandt, a Hamburg chemist, who obtained it from urine. Gahn and Scheele were, however, the first to discover its presence in bone, and to employ that material for its preparation. The following are the leading steps of the method now usually employed in obtaining it on the large scale. Bones are burned to whiteness, and powdered; and this bone-ash is then mixed with sulphuric acid in such quantity as partially to decompose the phosphate of lime occurring in the ash ( $3\text{CaO},\text{PO}_5$ ) into insoluble sulphate of lime, and a soluble superphosphate of lime, whose composition is represented by the formula  $2\text{HO},\text{CaO},\text{PO}_5$ . The solution of the superphosphate is evaporated to a syrup, mixed with charcoal, and submitted to distillation in an earthen retort exposed to a red heat. Phosphorus rises in vapour, and is conveyed, by means of a bent tube, into water, in which it condenses in yellow drops. Two distinct processes take place within the retort. The first consists in the decomposition of the superphosphate of lime into bone-earth and hydrated phosphoric acid; while the second consists in the deoxidation, by means of the carbon, of the liberated phosphoric acid into phosphorus—a process accompanied by the evolution of hydrogen and carbonic oxide gases. After it has been pressed in a fused state through wash-leather, and further purified, it is forced into tubes, in which it is allowed to solidify, and which give it the form of sticks, in which it is commonly met with.

Phosphorus forms with oxygen an oxide,  $\text{P}_2\text{O}$  (which is always produced in small quantity when phosphorus is burned in air, but is of no practical importance), and three acids—viz., hypophosphorous acid,  $\text{PO}$ , phosphorous acid,  $\text{PO}_2$ , and phosphoric acid,  $\text{PO}_3$ . Of these compounds, phosphoric acid is by far the most important, and we shall therefore consider it first in order of the three acids.

*Phosphoric acid* in its anhydrous state, or *phosphoric anhydride*, as it is usually termed at the present day, is represented by the formula  $\text{PO}_3$ , and is obtained by burning phosphorus in a jar of perfectly dry atmospheric air or oxygen, when it is deposited in snow-white flakes at the bottom and on the sides of the jar, from whence it must be removed by means of a platinum spatula as quickly as possible, in consequence of its attracting moisture from the atmosphere, and placed in a perfectly dry flask. When dropped into water, it combines with it, and dissolves, evolving a considerable amount of heat, and emitting a hissing sound, as when red-hot iron and water come together. In consequence of its strong affinity for water, this anhydride is very useful in the laboratory as a desiccating agent.

There are three hydrates of phosphoric acid, each of which possesses the properties of a distinct acid—viz., a protohydrate ( $\text{HO},\text{PO}_3$ ), a deutohydrate ( $2\text{HO},\text{PO}_3$ ), and a tritohydrate ( $3\text{HO},\text{PO}_3$ ). These hydrates retain their characteristic properties when dissolved in water, and combine with one, two, or three equivalents of bases to form salts, according to the hydrate employed. In the salts formed by the first hydrate, the one equivalent of water is replaced by one equivalent of base; in those formed by the second hydrate, both equivalents of water may be replaced by two of base, or one equivalent

of water alone may be replaced, while the other remains in the salt as basic water; while in those formed by the third hydrate, all three equivalents of water, or two, or only one, may be replaced by base, so that this acid forms three sets of salts. Hence phosphoric acid is what is termed a *Polybasic Acid* (q. v.). The following scheme may elucidate this remark: If  $\text{M}, \text{M}', \text{M}''$ , are any three metals, whose oxides act as bases, the monohydrate  $\text{HO},\text{PO}_3$  forms the salt  $\text{MO},\text{PO}_3$ , and is monobasic; the deutohydrate  $2\text{HO},\text{PO}_3$  forms the salts  $\text{MO},\text{M}'\text{O},\text{PO}_3$  and  $\text{MO},\text{HO},\text{PO}_3$ , and is bibasic; the tritohydrate  $3\text{HO},\text{PO}_3$  forms the salts  $\text{MO},\text{M}'\text{O},\text{M}''\text{O},\text{PO}_3$ ,  $\text{MO},\text{M}'\text{O},\text{HO},\text{PO}_3$ , and  $\text{MO},2\text{HO},\text{PO}_3$ , and is tribasic.

The occurrence of phosphoric acid (in a state of combination) in the three kingdoms of nature has been already noticed in our remarks on phosphorus. The discovery of the acid was made in 1740 by Marggraf; the discovery of its true chemical nature is, however, due to Lavoisier; and that of its various modifications and its polybasicity, to the investigations of our illustrious countryman, Graham.

*Phosphorous Acid* occurs both as an anhydride,  $\text{PO}_2$ , and as a hydrate,  $3\text{HO},\text{PO}_2$ . *Hypophosphorous Acid* ( $3\text{HO},\text{PO}$ ) is only known in its hydrated condition, in which it occurs as a very acid, colourless, uncrystallisable syrup.

Phosphorus combines with hydrogen in three proportions to form phosphuretted hydrogen gas,  $\text{PH}_3$ ; liquid phosphide of hydrogen,  $\text{PH}_2$ ; and solid phosphide of hydrogen, P.H. Of these, the first alone requires notice in these pages. There are various processes for obtaining the gas; one of the simplest being by boiling fragments of phosphorus in a concentrated solution of hydrated potash, in which case, hypophosphite of potash is formed, while phosphuretted hydrogen gas is extricated. The reaction is explained by the equation,  $4\text{P} + 3(\text{HO},\text{KO}) = 3(\text{KO},\text{PO}) + \text{PH}_3$ . The gas thus evolved is colourless, possesses a characteristic fetid odour, and has the remarkable property of taking fire spontaneously in atmospheric air or in oxygen gas, and of resolving itself into anhydrous phosphoric acid and water—a phenomenon of which Professor Miller has given the following graphic description: 'If allowed to escape into the air in bubbles, each bubble as it breaks produces a beautiful white wreath of phosphoric acid, composed of a number of ringlets revolving in vertical planes around the axis of the wreath itself as it ascends; thus tracing before the eye, with admirable distinctness, the rapid gyratory movements communicated to the superincumbent air by the bursting of a bubble upon the surface of a still sheet of water. If the bubbles be allowed to rise into a jar of oxygen, a brilliant flash of light, attended with a slight concussion, accompanies the bursting of each bubble.' There is reason to believe that *perfectly pure* phosphuretted hydrogen gas does not possess the power of igniting spontaneously, and that the self-lighting gas always contains a minute quantity of the vapour of the liquid phosphide ( $\text{PH}_2$ ). The luminous phenomenon known as *Will-o'-the-Wisp* has been referred to the natural evolution of the gas; there is, however, no scientific evidence in favour of this hypothesis.

Various compounds of phosphorus with sulphur, chlorine, iodine, bromine, &c., have been formed and investigated; but none of them are of any practical importance.

The medicinal uses of *phosphorus* and *phosphoric acid* have still to be considered. Phosphorus, dissolved in ether or oil, was formerly prescribed in very minute doses as a stimulant to the nervous system in certain conditions. It is, however, now

rarely employed in medicine, at all events, in this country, in consequence of its poisonous properties. Several cases are on record in which children have been killed by sucking the phosphoric ends of lucifer-matches; and Christison relates an instance in which a grain and a half of phosphorus proved fatal.

The symptoms induced by this poison are those of acute inflammation of the stomach and bowels, and the only treatment that can be recommended is the administration of large quantities of mild demulcent fluids, such as milk and thin arrowroot, so as, if possible, to envelop the phosphorus, and exclude it from the action of the air in the intestinal canal; and of magnesia, with the view of neutralising any phosphorous and phosphoric acids that may be formed.

*Dilute Phosphoric Acid* is included in the British Pharmacopoeia, but is not very much employed. It may be prescribed in much the same cases as those in which sulphuric and nitric acids are employed, and is less likely to disturb the digestive functions, if employed for a long period, than the other mineral acids. The late Dr Paris used to recommend it, when properly diluted, as the best acidulated drink for assuaging the thirst in diabetes. It may be prescribed in half-drachm doses.

PHOTIUS, Patriarch of Constantinople in one of the most critical periods of the struggle of that see with the great patriarchate of the West for supremacy in the entire church, was a member of a patrician family of Constantinople, and was born in the early part of the 9th century. From youth, he was distinguished by his abilities and learning; and having served in various important public offices, and especially on a diplomatic mission to Assyria (or more probably Persia), he secured the favour of the Emperor Michael, with whom P.'s brother was connected by marriage, and of the all-powerful Cæsar and favourite Bardas. The Patriarch Ignatius having incurred the displeasure of Bardas and of the emperor, a weak and profligate man, whose vices Ignatius tried in vain to correct, it was resolved to deprive him of the patriarchal dignity; and the attempt to induce him to resign having failed, he was deposed with much indignity, imprisoned, and sent into exile. P., although a layman, and hitherto engaged in secular pursuits, was appointed in his stead, hurried in a few successive days through all the stages of sacred orders, and finally installed as patriarch. A council of bishops, under the influence of the court (858), declared in favour of the deposition of Ignatius, and confirmed the election of P., and the latter communicated his election to the pope, Nicholas I., in a letter which carefully suppressed all these irregularities, and represented that he had reluctantly undertaken the office. Meanwhile, however, Ignatius had privately written to Rome, and the pope sent two legates to inquire and report on the facts. A new council was assembled (859), in which Ignatius was declared deposed, and was compelled to sign the act of abdication, and P. was declared duly elected. The legates concurred, it was believed, under the undue influence of Bardas, in this sentence. But in so doing they had exceeded their power, which was merely to report to the pope; and Nicholas refused to acknowledge the sentence, and summoned the parties to a new hearing. P., however, resisted; and a new cause of dispute having arisen in regard to the jurisdiction claimed by the see of Constantinople in part of the province of Illyricum and among the newly-converted Bulgarians, the council, which Nicholas called at Rome in 862, annulled the acts of that of Constantinople and of the legates, declared P.'s election uncanonical and invalid, deposed and excommunicated him, and

reinstated Ignatius in his see. Being supported, however, by the emperor, P. retained possession, and not only refused to yield, but retaliated on the pope by assembling a council at Constantinople in 867, in which the question was removed from the region of a personal dispute between the bishops to a controversy of doctrine and discipline between the churches of the East and West themselves. In this council, P. first brought forward distinctly certain grounds of difference between the churches, which, although considerably modified, afterwards led to their final separation. In all these doctrinal differences, the council condemned the Western Church, excommunicated Nicholas and his abettors, and withdrew from the communion of the see of Rome. During the life of the Emperor Michael, the authority of P. remained without further question; but on Michael being deposed and put to death by Basilus the Macedonian in 867, P., by that capricious exercise of imperial authority of which these times supply so many examples, was deposed, and banished to Cyprus, and Ignatius reinstated; soon after which, in 869, the council known as the eighth general council, at which Pope Adrian II.'s legates presided, was assembled at Constantinople. The whole case was revised. P. being convicted of fraud, forgery of documents, and uncanonical usurpation, was condemned and excommunicated, the rights of Ignatius established, and the intercommunion of the churches restored. From his exile at Cyprus, P. appealing successfully to Basilus, obtained his recall, and, on the death of Ignatius, was re-appointed to the patriarchate. The pope of the time, John VIII., yielding to expediency, or deceived by false reports, acquiesced in the proceeding—a supposed act of womanish weakness, which, in the opinion of some, by obtaining for John *the feminine sobriquet Joanna*, was the origin of the fable of POPE JOAN (q. v.). P., in 879, assembled a new council at Constantinople, renewed the charge against the Western Church, and erased from the creed in the article on the PROCESSION OF THE HOLY GHOST (q. v.), the word *filioque*, which had been inserted by the Latin Church. The separation of the churches, however, was not completed till the time of Michael Cerularius. See GREEK CHURCH. P. did not die in possession of the see; he was deprived, and exiled to Armenia, by Leo, surnamed the Philosopher, the son and successor of Basilus, in 886, and died soon afterwards, probably in 891. The character of P. is, of course, differently represented by the Easterns and by the Westerns, the latter of whom ascribe to him every excess of craft, violence, and perfidy. The Greeks, on the contrary, defend his memory. It is hardly possible, however, to doubt the substantial justice of the accusations made against him. The impression produced by a review of his chequered career, and of the more than equivocal proceedings with which his name is connected, is made more painful by the evidences of rare genius, and profound and cultivated literary judgment, which his works reveal. His chief remains are (1.) *Myriobiblon*, called also *Bibliotheca*, a summary review of the works which P. had read, with an epitome of the contents, and a critical judgment of their merits. The number of works thus criticised is no less than 279; and as many of these are now lost, the judgment and remarks of such a man are of great value for ancient literary history. (2.) A *Lexicon*, which was edited by Hermann, and afterwards by Porson (or rather from his manuscript by Dobree) in 1822. (3.) The *Nomocanon*, which is a collection of the acts and decrees of the councils up to the seventh ecumenical council, and the ecclesiastical laws of the emperors for the same period. (4.) Several minor theological treatises.

(5.) A collection of letters, many of them extremely interesting and elegant. There is one in which, from his exile, he appeals to be permitted the use of his books, which, for beauty of composition, delicacy of sentiment, and the genuine eloquence of a scholar's love of learning, can hardly be surpassed in ancient or modern literature. A complete edition of his works is found in Migne's *Patrologia Cursus Completus*, in 4 vols., royal 8vo.

**PHOTO-GLYPHIC ENGRAVING.** See PHOTOGRAPHIC ENGRAVING, PHOTOGRAPHY.

**PHOTOGRAPHIC ENGRAVING.** Several ingenious attempts have been made to prepare engraved plates by photogenic action; the earliest of these dates as far back as 1827, which was six years previous to the introduction of the Daguerreotype process, and was the invention of M. Nicéphore Niepce of Paris, who first discovered that thin plates of bitumen were curiously affected by light; he therefore coated metal plates with a thin layer of bitumen, of the kind called Jews' Pitch, and placed them in a camera obscura, so arranged that he could insure their exposure to the same image for several hours. The plate was then submitted to the action of oil of spike, which readily dissolved those portions not acted upon by the light, but exerted little action upon the remainder; the metal exposed by the solution of the bitumen was then acted upon by acid, which produced a complete etching-plate, the picture-part being protected by its bituminous varnish from the action of the acid. About ten years after, M. Fizeau invented another process; he took a Daguerreotype picture, and acted upon it with a mixture of nitric, nitrous, and hydrochloric acids, which, without affecting the silver where the metal was free from the photographic action, quickly attacked the dark portions of the picture in greater or less degree according to their intensity, and thus etched the picture in the plate. The action at first produced only a slight erosion, because a coating of chloride of silver was formed; but upon this being removed by a solution of ammonia, it was repeated until a greater depth was gained. This, at the utmost, was not very great, and never sufficient to print from; but he most ingeniously met this difficulty by coating the plate with a drying oil, which was carefully wiped from the surface, and left to dry in the engraved parts; afterwards, he electrotyped the level surface with gold until the necessary depth was obtained, after which the plate was boiled in a solution of caustic potash, which removed the varnish. The plate in this state required a little of the engraver's art to touch it up, and remedy some defects inherent in the process; and then, to prevent injury to the soft metals—silver and gold—employed, an electrotype plate was taken for the printer's use. But these processes, notwithstanding their extreme ingenuity, never thoroughly succeeded, and have been abandoned for the more satisfactory inventions of Dr W. H. Fox Talbot; these were patented in 1852 (No. 179) and 1858 (No. 875). By his first plan, a steel plate, such as is prepared for engravers, is first dipped into a solution containing acetic and sulphuric acids; it is then coated with a mixture, containing a solution of fine gelatine and bichromate of potash. This is impressed with the image of a photographic negative by exposure in the copying-frame, and washed. The film of gelatine is previously yellow, but the action of the light through the light parts of the photograph change it dark brown, but the remainder is unaffected: consequently, a picture is produced of a light yellow colour on a brown ground. The action of the light is to reduce the bichromate of

potash, and, consequently, to render the gelatine combined with it insoluble; whilst those portions which have been protected from the action of the light by the dark parts of the negative, are still readily soluble in water, and can be removed by soaking: the insoluble portion thus forms a raised picture, which is submitted to a solution containing bichloride of platina in certain proportions, with a little free acid and water, which etches out the exposed parts of the plate, and renders it fit for engraving from. In the same specification is added an ingenious method of giving to the whole picture the appearance of an engraving; it consists in spreading over the gelatinised plate, when nearly dry, a piece of very fine muslin, and evenly pressing it so as to leave an impression of the cross-lines of the textile material upon the surface. By his second specification, he alters the process so far as the washing is concerned, after obtaining the picture on the gelatinised plate, and thus obviates some injuries to which it was thereby rendered liable. Instead of washing, the gelatinised surface is thinly but very evenly covered with finely-powdered copal or other resin, and the under-side of the plate exposed to sufficient heat to melt the resin, so as to form a thin varnish over the whole. The etching fluid is then poured on, and, notwithstanding the resin coating, it acts through to the metal, and eats in wherever the gelatine has not been rendered insoluble by the action of the bichromate of potash and the light. When sufficiently etched, it is washed in clean water, and the plate is freed from the resin and gelatine. Two modifications of this process are given in the Specification, to which the reader is referred for fuller particulars. Dr Talbot calls his process *Photo-glyphic Engraving*. The same processes, with some modifications, applied to zinc constitute *Photo-zincography*, and to stone *Photo-lithography* (q. v.), both of which are largely practised; and they have been brought to such extraordinary perfection, especially by Sir Henry James, Director of the Ordnance Survey in this country, and by an eminent firm in Brussels—Messrs Simonau, Toovey, & Co.—that quite a new era is opened up in the art of engraving and printing.

These processes are particularly well adapted for copying maps and printed books, and Sir H. James has consequently turned it to a most profitable account in producing reductions of the large plans of the Ordnance Survey to the proper sizes of maps; and he has also published perfect fac-similes of Domesday Book and other important documents. See under PHOTOGRAPHY.

**PHOTOGRAPHY** (Gr. *phos*, light, and *grapho*, I write). From the following brief sketch of the history of this art, it will be apparent that its present advanced form has resulted from the combination of various discoveries in reference to the nature and properties of light made by investigators at different periods. Each inquirer has availed himself of the results obtained by previous students, adding to the common stock the results of his own investigations. The progress has been far more rapid than in most of the sciences which have been built up in a similar manner. Like other branches of chemistry, it owes its origin to the alchemists, who, in their fruitless researches after the Philosopher's Stone and *Elixir Vitæ*, produced a substance to which they gave the name of *Luna Cornea*, or Horn Silver, which was observed to blacken on exposure to light. This property of the substance constitutes the leading fact upon which the science of photography is based. More recently, the illustrious philosopher Scheele made experiments with the substance in question, with a view to determine the effects produced

## PHOTOGRAPHY.

upon it by different rays in the solar spectrum. His words are these (published in 1777): 'Fix a glass prism at the window, and let the refracted sunbeams fall on the floor; in the coloured light put a paper strewed with *luna cornea*, and you will observe that the horn silver grows sooner black in the violet ray than in any of the other rays.' Still more recently, the names of Wedgwood and Davy (1802), and of Niepce and Daguerre from 1814 to 1839, occur as followers in the path indicated by Scheele and the earlier savans; and in the early months of the present year (1864), the attention of the Photographic Society of London was occupied by the endeavour to establish the authenticity and true photographic character of some pictures found in the library of Matthew Boulton, and believed to be true sun-pictures by James Watt, the celebrated engineer; thus offering great probability that the mind which produced the wonders of steam-power, had also been engaged in the same investigations which have resulted in the present more extensive development of photographic science. Most of the experiments alluded to may be said to have been based upon the fact, that the salt of silver, called by the ancients *luna cornea*, and by modern chemists nitrate of silver, otherwise lunar caustic (from its use in medicine), is highly sensitive to the influence of light. But such observers must have been fully aware that this substance is not the only one affected by light, for it had been long noticed that the light of the sun does not fall upon any surface without leaving traces of its action thereon. It cannot be absorbed or reflected without in some way modifying the structure and properties of the exposed surface. Even the brick and stone of which our houses are built become blanched by its influence, and those portions on which the shadows of trees or other detached objects fall are perceptibly darker than those exposed to its full force; with the knowledge, therefore, of this all-pervading influence before their minds, the investigations of scientific photographers have been directed to the production of surfaces either of metal, paper, or glass, so imbued with chemical substances as to possess a maximum amount of sensibility to this subtle agent—light.

There seems but little doubt that some of the acute-minded men who investigated the phenomena of the influence of light must have made use of the beautiful invention of Baptista Porta of Padua, known as the Camera Obscura (q. v.); for the pictures of natural objects formed on the inner surface of this instrument would readily suggest its use in combination with the *luna cornea*. We know that, in the later period of the researches made on the subject, the camera was used, and that it has now been universally adopted. The earlier attempts to produce pictures by its means failed, however, in consequence of the want of a power of fixing the images produced by the lens. That want having, by means of chemical investigation, been supplied, the science of photography has become firmly established in its principles, and the practice of it as an art is diffused all over the civilised world. The honour of having been the first to produce pictures by the action of light on a sensitive surface is now very generally conceded to Thomas Wedgwood, an account of whose researches was published in 1802 in the *Journal of the Royal Institution*, under the title: 'An Account of a Method of copying Paintings upon Glass, and of making Profiles by the agency of Light upon Nitrate of Silver; with Observations by H. Davy.' In the experiments detailed in this communication, white paper and *white leather* were imbued with nitrate of silver, and exposed either in the camera obscura,

or under the leaves of trees or wings of insects. The result was, that the shadows preserved the parts concealed by them white, while the other parts became speedily darkened. The misfortune was, that no attempts made either by Wedgwood or Davy to prevent the uncoloured portions from being acted on by light (or, as we now say, to fix the picture), were successful. This operation was not effected in a thoroughly efficient manner until Sir John Herschel suggested the employment of hyposulphite of soda for that purpose. Many other fixing agents had been previously used, as ammonia, iodide of potassium, chloride of sodium, and bromide of potassium, suggested by Mr Fox Talbot; none of these, however, were found equal to the salt proposed and successfully used by Sir John Herschel.

M. Niepce of Chalon-on-the-Saone was the first to enjoy the satisfaction of producing *permanent* pictures by the influence of solar radiations. This was accomplished in 1814, and the name chosen to designate his process was heliography—a name in some respects preferable to photography. It consisted in coating a piece of plated silver or glass with a varnish made by dissolving powdered asphaltum to saturation in oil of lavender, taking care that the drying and setting of this varnish be allowed to take place in the entire absence of light and moisture. The plate so prepared was then exposed in the camera obscura for a length of time, varying from four to six hours! according to the amount of light. A faint image only is at first visible, and this is afterwards developed and fixed by immersion in a mixture of oil of lavender and oil of white petroleum; the plate being finally washed with water, and dried. Light has little or no action on these heliographs; they should, however, be protected from moisture. M. Daguerre improved on this process, by suggesting the use of the resins obtained by evaporating oil of lavender, whereby a great increase of sensibility was secured.

Adopting date of publication as the best evidence of discovery, the next process offering itself for consideration is that for photogenic drawing by Mr Henry Fox Talbot, communicated to the Royal Society on the 31st January 1839, just six months previous to the publication of Daguerre's process. It consisted in immersing carefully selected writing-paper in a weak solution of common salt, and drying it. After this, a dilute solution of nitrate of silver was spread over one side, and the paper again dried at the fire. When dry, it was fit for use, the sensitiveness being much increased by alternate treatment with saline and argentine solutions. Paper thus prepared yielded impressions in an incredibly short time, and nothing could be more perfect than the images it gave of leaves and flowers, the light passing through the leaves delineating every ramification of their nerves. Considerable improvement in point of sensibility was attained by Mr Talbot in the following year, 1840, by the employment of iodide of silver on paper, as a foundation, to be washed over with a mixture of aceto-nitrate and gallo-nitrate of silver, just previous to exposure in the camera. Paper so prepared was so sensitive that an exposure of less than a second to diffused light was enough to produce an impression. After exposure and development, the picture was washed, and fixed by immersion in a solution of bromide of potassium.

Niepce and Daguerre accidentally discovered that they were conducting experiments of a kindred character, and shortly afterwards entered into a partnership. The former, however, dying in July 1833, a new deed of partnership was signed between

his son Isidore and M. Daguerre, which resulted in the publication, in July 1839, of the process known as the Daguerriotype. This was not done, however, until the French government had passed a bill, securing to M. Daguerre a pension of 6000 francs, and to M. Isidore Niepce, the son of the Niepce, a pension of 4000 francs, both for life, and one-half in reversion to their widows. This handsome conduct on the part of the French government was based upon the argument, that 'the invention did not admit of being secured by patent, since, as soon as published, all might avail themselves of its advantages; they, therefore, chose to enjoy the glory of endowing the world of science and of art with one of the most surprising discoveries that honour their native land.'

The discovery of the Daguerriotype may be said to have arisen from the dissatisfaction entertained by Daguerre with the insensibility of the bituminous surfaces of Niepce, which induced him to turn his attention to the salts of silver as a means of producing a higher degree of sensitiveness. This he attained by exposing a highly polished plate of silver (attached, for greater strength, to a copper plate) to the vapour of iodine, by which pure iodide of silver was formed on the surface. The plate so prepared was exposed in the camera obscura for a length of time (20 minutes), which was then considered very short. No apparent effect was produced on the plate, the image being a latent one, arising from a minute molecular disturbance caused by the impact of the actinic rays. The latent image was afterwards developed by exposing the plate to the vapour of mercury; and it is this development of a latent image, reducing as it did the time of exposure from hours to minutes, which truly constituted a new era in the science of photography. It is further due to Daguerre to state, that, while his processes for the purpose were imperfect, he still succeeded in fixing his pictures, although it was reserved for Sir John Herschel to announce the great suitability of the hyposulphites for dissolving the haloid salts of silver. The sensibility of the silver plate was still further increased by Mr Goddard, who suggested, in 1839, the association of the vapour of bromine with that of iodine; while M. Claudet, in 1840, employed chlorine. It is a remarkable fact in connection with these discoveries, that the elder Niepce should, so early as 1820, have tried the treatment of silver plates with the vapours of sulphur and phosphorus.

But the progress of this interesting science received a very important impulse from a discovery, which at first scarcely appeared to have any connection therewith. In 1833, Braconnot gave, in the *Annales de Chimie*, an account of a new substance obtained by the action of nitric acid on starch, sawdust, linen, and cotton-wool. He named this substance Xyloidine; it was very combustible, and burned almost without residue. In 1838, Pelouze, in the *Comptes Rendues*, suggested its application in artillery. He says, 'Plunge paper in nitric acid (specific gravity 1.500), leave it in for two or three minutes, and wash; a kind of parchment is obtained, impermeable to moisture, and extremely combustible.' Dumas, in 1843, proposed the name Nitramidine, and suggested its use for fireworks. At a meeting of the British Association held at Southampton in the year 1846, Herr Schönbein, an eminent Prussian chemist, read a paper on the preparation of explosive cotton, a substance obtained by acting on ordinary carded cotton by a mixture of strong nitric and sulphuric acids. This explosive cotton was afterwards found to be soluble in ether; and the solution so prepared was named collodion by its discoverer, Mr Maynard,

who, in 1848, published in the *American Journal of Medical Science* the formula for its preparation. This ethereal solution having a certain proportion of alkaline iodides and iodide of silver added thereto constituted the collodion first employed by Mr Archer, who, although deserving the credit of having first arranged a practicable working process with collodion for its basis, without which photography could not have attained its present high position, says, in the second edition of his *Manual*, 'it is due to Legray to say that he was the first to publish an account of collodion as a photographic agent;' thus illustrating the candour with which Mr Archer admitted his claim to be considered the first to suggest its value in photography. Mr Fallon Horne and Mr Fry materially assisted Mr Archer in bringing his experiments to perfection. Although the announcement at the British Association in 1846, was to the effect that Schönbein had made cotton as explosive as gunpowder, no particulars were published. In April 1847, he obtained a patent; but in October 1846, Mr Thomas Taylor had published a similar method to that patented. By one of those singular freaks of fortune which sometimes occur, Daguerre succeeded in identifying his name with his process; but Mr Archer was not so fortunate as to give his name to the process which he invented. A reference to the article COLLODION will shew that (bearing in mind that glass perfectly cleaned forms the supporting medium) the sensitive surface is obtained by the conversion of the soluble iodides and bromides in the collodion film into iodide and bromide of silver by immersion in a solution of the nitrate of that base, and that it is exposed in the camera while still moist with adherent nitrate, the latent image so obtained being developed with a mixture of pyrogallic acid, acetic acid, and alcohol, fixed with hyposulphite of soda, and varnished.

In the Niepçotype or albumen process, glass plates of proper thickness and quality, and perfectly clean, are coated with Albumen (q. v.), to which an alkaline iodide has been added. When perfectly dry, they are immersed in a solution of nitrate of silver, when an immediate decomposition takes place; iodide of silver being formed in the albumen film, and nitrate of potash or ammonia remaining in solution. The plate is then freely washed with water, dried, exposed, developed with gallic acid, and fixed with hyposulphite of soda.

A retrospective glance will shew the reader that four processes have now been passed in review; and on a little consideration, it will be seen that one principle pervades the whole—viz. the production of a latent image by the action of light on iodide and bromide of silver, its subsequent development by suitable means, and the final removal of the unaltered portions of the sensitive film by a fixing agent.

Among these processes, that in which collodion is employed has achieved a well-merited distinction, and is now so generally employed, as almost entirely to exclude the others. Various modifications of this process have been from time to time suggested to meet the exigencies of landscape photography. It has already been stated that the collodion film is exposed while still moist with adherent nitrate of silver solution; and this method is especially applicable to the taking of portraits, where it is desired to reduce the time of exposure to a minimum; but for landscape purposes, it is by no means so imperatively necessary to curtail the time of exposure; and as the necessary apparatus and materials for sensitising and developing a wet plate are somewhat cumbersome for field-work, it was suggested by the Abbé Despratz to wash off the free nitrate from the

## PHOTOGRAPHY.

surface, and allow the film to dry in the absence of light. A number of sensitive plates can be prepared by this method in anticipation of a journey. This is called the 'Dry Collodion Process.' A plate so prepared is much inferior in point of sensitiveness to a wet plate, and this arises as much from an altered molecular condition of the iodide of silver as from the absence of free nitrate of silver. The Abbé Despratz introduced resin into his collodion, with the view of keeping the pores open. The pictures obtained by his process were, however, difficult to develop without stains; and a variety of agents have since been used, both from the organic and inorganic kingdoms, to preserve the film in the same molecular condition when dry as when wet. Among these may be mentioned nitrate of magnesia, honey, oxymel, and a host of other materials, such as sugar, albumen, infusion of malt, and lastly tannin, which last preservative agent bids fair to supersede all others.

The practice of photography in the present day is confined almost exclusively to the POSITIVE, the NEGATIVE, and the DRY COLLODION Processes. In the *first*, the object is to obtain in the camera a direct image, which is to be viewed by reflected light; and as it is desired that the pictures so produced should possess pure blacks and whites, an inorganic (nitric) acid is used in the bath, and the developer—protosulphate of iron—is also of inorganic origin, these being the conditions best calculated to produce a deposit of pure *white* metallic silver. In the *second*, however, an image possessing density to transmitted light is required; accordingly, an organic (acetic) acid is used both in the bath and developer; and in order still further to insure an efficient supply of organic matter to combine with the silver at the moment of its reduction, pyrogallic acid is sometimes exclusively used. The *third* or dry process is distinguished from the preceding modifications of the wet process by the complete removal of the adherent free nitrate of silver, the application of a preservative agent, and the necessity for adding nitrate of silver to the developer.

It will be desirable, before concluding this article, to refer to some of the various applications of photography which have been made since the principles of the science have been well understood.

PHOTO-LITHOGRAPHY, the application of photography to engraving on stone. A lithographic stone is coated with a mixture of water, gum-arabic, sugar, and bichromate of potash, dried in the dark, exposed in the camera, or under a negative. The effect of the luminous action is to render the gum almost insoluble. A solution of soap is then applied, which serves the double purpose by its decomposition of yielding a greasy printing-surface, and by its solvent action to remove those portions unacted on by light: its action being inversely proportionate to the extent to which the gum was fixed by the light. In this condition, the stone is freely washed with water, and when dry, receives a coating of printer's ink from the roller, which, by uniting with the soap, gives additional body to the picture. This process was patented by Mr W. E. Newton; but, in common with others of a kindred character noticed in this section, the resulting pictures were invariably deficient in middle tint, possessing a degree of hardness very unpleasant to the eye, and satisfactorily accounting for its not coming into general use.

PHOTO-XYLOGRAPHY, the application of photography to wood-engraving. One process, patented by Mr Newton, consisted, first, in rubbing into the wood-block a varnish, composed of asphaltum, ether,

and lamp-black, to saturate the pores. Collodion was then poured on as in the ordinary Collodion process (q. v.). The surface was then sensitised, and exposed in the camera, the picture being developed in the usual way. But the desired success was not complete, for the thickness of the united films was found to interfere with the operations of the engraver, and the process, in consequence, did not receive general adoption.

W. Crookes, F.R.S., subsequently simplified the method of producing an impression on wood-blocks, by rubbing them over with a mixture of oxalate of silver and water, and exposing under a negative. The advantage of this process was, that it did not require any treatment of the block for the purpose of fixing after exposure, as if kept from the *continued* action of light, the block would keep long enough for the engraver to work out the details with his tools. It is fair to assume, notwithstanding the ingenuity displayed in these processes, that some insuperable objection exists in both of them, since neither have been adopted to much extent.

PHOTO-MICROGRAPHY consists in the enlargement of microscopic objects, by means of the microscope, and the projection of the enlarged image on a sensitive collodion film. The manipulatory details are the same as in the Collodion process (q. v.), only that, on account of the delicate nature of the markings to be rendered, it is necessary to employ a collodion yielding what is termed a structureless film. The principle upon which the enlargement is effected is that of the conjugate foci. This branch of microscopic and photographic science has proved a useful aid in the study of the sciences of Botany, Physiology, and Entomology, by delineating, with unerring accuracy, woody fibre, ducts, starch granules, muscular fibre, blood discs, nerve papillae, &c. Among the numerous experimenters attracted by this interesting study, Dr Maddox is perhaps the only one who has attained to any renown; and by him, minute animalcules, all but invisible by unassisted vision, have been magnified to a superficial area of three square inches, in which the most delicate details have been faithfully preserved. By reversing the arrangement necessary for these enlargements of microscopic objects, it will be seen that minute photographs of engravings, or other objects, may be produced which would require a microscope for their inspection, and it has been suggested that in this way war despatches might be transmitted in the setting of a ring or breast-pin; and this is really by no means so difficult to accomplish as it may seem at first sight, since photographs no larger than a pin's head have been produced, including in that small space portraits of no less than 500 eminent men.

CELESTIAL PHOTOGRAPHY comprehends the application of photography to the automatic registration of celestial phenomena. The labourers in this field of scientific research have been numerous both in America and Europe; the name of Mr Warren de la Rue, however, stands out so prominently before all others, that in the limited space at command, it is scarcely necessary to do more than notice the leading facts established by his researches. Not the least interesting of these is the demonstration of the sphericity of the moon by means of the stereoscope and lunar photographs, also the determination of the nature of many of the more obscure markings on its surface, by which elevations are clearly distinguished from depressions. The *faculae* or spots on the sun's surface have also been photographed, and examined stereoscopically, by which they have been found to arise from elevations of the outer regions of the photosphere. Photographs

## PHOTO-LITHOGRAPHY—PHOTO-SCULPTURE

have also been obtained of Lyra and Castor, and of the nebulae in Orion. The instrument employed for the purpose is called a Photo-heliograph.

**PHOTO-GALVANOGRAPHY**, a method of producing from a photograph an electrotype copper-plate in a state fit for printing. It was invented by Mr Paul Pretsch of Vienna, and is dependent on the property which unaltered gelatine possesses of swelling up in water. In order that a plate should be fit for engraving, it is of course essential that it should have on its surface elevations and depressions corresponding to the lights and shadows of the picture. Accordingly, the first operation consists in coating a glass with a solution of gelatine and bichromate of potash, and when this is dry, exposing the same to light under a negative. In accordance with the above-named property of gelatine, it will be found, on applying water to the film, that the portion unacted on will swell up, while those parts upon which the actinic rays have exercised their full influence, will remain unchanged by the water. From the image thus obtained, a gutta-percha mould is prepared, and its surface made conducting by means of levigated graphite or bronze-powder. Copper is then deposited thereon by the electrotype process, and the plate thus produced is printed from in the ordinary way.

**PHOTO-GLYPHOGRAPHY** is a process, invented by Mr Fox Talbot, for etching a photograph into a steel plate. It consists in coating the plate with a mixture of bichromate of potash and gelatine, and exposing under a negative. The effect of this treatment is to render the gelatine insoluble, just in proportion to the intensity of the light's action, after which a solution of perchloride of iron, of a certain definite strength, is poured over the film, which solution penetrates those parts unacted on by light, reaching the steel plate, and biting itself in, but is repelled by that portion of the gelatine rendered insoluble; the plate being thus protected from the action of the solvent. Because a dilute solution of perchloride of iron soaks into a film of gelatine more readily than a strong solution, it is very important that the etching fluid should possess that amount of dilution which has been found by practice to yield the best results.

**PHOTO-LITHOGRAPHY.** See **PHOTOGRAPHIC ENGRAVING, PHOTOGRAPHY.**

**PHOTO-METER** (Gr. *phōs*, light; *metron*, measure), an instrument for measuring the intensity of light. The first who occupied himself in scientifically determining the intensity of light was Bouguer; but his investigations were far surpassed by those of Lambert, about 1760. The latter indicated an exceedingly simple and effective kind of photometer, which was afterwards constructed by Rumford. The instrument consists of a screen of thin paper placed vertically, and behind it, at the distance of a few inches, is placed a cylindrical stick, or any other similar body. When the intensity of light from two flames is to be compared, they are placed behind this stick in such a way that each casts a separate shadow of the stick upon the paper screen. The observer stands in front of the screen, and directs the removal of the two lights either to or from the stick, till the shadows which are cast upon the screen are equally obscure. The distance of each light from the shadow it casts on the screen is then measured; and the squares of these distances give the relative intensities of the two lights. This photometer may also be modified by employing, instead of a cylindrical stick, a second screen parallel to the first, but of greater thickness, and having an aperture cut in its centre. The two lights being then placed behind the second screen,

and considerably apart, each casts a separate illumination through the aperture in the second upon the first screen, and the observer in front of the latter changes their relative distances till the illuminations appear to the eye of equal intensity. The calculation is the same as before. There are several other classes of photometers, which, however, do not deserve the name, as they depend upon the heating and chemical powers which generally accompany light, and not upon the intensity of its action on the organs of vision. Thus, Leslie's instrument is nothing more than a differential thermometer, while Saussure's and Landriani's depend upon the chemical effects of light. Lam-padius, instead of calculating the intensities from the different distances of the lights from the screen, used plates of horn, or other semi-opaque material, of various thicknesses, and deduced his results from the comparative thickness of the two plates. The results attained by the aid of the photometer, owing to the imperfection of the instrument, are to be relied upon only within certain limits. Some of them are as follows: the light of the sun is 94,500 times greater than that of the moon; and an ordinary Argand lamp, with cylindrical wick, is equal to nine newly-trimmed candles.

**PHOTO-SCULPTURE**, a new art, invented, during the present year, by M. Willème, a Frenchman. It has been introduced into Great Britain, and is successfully practised by M. Claudet in London, and a society has been formed for carrying it out in Paris. It consists in taking likenesses in the form of statuettes and medallions by the aid of photography, and a very ingenious series of accessory contrivances. A building specially adapted for the purpose is absolutely necessary; this consists of a circular room, 40 feet in diameter, and surmounted by a glass cupola 22 feet high, the supporting wall being about 8 feet in height, and pierced with 24 equidistant holes about 4 feet from the floor; these are only sufficiently large to permit the action of an ordinary camera lens through each one. Outside the surrounding wall of this circular chamber is a covered dark passage, in which twenty-four cameras are placed with their lenses adjusted

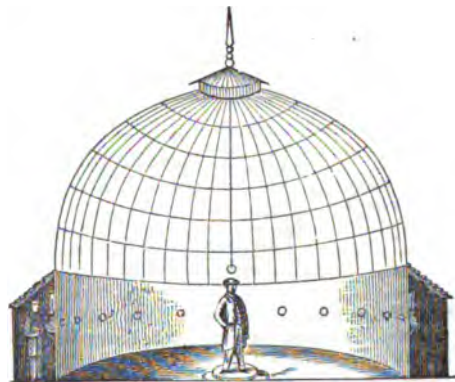

Fig. 1.

to the holes in the wall. The person whose likeness is to be taken stands in the centre under the glass dome, and at a given signal the cameras are simultaneously brought into action, and a photograph is taken. The whole of this arrangement will be fully understood by reference to fig. 1.

The twenty-four photographs are carefully numbered, so that no error can take place in the



PHOTO-ZINCOGRAPHY—PHRENOLOGY.

subsequent operation, which is performed in another chamber: any room which can be darkened will do. It consists in placing them in consecutive order on a

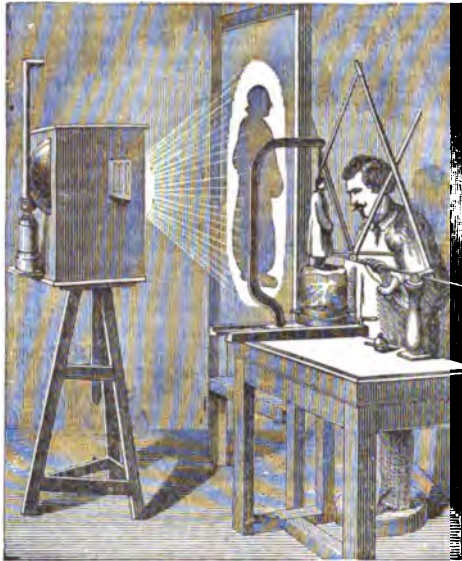

Fig. 2.

vertical wheel, which is so arranged that at the will of the operator each one can be brought before the lens of a magic lantern, and its image projected on a

transparent screen, as in fig. 2. The modelling clay is so placed, rather behind the screen, that the artist can use a pantograph, which has its reducing point armed with a moulding or cutting tool instead of a mere marker; and as the longer arm of the instrument describes the outline of the projected figures obtained from the photographs, the shorter one is reproducing on a smaller scale the figure in the clay. The statuette thus produced requires retouching with the hand to remove the sharp and rugged lines of the cutting-tools, and of course much depends upon artistic skill in doing this. In the skilled hands which have yet had to do with its operations, the arrangement has had so marked a success as to promise to produce in time the most satisfactory results.

**PHOTO-ZINCOGRAPHY.** See PHOTOGRAPHIC ENGRAVING.

**PHRAGMITES.** See REED.

**PHRASE**, the name given, in Music, to the simple motives containing in themselves no satisfactory musical idea, which enter into the composition of every melody containing a perfect musical

idea, e. g.,  The phrase

most usually consists of two measures; in compound time, it may be comprised in one measure, and an extended phrase is one which contains three measures. In the more simple and regular forms of musical composition, two phrases unite to form a section ending in a cadence; and a perfect musical idea is formed of two such sections terminating the first with the dominant, the second with the tonic harmony.

A little confusion has arisen from the use, by some musical writers, of the word phrase for what is here called a section.

**PHRENITIS.** See MENINGITIS.

**PHRENOLOGY** is a Greek compound signifying a discourse on the mind, but is used in a more limited sense to mean a theory of mental philosophy founded on the observation and discovery of the functions of the brain, in so far as it is concerned in intellectual and emotional phenomena. Phrenology takes into view likewise the influence of all other parts of the body, and of external agents affecting these, upon the brain.

The founder of this system was Dr Franz Joseph Gall (q. v.), who died in 1828. In Britain, it has been amply expounded by his pupil Dr Spurzheim (q. v.), by George and Andrew Combe (q. v.), by Dr Elliotson of London, and others. In America, Dr Charles Caldwell has been its ablest advocate. Gall's method of investigating the functions of the brain is that which, applied to other organs, has led to the discovery of their functions, but which had never before been systematically applied to the brain. When a physiologist wished to ascertain the function of any part of the body, he did not rest satisfied with examining its structure, and speculating on the purposes for which that structure seemed to be

## PHRENOLOGY.

adapted. He observed what kind of function appeared during life as the invariable accompaniment of the presence and action of that particular part; and, by repeated and careful observation, he at last succeeded in discovering the function. The knowledge thus obtained was afterwards verified and completed by examination of the structure, and observation of the effects of its injury or diseases. To the adoption of this principle in studying the functions of the brain, Gall was led by observing at school the concomitance of a quick and retentive memory of words with a peculiar appearance of the eye, which he afterwards found to be caused by a large development of a particular part of the brain. At school, at college, and in many other places, and under the most different circumstances, the same concomitance of talent with development of brain came under his notice so frequently, as to suggest to him the probability that there might be discovered by the same method a connection of other talents and dispositions with other portions of the brain. It was by the diligent application of the method of inquiry which accident had thus suggested to him, and not, as some suppose, by the exercise of his imagination, that Dr Gall was at last led to conclude, first, that the brain is an aggregate of many different parts, each serving for the manifestation of a particular mental faculty; and, secondly, that, *all other conditions being equal*, the size of each of these cerebral organs is a measure of the power of its function. These two propositions constitute the distinctive or fundamental principles of Phrenology. The first of them, however, is not new. The impossibility of reconciling actual phenomena with the notion of a single organ of the mind has, for many centuries, suggested the probability of a plurality of organs in the brain. But the phrenologists hold that Dr Gall was the first to *demonstrate* the fact, and to make any considerable progress in determining with what parts of the brain the various intellectual and emotional faculties and susceptibilities are connected.

That man, in his present state, cannot think, will, or feel without the intervention of the brain, is generally admitted by physiologists, and appears from even the fact that, by pressure applied to it, consciousness is at once suspended. That it is not a single organ is *a priori* probable from such considerations as these: 1. It is a law in physiology that different functions are never performed by the same organ. The stomach, liver, heart, eyes, ears, have each a separate duty. Different nerves are necessary to motion and feeling, and there is no example of confusion amongst them. 2. The mental powers do not all come at once, as they would were the brain one organ. They appear successively, and the brain undergoes a corresponding change. 3. Genius varies in different individuals: one has a *turn*, as it is called, for one thing, and another for something different. 4. Dreaming is explained by the doctrine of distinct organs which can act or rest alone. 5. Partial insanity, or madness on one point with sanity on every other, similarly points to a plurality of cerebral organs. 6. Partial injuries of the brain, affecting the mental manifestations of the injured parts, but leaving the other faculties sound, tend to the same conclusion. 7. There could be no such state of mind as the familiar one where our feelings contend with each other, if the brain were one organ.

These are grounds for presuming that the brain is not single, but a *cluster of organs*, or at least that it is capable of acting in parts as well as in whole. For this conclusion the phrenologists consider that they have found satisfactory proofs in numerous observations, shewing that particular manifestations

of mind are proportioned, in intensity and frequency of recurrence, to the size or expansion of particular parts of the brain—this law being subject to modification in the case of the brain, as in that of the muscles and other parts of the body, by differences of health, quality, exercise, &c.

If size of organ, *ceteris paribus*, is the measure of the vigour of function, it is of great moment in what region of the brain the organs are largest—whether in the animal, moral, or intellectual. On this preponderance depends the character. Two brains may be exactly alike in size generally, yet the characters may be perfect contrasts to each other.

It is held by phrenologists—1. That by accurate observation of human actions, it is possible to discover the strength of the dispositions and intellectual powers of men; 2. That the form of the brain can, in normal subjects not beyond middle age, be ascertained with sufficient accuracy from the external form of the head—the brain, though the softer substance, being what determines the shape of the skull; 3. That the organs or parts of which the brain is composed appear on its surface in folds or convolutions, which have a well-ascertained fibrous connection with the *medulla oblongata*, which unites the brain to the spinal cord; 4. That the brain being divided into two equal parts called *hemispheres*, in each of which the same organ occurs, all the organs are double, like the ears and eyes. See BRAIN. But when the term *organ* is used, both organs are meant.

It is true that where strength is most needful, the skull is thicker than at other places; but this is not overlooked by phrenologists, nor do they fail to warn observers against mistaking for signs of cerebral development the bony processes and ridges which serve for the attachment of muscles to the skull. See SKULL. They recognise also, as we shall see, the uncertainty often occasioned by the frontal sinus.

Besides the brain proper, there is a smaller brain, lying below the hinder part of the main brain, and called the *cerebellum*.

The brain is divided into the *anterior, middle, and posterior lobes*. The anterior lobe contains the organs of the intellectual faculties; the posterior lobe and lower range of the middle one are the regions of the animal propensities; while the moral sentiments are stated to have their organs developed on the top or coronal region of the head.

Phrenologists distinguish between *power* and *activity* in the mental faculties. Power, in whatever degree possessed, is *capability* of feeling, perceiving, or thinking; while activity is readiness and quickness in the exercise of power.

The powers of mind, as manifested by the organs, are called *faculties*. A faculty may be defined to be a particular power of thinking or feeling. A faculty is regarded as elementary or primary—1. When it exists in one kind of animal, and not in another; 2. When it varies in the two sexes of the same species; 3. When it is not in proportion to the other faculties of the same individual; 4. When it appears earlier or later in life than the other faculties; 5. When it may act or repose singly; 6. When it is propagated from parent to child; and 7. When it may singly preserve its soundness, or singly become deranged or extinct.

The faculties are usually divided by phrenologists into two orders—FEELINGS and INTELLECT, or AFFECTIVE and INTELLECTUAL FACULTIES. The Feelings are divided into two genera—the *Propensities* and the *Sentiments*; while the Intellectual embrace the *Perceptive* or *Knowing*, and the *Reflective Faculties*. This classification, however, is avowedly imperfect.

## PHRENOLOGY.

The following is a representation of the human head in four points of view, shewing the positions of the cerebral organs, according to Mr Combe :

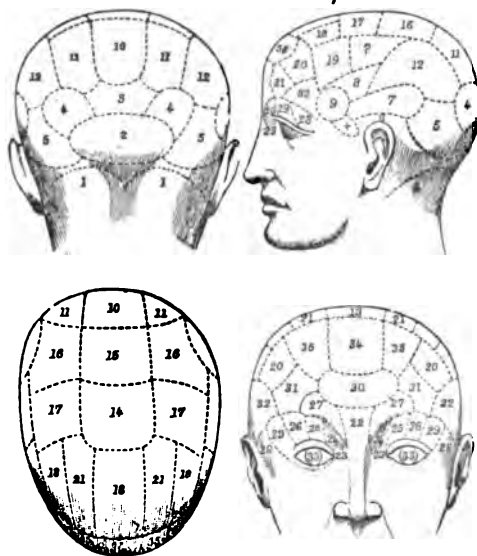

### AFFECTIVE.

#### I.—PROPENSITIES.

1. Amativeness.
2. Philoprogenitiveness.
3. Inhabitiveness or Concentrativeness.
4. Adhesiveness.
5. Combativeness.
6. Destructiveness. [Alimentiveness.] [Love of Life.]
7. Secretiveness.
8. Acquisitiveness.
9. Constructiveness.

#### II.—SENTIMENTS.

10. Self-esteem.
11. Love of Approbation.
12. Cautiousness.
13. Benevolence.
14. Veneration.
15. Firmness.
16. Conscientiousness.
17. Hope.
18. Wonder.
19. Ideality.
20. Wit, or Ludicrousness.
21. Imitation.

### INTELLECTUAL.

#### I.—PERCEPTIVE.

22. Individuality.
23. Form.
24. Size.
25. Weight.
26. Colouring.
27. Locality.
28. Number.

29. Order.
30. Eventuality.
31. Time.
32. Tune.
33. Language.

#### II.—REFLECTIVE.

34. Comparison.
35. Causality.

1. *Amativeness*, or sexual love, is believed to have for its organ the cerebellum, or at least a portion of it. As the basis of domestic life, this faculty is of great importance, and its regulation has ever been one of the prime objects of moralists and legislators.

2. *Philoprogenitiveness*, or love of offspring, is generally strongest in the female. Its organ is one of the easiest to distinguish in the human head. Those who are flat and perpendicular there, instead of being delighted, are annoyed by children. The feeling is said to give a tender sympathy with weakness and helplessness in general. The most savage races must have affection for their young, or they would become extinct. The organ, like the other cerebral parts, may become diseased; and insanity on the subject of children often occurs.

3. *Inhabitiveness* (called by Mr Combe *Concentrativeness*) has its organ immediately above the preceding. Dr Gall did not discover its function; and Dr Spurzheim, observing it large in persons attached to their native place, or any place in which they had long dwelt, called it *Inhabitiveness*. Mr Combe thought it has a more extended sphere

of action. He observed it large in those who can detain continuously their feelings and ideas in their minds; while the feelings and ideas of others pass away like the images in a mirror, so that they are incapable of taking systematic views of a subject, or *concentrating* their powers to bear on one point. The organ is stated as only probable, till further facts are obtained.

4. *Adhesiveness*.—The organ of this feeling was discovered by Gall, from being found very large in a lady remarkable for the warmth and steadiness of her friendships. It attaches men and gregarious animals to each other, and is the foundation of that pleasure which mankind feel in bestowing and receiving friendship, and in associating with each other. Acting with *Amativeness*, it gives constancy and duration to the attachment of the married. Generally speaking, *Adhesiveness* is strongest and its organ largest in woman.

5. *Combativeness*.—Dr Gall discovered the organ of this propensity by a vast number of observations on the heads of persons fond of fighting. Dr Spurzheim extended its function to *contention* in general, whether physical or moral. Those deficient in it shew that over-gentle and indolent character which yields to aggression, is easily repelled by the appearance of difficulty and trouble, and naturally seeks the shades and eddy-corners of life.

6. *Destructiveness*.—The propensity to destroy is abundantly manifested by man and carnivorous animals, and when too strong or ill-regulated is the source of cruelty and wanton mischief. As a defensive power, it is of high utility. Anger, resentment, and indignation spring from it. A small endowment is one of the elements of a 'soft' character; while persons who have much of it are generally marked by an energetic, and probably fierce and passionate character.

*Alimentiveness* and *Love of Life*.—Some of the recent phrenological works treat in this part of the order of the faculties, of a faculty of *Alimentiveness*, or the propensity to eat and drink, and also of another which follows—viz., *Love of Life*. The first being represented as no more than *probable*, and the second as only *conjectural*, they have no number allotted to them on the bust. The place assigned to *Alimentiveness* is marked by a cross on the side-view of the bust. Mr Combe suggests that the organ of the *Love of Life* is probably a convolution at the base of the middle lobe of the brain, the size of which cannot be ascertained during life.

7. *Secretiveness* is the propensity to conceal, which in excess assumes the form of cunning. It helps animals both to avoid and to prey upon each other. In abuse, it leads to lying, hypocrisy, and fraud, and with *Acquisitiveness* disposes to theft and swindling. The organ is subject to disease, and cunning madmen are difficult to deal with. Disease here often leads to belief in plots and conspiracies formed against the patient.

8. *Acquisitiveness*.—The existence of a cerebral organ for the desire of property is held by phrenologists to prove that this is not, as many have thought, a derived or secondary tendency. It is what Lord Kames calls the 'hoarding appetite.' This explains the miser's desire to accumulate money, without regard to its use in the purchase of other enjoyment. When the organ is diseased, persons in easy circumstances are sometimes prone to pilfer everything of value, and often of no value, which comes in their way.

9. *Constructiveness* is the impulse to fashion and construct by changing the forms of matter. Many of the inferior animals possess it, as the bear, bee, and birds. Physical nature consists of raw

materials which Constructiveness prompts and enables man to adapt to his purposes.

10. *Self-esteem* is the source of that self-competency which enhances the pleasures of life, gives the individual confidence in his own powers, and enables him to apply them to the best advantage. It is sometimes called proper pride, or self-respect, in which form it aids the moral sentiments in resisting temptations to meanness and vice. Its deficiency renders a man too humble, and the world take him at his word, and push him aside. Its excess produces arrogance, selfishness, disobedience, and tyranny. Self-esteem becomes insane perhaps more frequently than any other faculty, and then shews itself in extravagant notions of self-importance. Such maniacs fancy themselves kings, emperors, and even the Supreme Being. The organ is generally larger in men than in women; and more men are insane from pride than women.

11. *Love of Approbation* is the desire of the good opinion, admiration, and praise of others. It is an excellent guard upon morals as well as manners. The loss of character, to those largely endowed with it, is worse than death. If the moral sentiments be strong, the desire will be for honest fame; but in meaner characters, the love of glory is a passion that has deluged the world with blood in all ages. Shamelessness is the effect of its deficiency, often observed in criminals. The organ oftener becomes diseased in women than in men, as in women it is more active than in the other sex generally.

12. *Cautiousness*.—The organ of this faculty is found large in persons much troubled with fears, hesitations, and doubts. Its normal character is well expressed by its name. When diseased, as it often is, the organ produces causeless dread of evil, despondency, and often suicide.

13. *Benevolence* is the desire to increase the happiness and lessen the misery of others. When strong, it prompts to active, laborious, and continued exertions, and, unless Acquisitiveness be powerful, to liberal giving to promote its favourite object. Unregulated by Conscientiousness and Intellect, Benevolence degenerates into profusion and facility. It often coexists with Destructiveness in great force; as it did in Burns, whose poem on a Wounded Hare expresses both feelings highly excited.

14. *Veneration* has for its object *whoever and whatever is deemed venerable* by the individual. One man venerates what another treats with indifference, because his understanding leads him to consider that particular object as venerable, while his neighbour deems it otherwise. But any man with a large endowment of the organ will have a tendency to consider others as superior to himself. Veneration is the basis of loyalty, and, having the Deity for its highest object, forms an element in religious feeling. So liable is its organ to disease, that high devotional excitement is one of the most common forms of insanity.

15. *Firmness* is the source of fortitude, constancy, perseverance, and determination; when too powerful, it produces obstinacy, stubbornness, and infatuation. The want of it is a great defect in character. The English soldier is more persistent than the French, although in courage and spirit they are equal.

16. *Conscientiousness* gives the love of justice, but intellect is necessary to shew on which side justice lies. The judge must hear both sides before deciding, and his very wish to be just will prompt him to do so. Conscientiousness not only curbs our faculties when too powerful, but stimulates those that are too weak, and incites us to duty even against strong inclinations. The existence of

Conscientiousness as an independent element in the human constitution, explains some apparent inconsistencies in human conduct—that a man, for instance, is kind, forgiving, even devout, and yet not just. The organ is commonly larger in Europeans than in Asiatics and Africans; very generally, it is deficient in the savage brain. When it is diseased, the insanity consists in morbid self-reproach, belief in imaginary debts, and the like.

17. *Hope* was regarded as a primary faculty by Spurzheim, but was never admitted by Gall, who considered it as a function of every faculty that *desires*. Dr Spurzheim answered, that we desire much of which we have no hope. It produces gaiety and cheerfulness, looks on the sunny side of everything, and paints the future with bright colours. When not well regulated, Hope leads to rash speculation, and, in combination with Acquisitiveness, to gambling, both at the gaming-table and in the counting-house. It tends to make the individual credulous of promised good, and often indolent.

18. *Wonder*.—Dr Gall found the organ of this faculty large in seers of visions and dreamers of dreams, and in those who love to dwell on the marvellous, and easily believe in it. Persons who have it powerful are fond of news, especially if striking and wonderful, and are always expressing astonishment; their reading is much in the region of the marvellous, tales of wonder, of enchanters, ghosts, and witches. When the sentiment is excessive or diseased, it produces that peculiar fanaticism which attempts miracles, and (with Language active, speaks in unknown tongues.

19. *Ideality*.—The organ of this faculty was observed by Dr Gall to be prominent in the busts and portraits of deceased, and in the heads of a great number of living, poets. This confirmed to him the old classical adage, that the poet is born, not made. He called it the organ of Poetry. The name of Ideality was given to it by Dr Spurzheim. This faculty is said to delight in the perfect, the exquisite, the *beau-ideal*, the beautiful and sublime. The organ is usually small in criminals and other coarse and brutal characters, for it is essential to refinement. It prompts to elegance and ornament in dress and furniture, and gives a taste for poetry, painting, statuary, and architecture. A point of interrogation is placed on the bust on the back part of the region of this organ, conjectured to be a different organ, but one allied to Ideality. The existence of the faculty of Ideality is held by phrenologists to prove that the sentiment of beauty is an original emotion of the mind, and to settle the controversy on that subject. See *ÆSTHETICS*.

20. *Wit, or the Sentiment of the Ludicrous*.—The phrenological writers have discussed at great length, and with not a little controversy, the metaphysical nature or analysis of this faculty. We need not follow them into this inquiry, as most of them are agreed that by means of it we feel and enjoy the *ludicrous*.

21. *Imitation*.—Dr Gall found the prominence of this organ accompanied by instinctive, and often irrepressible mimicry. The tendency to imitate is evidently innate; from the earliest years, it makes the young follow the customs and the manner of speech of those around them, and so preserves a convenient uniformity in the manners and externals of society. Celebrated actors always possess it strong, and by its means imitate the supposed manner, and even feel the sentiments, of their characters. Its organ is found large also in painters and sculptors of eminence. In its morbid states, the impulse to mimic becomes irresistible.

We now come to the Intellectual Faculties, or

those which make us acquainted with things that exist, and with their qualities and relations. Dr Spurzheim divided them into three genera—1. The External Senses; 2. The Internal Senses, or Perceptive Faculties; 3. The Reflecting Faculties.

The external Senses, as generally received, are five in number—*Touch, Taste, Smell, Hearing, and Sight*. There seem to be two more—namely, the *Sense of Hunger* and *Thirst*, and the *Muscular Sense*, or that by which we feel the state of our muscles as acted upon by force and resistance. Without this last sense, we could not keep our balance, or suit our movements to the laws of the mechanical world. Whether each sense has a special cerebral organ in addition to its external apparatus and nerves, is a question regarded by phrenologists as still undetermined.

22. *Individuality*, the first in the list of the perceptive faculties, is not easily defined. It is said to take cognizance of individual objects as such, e.g., a horse or a tree. Other knowing faculties perceive the form, colour, size, and weight of the horse, but Individuality is thought to unite all these, and give the idea of a horse. It is regarded as the storehouse of knowledge of things simply existing. When it is strong, without being accompanied by reflecting power, the mind is full of facts, but unable to reason from them. After puberty, the size of the organ of Individuality, as well as of the neighbouring organs of Size, Weight, Colouring, and Locality—all situated behind the superciliary ridge of the skull—is often rendered doubtful by the existence of a hollow space, of uncertain width and extent, between the two plates of the skull. This hollow is called the *frontal sinus*; and when it is large, there may be a great projection of the bone over the eyes, without a corresponding projection of brain within. When this part of the skull is flat, however, the organs must be at least as defective as the flatness indicates. Owing to the source of uncertainty here pointed out, and the smallness of the organs behind the eyebrows, the functions of those parts of the brain are not regarded as being so well ascertained as those of the larger organs, nor will a cautious phrenologist be too ready to pronounce them large.

23. *Form*.—When the organ of Form is large, the eyes are wide asunder. Dr Gall discovered it in persons remarkable for recognising faces after long intervals, and although perhaps only once and briefly seen. The celebrated Cuvier owed much of his success in comparative anatomy to his large organ of Form. Decandolle mentions that 'his [Cuvier's] memory was particularly remarkable in what related to forms, considered in the widest sense of that word; the figure of an animal seen in reality or in drawing never left his mind, and served him as a point of comparison for all similar objects.'

24. *Size*.—Every object has size or dimension; hence a faculty seems necessary to cognize this quality. The supposed organ is situated at the inner extremities of the eyebrows, where they turn upon the nose. A perception of size (including distance) is important to our movements and actions, and essential to our safety.

25. *Weight*.—A power to perceive the different degrees of weight and force is likewise essential to man's movements, safety, and even existence. Phrenologists have generally localised the organ of that power in the part of the brain marked 25 on the bust.

26. *Colouring*.—The organ of this faculty is large in great painters, especially great colourists, and gives an arched appearance to the eyebrow; for example, in Rubens, Titian, Rembrandt, Salvator

Rosa, and Claude Lorraine. In cases of colour-blindness, it is found small. Many persons, though able to distinguish colours, have no perception of their harmonies: for this perception, a higher endowment of the faculty seems to be required.

27. *Locality*.—Dr Gall was led to the discovery of this faculty by comparing his own difficulties with a companion's facilities, in finding their way through the woods, where they had placed snares for birds, and marked nests, when studying natural history. Every material object must exist in some part of space, and that part of space becomes place in virtue of being so occupied. Objects themselves are cognized by Individuality; but their place, the direction where they lie, the way to them, fall within the sphere of Locality. Its organ is large in those who find their way easily, and vividly remember places in which they have been. It materially aids the traveller, and is supposed to give a love for travelling. The organ was large in Columbus, Cook, Park, Clarke, and other travellers.

28. *Number*.—The organ of this faculty is placed at the outer extremity of the eyebrows and angle of the eye. It occasions, when large, a fulness or breadth of that part of the head, and often pushes downwards the external corner of the eye. When it is small, the part is flat and narrow between the eye and the temple. Dr Gall called the faculty *le sens des rapports des nombres* (the Sense of the Relations of Numbers), and assigned to it not only arithmetic, but mathematics in general. Dr Spurzheim more correctly limits its functions to arithmetic, algebra, and logarithms; geometry being the products of other faculties, particularly Size and Locality. Dr Gall first observed the organ in a boy who could multiply and divide, mentally, ten or twelve by three figures, in less time than expert arithmeticians could with their pencils. Many such examples are on record.

29. *Order*.—The organ of this faculty is said to be large in those who are remarkable for love of method, neatness, arrangement, and symmetry, and are annoyed by confusion and irregularity. In savages, whose habits are slovenly, filthy, and disgusting, the organ is comparatively small.

30. *Eventuality*.—The organ is situated in the very centre of the forehead, and when large, gives to this part of the head a rounded prominence. Individuality has been called the faculty of *nouns*; Eventuality is the faculty of *verbs*. The first perceives merely things that exist; the other, motion, change, event, history. The most powerful *knowing* minds have a large endowment of both Individuality and Eventuality; and such persons, even with a moderate reflecting capability, are the clever men in society—the acute men of business—the ready practical lawyers. The organ of Eventuality is generally well developed in children, and their appetite for *stories* corresponds.

31. *Time*.—Some persons are called walking time-pieces; they can tell the hour without looking at a watch; and some even can do so, nearly, when waking in the night. The impulse to mark time is too common, too natural, and too strong, not to be the result of a faculty; it is an element in the love of dancing, almost universal in both savage and civilised man.

32. *Tune*.—The organ of Tune is large in great musicians; and when it is small, there is an utter incapacity to distinguish either melody or harmony. The great bulk of mankind possess it in a moderate endowment, so as to be capable of enjoying music in some degree. Those in whom it is large and active, become, in all stages of society, distinguished artists, exercising a peculiar power over their

## PHRENOLOGY.

fellow-creatures, so as to rouse, melt, soothe, and gratify them at pleasure. But the gift, in this active form, is liable to be much modified according as it is accompanied by Adhesiveness, Combativeness, Ideality, Benevolence, Wit, and other faculties.

33. *Language*.—The comparative facility with which different men clothe their thoughts in words, and learn to repeat them by heart, depends on the size of the organ of Language, which is situated on the super-orbital plate, immediately over the eyeball, and, when large, pushes the eye outwards, and sometimes downwards; producing, in the latter case, a wrinkling or pursing of the lower eyelid. Verbal memory is strong or weak, without relation to the strength or weakness of the memory of things, forms, or numbers.

The Perceptive Organs are for the most part called into activity by *external* objects; but internal causes often excite them, and objects are then perceived which have no external existence, but which, nevertheless, the individual may believe to be real. This is the explanation of visions and ghosts, and of the fact that two persons never see the same spectres at the same time. Excess or disease in the organ of Wonder predisposes to belief in the marvellous and supernatural, and probably stimulates the Perceptive Organs into action, when spectral illusions are the consequence.

34. *Comparison*.—Dr Gall discovered the organ of this faculty in a man of science who reasoned chiefly by means of analogies and comparisons, and rarely by logical deductions. The middle of the upper part of his forehead was very prominent. The precise nature of the faculty has been much disputed among phrenologists, but they seem to agree that the perception of analogy depends upon it. Every faculty, we are told, can compare its own objects: Colouring can compare colours; Weight, weights; Form, forms; Tune, sounds; but Comparison can compare a colour with a note, or a form with a weight, &c. Analogy is a comparison not of things, but of their relations.

35. *Causality*.—This is regarded as the highest and noblest of the intellectual powers. Dr Spurzheim so named it from believing that it traces the connection between *cause* and *effect*, and recognises the relation of ideas to each other in respect of *necessary consequence*. Some metaphysicians have held that we have no idea of cause, but see only sequence, or one event following another. See CAUSE. It is true that we do see sequence; but we have a *third* idea—that of power, agency, or efficiency, existing in some way in the antecedent, to produce the consequent. Whence do we get this third idea?—from a distinct faculty, Causality. It is a large ingredient in wisdom.

The phrenologists have chiefly confined their attention to the organs of the brain, and the various faculties of which these are the instruments. The former writers on mind—Reid, Stewart, Brown, and others—gave, on the contrary, their chief care to the mental acts called Attention, Perception, Conception, &c., which they considered as faculties. The phrenologist does not overlook the importance of this department of mental philosophy, but differs from the metaphysicians in considering perception, conception, memory, &c., as only *modes* in which the real faculties above described *act*. This distinction is one of great importance.

According to the phrenologists, the faculties are not mere passive susceptibilities; they all tend to action. When duly active, the actions they produce are proper or necessary; in excess or abuse, they are improper, vicious, or criminal. Small moral organs do not produce abuses; but they are

unable to prevent the abuse of the animal organs, as larger tend to do; thus small Benevolence is not cruel, but it does not offer sufficient control to Destructiveness, which then impels to cruelty. *Cæteris paribus*, large organs have the greatest, and small the least tendency to act—each faculty producing the feeling or idea peculiar to itself. In active constitutions, the brain partakes of the general activity, and comes more readily into play than where the constitution or temperament is lymphatic. Health and disease, exercise and inaction, nutrition and starvation, have also great influence in modifying both the power of the cerebral organs and their readiness to act. Moreover, when certain faculties have been much exercised for a series of generations in a family, they are apt to be manifested in greater strength and activity than where no such hereditary influence exists. Seeing that all the organs tend to action, each, it is concluded, must have a legitimate sphere of action, and be necessary for the welfare of man.

The PROPENSITIES and SENTIMENTS cannot be called into action by the will. We cannot fear, or pity, or love, or be angry, by willing it. But *internal* causes may stimulate the organs, and then, whether we will or not, their emotions will be felt. Again, these feelings are called into action in spite of the will, by the presentation of their *external* objects—Cautiousness, by objects of terror; Love, by beauty; and so on. The excitability of the feelings, whether stimulated from within or without, is increased by activity of the temperament. Insanity is a frequent result of over-activity of the propensities and sentiments. These may be diseased and yet the intellect sound. The converse is also true. When an organ is small, its feeling cannot be adequately experienced. The will can *indirectly* excite the propensities and sentiments by setting the intellect to work to find externally, or conceive internally, the proper objects. Lastly, these faculties do not form ideas, but simply feel; and therefore have no memory, conception, or imagination.

The PERCEPTIVE and REFLECTING FACULTIES, or Intellect, form ideas, perceive relations, and are subject to, or rather constitute, the Will; and minister to the affective faculties. They may be excited by external objects and by internal causes. When excited by the presentation of external objects, these objects are *perceived*, and this *act* is called PERCEPTION. It is the lowest degree of activity of the intellectual faculties; and those who are deficient in a faculty cannot perceive its object.—CONCEPTION also is a mode of action of the faculties, not a faculty itself. It is the activity of the faculties from internal causes, either willed, or involuntary from natural activity.—IMAGINATION is Conception carried to a high pitch of vivacity.—MEMORY, too, is not a faculty, but a mode of action. There is no such thing as the *general* memory of the metaphysicians, but every intellectual faculty has its own memory. Memory differs from Conception and Imagination in this, that it recollects *real* objects or events which it has actually perceived, and adds the consciousness of time elapsed since they were perceived. The other named modes of action do not require realities or time.—JUDGMENT is, properly, the perception of adaptation, fitness, and necessary consequence; this is a mode of action of the reflecting powers. In a certain sense, the Perceptive Faculties may each be said to possess judgment; as Colouring judges of colours; Form, of forms; Tune, of music. By the word 'judgment,' however, is meant right reasoning, sound deciding. To this, a proper balance of the affective faculties is essential. There can be no sound judgment where any of the feelings are

excessive.—CONSCIOUSNESS is the knowledge which the mind has of its own existence and operations.—ATTENTION is not a faculty, but the application, or *tension*, of any or all of the intellectual faculties.—ASSOCIATION is the succession of ideas in the mind, each seeming to call up that which succeeds; so that in our waking-hours the mind is never without an idea passing through it. This is a state or condition of the faculties, not a faculty.—PASSION is any faculty in excess: Love is the passion of Amativeness in union with Adhesiveness and Veneration; Avarice, of Acquisitiveness; Rage, of Destructiveness.—PLEASURE and PAIN, JOY and GRIEF, also belong to each faculty, according as it is agreeably or disagreeably affected.—HABIT is the power of doing anything well, acquired by frequently doing it. But before it can be done at all, there must be the faculty to do it, however awkwardly.—TASTE was held by Mr Stewart to be a faculty, and to be acquired by habit. It seems to be the result of a harmonious action of all the faculties.

Such is an outline of the system propounded by the phrenologists. So far as it shall be confirmed by the mature experience and observation of competent inquirers, the facts and principles which it unfolds must be of great practical value to mankind. The study of the mutual influence of the mind and body has ever been recognised by wise and observant men as one of high importance, though of great difficulty; and certainly, Gall and his followers have not only given a strong impulse to that study, but have thrown much light on the diversities of human character, and accumulated a large body of facts of a kind which had previously been too much overlooked. Much, it is admitted, still remains to be discovered. 'No phrenologist,' says Mr Combe, 'pretends that Gall's discoveries are perfect; they are far from it, even as augmented and elucidated by his followers; but I am humbly of opinion that, in their great outlines, his doctrines are correct representations of natural facts. . . . The future of phrenology will probably exhibit a slow and gradual progress of the opinion that it is true and important; and only after this stage shall have been passed, will it be seriously studied as science. Hitherto this has not been done: the number of those who have bestowed on it such an extent of accurate and varied observation and earnest reflection as is indispensable to acquiring a scientific knowledge of chemistry, anatomy, natural philosophy, or any other science, is extremely small; and the real knowledge of it, on the part of such as continue, through the press and in public lectures, to oppose it, appears to me scarcely greater than it was in 1815 and 1826,' when it was ridiculed in the *Edinburgh Review*.

In considering the claims of phrenology, two questions should not be confounded. One is—How far the functions of the different parts of the brain have been established by observation of extreme instances of their large and small development?—the other, To what extent the facts so ascertained can be applied physiognomically in practice? Gall disclaimed the ability to distinguish either ill-defined modifications of forms of the skull, or the slighter shades of human character (*Sur les Fonctions du Cerveau*, iii. 41); nor, we believe, did he or Spurzheim ever pretend to estimate the size of every organ in a single brain. By attempting too much in these directions some of their disciples may have helped to prolong the incredulity with which phrenology is still widely regarded.

For the titles of numerous books on phrenology, see GALL (F. J.), SPURZHEIM (J. G.), and COMBE (G.); also an article in *The British and Foreign*

*Medical Review*, vol. ix. p. 190. Among the more recent works bearing on, or criticising phrenology, we may mention Dr Laycock's *Mind and Brain, or the Correlation of Consciousness and Organisation* (2 vols. Edin. 1860); his article on Phrenology in the 8th ed. of the *Encyc. Brit.*; an article on Phrenological Ethics in the *Edinburgh Review* for January 1842, vol. lxxiv. p. 376; Aug. Comte's *Philosophie Positive*, tom. iii. (or Miss Martineau's transl. i. 466); Sir Benj. C. Brodie's *Psychological Inquiries*, Dialogue vi. (Lond. 1854); G. H. Lewes's *Biog. Hist. of Ph'os.*, p. 629 (Lond. 1857); Samuel Bayley's *Letters on the Philosophy of the Human Mind*, 2d Series, Letters xvi.—xxi. (Lond. 1858); and Professor Bain *On the Study of Character, including an Estimate of Phrenology* (Lond. 1861). Sir William Hamilton's objections, mostly published many years since, and which are now appended to his *Lectures on Metaphysics*, i. 404 (Edin. 1859), were discussed in the *Phren. Jour.*, vols. iv. and v., and are remarked on by Mr Combe in his work *On the Relation between Science and Religion*, pref., p. xvii. (Edin. 1857).

PHRYGANEÆ. See CADDICE.

PHRYGIA, a country in Asia Minor, the extent and boundaries of which varied very much at different periods of ancient history. In pre-historic ages it is believed to have comprised the greater part of the peninsula, but at the time of the Persian invasion it was limited to the districts known as Lesser Phrygia and Greater Phrygia—the former stretching from the Hellespont to Troas (inclusive), the latter occupying a central portion of Asia Minor. The inland boundaries of Lesser Phrygia are not well ascertained; but Greater Phrygia was bounded on the N. by Bithynia and Paphlagonia, on the E. by Cappadocia and Lycæonia, on the S. by the Taurus range, and on the W. by the maritime countries of Mysia, Lydia, and Caria. At a later period it was considerably reduced by the formation of Galatia (q. v.) and the extension of Lycæonia. P. was in general a high and somewhat barren plateau, though its pastures supported immense flocks of sheep, noted for the fineness of their wool, as indeed they still are. The most fertile part was the valley of the Sangarius, but the most beautiful and populous district was the southwest, at the base of the Taurus, where the Mæander and other streams had their rise. The mountains and streams yielded gold; Phrygian marble was anciently celebrated, and the cultivation of the vine appears to have been extensively carried on.

The origin of the Phrygians is one of the mysteries of ancient ethnology. Some think that they were settled at a very remote period in Europe, and that they emigrated from Thrace into Asia Minor; and Xanthus, Herodotus, and Strabo certainly speak of such a migration. Xanthus places it after the Trojan war; but if there be any truth in the tradition at all, it can only refer to a return of some tribes to the cradle of the race in the valley of the Sangarius, for the Phrygians were regarded as one of the oldest races (if not the very oldest) in Asia Minor. Instead of seeking for their origin in Thrace, the best classical ethnologists seek for it in the neighbouring highlands of Armenia, whence the Phrygians are believed to have spread at a period far before the dawn of authentic history over the greater part of the Peninsula, and thence to have crossed into Europe, and occupied the greater part of Thrace, Macedonia, and Illyria; while the mythic Pelops, who colonised the Peloponnesus, and gave it his name, was said by tradition to be a Phrygian. In both Greek and Latin poetry the Trojans are also called Phrygians, and the same name is applied to other nations of Asia Minor, such as the Mydonians and

Mysians. In Thrace, too, many of the names of places were the same as in Troas; while it has now been demonstrated that the Armenian, Phrygian, and Greek languages are akin to each other, so that the peoples speaking the two former tongues, like those speaking the latter, belong to the great Aryan branch of the human family. The Phrygians began to decline in power and numbers after the Trojan war. They were—if we can make anything like historic fact out of the mythic narratives of that early time—pushed out of Europe by the Illyrians in the north and the Macedonians in the south, while in Asia Minor the rise of the Semitic Assyrians also depressed and weakened them, by breaking up the integrity of their territory. The whole of the south coast of the peninsula was occupied by Semitic invaders; the Lydians and Cappadocians were of Syro-Phœnician origin; and Strabo speaks of structures of Semiramis as far north as Pontus. Their language, manners, and religion even, underwent radical changes—hence the great difficulty experienced in ascertaining their original characteristics. After being subjugated by Croesus, they passed, on the dissolution of the Lydian monarchy, under the sway of Cyrus; and it is only from this date that they are brought within the pale of positive history. Their country formed part of the empire of Alexander, and subsequently belonged to the Syrian Seleucidæ, to the kings of Pergamum, and to the Romans, who obtained possession of it, 133 B. C.

The Phrygians had not a warlike reputation among the ancients, but though in later times commonly described as indolent and stupid, yet, like negroes, they were of a mystic and excitable disposition. Their religious orgies, accompanied by wild music and dancing, are frequently mentioned by classic writers, and appear to have exercised a very material influence on Hellenic worship. Cybele, 'the great mother of the gods,' was the chief Phrygian divinity; others were Sabazius (Dionysus), Olympus, Hyagnis, Lityerseæ, and Marayæ.

**PHRYNĒ**, one of the most celebrated courtesans of antiquity, was the daughter of Epicles, and was born at Thespiæ in Bœotia. Her position in life was originally very humble, and she is said to have at one time earned a livelihood by gathering capers; but as the fame of her marvellous beauty spread, she obtained numerous lovers, who lavished gifts on her so profusely that she became enormously rich. In proof of this, the story goes that she offered to rebuild the walls of Thebes, if the citizens would allow her to place this inscription on them: 'Alexander destroyed them; Phryne, the courtesan, rebuilt them.' The Thebans declined the proposal. Her enemies accused her of profaning the Eleusinian mysteries. Summoned before the tribunal of the Heliasts, she was defended by the rhetorician Hyperides, one of her lovers, who, perceiving that his eloquence failed to convince the judges, threw back her veil, and displayed her naked shoulders and bosom. She was immediately acquitted, and carried in triumph to the Temple of Venus. The famous picture of Apelles (q. v.)—the 'Venus Anadyomene'—is said to have been a representation of P. Praxiteles, also a lover of hers, employed her as a model for his 'Cnidian Venus.'

**PHTHISIS.** See CONSUMPTION.

**PHULWARA TREE.** See BASSIA.

**PHYLA'CTERY** (from Gr. *phyllasso*, to guard), an amulet or charm worn by the Greeks against demoniac influences. Certain strips of parchment, inscribed with certain passages from the Scripture (Exodus xiii. 1—10, 11—16; Deuteronomy vi. 4—9, xi. 13—21), enclosed in small cases, and fastened

to the forehead and the left arm (*Tefillin*)—also, in another form, to door-posts (*Mesusah*)—in use with the Jews, in imagined accordance with Exodus xiii. 9—16, &c., are also called in the New Testament phylacteries. The writing of these is in the hands of privileged scribes (*Soferim*) only, and many and scrupulous are the ordinances which they have to follow in the execution of this task. Only vellum of a very superior kind is to be used; the characters must be traced with the greatest care; no erasures or corrections are allowed; the lines and letters must be of equal length; &c. The case in which they are enclosed consists of several layers of calf-skin or parchment. It may be observed, by the way, that not the wearing, but the exaggerated form of the phylacteries worn by some of the Pharisees, is inveighed against by Christ.

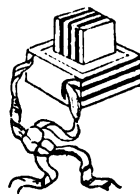

Phylactery.

**PHYLLOSO'MA.** See GLASS-CRAB.

**PHYSA'LIA**, a genus of *Acalepha*, having an oval or oblong body, which consists in great part of an air sac, so that the creature floats on the surface of the sea, with numerous appendages of various kinds hanging from its under side. The shorter of these appendages are suckers, which are kept in constant motion for procuring prey, and which seem also to be employed in extracting nutriment from it, as the P. has no proper mouth nor alimentary canal. Among these shorter appendages, also, some seem to be devoted to the purpose of reproduction by germination. The longer appendages, which are extremely long—those of a P. five or six inches in length, being capable of extension to twelve or eighteen feet—are rope-like tentacles, possessing a remarkable stinging power, which is probably used for benumbing prey. It is a common trick with sailors to make a novice pick up a P., the beautiful colours of which always attract admiration. The stinging power is, however, such as not merely to produce local pain, but constitutional irritation. It was at one time supposed that the P. has the power of expelling air from its bladder, and sinking at pleasure in the sea; but the observations of Mr Bennett (*Gatherings of a Naturalist in Australia*) render it more probable that it always floats on the surface, and is driven about by the winds. The name *Portuguese Man-of-War* is often popularly given to the species of P., and particularly to *P. pelagica*. The *Physalix* are inhabitants of the seas of warm latitudes, but shoals of them are occasionally driven to the British coasts.



Portuguese Man-of-War (*Physalis pelagica*).

**PHYSALIS**, a genus of plants of the natural order *Solanaceæ*, remarkable for the calyx, which becomes large and inflated after flowering is over, and encloses the ripened berry. The species are annual and perennial herbaceous plants and shrubs, natives of temperate and warm climates, and widely scattered over the world. The COMMON WINTER CHERRY (*P. alkekengi*) is a perennial, native of the south of Europe and great part of Asia, growing in vineyards and bushy places. It is not a native of



Britain, but is pretty frequent in flower-gardens. It has ovate triangular downy leaves, dirty-white flowers; and the fruit when ripe is a shining red berry, enclosed in a very large vermilion-coloured bladder. The berries have a sweetish subacid taste; they are seldom eaten in Britain, but very generally



Love Apple (*Physalis edulis*).

in many parts of the continent of Europe. They are refrigerant and diuretic, and were formerly employed in medicine on account of these properties.—The DOWNY WINTER CHERRY, or PERUVIAN GOOSEBERRY (*P. pubescens* or *P. Peruviana*), is an annual American species, densely clothed with down; with heart-shaped leaves, yellow flowers, and yellowish berries which are eatable, and when preserved with sugar, make an excellent sweetmeat. It is cultivated and naturalised in many of the warmer parts of the world, and sometimes ripens its fruit in England, and even in Scotland.—Some of the other species of *P.* are among the most common weeds of the West Indies and tropical America; and the fruits of some of them are occasionally eaten, although not esteemed.

**PHYSETER.** See CACHOLOT.

**PHYSIC NUT** (*Curcas*), a genus of plants of the natural order *Euphorbiaceæ*, having a 5-partite calyx, 5 petals, and 8—10 unequal-united stamens. The species are not numerous. They are tropical shrubs or trees, having alternate, stalked, angled or lobed leaves, and corymbs of flowers on long stalks; and notable for the acrid oil of their seeds. The COMMON P. N. of the East Indies (*C. purgans*), now also common in the West Indies and other warm parts of the world, is a small tree or bush, with a milky juice. It is used for fences in many tropical countries, and serves the purpose well, being much branched and of rapid growth. The seeds are not unpleasant to the taste, but abound in a very acrid fixed oil, which makes them powerfully emetic and purgative, or in large doses poisonous. Instances have recently occurred of very alarming, although not fatal, results from the eating of the seeds, imported into Britain under the name of *Physic Nuts*, *Jatropha Nuts* or *Jatropha Seeds* (the Linnean name of the plant being *Jatropha purgans*), and *Barbadoes Nuts* or *Barbuloes Seeds*. The expressed oil, commonly called *Jatropha Oil*, is used in medicine like croton oil, although less powerful; it is also used in lamps. The milky juice of the shrub is used by the Chinese for making a black

varnish, in order to which it is boiled with oxide of iron.—The FRENCH P. N., or SPANISH P. N. (*C. multifida*), a shrub, native of the tropical parts of America, with many-lobed leaves, yields a purgative acrid oil, called *Oil of Pinhoe*. It is very similar in its qualities to the oil obtained from the former species, perhaps stronger. To this genus belongs the PINONCILLO (*C. lobatus*) of Peru, the seed of which is eaten when roasted, and has an agreeable flavour, although when raw it is a violent purgative. When an incision is made in the stem of this tree, a clear bright liquid flows out, which after some time becomes black and horny. It is a very powerful caustic, and retains this property for years.

**PHYSICAL GEOGRAPHY.** See GEOGRAPHY.

**PHYSICIANS, THE ROYAL COLLEGE OF** (of London), was founded in 1518 by the munificence of Thomas Linacre, a priest and distinguished physician, who was born in 1460, and died in 1524. In 1518, through the influence of Cardinal Wolsey, he obtained from Henry VIII. letters-patent granting to John Chambre, himself, and Ferdinandus de Victoria, the acknowledged physicians to the king, together with Nicholas Halsewell, John Francis, Robert Yaxley, and all other men of the same faculty in London, to be incorporated as one body and perpetual community or college. They were permitted to hold assemblies, and to make statutes and ordinances for the government and correction of the College, and of all who exercised the same faculty in London and within seven miles thereof, with an interdiction from practice to any individual unless previously licensed by the President and College. Linacre was the first president, and held the office till his death in 1524. The meetings of the College were held at his house in Knightrider Street, which he bequeathed to the College, and which, until the year 1860, continued in the possession of that body. About the time of the accession of Charles I. the College, requiring more accommodation, took a house at the bottom of Amen Corner, which was subsequently purchased by Dr Harvey, and in 1649 was given by him to his colleagues. This was the seat of the College till 1666, when it was destroyed by the great fire of London. A new College was then built in Warwick Lane, and opened in 1674 under the presidency of Harvey's friend, Sir George Ent; and here the meetings were held till 1825, when the present edifice in Pall-Mall East was opened under the presidency of Sir Henry Hallford.

The reason for forming the incorporation, as set forth in the original charter, is 'to check men who profess physic rather from avarice than in good faith, to the damage of credulous people;' and the king (following the example of other nations) founds 'a college of the learned men who practise physic in London and within seven miles, in the hope that the ignorant and rash practisers be restrained or punished.' The charter further declares, that 'no one shall exercise the faculty of physic in the said city, or within seven miles, without the College licence, under a penalty of £5;' that, in addition to the president, 'four censors be elected annually to have correction of physicians in London and seven miles' circuit, and of their medicines, and to punish by fine and imprisonment;' and that 'the President and College be exempt from serving on juries.' Four years later, in 1522—1523, an act was passed confirming the charter, and enacting that 'the six persons before said named as principals and first named of the said commonalty and fellowship, shall choose to them two men of the said commonalty from henceforward to be called and cleaped Elects, and that the same elects yearly choose one of them to be president of the said commonalty;' and

further directing that, in case of a vacancy by death or otherwise, the surviving elects 'shall choose, name, and admit one or two, as need shall require, of the most cunning and expert men, of and in the said faculty in London;' and that 'no person from henceforth be suffered to exercise or practise in physic except he be a graduate of Oxford or Cambridge, until such time as he be examined at London by the said president and three of the said elects, and have from them letters testimonials of their approving and examination.'

In 1540 an act was passed (32 Hen. VIII. c. 40) by which the President and College were exempted, in consequence of their professional duties, 'from keeping watch and ward, and from being chosen to the office of constable and other offices;' and the censors were authorised 'to enter apothecaries' houses, to search, view, and see their wares, drugs, and stuffs, and to cause to be brent, or otherwise destroyed, such as they find defective, corrupted, and not meet nor convenient to be ministered in any medicine for the health of man's body.' In this act it was further declared explicitly that 'surgery is a part of physic, and may be practised by any of the company or fellowship of physicians'—a doctrine which in later times has been totally repudiated by the collegiate body, who, until a few years ago, would not admit to their privileges a member of the Royal College of Surgeons, unless he formally resigned his surgical diploma (for which act of resignation the College of Surgeons charged him a fee of £5). Other 'Acts touching the Corporation of the Physicians, London,' were passed in 1553, 1814, and 1858 (the last being known as 'the Medical Act'), which require no special notice, except that the Medical Act provides for the granting of a new charter to the College, which was obtained in 1862. Finally, in 1860, 'an Act to Amend the Medical Act' was passed, which repeals the provisions of the act of Henry VIII. (1522—1523) as to the elects, on the ground that their main function was licensing country physicians (the class recognised as Licentiate*s extra urban*), and that it has virtually ceased; and declares that 'the office and name of elects of the said College shall henceforth wholly cease,' and that the Presidency shall in future be an annual office, open to the Fellows at large, who shall also be the electing body.

The College has consisted, till the last few years, of *Fellows* (amongst whom were the eight Elects), who are a self-electing body, and were, until about 20 years ago, almost invariably graduates of Oxford or Cambridge; *Licentiate*s, who were examined by the president and censors, and who alone, excepting the *Fellows*, had the privilege of practising in and within seven miles of London; and *Extra-licentiate*s, who were examined by the Elects, and had the privilege of practising in any part of England excepting in and within seven miles of London. As at present constituted, it consists of *Fellows*, *Members*, *Licentiate*s, and *Extra-licentiate*s. The *Fellows* are elected from members of at least four years' standing, who have distinguished themselves in the practice of medicine, or in the pursuit of medical or general science or literature. The government of the College is vested in the President and *Fellows* only. The present *Members* consist of persons who had been admitted before February 1859 licentiate*s of the College*; of extra-licentiate*s who have complied with certain conditions*; and of persons who have attained the age of 25 years, who do not dispense or supply medicine, and who, after being duly proposed, have satisfied the College 'touching their knowledge of medical and general science and literature,' and that they have 'been engaged in the study of physic during a period of five years, of which

four years at least shall have been passed at a medical school recognised by the College.' The *members* constitute a portion of the corporation, in so far as they have the use of the library and museum, and the privilege of admission to all lectures, but they do not take any share in the government, or attend or vote at meetings. The *Licentiate*s are not members of the corporation, and in their qualifications very much resemble those who have diplomas both from the College of Surgeons and the Apothecaries' Hall. They must be 21 years of age, and must have been engaged in professional studies for four years before being admitted to examination.

The fee for admission as a Fellow is 30 guineas, exclusive of stamp-duty; the fee for admission as a Member is 30 guineas; and the fee 'for the licence to practise physic as a Licentiate of the College' is 15 guineas.

The following by-laws of the College should be generally known. 1. No Fellow of the College is entitled to sue for professional aid rendered by him. This by-law does not extend to Members. 2. No Fellow, Member, or Licentiate of the College is entitled to assume the title of Doctor of Medicine unless he be a graduate in medicine of a university. 3. No Fellow or Member of the College shall officiously, or under colour of a benevolent purpose, offer medical aid to, or prescribe for, any patient whom he knows to be under the care of another legally qualified medical practitioner.

**PHYSICS, or PHYSICAL SCIENCE** (Gr. *physikos*, natural), comprehends in its widest sense all that is classed under the various branches of mixed or applied mathematics, natural philosophy, chemistry, and natural history, which branches include the whole of our knowledge regarding the material universe. In its narrower sense, it is equivalent to Natural Philosophy (q. v.), which, until of late years, was the term more commonly used in Great Britain, and denotes all knowledge of the properties of bodies as bodies, or the science of phenomena unaccompanied by essential change in the objects; while chemistry is concerned with the composition of bodies, and the phenomena accompanied by essential change in the objects; and natural history, in its widest sense, includes all the phenomena of the animal, vegetable, and mineral world. The application of the term *Physic* to a branch of this last—viz., the science of medicine—is peculiar to the English language.

**PHYSIOGNOMY** (Gr.), the art of judging of the character from the external appearance, especially from the countenance. The art is founded upon the belief, which has long and generally prevailed, that there is an intimate connection between the features and expression of the face and the qualities and habits of the mind; and every man is conscious of instinctively drawing conclusions in this way for himself with more or less confidence, and of acting upon them to a certain extent in the affairs of life. Yet the attempt to reach this conclusion by the application of certain rules, and thus to raise the art of reading the human countenance to the dignity of a science, although often made, has never yet been very successful. Comparisons have been instituted for this purpose between the physiognomies of human beings and of species of animals noted for the possession of peculiar qualities, as the wolf, the fox, &c. This was first begun by Della Porta, a Neapolitan, who died in 1615, and was afterwards carried further by Tischbein. The subject of physiognomy was eagerly prosecuted by Thomas Campanella; and when his labours had nearly been forgotten, attention was

again strongly attracted to it, although only for a short time, by the writings of Lavater (q. v.).

**PHYSIOLOGY** (Gr. *physis*, nature; *logos*, a discourse) is the science which treats of the phenomena which normally present themselves in living beings, of the laws or principles to which they are subject, and of the causes to which they are attributable. It is, in short, the *science of life*, and hence the term *Biology* (Gr. *bios*, life) has been adopted by some writers in place of physiology. Biology is, however, regarded by some authors (and, we think, correctly) as including in its scope more than physiology, as will be seen from the following extract from Professor Greene's remarks 'On the Principles of Zoology': 'Biology,' he observes, 'is that branch of scientific inquiry which undertakes to investigate the nature and relations of living bodies. Every living being may be regarded from two points of view, which it is necessary to distinguish clearly from one another. The first of these exhibits to us living beings as possessing definite forms, which, in most instances, are found to be made up of a number of dissimilar parts or *organs*; while the second takes cognizance of the vital actions or *functions* which these organs perform. That department of biology which determines the former is termed *Morphology*; that which investigates the latter, *Physiology*. Hence the nature of living beings is twofold—*morphological* and *physiological*.'—*A Manual of the Protozoa*, 1859, pp. ix—x.

**PHYTOLACCA**, a genus of exogenous plants, of the natural order *Phytolaccaceæ*. This order contains about 70 known species, half-shrubby and herbaceous plants, natives of warm parts of Asia, Africa, and America, and is nearly allied to the order *Chenopodiaceæ*, from which it is distinguished by the frequently numerous carpels, the corolla-like perianth when the carpel is single, and the stamens either exceeding the number of the segments of the perianth, or alternate with them. It is also nearly allied to *Polygonææ*. The genus *Phytolacca* has for its fruit a berry with 8—10 cells, each cell one-seeded. *P. decandra*, the Poke or Pocom, a native of North America, now naturalised in some parts of the south of Europe, is sometimes cultivated for its young shoots, which, when blanched, are eaten like asparagus. Yet the leaves are acrid, and the root is an emetic almost or altogether equal to ipecacuanha. The root is also externally applied to cure itch and ringworm. A tincture of the ripe berries, which are fully larger than Black Currants, and grow in racemes, is efficacious in chronic rheumatism and syphilitic pains. By some it is held to be more valuable than guaiacum. The pulp of the berries is employed in the adulteration of wine.—The young shoots of *P. acinosa* are boiled and eaten in the Himalayas, those of *P. octandra* in Cayenne, and a Chinese species has recently been introduced into British gardens for the same use under the name of *P. esculenta*.

**PHYTOLOGY**, another name for Botany, not much in use.

**PHYTOZO'A** (Gr. *phyton*, a plant; *zōon*, an animal), also called *Antherozoids*, are minute bodies produced amidst a mucilaginous fluid in the antheridia of many cryptogamous plants (Algæ, Hepaticæ, Mosses, Ferns), which are either aquatic or delight in moist situations. In some many-celled antheridia of the higher cryptogamous plants, each cell is devoted to the production of a single phytozoon. When the antheridium is mature, and bursts, the phytozoa move for a short time by means of cilia—a provision, apparently, for their reaching the pistillidia, the spores contained in which—according

to an opinion rapidly gaining ground among botanists—they are destined to fertilise. Great diversities exist in the phytozoa of different cryptogamous plants. The annexed figure will convey a better notion of them than any mere description.

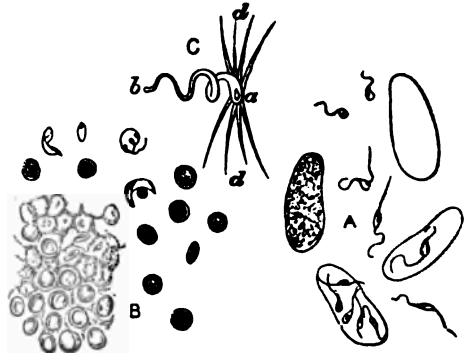

**Phytozoa:**

(From Carpenter on the Microscope.)

- A. Antherozoids of *Fucus platycarpus* (a sea-weed), some of them free, others still included in their antheridial cells.
- B. Cellular contents of an antheridium of *Polytrichum commune* (a moss), mature and discharging the antherozoids.
- C. Antherozoid of *Pteris serrulata* (a fern) shewing *a*, its large extremity; *b*, its small extremity; *d*, *d*, its cilia.

Cryptogamous plants, which, as lichens, live in dry situations, have no phytozoa, although it is supposed that they have organs destined to the same purpose, but destitute of the power of motion by cilia.

**PIACENZA**, a city of Northern Italy, in the province of the same name, on the right bank of the Po, 2 miles below the confluence of the Trebbia with that river, and 36 miles west-north-west of the city of Parma. Beautifully situated on a fine plain, confined on the south by well-cultivated hills, the city itself is gloomy and desolate in appearance. Its streets are broad and regular—that called the *Stradone* is one of the most beautiful in Italy—but many of them are unfrequented and grass-grown. It contains numerous palaces, and about 50 churches. The cathedral, an edifice in the ancient Lombard style, founded in the 11th c., is famous for the richly-curious and grotesque character of its internal decorations, for its numerous sculptures, its paintings, and for a number of frescoes of great grandeur, by Caraccio, Guercino, and others. The Church of Sant' Antonio, the original cathedral of P., was founded in 324 A.D., but has been several times rebuilt. Among the other principal buildings, are the Palazzo Farnese, founded in 1558, and once a sumptuous edifice, but which has been long in use as a barrack; the Palazzo del Commune, and the Collegio dei Mercanti are fine monuments of art. The principal square is the Piazza Cavalli, so called from the colossal bronze equestrian statues of the dukes Alessandro and Rannuccio Farnese. This town occupies by far the most important position, in a military point of view, in Italy—a fact which was fully appreciated by those who fortified it with solid walls and a strong castle, which, till 1859, were guarded by the Austrians. On being forced from the city by the war of 1859, the Austrians did not destroy the works, and the Italian government has strengthened and extended them by the formation of externally defended works, and of a formidable entrenched camp, which unites and protects the other works on the right bank of the Po.

Manufactures of silks, fustians, linens, hats, &c., are carried on to some extent. Pop. (1862), which has considerably increased within the last few years, 39,387.

P., called by the Romans *Placentia*, on account of its pleasing situation, first mentioned in 219 B. C., when a Roman colony was settled there. In 200 B. C., it was plundered and burned by the Gauls, but rapidly recovered its prosperity, and was long an important military station. P. was the western terminus of the great Æmilian road, which began at Ariminum on the Adriatic. In later history, it plays an important part as one of the independent Lombard cities.

PIA MAT'ER. See NERVOUS SYSTEM.

PIA'NO (Ital. *soft*), abbreviated *p*, is used in music to denote that the strain where the indication occurs is to be played with less than the average intensity of force. *pp*, or *ppp*, for *pianissimo*, signifies very soft, or as soft as possible. In contradistinction from *piano*, *forte*, abbreviated *f*, is used to denote a more than usual force; and *f*, or *fff*, for *fortissimo*, a still greater degree of force. The gradual transition from *piano* to *forte* is indicated by the sign <; from *forte* to *piano* by the sign >.

PIANOFORTE (Ital. *piano*, soft, and *forte*, loud), a stringed musical instrument, played by keys, developed out of the Clavichord and Harpsichord (q. v.), from which the pianoforte differs principally in the introduction of hammers, to put the strings in vibration, connected with the keys by a mechanism that enables the player to modify at will the intensity of the sounds; whence the name of the instrument.

The idea of the pianoforte was conceived independently about the same time by three persons in different parts of Europe—a German organist of the name of Schröter; Marius, a French harpsichord-maker; and Bartolomeo Cristofali, a harpsichord-maker of Padua. Priority in point of invention (1714) is due to the Italian maker. Schröter's discovery was followed up in Germany by Silbermann of Strasburg, Spät of Ratisbon, Stein of Augsburg, and others. The first pianoforte seen in England was made at Rome by Father Wood, an English monk there. A few German manufacturers and workmen settling in London, gave an impetus to the new instrument. The English pianoforte has been brought to its present state of perfection by a succession of improvements received at the hands of Broadwood, Stodart, Erard, Clementi, Collard, Wornum, Hopkinson, and other makers. All the really important later inventions are English. The compass of the early pianoforte was, like that of the harpsichord, four to five octaves, from which it has been gradually increased to 6½, or seven octaves, or occasionally more.

The most natural of the various forms which the instrument assumes is that of the grand pianoforte, derived from the harpsichord, with the strings placed horizontally, and parallel to the keys. The strings are stretched across a compound frame of wood and metal, composed of bars, rods, and strengtheners of various kinds—appliances necessary to resist the enormous tension. This framework includes a wooden sound-board. The mechanism by which hammers are connected with the keys, is called the *action* of the instrument. In the earliest pianofortes, the hammer was raised from below by a button attached to an upright wire fixed on the back-end of the key. The impulse given to the hammer caused it to strike the string, after which it immediately fell back on the button, leaving the string free to vibrate. This was called the *single action*. As the hammer, when resting on the button with the key pressed down, was thus necessarily

at a little distance from the string, the effectual working of this action required that a certain impetus should be communicated to the hammer to enable it to touch the string. Hence it was impossible to play very piano, and it was found that if the hammer was adjusted so as to be too close to the string when resting on the button, it was apt not to leave the string till after the blow had been given, thereby deadening the sound. This defect was remedied by a jointed upright piece called the *hopper*, attached to the back-end of the key, in place of the wire and button. When the key was pressed down, the hopper, engaging in a notch in the lower side of the hammer, lifted it so close to the hammer, that the lightest possible pressure caused it to strike; and at this moment, when the key was still pressed down, the jointed part of the hopper, coming in contact with a fixed button as it rose, escaped from the notch, and let the hammer fall clear away from the string. To prevent the hammer from rebounding on the string, a projection called the *check* was fixed on the end of the key, which caught the edge of the hammer as it fell, and held it firmly enough to prevent it from rising. A necessary part of the action is the *damper*, which limits the duration of each particular note, so as to cause it to cease to sound as soon as the pressure is removed from the key. It consists of a piece of leather resting on the top of the string, and connected with the back-part of the key by a vertical wire. When any key is pressed down, its damper is raised off the string, so as to allow the sound produced to be clear and open; but immediately on the finger being lifted off the key, the damper-wire falls, and the damper again presses on the string, muffling and stopping the vibration. The whole range of dampers may, when required, be raised by the use of the damper pedal, so as to prolong the sound of one note into another.

One further frequent and important addition to the action may be alluded to. In the mechanism above described, the key must rise to its position of rest before the hopper will again engage in the notch of the hammer for another stroke; hence, a note cannot be repeated until time has been allowed for the full rise of the key. The *repetition action* is a contrivance, varying in different instruments, for getting rid of this defect, by holding up the hammer at a certain height while the key is returning.

Great difference of detail exists in the actions of different makers. Some are more complicated than others; but in all are to be found the same essential parts, only modified in shape and arrangement. The subjoined figure represents one of the simplest grand pianoforte actions now in use. A is the

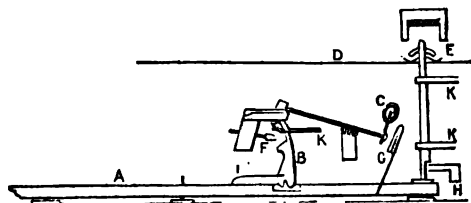

key, B the lever which raises the hammer, C the hammer, D the string, and E the damper; F is the button which catches the lever after it has struck the hammer, G the check, H the damper pedal-lifter, I the spring, and K, K, K are rails and sockets.

Formerly, the strings of the pianoforte were all of thin wire; now, the bass-strings are very

thick, and coated with a fine coil of copper-wire; and the thickness, strength, and tension of the strings all diminish from the lower to the upper notes. A grand pianoforte has three strings to each of the upper and middle notes, and now, generally, only two to the lower notes, and one to the lowest octave. When the soft pedal is pressed down, the hammers are shifted sideways, so as to strike only two strings instead of three, or one string instead of two.

Besides the grand, the kinds of pianoforte in use are the square, in which the strings are placed still in a horizontal position, but obliquely to the keys; and the upright, in which the strings run vertically from top to bottom of the instrument. The difference in form necessitates alterations in the details of the action, but the general principle is the same.

The pianoforte has in modern times attained a widespread popularity beyond that of any other musical instrument. It possesses nearly all the powers of expression of any other instrument; on no other except the organ can we execute such complete successions of harmonies; no other represents the orchestra so well, with the advantage that the various parts adapted to it are brought out by the same performer. In all cities of the civilised world, there are numerous manufacturers of the pianoforte, employing multitudes of workmen; and even in the secondary towns of Europe, the number of makers is daily increasing. In England, the manufacturers who have for some time past enjoyed the highest repute are Messrs Broadwood, Collard & Co., and Erard; but other makers are rapidly approaching them in excellence. Till lately, the German makers adopted a much less perfect action than the English, producing a very different touch and tone; but they are now largely using the English action, which is spreading over the continent. Music for the pianoforte is written in two staves, and on the treble and bass-clefs. Many of the most eminent musicians have devoted themselves to composing for the pianoforte, and some composers of note, as Hummel, Czerny, Kalkbrenner, Chopin, Thalberg, Liszt, and Heller, have almost entirely confined themselves to that instrument. See Rimbault, *The Pianoforte, its Origin, Progress, and Construction* (Lond. 1860).

PIARISTS, called also familiarly *Scolopini*, or 'Brethren of the Pious Schools,' a religious congregation for the education of the poor, founded at Rome in the last year of the 16th century. The originator of this institute was a Spanish priest, named Joseph of Calasanza, who, while in Rome, was struck with the imperfect and insufficient character of the education which then prevailed, even for the children of the higher classes, and conceived the idea of organising a body for the purpose of meeting this want, which the Jesuit Society had already partially supplied. The school which he himself, in conjunction with a few friends, opened, rapidly increased in number to 100, and ultimately to 700 pupils; and in 1617, the brethren who, under the direction of Joseph, had associated themselves for the work, were approved as a religious congregation by Paul V. (q. v.), who entered warmly into this and all other projects of reformation. In 1621, Gregory XV. approved the congregation as a religious order. The constitution of the order was several times modified by successive popes, down to the time of Innocent XI. Its field of operations has, of course, been confined to European countries; and at present it can reckon communities in Italy, Austria, Spain, Hungary, and Poland. In Italy, during the revolutionary wars, the P. received into their ranks many members of the suppressed Society of the Jesuits. In Spain, their establishments were spared,

on the general suppression of religious orders in 1836. In Poland, eleven houses still were in existence in 1832. The number of members in Hungary is said to be about 400, and the order is also found in the other dependencies of Austria. See Wetzer's *Kirchen-Lexicon*.

PIA'SSABA, or PIACABA, a remarkable vegetable fibre which, during the last twenty years, has become an article of much importance in this country. It is procured from Brazil, chiefly from the ports of Para and Maranhão, and is produced by one or more species of palm. That which furnishes the greater part is the Coquilla-nut Palm (*Attalea funifera*); but Mr Wallace states that much of it is procured from a species of *Leopoldinia*, which he has named *L. piassaba*. The fibre is produced by the stalks of the large fan-like leaves. When the leaves decay, the petioles or stalks split up into bundles of cylindrical fibres of a dark-brown colour, and of a hard texture, varying in thickness from that of a horse-hair up to that of a small crow-quill. This material has been found of great utility in making brushes of a coarse kind, particularly those required to sweep the street; and for this purpose they have almost superseded birch-brooms, split whale-bone brushes, and other similar means for scavengers' work. The coarsest fibres are best for such purposes, and the finer ones are found very valuable for finer kinds of brushes.

PIASTRE (Gr. and Lat. *emplastron*, a plaster; transferred in the Romanic languages to anything spread out or flattened, a plate, a coin), a Spanish silver coin which has been extensively adopted by other nations. It was formerly divided into 8 silver reals, and hence was termed a *piece of eight*, which name was invariably applied to it by the Buccaneers of the Spanish Main. The present Spanish piastre, commonly known as the *peso duro*, *peso fuerte*, or, briefly, *duro*, is the standard of the money system, and is equivalent to about 4s. 3d. of our money. It is divided into 20 copper reals (*reales de vellon*). In the Levant, the piastre is called a *colonnato*, on account of the original coins, which were struck for use in Spanish America, bearing two columns on the reverse side.—The Italian piastre, or *scudo*, is an evident imitation of the Spanish coin, and is exactly equal to it in value.—The same is true of the piastres in use in Chili, Mexico, and South America, with the sole exception of New Granada, where it is about 2½d. sterling less. The Dollar (q. v.) of the United States of North America was adopted from the Spanish piastre, but is a fraction less in value, owing, it is said, to an error in the original estimate. The original Spanish 'pillar' piastres or dollars are current nearly all over the world.—The coin known as the Turkish piastre is not an imitation, but is an independent national silver coin, which, in 1753, was worth about 3s. 6d. sterling, but has since gradually and rapidly deteriorated, till at the present day it is equal to not more than 2½d. of our money.—The Egyptian piastre is worth about 2½d. sterling. Pieces of 2, 5, 10, and 20 piastres are struck in silver, and of 50 and 100 in gold; the piece of 100 piastres being in Egypt the exchange at par for £1 sterling.

PIAZZA, an open *place* or square. The name is also applied to a portico or arcade, such as often surrounds a piazza in warm countries.

PIAZZI, GIUSEPPE, a celebrated astronomer, was born at Ponte in the Valteline, July 16, 1746. He was received into the order of the Theatins at Milan in 1764; and studied in that city, and subsequently in the houses of the same order at Rome and Turin. Summoned to the professorial chair of Philosophy at Genoa, he so alarmed the Dominicans by the

freedom and boldness of his opinions, that his friend the grand-master thought it desirable to remove him to Malta, where, in 1770, he became Professor of Mathematics in the newly-founded university. On the breaking up of this seminary, he returned to Italy, and after teaching philosophy in the Nobles' College at Ravenna, he went to Rome, where he became Professor of Dogmatic Theology in the institution of San Andrea della Valle. He was transferred in 1780 to the chair of Mathematics in Palermo; and after some time, obtained the consent and aid of government to establish an observatory at Palermo, which was put in working order in 1789. The first results of his observations were, the rectification of some errors in the estimation of the obliquity of the ecliptic, the aberration of light, the length of the tropical year, and the parallax of various heavenly bodies; these results were published in 1792. P. had now attained a European reputation, which was further heightened by his discovery, on the night of 1st January 1801, of a new planet, the first known of the great group of planetoids between Mars and Jupiter. P. was only able to give a description of it, accompanied with some hypotheses of his own, to some of the German and Italian astronomers, when it disappeared; Gauss (q. v.), however, rendered certain the fact of its being a planet. It received from P. the name Ceres, after the ancient goddess of Sicily. P. was so sincerely attached to Sicily, which he regarded as if it were his native country, that all the splendid offers of Napoleon were insufficient to induce him to remove to Bologna. In 1803, he published a map of the fixed stars, far superior to any before published, the result of ten years' observations: the work was crowned by the Institute of France. In 1814, appeared a new and more complete catalogue (containing 7646 stars), for which he was again rewarded with a prize from the French Institute. He also made researches into the nature of comets, aided to regulate the weights and measures of Sicily, and devoted the later years of his life to the improvement of public education in Sicily. He wrote a number of works, of which, besides the two catalogues of stars above mentioned, the *Lezioni Elementari di Astronomia* (Palermo, 1817) is the chief. He is also the author of many memoirs drawn up for the various scientific societies of Europe. P. died, 22d July 1826, at Naples.

**PI'BROCH**, a species of martial music performed on the bagpipe of the Highlanders, which has been found to have a wonderful power in arousing their military instincts. Its rhythm is so irregular, and its notes in the quicker parts so much jumbled together, that a stranger has difficulty in following the modulations or reconciling his ear to them. The earliest mention of the military music of the bagpipe is in 1594, at the battle of Balrinnis; indeed, prior to that period, the bagpipe can hardly be looked on as a national instrument of Scotland. There are appropriate pibrochs belonging to various clans and districts, but some of these may not be older than the beginning of last century. One of the oldest known pibrochs is called the 'Battle of Harlaw,' but it may be doubted whether it was contemporary with that event (1411). In the ballad account of that battle, there is mention of trumpets and horns, but none of the bagpipe; and the pibroch style of music has so obvious a relation to the bagpipe, that it is difficult to suppose that it preceded the use of that instrument. According to Sir Walter Scott, the connoisseurs in pipe-music affect to discover in a well-composed pibroch the imitative sounds of march, conflict, flight, pursuit, and all the current of a heady fight. Many remarkable instances have been recorded of the effect of the pibroch on the

Highlanders. At the battle of Quebec, in April 1760, whilst the British troops were retreating in confusion, the pipers were ordered to strike up a favourite pibroch, and the result was that the Highlanders, who were broken, rallied the moment that they heard the music, and formed with great alacrity in the rear.

**P'ICA.** See **MAGPIE**.

**PICA.** See **MORBID APPETITES**.

**PICA.** See **PRINTING**.

**PICARDY** (**PICARDIE**), an ancient province in the north of France, was bounded on the W. by the English Channel, and on the E. by Champagne. The name does not occur till the 13th century. The capital of this province was Amiens. The territory now forms the department of *Somme*, and portions of the departments of *Aisne* and *Pas-de-Calais*.

**P'ICCOLO** (Ital. *flauto piccolo*, small flute), a flute of small dimensions, having the same compass as the ordinary flute, while the notes all sound an octave higher than their notation. In joyous as well as violent passages, this instrument is sometimes very effective in an orchestra.

**PICCOLOMINI**, one of the oldest and most distinguished families of Italy, was originally settled at Rome, but afterwards removed to Siena, and subsequently obtained possession of the duchy of Amalfi. It has produced numerous celebrated *littérateurs* and warriors, one pope (PIUS II.), and several cardinals. One of the most distinguished in the history of this family was OTTAVIO P., the first Duke of Amalfi, born in 1599, and fifth in direct descent from Pope Pius II. He early entered the Spanish military service, and after taking part in the Milanese campaigns, was sent as captain with a Florentine cavalry regiment to aid Ferdinand II. against the Bohemians. As a cavalry leader, he distinguished himself; and from the regiment of cuirassiers under his command issued the death-dealing bullet to Gustavus Adolphus. In 1634, he was placed under the orders of Wallenstein, who took a great fancy to him, and confided to him his secret designs against the emperor; P., however, communicated these designs to the emperor, and received, as a reward for his fidelity, a part of Wallenstein's estates. During the remainder of this year, he was actively engaged against the Swedes, and greatly distinguished himself in the first battle of Nordlingen. In the following season he was sent with 20,000 troops to aid the Spaniards in the Netherlands, where the French and Dutch were carrying all before them. P. speedily drove out the French, but his success against the Dutch was not so marked. He was withdrawn by the emperor in 1640 to stay the Swedes, who, under Baner, were threatening the hereditary possessions of Austria; and his success against these invaders in Bohemia and the Palatinate, though damped by the defeat inflicted on him in Silesia by Torstensohn, induced the king of Spain to entreat the emperor to send him again to the Netherlands to take the command of the Spanish troops. But his success was not nearly so decisive as before, the prestige of the Spanish infantry having been completely destroyed by the great Condé at Rocroi (19th May 1643). P., however, was again successful against both the French and Dutch till 1648, when he was anew summoned to Germany to encounter the victorious Swedes; but after a brief campaign, the peace of Westphalia (1648) put an end to his career. He was created a field-marshal by the emperor, and was sent as plenipotentiary to the Congress of Nuremberg (1649), and soon after was raised to the

high dignity of a prince of the empire. The king of Spain conferred upon him the order of the Golden Fleece, and bestowed upon him in fief the duchy of Amalfi, which had previously belonged to his family. P. died at Vienna, 11th August 1656, leaving no children; his son Max, who figures in Schiller's *Wallenstein*, is only a poetical fiction. His fame as a warrior and general is somewhat tarnished by his cruel treatment of a number of Hessian and Lüneburger prisoners in 1640.

**PICHEGRU, CHARLES**, a French general, was born 16th February 1761, at Arbois, in the department of Jura, France. Though of humble parentage he succeeded in gaining admission to the college of his native town, where, and subsequently at Brienne, he received a thorough education. He was specially distinguished in mathematics, and had some thoughts of devoting himself to teaching as a profession; but the advice of Father Persault induced him to enter an artillery regiment in 1783, and he had risen to the rank of a lieutenant when the Revolution broke out. P. became an ardent democrat; joined the army of the Rhine, and by his brilliant soldierly qualities soon attracted general attention. In 1793, he became commander-in-chief of the army, and in conjunction with the army of the Moselle under Hoche, repeatedly defeated the Austrians, took from them many important towns, as Gemersheim, Spire, Worms, &c., and established himself in the Palatinate; while, after the arrest of his coadjutor Hoche, his success at the head of the combined Rhine and Moselle armies was not less decided. The rapidity and boldness of his manoeuvres, when he took the command of the army of the north, in 1794, disconcerted the allies; and before long they were compelled to retreat beyond the Meuse. After a brief respite, P. crossed this river, driving the British before him; and by February 1795, had completed the conquest of the Dutch towns and provinces, ending the campaign by capturing the enemy's fleet (which had been frozen in). He next visited Paris, and while there, suppressed an insurrection of the faubourgs (1st April 1795); but soon afterwards returned to the army, which was now opposed to the Austrians on the western frontier, and for some time displayed his usual skill and energy, crossing the Rhine in the face of the enemy, and capturing Mannheim, the chief fortress, on its banks. But the anarchy which he had found at Paris, combined with the flattering promises and bribes held out to him by the Prince of Condé, converted P. into a secret partisan of the Bourbons. His remissness, the unwonted folly and awkwardness of his military manoeuvres, though prearranged with the Austrian generals, was not suspected till he suffered himself to be shamefully defeated at Heidelberg, and then retreated, leaving Jourdan (q. v.) without support, thus compelling the latter also to retire. The suspicions of the Directory were now aroused, and being confirmed by the seizure of P.'s correspondence, he was immediately superseded by Moreau (q. v.), and retired to his native town, where he lived till 1797, when he was elected one of the council of Five Hundred. He soon became president; but continuing his intrigues with the Bourbons, he was arrested, and subsequently transported to Cayenne. Escaping in June 1798, he made his way to Surinam, whence he sailed for England. He now entered heart and soul into the Bourbon conspiracy along with George Cadoudal (q. v.), the two Polignacs, De Rivière, and others, the primary object being the assassination of the First Consul. The conspirators secretly reached Paris, and there P. attempted to persuade Moreau, who was also a royalist, to join with them, but

without success. But the plans of the conspirators were soon known to the police; and an intimate friend of P., with whom he resided, sold the secret of his retreat to the police for 100,000 crowns. P. was surprised in his sleep, and carried off naked to the Temple, where he was found dead in his bed on the morning of 6th April 1804. The Royalists have endeavoured to fasten a charge of private assassination on Napoleon, but it is more generally believed that P. strangled himself.

**PICHINCHA**, an extinct volcano in the west cordillera of the Andes, in Ecuador, about ten miles north-west of Quito. It is of irregular form, and is 14,984 feet in height. Around the crater are two other peaks of nearly equal elevation.

**PICHLER, KAROLINE**, one of the most eminent novelists of Germany, was born in 1769 at Vienna, where her father, Franz von Greiner, held several legal offices and court dignities. In 1796, she married Councillor Andrew Pichler, and published her first work under the title of *Gleichnisse* (Wien, 1800). This was quickly followed by other writings, as the novels *Olivier* (Wien, 1802); *Leonora* (Wien, 1804); *Ruth* (Wien, 1805), &c.; and the success which attended the appearance of these productions, encouraged her to try a more ambitious line of composition. In 1808 appeared *Agathokles*, which, according to some critics, is the best of her novels. In this work, she endeavoured, in opposition to the views expressed by Gibbon, in his *History of the Decline of the Roman Empire*, to depict the ennobling effect of Christianity on the human mind. At the suggestion of Hormayr and other literary friends, who had been struck by the success with which she threw herself into the spirit of the times of which she wrote, she turned her attention to the task of popularising German history, with the view of fostering a more general feeling of patriotism. Among her best works of this kind, which appeared between 1811 and 1832, and the earlier of which preceded Scott's greatest historical novels, we may instance *Grafen von Hohenberg* (Leip. 1811); *Die Belagerung Wien's von 1683* (Wien, 1824); *Die Schweden in Prag* (Wien, 1827); and *Henriette von England* (Wien, 1832); while of her social novels, the following are among the most popular: *Frauenwürde* (Wien, 1808); *Die Nebenbuhler* (Wien, 1821); and *Zeitbilder* (Wien, 1840). She died at Vienna in 1843. Her dramas were failures, and in her novels there is not a little tedious diffuseness, a remark which applies with equal truth to her autobiography, which appeared at Vienna in 1844 under the title of *Denkwürdigkeiten a. m. Leben*, and formed part of the edition of her collected works, published at Vienna in 1845 in sixty volumes.

**PICKET**, in Military Language, has several significations. It applies to a stake shod and sometimes ringed with iron, driven into the ground, and used to sustain ropes, which mark off sections in a camping-ground, or for tying horses to. These pickets are four or five feet long. Short pickets about eight inches long are employed as anchors for the ropes extending tents.—In Fortification, pickets are pointed stakes for punning gabions together and to the ground; also, when pointed at both ends, and laid close together, of different lengths, and in a position inclined towards the front, they form a powerful obstruction to the advance of a storming party, having a great effect in breaking a line of soldiers.—*Picket* was formerly a military punishment, where the culprit was held by the raised arm in such a position that his whole weight fell on one foot, which was supported on a picket with a blunt point. The time the man thus stood was proportioned to the offence. The punishment became

## PICKLES—PICO.

after a few moments, extremely painful : it has long been discontinued on sanitary grounds.—The word *picket*, when applied to a small guard of men, is ordinarily written *Piquet* (q. v.).

**PICKLES.** Although the term *pickled* is applied to animal substances, such as beef, pork, fish, &c., preserved in salt, yet pickles are generally understood to be the various parts of vegetables preserved in vinegar. The process employed is first to wash the articles intended for pickles in clean cold water, and afterwards to soak them for a few days in a strong solution of salt in water. They are next taken out, and if fruits or roots, dried in a cloth ; but if vegetables, such as cauliflower, &c., they must be well drained, and then placed in the vessels intended to hold them, a few peppercorns, or any other spice which is suitable, being sprinkled in from time to time. When the vessel is so far filled that it will hold no more, boiling vinegar is poured in until it is quite full, and tightly covered up. Many persons prefer to boil the spices, of whatever kind used, in the vinegar ; and some add the vinegar cold to such vegetables or fruit as are of a naturally soft substance, because, except in the case of green walnuts, and one or two other fruits, extreme softness is objectionable in pickles. When the materials to be pickled are naturally green, as in the case of gherkins or small cucumbers, French beans, &c., it is considered very desirable to preserve their colour as much as possible ; and it is sometimes very successfully accomplished by steeping vine, cabbage, spinach, or parsley leaves in the vinegar, by which their colour is imparted through the vinegar to the pickles. But this requires great care and patience, more, indeed, than is generally thought worth applying to it, and dealers consequently resort to very reprehensible methods of colouring their pickles, such as boiling the vinegar in copper vessels, and thereby forming an acetate of copper, which is green ; or even directly adding that salt to the pickles. Many serious accidents have resulted from the presence of this poison.

The principal pickles made in this country are *cabbage*, almost always made from the red variety ; to this is frequently added slices of beet-root, which are an agreeable addition, and improve the colour. The celebrated Spanish pickle is a mixture of the red cabbage and slices of the large Spanish onion. Some housewives, in their efforts to outrival their neighbours, add a little cochineal to improve the colour. The spices considered most suitable for pickled cabbage are white and black peppercorns, ginger, and mace.—*Cauliflowers*. Only the flower portion, with its white branches, is used, and in other respects they are treated as cabbage.—*Gherkins*, or very young cucumbers. These require the same spices as the cabbage ; but much care is required to keep as well as possible their green colour. This pickle is the one which British cooks and housewives most pride themselves upon making well ; and almost every one has some particular plan for its preparation. A very much approved method is to soak the gherkins in a brine, composed of six ounces of salt to the quart of water for twenty-four hours, then drain or dry in a cloth, place them in jars, and pour in the pickle, composed of vinegar, with an addition to each quart of one ounce salt, black peppercorns a quarter of an ounce, one ounce of ginger slightly bruised, one or two blades of mace, and a dozen bay-leaves. After soaking two days, they are set on the fire until they simmer, and then replaced in the jars, which must be well corked, and covered with skin, to exclude the air.—*French Beans*. The young green pods are prepared in the same way as gherkins.—*Onions and Eschalots* are carefully peeled, and, after

two days' steeping in brine, covered with boiling vinegar, to which the spice, usually black peppercorns, has been added. A small variety of onion, called the silver-skin, is generally used.—*Walnuts*. These are gathered green, and so tender that a pin can easily be pushed through them : they are useless when the shell has begun to form. They require at least a week's steeping in the brine. The vinegar must be poured on them boiling hot. The spices used are peppercorns, mace, ginger, and sometimes a little garlic and cloves.—*Mushrooms* are sometimes pickled only in brine, and are very useful for gravies, &c., in winter-time. They are also preserved in vinegar, and must be washed in salt and water quickly, and then boiled in the vinegar, to which, besides the spices, a small quantity of salt is added.—*Nasturtium*. The young green fruit or seeds of the *Nasturtium* plant, or greater Indian Cress (*Tropaeolum nasturtium*), make a most excellent pickle, which is an admirable substitute for the foreign capers in sauces for various dishes, and alone is an agreeable pickle.—Several kinds of mixed pickles are made, the chief of which is one called *Picalilly*, or 'Indian Pickle,' which consists of a mixture of cucumber, cauliflowers, &c., with a considerable quantity of mustard-seed and flour of mustard used as a spice, which gives it a bright yellow colour.

Of the foreign pickles imported from other countries, we have the unopened buds of the beautiful plant *Capparis spinosa*, called *Capers* ; olives, pickled both in brine and vinegar, but chiefly in the former—both from Southern Europe. From tropical countries, every variety of the capsicum—green shoots of bamboo—and the fruit of the mango, which is in much esteem wherever it is known, notwithstanding a turpentine flavour, which is not agreeable at first. Besides these, there are numerous other pickles of less importance, almost every soft part of wholesome vegetables being adapted for this mode of preparation. Pickles generally are considered provocatives to appetite, and if used judiciously, and made properly, are wholesome and agreeable additions to our food.

**PICO**, one of the Azores Islands, stands midway between the eastern and western extremities of the group, a few miles south-east of Fayal. It is 45 miles long, and 5 miles in average width ; area about 225 square miles ; pop.—the descendants of Portuguese—about 30,000. It is traversed by a volcanic ridge, which rises 7613 feet high in the Peak (Pico), whence the name of the island. See AZORES.

**PICO, GIOVANNI, DELLA MIRANDOLA**, an Italian philosopher and theologian, whose genius is decidedly inferior to the reputation he once enjoyed, was the son of the sovereign prince of Mirandola and Concordia, and was born 24th February 1463. At the age of 14, he was sent to the university of Bologna, and after spending some years there, visited the principal schools of Italy and France, everywhere distinguishing himself by the extraordinary facility with which he mastered the most difficult branches of knowledge. His linguistic acquisitions embraced Latin, Greek, Hebrew, Chaldee, and Arabic, besides Italian and French ; he was familiar with the different phases of the scholastic philosophy, and he was also versed in mathematics, logic, and physics. At the age of 23, he returned to Rome, when Innocent VIII. was pontiff, and immediately sought an opportunity of shewing his learning in the most striking manner, by publicly posting up no fewer than 900 theses or propositions in logic, ethics, physics, mathematics, theology, natural and cabalistic magic, drawn from Latin, Greek, Jewish, and Arabic writers, offering to maintain an argument on each



against all the scholars of Europe, and undertaking to pay the expenses of those who came from a distance. P. presumptuously entitled his theses *De Omni Re Scibili* (On Everything that can be Known), and Voltaire sarcastically added, *et de quibusdam aliis*, which addition is as true as it is witty. P. had several encounters with notable scholars, and is reported to have come off victorious on every occasion. But his very success was the cause of misfortune. The church appointed a committee to report on the propositions of the young prince, and the result was that several of them were condemned as 'heretical,' although the author was acquitted of any heretical intentions. P. now withdrew from Rome, and after a short time settled in Florence, where he austere devoted his whole time to the composition of polemical treatises against Jews and Mohammedans, and to the refutation of judicial astrology. Among his closest friends were Politian and Ficino. He died 17th November 1494, at the early age of 31. A complete edition of his works was published at Bologna in 1496; it has since been frequently reprinted. The principal are *Heptaplus, id est de Dei Creatoris Opere sex Dierum Libri Septem*, an allegorical explanation of Creation as recorded in the Book of Genesis; *Conclusiones Philosophicæ, Cabalisticæ et Theologicæ*—these are the famous propositions which excited so much ferment at Rome; *Apologia Concordiæ Comitibus*; *Disputationes adversus Astrologiam Divinatricem Libri xii.*; *Auræ ad Familiare Epistolæ*; *De Homine Dignitate*. P. is a happy illustration of the immediate effects produced in literature by the 'revival of letters'; he is full of a specious kind of universal learning, zealous and enthusiastic, but destitute of originality, depth, or creative power. 'He was,' says M. Matter, 'a prodigy of memory, elocution, and dialectics, but neither a writer nor a thinker.'

**PICOTEE.** See CARNATION.

**PICROTO'XINE** (C<sub>10</sub>H<sub>7</sub>O<sub>4</sub>) is the active principle of *Cocculus indicus*, from which it may be extracted by boiling alcohol, or by water containing a little hydrochloric acid. It crystallises in colourless prisms. This substance is extremely poisonous, one-third of a grain being sufficient, when introduced into the stomach of a cat, to produce tetanic convulsions and death in ten minutes.

**PICTOU'**, a thriving seaport on the north coast of Nova Scotia, on the north shore of an ample and perfectly protected harbour, 85 miles in direct line north-north-east of Halifax. Lat. of light-house, 45° 41' N.; long. 62° 40' W. It stands in a fertile and well-cultivated district, with extensive coal-mines and quarries of building-stone in the vicinity. In 1859, it exported 105,528 tons of coal. It also exports building-stone, dried fish, and potatoes. Its commerce is rapidly increasing. The mean summer temperature of P. is 63° 52', and the mean temperature for the year is 42° 09'. Pop. (1861) about 3000.

**PICTS**, the ancient inhabitants of the north-eastern provinces of Scotland. Everything connected with the history of the P. has been made matter of controversy, and it is not easy to ascertain the truth, where the information given by early writers is so scanty, and where most modern authors seem only to have looked for materials to support a favourite theory.

It will be unnecessary to enter on an examination of the name itself. The 'Picti' of the Romans probably represented a word by which the nation was known in its own language, as well as the barbaric custom to which the well-known expression of Claudian, 'nec falso nomine Pictos,' bears reference. Of much more importance is the inquiry regarding

the origin and language of the Picts. This is what, among Scottish antiquaries, has been emphatically called 'the Pictish question;' respecting which the best-known and most amusing, and certainly not the least useful discussion, is that between Jonathan Oldbuck and Sir Arthur Wardour, in the sixth chapter of *The Antiquary*. The disputants can hardly even now be said to be agreed; but the prevailing opinion is, what sound criticism always pointed to, that the P. were a Celtic race—perhaps the first known inhabitants of Northern Britain, and (as some hold) to be identified with the Caledonians of the Roman writers. At the time when they became generally spoken of under the name of P., they occupied the whole territory north of the Firth of Forth, except the western portion, which had been colonised or subdued by the Scots, another Celtic nation, whose chief seat was in Ireland—the proper and ancient Scotland. The southern boundary of the P. was the Roman province of Valentia, embracing the territory between the two Roman walls. At a later period, when Britain was abandoned by its imperial rulers, the boundaries of the various nations occupying the northern part of the island may be traced with considerable distinctness. Making allowance for partial changes at various times, these boundaries may be held to be the following: The Pictish territory extended along the whole sea-coast from the Firth of Forth to the Pentland Firth. It was bounded on the west by the country of the Scots, which extended along the western coast from the Firth of Clyde to the modern Ross-shire; but the precise line between the two nations cannot be ascertained. The country of the P. was bounded on the south by the Firth of Forth and the province of Lothian, then possessed by the English; while the country of the Scots had for its southern boundaries the Firth of Clyde and the kingdom of Cumbria, held by the independent Britons.

The Pictish nation consisted of two great divisions, called the Northern and the Southern P., the boundary between them being the mountain range known afterwards as the Grampians. These divisions seem at some times to have been ruled by different princes, at other times to have been under one sovereign. The P. were converted to Christianity at different periods. The Southern P. received the faith from St Ninian, Bishop of Candida Casa, early in the 5th century. This is mentioned by Bede, and the fact itself has never been doubted; but controversy, as usual, has been busy with the details. The point in dispute is the situation of the P. who owed their conversion to Ninian (q. v.). A careful examination of the statements of Venerable Bede, and the fuller but less trustworthy narrative of Ailred of Rievaulx, will shew that the Southern P., converted by Ninian, had their seat north of the Forth; that they were, in fact, the great division of the Pictish nation occupying the country between the Firth and the Grampians. The labours of Ninian were carried on and completed by teachers whose names are well known to the readers of ecclesiastical history—Palladius, Serf, Ternan, and others. The Northern P. owed their conversion to a teacher of higher renown—St Columba (q. v.). The life of that abbot, from his leaving Ireland in 563, to his death in 597, was chiefly spent in converting the Northern Picts. Their ruler at this time was Brude, son of Mailcon, whom Bede styles a very powerful king. His chief residence was on the banks of the Ness, and there Columba baffled and confuted the heathen Magi in the manner recorded by his biographer Adaman. It is impossible to ascertain the precise character of the superstitions held by the P. before their conversion. Those whom Adaman

calls Magi, are by some modern writers styled Druids, and their religion is said to have been a species of Druidism—whatever that may be held to mean.

Brude, the first Christian king of the P., died in 586. Catalogues are preserved, of more or less authority, of the sovereigns who succeeded him. It is impossible to reconcile the discrepancies of these lists, which probably contain the names of princes who reigned at the same time in the northern and southern divisions of the kingdom. The limits of the Pictish territories continued much the same till the middle of the 7th c., when a portion of the southern province was subdued by Oswy, king of Northumbria. In the beginning of the reign of Oswy's son and successor, Egfrid, the P. made an attempt to recover the territory which had been wrested from them. It was unsuccessful; and the power of the English was so firmly established, that the conquered province was erected into a diocese separate from Lindisfarne, the seat of the bishop being fixed at Abercorn. Encouraged by the success which had attended his enterprises, Egfrid seems to have contemplated the subjugation of the whole Pictish kingdom. He advanced northwards with his army; Brude, son of Bili, king of the P., retreating before him. The English sovereign passed the Tay, and the P. made a stand at Nechtansmere, supposed to be Dunnichen, in Angus. A conflict ensued; the English were utterly defeated, and their king was slain. The consequences of this battle, which was fought on the 20th of May 685, were very important. The P. recovered the whole territory which they had lost, and even subdued for a time a portion of the proper Northumbrian kingdom.

The next Pictish prince whose name calls for special notice is Nectan, son of Dereli, who succeeded about the year 710. He cultivated learning to some extent, and aspired to the position of an ecclesiastical reformer. The Pictish Church held precisely the same doctrines as the English; but it differed in various points of ritual, the most important of which related to the proper time of keeping Easter. The king applied for advice to Ceolfrid, Abbot of Jarrow, and the answer, which is addressed 'To the most Excellent Lord, and most Glorious King, Nectan,' is preserved among the works of Venerable Bede. Encouraged by this epistle, he summoned a council of his clergy and nobles, and enjoined them to observe the English usages. The royal command met with a ready obedience. He had also applied to the Abbot of Jarrow for architects to build a church of stone in the Roman fashion, which he proposed to dedicate to St Peter. We are told by Bede that the architects were sent, but have no further information on this interesting subject. The plans of the king were probably interrupted by dissensions among his people; and the entire assimilation of the ecclesiastical institutions of Northern Britain to those of England was postponed for four centuries.

The most active of all the Pictish sovereigns was Hungus, son of Urgust, who succeeded in 730, and reigned for thirty years. He was engaged in constant wars with the Scots, the Britons, and the English, in which he was generally victorious. After his death, the kingdom began to decline. The history of its latest period is involved in impenetrable obscurity; all that we know for certain is the final result. Various princes claimed the crown, and held possession of portions of the kingdom. But the most powerful competitor was Kenneth, son of Alpin, king of the Scots, who was descended, in the female line, from the ancient sovereigns of the P., and was probably the true inheritor, according

to the peculiar law of succession which is said to have existed among that nation. Kenneth was acknowledged as king in 843, and fixed his residence at Forteviot in Stratherna, the capital of the Pictish kingdom.

A famous passage from Henry of Huntingdon has often been quoted, in illustration of the supposed utter destruction of the P., of their princes, their race, and their language. It is referred to in that sense at the close of the following sentences of a work written some time ago, but only published in the present year. 'The Pictish vessel is seen in the distant horizon; she approaches rapidly, till you clearly distinguish the crew upon the deck; but before you are near enough to hear their voices, she sinks, the waters close over her, and the wreck never can be raised. The total extinction of the Pictish language renders any further inquiry impossible. The acumen and criticism of the 19th century cannot advance beyond the homely wisdom of the 12th century.'—Sir Francis Palgrave's *History of Normandy and England*, vol. iv. p. 294.

The impression conveyed by such words is an erroneous one. The Pictish princes still continued to reign in the persons of Kenneth and his descendants. They were kings of the P. in reality and by race, as much as James I. and his successors were kings of England. The princes did not cease in the one case more than in the other to be sovereigns of the larger kingdom, because they had previously ruled in the lesser one. Neither did the nation of the P. cease to exist. They dwelt as before in their own land; their old capital was the capital of the new kingdom; and Pictavia is spoken of by the chronicles long after the accession of Kenneth, and long before Scotia became identified with Northern Britain, or ceased to be the ordinary name for Ireland. Undoubtedly, through the influence of the kings, and perhaps of the clergy, whom the later Pictish princes had held under an oppressive bondage, the Scots became the predominant race, and finally gave their name to the united kingdom and nation. Neither did the language of the P. cease to be spoken. It continued, as before, to be the dialect of the north-eastern provinces, till, first in the extreme north, it yielded to the Scandinavian invader, and afterwards—more than two centuries subsequently to the accession of Kenneth—it began to recede slowly before the Teutonic tongue of English and Flemish colonists. The same process which destroyed the Celtic language of the Pictish people, destroyed also the Celtic language of the British kingdom of Cumbria. There is no more reason to question the causes which overthrew the ancient dialect of Fife and Buchan, than there is to question those which subverted the old speech of Carrick and Clydesdale. If anything were wanting to refute completely the popular error in regard to the destruction of the Pictish language, it would be supplied by the recent discovery at Cambridge of a manuscript of the 11th or 12th c. (see *DEER, OLD*) which contains the Celtic record how Columba and Drostan came from Iona to Aberdour, and how Bede the Pict, who was then Maormor of Buchan, gave them the cities of Aberdour and Deer.

The chief ancient authorities for the history of the P. are Adamnan's *Life of St Columba*, edited by Dr Reeves; the *Ecclesiastical History of Venerable Bede*; the *Life of St Ninian*, by Ailred of Rievaulx, in Pinkerton's *Ancient Lives of Scottish Saints*; the Pictish Chronicle, in the appendix to Innes's *Critical Essay on the Ancient Inhabitants of Scotland*, and in the appendix to Pinkerton's *Inquiry into the History of Scotland*; and

## PICTS' HOUSES—PIEDMONT.

the *Irish Annals*, edited by O'Connor. The best modern works on the subject are Innes's *Critical Essay*, and his *Civil and Ecclesiastical History of Scotland*; Pinkerton's *Inquiry*; Chalmers's *Caledonia*, vol. i.; Ritson's *Annals of the Caledonians, Picts, and Scots*; Mr Grub's *Ecclesiastical History of Scotland*, vol. i.; and a dissertation 'On the Probable Relations of the Picts and Gael with the other Tribes of Great Britain' in Garnett's *Philological Essays*, pp. 196—204.

**PICTS' HOUSES**, the name popularly given in many parts of Scotland to the rude underground buildings, more commonly and accurately called **EARTH-HOUSES** (q. v.). The name is often given also to a more advanced class of buildings of the same kind, found in the more northern counties of Scotland. The ground-plan of one of these at Kettleburn, in Caithness, explored and described by the late Mr A. H. Rhind, of Sibster, is figured in the accompanying woodcut. The outmost circle

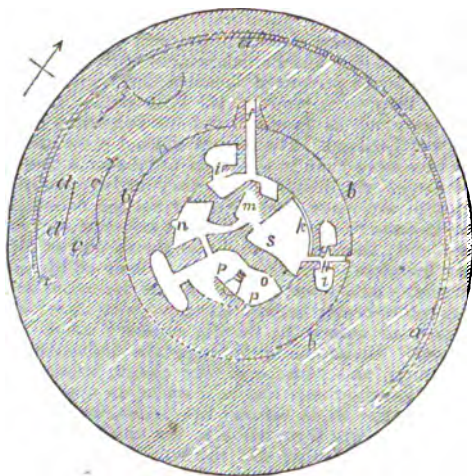

Pict's House at Kettleburn, Ground-plan.

represents the extreme limits of the mound which covered the structure; *a*, a bounding wall, three feet thick, and three feet high, rudely built of large unshaped stones; *b*, an inner wall, four or five feet high; *c* and *d*, fragments of walls faced outwards; *e* and *f*, passages leading to the inner chambers; *g*, *h*, and *i*, passages leading to smaller side chambers; *k*, a wall within the wall of the chamber *e*; *m*, a chamber, so ruined that its walls could not be traced all round; *n*, a large boulder, which, being difficult to remove, had been built over; *o*, a chamber containing a regularly built well (between *p* and *p*), nine feet deep, and roofed over. The whole walls were built without mortar. The objects found within them were remains of animals and shell-fish, fragments of pottery, and implements of stone, bone, horn, bronze and iron. The name of Picts' Houses is also occasionally given in the north of Scotland to rude stone structures above ground.

**PICTURES** are now protected by the law in a manner similar to books, the copyright of which belongs to some individual. By the act of 25 and 26 Vict. c. 68, if the author of any painting, drawing, or photograph in which there shall be subsisting copyright, after selling the same, or if any one, without the consent of the proprietor for the time being, repeat, copy, colourably imitate, or otherwise multiply for sale, hire, exhibition, or distribution, or

cause this to be done, or knowingly import into the United Kingdom, or sell, &c. such copies, he shall forfeit to the proprietor of the copyright a sum not exceeding £10, and the copies and materials shall belong to such proprietor. Moreover, if any person affix a mark, monogram, or initials of a person who did not execute or make such work, to paintings, drawings, or photographs, or fraudulently sell, exhibit, or offer such for sale, such person shall forfeit £10, or double the price of the thing sold, &c., and all spurious copies and imitations become forfeited to the real owner. This statutory protection to artists and owners of pictures, engravings, and photographs extends to the United Kingdom.

**PI'CUS AND PI'CIDÆ.** See **WOODPECKER.**

**PIE**, a well-known culinary preparation, consisting of a crust of dough or pastry, enclosing either meat or fruit, and baked in the oven. The origin of the word is very obscure. There are two kinds of pies, one in which a dish is used, as in cases where much juice or gravy has to be retained; the other, without the dish. The latter are called raised pies, and a particular kind of paste is required; which is made with hot lard and water, and must have sufficient consistency to stand up. When moulded into the form or case of the pie, it is filled with meat, usually game, and baked. This kind of crust is not usually eaten with its contents as it is considered unwholesome, it therefore merely serves as a case for the enclosed viands.

**PIEDMONT**, or **PIEMONT** (Fr. *pied*, foot, *mont*, mountain), an Italian principality, which now forms the north-west part of the kingdom of Italy, is enclosed mostly by natural boundaries, having on the N. the Pennine Alps, on the W. the Graian and Cottian Alps, on the S. the Maritime Alps and Genoa, and on the E. the Ticino and the duchy of Parma. It includes the former duchy of Montferrat (q. v.), which lies in its south-eastern corner, and the Sardinian portion of the old duchy of Milan, and contains 11,777 English square miles, with a population (1857) of 2,746,384. The mountain ranges which form its boundary on the north, west, and south, attain, in various places, a great elevation above the sea; the Col de Tende, Monte Viso, Mont Cenis, Mont Iseran, Mont Blanc, Mont St Bernard, Mont Cervin, Monte Rosa, and the Simplon, being all on the boundary-line. As to its general character, the country is partly mountainous, partly hilly, and much diversified with hill and dale; the ranges which traverse the country being spurs from the alpine boundary, and converging towards the central tract, through which flow the Po and its chief tributary the Tanaro. The valleys which separate these ranges are all watered by rivers which take their rise in the Alps, and pour their supplies into either the Po or the Tanaro, according as they come from the north and west, or from the south. The amount of the water-supply in the country may be imagined when it is considered that in P. the Po receives no fewer than 10 tributaries on the left, and 6 on the right, all of them of considerable size, and some of them, as the Tanaro and Dora Bactea, worthy of being classed as rivers. The valleys of the Po and Tanaro are exceedingly rich and fertile, producing abundant crops of grain, pulse, hemp, chestnuts, olives, and many kinds of fruit. Maize and barley are the chief cereals, the former being the ordinary article of food to the inhabitants, while abundant herds of swine are fed upon the latter. The climate is mild in winter; but in summer, especially on the level country east of the Dora Baltea and the Tanaro, the heat is scorching, and this portion would be

rendered a perfect sandy desert, were it not for the complete system of irrigation, which supplies moisture to more than half a million of acres, and renders the eastern districts the granary of the country. So valuable is the privilege of using the water of rivers as a means of irrigation, that a considerable tax is levied upon it. The other products of P. are wine and silk, which are produced in great abundance, especially silk, which is the best in Italy, and is generally exported raw. The chief manufactures are silk, linen, woollen, and cotton goods, hosiery, paper, leather, cutlery, various fermented liquors, glass, and iron. The inhabitants are active and industrious, and mostly belong to the Roman Catholic religion, but are more tolerant than in other parts of Italy. The Vaudois or Waldenses (q. v.), have from time immemorial inhabited the wild vales at the foot of the Cottian Alps, in the western corner of the principality. Many of the Piedmontese, like the Swiss and Tyrolese, spend their youth and early manhood in travelling through other countries as dealers in engravings, jewellery, and other articles of merchandise, and returning with a small hoard to spend the rest of their days in comfort in their native land.

P., in the 10th c., was possessed by the marquises of Susa, Ivrea, Montferrat, and Saluzzo; and it was not till when, a century afterwards, the marquise of Susa passed into the House of Savoy, that the latter, then counts of the Maurienne (the south portion of Savoy), gained a footing in the country. At the commencement of the 12th c., the possessions of the House of Savoy were divided, and the lines of Savoy and P. formed; but they were again united, in 1416, by Amadeus VIII. (afterwards Pope Felix V.), who, in the following year, obtained from the Emperor Sigismund the title of Duke of Savoy, which they exchanged for that of king in 1684. During the Spanish War of Succession, P. was increased by the addition of the provinces of Alessandria, Valence, Lomellino, and the Val di Sesia (1703), by Tortona and Novara in 1735—1736, and by Vigevanese and Bobbio in 1743. In 1796, it was seized by the French, and parcelled out into six departments, five being incorporated with France, and one with the kingdom of Italy; but after the fall of Napoleon, the House of Savoy recovered possession of it. See ITALY, SARDINIA, SAVOY. Since 1860, the name P., as a provincial designation, has been disused; and in the new division of Italy into 59 provinces, the boundaries of P. as a distinct country have been disregarded.

PIEPOWDER COURT, in England, an ancient court held in fairs and markets to administer justice in a rough and ready way to all comers, called also the Court of Dusty Foot (Fr. *piepoudreux*). Its jurisdiction seems to have been confined mostly to petty vagabonds, pedlars, and other wanderers. The court has long been obsolete, the only jurisdiction of that kind being now merged in the court of Petty Sessions (q. v.).

PIER, the block of solid wall between doors, windows, &c.; also a solid mass of masonry built to receive the arch of a bridge. The term is also used synonymously for the Pillars (q. v.) of a church; thus, we speak of nave-piers, &c.

PIERCE, FRANKLIN, the fourteenth President of the U.S. of America, was born in Hillsborough, New Hampshire, November 23, 1804. His father, General Benjamin Pierce, was a soldier of the war of independence, and governor of New Hampshire. Franklin P. was educated at Bowdoin College, Maine, and was an officer in a college military company, in which his biographer, Nathaniel Hawthorne, was a private. He spent his first vacation in teaching a

country school, studied law with Levi Woodbury, governor and senator, was admitted to the bar in 1827, became Speaker of the State House of Representatives in 1829, and was elected to the 33d congress, a democrat of the school of Jackson. In 1837, he was elected to the U.S. senate, of which he was the youngest member. He declined the office of Attorney-general, offered him by President Polk, and refused the nomination for governor of New Hampshire; and at the commencement of the Mexican war, volunteered as a private, but was appointed brigadier-general, and led his brigade in the battles of Contreras and Churubusco. In 1852, in consequence of the conflicting claims of the leaders of the Democratic party at the Baltimore Convention, he was nominated as a compromise candidate for the presidency, against General Scott, the Whig nominee, and received the votes of all but four states. He appointed an able cabinet, including Jefferson Davis as Secretary of War. During his administration, the Missouri Compromise was repealed; the treaty for reciprocity of trade with the British American colonies was made, and a treaty with Japan; and the Kansas difficulties which then arose, with the growing animosity between the North and South, led to secession, and the war of 1861. At the close of his term of office in 1857, he travelled in Europe, and, having no sympathy with the party which subsequently came into power, has taken no part in politics. His biography was written in 1852, by his friend and classmate, Hawthorne, whom he appointed U.S. consul at Liverpool. Mr P. is a man of marked ability, but probably owed the high position he attained more to amiable personal qualities, than to talent and statesmanship.

PIERCED, in Heraldry, a term used to indicate that a charge is perforated so as to shew the field beneath it. The aperture is presumed to be circular, unless some other form, as square-pierced or lozenge-pierced, be specified in the blazon.

PIERRE, JACQUES HENRI, BERNARDIN DE ST, a celebrated French writer, was born at Havre, 19th January 1737. He received his education at Caen and Rouen, and afterwards entered the government department of civil engineers. On his dismissal from this service in 1761, he wandered about the continent for several years, endeavouring to realise his dream of a republican colony. His adventures at St Petersburg, Moscow, Warsaw, and Dresden shew what an utter simpleton and sentimentalist P. was in his ideas of life. He returned to France in 1766, and soon after obtained a commission as engineer for the Mauritius, but parted from his companions; and after a residence of three years in the island, he returned to Paris, where he made many literary acquaintances. At this time, he wrote the story of *Paul et Virginie*, while his remembrance of tropical scenery was still fresh. The little book, with its passion, its simplicity, its tenderness, achieved an immense success, and has been translated into almost every language. St P. passed through the storms of the Revolution in safety, and was lucky enough to secure the patronage of Napoleon. From the Emperor, he received the legion of honour and a pension. He died at Erangy-sur-Oise, 21st January 1814. Besides *Paul et Virginie*, he wrote *La Chaumière Indienne* ('The Indian Cottage'), essays, a narrative of his journey to the Mauritius, and several plays. His *Oeuvres Complètes*, preceded by a life of the author, have been edited by M. Aimé-Martin (12 vols., 1818—1820).

PIETA' (an Italian word signifying piety, in the sense in which that term indicates or includes affection for relatives), the name given in the language of art to representations of the Virgin Mary

embracing the dead body of her son. It is a counterpart to the *Madonna* with the infant Jesus in her arms. The one affords an opportunity for the representation of the purest joy and highest motherly love; the other, of the utmost pain and grief. The *pietà* has long been a favourite subject, not only with painters, but with sculptors. A famous one by Michael Angelo is in the Church of St Peter at Rome.

PIETISTS, a designation given since the end of the 17th c. to a religious party in Germany, which, without forming a separate sect, is distinguished not only by certain peculiarities of religious opinion, but also by the manner in which these are manifested. The peculiar character of their religion is very generally denoted by the term *pietism*, which is frequently employed with reference to the same tendencies of opinion, feeling and conduct, where-soever and whensoever exhibited. Pietism may be regarded as consisting in an exaltation of the importance of religious feeling, and of the practical part of religion, with a corresponding depreciation of doctrinal differences, and a contempt for outward ecclesiastical arrangements; and has been more or less strongly developed from time to time in all sections of the church, a tendency towards it always existing in a large class of earnestly religious minds. In the church of the middle ages, this tendency was displayed in an endeavour to attain to a superior spirituality and purity by means of religious contemplation and asceticism, and many, consequently, embraced a monastic life. The Reformers, adopting the Augustinian doctrines, rejected this mode of seeking deliverance from indwelling sin, and proclaimed the efficacy of faith in the sacrifice of Christ. But the controversies which arose among them, and increased among their successors, gradually gave a too exclusively doctrinal and polemical character to the sermons and writings both of the Lutheran and Calvinistic divines, particularly in Germany, and a reaction ensued, not in favour of the Church of Rome, but in favour of a religion of feeling and good works, or of the heart and life. Disgust at the sectarian bitterness and exclusiveness which prevailed, led even to an undervaluing of disputed points; and thus the *Pietism* of Germany was generated and developed. The origin of it is referred to a work entitled *Vom wahren Christenthume*, by John Arnd, published in 1605; to the *Invitatio Fraternalitatis Christi* of John Val. Andrea, published in 1617, both of them Lutherans; and to the writings of Cocceius, a Calvinist. But its fuller development is unquestionably to be ascribed to Spener (q. v.), in the latter part of the 17th c., and to his friends and disciples. The name *Pietists* was first given in contempt to certain young *docents* in Leipzig, who began in 1689 to give prelections on the New Testament both to students and citizens, and to addict themselves much to a meditative mode of life. Spener had held meetings of a somewhat similar kind in his own house when preacher at Frankfurt-on-the-Maine, and in his writings had urged the necessity of a reform in the Protestant church and theology. He and his followers dwelt much upon the importance of studying the Scriptures rather than the symbolical books, upon the unfitness of any unconverted or unregenerate person for the office of the ministry, upon the right and duty of the laity to take part in the exercises of Christian assemblies, and upon the necessity of a practical rather than a systematic religion. But many of the more extreme Pietists carried their antipathy to the doctrinalism and the established services of the church to a degree that alarmed the theologians of the old school, the high and dry Lutherans, or German 'moderates,' who accused

Spener and his disciples, not without reason, of a tendency to make all goodness and virtue consist in mere religious feeling, or pious sentimentalism; to represent the divine grace as operating in too sudden and abrupt a manner; to exaggerate the value of good works; to depreciate the value of learning and of clear intellectual perception in the study of Scripture; and to indulge in a strictness of judgment upon the religious character of the ordained clergy, tending to sectarianism, and indeed incompatible with ecclesiastical unity. The weapons of argument, however, were not the only weapons employed against them. The docents were compelled to give up their prelections, and finally to leave Leipzig; the meetings for mutual edification were suppressed by the government as disorderly conventicles; and Francke (q. v.), the most distinguished of the Leipzig docents, having gone to Erfurt, was prevented from lecturing, and quickly compelled to retire. Spener's influence, however, procured a refuge for his friends in the newly founded university of Halle, and Francke obtained a professorship there. Halle became thenceforth the source of new religious influences, and, indeed, of a new religious life to Germany. The Pietists, although spiritually exclusive—disposed to regard themselves as the 'chosen of God' and to look down on all others as 'children of the world,' or even of the devil—did not attempt to form a separate sect. To do them justice, they were as far as possible from being ecclesiastically ambitious; all their desire was to excel in 'labours of love,' and to cultivate feelings of intensest piety. The rise of the Woltian or Rationalistic theology, the spread of that sort of sceptical anti-clerical philosophy which flourished for a while under the name of *Aufklärung* (Enlightenment), exercised an injurious and depressing influence on Pietism; yet through all the long obstinate warfare maintained against the doctrines of the church by the Rationalists during the last half of the 18th, and the most part of the 19th c., Pietism continued to number some adherents; and it can hardly be doubted that it is to the Pietists, and not to the Lutheran dogmatists, that Germany is in a great measure indebted for that revival of religious faith and feeling which, begun with the great Schleiermacher—himself trained up under pietistic influences—has since widely diffused itself through her biblical scholars and theologians. The patriotic enthusiasm called forth by the insolent conquests of the French, naturally allied itself to pietistic tendencies, for in Germany, the triumphs of Napoleon even as *emperor* were looked upon as the triumphs of revolutionary, republican, and infidel principles; and after the general restoration of peace, the statesmen and upper classes, especially in Prussia, believing that political security could only be obtained by a return of the populace to the simple, obedient, and unquestioning piety of earlier times, countenanced this party in the church; and amiable tea-drinking societies of devout men and women were formed to distribute tracts, and to inoculate the radical and heathen masses with pietistic sentiments. But this attempt to use 'piety' for reactionary political purposes sullied its purity, and alienated from it the very parties whom it wished to influence. Still, however, Pietism exists as a distinct element in the religious life of Germany, and now, as ever, its strongholds are Prussia (Berlin, Silesia, Wuppertal), Hesse, and Würtemberg.

PIETRA-DURA, a name given to the finest kinds of Florentine mosaic-work, in which the inlaid materials are hard stones, such as jasper, carnelian, amethyst, agate, &c. The real *pietra-dura* work dates as far back as the 16th c.,

## PIEZOMETER—PIGEON.

about 1570; and from that time to the present, has been almost confined to Florence, where a government *atlier* has existed ever since the beginning of the 17th c., which was originated in order to supply decorations for the Capella Medicea. It is sometimes called *Pietre Commesse*, and *Lavoro di Commesso*. In the inferior kinds, which are sold in Italy, and are manufactured now pretty extensively in Derbyshire and other parts of Britain, pieces of coloured sea-shells are used instead of the harder and more valuable coloured stones.

**PIEZO-METER** (Gr. *piezo*, I press; *metron*, a measure), an instrument for measuring the compressibility of fluids. Oersted's (q. v.) instrument, the first by which the compressibility of water was satisfactorily determined, consisted of a cylindrical glass jar, into the neck of which a narrower cylindrical tube of glass, open at both ends, was firmly fixed. In this tube worked an air-tight piston by means of a screw. In the interior of the jar was placed a bottle, whose neck was drawn out into a long capillary graduated tube, and alongside this bottle was suspended a cylindrical tube, closed at the top, but open at the bottom. When the compressibility of any liquid was to be determined, the instrument was adjusted in the following manner: the bottle inside was filled almost to the top of the capillary tube with the fluid, and being replaced inside the jar, the latter was completely filled with water up to the piston in the neck. The liquid in the submerged bottle, then under pressure of the water above it, fell slightly in the capillary tube, being kept from contact with the water by an air-bubble, the motion of which up or down, according as the pressure was less or greater, served as an index for reading off the graduation. The suspended tube alongside being at first only filled with air, the water rose in it to some extent, and by graduations on the tube it was made to indicate the pressure in atmospheres or parts of atmospheres. Pressure was now applied to the water in the jar by screwing down the piston; the compressed water communicated the pressure to the liquid in the bottle and to the air in the suspended tube; the descent of the air-bubble in the former indicating the amount of diminution in bulk the liquid had undergone (the capillary tube being graduated in inches and parts of inches, and each inch of tube being known to contain a certain fraction of the contents of the bottle), while the ascent of the water in the suspended tube shewed the amount of pressure which had been applied.

**FIG.** See Hoc.

**PIGEON** (Ital. *pigione*, *piccione*, or *pipione*, from *pipiare*, Lat. *pipire*, to peep or cheep), a name sometimes applied, like Dove (q. v.), to all the species of *Columbidae* (q. v.), and sometimes almost restricted to those still included by ornithologists in the genus *Columba*; having a bill of moderate length, hard, and a little arched at the point, the base of the upper mandible covered with a soft thick skin, in which the nostrils are pierced; the feet with toes divided to the base, and formed both for walking and perching; the wings rather large and pointed; the tail of moderate length, and generally square at the end. The species of this group are numerous, and occur in almost all parts of the world. Some of them build their nests in trees, and some in holes of rocks; they lay only two eggs at a time, but breed twice or oftener in a year, and both the male and the female take part in incubation. The original of all the varieties of the DOMESTIC P. is now almost universally believed to be the ROCK P. or ROCK DOVE (*C. livia*), the *Biset* of the French, a bird of extensive geographical range, being found as

far north as the Farøe Islands, and on many parts of the coasts of Europe, Asia as far as Japan, and the north of Africa, breeding in crevices of rocks, and often within caverns which open on the sea. It swarms in prodigious numbers in some of the rocky islands of the Mediterranean; and even on the British coasts, great numbers are found in some localities, particularly in the Orkneys and Hebrides. Its food consists partly of molluscs and other small animals, partly of grain and seeds; and it often makes unwelcome visits to the corn-fields of its vicinity. In a wild state, this bird exhibits great uniformity both of size and plumage; being not quite twelve inches in length from the tip of the bill to the end of the tail; the prevailing colour bluish-gray, in some parts with green and purple reflections, two broad and distinct bars of black across the closed wings; the lower part of the back white; the tail deep gray, with a broad black bar at the end; the bill blackish-brown; the legs and toes reddish-orange.—Until recently, naturalists very generally confounded this species with the STOCK DOVE or SMALLER WOOD P. (*C. oenas*), a species which inhabits woods, and generally builds in trees, preferring the hollows of old decaying trees, or the tops of such as have been pollarded and have become bushy—whence the name *Stock Dove*. In some of the open parts of England, however, it makes its nest in rabbits' burrows or other holes in the ground. It is rather larger than the Rock P.; its prevailing colour is bluish gray, in some parts passing into pale gray, but nowhere into white; the wings destitute of bands; the sides of the neck with green reflections; the breast purplish red. It congregates in large flocks in autumn and winter. It is partially migratory in some parts of Europe; a summer visitant of the northern regions. In Britain, it is found only in the southern parts of



1, Ring Dove, Cushat, or Wood-pigeon; 2, Biset, or Wild Rock Pigeon; 3, Collared Turtle.

the island. Its geographical range includes great parts of Europe and Asia, and the north of Africa. It feeds on beech-mast, acorns, grain, pulse, &c., and sometimes resorts to turnip-fields to eat the tender tops. Its voice is very different both from that of the Rock Dove and that of the Ring Dove.

Its flesh is of very fine flavour.—The RING DOVE, WOOD P, or CUSHAT (*C. palumbus*), is the most common British species, and is diffused over great part of Europe, either as a permanent resident or a summer bird of passage, although it is not found at all in some of the most northern regions; and occurs also in the temperate parts of Asia, and the north of Africa. Its soft loud coo is one of the pleasant intimations of approaching spring. It inhabits woods, and builds its nest among the branches of trees. It is the largest of the British species, being about seventeen inches in entire length. It feeds on green corn, young clover, turnip-tops, grain, pulse, acorns, &c. Where it abounds, its voracity is often very injurious to the farmer. It is gregarious in winter. It is in considerable estimation as an article of food; but it is very shy and wary, not easily approached by an inexperienced sportsman.—These are all the British species of pigeon. Our limits quite preclude us from noticing almost any other. The RING-TAIL P. (*C. Caribbea*) may be mentioned as a West Indian species, much valued for the richness and delicacy of its flesh, which is reckoned one of the greatest luxuries of that part of the world. The BALD-HEAD or WHITE-HEADED P. (*C. leucocephala*) is another large and fine species, plentiful in the West Indies. It migrates to the Keys of Florida in summer.—The DOUBLE-CRESTED P. (*C. dilopha*) is a large species, inhabiting the north of Australia and warmer regions to the northward, remarkable for its crest, which consists of two parts, one on the back of the head, and another of lax recurved feathers springing from the forehead, and even from the base of the bill.

Only one species of P. has been truly domesticated, and having long been so, it has undergone many remarkable changes, and there are numerous varieties or breeds; some of them, exhibiting very strange peculiarities, and known as *fancy pigeons*, being carefully preserved and tended by pigeon-fanciers. Pigeon-fancying is nowhere carried further than in London, where there are many persons who give great part of their time to it, and whose pigeons are their chief delight. The prices of such fancy pigeons as are deemed most perfect of their kind, are very high. The ordinary domestic pigeons, kept for profit as a kind of poultry, differ from the wild rock dove chiefly in colour, in which they are often very unlike it, although a tendency always manifests itself to return to the original colours, and the bars on the wings are apt to reappear in the progeny even of what may be called the most artificial varieties. Of these may be mentioned, as among the most interesting, the Rough-footed P., having the feet feathered; the Jacobin, which has a range of feathers inverted over the head, and extending down each side of the neck, as a hood; the Fan-tail, or Fan-tailed Shaker, in which the number of the tail-feathers is greatly increased, and the bird has the power of erecting its tail like that of a turkey-cock, whilst it has also a peculiar vibratory motion; the Tumbler, so called from tumbling in the air in its flight, and further characterised by a very short bill; and the Pouter or Cropper, which has the power of blowing up its crop to an extraordinary degree, so that the head seems fastened on the top of an inflated bladder. The Carrier P. (q. v.) is regarded as a variety of the Common Pigeon.

The law regarding pigeons is stated in the article DOVECOT. For the profitable keeping of pigeons, it is necessary to have a properly-constructed dovecot, divided into cells, a cell for each pair, each cell sixteen inches broad, by twelve from front to back, and the door towards one side, so that the nest may not be seen from without; a slip of wood in front

of each cell for the birds to sit and coo on. The dovecot must be placed at such a height as to be out of the way of rats and other depredators; and must be frequently cleaned, otherwise it may probably be deserted by its occupants. It ought to be painted white, that colour being very attractive to pigeons, and contributing to retain them when a new dovecot is established, in which there is often found to be not a little difficulty. Pigeons begin to breed at the age of nine months, and breed every month except in very cold weather. The male and female continue faithful to each other from year to year, a circumstance noted by Pliny and others of the ancients, and evidently, as well as their somewhat demonstratively manifested affection, a reason of the poetic references often made to the dove.

PIGEON PEA (*Cajanus*), a genus of plants of the natural order *Leguminosae*, suborder *Papilionaceae*, of which, according to some botanists, there is only one species (*C. flavus*), a native of the East Indies, but much cultivated also in the West Indies and in Africa; according to others, there are two species, *C. flavus*, with flowers entirely yellow, the pod marbled with dark streaks, and two or three seeds in each pod; and *C. bicolor*, called CONGO PEA in the West Indies, the pulse of which is much coarser, and is used chiefly by negroes. The finer kind is nearly equal to the Common Pea. This kind of pulse is very much used in tropical countries. The plant is a shrub (*Cytisus cajan* of Linnæus) about eighteen inches high. It is half-hardy in the south of England. In tropical countries, the plants stand and are productive for several years. They throw off their leaves annually, and reproduce them along with their flowers. The P. P. is one of the most valuable of the tropical kinds of pulse. It grows either on rich or poor soils. It is called *Doll* and *Urhur* in the East Indies. The name P. P. is West Indian.

#### PIGMENTS. See PAINTS.

PIKE, PIKEMAN. Previously to the use of the bayonet, infantry of the line of battle—that is, the heavy-armed troops—were from the earliest times armed with pikes or spears. The Macedonians carried pikes 24 feet long; those of modern warfare averaged 12 or 14 feet. They were of stout wood, and tipped with a flat iron spearhead, which sometimes had cutting edges. As a defence against cavalry, the pike, from its length and rigidity, was of great value; but though it long survived the introduction of gunpowder, that event was really fatal to it. For success with the pike, especially in offensive war, a depth of several men was essential, and this depth rendered the fire of artillery peculiarly fatal. The pike is now superseded by the bayonet on the end of the musket.

PIKE (*Esox*), a genus of malacopterous fishes, including all the species of the family *Esoxida*, as restricted by Müller, and characterised by an elongated body, covered with scales, a depressed head, and broad blunt muzzle, with very large mouth, abundantly furnished with teeth of various sizes on the jaws, palatine bones, and vomer; no adipose fin; and the dorsal fin placed very far back over the anal fin. The species are not numerous; they are all inhabitants of fresh water in the northern hemisphere. Only one is found in Europe, the COMMON P. (*E. lucius*), a native also of Asia and North America. It is very generally diffused over Europe, and is abundant even in its most northern regions; and is now abundant in lakes, ponds, and slow rivers in all parts of the British Islands, although it is supposed not to be truly indigenous to them, but introduced. The statement, which has been often made, however,

## PIKE—PIKE-PERCH.

that it was introduced in the reign of Henry VIII., is certainly erroneous, as there is evidence of its existence in England at a much earlier date. Edward I., graciously regulating the price of commodities for his subjects, fixed the price of the pike higher than that of the salmon, and ten times higher than that of the turbot and the cod, from which we may perhaps infer its comparative rarity at that period. Some of the waters in the fenny districts of England are peculiarly adapted to pike, which are there found in very great quantity, and of superior quality.

The P. is of a dusky olive-brown colour on the upper parts, becoming lighter and mottled with green and yellow on the sides, and passing into silvery white on the belly; the fins brown; the larger fins mottled with white, yellow, and dark green. The tail-fin is forked. The P. grows to a large size, occasionally attaining a weight of sixty or seventy pounds, although the stories of pikes much larger than this are liable to suspicion. The excessive voracity of the P. has long been proverbial. No animal substance which it can swallow, and which is capable of being digested, seems to be unpalatable to it; and no animal large enough to attract its attention, and which it can master, escapes being devoured. Mr Jesse mentions an instance of eight pike, of about five pounds' weight each, consuming nearly 800 gudgeons in three weeks; and one of them devoured four roach, each about four inches in length, in rapid succession, and seized the fifth, but kept it in his mouth for about a quarter of an hour before

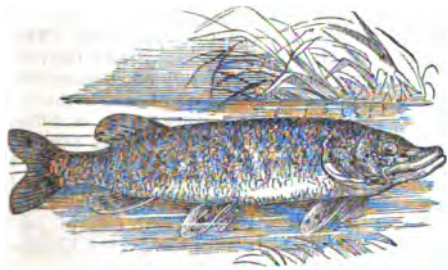

Pike, or Jack (*Esox lucius*).

swallowing it. The P. readily attacks a fish of its own size, and preys freely on the smaller of its own species. Frogs are frequent prey; water-rats and ducklings are sometimes devoured. A large P. often takes possession of a particular hole in the bank of a river, from which it issues to seize any creature that may pass.—The P. spawns in the beginning of spring, for that purpose ascending narrow creeks and ditches, in which it is very easily caught by nets. Large quantities are caught at the spawning season in Lapland, and dried for future use. The P. grows very rapidly when the supply of food is abundant, reaching a length of 8 to 10 inches in its first year, 12 to 14 in the second, 18 to 20 in the third, and afterwards increasing for a number of years at the rate of about four pounds every year. A young P. is sometimes called a *Jack* or *Pickered*. The name *Luce* (Lat. *lucius*) is still known as an English name of the pike. The Scotch name is *Gedd*, a name similar to those in the Scandinavian languages.

The flesh of the P. is much esteemed, but that of pikes of moderate size is reckoned superior to that of small, or of very large ones.

The P. is not only caught by means of nets, but by the rod, by set lines, and by *trimmers* or *liggers*, which may be briefly described as floats with lines

attached to them, the line being so fastened that the bait swims at a proper depth, and that some yards of line run out when the bait is taken. The floats are sometimes made of wood or cork, sometimes of bundles of rushes, sometimes of bottles. In angling for P., various baits are used, such as a minnow, par, or other small fish, a portion of a fish, &c., and sometimes an artificial fly is employed with great success, made of two large hooks tied together, and adorned with two *moons* from a peacock's tail. The angler unaccustomed to the P. must be cautioned as to the manner of the taking the hook from its mouth, as any rashness may lead to severe laceration of his hand by its teeth. P. may be fished any time from May to February inclusive, except when it is actually freezing. The best month is considered to be

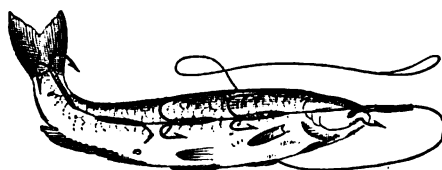

Pike Spinner.

November; the P. are then in the best condition. One of the most approved tackles for angling for the P. is the *Spinner*, baited with a small dace, bleak, gudgeon, or par of about two ounces, as represented in the fig. The mode of using it is thus described in Bailey's *Angler's Instructor* (Longman & Co. 1857): 'Having cast your bait as far as possible, allow it, if you are fishing in a pond, or lake, or deep water, to sink a little, say two feet, then wind away at a brisk rate, holding your rod on one side rather low; if no run, wind out and throw again, but this time wind brisk four or five yards, then all of a sudden stop a moment, then off again, doing so three or four times in one cast. I have often found this a good plan. If you still have no run try another throw and wind brisk as before, but occasionally giving your rod a sharp but short twitch.' See also Otter's *Modern Angler* (Alfred and Son, London).

Other species of P. are found in the lakes and rivers of North America, as *Esox estor*, which is sprinkled with round blackish spots, and *E. reticularis*, which is marked with a network of brownish lines.

The Gar-fish (q. v.) is sometimes called the Sea Pike. The same name is also given to certain large voracious fishes of warm seas, belonging to the perch family.—The Saury P. is noticed in a separate article.

**PIKE-PERCH (*Lucioperca*)**, a genus of fishes of the perch family, having two dorsal fins, of which the first has strong spiny rays, but resembling the pike in its elongated form, large mouth, and formidable teeth. The muzzle is not, however, broad and depressed, as in the pike. Several species are known, of which one (*L. sandra*) is common in the Danube, and in most of the rivers and lakes of the north-east of Europe; extending westward to the Oder and the Elbe, although not found in Italy, France, or Britain. It is highly esteemed for the table, and its introduction into British rivers seems particularly desirable. Salted and smoked, it is a considerable article of trade in some parts of Europe. It is a fish of rapid growth, and attains a weight of 25 or 30 pounds. This fish readily takes the minnow and the artificial fly. It is called *Sander*, *Sandel*, or *Sandat*, in some parts of Germany; *Nagmail* in Bavaria; and *Schill* at Vienna.—Another species (*L. Americana*), much resembling it, of a greenish-yellow colour, is found in the lakes and rivers of North America.



**PIKE'S PEAK**, a peak of the Rocky Mountains, in the U.S. territory of Colorado, lat. 39 N., long. 105° W., discovered by General Pike, U.S.A., in 1806. It is made by different measurements 12,000 and 14,500 feet high, and commands a view, of 100 miles' radius, of a rugged, mountainous country, containing many lakes, and the sources of four great rivers—the Platte, Arkansas, Rio Grande, and Colorado of California. In 1859, large deposits of gold were discovered in this region; and in 1860 it had a population of 60,000, and produced 4,000,000 dollars in gold. It abounds in rich gold-bearing quartz. The mining country is 5000 feet above the sea, with a dry climate, having a rainy season of only seven weeks. Denver City, the capital of the territory, has a population of 6000.

**PILA'STER**, in Classical Architecture, a square pillar, sometimes standing free, but usually attached to a wall, from which it projects  $\frac{1}{4}$ th,  $\frac{1}{2}$ th, or other definite proportion of its breadth. Greek pilasters, or antæ, were of the same breadth from top to bottom, and had different capitals and bases from those of the orders with which they were associated. The Romans gave them a taper like the columns, and the same capitals and bases.



Pilaster.

**PILAU**, or **PILAW**, a dish common in India, Turkey, Egypt, and Syria, consists generally of rice, but occasionally some animal food is added. It is sometimes seen at tables in this country, prepared for those who have been accustomed to it abroad. The correct method of preparing it is to boil the rice for twenty minutes, with sufficient water to soak it thoroughly, and swell the grains to their utmost, taking care not to break them by making them too soft; it is then drained, and gently stirred with butter, pepper, and finely-chopped onions, and served up. This is the way in which the pilau of the poorer classes are prepared; but for the tables of the more wealthy, fowls, lamb, mutton, shreds of ham or bacon, variously cooked, but always much boiled or roasted, are placed on the top of the rice, and served up with it. In India, very numerous and elaborate receipts are in use.

**PILCHARD** (*Clupea pilchardus*, or *Alausa pilchardus*), an important fish of the family *Clupeidae* (q. v.), referred by some naturalists to the same genus with the Herring (*Clupea*), and by others to the same genus with the Shad (*Alausa*). The P. is

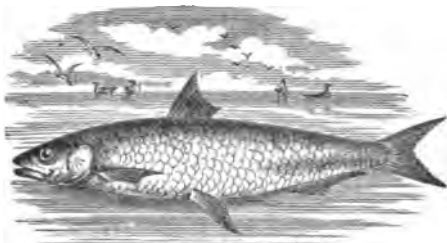

Pilchard (*Clupea pilchardus*).

nearly equal in size to the herring, but rather thicker, and the lines of the back and belly are straighter; the scales are also larger and fewer; and the dorsal fin is rather further forward. The mouth is small, and in the adult fish destitute of

teeth; the under jaw longer than the upper. The upper part of the body is bluish-green; the sides and belly silvery white; the cheeks and gill-covers tinged with golden yellow, and marked with radiating stræ; the dorsal fin and tail dusky. The P. is an inhabitant of more southern seas than the herring, being nowhere plentiful on the British coasts, except in the extreme south, and chiefly on the coasts of Devonshire and Cornwall; whilst it occurs on many parts of the Atlantic coasts of France and Spain, and on the coasts of Portugal, and is found in the Mediterranean Sea. Like the herring, it was formerly supposed to be a migratory fish, annually visiting the coasts of England and other countries; but, as in the case of the herring, this opinion has now been relinquished; and the shoals of pilchards which are seen on the coasts are believed merely to issue from deeper waters near at hand, for the purpose of spawning. The spawning season of the P. begins early in summer; but on the coasts of Devonshire and Cornwall, the principal fishery is in August and September. Pilchards are caught either with drift-nets or sean-nets, but principally with sean-nets. By means of one or more sean, each 360 feet long and 36 feet deep, a shoal is enclosed; the bottom of the net is then drawn together by a peculiar contrivance, and the pilchards are taken out at low water by small bag-nets. Prodigious numbers are sometimes enclosed in a single sean. Twenty-four millions and a half are said to have been taken at once from a single shoal, which, however, may have been spread over several square miles. The approach of a shoal of pilchards is known by the rippling of the water, and the sea-birds hovering above, and is often watched for and marked from the shore. The P. fishery on the English coast has of late been comparatively unsuccessful, probably undergoing one of those unaccountable mutations of which there are so many examples in the herring fishery in different places; but in some years the quantity taken has been very great, and the capital invested in the P. fishery in Devonshire and Cornwall is probably not much under one million sterling. The English P. fishery is regulated by several acts of parliament, the first of which are of the days of Elizabeth. Great quantities of pilchards are annually exported to the West Indies and elsewhere. Those intended for exportation are pickled, and packed in barrels by means of great pressure, by which the bulk is reduced, and oil is expressed to the amount of three or four gallons from a hogshhead of fish. The oil, with the blood and pickle with which it is mingled, is generally used for manure. A favourite Devonshire dish is a pie made of pilchards, with their heads protruding from the crust.—A great number of boats are employed in the P. fishery in and near the estuary of the Tagus.—The P. is known on the coasts of Scotland as the *Gipsy Herring*.

**PILCOMAYO**, a river of South America, whose course has not as yet been thoroughly explored, draws its waters from the Bolivian Andes, and is formed by the confluence of two rivers, the Suipacha and the Pilaya. Of these head-waters, the south one, the Suipacha, rises in the mountains immediately south of Potosi; while the northern branch, the Pilaya, drains the valleys around Chuquisaca. These streams unite in lat. about 21° 35' S., to form the P., which flows in a general direction south-east, crosses the Bolivian frontier, waters the north-east region of the Argentine Confederation, and falls into the Paraguay a few miles below Asuncion. It is at least 1200 miles in length; but its waters are much spent in lagunes on its course, so that it adds no great volume to the waters of the Paraguay. It is navigable for about 600 miles; but numerous

hordes of hostile Indians render navigation perilous. Before entering the Paraguay, it divides into two arms, of which the northern is called Araguay-Guaso; and the southern, which is again divided into two branches, the Araguay-Mino. The mouths of the P. are narrow, deep, and much obstructed by water-plants.

**PILE**, in Heraldry (from Lat. *pilum*, a javelin; or from the *pile* or stake used in the construction of a bridge), an ordinary, or, according to some

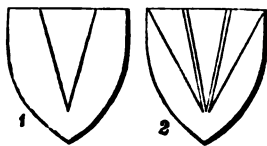

Pile.

heralds, a subordinate, in the form of a wedge, issuing generally, as in fig. 1, from the middle chief, and extending towards the middle base of the shield. It is said that a pile should occupy one-third of the breadth of the chief, or, if charged, double that breadth. When a pile is borne issuing, not from the middle chief, but from some other part of the bounding-line of the shield, this must be specified in the blazon. Three piles are sometimes borne conjoined in point, as in fig. 2. A pile *transposed* is one whose point is upward.

**PILE-BRIDGE**, a bridge of which the piers are built with piles. These may be either temporary wooden structures, in which wooden piles, driven into the ground, serve also as piers, or they may be permanent bridges, with iron cylinders forming the piles below the surface, and piers above. See **PILES**.

**PILES** are usually squared logs of wood used in engineering operations, such as dams, bridges, roads, &c. They are sharpened at the point, and, if necessary, protected with iron points, to enable them to cut through the strata they encounter as they are driven into the ground. When used for coffer-dams, or such temporary purposes, they are placed close together, and driven firmly into the earth; the water is then pumped out, and the piles form a dam, to enable workmen to lay foundations of piers, &c. When the force of the water round the dam is great, two rows of piles are driven in all round, and the space between the rows filled with clay, and puddled. Piles are also used for permanent works, when they are driven through loose soil till they reach a firm bottom, and thus form a foundation on which buildings, roads, &c., may be placed.

Cast iron is frequently used for piles, which are cast hollow. Wharf-walls are sometimes built of piles; they are then cast with grooves on the sides, into which cast-iron plates (forming the walls) are fitted.

A kind of pile has been invented by Mr Mitchell, which is of great use in very loose and shifting substances. It is called the screw-pile, and consists of a long shaft (of wrought iron), with a broad cast-iron disc, of a screw form at the lower end. These piles are especially useful for light-houses, beacons, &c., which have to be placed on sands. They are fixed by means of capstans, which give them a rotatory motion. Common piles are driven in by machines called *pile-drivers*. In these, a heavy weight (or monkey) is raised to a considerable height between two guides, and then let fall on the head of the pile. The application of steam to these drivers has made them very powerful engines—Nasmyth's steam-hammer being a well-known instance.

In 1843, Dr L. H. Potts obtained a patent for a new kind of pile, which consists of hollow tubes of iron, from which the sand, &c., within them is

removed by means of an air-pump, and the pipes are then sunk.

In recent railway bridges, cylinders have been much used to form both piles and piers. They are of cast iron, and made in pieces (of about 6 feet in height), which are applied one on the top of another. The sand or gravel is removed from the inside of the first laid, which thus sinks down; another cylinder is placed above it, and the same process continued till it also has sunk sufficiently; and so on, cylinder over cylinder, till a solid foundation is reached. The requisite number of cylinders is then piled up to form the pier above ground.

**PILES**, or **HÆMORRHOIDS**, are small tumours situated either within or on the verge of the anus. They consist of folds of mucous and sub-mucous membrane in an inflamed, infiltrated, or permanently thickened condition, and usually contain enlarged veins. There are several varieties of these tumours. Sometimes the pile is mainly composed of a little knot of varicose veins in the sub-mucous tissue; in this case, it is readily emptied, by pressure, of the fluid blood contained in it, which, however, returns when the pressure is removed. Sometimes the blood in a dilated vein coagulates, forming a solid tumour surrounded by tissues, thickened in consequence of inflammation; or the tumour may consist of a kind of erectile tissue formed by an abnormal condition of the vessels of the mucous membrane; this variety is especially liable to bleed. These tumours are divided into *bleeding* and *blind* piles, according as they are or are not accompanied with hæmorrhage; and into *internal* and *external* piles, according as they are within or without the sphincter muscle of the anus.

The following are the general symptoms of this affection. The patient, after having experienced for a varying time a feeling of heat, fulness, and dull pain about the lower part of the bowel, becomes conscious of a sensation as if there were a foreign body in the anus; and on examination after an evacuation, discovers a small tumour, usually about the size of a grape, which either remains outside, or is retracted, according as it originated without or within the sphincter. This tumour gradually increases, and others form around it, until a mass at length results as large as a pigeon's egg, or larger. In its ordinary *indolent* state the tumour has little sensibility, and occasions comparatively little annoyance; but when it is *inflamed* (from strangulation of the sphincter muscle, or from any other cause), it is exquisitely tender to the touch, and is the seat of burning and stinging sensations, rendering the evacuation of the bowels (and sometimes of the bladder also) difficult and painful. In women, an inflamed pile may cause pain in the back, irritation of the womb, with mucous discharge, and many other anomalous symptoms. In severe cases, the patient can neither stand nor sit with comfort, and only finds relief in the horizontal position.

Piles may be caused by any circumstances which cause congestion in the lower bowel, such as luxurious and sedentary habits of life, pregnancy, and such diseases of the liver as tend to check the return of blood from the veins of the rectum. Moreover, anything that causes irritation of the rectum, such as acrid purgatives and especially aloes, dysentery, inflammation of the prostate gland, &c., may cause piles. But of all causes, constipation is probably the most frequent; it operates in producing them partly by the pressure of the accumulated and hardened feces upon the veins carrying the blood away from the rectum, and partly by the straining and irritation such feces occasion during their evacuation.

In the treatment of piles, it is expedient to relieve

## PILEUS—PILLAR.

the congested state of the lower bowel by one or two doses of sulphate of magnesia, and a cooling vegetable diet, after which the continued use of mild laxatives should be resorted to. A teaspoonful of an electuary, consisting of an ounce of confection of senna, half an ounce of cream of tartar, and half an ounce of sulphur, if taken in the middle of the day, usually acts gently about bedtime, which is far the best time for the bowels of patients of this kind to act, as the parts irritated by the passage of the evacuation become quieted during the night. In long-standing cases, in which there is general relaxation of the mucous membrane, the confection of pepper in doses of a drachm may be given thrice daily with advantage, or a scruple of common pitch may be taken at bedtime in the form of pills or in capsules. Amongst the milder forms of local treatment must be mentioned (1) the injection of the rectum with cold water both before and after the motion; (2) washing the anus with yellow soap and water after each evacuation; (3) the application of gall ointment or of other astringents; and (4) the injection of astringent lotions, as, for instance, of sulphate of iron, in the proportion of a grain to an ounce of water. If these fail, recourse may be had to pressure by means of instruments specially devised for the purpose; to the application of strong nitric acid, which, in the case of internal piles, affords the most speedy and effective means of relief (the operation must, of course, be performed by a surgeon, and if the parts cannot be protruded, the acid must be applied through the speculum); to ligature; or, in the case of external piles, to excision. When the piles are inflamed, leeches to the anus (but not applied directly to the tumours) are sometimes required; but the inflammation generally subsides under the influence of rest in the horizontal position, fomentations, poultices, and low diet.

The treatment of the hæmorrhage that frequently accompanies piles requires a few words. If the bleeding is moderate in quantity, and has continued for some time without inducing weakness or any other bad symptom, it is not expedient to interfere with it. When, however, it obviously requires checking, the effect of cold water injected into the rectum, as already recommended, should be tried, and, in case of its failing, astringent injections should be had recourse to. At the same time, the patient should remain in the horizontal position, and take the medicines usually prescribed for internal hæmorrhage, amongst which may be especially mentioned oil of turpentine, in doses of twenty drops three or four times a day, or ergot of rye in divided doses to the extent of a drachm daily. In rare cases, it is necessary to tie a vessel, or to touch it with a red-hot wire (through the speculum), or to plug the anus.

**PILEUS.** See FUNGUS.

**PILWORT.** See RANUNCULUS.

**PILGRIM** (Ital. *pellegrino*, Lat. *peregrinus*, 'a foreigner,' 'a visitor of foreign lands'). A pilgrim is a person who has undertaken, especially under vow, to visit, for the purpose of prayer and religious worship, some shrine, sanctuary, or other place, reputed to possess some especial holiness or religious interest. That the early Christians—as had been the habit of the Jews, and indeed of the pagan Gentiles also—regarded certain places with some sort of religious interest, seems beyond all question; and among all the places thus reputed as sacred, or at least venerable, the first rank was given to the Holy Land, and particularly to the scenes of the Passion of our Lord at Jerusalem. St Jerome (Ep. xlv.) speaks of the practice of

visiting Jerusalem as established ever since the discovery of the Holy Cross by St Helena, the mother of Constantine. He himself was a zealous pilgrim, and was followed by many of his friends and disciples; and throughout the 4th, 5th, and 6th centuries, pilgrims habitually undertook the long and perilous journey to the Holy Land from almost every part of the West. Other sacred places, too, were held to be fit objects of the same visits of religious veneration. The tombs of the apostles Peter and Paul, and the many tombs of the martyrs in the catacombs at Rome, are so described by St Jerome (*Commentar. in Ezekiel*). St Basil speaks in the same terms of the tomb of the Forty Martyrs; and the historian Theodoret tells of a practice exactly similar to that still seen in Catholic countries, of not only visiting such sanctuaries, but of hanging up therein as offerings, gold and silver ornaments, and even models of hands, feet, eyes, &c., in commemoration of the cures of diseases of their several members, believed to have been supernaturally obtained as the fruit of these pious visits. The PILGRIMAGE, however, pre-eminently so called, was that of the Holy Land; and even after Jerusalem had been permanently occupied by the Saracens, the liberty of transit for pilgrimage, on payment of a stated tax, was formally secured by treaty; and it was from the frequent violation of this immunity, and the necessity of protecting pilgrims from outrage, that the well-known MILITARY ORDERS (q. v.) had their origin. The CRUSADES (q. v.) may in some sense be regarded as a pilgrimage on a great scale; and the direct object of all the expeditions was to secure for the Latin Christians the permanent immunity of pilgrimage. On the other hand, the closing of the Holy Land against western pilgrims, consequent on the final abandonment of the Crusades, led to a great extension of what may be called domestic pilgrimage, and drew into religious notice and veneration many shrines in Europe, which, after the lapse of time, became celebrated places of pious resort. The chief places of pilgrimage in the West were: in Italy—Rome, Loretto (q. v.), Genetsano, Assisi; in Spain—Compostella, Guadalupe, Montserrat; in France—Fourviere, Puy, St Denis; in Germany—Oetting, Zell, Cologne, Trier, Einsiedeln; in England—Walsingham, Canterbury, and many others of minor note. The pilgrim commonly bound himself only by a temporary vow (differing in this from the palmer), which terminated with the actual visit to the place of pilgrimage, or at least with the return home, and by which he was bound for the time to chastity and to certain other ascetic observances. The costume consisted of a black or gray gabardine, girt with a cincture, from which a shell and scrip were suspended, a broad hat, ornamented with scallop-shells, and a long staff. Many abuses arose out of these pilgrimages, the popular notions regarding which may be gathered, although, probably, with a dash of caricature, from Chaucer's *Canterbury Tales*.

**PILLAR**, a detached support like a column; but its section may be of any shape, whereas the column is always round. Pillars have been used in all styles of architecture, and their forms and ornaments are usually amongst the most characteristic features of the style. The Greek and Roman pillars (or columns) are the distinguishing elements in the various orders. In Gothic architecture, also, the pillars are of different forms at the various epochs of that style. First, in the Norman period, we have plain massive pillars, square, circular, and octagonal, frequently ornamented with zigzag ornaments, spiral bands, &c., on the surface (fig. 1). As vaulting progressed, the

## PILLAR SAINTS -PILLORY.

system of breaking the plain surface, and giving to each portion of the vaulting a separate little

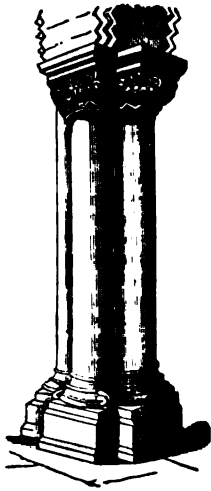

Fig. 1.—Norman Clustered Pillar.

mouldings; plain, circular, or octagonal pillars, however, are used in this, as in all the styles. The mouldings and shafts are usually filleted; and

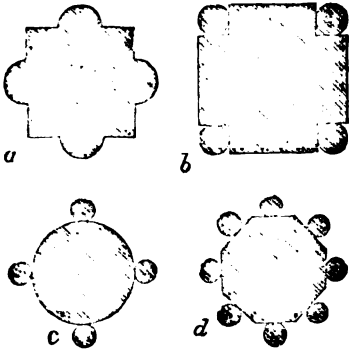

Fig. 2

some of the mouldings run up into the arch without any cap. In Perpendicular the same idea is further carried out; the mouldings become thinner, and are more frequently run up into the arch without caps. See FLAMBOYANT.

**PILLAR SAINTS**—called also 'STYLITES' (Gr. from *stylos*, a column), 'Pillarists,' 'Holy Birds,' 'Air Martyrs,' and several similar names—a very remarkable class of anchoretical Ascetics (see ASCETICISM), chiefly of Syria, who, with a view to separating themselves more completely from earth and fellow-men, took up their abode on the tops of pillars, on which they remained without ever descending to earth, and exposed to all the variations of a Syrian climate. The earliest of them, and the most celebrated, Simeon (called also Simon) the Stylite, had been a monk, and had lived, in the beginning of the 5th c., in extreme seclusion in his monastery for nine years, without ever moving from his narrow cell. Increasing in enthusiasm, he withdrew to a place about 40 miles from Antioch, where he built a pillar,

on the top of which, only a yard in diameter he took up his position. From this pillar he removed to several others in succession, each higher than its predecessor, till at last he attained to 40 cubits, or about 60 feet, in height. In this mode of life he spent 37 years, his neck loaded with an iron chain, and his lips engaged in constant prayers, during the recitation of which he bent his body so that his forehead touched his feet. His powers of fasting were no less marvellous; he is said to have frequently limited himself to a single meal in the week, and during the forty days of Lent abstained entirely from food. The fame of his sanctity brought crowds of pilgrims from the most distant countries, even Britain itself, to see him; and the admiration of his austerities is said to have converted many pagans and Saracens to the church. In trial of his virtue, through the test of humility, some neighbouring monks reproaching him with vanity, and the love of novelty in this extraordinary mode of life, ordered him to come down from his pillar. Simeon prepared without hesitation to comply, and the compliance was accepted as an evidence of his perfect humility and holiness of purpose. It is said that in consequence of an ulcer which was formed on one of his legs, he was obliged for the last year of his life to remain on his pillar upon one foot. In this position he died in 460, aged 72 years. A disciple of Simeon, named Daniel, succeeded to his reputation for sanctity; and to his mode of life, which he maintained for 33 years, in the still more trying climate of the shores of the Bosphorus, about 4 miles from Constantinople. The marvels of Daniel's career are still more startling. He was sometimes almost blown by the storms of Thrace from the top of his pillar. At times for days together he was covered with snow and ice. How he sustained life, what nourishment he took, was a mystery even to his disciples. The emperor at length insisted on a covering being placed over the top of the pillar, and Daniel survived till the year 494. In Syria there were many pillar saints as far down as the 12th c.; but in the west, Daniel is all but a solitary example. A monk named Wulfailich, near Trier, attempted the pillar-life in the 6th c., but the neighbouring bishops compelled him to desist, and destroyed his pillar.

**PILLNITZ**, a palace and ordinary summer residence of the royal family of Saxony, in a beautiful situation seven miles south-east of Dresden. The grounds are finely diversified, and the walks ascend to the summits of hills, of which one is nearly 1000 feet high. P. acquires a historic interest from the meeting of princes held in the castle in August 1791, when the Declaration of Pillnitz was framed, according to which Austria and Prussia agreed to declare the circumstances of the king of France (then a prisoner in the Tuileries, after his ineffective flight to Varennes) to be a matter of common interest to the sovereigns of Europe, and to express the hope that common cause would be made for his restoration. The emperor and the king of Prussia were resolved to use force in order to effect this result; but any immediate interference on their part was rendered unnecessary by Louis's acceptance of the constitution as modified by the National Assembly, after which he was again placed on the throne.

**PILLORY**, an engine for the public punishment of criminals, diused in Britain since 1837; but previous to that time commonly employed, as it also was in France and Germany. It consisted of a stout plank fixed like a sign-board on the top of a pole, the pole being supported on a wooden platform elevated above the ground. Above, and

parallel to this plank another of similar dimensions was placed in a similar position with respect to the pole, and fixed to the former by a hinge, being thus capable of being moved upwards from it or closed upon it, when necessary. A large circular hole is cut, with its centre in the line of junction of the two planks, and two corresponding holes of smaller size are formed, one on each side of it; the large hole is for receiving the neck, and the two smaller the wrists. When a criminal is to be placed in the pillory, he is made to mount and stand upon the platform; the upper of the two hinged planks is raised to allow the culprit's neck and wrists to be inserted in their proper grooves, and then brought down into its place, and fastened by a padlock, or in some other way. See for illustration the wood-cut to the article OATES, TITUS. The pillory seems to have existed in England before the Conquest, in the form of the stretch-neck (an instrument by which the neck only was confined), and was originally intended, according to the 'Statute of the Pillory' (51 Hen. III. c. 6), for 'forestallers, users of deceitful weights, perjury, forgery, &c.,' and all such dishonourable offences. Its use was exclusively confined to this class of offenders till 1637, when restrictions were put upon the press, and all who printed books without a licence were put in the pillory. From this time it became the favourite mode of punishing libellers (or those who were considered to be such by the government), authors and publishers of seditious pamphlets, or of strictures on the government; and many eminent men were accordingly from this time put 'in and on the pillory,' among whom may be mentioned Leighton, Lilburn and Warton the printers, Prynne, Dr Bastwick, Daniel Defoe, &c. The insufficiency of the pillory as a means of inflicting a definite amount of punishment was now apparent, for to those who were popular favourites it was no punishment at all, while those who were objects of popular dislike were ill-used to such an extent as occasionally to cause death. The sufferers above mentioned being popular favourites, or having at least a numerous class of supporters, were shaded from the sun, fed, and otherwise carefully attended to; while the encouragement, applause, and sympathy of the crowd around converted the intended punishment into a triumph, but such men as Titus Oates, and the class of offenders including perjurers, swindlers, polygamists, &c., who were objects of popular hatred and disgust, were pelted with rotten eggs (the favourite missile), garbage, mud, sometimes even with more dangerous missiles. In 1814 the celebrated naval hero Lord Cochrane (see DUNDONALD, EARL OF) was sentenced to the pillory, but the government of the day was not prepared to brave the consequences of such an act, and the sentence was not carried into effect. In France the pillory was anciently called *pilori*, and in recent times *carcan*, from the iron collar by which the criminal's neck was attached to the post; but punishment by this mode was abolished in that country in 1832.

PILLS are the most generally convenient and popular of all forms of medicine. They are formed from masses of a consistence sufficient to preserve the globular shape, and yet not so hard as to be of too difficult solution in the stomach and intestines. This form is especially suitable for (1) all remedies which operate in small doses, as metallic salts; (2) those which are designed to act slowly and gradually, as certain alteratives; (3) those which are too readily soluble when exhibited in other forms; (4) substances whose operation it is desirable to retard until they have reached the lower intestines, as in certain pills for habitual costiveness; (5) bodies whose specific gravities are

too inconsiderable to allow their suspension in aqueous vehicles; and (6) fetid substances: while it is unsuitable for (1) medicines which require to be given in large doses; (2) deliquescent salts; (3) fluid or semi-fluid substances, such as oils, balsams, &c., which require a very large proportion of some dry powder to render them sufficiently tenacious to form into a mass; (4) substances so insoluble, that when exhibited in solid form they pass through the intestinal canal unaltered, as extract of logwood (Paris's *Pharmacologia*, 9th ed. p. 550). Many substances, such as vegetable extracts, may be at once formed into pills without any addition; but most substances require the addition of a material termed an excipient, for converting it into a pill-mass. The excipients in most common use are bread-crumbs, hard soap, extract of liquorice, mucilage, syrup, treacle, honey, castor oil, and conserve of roses. From the property of preserving pills for a long time in a properly soft state, the most valuable excipient is the conserve of red roses; and, perhaps, next to it treacle is the most valuable excipient, as it does not undergo any change by time, but maintains a proper consistence, and preserves the properties of vegetable powders unimpaired for years. It is common to place pills in some fine powder, to prevent them from adhering to each other, and to conceal their taste. For this purpose, liquorice powder, wheat flour, starch, and magnesia are generally used in this country, and lycopodium on the continent. Pills retain their moisture and activity far longer in small bottles than in the ordinary pasteboard boxes. The ordinary weight of a pill is five grains; if it much exceeds that weight, it is too bulky to swallow conveniently if it consist of vegetable matter. It is very common to meet with patients who express their inability to take this form of medicine. If, however, they practise with a small globular mass, towards which they feel no repugnance, as a pellet of bread or a currant, placing it on the back of the tongue, and gulping it down with water, they will soon get over the difficulty.

PILOT is a person specially deputed to take charge of a ship while passing through a particular sea, reach, or dangerous channel. The intricacy of almost all coast navigation renders it impossible that any navigator, however skilful, can be master of all the waters to which he may have to sail his ship; and the risk of failure, through ignorance of local dangers, is therefore avoided by transferring the direction of her course to some one perfectly acquainted with the spot. The man to whom so much is intrusted must be a responsible person, and therefore in all countries qualified sailors are officially licensed to act as pilots in their districts, and they are granted the monopoly. The origin of the word pilot is uncertain; but it is probably taken from or nearly identical with the Dutch *piloot*, which is compounded of *peilen*, to sound the depth, and the root which appears in *D. looteman*, *O. E. lodesman*, and signifies to lead, direct. Pilot thus means one who conducts a vessel by sounding. The laws of Wisby, promulgated at least as early as the 14th c., and subsequently incorporated in nearly every maritime code, render it compulsory on the master of a ship to employ a pilot when sailing near a coast.

The British laws relating to pilots were revised and consolidated by the act 16 and 17 Vict. c. 129. Certain fees are established in proportion to the distance and responsibility; and the master of every vessel, above 50 tons, passing up the Channel or the Thames, or *vice versa*, is required to accept the services of the first pilot tendering, provided he

## PILOT-FISH—PIMENTO.

shews his licence as a proof of qualification. Except in matters of discipline, the command of the vessel is then vested entirely in the pilot, who can have the sails, steering, &c., of the ship carried on entirely at his discretion until the limit of the pilot's district is passed, except that the captain resumes his powers when the question of taking up ground in a harbour is concerned. The fees vary with the draught of the ship and the distance; as specimens, may be cited the highest and lowest in the London district: a ship drawing 22 feet of water is piloted from Orfordness to Blackwall for £27, 12s.; a ship drawing not more than 7 feet is guided from Gravesend Reach to Long Reach for 9s. 3d.

Pilots are associated in guilds called Brotherhoods, of which the principal are the Brotherhood of the Trinity House of Deptford-Stroud, situated on Tower Hill, which has jurisdiction over the Thames, Medway, and the coast from Harwich to the Isle of Wight; and the Trinity Houses of Kingston-upon-Hull and Newcastle-on-Tyne. There are also societies of pilots at the larger ports out of these districts, the government in such case being vested in certain officials lawfully appointed as 'pilotage authorities.' Their powers over the members, &c., are defined in the act above quoted, and in the Merchant Shipping Act of 1854, 17 and 18 Vict. c. 104, sections 330—338.

Pilots board vessels entering their districts in boats conspicuously painted, on the bows and sails of which must be the man's distinguishing number as shewn by his licence. The boat also bears a flag of comparatively large size, of red and white divided horizontally. A ship requiring a pilot hoists a square blue flag. In passing up or down the Thames, every ship above 50 tons or 6 feet draught must bear a pilot; but her master or first-mate may act by licence in that capacity, if he have passed the necessary examination. A master is subject to a penalty for sailing without a pilot; and, on the other hand, so also is any person, without a licence, or whose licence has been forfeited, presuming to act or offering to act as a pilot.

In the navies of some countries the pilot is a permanent officer of the ship, and has charge of her course; but his functions in that case approach nearer to those of the British Master (q. v.). Large French vessels have often several sailing pilots called *pilotes hauturiers*, and a *pilote côtier* or *lamanneur*. The ancient laws of France contained provisions for the education and regulation of both these classes.

The general rule as to the responsibility of the owners of the ship is, that no owner or master of a ship is answerable to any person whatever for any loss or damage, occasioned by the fault or incapacity of any qualified pilot, acting in charge of such ship within any district where the employment of the pilot is compulsory.

**PILOT-FISH** (*Naucrates ductor*), a fish of the family *Scomberidae*, and belonging to a section of that family in which the first dorsal fin is represented by mere spines, and there are no finlets behind the second dorsal and the anal fins as in the mackerel, &c. The shape of the P. is very similar to that of the mackerel. It is usually about a foot long; the general colour silvery grayish-blue, five dark-blue transverse bands passing round the whole body. Its flesh is very delicate, and resembles mackerel in flavour. It is common in the Mediterranean, and appears to be widely-diffused through the warmer parts of the ocean, often following ships for a long time and very far, in which way it has been known to come from Alexandria to Plymouth. It is, however, of rare

occurrence even on the southern coasts of Britain. It is supposed to be the *Pompilius* of the ancients, which was believed to point out their desired course to sailors. It is often seen in the company of a shark, and is therefore very commonly supposed to direct the shark to its prey. Concerning this many wonderful stories are to be found in the writings both of voyagers and of naturalists. It has been



Pilot-fish (*Naucrates ductor*).

contended, on the other hand, that the P. merely follows the ship along with the shark for the same object that gulls follow the steam-boats on our coasts, to feed on anything eatable that may fall or be thrown overboard; or that it attends the shark in order to seize small morsels of its large prey. The following statements of Dr Bennett may be received with confidence: 'I have observed that if several sharks swim together, the pilot-fishes are generally absent; whereas, on a solitary shark being seen, it is equally rare to find it unaccompanied by one or more of these reputed guides. . . . The only method by which I could procure this fish was, that when capturing a shark I was aware these faithful little fishes would not forsake him until he was taken on board; therefore by keeping the shark, when hooked, in the water until he was exhausted, or, as the sailors term it, "drowned," the pilot-fish kept close to the surface of the water over the shark, and by the aid of a dipping-net fixed to the end of a long stick I was enabled to secure it with great facility' (*Gatherings of a Naturalist*).—A much larger species of *Naucrates* is found on the coasts of South America.

**PILPAI.** See BIDPAL.

**PILSEN**, a town of Bohemia, in a fertile and beautiful valley at the confluence of the Mies and the Beraun, 52 miles west-south-west of Prague. The church of St. Bartholomew (built in 1292), the town-hall, and the house of the Teutonic Knights are interesting Gothic edifices. The town also contains a gymnasium and other educational institutions, an arsenal, theatre, and a number of churches and convents. P. has leather and cloth-factories, a great alum-work, iron and coal mines, and an important brewery. Pop. 11,500.

**PIMENTO, PIMENTA, ALLSPICE, or JAMAICA PEPPER**, a well-known spice, is the dried fruit of *Eugenia Pimento* (see *EUGENIA*), a small West Indian tree, which grows to the height of twenty or thirty feet, and has oblong or oval leaves about four inches long, of a deep shining green, and numerous axillary and terminal trichotomous panicles of white flowers, followed by small dark-purple berries. The P. tree is much cultivated in some of the West Indian Islands. It is a very beautiful tree, with straight trunk and much branching head; and about the month of July is covered with an exuberance of flowers, which diffuse a rich aromatic odour.

The leaves and bark partake of the aromatic property for which the fruit is valued. The fruit, when ripe, is filled with a sweet pulp, and the aromatic property, which so strongly characterises it in an unripe state, has in a great measure disappeared. The gathering of the berries, therefore, takes place as soon as they have reached their full



Pimento.

size, which is about that of pepper-corns. They are gathered by the hand, and dried in the sun on raised wooden floors, during which process great care is taken, by turning and winnowing, to prevent them from being injured by moisture. Their colour changes in drying, from green to reddish-brown. When dry they are packed in bags for the market. Some planters kiln-dry them.—The name *Allspice* was given to P. from a supposed resemblance in flavour to a mixture of cinnamon, nutmeg, and cloves. P. is much employed in cookery, and is also used in medicine as a carminative and stimulant, to prevent the griping of purgatives, and to disguise the taste of nauseous drugs. It depends for its properties chiefly on a volatile oil, *Oil of P.*, which is obtained from it by distillation with water, and is sometimes used to relieve toothache, and for making the *Spirit of P.* (or of *Allspice*) and *P.* (or *Allspice*) *Water of the shops*.

**PIMPERNEL** (*Anagallis*), a genus of plants of the natural order *Primulacæ*, having a wheel-shaped corolla, and the capsule opening by division round the middle. The species are elegant little annual and perennial plants, natives chiefly of temperate climates. The flowers are not large, but very beautiful.—The **SCARLET P.** (*A. arvensis*) is a common plant in Britain, occurring as a weed in fields and gardens; it is common also in most parts of Europe, and in many parts of Asia. The flowers are of a fine scarlet colour, with a purple circle at the eye. There is a common belief in England, mentioned by Lord Bacon, that when this plant opens its flowers in the morning a fine day may be expected; and they certainly close very readily on the approach of rain. They usually open about eight in the morning, and close about noon.—The **BLUE P.** (*A. cærulea*) is far less common in Britain,

but very abundant in some parts of Europe.—The **BOG P.** (*A. tenella*), frequent in bogs in England, but rare in Scotland, is an exquisitely beautiful plant.—Several species are cultivated in our flower-gardens.—Acrid properties prevail in this genus, and *A. arvensis* has been used medicinally in epilepsy, dropsy, and mania.—The name **WATER P.** is given to *Samolus Valerandi*, also called *Brookweed*, another British plant of the same order, with racemes of small white flowers, growing in watery gravelly places. It is supposed to be the *Samolus* which Pliny says the Druids gathered fasting, with the left hand, and without looking at it, ascribing to it magical virtues in the cure and prevention of diseases in cattle. Its geographic distribution extends over almost all the world.

**PIN.** As a requisite of the toilet, &c., pins were first used in Britain in the latter part of the 15th c.; they were at first made of iron wire, but in 1540 brass ones were imported from France by Catharine Howard, queen of Henry VIII. Several inventions, however, were previously in use for holding together parts of the dress, such as buckles, brooches, laces, clasps, hooks, &c. At first pins were made by filing a point to a proper length of wire, and then twisting a piece of fine wire around the other extremity, or fixing it after twisting, in order to form a knob or head; and ultimately these operations were so skilfully conducted, that a completely round head was made of very small size, and scarcely shewing the nature of its construction. Some pins are still made in this way. It is surprising how many operations are needed to complete so small an article. They are as follows: 1. *Straightening and Cutting the Wire.*—The straightening is necessary, because the wire-drawers coil the wire as they make it upon a cylinder, and when it is unrolled, the coils remain. It is therefore drawn through an arrangement of upright iron rods which completely straighten it, after which it is cut into lengths of 30 feet, and these are again reduced to lengths of four pins. 2. *Pointing.*—This is done by two operations and different workmen, each standing at a separate grindstone; the first is the rough grinder, and the second the finisher. Each holds with the thumb on the palm of the hand a number of the wires amounting to 30 or 40, and by a movement of his thumb he manages to make the wires turn round so as to make a point to each as he holds them to the grindstones, the second of which, being of a fine material, gives them a smooth finish; they are then reversed, and the other end pointed. 3. *Cutting.*—The length of a single pin is cut off of each end of these pieces; the intermediate portions are then handed back to the pointers, and each end receives a point, after which they are divided into two, and thus the four pin piece is reduced into single pin lengths, each having a point. 4. *Twisting the Heads.*—These are made of very thin wire, which is coiled twice, by means of a lathe, around the end of another piece of wire the same thickness as the pins. 5. *Cutting the Heads.*—The head being formed on the thin wire, it is handed to another workman who cuts it off; these two operations are performed with great rapidity, so great, indeed, that as many as 12,000 have been made in an hour. 6. *Annealing the Heads.*—This is softening them by putting some thousands into an iron ladle, and after making them red hot, plunging them into cold water. 7. *Stamping or Shaping the Heads.*—This is pressing the heads into a better shape by means of a small lever press, and at the same time fixing them on the pins; a good worker will do as many as 12,000 per day. 8. *Yellowing or Cleaning the Pins.*—This is done by a process which is often called *ouring*; it consists in boiling them for about half an hour in

## PIN.

the dregs of sour beer, or a solution of argol or cream of tartar, and then washing them in clean water. 9. *Whitening or Tinning*.—In this process a large copper pan is used, and in it is first placed a layer of about six pounds of the cleaned or yellowed pins, and over these a layer of grain-tin to the amount of about eight pounds. Several alternate layers of pins and tin are put in one vessel, and then by a pipe arranged inside the copper pan water is gently poured in, and goes through the pipe to the bottom, first rising up through the different layers so gently as not to disturb them. Fire is now applied to the bottom of the pan, and when it is nearly boiling its surface is sprinkled with a quarter of a pound of cream of tartar, and the whole is slowly boiled for half an hour, then poured into a strainer and shaken, to separate the pins from the grain-tin and liquid; by this process a thin deposit of tin has been thrown on the pins, which now are white instead of yellow; without the souring this would not take place, it being essential that they should be quite free from any oxidation or soil. 10. *Washing*.—The pins are now thoroughly washed in pure water. 11. *Drying and Polishing*.—They are now put into a large leathern bag with a quantity of bran, and violently shaken backwards and forwards by two men. 12. *Winnowing*.—The bran is next separated by fanning. 13. *Pricking the Papers to receive the Pins*.—This is now done by an ingenious machine, through which the papers are passed, and which, at regular intervals, arranged according to the size of the pins, pinches up a fold of the paper, and at the same time pricks the holes to receive the pins, and then places the pins in their places. Formerly this required a separate operation. Thus fourteen persons were required to make and put up for sale a pin, and in some manufactories this is still the case; but in all the large establishments machines are now employed, and an immense reduction of hand labour is effected by them.

The first machine was invented by Lemuel Wellman Wright, of the United States, in 1824. This did very little more than make solid heads to the pins, by a process in principle like that used for nail-making—viz., by driving a portion of the pin itself into a counter-sunk hole. The action, however, was automatic, and consisted in an arrangement by which the wire was seized in two small grooved cheeks, as in figs. 1 and 2, which represent them separated. Fig. 1 has the groove empty, but in fig. 2 is seen the wire which projects at *a*. When both cheeks are

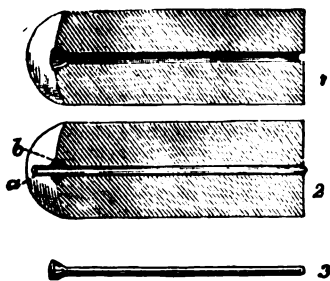

placed face to face, and the wire is held tightly in the groove with the small portion (*a*) projecting, a small ram or hammer connected with the machine strikes on *a*, and compresses it into the small cup-shaped depression *b*, and thus the head is formed, as in fig. 3. The pointing and dressing of the pins was afterwards carried on as described

in the processes for hand-made pins. Since Wright's invention many remarkable improvements have been effected in these machines, which have consequently become very complicated in their details, although the principles upon which they act are very simple. No description would convey a satisfactory idea of these wonderful pieces of mechanism, which now, without the aid of hands, complete the pin in all respects except the colouring and polishing; but a slight account of the leading features will enable the reader to understand their mode of working. First, then, a reel of wire as it comes from the wire-drawer is placed in the rear of the machine, and the end of the wire is taken hold of by a pair of nippers, which pull it over a fixed *straightening board*, and pass it on completely straightened, until it is seized by two cheeks similar to those in figs. 1 and 2, when a cutter descends and cuts it off, leaving the projecting part for the head; on the withdrawal of the cutter, the hammer flies forward, and makes the head as before described; the cheeks open, and the pins drop on to a sloping metal plate finely grooved, down which they slip with the heads upwards, until the end which is to be pointed comes in contact with a cylindrical roller with a grinding surface, which soon grinds points upon them, owing to two or three ingenious arrangements: the first is, that the grooved surface of the plate by which the pins descend terminates a little above the grinding roller, then a slight depression is given to the sloping plate and also to the roller, so that one end is an inch or two lower than the other; therefore, as the pin descends the groove (*a*, fig. 4), and is thus brought down the inclined plate until it lies on the smooth part (*b*, fig. 4), where it is highest, and with its end in contact with the grinding roller (*c*) which is revolving, the pin itself is compelled by the friction of the roller to turn round, and gradually descends from the upper to the lower part of the inclined plate (*d*), and then falls off into

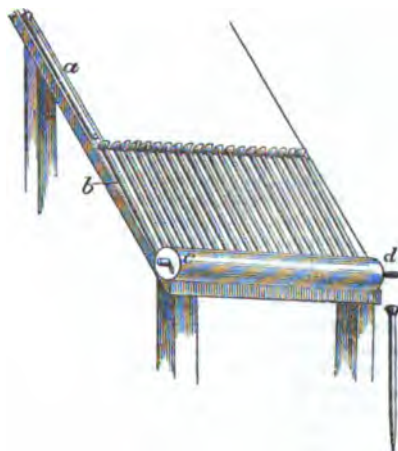

Fig. 4.

a box placed to receive it. This is attempted to be shewn in fig. 4. These operations are performed so rapidly that they can scarcely be followed by the eye, and the pins fall into the box beautifully pointed in a complete stream. They are then *yellowed, tinned*, and prepared for papering, which is a remarkable process. The machine by which it is done is worked by two children; one feeds the machine with pins, the other with papers. The first part of the machine is a box, about 12 inches



long by 6 inches broad and 4 inches deep; the bottom is made of small square steel bars, sufficiently wide apart to let the shank of the pin fall through but not the head, and they are just as thick as the space between papered pins; the bottom of the box, with the row of pins hanging through it, are seen in fig. 5. The lower part of the bottom of the

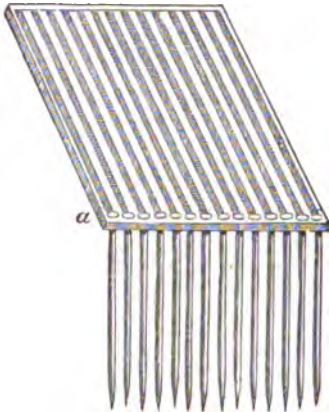

Fig. 5.

box at *a* is made to detach itself as soon as the row of pins is complete, and row after row at regular intervals is received and passed down a corresponding set of grooves, until they reach the paper which, as before described, is pinched into regular folds and pierced to receive the pins, which, by the nicest imaginable adjustments, come exactly to their places, and are pressed into them. In this way many thousands of those neat-looking paper packages of pins, with which all are familiar, are put up in one day by two little girls, aided by these wonderful machines.

**PINA CLOTH**, a very beautiful fabric made of the fibres of the leaves of the pine-apple plant (*Ananassa sativa*), and other allied species. This cloth is only made in Manilla, and in its manufacture resembles horse-hair cloth, because the threads both of warp and weft are each single unspun fibres, consequently only small pieces can be made; the workers have, however, a plan of joining the fibres of the coarser kinds end to end, so as to make warp threads of considerable length. Pina cloth is very strong, and the better sorts far excel the finest lawns in texture. It is chiefly employed in the manufacture of ladies' pocket-handkerchiefs, which often have their costliness much increased by beautiful embroidery.

**PINCHBECK** is an alloy of zinc and copper, in which the proportions slightly differ from those which constitute brass; 3 parts zinc to 16 of copper constitute this material, instead of one part of the former to two of the latter as in common brass. Pinchbeck, when new, has a colour resembling red gold, and it was at the beginning of the present century much employed in making watch-cases and other small articles in imitation of gold.

**PIND DADU'N KHAN**, a town in the Punjab, stands on a narrow verdant plain on the right bank of the Jhelum, and at the southern base of the Salt Range or Kalabagh Mountains, 110 miles north-west of Lahore. The town consists of three groups of houses, four miles from the Jhelum. The houses are built of mud, but the framework is of cedar-wood. In the vicinity, salt is extensively raised in the Salt Range. See **PUNJAB**. Entire population, 13,588.

**PINDAR** (Gr. *Pindaros*), the great lyric poet of Greece, was born, about 522 B.C., of a noble family of Thebes, at Cynoscephalæ, a village in that territory. His genius for music was hereditary, and at an early age he was sent by his father, himself a flute-player, to receive instruction in the same art from Scopelinos. At this time his genius for poetry too—foreshadowed, according to later writers, by a swarm of bees miraculously resting on his lips when asleep—began to develop itself, and so he went to Athens to be placed under the tuition of Laon of Hermione, the founder of the Athenian school of dithyrambic poetry. Before completing his 20th year he returned to Thebes, where he continued to pursue his studies under Myrtis and Corinna, of Tanagra, two poetesses then famous in Bœotia. With both of his instructresses he contested the prize for music at Thebes, but was five times defeated by Corinna. He was still a young man when he entered on his professional career as a poet, and his services soon came to be in great request on festive occasions throughout all the Hellenic states. He composed choral songs for Hiero, tyrant of Syracuse; Alexander, son of Amyntas, king of Macedonia; Theron, tyrant of Agrigentum; Arceilaus, king of Cyrene; and also for many free states and private individuals. He won not only the admiration of his employers for his lyrical genius, but also their respect for his independent character, which, amid all the presents and rewards conferred upon him, never degenerated into that of the poet who merely performed for hire. He was especially the favourite of Alexander, king of Macedonia, and of Hiero, tyrant of Syracuse; and it is said that to the praises he lavished on the former of these monarchs his house owed its preservation at the hands of Alexander the Great, when he reduced the rest of Thebes to ruins. His life was for the most part spent abroad at the courts of kings, and at the scenes of the great public games; and at one period, 473 B.C., he resided at Syracuse at the court of Hiero for the space of four years. He died most probably in 442 B.C., in his 80th year. Of the immense number of his poems, consisting of hymns to the gods, peans, dithyrambs, odes for processions (*prosodia*), maidens' songs (*parthenia*), mimic dancing songs (*hyporchemata*), convivial songs (*scolia*), dirges (*threnoi*), and encomia on princes, we only possess fragments. His *Epinikia*, or Triumphal Odes, however, have come down to us entire; and it is from these—divided into four books, and celebrating the victories won in the Olympian, Pythian, Nemean, and Isthmian games respectively—that we must form an opinion of P. as a poet. A victory at these games conferred honour not upon the winner and his family only, but also on the city to which he belonged; and for its celebration—which began with a procession to the temple, where sacrifice was offered, and ended with a convivial banquet—a poem was specially composed, and was sung by a chorus either during the procession, or, more frequently, at the banquet (*comus*). P.'s poetical style is peculiar. Full of bold conceptions and striking metaphors, his manner is so rapid and so subject to abrupt transitions, as to render him not only a difficult but an obscure composer. Typical examples of his strength, as well as of his weakness, will be found in the Second Olympian and First Pythian Odes, where the description of the Islands of the Blest in the former, and of an eruption of Mount Etna in the latter, are brilliant offsets to the shadowy mythological allusion and the undeveloped metaphor which also characterise them. His metres, in spite of the able efforts of Böckh, still remain to be satisfactorily elucidated; and all that we can

here say of them is, that he makes chief use of the Dorian rhythm, and not unfrequently of the Æolian and Lydian. He has been fortunate neither in his numerous imitators nor translators—Gray being, perhaps, the most successful among the former, and Carey and Abraham Moore among the latter. He has been elaborately explained and criticised in Schmidt's *Pindar's Leben und Dichtung* (Bonn, 1852); while his relation to lyric poetry in general forms the subject of Villemain's brilliant *Essais sur le Génie de Pindare et sur la Poésie Lyrique* (Paris, 1859). The best editions are those of Bückh; of Dissen, re-edited by Schneidewin; and of Hartung.

PINDAR, PETER. See WALCOTT.

PI'NDUS, anciently the name of a chain of mountains in Greece (q. v.).

PINE (*Pinus*), a genus of trees of the natural order *Coniferae*. The Linnæan genus includes all kinds of Fir, Larch, and Cedar; but as now limited, the genus *Pinus* is distinguished by monœcious flowers, and woody cones with numerous two-seeded scales, the scales having an angular truncated apex. The leaves are linear and very narrow, of a very dark-green colour, growing in clusters or in pairs, and surrounded by scarios scales at the base. To this genus belong many noble and useful trees. They mostly grow in mountainous or other exposed situations, and their narrow leaves are admirably adapted to evade the force of winds, which produce in the tops of pines a peculiar sound, much noticed by the ancient poets, more soft and continuous than in trees of richer foliage. Most of the pines are more or less social, one kind often covering a considerable tract; some of them clothing the sides and even the summits of mountains with magnificent but sombre forests; some growing in lower situations, on otherwise unproductive sandy grounds, as the *Pine Barrens* of North America. The pines growing in the most barren soils, or in the coldest climates and most exposed situations, are often very small; and although very unlike any other shrubs or bushes, are scarcely to be called trees. Pines are widely diffused over the northern hemisphere, being found on mountains within and near the tropics, and in the colder temperate and the arctic regions descending to the level of the sea.

The SCOTCH P. or SCOTCH FIR (*P. sylvestris*) is the only species indigenous to Britain. It has leaves in pairs, about an inch and a half long; the cones about the same length, obtuse, and with unarmed scales. On very poor soils and at great elevations it is reduced to a kind of shrub, but in favourable situations it becomes a lofty tree. A plank five feet and a half in diameter has been obtained from a Scottish forest. The Scotch P. is of quick growth, but has been known to attain the age of 400 years. Its head is somewhat conical or rounded, and the lower branches die off as the tree grows, leaving the older trees bare of branches for the greater part of their height; but it is more apt to send off large branches than most of the *Coniferae*. There are still native forests of Scotch P. at Braemar and elsewhere in the Highlands of Scotland; and even in the south of Scotland noble trees are to be seen which, probably, were not planted by man. The Scotch P. is not indigenous to the south of England, but having been introduced, is spreading rapidly and spontaneously, along with the Pinaster, in some of the heaths and other unfertile tracts. Immense forests of it exist in some countries of Europe, in some of which it is mingled with the Spruce Fir. In the middle and north of Europe and of Asia, it is found even in plains near the level of the sea, especially where the soil is somewhat sandy; in the south of Europe

it grows only on mountains. Its timber is highly valuable, being very resinous and durable, and is the *Red Deal* or *Red Pine* used in house and ship-carpentry. There is very great difference, however, in the timber of Scotch P. growing in different soils and situations, rich soils and sheltered situations being unfavourable to the quality of the timber, which becomes white, soft, and comparatively worthless; and there exist several varieties of Scotch P., some of which yield timber very superior to others. Many plantations in Britain have, unfortunately, been made of inferior kinds. One of the best varieties is that which forms the northern Scottish forests, often designated *Braemar*



Braemar Pine.

*P.* by nurserymen. It is remarkable for its very horizontal branches, and is therefore sometimes called *P. horizontalis*.—The Scotch P. is not only valuable for its timber, which is available for some purpose at every stage of its growth, but on account of other products. Common Turpentine is in great part obtained from it, and much Tar, Pitch, Resin, and Lamp-black. See these heads. Oil of Turpentine is sometimes distilled from the cones, and even from the leaves; the leaves have also been used in Germany for the manufacture of a substance resembling tow, and called *Waldwolle* (Forest Wool), suitable for stuffing cushions, &c. The resinous roots are dug out of the ground in many parts of the Highlands of Scotland, and being divided into small splinters, are used to give light in cottages instead of candles. Fishermen, in some places, make ropes of the inner bark, which is applied to a very different use, when most soft and succulent in spring, by the Kamtchatdales and Laplanders, being dried, ground, steeped in water to remove the resinous taste, and used for making a coarse kind of bread.—The DWARF P. (*P. Pumilio*, or *P. Muglus*) is found on the Alps and Pyrenees, its trunk often lying on the ground, although sometimes it appears as a bush or low tree. The recumbent trunks are called *Krummholz* (Crooked-wood) and *Knieholz* (Knee-wood) by the Germans.—The leaves are in pairs, very like those of the Scotch P., but a little longer; the cones are also similar. From the young shoots an oil resembling oil of turpentine is obtained

## PINE.

by distillation, which is a kind of universal medicine among the peasantry of Hungary, as is also the resin spontaneously exuding from the tree, which is known as *Hungarian Balsam*.—The BLACK P., or BLACK FIR (*P. nigricans*, or *P. Austriaca*), is another species closely allied to the Scotch P., but remarkable for its very long leaves. It is a native of Austria. It abounds in resin more than any other European tree.—To the same group of pines belongs the SEASIDE or TAURIAN P. (*P. Pallasiana*, *maritima*, or *Taurica*), which also affords resin in great quantity, and of a very pleasant odour. It is found in many parts of the south of Europe. Its timber is of little value; but great part of the turpentine of the *Landes* and other maritime districts of France is obtained from it. It yields also part of the *Burgundy Pitch* of the apothecaries' shops.—The ALEPPO P. (*P. Halepensis*), a native of the south of Europe, Syria, &c., is a very graceful tree of moderate size, with leaves in pairs and slender. It yields a liquid resin or turpentine, which is extracted from it in Provence and elsewhere, and sold as *Venice Turpentine*. The wood is extensively used in the Levant for shipbuilding.—The LARICIO (*P. Laricio*) has leaves in pairs, lax, and 4–8 inches long, cones 2–4 inches long, with the scales slightly pointed. It is often called the CORSICAN PINE. It grows on the shores of the Mediterranean Sea, and is valuable both for its timber and for its resinous products. In the island of Corsica, it frequently attains the height of 140 feet. It grows well in sandy soils, and has been made particularly useful for preventing the drifting of the sand, and turning to account the otherwise useless tracts between the mouths of the Garonne and the Adour in France, thus also preserving valuable lands which the sand threatened to overwhelm.—The PINASTER or CLUSTER PINE (*P. Pinaster*) is another of the most important European species. It has cones in whorls of 3, 4, or even 8 together, 4–6 inches long, leaves in pairs, and very long. It is found on the shores of the Mediterranean, and also in the Himalaya and in China. It has been used in France to a great extent, in the same way as the Laricio, for covering waste sandy tracts. The timber is of inferior quality, but great quantities of resin are procured from it. It yields *Bordeaux Turpentine*.—The PYRENEAN P. (*P. Pyrenaica*) is a majestic tree, a native of the Pyrenees, and producing very fine timber.—The CALABRIAN P. (*P. Bruttia*) somewhat resembles the Pinaster.—The STONE P. (*P. pinea*) a tree with a broad umbrella-shaped head, a form often seen also in the Scotch fir, forms a characteristic feature of the scenery of the Mediterranean, and is very often introduced in paintings. It is the *Pinie* of the Germans, the *Pignon* of the French. The leaves are in pairs, 4–5 inches long; the cones very large, ovate, and obtuse. The seeds, which do not ripen till the fourth year, are large, abound in a fixed oil, and when fresh, have a sweet taste resembling that of almonds. They are used in Italy and other countries in the same way as almonds and pistachio nuts for the dessert, in various dishes, also in emulsions, &c., under the names of *pinies*, *pinioles*, and *pignons*. The use of them, however, is almost entirely confined to the countries in which they are produced, as they very soon become rancid. They are sometimes imported into London in the cone, in which way they can be kept longer, but the cost of importation is much increased. The wood of this tree is very useful and beautiful. It yields resinous products only in small quantity.—The CEMBRA P., or SWISS STONE P., which grows in the central parts of Europe and the south of Siberia—a stately tree, with the lower branches more persistent than they

are in most pines, and rigid leaves in groups of three to five—also produces eatable seeds (*Cembra Nuts*), which, although they are extracted with difficulty,



Stone Pine (*P. Pinea*).

are much used. The cuticle contains a resinous juice; but in Siberia, this fruit is so much prized, that noble trees are often cut down to obtain it. The Cembra P. yields a pellucid, whitish oil, resembling oil of turpentine, and known as *Carpathian Balsam*.

North America produces many species of P., some of them very beautiful and very valuable. Besides those long known, and which are found in the states and colonies near the Atlantic, a number of the noblest species of this genus have, since the commencement of the present century, been discovered in California and the north-western parts of America.—The RED CANADIAN P. (*P. resinosa*) is found from Canada to the Pacific, but does not reach far south in the United States. It is the YELLOW P. of Canada and Nova Scotia. It delights in dry and sandy soils, and attains a height of 70–80 feet, with a diameter of two feet at the base, the trunk continuing of uniform diameter for two-thirds of its length. The leaves are in pairs, and are congregated towards the extremities of the branches. The timber is highly esteemed for strength and durability, and furnishes excellent planks for ship-building. It is also used for masts.—Somewhat resembling this in botanical characters, is the SCRUB P., or GRAY P. (*P. Banksiana*), generally only 3–10 feet high, which begins to appear in the northern parts of the United States upon high mountains, and is interesting as an arctic species, extending further north than any other.—The YELLOW P. (*P. variabilis*, or *P. mitis*) abounds in the Atlantic States from New Jersey to Virginia. It is a tree of 50–60 feet high, 15–18 inches in diameter at the base, with leaves 4–5 inches long, usually in pairs, but sometimes in threes upon the younger shoots. The timber is very extensively used for ship-building, and is largely exported to Great Britain. At Liverpool, it is known as NEW YORK PINE.—The JERSEY P., or SCRUB P. (*P. niops*), abounds in the lower parts of New Jersey, and thence to the south-west. The leaves are in pairs, 1–2 inches long, the cones armed with strong spines. The tree is rarely 30 or

## PINE.

40 feet high. Great quantities of tar are made from it in Kentucky.—The PITCH P. (*P. rigida*) is a native of the northern and middle parts of the United States, often growing in great miry swamps, and attaining a height of 70–80 feet, and a diameter of two feet at the base. The leaves are in threes, varying much in length, as the cones do in size. Immense quantities of it are used for fuel. Tar and lamp-black are sometimes made from it.—The LOBLOLLY or OLD FIELD P. (*P. Taeda*) grows in dry and sandy soils in the lower parts of the Southern States, often occupying lands exhausted by cultivation. Vast tracts never cultivated, in the Southern States, are *Pine Barrens*, in great part covered with this species of pine. It attains a height of 90 feet and upwards, and has a wide-spreading crown. The leaves are 6 inches long, in threes, sometimes in fours on young branches; the cones four inches high, with strong spines. The timber is not of much value.—The LONGLEAVED P., or SOUTHERN P. (*P. palustris*, or *P. Australis*), is perhaps the most important of North American forest trees. It furnishes the greater part of the tar, resin, pitch, and turpentine used in the United States. The timber is also very valuable, and is much used for ship-building. In England and the West Indies, it is known as GEORGIA PITCH PINE. The tree attains a height of 60–70 feet, and a diameter of about 16–18 inches; the leaves are in threes, and about a foot long; the cones 7–8 inches long, and 4 inches in diameter, with small spines. The seeds are sometimes eaten.—The WEYMOUTH P., or WHITE P. (*P. Strobus*), attains a height of 150 feet, and a diameter of 5 feet and upwards. It has lax sub-triangular leaves in groups of five; and pendulous cones 4–5 inches long, with thin smooth scales. It is frequently planted in Britain and on the continent of Europe for its beauty. In its native country, it abounds chiefly from lat. 47° to lat. 43°, and southward on the Alleghanies. The timber is not strong, but easily wrought and durable.—Of the species

attains a height of 150–200 feet, and a diameter of 7 feet and upwards, almost to 20 feet. The trunk is remarkably straight, and destitute of branches for two-thirds of its height; the leaves in fives, the cones upwards of a foot long. The timber is white, soft, and light; and the tree produces great quantities of a pure amber-coloured resin, which, when the wood is partly burned, is changed into a somewhat saccharine substance, used by the natives as a substitute for sugar. The seeds are eaten either roasted or pounded into coarse cakes.—*P. flexilis* is found on the Rocky Mountains, near the head-waters of the Arkansas, and occurs almost to the limit of perpetual snow. It has a dense crown, formed of numerous and remarkably flexile branches. The leaves are in fives. The seeds are used as food by hunters and Indians.—*P. ponderosa*, another native of the Rocky Mountains, is a magnificent tree, remarkable for the heaviness of its timber, which almost sinks in water. The leaves are in threes, and 9–14 inches long.—*P. Sabiana*, *P. Coulteri*, and *P. insignis*, are also noble species from the west of North America. The Himalaya Mountains abound in pines, some of which rival in magnificence those of North-west America. The BHOTAN P. (*P. excelsa*), much resembling the Weymouth P. in its botanical characters, and attaining a height of 90–120 feet, abounds in Bhotan, although it is not found in the neighbouring countries of Sikkim and Nepal. The wood is highly valuable, being durable, close-grained, and so resinous as to be used for flambeaux and candles.—The CHEER P. (*P. longifolia*) of India is a tree of remarkable and most graceful appearance; with leaves in threes, very long, very slender, and generally pendulous. It is abundant on the crests of hills in the lower Himalaya, growing at a lower elevation than the other pines. It is cultivated in some parts of India as an ornamental tree. It is much valued for its resin. The wood is used in India as a substitute for European deal.—The KHASIA P. (*P. Khasiana*) is peculiar to the Khasia Mountains, and has very much the general appearance of the Scotch pine.—*P. Gerardiana*, a species with leaves in threes, is a large tree, a native of Nepal. The seeds are eatable.—The mountains of India and the north-western parts of America produce numerous other species; Mexico has a number of very fine ones peculiar to itself; the mountains of St Domingo have one; the Canary Islands have one; China and Japan also have some. Most of those which have been named, and a number of others, are now readily to be procured in nurseries in Britain, although some of them only at prices which prevent any attempt at extensive plantation. Some wealthy noblemen and gentlemen devote a portion of their grounds to a collection of different kinds of P., called a *Pinetum*. A few foreign species have become pretty common in plantations. Most of the pines are quite hardy in Britain, but this is not the case with the Cheer P. and some of the Mexican species. The name P. is often popularly extended, and even in scientific works, to other *Coniferae*.

PINE-TIMBER.—This term is in general use for the timber of the pine-tribe (see CONIFERÆ), and is not confined to that of the genus *Pinus*, but embraces the wood of species of *Abies*, *Larix*, *Araucaria*, *Dammara*, &c. From the Baltic ports we receive red and white pine, or deal-timber. The former is yielded by the Scotch Fir (*Pinus sylvestris*), and the latter by the Spruce Fir (*Abies excelsa*). These two, with the Larch (*Larix Europæa*), yield the greatest part of the pine-timber of Europe; and of these, the imports into Britain from the north of Europe for the year 1862 were 89,000,000



Lambert's Pine (*P. Lambertiana*).

belonging to the north-western parts of America, one of the most magnificent is *P. Lambertiana*, which is found on the Rocky Mountains, between lat. 40° and lat. 43°, chiefly in sandy soils. It

## PINEAL BODY—PINE-APPLE.

cubic feet. Next in importance to these is the pine-timber of the British North American colonies, which is chiefly yielded by the Weymouth Pine (*Pinus Strobus*), although, doubtless, the wood of other coniferous trees is often substituted for it. The celebrated pitch-pine of Savannah, in the Southern States, is the produce of *Pinus rigida*. It is much used for ships' masts and yards, and for all purposes requiring great strength and durability, in both of which qualities it excels most others of its kind. The American war has, for the last three years, cut off the supply of this useful timber; but from her colonies in North America Great Britain imported, in 1862, upwards of 55,000,000 cubic feet of other kinds of pine timber. The kinds above mentioned are those which constitute the greater part of the pine-timber used in ship and house-building, carpentry, &c., in Great Britain. In France, the timber of the Corsican Pine (*Pinus Laricio*) and the Seaside Pine (*Pinus pinaster*) are greatly used. In Italy, the pine-timber is chiefly yielded by the Stone Pine (*P. pinea*) and the Calabrian Pine (*P. Bruttia*); that of Spain is from the Pyrenean Pine (*P. Pyrenaica*). In Germany, and especially in Austria, the Black Pine (*P. Austriaca*) furnishes the greater portion; but the fine-grained, soft white pine, or deal, so much used for sounding-boards of musical instruments, is the wood of the Silver Fir. See FIR. The trade in this timber is very great, for not only do the Germans use it almost exclusively in their vast toy-manufactories and for lucifer-matches, but considerable quantities are exported. The finest is cut in the forests of Bohemia, where large establishments are formed for dressing and preparing the wood for various purposes.

The timber of the Norfolk Island Pine (*Araucaria excelsa*) is sometimes imported for making ships' masts, as several other kinds of pine-timber are imported from time to time, but those mentioned form the great staples of the timber-trade. The chief value of this class of timber-woods is in the combination of lightness and strength with softness of texture and ease in working with ordinary tools; they constitute, in fact, the principal materials of our builders, and are more used than all other kinds of wood together. Much confusion prevails as to their common designations, for in this country alone, *fir*, *pine*, and *deal* are terms applied to all and each of them, according to the caprice of the individual. The two first names are used because the material is derived from one or other of those genera; but the last is a misnomer altogether, as the term deal belongs only to pieces of fir or pine timber cut to particular sizes: they are three inches in thickness, nine inches broad, and of variable length; if of less width, they are called *battens*.

**PINEAL BODY**, is a small reddish-gray body, of a conical form, and deriving its name from its resemblance to the fruit of the pine. It rests upon the corpora quadrigemina of the brain, in front of the cerebellum. It is about four lines in length, and from two to three in width at its base. It is larger in the child than in the adult, and in the female than in the male. It consists chiefly of gray matter, and in its base is a small cavity, which contains a transparent viscid fluid, in which are granules composed chiefly of phosphate and carbonate of lime, and termed *acervulus cerebri*. This organ was regarded by the ancients as the seat of the soul.

**PINE-APPLE**, or **ANANAS** (*Ananassa sativa*) a plant of the natural order *Bromeliaceae*, highly esteemed, and much cultivated for its fruit. The

fruit is a *sorosis*, formed by the calyces and bracts of a close spike of flowers, becoming succulent and combined. This is the distinctive character of the genus *Ananassa*. The P. has a number of long, serrated, sharp-pointed, rigid leaves, springing from the root, in the midst of which a short flower-stem is thrown up, bearing a single spike of flowers, and therefore a single fruit. From the summit of the fruit springs a crown or tuft of small leaves, capable of becoming a new plant, and very generally used by gardeners for planting; the P., in cultivation, being propagated entirely by crowns and suckers, as, in a state of high cultivation, perfect seed is almost never produced. The P. is a native of tropical America; it is found wild in sandy maritime districts in the north-east of South America, but it has been very much changed by cultivation. It has also been gradually diffused over tropical and subtropical countries, and not only as a cultivated plant, for it is fully naturalised in many parts both of Asia and Africa. It delights in a moist climate, and consequently does not succeed well in the dry climate of the south of Italy, although the warmth is sufficient. The first particular account of the P. was given by Oviedo in 1535. It was in Holland that it first began to be cultivated in hot-houses; but it was introduced into England in the end of the 17th c., and its cultivation rapidly became general in the gardens of the wealthy. It is only since the peace of 1815 that it has received similar attention in continental Europe. Great care is requisite in the cultivation of the P., which, without it, is generally fibrous and coarse, with little sweetness or flavour; and with it, one of the most delicate and richly flavoured of fruits. Its size also very much depends on cultivation. The size varies from 2½ lbs. to 12 lbs. in weight. The pine-apples grown in British hot-houses are generally much superior to those of the West India, because the latter grow almost or altogether without cultivation; but the importation of pine-apples from the West Indies having now been carried on to a considerable extent, and promising to add to the sources of wealth for these colonies, has led to greater care in cultivation there, and consequent improvement of quality.

In the cultivation of the P. in Britain, a tropical heat must always be maintained. It is generally cultivated in hot-houses specially appropriated to it, called *Pineries* or *Pine-stoves*; sometimes also in flued pits; and sometimes even without fire-heat, in frames continually supplied with fresh tanners' bark and dung. The universal practice, till of late, was to grow the plants in pots, plunged to the requisite depth in tanners' bark or other fermenting matter, and these were transferred from one house or one compartment to another, according to their stage of advancement; three years' culture being deemed requisite for the planting of a crown or sucker to the production of the ripe fruit; but the P. is now often planted in beds, and fruit of the best quality is sometimes obtained in fifteen months. The best soil is a rich and rather sandy loam. It is often formed from the turf of old pastures, with dung, peat, sand, &c., thoroughly mixed. Ventilation must be freely allowed from time to time, but care must be taken to keep the atmosphere moist. A P. which has borne fruit is thrown away as useless.

There are many varieties of the P. in cultivation. Of these, some are referred by some botanists to distinct species. But the greater number of varieties are universally referred to *A. sativa*, and differ in the more or less spiny serratures of the leaves, the globular, cylindrical, or pyramidal fruit, its size, &c.

## PINE-CHAFER—PINK.

A spirituous liquor (*Pine-apple Rum*) is made from the P. in some warm countries.

The use of the fibre of the P. is noticed in the article BROMELLACEÆ.

**PINE-CHAFER, or PINE-BEETLE** (*Hylurgus piniperda*), a small coleopterous insect of the family *Xylophagi*. See BARK-BEETLE. It is often very destructive to Scotch firs in rich soils and low situations, attacking the young terminal shoot in summer, and soon eating its way into the heart, which it proceeds to excavate so as to convert the shoot into a tube. Pines growing in open situations are little liable to the attacks of this insect; and trees of thirty feet in height, or upwards, are very rarely attacked. The insect is about the size of a seed of the Scotch fir, and of a black or dark-brown colour.

**PINE-FINCH, or PINE GROSBEAK** (*Corythus*), a genus of birds of the family *Fringillidæ*, nearly allied to Bullfinches and Crossbills, the bill nearly resembling that of the former, but the tongue very similar to the tongue of the crossbills, with the same peculiar bone articulated to the hyoid bone. See CROSSBILL. One species, the COMMON P. (*C. enucleator*), is a very rare visitant of Britain, but is abundant in many of the northern parts of Europe, Asia, and America. It is larger than a bullfinch, but much resembles the bullfinch in form, wings, tail, &c. The general colour of the male is red. This bird frequents pine-forests, and associates in flocks in winter. It is easily tamed. Its song is rich and full.—There are other species in the northern parts of the world.—The name P. is given in North America to a very different and much smaller bird (*Carduelis pinus*).

**PINEL, PHILIPPE**, a celebrated French physician, was born 20th April 1745, at Saint-André, in the department of Tarn, France; and after receiving a good classical education at the college of Lavaur, removed to Toulouse, where he studied medicine, and took his degree in 1773. He continued his medical studies at Montpellier, maintaining himself meantime by teaching mathematics; and in 1778 removed to Paris, where he acquired some reputation by a translation into French of Cullen's *Nosology* (1785), and the works of Baglivi (1788), and also by some Memoirs on subjects connected with zoology and comparative anatomy. Having applied himself with success to the study of mental alienation, he was charged, in 1791, to make a report on the insane inmates of the Bicêtre, became chief physician of this institution in 1793, and in 1795, was chosen to the same office at the Salpêtrière (a similar asylum, but for females). In the latter institution, P. commenced a class of clinical medicine, which he continued after his appointment to the chair of Medical Physics and Hygiene, and subsequently that of Pathology, at the School of Medicine in Paris. He was admitted as a member of the Institute in 1803, and died at Paris, 26th October 1826. His most valuable works were his *Traité Médico-philosophique de l'Aliénation Mentale* (1791), and *La Nosographie Philosophique* (1798), with its commentary, *La Médecine Clinique* (1802). P. gained for himself undying fame by his reformation of the old barbarous methods of treating the insane. The physicians brought up under the old system were not ashamed to offer a vigorous opposition to P.'s philanthropic opinions; but he fortunately succeeded in thoroughly establishing their correctness, and his system in a few years prevailed over the whole of Europe.

**PINEROLO, or PIGNEROL**, a town in the north of Italy, on the Clusone, at the entrance of the valley of Perosa, in the province of Turin, and 23

miles by railway south-west of the city of that name. It was formerly strongly fortified, and was the residence of the rulers of Piedmont. It contains a new cathedral, a bishop's palace, seminaries, barracks, &c. The ruins of the *citadel*, for some time the prison of the *Man with the Iron Mask* (q. v.), are still to be seen on the hill of St Brigida. Broad-cloth, paper, leather, iron, and silk, are manufactured. Pop. 14,260.

**PINE-WOOL.** Several attempts have been made of late years to utilise the leaves of pine and fir-trees, which are cut down in vast numbers for their timber only. The leaves contain a considerable quantity of fine vegetable fibre, which, when separated, has much the appearance of cotton. In Germany, several works have been established for preparing this fibre, and fitting it for various applications; and under the name of pine-wool, it is now sold for stuffing cushions, making wadding, &c. The principal manufacture is near Breslau in Silesia, where it is carried on by the inventor, Herr Pannewitz.

**PINEY TREE.** See CALOPHYLLUM.

**PINEY-VARNISH.** See DAMMAR.

**PINGUI'OLA.** See BUTTERWORT.

**PINHOEN, OIL OF.** See PHYSIC NUT.

**PINK** (*Dianthus*), a genus of plants of the natural order *Caryophyllaceæ*, of which there are many species, annuals and perennials, with beautiful and often fragrant flowers, chiefly natives of Europe and the temperate parts of Asia. The calyx is tubular, 5-toothed, with two or four scales at the base; there are five petals suddenly contracted at the throat of the corolla into a linear claw. There are ten stamens, and one germen with two styles. The capsule is cylindrical, and one-celled. The exquisite beauty of the flowers has attracted admiration in all ages; and some of the species have long been much cultivated in gardens, particularly the GARDEN P. and CARNATION (q. v.), which are often referred to one original, the CLOVE P. (*D. caryophyllus*), a native of the south of Europe, growing wild on rocks and old walls, and naturalised in some places in the south of England; whilst some botanists refer the garden pinks in part to the MAIDEN P. (*D. deltoides*), a pretty common British species, and those called Pheasant-eye pinks to the FEATHER P. (*D. plumarius*), a native of some parts of continental Europe, differing from the Clove P. chiefly in having the leaves rough on the margin, and the petals bearded and much cut. Nearly allied to them is *D. superbus*, found in moist places in some parts of Europe, and not unfrequently to be seen in flower-borders. It has very fragrant flowers. All the varieties of Garden P., whatever their origin, have been much changed by cultivation, and careful cultivation is requisite to preserve them in perfection. Both single and double pinks are generally propagated by *pipings*, which are short cuttings of the younger shoots. They are also sometimes propagated by layers. A rich loamy soil is the best for pinks. The Clove P., in a wild state, has flesh-coloured flowers. The leaves are linear-awl-shaped, grooved, and glaucous. The Maiden P. is a small much branched plant, growing in grassy places, on gravelly and sandy soils; it has rose-coloured flowers spotted with white, and a white eye encircled by a deep purple ring.—The Deptford P. (*D. Armeria*) and the CLUSTERED P., or CHILDING P. (*D. prolifer*), also natives of England, differ from these in being annuals, and in having clustered flowers.—The BEARDED P., or SWEET WILLIAM (*D. barbatus*), a native of the middle of Europe and the south of France, with lanceolate leaves, flowers

crowded in dense clusters at the top of the stem, acuminate bracts, and bearded petals, has long been a favourite garden-flower, still retaining its place alike in palace and cottage gardens. Although perennial, it is sown annually by florists, to secure fine flowers, and there are many varieties, single and double, exhibiting much diversity of colour.—The INDIAN P. or CHINA P. (*D. Chinensis*) is now also common in flower-gardens.

The Clove P. was formerly regarded as possessing medicinal properties, and was used in nervous maladies.—*Sea P.* is a common name of Thrift (q. v.).

**PINK COLOURS**, very light shades of rose-red colour: they are usually produced by extreme dilution of cochineal or carmine, Brazil and Braziletto wood colours, with whiting. Some mineral pinks for oil colours are obtained from preparations of manganese, &c. See RED COLOURS. The term pink is also applied to several Yellow Colours (q. v.).

**PINKERTON, JOHN**, an industrious and learned *littérateur*, was born at Edinburgh, 17th February 1758, and educated at the grammar-school of Lanark, where he was noted for the unusual excellence of his classical attainments, and for his hypochondriacal tendency. He was afterwards apprenticed to a Writer to the Signet, his father refusing to let him proceed to the university; and while engaged in the irksome and distasteful practice of law, he published an *Ode to Craigmillar Castle* in 1776, which he dedicated to Dr Beattie. In 1780, he went to London, where he settled as a man of letters. Next year, he gave to the public a volume of *Rimes* (as he called his pieces), and a collection of *Scottish Tragic Ballads*, followed in 1783 by a second collection of *Ballads of the Comic Kind*—both of which subsequently appeared under the title of *Select Scottish Ballads*. They professed to be ancient, but many of them were really compositions—*forgeries*, some might say, of P.'s own, and would hardly deceive a critical archæologist. In 1785, he published an *Essay on Medals*, which went through several editions, and long held a high place among books on numismatics; and in 1785, *Letters on Literature*, marked chiefly by a novel system of orthography (e. g., the use of *a* instead of *s* in forming plurals), intended to soften the harshness of the English language, and which was abused as heartily as it deserved. These *Letters* were, however, the means of introducing him to Walpole, through whom he became acquainted with Gibbon and other literary celebrities. P.'s next publication was a most valuable one, *Ancient Scottish Poems never before in Print, from the MS. Collections of Sir Richard Maitland of Lethington, Knight* (2 vols. Lond. 1786). It was followed in 1787 by his once notable *Dissertation on the Origin and Progress of the Scythians or Goths*, in which, for the first time, appears that grotesquely virulent hatred of the Britanno-Celtic race—Scotch Highlanders, Welsh, and Irish—that reaches its climax in his *Inquiry into the History of Scotland preceding the Reign of Malcolm III.* (2 vols. Lond. 1790), where he affirms again and again, obviously with the extremest gusto, that the Highlanders are 'mere savages, but one degree above brutes; that they are just as they were 'in the days of Julius Cæsar; that 'like Indians and Negroes,' they 'will ever continue absolute savages,' and that 'all we can do is to plant colonies among them, and by this, and encouraging their emigration, try to get rid of them.' But in spite of this extravagant truculence of speech, the *Inquiry* contains a great deal of important matter—rare and curious historical documents, some of which are to be found nowhere else in print. P. left

England in 1802, and fixed his residence at Paris, where he died 10th March 1826, after a life of hard literary work. His principal publications, besides those already mentioned, are, *The Medallic History of England to the Revolution* (1790); *Scottish Poems* (3 vols. 1792), reprinted from scarce editions; *Iconographia Scotica, or Portraits of Illustrious Persons of Scotland, with Biographical Notes* (2 vols. 1795—1797); *The History of Scotland from the Accession of the House of Stuart to that of Mary* (2 vols. 1797), valuable for its laborious investigation of original materials, but disfigured, in a literary point of view, by an imitation of the grandiose style of Gibbon; *Walpoliana*, a collection of his notes of his friend Horace Walpole's conversation, in 2 vols.; *The Scottish Gallery, or Portraits of Eminent Persons of Scotland, with their Characters* (1799); *Modern Geography* (3 vols. 1802—1807); *General Collection of Voyages and Travels* (16 vols. 1808—1813); *New Modern Atlas* (1809—1815); and *Petra'ogy, or a Treatise on Rocks* (2 vols. 1811).

**PINK ROOT.** See SPIGELIA.

**PINNA**, a genus of lamellibranchiate molluscs of the same family with the *Pearl Mussel* (*Avicula*), and having a shell of two equal wedge-shaped valves, closely united by a ligament along one of their sides. The mantle is closed on the side of the ligament; the foot is small and conical. The byssus is remarkably long and silky; and by it the species affix themselves to submarine rocks and other bodies, sometimes even to sandy or muddy bottoms. The best known species is *P. nobilis*, a native of the Mediterranean, the byssus of which was used by the ancients for fabrics, but chiefly as an article of curiosity, to which a great value was attached. It is still so used in Sicily and elsewhere. It is very strong and lustrous. The only reason against its more general use is the difficulty of procuring it in sufficient quantity. The byssus of this species is sometimes two feet long, the shell is about the same length. Pinnæ are often found in large beds, with only the edges of their shells appearing above the mud or sand. The animal is eaten.

**PINNACE** (from the Ital. *pinaccia*, a diminutive of *pino*, a ship) was originally a small vessel, usually schooner-rigged, employed as tender to a large ship, for the purpose of communicating with the shore, &c. At present, however, the signification is limited to a large boat carried by great ships. It is smaller than the launch, but larger than the cutters; and is generally rowed 'double-banked,' by from ten to sixteen oars.

**PINNACLE**, an ornamental termination much used in Gothic architecture. It is of simple form in the earlier periods of the style, having a plain square or octagonal shaft and sloping roof or top, terminating with a finial; but in later examples the pinnacle is greatly developed, and becomes one of the most varied and beautiful features of the style. It is ornamented with shafts bearing canopies, and niches filled with statues. Pinnacles are most frequently used on buttresses and parapets, and when placed over the former, serve as a deadweight to increase their power of resisting a thrust.

**PINNULE**, in Botany, a leaflet of a pinnate leaf, or of one which is bipinnate, tripinnate, &c. See LEAVES. The term is more frequently used, however, to designate the ultimate divisions of the fronds of ferns, when divided in the same manner.

**PINSK**, a town of West Russia, in the government of Minsk, surrounded by vast marshes called the Pinsk Marshes, stands on the banks of the Pina, a branch of the Pripet, 752 miles south-south-

west of St Petersburg, lat. 52° 7' N., long. 26° 6' E. It was founded in the 12th c., was conquered by the Prince of Lithuania in 1320, was annexed, together with Lithuania, to Poland in 1569, and came at last into the possession of Russia in 1795. The trade of P., chiefly transit, has increased, especially since the opening of the Oghlinsky Canal, which connects the Dnieper and the Black Sea with the Niemen and the Baltic Sea. A very considerable number of ships and barges enter and clear the port. They are laden principally with salt, corn, hemp-seed, iron, glass, tar, tallow, wool, tobacco, and timber. These goods are forwarded to the west and north-west, being conveyed by land to Austria, and by water to Kovno, Königsberg, Danzig, and Warsaw. The manufacturing activity of the town is not great. Pop. 11,325; 5000 of whom are Jews.

**PINT**, a measure of capacity used both for liquids and dry goods, and equivalent to the eighth part of a Gallon (q. v.), or 34·65925 cubic inches. The Scotch pint, still in use, though superseded as a legal measure by the imperial pint, is equivalent to 3·00651 imperial pints.

**PINTA'DO**. See GUINEA FOWL.

**PINTAIL**, or **PINTAIL DUCK** (*Dafla*), a genus of ducks, of the section with the hind-toe destitute of membrane. The bill is without tubercle at the base, narrow, with laminae not projecting beyond the margin. The tail of the male is long, and tapers to a point.—The COMMON P. (*D. acuta*) is a handsome bird, rather longer in shape than most

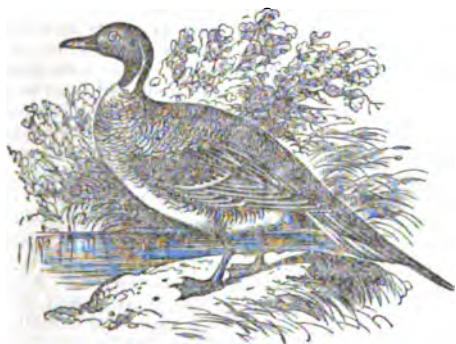

Pintail Duck (*Dafla acuta*).

of the ducks; the neck also longer and more slender. It is about equal in size to the mallard. The head is brown, with a white longitudinal line on each side extending down the neck; the back and sides marked with wavy lines of black and grayish-white; the lower parts white; the elongated central tail-feathers black. It is a native of all the northern parts of the world, migrating southwards in winter, and a regular visitant of many parts of the British coasts. It also frequents fresh-water lakes and ponds, and is common in winter in the valley of the Mississippi. Its winter range extends southwards to the Mediterranean and the Gulf of Mexico, and even to Africa and the West Indian Islands. Its flight is very rapid and noiseless. It is very much esteemed for the table. It has been tamed, and has bred in confinement.

**PIOMBINO**, a principality now incorporated in the kingdom of Italy, lies along the Italian coast opposite the island of Elba, the greater part of which belonged to it. Its extent was about 132 English square miles; and its population, previous

to its incorporation with the rest of Italy, about 25,000. P. was originally a fief of the empire, and, at the end of the 14th c., came into the possession of the family of Appiani, which, after ruling it for nearly 300 years, made way for a new dynasty, the family of Buoncompagni. This latter dynasty was mostly under the suzerainty of the neighbouring states of Sardinia and Naples alternately. In 1801, the Buoncompagni family were expelled by Napoleon, and the principality given to his sister Elisa, the wife of Felice, Prince Baciocchi; but the latter was ejected, and the old dynasty restored, by the Congress of Vienna; the principality being then put under the suzerainty of Tuscany, whose grand-duke indemnified the Buoncompagni for their loss of sovereignty. It is now a part of the province of Grosseto, in the kingdom of Italy. The strait between P. and Elba is called the 'Channel of Piombino.'

**PIONEER**, a military labourer employed to form roads, dig trenches, and make bridges as an army advances; and to preserve cleanliness in the camp when it halts. Formerly, the pioneers were ordinary labourers of the country in which the army was, impressed for military purposes; but now such persons are only brought in as auxiliaries, a few men being attached to every corps as a permanent body of pioneers. In the British army, one man is selected, for his intelligence, from every company. These pioneers march at the head of the regiment, and the senior among them commands as corporal. Instead of a musket, each man carries a saw-backed sword, which is at once tool and weapon. Each bears also an axe and two gun-spikes, other necessary tools being distributed among them. There is something rather conflicting between the functions of the pioneers and those of the engineer force.

**PIOTRKO'W**, a town of Poland, in the government of Warsaw, and 91 miles south-west of the city of that name, close to the Warsaw and Vienna Railway. It is known to have existed in the 15th c.; but it is now a decaying town, carrying on no prominent and special branches of trade or manufacture. Pop. 11,203.

**PIOZZI**, MRS (*née* HESTER LYNCH SALUSBURY), who cannot be forgotten while the great Dr Samuel Johnson continues to be remembered, is the daughter of John Salusbury, Esq., of Bodvel, in Caernarvonshire, where she was born in the year 1739. Early introduced into the fashionable world of London, she charmed by her beauty and her lively manners; and, in 1763, was married to Mr Henry Thrale, a rich brewer, with a recognised position in society, and, at the time, one of the members for the borough of Southwark. Her acquaintance with Dr Johnson, which speedily became an intimacy of the closest and most affectionate kind, began shortly after. Of all Johnson's many friendships, this was perhaps, in certain essential respects, the most valuable to him. To Johnson, widowed and alone, and subject, as he had been throughout, to accessions of a frightful gloomy hypochondria, which made life at times to him an almost intolerable burden, the society of Mrs Thrale, and of the circle which she gathered round her, was a source of incalculable solace. Mrs Thrale in particular, with her warm heart, and bright womanly intelligence, was always a comforting presence; and her unflinching cheerfulness and vivacity enlivened for him many an otherwise cloudy hour. Her married life, though prosperous, was not an eminently happy one, Mr Henry Thrale, though always a pleasant and kindly gentleman, being no miracle of conjugal virtue. If Johnson owed her much, it may be



surmised that the benefit was in some sort reciprocal, and that, by her affectionate reverence and solicitude for her sage, she a little consoled herself for the gentlemanly indifference of her husband. On the death, in 1781, of her husband, Mrs Thrale retired with her four daughters to Bath, where, in 1784, she married Mr Gabriel Piozzi, an Italian teacher of music. This *mésalliance*—as it was held—was deeply censured by all her friends, and so unreasonably excited the ire of Dr Johnson in particular, that a rupture of friendly relations was the result. In the correspondence between them on the subject, it must be admitted the lady has much the better of the philosopher, whose tone of unmannerly rudeness gives some countenance to the good-natured suspicion of his friends, that he had an eye to the widow himself. Though the feud was ostensibly healed, the friends never again met; Mrs P. leaving England for Italy with her husband, and Dr Johnson dying soon after. Some little time subsequent to his death, she published an octavo volume, entitled *Anecdotes of Dr Samuel Johnson during the last Twenty Years of his Life*, in which it seemed to the indignant Boswell and others, that her main intention was to take her little feminine revenge on the deceased for his outrage in the matter of Piozzi. This work she supplemented in 1788 by a collection of *Letters to and from Dr Samuel Johnson*, in 2 vols. 8vo. Of works more properly her own, may be mentioned, *Observations and Reflections made in the course of a Journey through France, Italy, and Germany* (2 vols. 8vo, 1789); *British Synonymy, or an Attempt at regulating the Choice of Words in Familiar Conversation* (2 vols. 8vo, 1794); and *Retrospection, or a Review of the most striking and important Events, Characters, Situations, and their Consequences, which the last Eighteen Hundred Years have presented to the View of Mankind* (2 vols. 4to, 1801)—books long since utterly forgotten, if ever they were at all read and remembered. Having survived her second husband, her own celebrity, and almost in some sort that of the great Dr Johnson, with whom her name remains indissolubly connected, Mrs P. died at Clifton, near Bristol, on the 2d May 1821.

PIPA, a genus of batrachians, in general form resembling frogs and toads, and characterised by the very broad and triangular head, the sides of which are destitute of the glands (*parotoids*) so large in the true toads; the eyes small, and situated near the margin of the lower jaw; the ear concealed beneath the skin; the tongue merely rudimentary; the jaws destitute of teeth; the fore-feet not webbed, but divided into four fingers, each of which divides at the extremity into four small points, these, again, being minutely divided in a similar manner; the hind-feet five-toed and completely webbed; the larynx of the male extremely large—a triangular bony box, within which are two small movable bones for occasionally closing the entrance of the bronchi; the back of the female furnished with numerous cells or pouches, in which the eggs are hatched, and the young undergo all their transformations till they have attained a form similar to that of their parents. These characters are so remarkable as to make the creatures of this genus objects of peculiar interest, but particularly the mode of rearing the young. It was at first supposed that the young were produced in some unusual way in the cells from which they were seen finally to emerge; but this is not the case. The eggs are deposited by the female in the ordinary manner, and are carefully placed by the male in the cells of her back, which close over them. When the young are ready to use their limbs, they struggle out of the cells, to which they never afterwards

return. The best-known species of P. is that commonly called the Surinam Toad (*P. Surinamensis*), a native of Guiana and other warm parts of continental America, where it inhabits swamps and ditches, and is occasionally found in damp and dirty corners of houses. It is sometimes seven inches long; its colour is brownish-olive above, whitish below; the skin covered with small hard granules, mingled with occasional horny tubercles. The whole aspect of the creature is peculiarly hideous.

PIP. See POULTRY.

PIPE, a measure of quantity commonly employed in Portugal, Spain, France, and in some other countries which trade with these. It is used almost exclusively for wine and oil, and has a particular value for almost each locality. The pipe is called in England a butt, and is equal to two hogsheds, or half a tun. The pipe of Oporto is larger than those of Lisbon and of Spain in the proportion of 93 to 76. There are three different measures of this name in France; and there was formerly a pipe, a measure of capacity for dry goods, in use by the Bretons. But the pipe in England varies with the description of wine it contains: a pipe of port contains 114 imperial gallons; of sherry, 108 imperial gallons; and of madeira, 92 imperial gallons; while the common English pipe contains 126 wine gallons, or 105 imperial gallons nearly.

PIPECLAY is a fine Clay (q. v.), free from iron and other impurities, having a grayish-white colour, a greasy feel, and an earthy fracture. It adheres strongly to the tongue, and is very plastic, tenacious, and infusible. It is used for the manufacture of tobacco-pipes and white pottery. The localities where it is chiefly obtained are Devonshire, and the Trough of Poole in Dorsetshire. It is also found in various places in France, Belgium, and Germany.

PIPE-FISH (*Syngnathus*), a genus of osseous fishes of the order *Lophobranchii* (q. v.), and of the family *Syngnathidae*. In this family the form is elongated, there is little flesh, and the body is almost covered with partially ossified plates; the head is long; the jaws are elongated so as to form a tubular snout—whence the names P. and *Syngnathus* (Gr. *syn*, together; and *gnathos*, a jaw); and the males have pouches, variously situated, in which they receive the eggs of their mate, and carry them till they are hatched. The family *Syngnathidae* is sometimes restricted to those in which the egg-pouch



Pipe-Fish (*Syngnathus acus*).

of the males is on the tail, and is open throughout its whole length, and the tail is not prehensile. Thus restricted, it contains a number of genera, of which one only, *Syngnathus*, is British.—One of the most common British species is the GREAT P. (*Syngnathus acus*), which is sometimes found in deep water, and sometimes at low tide among the sea-weed in rock-pools. The specimens commonly seen are from 1 foot to 16 inches in length; but this fish is said to attain

## PIPERACEÆ—PIPES.

a length of 2 or 3 feet. Its food, and that of the other species, is believed to consist of small marine animals and the eggs of fishes; and it may be seen slowly moving about, with curious contortions, poking its long snout into every crevice in search of food, and sometimes assuming a vertical position with the head downwards, poking into or stirring the sand. This and the other pipe-fishes shew great affection for their young, which are believed to return, on the appearance of danger, to the pouch of their male parent, after they have begun to leave it, and to swim about in the sea.

The name *P.* is sometimes also given to the fishes forming the family *Fistulariæ* (q. v.), or Flute-mouths, sometimes called *Pipe-mouths*.

**PIPERACEÆ**, a natural order of exogenous plants, natives almost exclusively of the hottest parts of the globe, particularly of Asia and America. None of them found in cold regions. About 600 species are known, to most of which the name **PEPPER** is sometimes given, although some are also known by other names, particularly those of which the fruit is not used as a spice, but of which some part is employed for some other purpose, as Betel, Cubebs, Matico, and Ava. See these heads. But Pepper (q. v.) is the most important product of the order. Of the *P.*, a few are almost trees; but they are generally shrubs or herbaceous plants, often climbing. They have jointed stems; opposite whorled or alternate leaves, with or without stipules, and insignificant greenish flowers in slender spikes, unisexual or hermaphrodite, the different kinds generally mingled in the same spike; the flowers without calyx or corolla, but each with a bract, the stamens 2—6, the ovary with one cell and one ovule, and crowned with one or three stigmas; the fruit somewhat succulent, containing one seed.

**PIPERINE** ( $C_{34}H_{49}NO_3$ ) is an alkaloid possessing very weak basic properties, which is found in the Pepper tribe. It may be obtained by heating powdered pepper with alcohol, which extracts the piperine and some resinous matter, which may be removed by digestion in a solution of potash. It occurs in colourless well-formed prisms, which are insoluble in cold water, but dissolve readily in alcohol and ether. According to Miller, piperine 'has an acrid taste, resembling that of pepper;' while Gorup-Besanez asserts that 'it is devoid of odour or taste, and that, consequently, the well-known properties of pepper are not dependent on it.' On heating piperine with soda-lime, a remarkable oily base, *Piperidine* ( $C_{10}H_{17}N$ ), is obtained, with a pungent odour, resembling both that of ammonia and pepper.

**PIPES, or TUBES**, are made of various materials and for various purposes. Thus, we have draining-pipes for agricultural and sanitary purposes, made of earthenware, wood, and metal; pipes of various kinds of metals for a great variety of purposes, and Tobacco-pipes (q. v.) of various materials. Formerly, wooden pipes were extensively used for conveying water and for draining; but so great an improvement has been effected of late years in the manufacture of metal and earthenware pipes, that they have now become exceedingly rare, and will soon disappear. For agricultural purposes, *drain-tiles* are made of ordinary brick-clay; and owing to the use of machinery in their manufacture, they are produced very rapidly and cheaply. They are of various sizes, but the most general is 15 inches in length by 2½ inches diameter. The operation of the drain-tile machine is to squeeze a continuous length of soft plastic clay through a ring-shape orifice, the centre of which is occupied by a core or mandrel of the size of the hollow part of the

pipe. Another arrangement of the machine is to cut the pipe to the proper lengths as it passes through, and by means of a travelling-table, to carry them forward to be removed to the sheds, where they are dried, previous to being burned in the kilns.

Within the last twenty years, earthenware pipes have been made of almost every size, from an inch or two in diameter up to the enormous size of fifty or six inches. They are usually made of fire-clay, and are glazed like common pottery. See **POTTERY**. They are wider at one end, so as to form a socket, as in fig. 1, to receive the end of another, and thus form a continuous tube. These are greatly used for the drainage of houses, and for sewerage, for which

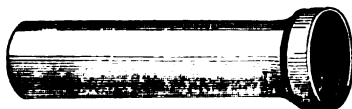

Fig. 1.

they are admirably adapted: the inner surface being glazed as well as the outer, offers no resistance to sedimentary matters, which are consequently carried away readily. These pipes are of such great strength, that many small towns in England are now seweraged with them almost entirely. Another kind has been introduced for chimney flues. They are also made of fire-clay, but unglazed externally, and so thick, that there is little fear of breaking. They are placed one on another, and are built into the walls of houses, instead of the ordinary chimneys, and in this way save much labour in building, and afford a much more effective, and easily cleaned flue (fig. 2).



Fig. 2.

*Caoutchouc vulcanised* and *gutta percha* are also extensively used for making pipes for a variety of purposes, their flexibility rendering them very useful. *Leathern pipes* are used chiefly for the conveyance of water temporarily, as in the case of fire-engines: they are generally called *hose*. Metal pipes are made of iron, lead, tin, or an alloy of tin and lead, copper, brass, &c. Iron pipes are usually cast, and the manufacture of such pipes has become of enormous extent, in consequence of the vast works, by which almost all large towns in this kingdom and in many foreign states are now supplied with water and gas, the pipes for which are largely exported from Great Britain. A great proportion of the trade in cast-iron pipes is carried on in Scotland. The water-works which supply the great towns of Lancashire have nearly all been furnished with pipes from Scotland; and the magnitude of the supply can be best understood when it is known that for the Rivington Pike Works, which supply Liverpool, upwards of twenty miles of iron pipes, nearly four feet in diameter, are required. It would be impossible to make a correct estimate, but it has been stated, with great reason for belief, that in Great Britain the gas and water-pipes laid in use exceed half a million of miles in length.

Pipes made from the ductile metals, such as brass, copper, and tin, are made by first casting an ingot of the metal into the shape shewn in fig. 3, with a hole through its length of the same diameter the bore of the pipe is intended to have. Into this is placed an iron rod, called the mandrel (a, fig. 4), which exactly fits, and which projects slightly at the tapered end (b, fig. 4). It is then

## PIPE-STICKS—PIPPIN.

brought to the drawing-table, and here the small end with its projecting mandrel is put into a funnel-shaped hole, drilled through a steel post (a, fig. 5),

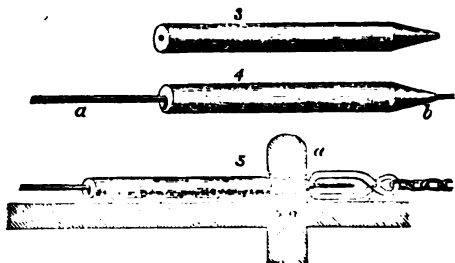

so as to allow the point to be gripped on the other side by a pair of pincers, at the end of a strong chain; the machine-power is then applied to the other end of the chain, and the soft metal and its mandrel are drawn through, the former being extended equally over the surface of the latter, which is then removed, and the length of pipe is complete. Some metals require repeated drawing through holes, getting gradually smaller, and have to be softened or annealed at intervals, as the metal hardens under repeated drawing. In this way, brass, copper, tin, and pewter pipes are made; and a patent has just been taken out for making steel ones; but lead pipes are made of great lengths by squeezing the soft metal through a hole in a steel plate in which there is a fixed core or mandrel projecting, which forms and regulates the size of the bore of the pipe. Pipes are also made from copper, brass, and malleable iron by rolling out narrow strips of metal, and then passing them successively through rollers, which are deeply grooved, and which turn up the edges (fig. 6). A mandrel is then laid in it, as in fig. 7, and it is next passed through double-grooved rollers, which turn the edges in, and thus form a complete tube round the

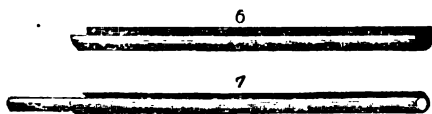

mandrel. The edges, however, require soldering or welding, if of iron. All boiler tubes used to be made in this way; but the method of drawing has lately been so much improved, that copper and brass pipes, or tubes, as they are frequently called, are now drawn of considerable thickness and diameter.

**PIPE-STICKS.** It is usual to call the wooden tubes used for some tobacco-pipes by this name; and unimportant as it may at first sight appear what the tube is made of, there is great difference of taste in this respect; and great care is taken by some smokers to get what they consider the choicest material. Perhaps the most prized are the Agriot or Cherry pipe-sticks of Austria. These are the young stems of the Mahaleb Cherry (*Prunus Mahaleb*), which is extensively grown for the purpose in the environs of Vienna. An astonishing amount of care is bestowed on the cultivation of these shrubs, which are all raised from seed. When the seedlings are two years old, they are each planted in a small pot, and as they continue to grow, every attempt at branching is stopped by removing the bud. As they increase in size from year to year, they are shifted to larger pots or boxes, and great care is taken to turn them round almost daily, so that every part is

equally exposed to the sun. When they have attained a sufficient height, they are allowed to form a small bushy head, and continue to receive the same attention in daily turning, &c., until they are thick enough in the stem. They are then taken up, and the roots and branches removed, and the stem put by to season. Afterwards, they are bored through, and are ready for use. These pipe-sticks have an agreeable odour, and are covered with a reddish-brown bark, which is retained. Sometimes they are five feet in length, and as smooth and straight as if turned. When of such a length, they command high prices. In Hungary, pipe-sticks made from the stems of the Mock Orange (*Philadelphus coronarius*) are much used; and the jessamine sticks of Turkey are in great esteem in all countries. Orange and lemon-trees and ebony are also used. The chief recommendation of these materials seems to be in the power of the wood to absorb the oil produced in smoking tobacco, and consequently to render the smoke less acrid. See TOBACCO-PIPES.

**PIPI**, the name given to the ripe pods of *Casalpinia Pupai* (see *CÆSALPINIA*), which are used in tanning, and are not unfrequently imported along with *Dividivi* (q. v.), and sometimes separately, but not to any considerable extent, being very inferior to *dividivi*. They are easily distinguished from the pods of *dividivi*, not being curved as they are, but straight.

**PIPING CROW.** See **BARITAE**.

**PIPIT, TITLING, or TITLARK** (*Anthus*), a genus of birds included by Linnæus among Larks (*Alauda*); but now regarded as forming even a distinct family, *Anthidae*, which is ranked among the *Dentirostres*, whilst the lark family (*Alaudidae*) is ranked among the *Conirostres*. The bill is more slender than in larks; the tips of the mandibles slightly bent downwards and notched. The hind-claw is long, although not so long as in larks, and more or less curved. The plumage resembles that of larks; in habits and motion of the tail, there is a greater resemblance to wagtails. The bill is not strong enough for feeding on grain or hard seeds, and insects and worms are the principal food of pipits. The most common British species is the MEADOW P., COMMON TITLARK, or TITLING (*A. pratensis*), familiarly known in many parts of England and of Scotland as the *Moss-cherper*. It is found in almost all parts of Europe, and the north of Asia, in Western India, in Japan, and in Iceland. It is a small bird, its colour brown of various shades. It frequents heaths, mosses, and pastures; and usually makes its nest on a grassy bank, or beside a tuft of grass or heath. Its song is weak and plaintive, and it generally sings in the air. It is gregarious in winter. The cuckoo is said to deposit its egg more frequently in the nest of the Meadow P. than in that of any other British bird.—A rather larger British species is the TREE P., or FIELD TITLING, which has a shorter claw, and perches on trees, frequenting enclosed and wooded districts. It is a summer visitant of Britain, and most common in the south of England. It occurs in most parts of Europe, in Asia, and the north of Africa.—The ROCK P., or SEA TITLING (*A. petrosus*), is to be found on the shores of all parts of Britain and Ireland. It is rather larger than the Tree P., and has a long curved hind-claw. It feeds chiefly on small marine animals, seeking its food close to the edge of the retiring tide.

**PIPPIN** (so called probably because raised from the *pip*, or seed), a name given to many varieties of apple, among which are some of the finest in cultivation, as the *Golden P.*, *Ribston P.*, &c. The

## PIQUÉ WORK—PIRAYA.

Ribston P. was long supposed to be an originally English variety, produced at Ribston Hall in Yorkshire, but it is proved to have been introduced from Normandy in the beginning of the 18th century.

**PIQUÉ WORK**, a very fine kind of inlaying with gold, silver, and other costly materials; it is, in fact, a kind of Buhl-work (q. v.), carried out on a very minute scale. It is only applied to articles of small size, such as snuff-boxes, card-cases, and similar articles.

**PIQUET** is a small body of men posted at some point beyond the general line of the army or corps, for the purpose of observing the motions of an enemy, or giving timely notice in case of any attack. Piquets are either *outlying* or *inlying*.

**PIQUET**, a game of cards played between two persons with thirty-two cards—viz., the four honours, and the highest four plain cards of each suit. The cards are shuffled and cut as in whist, and then dealt, two by two, till each player has twelve; and the remaining eight, called the *talon*, or *stock*, are then laid on the table. The first player must then discard from one to five of his cards, replacing them with a similar number from the talon; and after him, the younger hand may discard if he pleases, similarly making up his proper number from the remaining cards of the talon. The player who first scores 100 wins the game, and the score is made up by reckoning in the following order—*carte-blanche*, the point, the sequence, the quatorze, the cards, and the capot. *Carte-blanche* is a hand of twelve plain cards, and counts ten for the player who possesses it. The *point* is the greatest number of cards in any suit, or, if the players are equal in this respect, that which is highest in value (the ace counting eleven, each court-card ten, and the plain cards according to the number of pips), and counts a number equal to the number of cards in the suit. The *sequence* is a regular succession of three or more cards in one suit, and the highest sequence (i. e., the one containing the greatest number of cards, or if the players have sequences equal in this respect, the one of the two which begins with the highest card), if of three cards, counts three; of four cards, four; of five cards, fifteen; of six cards, sixteen, &c. The *quatorze* is a set of four equal cards (not lower than tens), as four aces, four queens, &c., and the highest quatorze counts fourteen for its holder; but should neither player have a quatorze, then the highest set of three is counted instead, but it reckons only three. The possessor of the highest sequence or the highest quatorze also counts all inferior sequences and quatorzes (including sets of three); while his opponent's sequences and quatorzes go for nothing. The first player reckons his points, and plays a card; the dealer then reckons his points, and follows his opponent's lead, and cards are laid and tricks are taken as in any ordinary card-game. Each player counts one for every card he leads, and the taker of the trick (if second player) counts one for it; the possessor of the greater number of tricks counting ten in addition (the 'cards'), or if he takes all the tricks, he counts forty in addition (the 'capot'). If one player counts thirty—i. e., 29 by his various points, and one for the card he leads, before his adversary has counted anything, he at once doubles his score, reckoning sixty instead of thirty (this is called the 'pique'); and should his score reach thirty before he plays a card, or his adversary begins to count, he mounts at once to ninety (the 're-pique').

**PIRACY** is robbery on the high sea, and is an offence against the law of nations. It is a crime not against any particular state, but against all

mankind, and may be punished in the competent tribunal of any country where the offender may be found, or into which he may be carried, although committed on board a foreign vessel on the high seas. It is of the essence of piracy that the pirate has no commission from a sovereign state, or from the belligerent state at war with another. Pirates being the common enemies of all mankind, and all nations having an equal interest in their apprehension and punishment, they may be lawfully captured on the high seas by the armed vessels of any particular state, and brought within its territorial jurisdiction for trial in its tribunals. The African slave-trade was not considered piracy by the law of nations; but the municipal laws of the United Kingdom and of the United States by statute declared it to be so; and since the treaty of 1841 with Great Britain, it is also declared to be so by Austria, Prussia, and Russia.

**PIRÆUS** (Gr. *Peiræus*), the principal harbour both of ancient and modern Athens (q. v.). Only a few traces remain of the long walls which formerly united it and Munychia with the capital city. The modern P., which has sprung up since 1835, is a regularly laid-out town, with some good houses and shops, and is connected with Athens by a carriage-road that follows the line of the more northern of the ancient walls. The population of the town in 1862 was 6264. The harbour, called also Porto Leone or Drakoni, is both safe and deep; but the entrance is narrow. In 1858, the number of vessels entering the P. was 7137, whose tonnage amounted to 347,459.

**PIRANO**, a seaport of Austria, in the markgratdom of Istria, stands on a peninsula in the bay of Largone, 15 miles south-west of Trieste. It contains an old castle, has a port and several dock-yards, commodious roads, in which large vessels find safe anchorage, and is the seat of considerable trade and commerce. Among its more important edifices are an interesting Gothic church, a town-house, and a Minorite convent, with a number of good pictures. Wine and oil are made in considerable quantities, and there are salt-works in the neighbourhood, which produce upwards of 330,000 cwts. of salt annually. Pop. 9200.

**PIRAYA**, or **PIRAI**, the name given in Guiana to *Serrasalmo piraya*, and other species of *Serrasalmo*, a genus of fishes of the family *Characiniæ*, regarded by many as a section of *Salmonidæ* (q. v.). The fishes of this genus, of which numerous species inhabit the rivers and other fresh waters of tropical South America, have a compressed and deep body, the belly keeled and serrated with a double row of hard serratures. They are extremely voracious fishes, and not only consume with great rapidity dead carcasses thrown into the water, but attack living creatures very much larger than themselves, biting off the fins of large fishes, and then devouring them at leisure, often mutilating ducks and geese by depriving them of their feet, and venturing to attack even oxen and human beings. The latter, however, make reprisals on them, and find them very good food. *Serrasalmo piraya* seldom exceeds 10 or 12 inches in length, but some of the species attain a considerably larger size. Some of them are very brilliantly coloured. The Indians use the teeth for sharpening the arrows, made of the very hard ribs of palm-leaves, which they use for their blow-pipes, and which they sharpen to a very fine point by drawing them across a piraya's jaw, an article with which the Indian of Guiana is always provided; nor does the edge of the teeth soon begin to be worn. Pirayas are readily taken by a baited hook, and almost any

kind of bait will do; but they at once cut through any line, and the line must therefore be cased above the hook in tin-plate. The Indians often shoot them with arrows.

**PIRMASENS**, a small town of the Bavarian Palatinate, and formerly the chief town of the county of Hanau-Lichtenberg, 22 miles west of Landau. It has 6735 inhabitants, who manufacture shoes and musical instruments.

**PIRNA**, a small town of Saxony, stands on the left bank of the Elbe, 11 miles by railway south-east of Dresden. It is surmounted by a hill, crowned by a castle, now used as a lunatic asylum, contains a beautiful parish church, and a number of important benevolent institutions. The manufacture of stone-ware employs many hands. Pop: about 6000.

**PISA**, one of the oldest and most beautiful cities of Italy, and, till lately, the capital of the now extinct grand-duchy of Tuscany, is situated in a fruitful valley, on the banks of the river Arno, which intersects the city and is spanned by three noble bridges. P. is situated in 43° 43' N. lat., and 11° 24' E. long. The population was, in 1862, 51,057. It has broad, straight, well-paved streets, and several fine squares. Among its 80 churches, the most worthy of notice is the cathedral, or Duomo, begun in 1068, and completed in 1118, with its noble dome, supported by 74 pillars, and its fine paintings, variegated marbles, and painted windows. Near the cathedral stands the round marble belfry known as the Leaning Tower of Pisa, from the circumstance that it deviates about 14 feet from the perpendicular. This celebrated building, which is 180 feet in height, and consists of seven stories divided by rows of columns, and surmounted by a flat roof and an open gallery commanding a splendid view of the surrounding country, was erected in the 12th c. by the German architect Wilhelm of Innsbruck. The Baptistery, or Church of St John, opposite the cathedral, an almost equally remarkable structure, was completed in 1162 by Diotisalvi. The main building, which is circular, and raised on several steps, supports a leaden-roofed dome, having a second dome above it, surmounted by a statue of St John. The beautifully proportioned interior, noted for its wonderful echo, contains a pulpit, which ranks as the greatest masterpiece of Nicola Pisano, various pieces of sculpture, and a large octagonal marble font. The Campo-Santo, or ancient national cemetery, dates from the year 1228, when the Pisans caused earth to be brought from Jerusalem for the graves of the most distinguished citizens of the republic. In 1283, the ground was surrounded by cloisters, the walls of which were adorned by fresco-paintings, now nearly obliterated, although some of these works of art, which are chiefly by Giotto, Veneziano, Orcagni, and Memmi, still retain traces of their original beauty. Among the other public buildings of P., special notice is due to the churches of La Madonna della Spina and San Stefano, both rich in paintings and sculptures, and the latter famous for its organ, the largest in Italy; the grand ducal and Lanfranchi palaces; the Torre della Fame, so called from its being supposed to have been the spot in which Ugolino Gherardesca and his children were starved to death in 1288; the university, founded in 1330, and restored by Cosmo I. de' Medici, which enjoyed a high reputation in the middle ages, and still possesses claims to consideration in its library, botanical garden, observatory, and affiliated schools and art collections, &c. The population of P., which, in the 13th c., amounted to 150,000, had fallen, in the present century, to less than one-sixth of that number; but of late years, trade and

industrial arts have made a rapid advance, and the population has increased in proportion. In the neighbourhood of P., at the foot of San Giuliano, lie the mineral baths, whose fame was known to Pliny, and which continued through the middle ages to attract sufferers from every part of Italy. The waters, which are rich in carbonic acid and chloride of sodium, are found efficacious in various arthritic and rheumatic affections.

*History.*—Ancient P., like other Etruscan cities subject to Rome, retained its municipal government, and enjoyed an almost unlimited freedom while nominally under Roman protection; but, on the decline of the imperial power, it was compelled to submit in turn to the various transalpine nations who successively overran Northern Italy. Early in the 11th c., P. had risen to the rank of a powerful republic, whose sway included the then fertile district known as the Maremma di Lerici, and which yielded little more than nominal homage to its suzerain lords, the emperors of Germany. Throughout the 11th c., P. was at the height of its prosperity, and to this period belong most of the splendid monuments of art that still adorn the city. Its troops took part in all the great events of the Holy Land; and its fleet in turn gave aid to the pope in Southern Italy, to the emperor in Northern France, chastised the Moors, and exacted its own terms from the Eastern emperors. In their wars with the Saracens of Sardinia, the Pisans had conquered Sardinia, Corsica, and the Balearic Islands, and for a time maintained their ground against their hereditary enemies, the Genoese; but having sided with the Ghibellines in the long wars which desolated the empire, P. suffered severely at the hands of the victorious Guelphic party. Indeed, the rivalry of the Guelphic cities of Florence, Lucca, and Siena, nearly brought P. to the brink of ruin at the close of the 13th c.; and after struggling for more than a hundred years against external foes and the internal dissensions between the democratic mob and the Ghibelline nobles, without losing their character for indomitable valour, the Pisans finally threw themselves under the protection of Galeazzo Visconti of Milan. The son of the latter sold the Pisan territory to their greatest enemies, the Florentines, from whose tyrannical rule it was for a time relieved by Charles VIII. of France, who, in 1494, accepted the protectorate of the city. When the French left Italy, the old struggle was renewed; and after offering a desperate resistance, the Pisans, in 1509, were compelled by hunger to surrender the city to the Florentine army besieging the walls. The most influential families, as formerly in 1406, when P. first lost her independence, preferred emigration to subjection, and removed to Sardinia and Sicily, since which time, P. has remained incorporated with the Florentine territories of Tuscany.

**PISA, COUNCIL OF**, one of the councils commonly reputed by Roman Catholics as oecumenical or general, although some, especially of the Ultramontane (q. v.) school, do not look upon it as such. It was assembled in the time of the great Western Schism, for the purpose of restoring the peace of the church, and the unity which had been interrupted by the rival claims of two competitors for the papacy. The history of this rival claim will be found under the head **WESTERN SCHISM**. For our present purpose, it is enough to state that the adherents of both the claimants of the see of Rome—those of Gregory XII., as well as those of Benedict—agreed on the necessity of a general council, as the only means of putting an end to the schism; and the rival popes having themselves either evaded or declined the demand, the cardinals of both united in issuing letters of convocation, and in summoning

both the claimants to the council so convened. Neither of them complied with the citation; but the council proceeded, nevertheless, to examine and deliberate upon the cause. It was opened at Pisa, March 25, 1409, there being present 22 cardinals, 4 patriarchs, 12 archbishops, 80 bishops, together with representatives of 12 archbishops and 102 bishops, and a vast body of abbots, doctors in theology, and other eminent ecclesiastics. Of the proceedings, it will be enough to say, that after a formal citation of the rival popes to appear within a stated period, the council, on the expiration of that period, proceeded to declare them contumacious, and to examine their respective claims as though they had appeared. The result, after a protracted inquiry, was a decree in the 13th session by which they were both declared schismatics, and their conduct heretical, and calculated to lead the people from the faith; wherefore, since they had violated the solemn engagements made at their respective elections, they were deposed from the papal dignity, and their followers released from obedience. In the 17th session, the cardinals having first pledged themselves by oath, each, that, if elected, he would continue the sittings of the council, entered into conclave to the number of 24, and unanimously elected Peter Philargi, one of the cardinal priests, and a member of the Franciscan order. He took the name of Alexander V. The council proceeded after his election to pass a number of decrees, for the purpose of giving validity to the acts done on either side during the schism. A vain attempt was made to obtain the submission of the still recusant rivals, and it was resolved that a new council should be held within three years. The authority of this council, like that of the Council of Constance, is alleged, on the Gallican side, as establishing the superiority of a general council over the pope. But the Ultramontanes reply that both these councils, and also that of Basel, must be regarded as abnormal assemblies, called to meet the special emergency of a disputed succession and of a doubtful pope, and that these principles cannot by any means be applied to the ordinary circumstances of the church, or form a precedent by which to estimate the normal relations between a pope whose title is certain and undisputed, and a general council regularly assembled at a time of peace, and in the ordinary circumstances of the church. It cannot be doubted, nevertheless, that the spirit of the fathers of Pisa was the same which ran through the succeeding assemblies of Constance and Basel, and found its permanent representation in the Gallicanism (see GALLICAN CHURCH) of later centuries.

**PISCATAQUA**, a river about 80 miles in length, which forms the southern part of the boundary between Maine and New Hampshire, U.S., and empties itself into the Atlantic, forming at its mouth the excellent harbour of Portsmouth.

**PISCICULTURE**, or **FISH-CULTURE**, the breeding and rearing of fishes, in order to the increase of the supply for food. Hitherto, it has been almost entirely limited to fresh-water fishes; nothing having been done as to sea-fishes but by legislation—chiefly in the case of the herring—to prevent the destruction of the very young fish, and that not, apparently, to much advantage. Ponds for sea-fishes have, indeed, been sometimes constructed, advantage being taken of natural circumstances favourable for the purpose; the ancient Romans had such ponds, and some have been made on different parts of the British coast; fishes being caught in the open sea and placed in them to be fed and fattened for the table. Such ponds, however, are of little real utility. That the Romans

succeeded in keeping sea-fishes in fresh-water ponds, as has been asserted, must be regarded as mere fable, or as an exaggeration, founded on the power which a few fishes have of adapting themselves both to fresh and salt water. But it may be doubted if in modern times sufficient advantage has been taken of this power.

Ponds for fresh-water fishes have been common from a very remote antiquity. It appears from Isaiah, xix. 10, that they were used in ancient Egypt. In the times of Roman luxury, almost every wealthy citizen had fish-ponds. The Chinese have long bestowed more attention on pisciculture than any other nation, and with them it is truly a branch of economy, tending to the increase of the supply of food and of the national wealth; not merely, as it seems to have been among the Romans, an appliance of the luxury of the great. In some countries of modern Europe, this branch of pisciculture is also prosecuted to a very considerable extent, particularly in Germany and Sweden, and of late years in France, in order to the supply of fish for the market. In Britain, it has never been systematically prosecuted, or for any important purpose; the country-seats of the nobility and gentry being, indeed, generally provided with fish-ponds, but in most cases rather as ornamental waters than for use. In the northern parts of Britain, trout, perch, and pike are almost the only fish kept in ponds; in England, they are often stocked with carp and tench, and are turned to much better account than in Scotland. In Germany, ponds carefully attended to are found very productive and remunerative. There can be no doubt that in Britain, also, many a piece of land at present very worthless, might easily be converted into a pond, and made to yield large quantities of excellent fish; but such a thing seems almost never to be thought of.

In the construction of ponds, or *stews*, for fish, it is recommended to have, if possible, a succession of three ponds on the same rivulet, with sluices, by which they can be dried, so that the fish may be easily taken when required, the different ponds being in part intended for fish of different ages. But all this must be very much regulated by local circumstances. It is of more importance to note that the margins should be shallow, so that there may be abundance of reeds and other water-plants, and that only a small part of the pond should be too deep for the growth of pond-weeds (*Potamogeton*). Much depends on the soil of the neighbourhood as to the supply of food, and consequently the growth of fish and productiveness of the pond. Trees overhanging the pond are not desirable; the decomposition of their fallen leaves being injurious to fish. The growth of weeds is more to be encouraged in ponds for carp and tench than in those for perch or trout. A stony bottom is very advantageous to perch and trout ponds. Ponds for pike must be larger than is necessary for any other fish known to British pisciculture: an extent of at least six acres is desirable. A nursery for minnows may be established with great advantage in connection with a fish-pond, as they afford most acceptable food to perch, pike, and trout. But in a pond where carp and tench are expected to spawn, the presence of minnows is very undesirable. It is often impossible to provide a pond with a place suitable for the spawning of trout, for which a gravelly stream with a quick current is necessary; but for perch, pike, carp, or tench, the pond itself is sufficient, and the stock once introduced is kept up without replenishing. Indeed, it is recommended that a pond stocked with carp should also be stocked with pike, that the excessive multiplication of the carp may be checked,

## PISCICULTURE.

which would otherwise prevent the fish from growing rapidly or to a good size.

The greatest improvement in pisciculture, and a most important branch of it, to which the term is often restricted, is the breeding of fish in artificial breeding-places, from which not only ponds but rivers may be stocked; or the art of fecundating and hatching fish-eggs, and feeding and protecting the young animals till they are of an age to secure their own food, and protect themselves from their numerous enemies. As at present conducted, pisciculture has become in many instances a profitable branch of industry; and the art has been employed in France with great success for replenishing with fishes many of the most important streams that had become barren through over-fishing; in Britain, also, this artificial system has become a profitable adjunct of one or two of our larger salmon-fisheries.

Modern pisciculture is the revival of an old art well known to the ancient Italians, but which had fallen into abeyance for a number of centuries. The art of breeding and fattening fish was well known to the luxurious Romans, and many stories are told about the fanciful flavours which were imparted to such pet fishes as were chosen for the sumptuous banquets of Lucullus, Sergius Orata, and others. The art had doubtless been borrowed from the ingenious Chinese, who are understood to have practised the art of collecting fish-eggs and nursing young fish from a very early period. Fish forms to the Chinese a most important article of diet; and from the extent of the water-territory of China, and the quantities that can be cultivated, it is very cheap. The plan adopted for procuring fish-eggs in China is to skim off the impregnated ova from the surface of the great rivers at the spawning season, which are sold for the purpose of being hatched in canals, paddy-fields, &c.; and all that is necessary to insure a large growth of fish is simply to throw into the water a few yolks of eggs, by which means an incredible quantity of the young fry is saved from destruction. Although all kinds of fish are enormously fecund, it is well known to naturalists that only a small percentage of the eggs ever come to life, and of the young fish, very few ever reach the table as food. So many of the eggs are destroyed by various influences, and so many likewise escape impregnation, that if we are to keep up our fish supplies, pisciculture, or protected breeding becomes absolutely necessary.

Commercial pisciculture, as at present carried on, owes its origin to the French, the art having been first put in practice by M. Remy, a poor fisherman, who gained a living by catching fish in the streams of La Bresse in the Vosges. This re-discovery of the lost art of fish-breeding is understood to have been quite accidental on the part of Remy, although it is thought by some zealous Scotchmen that the Frenchman must have heard of the experiments of Mr Shaw of Drumlanrig, who, for a few years previous to Remy's discovery, had been trying to solve some problems in the natural history of the salmon by means of the artificial system. The art had also been partially revived in Germany about the middle of last century by a gentleman of the name of Jacobi, who practised the artificial breeding of trout. Whether or not Remy had heard of either of these experimenters, it is certain that to him we owe the revival of the art in its larger or commercial sense; the others only used it as an adjunct to their study of the natural history of fishes. In one sense, fish-culture was largely practised in this country long before the discovery by Remy of the system of artificial fecundation—we allude to the fact of there being large numbers of private ponds and stews in which country gentlemen bred fish for the

use of their own tables, as well as similar places attached to monasteries and other religious edifices, in which fish were grown for fast-day uses. The range of fish suited for pond-breeding was very limited; and to render them at all good in flavour, expensive food had to be obtained for them, and they had to be served up accompanied by expensive sauces. It is probable that some of our rarest fishes were introduced into this country during these old monastic times, such as the Lochleven trout, the vendace, &c.

It was the great waste of eggs incidental to the natural system of fish-breeding that led Remy, about 1842, in conjunction with Gehin, a coadjutor whom he assumed as a partner, to try what he could do in the way of re-peopling the fish-streams of his native district. His plan being at once successful, attracted the favourable notice of many of the French savans, and led to rewards and preferment for Remy; the new art was taken under the protection of the government; and now, after the experience of twenty years, artificial fish-culture has been so perfected in France that there has arisen at Huningue, near Basel, on the Rhine, a gigantic fish-nursery and egg-dépot for the supply of eggs, and the dissemination of the art both in France and other countries. The place is fitted up specially for this purpose with egg-boxes and reservoirs; and millions of eggs are annually received, and sent to Germany, Spain, England, and other places. A drawing is given on the next page of one of the halls of this interesting establishment.

The course of business at Huningue is as follows: the eggs are chiefly brought from the streams of Switzerland and Germany, and embrace those of the common trout, as well as the Rhine and Danube salmon, and the tender charr or ombre chevalier. People are appointed to capture gravid fish of these various kinds, and, having done so, to communicate the fact to Huningue. An expert is at once sent to deprive these fishes of their spawn, and bring it to the breeding or resting boxes, where it is carefully tended till it is ready to be despatched to some district in want of it. It is, of course, much more convenient to send the eggs than the young fish, as the former, nicely packed among wet moss in little boxes, can be carried to a distance with greater facility. The mode of artificially spawning a salmon is as follows. It should, of course, be ascertained that the spawn is in a perfectly matured state, and that being the case, the salmon is held under water in a large tub, while the hand is gently passed along its abdomen, when, if the ova be ripe, the eggs will flow out like so many pease. The eggs are then carefully washed, and the water is poured off. The male salmon is then handled in a similar way, when the contact of the milt immediately changes the eggs into a brilliant pink colour. After being again washed, they may be laded out into the breeding-boxes, and left to come to life in due season. The period occupied in hatching is different in different climates. At Stormontfield, where the eggs have no shelter, the usual period is about 135 days; but salmon ova have been known to burst in about half that period, and to yield very healthy fish. Great care is of course necessary in handling the ova. The eggs manipulated at Huningue are all carefully examined on their arrival, when the bad ones are thrown out, and those that are good are counted and entered in a record. The ova are watched with great care, and from day to day all that become addled are removed. The applications for eggs, both from individuals and associations, are always a great deal more numerous than can be supplied; and before second applications can be

## PISCICULTURE.

entertained, it is necessary for the parties to give a detailed account of how their former efforts succeeded. It may be interesting to note, as regards

the cost of pisciculture at Huningue, that the most expensive fish is the ombre chevalier. Of some species, as many as sixty or seventy per cent. of the

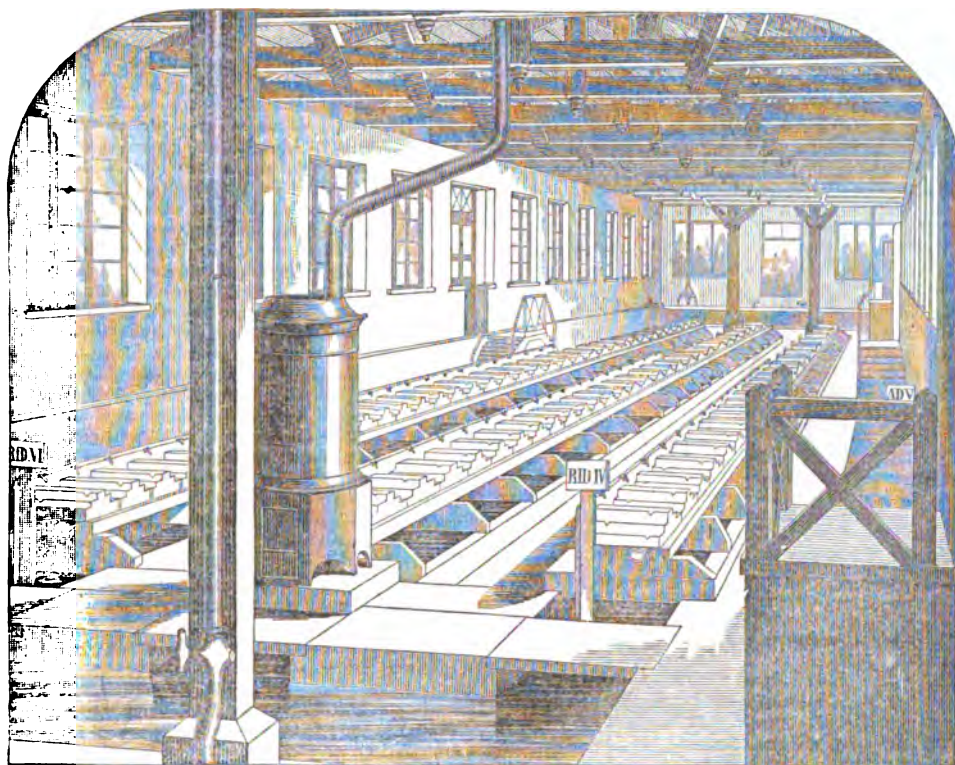

Reception-hall for Fish-eggs at Huningue.

eggs are lost. The general calculation, however, is twelve living fish for a penny.

The total number of all kinds of fishes distributed from Huningue, during the first ten years was upwards of 110 millions! See HUNINGUE.

A very successful effort in pisciculture has been carried out in connection with the salmon-fisheries of the river Tay. At Stormontfield, near Perth, a series of ponds have been constructed, and a range of breeding-boxes laid down capable of receiving 300,000 eggs; and in a large addition to their rental, the proprietors of the Tay fisheries are reaping the reward of their enterprise. The operations at Stormontfield were begun in 1853, and from the end of November till the end of December, 300,000 ova were deposited, and these coming to life in April 1854, remained in the boxes and ponds one half for one year, and the other moiety for two years before they assumed the scales of the smolt, and were seized with the migratory instinct. See SALMON. Every two years since the completion of the ponds, a brood has been obtained, and upwards of one million of salmon have by means of these ponds been added to the fish-stock of the river Tay, so as considerably to enhance the value of the fisheries. Another pond (there was only one originally) has now been added to the suite, for the purpose of holding the second-year parrs, so that a brood of 300,000 will now be obtained annually. At several other places in Scotland, the artificial system is being introduced as an adjunct to the natural breeding resources of different rivers.

The art of pisciculture has also been introduced into Ireland, at the fisheries of Loughs Mask and Carra, by the Messrs Ashworth, who have obtained excellent practical results from their enterprise. These lochs contain an area of water equal to thirty-five acres; and a communication with the sea having been opened, they now teem with salmon; and the proprietors are confident that it is as easy and as profitable to cultivate salmon as sheep. The latest experiment in fish-culture with the salmon consists in the introduction of that fish into Australia and Tasmania. Impregnated eggs carefully packed in ice were sent out in a fast-sailing ship, and were at once transferred to a suitable river, where (1864) they burst into life, with every prospect of becoming naturalised in that vast continent.

A series of piscicultural experiments have been very successfully carried on in the upper waters of the Thames, and the salmon has been bred along with various other fishes, upwards of 120,000 fishes having been added to the stock of the river; but the success of this experiment yet remains to be determined, as it is not certain whether the salmon will be able to penetrate to the sea, in consequence of the lower Thames being used as the sewer of London.

This branch of pisciculture has begun to be prosecuted to some extent in several countries of Europe, and has been deemed of sufficient importance to demand the attention of governments. It is probable that the attention turned to the whole subject of pisciculture, and the example of the transportation of salmon to Australia, may lead to



the introduction of valuable kinds of fishes into waters where they are now unknown. The grayling has thus already been introduced into the Clyde and Tweed. There is no apparent reason why every valuable fresh-water fish of Europe should not be plentiful in Britain.

The French government are now extending the system of artificial culture to some kinds of sea-fish and to many of the larger crustaceans. See OYSTER. At Comacchio (q. v.), on the Adriatic, a curious industry is carried on in the cultivation of eels; and in the Bay of Aiguillon, there is an ancient mussel-farm in which large quantities of that shell-fish are annually grown from the seed, and turned to very profitable account. There is no practical difficulty, it is said, in rendering an acre of water as productive as an acre of land.



Piscina, Warmington.

PISCINA, the large basin (or pond) in the Roman thermæ, containing tepid water, in which the bather might swim.

PISCINA, a shallow stone basin with a drain (usually leading directly to the earth), in Roman Catholic churches, in which the priest washes his hands, and for rinsing the chalice at the celebration of the mass. In England, it is almost invariably placed on the south side of the choir, at a convenient height.

PI'SÉ, a kind of work used instead of brick, &c., for the walls of cottages. It consists of loam or earth hard rammed into framing, which, when dry, forms a wall.

PI'SEK (Boh. *Piscek*, sand), a small town of Bohemia, on the right bank of the Wottawa, an affluent of the Moldau, stands on a sandy plain (from which circumstance it probably received its name) 55 miles south-south-west of Prague. The town is old, and contains the remains of a royal castle. Among other institutions are a school of arts and a high school. The manufactures are woollen and cotton fabrics, iron wire, and musical instruments. Pop. 6100.

PISHAMIN. See DATE PLUM.

PI'SOLITE (Gr. pea-stone), a concretionary limestone, differing from oolite in the particles being as large as pease.

PISTA'CIA, a genus of trees of the natural order *Anacardiaceæ*, having dioecious flowers without petals, and a dry drupe with a bony stone.—The PISTACIA or PISTACHIO TREE (*P. vera*) is a small tree of about 20 feet high, a native of Persia and Syria, but now cultivated in all parts of the south of Europe and North of Africa, and in many places naturalised. It has pinnate leaves, with about two pair of ovate leaflets, and an odd one; flowers in racemes; fruit ovate, and about the size of an olive. The stone or nut splits into two valves when ripe; the kernel, which is of a bright green colour, is very oleaginous, of a delicate flavour, and in its properties very much resembles the sweet almond. In the south of Europe and in the East, *Pistachio nuts* are much esteemed; but as they very readily become rancid, they are little exported to other countries. They are sometimes called *Green Almonds*. Oil is expressed from them for culinary and other uses. In cultivation, one male tree is allowed to

five or six fertile ones. The tree produces flowers and even fruit readily enough in the south of England, but the summers are not warm enough to ripen the fruit, and the tree is apt to be destroyed by a severe frost.—The MASTIC TREE, or LENTISK (*P. lentiscus*), yields the gum-resin called Mastic (q. v.). It is a native of the countries around the Mediterranean.—The TURPENTINE TREE (*P. terebinthus*) yields the Turpentine (q. v.) known in commerce as *Cyprus Turpentine*, *Chian Turpentine*, or *Scio Turpentine*, which is of a consistency somewhat like that of honey, a greenish-yellow colour, an agreeable odour, and a mild taste, and in its properties resembles the turpentine of the Coniferæ, but is free from acidity. It is obtained by making incisions in the trees, and placing stones for the turpentine to flow upon, from which it is scraped in the morning, before it is liquefied again by the heat of the sun. The tree is about 30 or 35 feet in height; and has pinnate leaves, of about three pair of leaflets and an odd one; the flowers in compound racemes, the fruit nearly globular. The kernel of the fruit is oleaginous and pleasant.—The BATOUX TREE (*P. Atlantica*), a round-headed tree of about 40 feet in height, a native of the north of Africa, produces a fruit much used by the Arabs; and a gum-resin of pleasant aromatic smell and agreeable taste, which exudes from its stem and branches, is chewed to clean the teeth and impart a pleasant smell to the breath.—The fragrant oil of the kernels of *P. oleosa*, a native of Cochin China, is used by the people of that country to impart a perfume to ointments.

PI'STIL, in Botany, the female organ of fructification in phanerogamous plants; that part of the Flower (q. v.) which, after flowering is over, is developed into the fruit. There is sometimes one pistil in a flower, sometimes more; in some flowers, which have numerous pistils, they form a number of whorls, one within another, sometimes on an elevated receptacle or elongated axis, or, more rarely, they are spirally arranged. In every case, the centre of the flower is occupied by the pistil or pistils, if present. See FLOWER. A pistil is either formed of a single Carpel (q. v.), as is the case when there are numerous pistils, or of several carpels combined; and the number of carpels of which the pistil is formed is often indicated by the number of the cells of the germen, or by its lobes or angles. The pistil usually consists of a Germen (q. v.) or ovary, in which the Ovules (q. v.) are contained, and which is surmounted by a stigma, either immediately or through the intervention of a style; but in Gymnogens (q. v.), there is neither germen, style, nor stigma, the female organs of fructification being mere naked ovules. The germen is always the lowest part of the pistil. The stigma exhibits an endless variety of forms, and is adapted to the reception and retention of the pollen grains requisite for fecundation, partly by the roughness of its surface—which is of a somewhat lax cellular tissue, covered with projecting cells, often in the form of minute warts, and often elongated into hairs—and partly by the secretion of a viscous fluid. The stigma when not sessile—or seated immediately on the germen—is supported by the style, which rises from the germen, and on the top of which the stigma is generally placed. The style is sometimes very long and slender, sometimes very short; the germen sometimes passes imperceptibly into the style, and sometimes the style rises from it abruptly; and similar differences appear in the relations of the style and stigma; the stigma, however, may be regarded as always an expansion of the top of the style, although it is sometimes, but rarely, situated on one or both sides of the style, beneath its summit. In like

PISTILLIDIUM—PISTOLE.

manner, by peculiar modifications taking place in the growth of the germen, the style sometimes seems to arise from beneath its apex, or even from

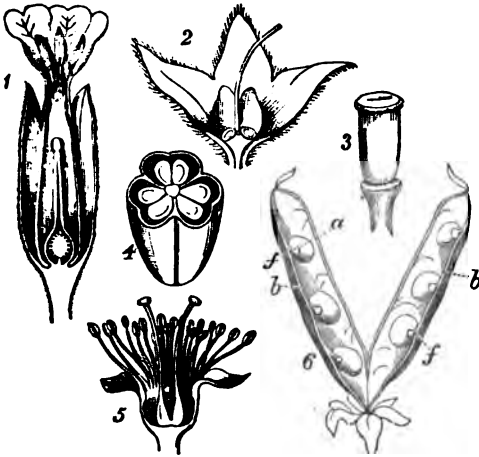

Pistils :

1, Section of flower of a species of Primrose, shewing the pistil laid open; numerous ovules attached to a free central placenta. 2, Section of flower of Comfrey, with corolla removed, shewing two of the four ovaries, and the style. 3, Pistil of the Barberry, consisting of several carpels combined; the style very short and thick, the stigma shield-like. 4, Section of the ovary of a Lily. 5, Section of flower of Cherry, shewing pistil of two separate carpels, only one of which comes to perfection in fruit. 6, Pistil of Pea, opened; a, ovule; b, placentas; f, umbilical cord.—From Balfour's *Class-book of Botany*.

its base; but it always rises from what is, structurally considered, the real apex of the germen. When several carpels are united to form one germen, they are sometimes again separated in their styles, and more frequently in their stigmas, so that one germen bears several styles, or the style divides at some point above the germen, or one style is crowned by a number of stigmas. The style is usually cylindrical; and when this is not the case, it is often owing to the combination of several styles into one, although sometimes the style is flat and even petal-like. It is traversed throughout its whole length by a canal, which, however, is in general partly filled up by cells projecting from its sides, and often also by very slender tubes extending in the direction of its length; the function of the canal, to which in some way or other the enclosed slender tubes are subservient, being to bring about the connection between the pollen and the ovules for fecundation (q. v.). The length of the style is adapted to the ready fecundation of the ovules, being such that the pollen may most easily reach the stigma; and in erect flowers, the styles are usually shorter than the stamens; in drooping flowers, they are longer than the stamens. After flowering is over, when fecundation has taken place, the *foramen* of the ovules closes, the germen enlarges and ripens into the fruit, whilst each ovule is developed into a seed. The style and stigma meanwhile either fall off, or remain and dry up, or they increase in size, and are changed into various kinds of appendages of the fruit, as feathery awns, beaks, &c.

**PISTILLIDIUM**, in Botany, a term which, along with *Antheridium* (q. v.), must be regarded as provisional, and as expressive of an opinion, probable, but not yet ascertained to be true. The evidence in favour of it, however, seems continually to increase, and its great probability is more and

more generally acknowledged. The pistillidium is an organ of cryptogamous plants, supposed to perform functions in fructification analogous to those of the pistil in phanerogamous plants. It consists of a germen-like body—the *sporangium*, *theca*, or *spore-case*—hollow, and containing Spores (q. v.), by which the species is propagated. These spore-cases are very various in their forms and in the situations which they occupy in different orders and genera; being sometimes immersed in the substance of the plant, sometimes distinct from it, sometimes sessile, sometimes stalked, &c. See the articles on the different cryptogamous orders.

**PISTO'JA** (anc. *Pistorium*), a manufacturing town of Italy, in the province of Florence, and 21 miles by railway north-west of the city of that name, stands on a gentle rising ground at the foot of the Apennines. It is well built; its streets are thoroughly Tuscan, and it is surrounded by lofty and well-preserved walls. The chief buildings are the cathedral, built at various times, and containing a number of good pictures; several old and interesting palaces, and a number of churches, some of which are of importance in the history of medieval architecture and sculpture. The principal manufactures are iron and steel wares, and paper. Pop. about 12,000.

**PISTOL** is the smallest description of fire-arm, and is intended to be used with one hand only. Pistols vary in size from the delicate saloon-pistol, often

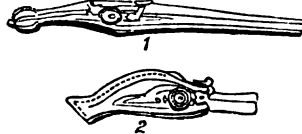

Ancient Pistols :

1, Long Wheel-lock Pistol; 2, Pocket 'Wheel-lock Dag'—temp. Elizabeth.—From Fairholt's *Costume in England*.

not six inches long, to the horse-pistol, which may measure 18 inches, and sometimes even two feet. They are carried in holsters at the saddle-bow, in the belt, or in the pocket. Every cavalry soldier

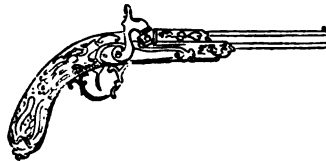

Modern Pistol.

should have pistols, for a fire-arm is often of great service for personal defence, and almost indispensable in giving an alarm or signal. Sailors, when boarding an enemy's ship, carry each two in their waistbelts.

As early as the reign of Henry VIII., the English cavalry carried clumsy pistols called 'dags.' The latest improvement on the pistol is the Revolver (q. v.).

**PISTOLE**, the name given to certain gold coins current in Spain, Italy, and several parts of Germany. The pistole was first used in Spain, and was originally equivalent to about 11 old French livres, but till 1728 it was merely an irregular piece of gold. From this time till 1772, its value was 17s. 1d. sterling; but it was after this date decreased till it reached its present value of 80 reals, or 16s. 2d. sterling. Gold coins of 4, 2, 1, and ½ pistoles are at the present day current in Spain. The Italian pistoles are also gold coins, and vary considerably in value: that of Rome =

13s. 9d.; of Venice = 16s. 2½d.; of Florence and Parma = 16s. 1¼d.; and the old coin of Piedmont = £1, 2s. 7½d., or 24 old liras. These will, however, in all probability, be soon superseded by the new pistole of 20 liras, or francs, which is equivalent to 16s. sterling. Gold coins of this name are current in Hesse-Cassel, Switzerland, Brunswick, and Hamburg, but are in most cases merely convenient multiples of the ordinary thaler and gulden.

**PISUM.** See **PEA**.

**PIT**, in Gardening, is an excavation in the ground, intended to be covered by a Frame (q. v.), and to afford protection to tender plants in winter, or for the forcing of vegetables, fruits, &c. Pits are often walled on all sides, although, in many cottage gardens, excellent use is made of pits which are mere excavations. The walls are often raised above the ground, particularly the back wall, the more readily to give slope to the glazed frame. A pit in which no artificial heat is supplied, is called a *cold pit*; but when forcing is intended, flued pits are often used. Artificial heat is sometimes also given by means of fermenting matter. The ventilation of pits, as much as the weather will permit, is of the greatest importance.

**PITA-HEMP**, one of the names of the Agave or Aloe fibra. See **AGAVE**.

**PIT'AKA** (literally, 'basket') is, with the Buddhists, a term denoting a division of their sacred literature, and occurs especially in combination with *tri*, 'three;' *tripit'aka* meaning the three great divisions of their canonical works, the *Vinaya* (discipline), *Abhidharma* (metaphysics), and *Sūtra* (aphorisms in prose), and collectively, therefore, the whole Buddhistic code. The term 'basket' was applied to these divisions, because the palm-leaves on which these works were written were kept in baskets, which thus became a part of the professional utensils of a Bhikshu, or religious mendicant.

**PITCAIRN ISLAND**, a solitary island in the Pacific Ocean, lying at the south-eastern corner of the great Polynesian Archipelago, in lat. 25° 3' 6" S., and long. 130° 6' W. Its length (2½ miles) is about twice its breadth, and the total content is approximately 1½ square miles; so that, except from its being the only station (with the exception of the Gambier Islands) between the South American coast and Otaheite at which fresh water can be procured, it would be too insignificant to deserve notice, were it not for the manner in which it was colonised. The island is wholly surrounded by rocks; it has no harbour, and its soil is not very fertile. It was occupied in 1790 by the mutineers of the *Bounty* (see **BLIGH, WILLIAM**), who, after touching at Toobouai, sailed for Tahiti, where they remained for some time. Christian, the leader of the mutineers, however, fearing pursuit, hastened their departure; and after leaving a number of their comrades who preferred to stay on the island, they brought off with them 18 natives, and sailed eastward, reaching P. I., where they took up their residence, and burned the *Bounty*. They numbered then 9 British sailors—for 16 of the sailors had preferred to remain at Tahiti, and of these, 14 were subsequently captured, and (September 1792) three of them executed—and 6 Tahitian men, with 12 women. It was impossible for concord to subsist in a band of such desperate character; and, in the course of the next ten years, all the Tahitian men, all the sailors, with the exception of Alexander Smith (who subsequently changed his name to John Adams), and several of the women, had died by violence or disease. From the time of their leaving Tahiti, nothing had been heard of them, and their fate was only known when an American, Captain

Folger, touched at P. I. in 1808, and on his return, reported his discovery to the British government; but no steps appear to have been taken by the latter. On September 17, 1814, a British vessel, the *Britain*, called at the island, and found old Adams still alive, commanding the respect and admiration of the whole little colony, by his exemplary conduct and fatherly care of them. Solitude had wrought a powerful change in Adams; and his endeavours to instil into the young minds of his old companions' descendants a correct sense of religion, had been crowned with complete success, for a more virtuous, amiable, and religious community than these islanders, had never been seen. They were visited by British vessels in 1825 and 1830, and the reports transmitted concerning them were fully corroborative of the previous accounts; but, in 1831, their numbers (87) had become too great for the island, and at their own request, they were transported to Tahiti, in the *Lucy Ann*, by the British government. But, disgusted at the immorality of their Tahitian friends and relatives, they chartered a vessel, defraying the cost of it in great part with the copper bolts of the *Bounty*, and most of them returned to P. I. at the end of nine months. In 1839, being visited by Captain Elliot of H.M.S. *Fly*, they besought to be taken under the protection of Britain, on account of the annoyances to which they had been subjected by the lawless crews of some whale-ships which had called at the island; and, accordingly, Captain Elliot took possession of it in the name of Her Majesty, gave them a Union Jack, and recognised their self-elected magistrate as the responsible governor. He also drew up for them a code of laws, some of which are amusing from the subjects of which they treat, but the code was of great use to the simple islanders. From this time, they were frequently visited by European ships; and, in 1855, finding their numbers again too great for the island, they petitioned government to grant them the much more productive Norfolk Island, to which they were accordingly removed in 1856. In 1859, however, two families, numbering in all 17, returned to P. I., reducing the number of those left on Norfolk Island to 202. From their frequent intercourse with Europeans, the Pitcairn Islanders have, while still retaining their virtuous simplicity of character and cheerful hospitable disposition, acquired the manners and polish of civilised life, with its education and taste. They are passionately fond of music and dancing, the latter evidently a legacy from their maternal ancestry. The men are engaged in whaling and herding cattle, or in cultivating their gardens and plantations; while the women (who seem to be the more industrious class) attend to their families, manage the dairies, and take an occasional part in field-labour.

P. I. was first discovered by Carteret in 1767, and was named by him after one of his officers; but it was never visited by Europeans till taken possession of by the mutineers, though the latter found satisfactory indications of its having previously been occupied for a considerable period by savages, probably from the neighbouring islands.



**PITCH**. The common kind of pitch is the black residue which remains after distilling wood-tar. See **TAR**. It is made extensively in Russia, Norway, and North America. It is a most useful material for protecting wood from the action of water, hence it is used for calking the seams, and coating the outsides of ships and boats; it is also applied to the inside of water-casks, and many similar uses. A variety of pitch is now obtained from the distillation of coal-tar, and another from bone-tar: the latter is said to be nearly equal in

value to that from wood, but coal-pitch wants the toughness which is one of the more valuable qualities of wood-pitch. It is, however, much used in making artificial asphalt for building and paving purposes; and for the black varnish used for coating iron-work to keep it from rusting. Pitch is solid at the ordinary temperature of our climate, but softens and melts with a small accession of heat.

**PITCH, BURGUNDY.** See BURGUNDY PITCH.

**PITCH**, the degree of acuteness of musical sounds. A musical sound is produced by a series of vibrations recurring on the ear at precisely equal intervals; the greater the number of vibrations in a given time, the more acute or higher is the pitch. In stringed instruments, the pitch is dependent on the length, the thickness, and the degree of tension of the strings; the shorter and thinner a string is, and the greater its tension, the higher is the pitch of the note. In wind instruments, where the notes are produced by the vibration of a column of air, as in the mouth-pipes of an organ, the pitch is dependent on the length of the column set in motion; the shorter the column of air, the higher the pitch becomes.

The pitch of musical instruments is adjusted by means of a tuning-fork, consisting of two prongs springing out of a handle, so adjusted as to length that, when struck, a particular note is produced, that

note being C  in Britain, and A 

in Germany. It is obviously important to have a recognised standard of pitch, by which instruments and voices are to be regulated: but there is, unfortunately, not the uniformity that might be desired in the pitch in actual use. For a long time prior to 1859, concert-pitch had been gradually rising, to the detriment of the voices of public singers. The C tuning-fork, in use in 1699, made 489 vibrations per second, while in 1859, the number of vibrations had increased to 538. Mr Hullah, in 1842, in the numerous classes instituted by him under the sanction of the Committee of Council on Education, found it necessary to secure a uniform standard of pitch, and adopted 512, which has an especial convenience as being a power of 2. The French Imperial government, in 1858, fixed on 522. In 1859, a Committee of the Society of Arts was appointed to consider the subject of a uniform musical pitch. Their deliberations lasted 12 months. Sir John Herschel, in a letter to the Committee, strongly recommended the number 512. It was agreed on all hands that the then existing opera-pitch of 546 was too high and painful to the singers of soprano music. The instrumental performers stated that they could lower the pitch to 523, but if they had to lower it to 512, some of them would have to purchase new instruments; and, in consequence apparently of their representation, the Committee reported in favour of 523.

**PITCHBLENDE**, a mineral which is essentially Oxide of Uranium (q. v.), with slight mixtures of other substances. Its colour is grayish-black or brownish-black. It is infusible before the blowpipe, without the addition of borax, with which it fuses into a dull yellow glass.

**PITCHER PLANT.** See NEPENTHES.

**PITCHSTONE**, a name sometimes given to a variety of common Opal (q. v.), brown, black, gray, red, or of mixed colours; the lustre more resinous than in opal, and the fracture less perfectly conchoidal. It occurs in several localities in the British Islands, in Saxony, &c.—The same name is given to another mineral (Ger. *Pechstein*), a variety

of Felspar (q. v.), occurring as a rock in dikes which traverse strata or in overlying masses; compact, slaty, or in concentric slaty concretions. It exhibits great variety of colour, and has a somewhat resinous appearance. It often contains numerous imbedded crystals of felspar, and is then called *P. porphyry*.

**PITCHURIM BEANS**, or **SASSAFRAS NUTS**, an occasional article of importation from South America, are the seed-lobes of *Nectandra Puchury*, a tree of the same genus with the Greenheart (q. v.), growing on the banks of the Rio Negro and elsewhere in the rich alluvial parts of the basin of the Amazon. They are about an inch and a half long, and half an inch broad. They are much in request among chocolate manufacturers for flavouring chocolate, as a substitute for vanilla. They are sometimes called Wild Nutmegs, because of a resemblance to nutmeg in flavour. The name Sassafras Nuts is also due to the flavour, which approaches that of Sassafras bark; and the tree belongs to the same natural order with the Sassafras tree.

**PITH** (*Medulla*), the light cellular substance which occupies the centre of the stem and branches in Exogenous Plants (q. v.). In the earliest stage of a young stem or branch, it is entirely composed of pith and bark, by which alone, therefore, young buds are nourished; the vascular bundles or woody fibre appearing afterwards, and in trees and shrubs, generally increasing, so as to constitute the greater part of the substance of the stem and branches, whilst the pith is ultimately reduced to a very small column in the centre. The pith, however, exists even in the most mature woody stem, and maintains its connection with the bark by means of *Medullary Rays*, analogous in their character to the pith itself, and which exist even in the most compact wood, although much compressed by the woody layers, and in a transverse section appearing as mere lines. The medullary rays convey to the central parts of the stem the secretions of the bark necessary for their nourishment. P. is in general entirely composed of cellular tissue; vessels occurring in it only in a few plants. Its cells diminish in size from the centre towards the circumference. In a few plants, it exhibits cavities which have a regular arrangement; in many herbaceous plants of rank growth, large irregular cavities occur in it. The pith is immediately surrounded by a thin vascular layer called the *Medullary Sheath*, consisting chiefly of spiral vessels, which continue to exercise their functions during the life of the plant.

**PITHE'CIA.** See SAKI.

**PITHE'CUS.** See ORANG.

**PIT'ON BARK.** See CARIBBEE BARK.

**PITR'I** (a Sanscrit word literally meaning father = Latin *pater*, in the plural *Pitares*, but in English translations from the Sanscrit usually Anglicised to *Pitris*), a name which, in a general sense, means the deceased ancestors of a man, but in the special sense in which it occurs in Hindu mythology, denotes an order of divine beings inhabiting celestial regions of their own, and receiving into their society the spirits of those mortals for whom the funeral rites (see *SRADDHA*) have been duly performed. They include, therefore, collectively the manes of the deceased ancestors; but the principal members of this order are beings of a different nature and origin. According to Manu, they were the sons of Marichi, Atri, Angiras, and the other R'ishis or saints produced by Manu, the son of Brahmâ; and from them issued the gods, demons, and men. According to several Purânas (q. v.), however, the first Pitris were the sons of the gods; and to reconcile this discrepancy, a legend relates

that the gods having offended Brahmā by neglecting to worship him, were cursed by him to become fools; but upon their repentance, he directed them to apply to their sons for instruction. Being taught accordingly the rites of expiation and penance by their sons, they addressed the latter as fathers, whence the sons of the gods were the first Pitri's (fathers). See Wilson's *Viśhn'u-Purān'a*. Manu enumerates various classes of Pitri's in defining those who were the ancestors of the gods, those who were the ancestors of the demons, and those from whom proceeded the four castes severally; but he adds, at the same time, that these are merely the principal classes, as their sons and grandsons indefinitely must likewise be considered as Pitri's. The Purān'as divide them generally into seven classes, three of which are without form, or composed of intellectual, not elementary substance, and assuming what forms they please, while the four other classes are corporeal. In the enumeration, however, of these classes the Purān'as differ. The Pitri's reside in a world of their own, called Pitri-loka, which is sometimes supposed to be the moon; according to the Purān'as, it is below the paradise of Indra, and is also the abode of the souls of devout Brahmans. The time at which the Pitri's are to be worshipped, the libations which they are to receive, the benefit which they derive from them, and the boons which they confer on the worshipper, are all minutely described in the Purān'as. See ŚRĀDDHA. A song of the Pitri's, as given by the *Viśhn'u-Purān'a*, may convey an idea of the importance attributed to this worship, and of the manner in which the Brahmans turned it to their profit. It runs as follows: 'That enlightened individual who begrudges not his wealth, but presents us with cakes, shall be born in a distinguished family. Prosperous and affluent shall that man ever be who, in honour of us, gives to the Brahmans, if he is wealthy, jewels, clothes, lands, conveyances, wealth, or any valuable presents; or who, with faith and humility, entertains them with food, according to his means, at proper seasons. If he cannot afford to give them dressed food, he must, in proportion to his ability, present them with unboiled grain, or such gifts, however trifling, as he can bestow. Should he be utterly unable even to do this, he must give to some eminent Brahman, bowing at the same time before him, sesame seeds, adhering to the tips of his fingers, and sprinkle water to us, from the palms of his hands, upon the ground; or he must gather, as he may, fodder for a day, and give it to a cow; by which he will, if firm in faith, yield us satisfaction. If nothing of this kind is practicable, he must go to a forest, and lift up his arms to the sun and other regents of the spheres, and say aloud: "I have no money, nor property, nor grain, nor any thing whatever fit for an ancestral offering; bowing therefore to my ancestors, I hope the progenitors will be satisfied with these arms tossed up in the air in devotion." See Wilson's *Viśhn'u-Purān'a*.

PITT, WILLIAM, the second son of the Earl of Chatham and of Lady Hester Grenville, daughter of the Countess Temple, was born on the 28th May 1759. His genius and ambition displayed themselves with an almost unexampled precocity. 'The fineness of William's mind,' his mother writes of him, when he was but twelve years old, 'makes him enjoy with the greatest pleasure what would be above the reach of any other creature of his small age.' Owing to the excessive delicacy of his constitution, it was found impossible to educate him at a public school. His studies were, however, prosecuted at home with vigour and success. In 1773, he was sent to the university of Cambridge, where his knowledge of the classics seems to have

astonished veteran critics. To modern literature, he appears to have been utterly indifferent—he knew no continental language except French, and that very imperfectly. Among English poets, he liked Milton best; the debate in Pandemonium being his favourite passage. In 1780, P. was called to the bar. He took chambers in Lincoln's Inn, and joined the western circuit. A general election having taken place in the autumn of the same year, he stood for the university of Cambridge; but he was at the bottom of the poll. Through the influence, however, of the Duke of Rutland, he obtained a seat in parliament as member for Appleby. Lord North was now prime-minister. The Opposition consisted of two parties; one being led by Rockingham and Fox, the other by Lord Shelburne. The latter consisted chiefly of the old followers of Chatham; and to this party Pitt naturally became attached. On 26th February 1781, he made his first speech in parliament. It was in favour of Burke's plan of economical reform, and was a splendid success. 'It is not a chip of the old block,' said Burke; 'it is the old block himself.' Shortly before the meeting of parliament, in the autumn of 1781, the news arrived of the surrender of Cornwallis and his army. In the debate on the address, P. spoke with even more energy and brilliancy than on any former occasion. No one was so loud in eulogy as Henry Dundas, Lord Advocate for Scotland; and from this night dates a connection between him and P., which was only broken by death. After several defeats, the ministry resigned, and Rockingham was called on to construct a cabinet. P. was offered the vice-treasurership of Ireland; but he declined to accept a position which did not confer a seat in the cabinet. On 7th May 1782, he made his first motion for a reform in the representation of the people; which motion was lost by only 20 votes in a house of more than 300 members. The reformers never again had so good a division till 1831. At the end of three months after his accession to office, Rockingham died; Lord Shelburne succeeded to the head of the treasury; and P., at the age of 23, became Chancellor of the Exchequer. In opposition to the government, there was then formed a coalition emphatically known as 'The Coalition.' On Lord Shelburne's resignation in 1783, the king himself, who hated the Coalition, tried to persuade P. to take the helm of affairs; but he resolutely declined. The Duke of Portland succeeded, with Fox and North as Secretaries of State. P., from the Opposition benches, brought for a second time the question of parliamentary reform before the House. His motion was lost by 293 votes to 149. On the prorogation, he visited the continent for the first and last time. In 1783, the ministry having been defeated on a motion for transferring the government of India to parliament, P. became First Lord of the Treasury and Chancellor of the Exchequer. But parliament was dead against him: between 17th December 1783 and 8th March 1784, he was beaten in sixteen divisions. The nation, however, was in his favour; both on account of his policy, and from admiration of his private character. Pecuniary disinterestedness is what all can comprehend; and even when known to be overwhelmed with debt, when millions were passing through his hands, when the greatest men in the land were soliciting him for honours, no one ever dared to accuse him of touching unlawful gain. At the general election in 1784, 160 supporters of the Coalition lost their seats, P. himself heading the poll for the university of Cambridge. He was now, at 25 years old, the most powerful subject that England had seen for many generations. He ruled absolutely over the cabinet, and was at once the

favourite of the sovereign, of the parliament, and of the nation; and from this date, the life of P. becomes the history of England and of the world. For seventeen eventful years, he held his great position without a break. In 1784, he established a new constitution for the East India Company. In 1786, he carried through a commercial treaty with France on liberal principles. In the same year, he established a new sinking fund; a scheme which experience has shewn to be wrong in principle, though it was long viewed with favour by the nation. To exertions which were now begun for the abolition of the slave-trade, he gave the help of his eloquence and power. In 1788—1789, he maintained against Fox the right of parliament to supply the temporary defect of royal authority occasioned by the incapacity of the king. The year 1793 saw the beginning of the great war with France. Authorities differ as to the cause. It is, however, certain that P.'s military administration was eminently unsuccessful. But no disaster could daunt his spirit. When a new French victory, a rebellion in Ireland, a mutiny in the fleet, and a panic in the city had spread dismay through the nation, P. from his place in parliament poured forth the language of inextinguishable hope and inflexible resolution. Disaster abroad was regularly followed by triumph at home, until at last he had no longer an opposition to encounter. In 1799, he effected the union with Ireland. It was part of his scheme to relieve the Roman Catholic laity from civil disabilities, and to grant a public maintenance to their clergy; but the obstinacy of the king frustrated this design. Chagrined by this failure, P. resigned office in 1801. He was succeeded by Mr Addington, to whom for a while he gave his support. In 1804, he returned again to the head of the treasury, which position he continued to hold till his death on 23d January 1806. This event was doubtless hastened by the stupendous success of Napoleon. The peculiar look which he wore during the last days of his life was pathetically termed by Wilberforce 'the Austerlitz look.' The impeachment also of his friend, Lord Melville, is supposed greatly to have hastened his end. It gave him, he said in parliament, a deep pang. His voice quivered as he uttered the word; and it seemed as if the man of iron were about to shed tears. 'He was,' says Macaulay, 'a minister of great talents, honest intentions, and liberal opinions, . . . but unequal to surprising and terrible emergencies, and liable in such emergencies to err grievously, both on the side of weakness and on the side of violence.' But what man ever lived, we may ask, who, placed in such circumstances as P., would not often have greatly erred? His policy was liberal beyond his age, at least he wished it to be so, although he was often obliged to yield to the prejudices of his sovereign. He resigned office because he could not carry Catholic emancipation. He laid before the king unanswerable reasons for abolishing the Test Act. He was more deeply imbued with the doctrines of free-trade than either Fox or Grey. It cannot indeed be denied that he was addicted to port-wine, and that he died overwhelmed with debts; parliament voting £40,000 to his creditors. High as his character stands, it would have stood even higher had he united the virtue of frugality to that of disinterestedness. See *Life of Pitt* by Lord Stanhope (Lond. 1861); also Lord Macaulay's *Biographies* (Edin. 1860). In the former work, vol. ii., p. 185, will be found a valuable criticism on Macaulay's memoir.

**PITTACUS**, one of the 'Seven Wise Men' of ancient Greece, was born at Mitylene, in the island of Lesbos, about the middle of the 7th c. B.C. The

incidents of his life do not perhaps rest on a very secure historical basis, but he is by no means to be regarded as a merely traditional personage. We may feel quite certain that his career and character were substantially what later history represents them. About 612 B.C., in conjunction with the brothers of Alceus the poet, he overthrew the 'tyrant' Melanchrus, and put him to death. He next figures in the contest between the Lesbians and the Athenians for the possession of Sigeum in the Troad, and displayed as much valour on the battle-field as Alceus did cowardice. His townsmen, the Mityleneans, were so pleased with his deeds of prowess, that they gave him a portion of the city-territory, which he dedicated to sacred use, and which was known long after as the 'Pittaceian land.' Meanwhile, the civic struggles did not cease; the democratic party, however, roughly represented by a series of popular 'tyrants,' were in the ascendant, and the oligarchic aristocrats, at the head of whom was Alceus, were finally banished. P. was subsequently chosen dictator, 589 B.C., to prevent the turbulent exiles from returning to Mitylene, and ruled absolutely with great success for ten years, after which he voluntarily resigned his power, and withdrew into honoured retirement. He died in 569 B.C. Many of the anecdotes preserved by tradition concerning P. are probably apocryphal; but they all attribute to him the same characteristics—great moral sagacity, a contempt of outward pomp, and a plain practical understanding. His favourite maxim, *Gnôthi Kairôn* ('Know the fitting moment'), may be recommended to all statesmen and politicians. To P. is also ascribed the saying which has so often been verified in actual history, *Chalepôn esthôn emmenai* ('It is a misfortune to be eminent'). Of his 600 didactic verses, only four are extant, and these prove that he was strongly impressed with the falsehood and insincerity of men. See Schneidewin's *Delectus Poesis Græcorum Elegiacæ*, &c. (Gott. 1839.)

**PITOSPORA'CEÆ**, a natural order of exogenous plants, allied to *Vitaceæ* (the Vine, &c.), and containing nearly 100 known species of trees and shrubs, chiefly Australian, although a few are natives of different parts of Asia, Africa, and the islands of the Pacific. To this order belongs the genus *Billardiera* (q. v.). The genus *Sollya* also deserves notice, as containing some of our most beautiful green-house climbers.

**PITTSBURG**, a city of Pennsylvania, U.S. of America, at the confluence of the Alleghany and Monongahela rivers, at the head of the Ohio, lat. 40° 26' 34" N., long. 80° 2' 38" W. It is situated among some of the richest deposits of bituminous coal and iron in America, supplying coal to the extent of 1,600,000 tons a year to the whole Mississippi Valley, and having 65 mining companies, 23 iron and steel works, 16 foundries, extensive machine-shops, manufactures of steam-boilers, engines, nails, spikes, rivets, files, wire, foundries for cannon, &c. There are also copper-smelting and rolling mills, 6 cotton-mills, white-lead and glass works. The numerous foundries and factories fill the atmosphere with smoke, and have given P. the name of the Birmingham of America. It is connected by steamboats with the whole Mississippi Valley, and by railways and canals with Philadelphia and Cleveland. Among its public buildings are a fine court-house, the largest Roman Catholic cathedral in the country, 115 churches, railway, aqueduct, and other bridges, United States arsenal, schools and colleges, western state penitentiary, &c. There are 10 or 12 newspapers, 2 German. P. occupies the site of Fort Pitt, and the older French

Fort Duquesne, in an expedition against which, the British general, Braddock, was defeated in 1755, by an allied force of French and Indians. It was taken, on a third attempt, by General Forbes in 1758. The city was chartered in 1816; in 1845, it was nearly destroyed by fire. The population in 1840 was 21,115; in 1860, 49,220; or, including the towns which cluster around it, 115,000.

**PITTSFIELD**, a village in Massachusetts, U.S. of America, on the Western Railway, 151 miles west of Boston, and the terminus of the Housatonic and Pittsfield Railway. It has two cotton and nine woollen factories, various manufactories, the Berkshire Medical College, two banks, nine churches, &c. Pop. (1860) 8045.

**PITUITARY BODY**, a small reddish-gray mass of an oval form, weighing from six to ten grains, and situated on the sella turcica of the sphenoid bone, on the floor of the cavity of the skull. It is very vascular, and in its structure it resembles the ductless glands. In the fœtus, it is relatively larger than in the adult, and contains a cavity which subsequently disappears. It derives its name from its having been formerly supposed to secrete the fluid which (as we now know) is yielded by the Schneiderian or pituitary membrane of the nostrils. Its function is not known.

**PITYRIASIS** (from the Greek word *pityron*, bran) is the term given to one of the squamous or scaly diseases of the skin, in which there is a continual throwing off of bran-like scales of epidermis, which are renewed as fast as they are lost. It may occur upon any part of the body, giving rise to brown patches, in which there are sensations of itching, tingling, or pricking. It is more easily cured than the other scaly diseases, and its removal can generally be effected by the frequent use of the warm bath; or, if it fails, recourse may be had to alkaline or sulphur baths; due attention being at the same time paid to the general health. It sometimes occurs on the scalp, when it is known as *dandruff*, and must be treated with weak alkaline lotions, or, if these fail, with tar ointment, provided there is no inflammation. There is a variety known as *Pityriasis versicolor*, which is probably due to the presence of a parasitic fungus, the *Microsporon furfurans*; but whether the fungus is the positive cause of the disease, or only an attendant on it, finding a suitable *nidus* in the diseased epidermis, is not certain. This variety may be detected by a microscopic examination of the exfoliated scales, when the spores and filaments of the fungus will be detected. The treatment of this affection must be solely local. Dr Watson mentions a case which yielded at once to a couple of sulphur baths. Probably the best remedy is the application of a saturated watery solution of sulphurous acid gas, or of one of the sulphites dissolved in diluted vinegar.

**PIÙ** (in Ital. more), as a musical term, when prefixed to another word, intensifies its meaning—e. g., *più mosso*, with more movement.

**PIUS**, the name of nine among the Roman pontiffs, of whom the following only appear to call for particular notice.—**PIUS II.**, originally known as Æneas Sylvius, was a member of the noble family of Piccolomini, and was born (1405) at Corsignano, in the duchy of Siena. His early life was not free from serious irregularities, but he made amends by his subsequent decorous conduct; and his eminent abilities as a canonist led to his being employed, when but 26 years of age, as secretary of the Cardinal of Fermo, in a post of the highest confidence at the council of Basel (q. v.). He was intrusted by that council—the views of which, in its conflict with the pope, he fully shared—

in several commissions of great importance; and on the election of the antipope, Felix V., Æneas Sylvius was chosen as his secretary. But having been sent by him as ambassador to the Emperor Frederick III., he was induced to accept office in the imperial court, and served on several embassies and other missions of importance on behalf of the emperor. In the difficulties between Frederick and the Pope Eugenius IV., which arose after the council of Florence, Æneas conducted so skilfully a negotiation with which he was intrusted, that the pope was induced to retain him in his own court, in the capacity of secretary. His views of church matters having undergone a considerable change, he continued in equal favour under the successor of Eugenius, Nicholas V., 1447; and under Callistus III., he was elevated to the cardinalate. On the death of Callistus in 1458, he was elected pope, and took the name of Pius II. His pontificate was embarrassed by some contests on German affairs, but it is chiefly rendered memorable by the sustained efforts which P.—the first in this policy of a long line of pontiffs, to whom the public security of Europe owes a deep obligation—made to organise an armed confederation of Christian princes to resist the progress of the Turkish arms. This organisation, however, for a long time did not lead to any considerable results. P. died, August 14, 1464. The literary reputation of the scholar, Æneas Sylvius, has partially eclipsed the historical fame of the Pope Pius. He was one of the most eminent scholars of his age. His works were published at Basel (1 vol. fol., 1551), but many of his works are not included in that edition. They consist chiefly of histories, or historical dissertations and materials of history; but the most interesting portion of his collected works are his letters, which are very numerous, and full of details, characteristic as well of the writer as of the age. The same may be said of a biographical commentary, which is in truth an autobiography, being chiefly written from his own dictation, by his secretary, John Gobellinus, published at Frankfurt in 1614. See Voight's *Life of Pius* (Berl. 1856).—**PIUS IV.**, Giovanni Angelo Medici, uncle of Saint Carlo Borromeo, deserves to be noticed from his connection with the celebrated creed known under his name. He was elected in 1560; and his pontificate is chiefly memorable as that in which the protracted deliberations of the Council of Trent (q. v.) were brought to a close. P. had the duty, in December 1563, of issuing the bull confirmatory of its decrees. The well-known creed called the Creed of Pius IV., and sometimes the Tridentine Creed, was issued by P. IV. as an embodiment of all the doctrines defined in that council. P. died, December 8, 1565, in the arms of his nephew, Carlo Borromeo.—**PIUS V.**, a saint of the Roman Catholic Church, originally named Michele Ghislieri, was born of poor parents, in the village of Bosco, near Alessandria, in 1504, and at the age of fourteen, entered the Dominican order. His eminent merits were recognised by Paul IV., who named him Bishop of Satri, in 1556, and cardinal in the following year. Of austere and mortified habits, he carried into his administration the same rigour which distinguished his personal conduct; and when appointed inquisitor-general for Lombardy, he employed the most rigorous measures in repressing the progress of the Reformation, which had begun to effect an entrance. He was afterwards translated to the see of Mondovì; and immediately after the death of Pius IV., he was chosen unanimously as his successor, January 8, 1566. P. carried into his pontifical life the same personal austerity and administrative rigour which he had evinced as a bishop. Applying to others the same

rules which he enforced upon himself, he enacted a number of severe laws for the regulation of public morals, prohibiting bull-fights, suppressing prostitution, and proscribing a variety of popular but demoralising exhibitions. The Roman Inquisition, too, under his government, exercised a severity of which no other pontificate has shewn any example. He endeavoured to enforce everywhere the disciplinary decrees of the Council of Trent; and the whole spirit of his pontificate is most strikingly exhibited in the decree by which he ordered the yearly publication of the celebrated bull, *In Cæna Domini* (q. v.). It was an application to the 16th c. of the principles and the legislation of the Hildebrandine epoch. But the most momentous event of the pontificate of P. was the expedition which he organised, with Spain and Venice, against the Turks, and which resulted in the great naval engagement of the Gulf of Lepanto, on 7th October 1571. P. died in the following May, 1572. He was canonised by Clement XI. in 1712.—PIUS VI., originally named Angelo Braschi, was born at Cesena, December 27, 1717. He was selected by Benedict XIV. as his secretary; and under Clement XIII., he was named to several important appointments, which led finally, under Clement XIV., to his elevation to the cardinalate. On the death of Clement XIV., Cardinal Braschi was chosen to succeed him, February 15, 1775. The conflict with the civil power in the various states of Europe, in which, from the days of Innocent XI., the Roman see had been almost unceasingly involved to a greater or less degree, assumed under P. what may be called its complete and scientific development. His relations to the Emperor Joseph of Austria and the Grand Duke Leopold of Tuscany, who persisted in the reformation of the religious orders, &c., were far from amicable. The internal administration of P., however, was enlightened and judicious. To him, Rome owes the drainage of the Pontine Marsh, the improvement of the port of Ancona, the completion of the church of St Peter's, the foundation of the new Museum of the Vatican, and the general improvement and embellishment of the city. These and other similar projects were interrupted by the outbreak of the French Revolution. In 1793, a popular tumult at Rome, which was caused by the imprudence of a French political agent named De Basseville, and which resulted in his death, gave the French Directory an opportunity of hostile demonstrations against the pope. In 1796, Bonaparte took possession of the Legations, and afterwards of the March of Ancona, and by a threatened advance upon Rome, extorted from P., in the Treaty of Tolentino, the surrender of these provinces to the Cisalpine Republic, together with a heavy war contribution. The year 1797 was marked by a continuance of the same vexatious measures; and at length the Directory ordered the invasion of Rome; Berthier entered the city, February 10, 1798, and took possession of the castle of St Angelo. P. was called on to renounce his temporal sovereignty, and on his refusal, was seized, February 20, and carried away to Siena, and afterwards to the celebrated Certosa, or Carthusian monastery, of Florence. On the threatened advance of the Austro-Russian army in the following year, he was transferred to Grenoble, and finally to Valence on the Rhone, where, worn out by age and by the rigour of confinement, he died in August 1799, in the 82d year of his age and the 24th of his pontificate.—PIUS VII., originally Gregory Barnabas Chiaramonte, was born at Cesena in 1742. He entered the Benedictine order at an early age, and was employed in teaching philosophy and theology at Parma, and afterwards at Rome. He was appointed Bishop of Tivoli; and afterwards, being

created cardinal, was translated to the see of Imola. After the death of Pius VI., Cardinal Chiaramonte was chosen his successor (March 14, 1800). Rome, which, up to this time, had been in the occupation of the French, was now restored to the papal authority, and in the July of that year, P. VII. entered into his capital; and in the following year, the French troops were definitively withdrawn from the papal territory, with the exception of the Legations. From this time forward, P., ably seconded by his secretary of state, Cardinal Consalvi, was destined to occupy a prominent place in the political as well as the ecclesiastical affairs of Europe. Bonaparte had resolved to restore religion in France on the ancient basis of connection with Rome. With this view, he entered into negotiations with P. VII. for the establishment of a concordat suited to the new order of things which had arisen. These negotiations were conducted at Paris, and were attended with many difficulties and delays, until at length Cardinal Consalvi repaired in person to the conference, and, by his energy and decision, disentangled the complicated embarrassments in which it was involved. It was agreed to at Paris, July 15, 1801; ratified in Rome, August 14; and published in Notre-Dame on Easter Sunday 1802. But simultaneously with the concordat, and as if forming part of the same arrangement, was published a code of what were called 'Organic Laws,' seriously affecting the discipline of the church on marriage, on the clergy, and on public worship, which had never been submitted to P., and to which he not only had not consented, but to which he found himself compelled to offer every opposition. For the first year which succeeded the publication of the concordat, no occasion of difficulty arose; but conflict of principles was in the end inevitable. In 1804, Bonaparte having resolved on assuming the imperial crown, invited P. to come to Paris for the purpose of crowning him, and the pope, although with much hesitation, consented. He took advantage of his visit to demand the recall or modification of the articles, but without success; and although, during his visit to Paris, he was treated with great distinction and reverence, his relations with Napoleon from that date began to assume a less friendly character. The French emperor now proceeded from one petty outrage to another, until finally, in February 1808, the French troops, under General Miollis, entered Rome, and took possession of the castle of St Angelo; and on the 2d of April, a decree was issued annexing the provinces of Ancona, Fermo, Urbino, and Macerata to the kingdom of Italy. P., besides protesting against the usurpation, declared himself a prisoner in the French hands, and confined himself to his palace. The papers of the cardinal secretary were violently seized, and the pope was compelled to appoint a pro-secretary; and finally (May 17, 1809), the usurpation was consummated by a decree annexing Rome and all the remaining papal territory to the French empire. This was the signal for the pope abandoning his lengthened policy of forbearance. On June 10, P. issued a bull of excommunication, directed (without naming Napoleon) against the perpetrators and abettors of the invasion of the rights and the territory of the holy see. Soon afterwards, the French general ordered the removal of the pope from Rome; and P., without offering any resistance beyond the declaration that he yielded to force, was removed, first to Florence, then to Grenoble, thence for a longer time to Savona, whence, in June 1812, he was finally transferred to Fontainebleau. During this prolonged captivity, P. firmly but quietly resisted every effort to compel or seduce him from his policy. At



Fontainebleau, he was treated with much external respect; and on Napoleon's return from the Russian campaign, in December 1812, orders were given that the cardinals, with certain exceptions, should be admitted to the presence of the pope. Under much pressure, both from the emperor himself—who is alleged by some to have acted with great rudeness, and even with personal violence—and from the ecclesiastics to whom the emperor confided his plans, P. was induced to sign a new concordat, an important provision of which was the recognition of the annexation of the Roman states to the empire. Having obtained the concession, Napoleon at once permitted the absent cardinals to return, and of these many remonstrated so earnestly against the concordat, that, on March 24, P. wrote to revoke his consent. Napoleon took no notice of the revocation; nor was it till after the disasters of 1813 that he began to seek an accommodation. P. refused to treat until he should be restored to Rome; and on January 22, 1814, orders were sent for his immediate return to his capital. Unattended by his cardinals, he was escorted to Italy, and remained at Cesena until the fatal campaign of the spring of 1814 placed Paris in the hands of the allies, when P. re-entered Rome amidst the gratulations of the people on May 24, 1814—a day since that time held sacred in the Roman calendar. During the Hundred Days, he was again compelled to leave Rome; but after the campaign of Waterloo, he finally resumed possession, which was undisturbed for the rest of his life, and which extended to the whole of the ancient territory, including the Legations.

The last years of his pontificate were devoted to measures of internal administration; and under the enlightened government of Cardinal Consalvi, were marked by much wisdom and moderation. But the administration chiefly by ecclesiastics and the secrecy of law procedure were resumed. P. repressed, too, with great vigour the disorder and brigandage which the long wars had introduced, and a whole village of notorious and incorrigible criminality, that of Somma, was razed to the ground in 1819. He was equally vigorous in repressing secret societies, especially that of the Carbonari (q. v.). The ecclesiastical measures of his later period were also of much importance. In 1814, he formally restored the suppressed order of the Jesuits (q. v.). In 1817 and the following years, he concluded concordats with Naples, with Prussia, Würtemberg, and other courts of Germany. In this and every other period of his life, P. was a model of gentleness, simplicity, benevolence, and Christian charity. In July 1823, having reached the patriarchal age of 81, he fell accidentally in his own apartments, and broke his thigh. Under the inflammation which ensued, he sunk gradually, and died August 20, 1823.

PIUS IX., GIOVANNI MARIA MASTAI FERRETTI, the reigning pontiff, was born at Sinigaglia, May 13, 1792. He was originally destined for the military profession, and was sent to Rome to enter the Noble Guard; but symptoms of an epileptic tendency led to his abandoning his intended profession, and entering an ecclesiastical seminary. He received holy orders, and for a time exercised his ministry in connection with several works of charity and benevolence in Rome; but was sent to South America as 'auditor' of Monsignor Mugé, the vicar-apostolic of Chili. On his return, he became domestic prelate of Leo XII., and President of the Ospizio of San Michele; and in 1829 he was named Archbishop of Spoleto, whence he was translated to Imola. He was soon afterwards sent to Naples as nuncio; and in 1840, was named cardinal, from which date

he continued to reside in his see. On the death of Gregory XVI. in 1846, Cardinal Mastai Ferretti was elected by acclamation to succeed him; and having learned, by long intercourse with the people of the Legations, the prevalence and the causes of discontent—which had been concealed under the repressive system of Gregory, following the direction of the Austrians, by whom a protectorate was exercised—he entered at once on a course of reforms, by which he hoped to establish the papal government on a popular, but yet on a firm basis. He resolved to extirpate all abuses of administration, financial as well as political, to withdraw as far as possible the restrictions of personal liberty, to secularise in many details the local administration, and to extend the rights of self-government as far as was compatible with the essential institutions of the Roman states. His first step to this end was to grant an amnesty; and this measure, however humane and necessary, had the unfortunate result of drawing together into the Roman states a body of men whom an unhappy experience of foreign exile had embittered against the existing order of things, and who had served in foreign revolutions, and, in the secret councils which their position had necessitated, an apprenticeship to the arts of political intrigue. For a time, the reforming policy of P. carried with it the affections of the people; but he soon began to fall short of the expectations which he had created. The outbreak of the revolution of February 1848 precipitated the crisis of popular excitement and of popular discontent. Reform assumed the shape of revolution. In November of that year, Count Rossi, whom the pope had appointed as his minister, was assassinated; and violent demonstrations were daily employed to compel the pope's assent to measures which he repudiated. He was driven to confine himself a close prisoner in the Quirinal; and at length, in December, he fled secretly from Rome and established himself at Gaeta, a Neapolitan seaport, not far beyond the Roman frontier. A republic was proclaimed in Rome, the provisional heads of which proceeded to a complete and radical remodelling of the civil government of the state. P. from his exile addressed a remonstrance to the various sovereigns. In April 1849, a French expedition was sent to Civita Vecchia, which eventually advanced upon Rome, and after a siege of about 30 days took possession of that city, and established a French army of occupation within the Roman state. The pope's government was re-established, but he himself did not return till 1850, when, once again, he entered upon the administration. In consequence of the unsettled condition of Italy and the failure of many of his early measures of improvement, he declared himself unable to proceed with the reformations which he had contemplated. Since that time, his authority has been maintained without interruption; but it has always been believed that the discontent with the government still continues, and that, if the French army were withdrawn, violent changes would be imminent. In consequence of the war for the unification of Italy, the Legations, Ancona, and a considerable part of the papal territory southward in the direction of Rome, have been annexed to the kingdom of Italy, but P. has persistently refused to cede any portion or to enter into any compromise. His ecclesiastical administration has been very active, and has proceeded upon the strongest assumption of the right of independent action on the part of the church. In this view, he re-established the hierarchy in England, he sanctioned the establishment in Ireland of a Catholic university, and condemned the principles upon which the Queen's Colleges in that country were

constituted. He concluded with Austria a concordat much more favourable to church authority than the existing ecclesiastical laws had permitted. In 1854, he issued a decree propounding as a doctrine of the church the faith of the Immaculate Conception of the Blessed Virgin Mary (q. v.). In the internal administration of his states, notwithstanding the embarrassed condition of finances produced by the curtailment of his territory, he has introduced many ameliorations, and has done much for the advancement and improvement of the city of Rome and of its institutions. In this he has been aided by the voluntary contributions of the several churches, as well in special gifts as in the organisation of the permanent tribute called Peter-pence (q. v.). His health has for some years been precarious; but with the exception of occasional interruptions, he continues (1864) to attend personally to all the public affairs, civil as well as ecclesiastical, of his government.

**PIVOT**, the point on which a body revolves, has a like signification in military affairs—the pivot-man being that soldier who marks the centre while a line is wheeling.

**PIYĀDASI**, one of the names of the celebrated King As'oka. See **BUDDHISM, INDIA**. He is often designated by this name in inscriptions.

**PIZARRO, FRANCISCO**, the conqueror of Peru, was an illegitimate son of Gonzalo Pizarro, a colonel of infantry, and a soldier of some distinction. He was born at Truxillo, in Estremadura, Spain, about 1471. Of his youth, little is known, but it appears that he was wholly neglected by his parents, was taught neither to read nor write, and that in his youth his principal occupation was that of a swineherd. Abandoning this uncongenial employment, he sought the port of Seville, and there embarked, to seek fortune in the New World. He was in Hispaniola in 1510; later, he joined Balboa, and was with that cavalier when he crossed the Isthmus of Panama, and discovered the Pacific. In 1515, he was engaged in traffic with the natives on the shores of the newly-discovered ocean, but was afterwards chiefly employed in military service, in which he shewed great bravery, resource, and power of endurance. About this time, when a fresh and powerful impulse was given to adventure by the splendid achievement of Cortes, rumours of a country far south, in which gold and silver were said to be as abundant as iron in Spain, reached Panama, and kindled P.'s ambition. He formed a sort of copartnership with Diego de Almagro, an adventurer and a foundling like himself, and Hernando Luque, an ecclesiastic; and with the funds which the three friends amassed, they were enabled to fit out a small expedition, of which P. took command. In November 1524, he set sail southward, but went no further than Quemada Point. Making an agreement (dated March 10, 1526), that all lands, treasures, vassals, &c., that should be discovered, were to be equally divided between them, the three friends, P., Almagro, and Luque, organised a second expedition, consisting of two ships, which set sail for the South Sea. Having reached the port of Santa, in lat. about 9° S., and having really discovered Peru, P. returned to Panama, carrying with him, however, many beautiful and valuable ornaments in gold and silver, which he had obtained from the friendly and generous natives, as well as specimens of woollen cloths of silky texture and brilliant hue, and some llamas or alpacas. Unable to find in Panama a sufficient number of volunteers for the invasion of the newly-discovered country, the indomitable adventurer returned to Spain in 1528, narrated the story of his discoveries

before Charles V. and his ministers, described the wealth of the territories, and shewed, as proof, the gold ornaments and utensils, the manufactures, &c., which he had brought with him. The result of his representations was, that the right of the discovery and conquest of Peru was secured to him, and honourable titles—among others, those of Governor and Captain-general of Peru—were conferred on him. On his side, he agreed to raise a certain number of followers, and to send to the crown of Spain a fifth of all the treasures he should obtain. Returning to Panama, he set sail for Peru for the third and last time, with a well-equipped but small force, the number being not more than 180 men, of whom 27 were cavalry. The chief events of the conquest of Peru are detailed at sufficient length in the article **PERU**, and also the articles **ALMAGRO** and **ATAHU-ALPA**. Within ten years, the great *conquistador* made the empire of Peru his own; but he who had surmounted so many stupendous difficulties, who had broken through the lofty barrier of the Andes, and, with his group of followers, been a victor in so many fields, fell a victim to a conspiracy, June 26, 1541.

P. was a soldier of the most undoubted courage, inflexible constancy of purpose, and infinite resource; yet his success in Peru appears to have been more the result of chance than of calculation. His boldest stroke was the seizure of the Inca Atahualpa (q. v.), when surrounded by thousands of his followers; but in doing so, he deserved credit neither for originality nor policy, because the idea was borrowed from Cortes, and the step itself was so foolhardy and desperate, that its success can be regarded only as luck. Although on many occasions he appears to have been guided by noble and generous impulses, he was eminently selfish, perfidious, and relentless. His conquest of Peru is a drama in every act of which there is bloodshed; but the drama is at least consistent to the end. P. lived a life of violence, and died a violent and bloody death.

**PIZARRO, GONZALO**, threw in his fortunes with those of his brother Francisco, on the occasion when that leader returned to Spain in 1528. He was, like the great conqueror, illegitimate. He became a soldier at an early age, distinguished himself, before he joined his brother's expedition, by his skill in martial exercises, and when he reached Peru, was esteemed the best lance in the Spanish troop. The territory of Quito was assigned to him by Francisco, and he was enjoined to undertake an exploring expedition to the east, where a land, reputed to be extremely rich in spices, was said to lie. At the head of 350 Spaniards and a great concourse of Indians, P. set out on his famous journey in the beginning of 1540. Marching east, they reached a country traversed by lofty branches of the Andes. Here the icy winds benumbed the limbs of the adventurers as they rose to the higher plateaux, and, rendered helpless by the cold, many of them sank and died. Descending the eastern slopes of the Andes, they reached the 'Land of Cinnamon;' but as they could not transport the trees across the mountains, their discovery was almost valueless. Hearing of a land abounding in gold at the distance of ten days' journey, the leader resolved to reach it. Pushing forward, the Spaniards entered great forests, where often they had to hew a passage with their axes. Their clothes were now torn to shreds, and their provisions had been long exhausted. They killed and ate the dogs they had brought with them, after which they lived on the herbs and dangerous roots of the forest. At length they struck the broad but desolate waters of the Napo, an important affluent of the Amazon. On the surface of this broad river,

no vessel floated, and it ran amid gloomy woods, the silence of which was undisturbed save by the sound of the rushing waters. Here P. caused a rude bark to be constructed for the transport of the baggage and of the weaker travellers. Francisco de Orellana was intrusted with the command of the vessel. P., hearing of a populous nation at the distance of a few days' journey, who dwelt near the confluence of the Napo with a larger river, sent forward Orellana to obtain and bring back supplies for the starving travellers, who had eaten the last of their horses, and were now reduced to the leather of their saddles and belts. Orellana reached the Amazon; but, unable either to obtain supplies, or to return against the current of the river, abandoned the expedition, and with his fifty followers resolved to sail down the Amazon, reach the Atlantic, and make for Spain. This wonderful design was successfully carried out. P., after waiting in vain for the return of the barque, resolved to return to Quito, which, after enduring terrible sufferings, and seeking fruitlessly for the rich regions of which he had heard so much, he reached in June 1542, after an absence of more than two years. The fatal character of this expedition may be inferred from the appearance the travellers presented on their return. Half of the 4000 Indians had perished, and of the Spaniards, only eighty remained; and these, clad in skins, blackened by the sun, and wasted by hunger and fatigue, with long matted locks, seemed like a troop of spectral savages. This expedition stands unmatched in the annals of American discovery for its dangers and sufferings, for the length of their duration, and for the heroic fortitude with which they were endured. For the fate of Gonzalo P., see article PERU.

**PIZZICATO** (Ital. twitched), abbreviated *pizz.*, a phrase used in Music for the violin or violoncello, to denote that the strings, instead of being played as usual by the bow, are to be twitched with the fingers in the manner of a harp or guitar. The pizzicato is much used in accompaniments, as sounds thus produced do not cover the voice; it is also used in symphonic effects. The ordinary mode of playing is restored by the letters *c. a.* (*col arco*, with the bow).

**PLACENTA**, or **AFTER-BIRTH**, a temporary organ that is developed within the uterus during pregnancy, and is, as its popular name implies, expelled from the maternal organism shortly after the birth of the child or young animal. It is a spongy vascular mass, existing in some form or other in all mammals, excepting the *Marsupialia* and *Monotremata*, as an appendage to the foetal membrane called the *chorion*. In the human subject (fig. 1), it is of considerable size at the period of delivery, being of a rounded or oval form, with a diameter of 6 or 8 inches, and a thickness of somewhat more than an inch. Its outer surface, which, till the period of its detachment and expulsion, is attached to the walls of the uterus, is uniform and level (unless it has been morbidly adherent), being covered by a membrane, shortly to be noticed, called the *decidua serotina*; and on peeling off this membrane, the various lobes of which the placenta is composed are apparent. The internal or free surface is smooth and shining, and gives attachment to the umbilical cord or navel-string, which connects it with the foetus. To render the mode of formation of the placenta clear, we must premise that the impregnated ovum, when it reaches the uterus, is invested with an outer membrane, the *chorion*, which forms a shut sac, externally covered with short villi. As the ovum advances in age, these villi diminish in number, until few remain,

except at that part of the chorion which is in contact with the uterus; and here, about the second month (in the human subject), they divide into branches, as shewn in fig. 2. While these changes are going on in the membrane of the ovum, the uterus is also undergoing modification; and it is on the nature and extent of these uterine changes that the character or type of the placenta depends.



Fig. 1.—Human Placenta (half of it being split in two) and Umbilical Cord.

There are two such types, the first of which is best represented by the human placenta, and the latter by that of the pig.

In animals exhibiting the first type of placental structure, the mucous membrane lining the uterus

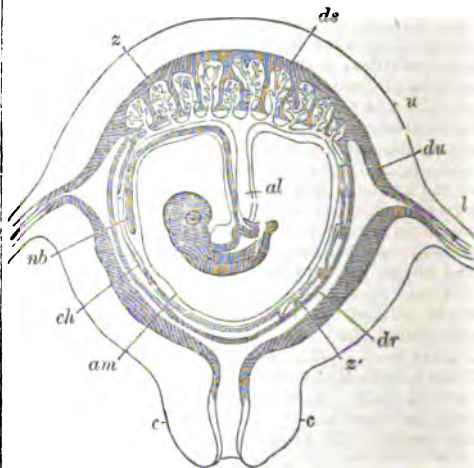

Fig. 2.—Diagrammatic Section of a Human Pregnant Uterus, with the contained Ovum:

*u*, uterus; *l*, oviduct (or Fallopian tube); *c*, cervix uteri (or neck of the womb); *du*, decidua uteri; *dr*, decidua reflexa; *ds*, decidua serotina; *ch*, chorion; *am*, amnion; *al*, allantois; *nb*, umbilical vesicle; *z*, villi, which form the foetal part of the placenta; *s*, villi over the rest of the chorion, which, in the human subject, take no part in the placental function.

undergoes a rapid growth and modification of texture, becoming connected with the *membrana decidua*, which is so called from its being thrown off at each parturition. For brevity, it is usually termed the *decidua*. This decidua is from an early period separable into three portions—the *decidua*

## PLACENTA.

*vera*, or *decidua uteri*, which lines the general cavity of the uterus; the *decidua reflexa*, which immediately invests the ovum; and the *decidua serotina*, which is merely a special development of a part of the decidua vera at the part where the villi of the chorion are becoming converted into the fetal portion of the placenta. The arrangement of these layers is distinctly seen in fig. 2. At first, the villi of the chorion lie loosely in the corresponding depressions of the decidua; but subsequently, the fetal and maternal structures (the villi and the decidua vera) become closely united, so as to form one inseparable mass, by the following means: the deeper substance of the uterine mucous membrane in the region of the placenta is traversed by vessels which enlarge into what, in the case of the veins, are termed *sinuses*, dip down between the villi, 'and at last swell round and between them, so that finally the villi are completely bound up or covered by the membrane which constitutes the walls of the vessels, this membrane following the contour of all the villi, and even passing, to a certain extent, over the branches and stems of the tufts.'—Goodsir's *Anatomical and Pathological Observations*, p. 60.

The pure maternal blood is conveyed to the placenta by what are termed, from their tortuous course, 'the curling arteries' of the uterus, and is returned by the large veins termed sinuses. 'The fetal vessels,' says Dr Carpenter, 'being bathed in this blood, as the branchiæ of aquatic animals are in the water that surrounds them, not only enable the fetal blood to exchange its venous character for the arterial, by parting with its carbonic acid to the maternal blood, and receiving oxygen from it, but they also serve as rootlets, by which certain nutritious elements of the maternal blood (probably those composing the liquor sanguinis) are taken into the system of the fœtus. It is probable, too, that the placenta is to be regarded as an excretory organ, serving for the removal, through the maternal blood, of excrementitious matter, whose continued circulation through the blood of the fœtus would be prejudicial to the latter.'—*Human Physiology*, 3d ed. pp. 1013, 1014. Moreover, the recent investigations of Bernard shew that the placenta secretes, like the liver, the saccharine matter known as Glycogen (q. v.), which probably takes part in keeping up the animal heat. The vascular connection between the fœtus and the placenta is effected by the umbilical vein (containing arterial blood) and the two umbilical arteries (containing venous blood), all of which lie in the umbilical cord which connects the Fœtus (q. v.) with the placenta. The placenta may be formed at any point of the uterus, but is most commonly on the left side. Occasionally (in 11 cases out of 600, according to Nægele), it is situated partially or entirely over the mouth of the womb (*os uteri*), in which case dangerous flooding takes place previous to or at the period of labour. This condition is known as *placenta prævia*, and under ordinary management, 'one in three of the mothers are lost, and more than 65 per cent. of the children.'—Churchill, *Theory and Practice of Midwifery*, 3d ed. p. 473. By substituting the detachment and extraction of the placenta for the old method of turning the child *in utero*, Professor Simpson finds that the mortality sinks to one in fourteen of the mothers, but slightly rises (to 69 per cent.) in the case of the children.

Another difficulty in midwifery practice, but far less serious than the preceding, is undue retention of the placenta. In ordinary cases, the average interval between the birth of the child and the expulsion of the after-birth is a quarter of an hour. When the expulsion does not take place within an hour or an hour and a half, the case is regarded as

coming under the head of 'retained placenta.' It occurs in about 1 case in 400, and in these cases is fatal to about one mother in five; the cause of death being hæmorrhage. The principal causes of retention are either imperfect and insufficient, or irregular contraction of the womb, after the birth of the child. In the first of these cases, if the uterus cannot be excited to sufficient action, the placenta must be withdrawn by steady traction or the umbilical cord, and if it fail, extraction by the introduction of the hand (an operation always to be avoided if possible) must be resorted to; in the latter case, manual extraction is commonly necessary. Sometimes, in consequence of inflammatory or other affections of the placenta, there may be adhesion between its outer surface and the inner surface of the womb. This is the most dangerous form of retention, there being usually excessive flooding, and additionally the peril arising from the decomposition of any portion that cannot be removed without undue violence.

The placenta acquires its proper character, in the human subject, during the third month, and it subsequently goes on increasing to the full period of gestation. At about the fourth month, the blood, moving through the enlarged uterine vessels, produces a peculiar murmur, which is known as the *placental bruit*, resembling the sound made by blowing gently over the lip of a wide-mouthed phial, and increasing in intensity and strength as pregnancy (of which it is one of the characteristic signs) advances.

In animals exhibiting the second type of placental structure—as, for example, the pig—the placenta is comparatively simple in its structure. 'No decidua is developed; the elevations and depressions of the unimpregnated uterus simply acquire a greater size and vascularity during pregnancy, and cohere closely with the chorionic villi, which do not become restricted to one spot, but are developed from all parts of the chorion, except its poles, and remain persistent in the broad zone thus formed throughout fetal life. The cohesion of the fetal and maternal placenta, however, is overcome by slight maceration or post-mortem change; and at parturition, the fetal villi are simply drawn out like fingers from a glove, no vascular substance of the mother being thrown off.' Professor Huxley, from whose *Elements of Comparative Anatomy* (1864, p. 103) the preceding extract is borrowed, follows the opinion adopted by De Blainville, Von Baer, Eschricht, Milne-Edwards, Gervais, and Vogt in regarding 'the features of the placenta as affording the best characters which have yet been proposed for classifying the monodelphous [or placental] mammals.' He proposes to apply the term *deciduate* to those animals whose placenta presents the human type, and which throw off a *decidua*; and to term those animals *non-deciduate* in which the placenta is constructed on the same plan as that of the pig. 'Thus,' he observes, 'man; the apes, or so-called *Quadrumana*; the *Insectivora*; the *Cheiroptera*; the *Rodentia*, to which the lowest apes present so many remarkable approximations; and the *Carnivora*, are all as closely connected by their placental structure as they are by their general affinities. With the pig, on the other hand, the ungulate quadrupeds, and the *Cetacea* which have been studied, agree in developing no decidua, or, in other words, in the fact, that no vascular maternal parts are thrown off during parturition. But considerable differences are observed in the details of the disposition of the fetal villi, and of the parts of the uterus which receive them. Thus, in the horse, camel, and *Cetacea*, the villi are scattered as in the pig, and the placenta is said to be *diffuse*; while

PLACENTA—PLACETUM REGIUM.

in almost all true *Ruminants*, the foetal villi are gathered into bundles or cotyledons (fig. 3), which in the sheep are convex, and are received into cups

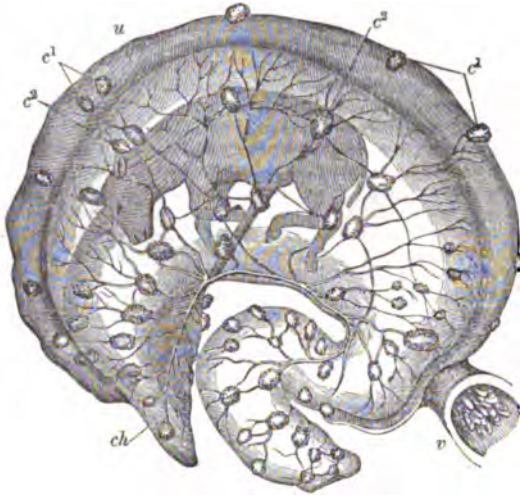

Fig. 3.—Uterus of a Cow in the middle of Pregnancy, laid open :  
v, vagina; u, uterus; ch, chorion; c<sup>1</sup>, uterine cotyledons; c<sup>2</sup>, foetal cotyledons.

of the mucous membrane of the uterus; while in the cow, on the contrary, they are concave, and fit upon corresponding convexities of the uterus.

The remarks which have been made on the functions of the human placenta, are equally applicable to all placental mammals generally.

The *diseases* of the human placenta had not been studied with any accuracy, until the subject was taken up by Professor Simpson. This distinguished physician and subsequent observers have ascertained that the placenta is liable to (1) congestion, ending in the effusion of blood into the substance of the organ upon its surfaces, or between the membranes; (2) Inflammation, giving rise to adhesions, or terminating in suppuration, which may occasion very serious constitutional disturbances; (3) Partial or entire hypertrophy or atrophy; and (4) Fatty degeneration, affecting its small vessels. Whatever be the form of disease by which the placenta is attacked, the result is usually fatal to the foetus.

**PLACENTA**, in Botany, a membrane of the interior of the Germe (q. v.) or ovary, to which the ovules are attached either immediately or by Umbilical Cords (q. v.). The placenta sometimes appears as a mere thickening of the walls of the germe. In many cases, it is a more decided projection from the walls of the germe. When thus connected with the walls of the germe, the placenta are described as *parietal* (Lat. *paries*, a wall). But in some plants, the placenta of the different cells of the germe are united together in a column in its axis, and they are then described as *axile*. This distinction is of great importance as characterising different natural orders. Parietal placenta are formed where the edges of carpellary leaves unite; but great difficulty has been experienced by vegetable physiologists in explaining the formation of axile placenta; some regarding them as also originally formed in this manner, and others as formed in a quite different manner from the axis itself; nor is it impossible that both theories may

be correct as to different orders of plants. It is certain that in many cases in which the placenta appear as axile, they are formed from the edges of the carpellary leaves which fold in to meet in the axis, and form *Dissepiments* (q. v.) between the cells of the germe. The number of placenta corresponds with the number of carpels in the germe, or appears to be the double of it, each carpel producing two rows of ovules instead of one. See figures in article **PISTIL**.

**PLACENZA**. See **PIACENZA**.

**PLACETUM REGIUM**, called also **PLACET**, **EXEQUATUR**, **LETTERES PATENTES**, is an act or instrument executed in virtue of the privilege claimed by the government in certain kingdoms to exercise a supervision over the communications of the Roman pontiff with the clergy and people of those kingdoms, and to suspend or prevent the publication of any brief, bull, or other papal instrument which may appear to contravene the laws of the kingdom, or to compromise the public interest. The early Christian emperors, it is well known, freely stretched their legislation into the affairs of the church; and one constant cause of conflict between church and state, in the medieval period, was the attempt, on the part of the sovereigns, to control the free intercourse of the pope with the several churches. In the Pragmatic Sanction in France, and in the similar legislation of Spain, Portugal, Sicily, and the Low Countries—during the 15th c., the claims of the state on the same head are more than once asserted; and among the so-called 'liberties' of the later Gallican Church was a certain, though not a complete subjection to the state in this particular; but it was in the German states that this claim was most distinctly asserted, and most formally embodied in the constitutional law. The principle upon which the Peace of Westphalia, so far as regards its religious provisions, is based, is that the will of the sovereign of the state is supreme and final in all the concerns of religion. *Cujus regio illius et religio* ('Whose territory, his also the religion'), became the maxim of church government; and, of course, within certain limits, the Catholic sovereigns acted as freely upon it as the Protestant. This intermixture of the spiritual and the temporal prevailed especially in the mixed governments of the ecclesiastical sovereigns of Germany, the prince-bishops of the Rhine; but without the same foundation, the system was carried to its height in Austria under Joseph II. (see **FEBRONIANISM**, **PIUS VI.**), the excessive minuteness of whose ecclesiastical ordinances procured for him the sobriquet of 'The Sacristan.' Under him, all pontifical bulls, briefs, and constitutions, and all the ordinances of the local bishops, were made subject to the imperial censorship, and it was forbidden to publish any of them without its receiving the *placet* of the emperor. The only exception, in the case of pontifical decrees, regarded those emanating from the Roman Penitentiary (q. v.), which, as being of their nature secret, were not held subject to revision. In Prussia, the same law was enforced, as also in Baden and Saxony, no less than in the Protestant governments of Würtemberg, Saxe-Gotha, Saxe-Weimar, &c. These claims of the state had always been the subject of protest on the part of the Roman see, but the church, nevertheless, had been compelled to acquiesce silently in the enforcement. In many cases, however, they have led to serious disputes, of which the mixed-marriage question in Prussia furnished a recent and very

remarkable example. On the whole, nevertheless, the results have involved less of conflict than might have been expected. The general relaxation of absolutist principles in the government, whether of state or of church, which followed the revolution of 1848, has led to very considerable modifications of these regulations in almost all the German states; and in Austria especially, the concordat has involved many important changes in every department of ecclesiastical ordinance.

**PLACOID FISHES**, an order of fishes, in the classification proposed by Agassiz, characterised by having *placoid* (Gr. *plax*, a broad plate) scales, irregular plates of hard bone, not imbricated, but placed near together in the skin. These scales or plates are of considerable size in some fishes, but in others they are very small tubercles, as in the dogfish, of which the skin forms fine-grained

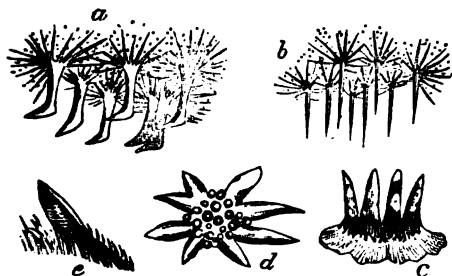

Placoid Scales:

a and b, placoid scales of *Aleuterus trossulus*, one of the Ball-tides, from Australia; c, d, e, scales from different parts of the body of *Aleuterus variabilis*.

shagreen. Agassiz includes among the P. F. those cartilaginous fishes which have no scales. The order is exclusively composed of *Cartilaginous fishes* (q. v.). The existing P. F. are few in comparison with the fossil genera and species. Placoid scales are often elevated in the middle, the centre sometimes rising into a strongly projecting point or spine. They exhibit great variety of forms, sometimes even in different parts of the same fish.

**PLA'GAL**, a musical term, principally applicable to *Canto Fermo* and signifying collateral. Gregory the Great, in revising the labours of Ambrose, and remodelling the Plainsong (q. v.) of the church, added to the scales of Ambrose, which he distinguished as authentic, certain other collateral scales, which he called plagal, possessing the peculiarity of having the octave so divided that the fourth was above the fifth. Melodies are now known as plagal which have their principal notes contained between the fifth of the key and its octave or twelfth. The cadence, consisting of the subdominant harmony followed by the tonic, is called the plagal cadence—

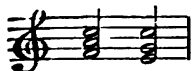

**PLAGIOSTOMI** (Gr. *transverse-mouthed*), an order of fishes, in the system of Müller, containing the cartilaginous fishes with Placoid (q. v.) scales, and divided into two sub-orders, one containing sharks, and the other rays. The P. have five or more gill-openings. They have no air-bladder. Impregnation takes place before the eggs are deposited, and the males are furnished with *claspers*.

**PLAGUE**, a very malignant kind of contagious fever prevailing at certain times and places

epidemicly, characterised by buboes, or swellings of the lymphatic glands, by carbuncles and petechia, and not apparently furnishing any security against its recurrence in the same individual. For a history of the origin of the plague in the far East (China), and its gradual spread, under the name of the *Black Death* (q. v.), through Asia and Europe, in the 14th c., the reader is referred to Hecker's *Epidemics of the Middle Ages* (1844, published by the Sydenham Society). Its true and permanent home seems to be in the regions bordering upon the eastern extremity of the Mediterranean. At different periods of the 15th, 16th, and 17th centuries, it visited Western Europe. It last attacked London and England almost generally in the years 1663—1665; while so late as 1720, it destroyed nearly half the population of Marseille; and seventy years afterwards, prevailed in Russia and Poland, since which time it has been almost unknown in Western Europe. It is now limited chiefly to Egypt, Syria, Anatolia, Greece, and Turkey, occasionally extending northward towards Russia, and westward as far as Malta.

The disease usually commences with a sensation of intense weariness and fatigue, slight shivering, nausea and sickness, confusion of ideas, giddiness, and pain in the loins. These symptoms are rapidly followed by increased mental disturbance, with occasional stupor and delirium, by alternate pallor and flushing of the face, by suffusion of the eyes, and a feeling of intense constriction in the region of the heart. Darting pains are felt in the groins, armpits, and other parts of the body, which are soon followed by enlargements of the lymphatic glands, or *buboes* (which sometimes appear on the first and second day, sometimes not till near the close of the disease, and sometimes are altogether absent), and by the formation of *carbuncles* on various parts of the body. As the disease advances, the tongue becomes dry and brown, while the gums, teeth, and lips are covered with a dark fur; the bowels, at first constipated, become relaxed, the stools being dark, offensive, and sometimes bloody. The power of the will on the muscles is much impaired; and altogether the patient resembles a person under the influence of intoxication. Throughout the disease, there is more or less tendency to faintness; and usually about the second or third day, petechial spots, livid patches like bruises, and dark stripes (called *vibices*), appear upon the skin, especially in severe cases. These discolorations are owing to the extravasation of blood, and are often accompanied with hæmorrhagic discharges from the mucous membranes. In fatal cases, the pulse gradually sinks, the surface becomes cold and clammy, blood oozes from the mucous surfaces, there is coma, or low delirium; and death occurs usually in five or six days, either without a struggle, or preceded by convulsions.

Great difference of opinion exists as to the cause of plague. Some maintain that it is propagated exclusively by a peculiar contagion; others, while admitting its contagious nature, maintain that it may also be spontaneously engendered by endemic or epidemic influences; while others, again, reject the contagion view altogether, and assert that it originates exclusively in local causes or epidemic influences. Of these three views, the great mass of evidence goes to show that the second is the correct one. Whatever may be the cause of the disease, temperature appears to exert a considerable influence over it. In tropical climates, the disease is unknown, and the cold weather of northern climates has been observed to check its ravages. In Europe, it has always been most fatal in the summer and autumn, especially in September. Thus, in the

great plague of London in 1665, the deaths from the plague were, in June, 590; in July, 4129; in August, 20,046; in September, 26,230; in October, 14,373; in November, 3449; while in December, they were less than 1000.

The exact nature of the disease is unknown. A poison whose characters evade all chemical and microscopical examination, is absorbed, and alters at once, or after a short stage of incubation, the composition of the blood and the condition of the tissues.

With respect to treatment, little can be done to arrest the progress of the disease in any individual case. The patient should, if possible, be removed at once from the source of the disease; he should be exposed freely to fresh air; his secretions should be duly regulated, and his strength supported as far as possible. Friction with olive oil has been strongly recommended, but subsequent experience has not confirmed the first reports in its favour. But although treatment is comparatively valueless, much may be done towards guarding against the attacks of the disease. There can be little doubt that it is in consequence of the free external use of cold water, perfect cleanliness, moderate habits of life, and superior ventilation, that European (especially English) residents in the infected cities of the Levant are comparatively exempt from this disease. It is very possible that inunction of the body with olive oil may be (as has been asserted) a useful prophylactic agent, although it fails to cure the disease. It is almost needless to add, that all unnecessary communication with the sick, or contact with clothes or other matter that may have been infected with the poison, should be as much as possible avoided.

**PLAICE** (*Platessa vulgaris*), a species of Flounder (q. v.), much resembling the common flounder, but rather broader in proportion to its length; the upper surface of the body and the fins olive-brown, marked with large bright orange spots; a row of similar spots on the dorsal fin and on the anal fin; no tubercular asperities on any part of the body, but a curved row of bony tubercles on the eye-side of the head. The P. inhabits sandy and muddy banks, not in very deep water, and is very abundant on most parts of the British coasts, as well as on those of continental Europe. Like the common flounder, it often ascends slow rivers to some distance from the sea, and it has even been found to thrive well when transferred to fresh-water ponds. It feeds on worms, molluscs, small crustaceans, and young fishes. It has been known to attain the weight of fifteen pounds, but a P. of seven or eight pounds is accounted large. It is taken both by lines and trawl-nets. It is in considerable esteem for the table, although so plentiful in the British markets, that it is in general very cheap.

**PLAID**, a woollen garment, in the form of a large scarf, to wrap round the body, and used chiefly among the rural population of Scotland. See **TARTAN**.

**PLAIN**, in Geography, is an extensive tract of country which, on the whole, preserves a nearly uniform elevation. When referred to the level of the sea, plains may be distinguished into low plains or lowlands, and elevated plains called plateaux or *Table-lands* (q. v.). Plains differ much in appearance, according to the nature of their soil and climate, from the frightful sandy wastes of Africa, to the luxuriant fertility of the South American silvas. They are occasionally crossed by hills of moderate altitude, which, however, are generally detached, and exhibit no connection with

any neighbouring mountain system. These hills often, as in the North American plains, degenerate into mere undulations, perfectly uniform in structure. The term 'plains' is, in a limited sense, confined to the plains of Western Europe; those of other parts of the world receiving special designations, and differing from each other in many important points; thus, we have the *Steppes* (q. v.) of Eastern Europe and Asia; the *Deserts* (q. v.) of Arabia and Africa; the *Savannahs* (q. v.) and *Prairies* (q. v.) of North America; and the *Llanos* (q. v.), *Pampas* (q. v.), and *Silvas* (q. v.) of South America. The chief plains of Europe are, the country stretching from the foot of the Carpathians in Galicia to the Ural Mountains (including Poland and Russia), the drainage-area of the Danube in Hungary, and the portion of Europe which is bounded by the Elbe, the Harz Mountains, France, and the sea. Plains of comparatively small extent, but presenting the necessary characteristics in perfection, are found in almost all countries.

**PLAINSONG**, or **CANTO FERMO** (Ital.), a name given by the Church of Rome to the ecclesiastical chant. It is an extremely simple melody, admitting only notes of equal value, rarely extending beyond the compass of an octave, and never exceeding nine notes, the staff on which the notes are placed consisting of only four lines. The clefs are C and F. St Ambrose is considered to have been the inventor or systematiser of Plain-song. His labours consisted in selecting from the extremely complicated system of the Greeks a set of scales sufficiently few and simple for a very rude people. During the two centuries succeeding the death of Ambrose, his institutions fell into utter confusion. Gregory the Great revived and perfected them, recasting them into an *Antiphony*, or authorised body of ecclesiastical music, and brought Plain-song into the state in which it is yet used in the Roman church. See **AMBROSIAN CHANT** and **GREGORIAN CHANT**.

**PLAINTIFFF**, in English and Irish Law, is the name given to the person who institutes and maintains a civil action or suit against another, who is called the Defendant. In Scotland, a plaintiff is called a Pursuer. But in both countries, many proceedings and applications of a civil nature are commenced by petition; and hence the party taking the initiative is called the Petitioner.

**PLAN**, a word frequently applied to all kinds of architectural drawings, but which ought to be limited to those which represent the horizontal sections of the various floors of buildings. Plans shew the disposition of the apartments and walls, with the situation of the fireplaces, cupboards, doors, &c.; they, in fact, represent the different stories as they actually appear as seen from above, when the walls are built two or three feet above the level of each floor.

**PLANARIA**, a genus of worms placed by Cuvier among *Entozoa*, although not parasites, but inhabitants of stagnant waters, because of their great resemblance to some of the entozoic parasites, and particularly to flukes. The species are numerous. Some inhabit fresh, and others salt water; they feed on small annelids, molluscs, &c. They are generally found creeping among confervæ, or on the stems of plants. Many of the larger marine species are able to swim freely by flappings of the broad margins of their bodies. The body of a planaria seems to be entirely gelatinous; but M. de Quatrefages has detected under the skin an arrangement of muscular fibres. Two red specks in the fore-part of the body of many species have been supposed to be eyes; but there is no proof of

## PLANE

it. Planariæ are hermaphrodite, but copulate for mutual impregnation. Their power of multiplication by division is very great; if an individual be cut in pieces, each piece continues to live and feel, and 'even if it be the end of the tail, as soon as the first moment of pain and irritation has passed, begins to move in the same direction as that in which the entire animal was advancing, as if the body was actuated throughout by the same impulse; and, moreover, every division, even if it is not more than the eighth or tenth part of the creature, will become complete and perfect in all its organs.'—*Rymer Jones*.

**PLANE**, in Geometry, is a surface without curvature, and the test of it is, that any two points whatever being taken in the surface, the straight line which joins them lies wholly in the surface. When two planes cross or intersect one another, their common section is a straight line; and the inclination of the planes to each other is measured by taking any point in their common section, and drawing from it two straight lines, one in each plane, perpendicular to the common section; the angle contained by these lines is the angle of inclination of the planes. When the angle is a right angle, the planes are perpendicular to each other.

**PLANE** (*Platanus*), a genus of trees, the sole genus of the natural order *Platanaceæ*, regarded by many as a sub-order of *Amentaceæ* (q. v.). The flowers are in globose stalked catkins; the ovary is one-celled, and contains one or two pendulous



Plane Tree (*Platanus orientalis*).

ovules. The species of *P.* are few; natives of temperate climates in the northern hemisphere; tall trees, with smooth whitish bark, which annually scales off in large pieces, and large palmate deciduous leaves. The catkins are small, and curiously placed one above another on the same stalk; they are pendulous, with long stalks, and give plane trees a very peculiar appearance, especially in winter, when they remain after the leaves have fallen.—The **ORIENTAL P.** (*P. orientalis*), a native of Greece and the East, was much admired and planted, both by the Greeks and the Romans, as an ornamental tree; no other tree, indeed, commanding equal admiration; and, for centuries, the youth of Greece assembled under the shade of planes, in the groves of Academus and elsewhere, to receive lessons in philosophy. To this day, the *P.* is generally planted for shade and ornament in

the south of Europe. Many fine trees exist in England, but they were at one time much more numerous, great part having died in the end of last century, probably from some disease similar to the potato disease. The injury often done to the young leaves by late frosts, and the insufficient duration of the summer for the proper ripening of the wood, render the *P.* less suitable for Scotland; yet there is a tree at Gordon Castle 66 feet high. No tree better endures the atmosphere of a large city, and there are no finer trees within the precincts of London than the *P.* trees which are to be seen in some places there. In its native regions the *P.* attains an immense size. One tree, which grows in the meadow of Buyukdere on the banks of the Bosphorus, is 141 feet in circumference at the base—its trunk being apparently formed of several which have grown together—extends its branches 45 feet from the trunk, and is believed to be more than 2000 years old. The wood of the *P.*, when young, is yellowish-white; when old, it is brownish, fine grained, takes a high polish, and is esteemed for cabinet-making. A rich alluvial soil and the vicinity of water are most suitable to this tree.—The **NORTH AMERICAN P.**, or **BURTONWOOD** (*P. occidentalis*), is a very similar tree. It is the largest deciduous tree of the United States, and abounds on the banks of the great rivers of the middle states. Its timber is not very valuable, and is very liable to decay. It is sometimes called the *Cotton Tree*, from the wool which, as in the former species, covers the under side of the young leaves, and which, being cast off, floats about on the wind. A tree of this species on the bank of the Thames, in Chelsea Hospital gardens, is 115 feet high, with a trunk five feet in diameter.—The name *P.*-tree is commonly given in Scotland to the Sycamore (*Acer pseudo-platanus*), which resembles the true planes in its foliage.

**PLANE**, a tool used for rendering the surface of wood smooth and level. It consists of an oblong block of wood or metal (the latter is only just coming into use), with an opening through the centre; this opening is square on the upper side, and is always large enough to admit the cutting instrument; it diminishes down to a mere slit on the under side, merely wide enough to allow the cutting edge of the plane-iron and the shaving of wood which it cuts off to pass through. The form

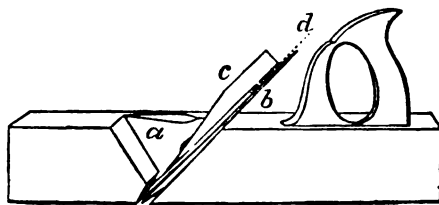
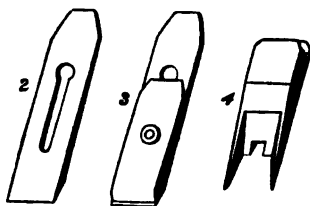

Fig. 1.

of this opening will be seen at *a*, fig. 1, which represents the section of a common jack-plane. The essential part of the tool is the plane-iron, a piece of steel with a chisel-shaped edge, and a slot in its centre for a large headed screw to work and to attach to it a strengthening plate. Fig. 2 shows the plane-iron, and fig. 3 the same with the strengthening plate attached; these are shown in their proper position at *bd* in the section fig. 1, and they are held in place by the hard-wood wedge (fig. 4), seen also in the section at *c*. By driving in the wedge, the irons are held very firmly in their place, and they are so adjusted that only the fine



sharp chisel-edge of the cutting-tool projects through the slit in the bottom of the body of the plane, so that when the tool is pushed forward by the force of the hand, the cutting edge pares off all irregularities, until the wood is as smooth as the under



surface of the plane. There are many modifications in this tool, which can have its cutting edge and under surface made to almost any contour, so that mouldings of all kinds may be made. The two commonest are the jack-plane for rough work, and the smoothing-plane for finishing off plane surfaces.

PLANING-MACHINES have lately been much in use, by which both wood and metal are planed. In the case of those intended for wood, the cutting instruments are moved forward over the wood by machinery in the same manner as in the hand-plane. The precision and rapidity with which these machines work have given great facilities for building, as one machine will do as much work as sixty men. The planing-machines used for metal are different in principle. A well-tempered, chisel-edged steel cutter is held in a fixed position, pressing downwards upon the metal plate, which is moved forward by powerful machinery. The action of this movement is, that a groove is ploughed into the metal of the size of the steel cutter; when the metal has travelled its full length, and has made the groove complete, the downward pressure of the tool is removed, and by the action of the double screw which has carried it forward, it is returned, and readjusted for another groove to be formed by the side of the first; and this is repeated until the whole surface of the plate is reduced to the required level. However tedious this process may appear, it offers such facilities for metal working as were previously unknown.

PLANETA, the Greek name of the vestment called by the Latins *Casula*, and in English 'Chasuble,' which is worn by priests in the celebration of mass. The form of this vestment in the modern Roman church, differs both from the ancient form and from that in use in the Greek church. The change appears to date from the 9th c., but has been gradual. A certain modification of the Roman planets was recently introduced in England under the inspiration of the late Mr Pugin, the great reviver of Gothic architecture and ecclesiastical costume and decoration. But its use has been only partial even in England.

PLANETARIUM, a machine much employed by astronomers in the 17th and 18th centuries, and first constructed by Huyghens and Römer, for the purpose of exhibiting clearly the motion of the heavenly bodies in conformity with the Copernican doctrine. The P. exhibited only the orbital motions of the planets about the sun, either in circles or ellipses, and with constant or varying motions, according to the perfection of the machine. It was subsequently supplemented by the *combined tellurian and lunarian*, which exhibited at one and the same time the motion of the moon about the earth and that of the latter round the sun, with the principal phenomena (such as the succession of day and night, the varying length of each, eclipses, and

the motion of the moon's apogee and nodes) which accompany these motions. A *satellite machine* was also invented to illustrate the motions of Jupiter's satellites. All these machines are now combined in the Orrery (q. v.), which exhibits in the best manner possible the varied motions and phenomena of the bodies in the solar system.

PLANETOIDS, or ASTEROIDS, the name given to that numerous group of very small planets which are situated in the solar system between Mars and Jupiter. Till the present century they remained undiscovered; but for some years before, their existence had been suspected, mainly owing to the remarkable hiatus in the series of the planetary distances when compared with the law of Bode (q. v.). On the first day of the present century the first of them was detected by Piazzi of Palermo, and his success roused his brother astronomers to search for more planets. Their search was successful, for Olbers (q. v.) discovered two in 1802 and 1807, and Harding one in 1804; but as all researches for some time subsequent to 1807 were unavailing, astronomers gradually allowed themselves to settle down into the belief that no more planetoids remained to be discovered, when the detection of a fifth by Hencke in 1845, revived the hope of fresh discoveries, and from this period no year (excepting 1846) has passed without adding to the list. The number at present (1864) known is 81. This remarkable success of the astronomers of our time is due to the systematic manner in which the zodiacal belt has been explored, and the place and apparent size of every star of this region distinctly determined; so that the presence of a wandering body can at once be detected.

The magnitudes of these celestial bodies have not been accurately ascertained, but it is certain that they are exceedingly small as compared even with Mercury, the least of the other planets; the diameter of the largest among them being generally believed not to exceed 450 miles, while most of the others are very much smaller than this. They also differ, generally speaking, from the rest of the planets in other respects; their orbits are of greater eccentricity, are inclined to the ecliptic at a greater angle, and are interlaced in a most intricate manner, crossing each other so frequently as to form, when viewed perpendicularly, a kind of network. The consequence of this is, that a planetoid which is nearest the sun at one part of its orbit, is, when at another part of its orbit, further from it than are several of the others, and a mutual eclipsing of the sun at different periods by two planetoids must be of very frequent occurrence. From the generally large size of their angle of inclination to the ecliptic, many of them occasionally travel far beyond the limits of the zodiac, and are thence termed *ultra-zodiacal planets*. Of the planetoids, Flora has the shortest period of revolution (1193 days), and consequently, by Kepler's third law, its mean distance from the sun is a little over 209 millions of miles; Maximiliana has the longest period (2343 days), and its mean distance from the sun is about 330 millions of miles. Concordia's orbit has least eccentricity, that element amounting to little more than  $\frac{1}{4}$  of the major axis, while in Polyhymnia it amounts to more than  $\frac{1}{2}$ . Massalia's orbit makes a smaller angle—only 41' 7"—with the ecliptic than that of any other planet in the solar system, while the inclination of the orbit of Pallas is no less than 34° 42' 41". After the first two or three of these bodies had been discovered, the opinion was propounded by Olbers that they were but the fragments of some large planet; and this hypothesis received corroboration from the intimate connection which was shewn

PLANETOIDS—PLANETS.

to subsist among them; but of late years it has, to a considerable extent, fallen out of favour with astronomers.

The 81 planetoids, with the names of their discoverers, the dates of their discovery, and their periods of revolution, are as follows:

Name.	Date of Discovery.	Discoverer.	Period of Sidereal Revolution in Days.
1. Ceres, . . . . .	1801, January 1, .	Piazzi, Palermo, . . . . .	1681.
2. Pallas, . . . . .	1802, March 28, .	Olbers, Bremen, . . . . .	1684.
3. Juno, . . . . .	1804, September 1,	Harding, Lilienthal (Bremen),	1592.
4. Vesta, . . . . .	1807, March 29, .	Olbers, Bremen, . . . . .	1325.
5. Astraea, . . . . .	1845, December 8,	Hencke, Driesen (Prussia),	1511.
6. Hebe, . . . . .	1847, July 1, . . .	Hencke, Driesen (Prussia),	1380.
7. Iria, . . . . .	1847, August 13, .	Hind, London, . . . . .	1346.
8. Flora, . . . . .	1847, October 18, .	Hind, London, . . . . .	1193.
9. Metis, . . . . .	1848, April 25, . . .	Graham, Sligo, . . . . .	1347.
10. Hygiea, . . . . .	1849, April 12, . . .	De Gasparis, Naples, . . . . .	2043.
11. Parthenope, . . . . .	1850, May 11, . . . .	De Gasparis, Naples, . . . . .	1402.
12. Victoria, . . . . .	1850, September 13,	Hind, London, . . . . .	1301.
13. Egeria, . . . . .	1850, November 2, .	De Gasparis, Naples, . . . . .	1511.
14. Irene, . . . . .	1851, May 19, . . . .	Hind, London, . . . . .	1518.
15. Eunomia, . . . . .	1851, July 29, . . . .	De Gasparis, Naples, . . . . .	1370.
16. Psyche, . . . . .	1852, March 17, . . .	De Gasparis, Naples, . . . . .	1826.
17. Thetis, . . . . .	1852, April 17, . . .	Luther, Bilk (Dusseldorf),	1420.
18. Melpomene, . . . . .	1852, June 24, . . . .	Hind, London, . . . . .	1270.
19. Fortuna, . . . . .	1852, August 22, . . .	Hind, London, . . . . .	1328.
20. Massalia, . . . . .	1852, September 19,	De Gasparis, Naples, . . . . .	1366.
21. Lutetia, . . . . .	1852, November 16,	Goldschmidt, Paris, . . . . .	1388.
22. Calliope, . . . . .	1852, November 16,	Hind, London, . . . . .	1812.
23. Thalia, . . . . .	1852, December 15,	Hind, London, . . . . .	1566.
24. Themis, . . . . .	1853, April 5, . . . . .	De Gasparis, Naples, . . . . .	2034.
25. Phocæa, . . . . .	1853, April 7, . . . .	Chacornac, Marseille, . . . . .	1359.
26. Proserpine, . . . . .	1853, May 6, . . . . .	Luther, Bilk, . . . . .	1581.
27. Euterpe, . . . . .	1853, November 8, .	Hind, London, . . . . .	1314.
28. Bellona, . . . . .	1854, March 1, . . . .	Luther, Bilk, . . . . .	1689.
29. Amphitrite, . . . . .	1854, March 1, . . . .	Marth, London, . . . . .	1492.
30. Urania, . . . . .	1854, July 22, . . . .	Hind, London, . . . . .	1:29.
31. Euphrosyne, . . . . .	1854, September 1, .	Ferguson, Washington, . . . . .	2048.
32. Pomona, . . . . .	1854, October 26, . . .	Goldschmidt, Paris, . . . . .	1500.
33. Polyhymnia, . . . . .	1854, October 28, . . .	Chacornac, Paris, . . . . .	1778.
34. Circe, . . . . .	1855, April 6, . . . . .	Chacornac, Paris, . . . . .	1609.
35. Leucothea, . . . . .	1855, April 19, . . . .	Luther, Bilk, . . . . .	1908.
36. Atalanta, . . . . .	1855, October 5, . . .	Goldschmidt, Paris, . . . . .	1666.
37. Fides, . . . . .	1855, October 5, . . .	Luther, Bilk, . . . . .	1583.
38. Laila, . . . . .	1856, January 12, . . .	Chacornac, Paris, . . . . .	1677.
39. Laetitia, . . . . .	1856, February 8, . . .	Chacornac, Paris, . . . . .	1684.
40. Harmonia, . . . . .	1856, March 31, . . . .	Goldschmidt, Paris, . . . . .	1247.
41. Daphne, . . . . .	1856, May 22, . . . . .	Goldschmidt, Paris, . . . . .	1779.
42. Isis, . . . . .	1856, May 23, . . . .	Pogson, Oxford, . . . . .	1392.
43. Ariadne, . . . . .	1857, April 15, . . . .	Pogson, Oxford, . . . . .	1195.
44. Nysa, . . . . .	1857, May 27, . . . . .	Goldschmidt, Paris, . . . . .	1379.
45. Eugenia, . . . . .	1857, June 27, . . . .	Goldschmidt, Paris, . . . . .	1640.
46. Hecate, . . . . .	1857, August 16, . . .	Pogson, Oxford, . . . . .	1470.
47. Melete, . . . . .	1857, September 9, . .	Goldschmidt, Paris, & Schubert (St Petersburg),	1529.
48. Aglaja, . . . . .	1857, September 15, . .	Luther, Bilk, . . . . .	1788.
49. Doris, . . . . .	1857, September 19, . .	Goldschmidt, Paris, . . . . .	1998.
50. Pales, . . . . .	1857, September 19, . .	Goldschmidt, Paris, . . . . .	1980.
51. Virginia, . . . . .	1857, October 4, . . . .	Ferguson, Washington, . . . . .	1577.
52. Nemausa, . . . . .	1858, January 22, . . .	Laurent, Nimes (France), . . . . .	1330.
53. Europa, . . . . .	1858, February 6, . . .	Goldschmidt, Paris, . . . . .	1993.
54. Calyso, . . . . .	1858, April 4, . . . . .	Luther, Bilk, . . . . .	1848.
55. Alexandra, . . . . .	1858, September 10, . .	Goldschmidt, Paris, . . . . .	1629.
56. Pandora, . . . . .	1858, September 10, . .	Searle, Albany, New York, . . . . .	1674.
57. Mnemosyne, . . . . .	1859, September 22, . .	Luther, Bilk, . . . . .	2049.
58. Concordia, . . . . .	1860, March 24, . . . .	Luther, Bilk, . . . . .	1619.
59. Olympia, . . . . .	1860, September 12, . .	Chacornac, Paris, . . . . .	1673.
60. Echo, . . . . .	1860, September 16, . .	Ferguson, Washington, . . . . .	1352.
61. Dione, . . . . .	1860, September 16, . .	Goldschmidt, Paris, . . . . .	1902.
62. Erato, . . . . .	1860, September 14, . .	Förster, Berlin, . . . . .	2023.
63. Ausonia, . . . . .	1861, February 10, . . .	De Gasparis, Naples, . . . . .	1356.
64. Angelina, . . . . .	1861, March 4, . . . . .	Tempel, Marseille, . . . . .	1601.
65. Maximiliana, . . . . .	1861, March 5, . . . . .	Tempel, Marseille, . . . . .	2345.
66. Mela, . . . . .	1861, April 9, . . . . .	Tuttle, Cambridge, Massachusetts, . . . . .	1588.
67. Asta, . . . . .	1861, April 17, . . . .	Pogson, Madras, . . . . .	1376.
68. Hesperia, . . . . .	1861, April 29, . . . .	Schiaparelli, Milan, . . . . .	1893.
69. Leto, . . . . .	1861, April 29, . . . .	Luther, Bilk, . . . . .	1688.
70. Panopea, . . . . .	1861, May 5, . . . . .	Goldschmidt, Chatillon (Paris), . . . . .	1557.
71. Niobe, . . . . .	1861, August 13, . . . .	Luther, Bilk, . . . . .	1671.
72. Feronia, . . . . .	1862, February 12, . . .	Peters (Clinton, New York, & Safford (Washington))	1148.
73. Clytie, . . . . .	1862, April 7, . . . . .	Tuttle, Cambridge, Massachusetts, . . . . .	1590.
74. Galatea, . . . . .	1862, August 29, . . . .	Tempel, Marseille, . . . . .	1509.
75. Eurydice, . . . . .	1862, September 22, . .	Peters, Clinton, New York, . . . . .	1590.
76. Freya, . . . . .	1862, October 31, . . .	D'Arrest, Copenhagen, . . . . .	2080.
77. Frigga, . . . . .	1862, November 12, . .	Peters, Clinton, New York, . . . . .	1360.
78. Diana, . . . . .	1863, March 16, . . . .	Luther, Bilk, . . . . .	Not determined.
79. Euryome, . . . . .	1863, September 19, . .	Watson, Ann Arbor, America, . . . . .	Not determined.
80. Sappho, . . . . .	1864, May 8, . . . . .	Pogson, Madras, . . . . .	Not determined.
81. Terpsichore, . . . . .	1864, September 30, . .	Tempel, Marseille, . . . . .	Not determined.

PLANETS (Gr. *planētēs*, 'a wanderer'), are those heavenly bodies (including the Earth) which belong to our solar system, and revolve in elliptic

orbits round the sun. They are often denominated *primary planets*, to distinguish them from their moons or satellites, which are called *secondary*

## PLANETS.

*planets.* The name planet is of considerable antiquity, and was applied to these dependents of the sun to distinguish them from the myriads of luminous bodies which stud the sky, and which present to the naked eye no indication of change of place (see STARS). The planets at present known are, in the order of their distance from the sun, Mercury, Venus, the Earth, Mars, the Planetoids (q. v.), Jupiter, Saturn, Uranus, and Neptune. Six of these, Mercury, Venus, the Earth (which was not, however, then reckoned a planet), Mars, Jupiter, and Saturn, were known to the ancients; Uranus was discovered by Sir William Herschel (q. v.) in 1781; and Neptune, after having its position and elements determined theoretically by Leverrier and Adams, was discovered by M. Challis, and afterwards by Dr Galle, in 1846. The Planetoids, which now number 81, have all been discovered during the present century. Five of the planets, the Earth, Jupiter, Saturn, Uranus, and Neptune, are attended by one or more satellites; Uranus (generally), Neptune, almost the whole of the Planetoids, and all the satellites except the Moon, are invisible to the naked eye. The visible planets can be at once distinguished from the fixed stars by their clear steady light, while the latter have a sparkling or twinkling appearance. The comparative proximity of the planets may be proved by examining them through a telescope of moderate power, when they appear as round luminous disks, while the fixed stars exhibit no increase of magnitude. The planets, as observed from the Earth, move sometimes from west to east, sometimes from east to west, and for some time remain stationary at the point where progression ends and retrogression commences. This irregularity in their movements was very puzzling to the ancient astronomers, who invented various hypotheses to account for it. See PROLEMAIC SYSTEM and EPICYCLE. The system of Copernicus, by assuming the sun, and not the earth, as the centre of the system, explained with admirable simplicity what seemed before a maze of confusion.

The planetary orbits differ considerably in their degrees of excentricity, the Planetoids, Mars, and Mercury being most, and the larger planets least excentric. No two planets move exactly in the same plane, though, as a general rule, the planes of the larger planets most nearly coincide with that of the ecliptic. The latter are consequently always to be found within a small strip of the heavens extending on both sides of the ecliptic; while the others have a far wider range, Pallas, one of them, having the angular elevation of its orbit no less than  $34^{\circ} 35'$  above the ecliptic. According to Kepler's Laws (q. v.), the nearer a planet is to the sun the shorter is the time of its revolution. The arrangement of the planets in the solar system bears no known relation to their relative size or weight, for though Mercury, Venus, and the Earth follow the same order in size and distance from the sun, yet Mars, which is further from the sun, is much less than either the Earth or Venus, and the Planetoids, which are still further off, are the least of all. Jupiter, which is next in order, is by far the largest, being about  $1\frac{1}{4}$  times as large as all the others together; and as we proceed further outwards, the planets become smaller and smaller, Saturn being less than Jupiter, Uranus than Saturn, and Neptune than Uranus.

With reference to their distance from the sun, as compared with that of the Earth, the planets are divided into *superior* and *inferior*; Mercury and Venus are consequently the only 'inferior' planets, all the others being 'superior.' The inferior planets must always be on the same side of the Earth as the sun is, and can never be above the horizon of

any place (not in a very high latitude) at midnight; they are always invisible at their superior and inferior conjunctions, except when, at the latter, a *Transit* (q. v.) takes place. The superior planets are likewise invisible at conjunction, but when in opposition they are seen with the greatest distinctness, being then due south at midnight. The time which elapses from one conjunction to its corresponding conjunction is called the *synodic period* of a planet, and in the case of the inferior planets must always be greater than the true period of revolution.

*Mercury*, the planet which is nearest the sun, is also, with the exception of the Planetoids, the smallest (being only 3 times the size of the moon), and performs its revolution round the sun in the shortest time. Its greatest elongation is never more than  $28^{\circ} 45'$ , and consequently it is never above the horizon more than two hours after sunset, or the same time before sunrise; on this account, and from its small apparent size ( $5''$  to  $12''$ ), it is seldom distinctly observable by the naked eye. It shines with a peculiarly vivid white or rose-coloured light, and exhibits no spots.—*Venus*, the next in order of distance and period, is to us the most brilliant of all the planets. Its orbit is more nearly a circle than any of the others, and when at its inferior conjunction, it approaches nearer the Earth than any other planet. Its apparent angular dimensions thence vary from  $10'$  at the superior, to  $70'$  at the inferior conjunction. Its greatest elongation varies from  $45^{\circ}$  to  $47^{\circ} 12'$ , and therefore it can never be above the horizon for much more than three hours after sunset, or the same time before sunrise. While moving from the inferior to the superior conjunction, Venus is a *morning star*, and during the other half of its synodic period an *evening star*. When this planet is at an elongation of  $40'$ , its brilliancy is greatest, far surpassing that of the other planets, and rendering a minute examination through the telescope impossible. At this period it sometimes becomes visible in the daytime, and after sunset is so bright as to throw a distinct shadow. Astronomers have repeatedly attempted to ascertain the nature and characteristics of its surface, but its brightness so dazzles the eyes as to render the correctness of their observations at best doubtful. From the changes in the position of dusky patches on its surface, which have been frequently noticed, it is concluded that it revolves on its axis, and that its equator is inclined to the plane of its orbit at an angle of  $75^{\circ}$ , but many astronomers (Sir John Herschel included) profess to doubt these conclusions. Both Venus and Mercury necessarily exhibit phases like the moon.—The *Earth*, the next planet in order, will be found under its own name; it has a single satellite, the *Moon* (q. v.).—*Mars*, the first of the superior planets, is much inferior in size to the two previous, its volume being about  $\frac{1}{8}$ th of the Earth's, and, after Mercury, its orbit is much more excentric than those of the other planets. When it is nearest to the Earth (i. e., in opposition), its apparent angular diameter is  $30''$ ; but when furthest from it (i. e., in conjunction), its diameter is not more than  $4''$ . Mars is less known than the rest of the superior planets, owing to its not possessing a satellite, by the motions of which its attractive force (and hence its mass and density) could be estimated. It shines with a fiery red light, and is a brilliant object in the heavens at midnight when near opposition; when seen through the telescope its surface appears to be covered with irregular blotches, some of them of a reddish, others of a greenish colour, while at each pole is a spot of dazzling white. The red spots are surmised to be

land; the green, water; while the white spots at the poles are with some reason supposed to be snow, since they decrease when most exposed to the sun, and increase under the contrary circumstances. The Phases (q. v.) of Mars range between full, half, full (in conjunction, if visible), and half.—After Mars in order come the *Planetoids* (q. v.), formerly but improperly called *Asteroids*.—*Jupiter*, the next in order, is the largest of all the planets, its bulk being more than 1400 times that of the Earth, though, from its small density, its mass is only 338 times more. After Venus it is the brightest of the planets and the largest in apparent size, its angular diameter varying from 30' to 45". When looked at through a telescope, it is seen to be considerably flattened at the poles, owing to its rapid revolution on its own axis; and its surface is crossed in a direction parallel to its equator by three or four distinct and strongly-marked belts, and a few others of a varying nature. Spots also appear and remain for some time on its surface, by means of which its revolution on its axis has been ascertained. This planet is attended by four satellites, which are easily observable through an ordinary telescope, and which have rendered immense service in the determination of longitudes at sea, and of the motion and velocity of light. The satellites, which were discovered by Galileo, were proved by Sir William Herschel to revolve on their own axes in the same time that they revolve round their primary. The smallest is about the same size as our Moon, the others are considerably larger.—*Saturn*, the next in position, is about 735 times larger in volume, though only about 100 times greater in mass than the earth. Its apparent diameter when in opposition is 18", and there is a considerable flattening towards the poles. Its surface is traversed by dusky belts much less distinctly marked than those of Jupiter, owing doubtless in great part to its inferior brightness; its general colour is a dull white or yellowish, but the shaded portions, when seen distinctly, are of a glaucous colour. The most remarkable peculiarity of Saturn is its ring, or series of concentric rings, each one parallel and in the same plane with the others, and with the planet's equator; the rings are at present supposed to be three in number, the two outermost are bright like the planet itself, while the innermost is of a purplish colour, and is only discernible through a powerful telescope. The rings are not always visible when Saturn is in the 'opposite' half of its orbit, for when the plane of the rings is intermediate between that of the earth's orbit and of the ecliptic, their dark surface is turned towards us, and when the sun is in their plane only the narrow edge is illumined; in both of these cases the ring is invisible from the Earth. Its plane being inclined at an angle of 28° to the ecliptic, we see the two surfaces of the ring alternately for periods of 15 years at a time; and at the middle of each period, the rings attain their maximum obliquity to the ecliptic, and are then best seen from the Earth. It is hardly necessary to remark that at the end of each period they become invisible. Saturn has also no less than eight\* satellites, seven of which revolve round it in orbits little removed from the plane of the ring, while the eighth, which is the second in size, is considerably inclined to it. Two of the satellites were discovered by Herschel in 1787 and 1789, four by Cassini in 1672 and 1684, one by Huyghens in 1655, one by Mr Lassell in England and Professor Bond in America in 1848. The satellites are all situated

outside of the ring, and the largest of them is nearly equal to the planet Mars in size.—*Uranus*, the next planet in position, was discovered accidentally by the elder Herschel on 13th March 1781, and was named 'the Georgium Sidus' and 'Herschel,' but these names soon fell into disuse. It is about 96 (some astronomers say 82) times greater than the Earth in volume, and 20 (according to others, 15) times in mass; but though so large, its distance is so much greater in proportion that astronomers have been unable to gain much information concerning it. No spots or belts have hitherto been discovered on its surface, and consequently its time of rotation and the position of its axis are unknown. It is attended by a number of satellites, but so minute do these bodies appear, that astronomers hitherto have been unable to agree as to their exact number; Sir William Herschel reckoned six, while other astronomers believe in the existence of four, five, and eight respectively. That there are at least four is without doubt.—The next and outermost member of the solar system is *Neptune*, which, at a distance of nearly 3000 millions of miles from the centre of the system, slowly performs its revolution round the sun, accomplishing the complete circuit in about 165 solar years. It is about 84 times larger than the Earth, but from its extreme remoteness is of almost inappreciable magnitude when seen through an ordinary telescope. It was the disturbance in the motion of Uranus caused by the attractive force of this planet which led Leverrier and Adams to a calculation of its size and position, on the supposition of its existence, and the directions which were given by the former to Dr Galle of Berlin, specifying its exact position in the heavens, led that astronomer to its discovery on 23d September 1846. Mr Lassell of Liverpool has discovered that Neptune is attended by one satellite. The satellites of Uranus and Neptune differ from the other planets, primary and secondary, in the direction of their motion, which is from east to west, and in the case of the former, in planes nearly perpendicular to the ecliptic. Both Uranus and Neptune were observed long before the times of Herschel and Leverrier, but they were always supposed to be stars. Uranus is known to have been observed by Flamsteed between 1690 and 1715, and Neptune by Lalande in 1795. For the periods, distances, size, density, &c., of the planets, see SOLAR SYSTEM. In astronomical tables, almanacs, &c., the planets are for convenience denoted by symbols instead of their names, as follows: Mercury, ☿; Venus, ♀; Earth, ⊕; Mars, ♂; the Planetoids, in the order of their discovery, ①, ②, ③, &c.; Jupiter, ♃; Saturn, ♄ or ♅; Uranus, ♅; Neptune, ♆; the Sun, ☉; the Moon, ☾.

**PLANT**, a living organic being, destitute of any indication of mind or feeling, and sometimes defined as essentially differing from an animal in the want of voluntary motion. Plants are the organisms which form the *Vegetable Kingdom*. The science which treats of plants is called Botany (q. v.), of which there are several important branches.

The difference between plants and animals is sometimes difficult to discern, but only in some of the groups, which must of necessity be referred to the lowest place whether in the animal or vegetable kingdom. Plants of higher organisation can never be mistaken for animals, nor animals of higher organisation for plants. Instead of a regular ascending and descending scale of organisms, from the highest animal to the lowest plant, we find a widely-extended base from which the ascent seems to begin at once in both the organic kingdoms, with many ramifications in each; and perhaps that we do not at once recognise the difference even in the lowest

\* The existence of a ninth satellite was suspected by M. Goldschmidt in April 1861, but his observation has not been verified.

organisms, may be owing to our ignorance and incapacity of proper observation.

Something which resembles the voluntary motion of animals is to be seen in some plants, in various phenomena of Irritability (q. v.); and there is even locomotion in the vegetable kingdom wonderfully simulating voluntary locomotion, a provision of nature for the diffusion of some of the lower vegetable organisms; the *Gonidia* (q. v.) of Algae and the *Spermatocoidia* (q. v.) of some other cryptogamous orders moving in a surrounding fluid by means of cilia, so that they have often been mistaken for animalcules. But no motion which can really be deemed voluntary takes place in the vegetable kingdom; and no animal, certainly to be pronounced such, fails to exhibit it—even when there is no power whatever of locomotion—in the prehension of food, or for some of the purposes of life.

The general laws which govern life prevail in plants as in animals. There are organs of nutrition and organs of reproduction; the whole being made up of organs, and every organ destined to maintain the existence either of the individual or of the race. But there is nothing in plants corresponding to the mouth, stomach, and alimentary canal of animals. Nutrition takes place in a different manner; assimilation being effected by a process very unlike that of digestion in animals. There are, however, animals destitute of a mouth, stomach, and alimentary canal; so that the distinction between plants and animals cannot be stated so absolutely in this respect as in respect to voluntary motion; and as there are many plants which have no roots, nutrition by means of roots, although peculiar to the vegetable kingdom, is not its distinguishing characteristic. The nutriment of plants is derived either by their roots from the soil (see *ROOT*), or through the integuments of their other parts from the air or water in which they live; and all their nutriment is either liquid or gaseous, being taken up in the former case by *Endosmose* (q. v.), and in the latter case through *Stomata* (q. v.). Many plants, and among them the greater number of phanerogamous plants, owe their nourishment both to the soil and to the atmosphere, their roots deriving it from the former, and the Leaves (q. v.) of plants that have leaves being the principal organs by which they derive it from the latter. When leaves are wanting, the integument of the parts exposed to the air performs the functions ordinarily assigned to them. Solid matter cannot be appropriated by plants until it has been dissolved in water, or decomposed. See *MANURE* and *SOIL*.—The nutriment appropriated by the plant is not assimilated until it has undergone chemical changes, which sometimes take place entirely within the very cell through the integument of which it has entered, some of the lowest kinds of plants consisting altogether only of a single cell; but which, in other plants of higher and more complex organization, depend upon a Circulation of the Sap (q. v.), and a very various action of many different organs, each formed of a multitude of cells. These processes are still very imperfectly understood. By them, not only is the plant nourished, but vegetable products of every kind are elaborated, in which, throughout the wide domains of the vegetable kingdom, there is such wonderful variety, and often great diversity in different parts of the same plant.

Whatever the source from which plants derive their nutriment, no organic substance is appropriated by them; but in order to their use, it must first undergo decomposition. Their food consists wholly of inorganic matter, and the value of organic substances as manures depends not only on the abundance which they contain of the proper elements, but of the readiness with which they undergo

decomposition so as to present these elements in the most suitable form; which is not, however, as elements uncombined, but in various combinations with each other. Thus carbon and oxygen enter plants together in the form of carbonic acid, oxygen and hydrogen together in the form of water, hydrogen and nitrogen in the form of ammonia. Carbonic acid absorbed by the leaves from the air is decomposed within the plant, under the influence of light, and particularly of the direct rays of the sun, and its carbon enters into new combinations to form vegetable substances, whilst its oxygen is exhaled again into the atmosphere, which is thus maintained in a state fit for the support both of vegetable and animal life by the opposite and balanced action of animals and plants. Of the elements which enter into the composition of vegetable substances, Carbon is the most abundant; and, along with it, Oxygen, Hydrogen, and Nitrogen constitute the chief part of every plant. Other elements, both metallic and non-metallic, are found in comparatively small quantity, although some of them are very generally present in plants, as Calcium, Potassium, Sodium, Sulphur, Phosphorus, Silicon, Iron, Aluminium, Magnesium, Chlorine, and Iodine. Among the elements found in plants are also to be enumerated Bromine, Manganese, and Copper, which occur only in minute quantities, and Copper very rarely.

There is no circulation in plants like that of the blood in animals, nor any organ at all analogous to a heart; although there is a constant motion or circulation of their juices, both throughout the whole organism and within individual cells. And although the term *respiration* has been often employed with reference to plants, and particularly to leaves, yet there is not only no action analogous to that of lungs, but no oxygenation of the juices by their being brought into contact with the air; carbonic acid and ammonia—not oxygen—being imbibed from it for nutrition. And there is nothing in the vegetable kingdom having the slightest resemblance to a brain or a nervous system. In the possession of sexual organs, however, there is a wonderful agreement, where it might least have been expected, between plants—or at least all phanerogamous plants—and animals. As to this and other important points concerning the life of plants, see *VEGETABLE PHYSIOLOGY*. See also the article *FLOWER*, and those on the different organs of which the flower is made up; the articles *FRUIT*, *SEED*, *SPORE*; *CELLS*, *CELLULAR TISSUE*, *VASCULAR TISSUE*; *METAMORPHOSIS OF ORGANS*; *LEAVES*, *STEM*, &c. The great divisions of the vegetable kingdom are noticed in the article *BOTANY*, in connection with the subject of classification, and in separate articles. The *GEOGRAPHICAL DISTRIBUTION OF PLANTS*, and the *DISEASES OF PLANTS*, are noticed under these heads.

Besides the relations of the animal and vegetable kingdoms already noticed in this article, in their joint and balanced action, keeping the constitution of the atmosphere such as is fit both for animal and vegetable life, reference may be here made, in conclusion, to similar relations subsisting in plants and animals as to temperature and as to their mutually providing food for one another. It would almost seem as if plants possessed a power of producing cold analogous to that exhibited by animals in producing heat, and of this beneficent arrangement man enjoys the benefit in the luxurious coolness of the fruit which nature lavishes on the tropics (Sir J. E. Tennent). Flowers indeed produce heat; but the juices of plants are colder than the soil or surrounding atmosphere during the time of active vegetation; and the coolness of groves is owing not only to shade but to the transpiration of moisture by the innumerable leaves.—Inorganic

PLANTAGENET—PLANTAGINEÆ

substances are appropriated by plants, as food, and converted by a 'high and mysterious' chemistry into organic substances of many kinds, many of them suitable food for animals, which feed on organic substances alone. But the excrements of animals again furnish food for plants; and when animals die, their bodies undergo a series of changes by decomposition, which terminate in the production of the substances most suitable for the nourishment of plants. There is, moreover, not only this conversion of the same matter into animal and vegetable substances alternately; but there is also a continual transformation of matter which has remained inorganic throughout long geologic periods into organic substances, and in this some of the lowest kinds of plants are particularly employed, as lichens, which decompose and feed upon the very rocks on which they grow; whilst, on the other hand, the fossil remains of remote periods, and all the products of decomposition, exhibit matter which once formed part of living organisms returned to an inorganic state.

PLANTA'GENET, the surname of the French family of Anjou, which, in 1154, succeeded to the throne of England on the extinction of the Norman dynasty in the male line, and reigned till 1485, when it was supplanted by the family of TUDOR (q. v.). The name P. belonged originally to the House of Anjou, and is said by antiquarians to have been derived from the circumstance of the first count of this house having caused himself to be scourged with branches of broom (*planta-genista*), as a penance for some crime he had committed. On the extinction of the male line of the Norman dynasty in the person of Henry I., the crown of England was claimed by Stephen, count of Blois, the son of Henry's sister Adela, or Adeliza, and by Henry's own daughter Matilda ('the Empress Maud'), then the wife of Geoffrey P., Count of Anjou, for her son Henry Plantagenet. Stephen, by favour of the nobles, was the successful competitor, on the condition that Henry should succeed him; and accordingly on Stephen's death, in 1154, the son of Geoffrey P. ascended the throne of England as Henry II. His sons Richard I. and John succeeded him, and the descendants of the latter in the direct male line—viz., Henry III., Edward I., Edward II., Edward III., and (Edward III.'s eldest son, the Black Prince, having died before his father, leaving an only son, who as) Richard II.—succeeded without interruption. The eldest male line now became extinct, and it was necessary to choose the rightful heir to the throne from among the descendants of Edward III.'s other sons. His second son had died without heirs, but Lionel, Duke of Clarence; John of Gaunt, Duke of Lancaster; and Edmund Langley, Duke of York, his third, fourth, and fifth sons respectively, were still represented by legitimate issue. Of these, Edmund Mortimer, Earl of March, and Anne Mortimer, the wife of Richard, Earl of Cambridge (who was the eldest son and heir of Edmund Langley, Duke of York), the lineal descendants of Lionel of Clarence, possessed the prior claim to the throne; but Edmund was put in prison by Henry IV., the eldest son of John of Gaunt, Duke of Lancaster, who usurped the crown in 1399, and transmitted it to his lineal descendants Henry V. and Henry VI. By this time Edmund Mortimer had died without heirs, and the descendants of the marriage of his sister Anne (the heiress of Clarence) with Richard, Earl of Cambridge (the heir of York), uniting the claims of the third and fifth sons, had, through their maternal ancestors, a superior claim to the throne over Henry VI. the Lancastrian monarch, who only represented the fourth

son of Edward III. Richard Duke of York, the son of Richard of Cambridge and Anne Mortimer, attempted to obtain the crown, but he was taken and executed, leaving to his sons the task of avenging his death, and asserting the claims of the combined house of York and Clarence to the throne, in which they were ably assisted by Richard Neville Earl of Warwick ('the King-maker'). The result was a long and desolating civil war (1455—1485) between the partisans of York and Lancaster, which is known in history as the 'Wars of the Roses' (the Lancastrians having chosen for their emblem a red and the Yorkists a white rose), in which more than 100,000 persons perished, and many noble families were either extirpated on the field and the scaffold, or completely ruined. During this dreadful contest, in which the Yorkists generally had the advantage, Edward IV. (the eldest son of the Duke of York who had been executed), his son Edward V., and his brother Richard III. (q. v.) successively swayed the sceptre. But Richard's cruel and tyrannical government added new vigour to the reviving Lancastrians, and Henry Tudor (see HENRY VII.), the representative of their claims, defeated the Yorkist tyrant on the field of Bosworth; and then, by his marriage with Elizabeth, the eldest daughter of Edward IV., and the representative of the Yorkist claims, reunited in his family the conflicting pretensions to the throne, which he transmitted in peace to his descendants. See TUDOR; and for the events of this contest, see ROSES, WARS OF THE.

PLANTAGINEÆ, or PLANTAGINA'CEÆ, a natural order of exogenous plants, mostly herbaceous and without stems; the leaves forming rosettes, flat and ribbed, or taper and fleshy; the flowers generally in spikes, and generally hermaphrodite; the calyx 4-parted, persistent; the corolla hypogynous, membranous, persistent, its limb 4-parted; the stamens four, inserted into the



Greater Plantain (*Plantago major*).

corolla, with long filaments; the ovary free, of a single carpel, 1—4-celled; the cells containing one, two, or many ovules; the fruit, a membranous

## PLANTAIN.

capsul; with a lid. The *testa* of the seeds abounds in mucilage, which is easily extracted by boiling water. The order is allied to *Plumbagineæ* and *Primulaceæ*. There are about 120 known species, diffused over all parts of the globe, but most abundant in temperate and cold countries. The most important genus is *Plantago*, the species of which often receive the English name PLANTAIN. Five of this genus are found in the United Kingdom, the chief of which are the following: the GREATER PLANTAIN, or WAYBREAD (*P. major*), one of the most common of British plants; a perennial, with broad ovate stalked leaves and long cylindrical spikes, growing in pastures, waysides, &c. It is very widely diffused over the world. Its seeds are a favourite food of birds, and the gathering of the spikes to feed cage-birds is familiar to every one. The leaves are applied to wounds by the peasantry in many districts. They are said also to be a useful application to ulcers and indolent scrofulous tumours. — The RIBWORT PLANTAIN, or RIBGRASS (*P. lanceolata*), is another very common British plant, forming no small part of the herbage of many meadows and pastures, and sometimes sown by farmers, because its foliage is produced early in the season, and is then acceptable to oxen, sheep, and horses; but deemed most suitable for poor soils, as its spreading leaves occupy too much of the ground, and choke better grasses in rich land. Its leaves are lanceolate, and taper at both ends; its spikes are short, ovate or cylindrical, and placed on long angular stalks. Its seed is acceptable to cage-birds. This is the plant, commonly known as 'bullies,' or 'sodgers,' the striking off the heads (or spikes) of which is such a favourite amusement of children. — The mucilage of the seeds of *Plantago ispaghula* and of *P. psyllium* is much used in India in catarrhs and other complaints; and *P. psyllium*—called FLEAWORT, and its seeds FLEASEED—is cultivated in France for the sake of this mucilage, which is used by paper-stainers in preference to that obtained from linseed, and is also extensively used by muslin manufacturers for stiffening their goods. The plant has a branched spreading stem, and recurved leaves.

PLANTAIN (*Musa Paradisiaca*), a most important food-plant of tropical countries, and one of the largest of herbaceous plants, belongs to the natural order *Musaceæ* (q. v.), and is a native of the East Indies, where numberless varieties of it have been cultivated for thousands of years. It is now diffused over all the tropical and subtropical regions of the globe. It must have been carried to America soon after or during the days of Columbus, for its fruit was a principal article of food there in the first half of the 16th c.; but there is nothing to support the conjecture of Humboldt that there may be different species cultivated under the name of P., and some of them natives of America. The P. is now, however, cultivated to the furthest depths of the primeval American forests, accompanies the Indians in their frequent changes of residence, forms the wealth of many occupiers of land in the vicinity of great towns, where large plantations of it are made, and is a true staff of life to the population of all colours and classes in tropical countries. In many regions it is the principal article of food.

In the genus *Musa* there arise from the midst of the leaves—or apparently from the top of the stem, the sheathing bases of the leaves forming a tree-like false stem—stalks which bear great spikes of flowers, each enclosed in a large bract or spathe; the flowers, and afterwards the fruit, are arranged in clusters or almost in whorls on the stalk; the flowers have a perianth of six segments, five of which cohere as a tube slit at the back, and the sixth is small and concave; there are six stamens,

one or more of them imperfect; the germen is inferior, 3-celled, with two rows of ovules in each cell; the fruit is fleshy, and has many seeds imbedded in its pulp. The name *Musa* is from the Arabic *muz*, a plantain; the P. seems to be described by Pliny under the name *pala*, a name probably derived from an eastern root, from which also comes the name *plantain*. The specific name *Paradisiaca* alludes either to a fancy that the P. was the forbidden fruit of Eden, or to a legend that the aprons which our first parents made for themselves were of P. leaves.

The stem of the P. is usually 15 or 20 feet high, although there are varieties having a stem of only six feet. The leaves are very large, the blade being sometimes ten feet long and three feet broad, undivided, of a beautiful shining green; the midrib strong and fleshy. The fruit is oblong, varying from its usual long shape to an almost spherical one, obscurely angular, eight inches to a foot long in the varieties commonly known by the name P., of which the fruit is usually cooked or prepared in some way in order to be eaten, and very often forms a substitute for bread; whilst the smaller-fruited varieties, of which the fruit is eaten raw, are generally known by the name Bananas (q. v.); these names, however, being somewhat variously used.

The P. is generally propagated by suckers; and a sucker attains maturity in about eight months or a year after being planted. The stem is cut down after fruiting, but the plantation does not require renewal for 15 or 20 years. Plantains ought to be at least ten feet apart in plantations of them, or six feet in single rows around fields or gardens. The P. has been sometimes cultivated with success in hothouses.

With the exception of two or three palms, it would not be easy to name, in the whole vegetable kingdom, any plant which is applied to a greater number of uses than the plantain. The fruit is sometimes eaten raw, although more generally—except that of the banana—boiled or roasted, and variously prepared. It is both farinaceous and saccharine. In most of the varieties it has a sweetish taste; in some it is mealy; and in some it is sub-acid or austere. It is as much used before being perfectly ripe as when it is so. In the West Indies the P. boiled and beaten in a mortar is a common food of the negroes. Plantains baked in their skins, or fried in slices with butter and powdered over with sugar, are favourite dishes in some tropical countries. They are preserved by drying in the sun—or in ovens, and pressed into masses, in which state they keep for years, and furnish a wholesome article of food. The unripe fruit, peeled, sliced, dried, and powdered, is called *P. meal*, and in Guiana *Conquin-tay*; it is whitish with dark-red specks, a fragrance like orris-root, and a taste like wheat-flour; and is made into excellent and nourishing dishes. A good and wholesome starch is obtained from the P. by rasping and washing.—A decoction of the fruit is a common beverage; and a kind of wine is obtained from it by fermentation.—The top of the stalk is a good boiled vegetable.—The leaves are much used for packing, and many other purposes; the fibre of their stalks is used for textile purposes and for cordage; and it is probable that it might be used for paper-making; but hitherto the leaves and stems of plantains have been generally burned or left to rot.

So great is the food produce of the P., that according to Humboldt's calculation, it is to that of the potato as 44 to 1, and to that of wheat as 133 to 1. The P. requires little attention.

The name P. is frequently extended to the whole genus *Musa*. Wild species, with austere fruit

## PLANTAIN-EATER—PLANTS.

are found in many parts of the East. One ascends the Himalayas to an elevation of 6500 feet. A species found in the South Sea Islands (*M. troglodytarum*) is remarkable for bearing its clusters of fruit erect, not pendent like the other species. Its fruit is eatable, as is that of *M. Cavendishii* and of *M. Chinensis*, species or varieties smaller than the common plantain.—The *Musa* which is extensively cultivated in the Philippine Islands for its fibre, *Abaca* or *Manilla Hemp*, is very similar to the common P., but has a green, hard, and austere fruit. It is generally cut when about a year and a half old, before flowering. The outer layers of the stem yield the coarsest fibre; that of the inner is so fine that a garment made of it may be enclosed in the hollow of the hand.—The young stems of *M. Ensete*, the *ENSETTE* of Abyssinia, are used in that country as a boiled esculent.

**PLANTAIN-EATER** (*Musophaga*), a genus of birds of the family *Musophagidae*, to the whole of which the same English name is often extended. The *Musophagidae* are tropical birds, African and South American, of the order *Insectores*, and tribe *Conirostrea*, allied to finches, but many of them large, and more like gallinaceous birds than finches. They are birds of beautiful plumage. They have strong thick bills, more or less curved on the top, the cutting edges jagged or finely serrated, so as to render them very efficient instruments for cutting soft vegetable substances, on which they feed, as the plantain and other fruits, and for dividing the succulent stems of plants, which they cut off close to the ground. They live much among the boughs of trees, and are active and wary birds. The true plantain-eaters (*Musophaga*) have the base of the bill extending upon the forehead; the *TOURACOS* (*Corythaix*) have a smaller bill, and the head crested.

**PLANTATION**, a term sometimes applied to places where timber trees have been planted. In that sense, as a general rule, whoever is the owner of the soil, is entitled to the trees which are planted in such soil. When land is let by lease to a tenant, the tenant does not become the owner of the trees, and cannot cut them down. But he is in England and Ireland entitled to reasonable estovers; that is, to cut sufficient wood to repair or build the houses, or make implements of husbandry. The common law of England was very defective in protecting plantations, for it was held that, as the trees were part of the realty, or soil, and nobody could steal the soil, hence nobody could be punished for larceny of trees. But this defect was cured by statute. Whoever cuts, breaks, roots up, or otherwise destroys or damages, with intent to steal, the whole or any part of a tree, sapling, or shrub, if the damage is of the amount of one shilling, may be convicted summarily, before justices of the peace, and fined £5; for a second offence, he may be committed to the house of correction for twelve months or less; and for a third offence, he is guilty of felony, and may be punished as for larceny. So, whoever steals or damages a live fence, may be fined by justices a sum of £5; and for a second offence, may be committed to the house of correction for twelve months. Moreover, if any person is found in possession of a piece of a tree or live fence, and do not give a proper account of his coming into lawful possession of the same, he may be fined £2.—In Scotland, various acts of the Scotch parliament were directed against offences of damaging trees, which are punishable as malicious mischief; the penalty being £10 Scots for each tree less than ten years old, and £20 Scots for each older tree. Tenants may also be fined for such offences. In case of injuries to fences, old Scotch statutes also provide a punishment.

## PLANTATION AND PLANTING OF TREES. See ARBORICULTURE.

**PLANTIGRADA**, in Cuvier's zoological system, a tribe of *Carnivora* (q. v.), characterised by placing the whole sole of the foot on the ground in walking. The sole is generally destitute of hair. Both fore and hind feet are five-toed in all the plantigrada. The P. are generally more or less nocturnal in their mode of life, and their movements are slower and their gait more clumsy than those of the *Digitigrada*. They are also, in general, less carnivorous; many of them feed in part or occasionally on vegetable food. The conformation of their limbs and feet gives them a power of standing erect on their hind-feet, which none of the *Digitigrada* possess, and of which advantage is taken in tame bears for the amusement of spectators.



Plantigrade Foot.

**PLANTIN**, CHRISTOPHE, an eminent printer, was born at St Avertin, near Tours, in 1514, and set up a printing-establishment at Antwerp in 1550, which soon became the greatest and most celebrated of the time. He had often twenty presses or more in active operation. Guicciardini mentions his printing-establishment as the finest ornament of the city of Antwerp, and as one of the wonders of Europe, and the learned agreed in regarding him as the first printer of his time, although he was the contemporary of Aldus and Estienne (Stephens); but this is true only as regards the number of works which issued from his establishment, and the beauty of their typography; for the services which the others have rendered to classic literature are far beyond those of Plantin. P. was nevertheless himself a man of varied, though probably not very profound learning. He superintended the publication of works in several languages, and was extremely careful of their accuracy, employing able and learned correctors of the press, whom he remunerated liberally, and publicly offering rewards for the discovery of errors. The most noted of all his publications is the *Biblia Polyglotta* (8 vols. 1569—1572), which was printed under the personal superintendence of Arias Montanus, the court chaplain of Philip II. of Spain, and towards which, Philip gave 6000 ducats for the purchase of paper. But the oldest book known to have proceeded from the press of P. is the *Institution d'une Fille de Noble Maison, traduite de Langue Toscane en François*, by Jean Beller (Ant. 1555). P. died at Antwerp in 1589. He had set up printing-establishments in Leyden and Paris, and these, with that in Antwerp, were carried on by the husbands of his three daughters.

**PLANTS**, in point of law, when put in a garden or other ground let to a tenant, belong to the landlord, and not to the tenant, for they become part of the soil. Hence, a tenant cannot dig them up and remove them, at the termination of his lease. This right of the landlord, however, is seldom enforced with much strictness, partly because the tenant may alter and remove the plants at discretion during his lease, and thus can evade the rule of law. In the case of nursery-grounds, however, the above rule does not apply, as between landlord and tenant, for the plants are considered the stock-in-trade of the nurseryman, who puts them in the ground, not with a view to let them grow permanently, but as a convenient mode of keeping them for sale. Hence, at the termination of his lease, the tenant can remove them all.



**PLANUDĒS, MAXIMUS.** See ANTHOLOGY.

**PLASEN'CIA**, an ancient and much-decayed, but most picturesque town of Spain, in Estremadura, 43 miles north-north-east of Cáceres, stands on a steep hill, with beautiful and fertile valleys, extending on the north-west and south-east sides. It is almost wholly girdled by the clear waters of the Jerte; and the surrounding scenery, embracing city, castle, river, rock, and mountain, and over-arched by a sunny and unclouded sky, is remarkably beautiful. The city contains the picturesque remains of an ancient castle, and is surrounded by crumbling walls, surmounted by 68 towers, and pierced by six gates. Water is brought to the town by an aqueduct of 80 arches. There are seven Gothic churches, an episcopal and several other palaces, and the cathedral, an ornate Gothic edifice, begun in 1498, and some portions of which are still unfinished, while others have been altered and disfigured. The cathedral contains many noble tombs, with effigies. P., once a flourishing and important city, was founded in 1190. It now carries on some minor manufactures of cotton, woollen, and hempen fabrics, and of hats and leather. Pop. about 6000.

**PLA'SMA**, a silicious mineral, a variety of quartz or chalcedony, of a dark-green colour, black when unpolished and seen by reflected light, but very translucent when held between the eye and the light. It is very nearly allied to heliotrope or bloodstone, but has no red spots, is more translucent, and is not susceptible of so brilliant a polish. It is never found crystallised. It is a rare mineral, and the finest specimens are brought from India and China. It was highly prized by the ancient Romans, who wrought it into ornaments of various kinds; and very fine engraved specimens have been found among the ruins of ancient Rome. The ancients are said to have obtained their plasma from Mount Olympus, in Asia Minor. The name plasma is supposed to be identical with the Greek *prason*, a leek, the *r* having passed into *l*.

**PLASTER OF PARIS.** See GYPSUM.

**PLASTERING**, the art of covering walls, partitions, ceilings, &c., with a composition of lime mixed with sand and hair. It is usually done in three coats. The first coat is the solid foundation on which the rest is placed; it is therefore of a good thickness, and is hatched or crossed with lines, so as to give a bond for the next coat. The first coat is allowed to dry thoroughly; then the second coat is floated over the first, and rubbed well in with a flat board, about 12 inches square, so as to bring it all to a fair and equal surface (in Scotland this is called the 'straightening'); and before the second coat has thoroughly dried, the third or finishing coat is applied in finer materials, and in a more liquid state. In the case of ceiling cornices, mouldings, &c., plaster of Paris or stucco is generally used. This sets or hardens more rapidly than lime, and has a finer and whiter surface.

Ornaments (called enrichments) are generally composed of plaster of Paris, and cast in moulds. They are then set in their places after the cornice has been made, or run.

**PLASTERS** are a class of medicinal agents which are employed externally with various objects. They are solid and tenacious compounds, adhesive at the ordinary temperature of the body, and owing their consistency—1. To the chemical combination of oxide of lead, with one or more fatty acids; or 2, to a due admixture of wax, or fat, and resin; or 3, to the chemical action of the component parts of the plaster on each other. Strictly speaking, the term *Plaster* should be restricted to the

first class of compounds; viz., to combination of oxide of lead with fatty acids. In the British Pharmacopœia, there are directions for making 12 plasters, viz., ammoniac and mercury plaster, Belladonna plaster, cantharides plaster, chalybeate plaster, galbanum plaster, litharge (or lead) plaster, mercurial plaster, opium plaster, pitch plaster, resin plaster, soap plaster, and warm plaster. The litharge (or lead) plaster, directly or indirectly, enters into the composition of all the twelve official plasters, excepting those of ammoniac and mercury, cantharides, and pitch. *Lead Plaster*, which is usually sold under the name of *Diachylon*, in combination with resin, constitutes the ordinary adhesive plaster. The best plaster of this kind for strapping is composed of a mixture of six drachms of resin with a pound of lead plaster. The *cantharides plaster* and the *ammoniac and mercury plaster*, are examples of the second and third varieties.

Plasters are generally kept in rolls; and when they are to be used, they are melted at a temperature of not more than 212°, and spread on soft leather. They are employed to answer two distinct indications, namely, to act *mechanically*, as by affording artificial support to weak muscular structures, by preventing threatened or tedious excoriations, by protecting parts already excoriated from the action of the air, &c.; and to act *medicinally* as stimulant, discutient, alterative, anodyne, &c.

**PLATA, LA.** See ARGENTINE REPUBLIC.

**PLATA, RIO DE LA**, a wide estuary of South America, between Uruguay on the north and the Argentine Confederation on the south, forms the mouth of the Parana (q. v.) and the Uruguay (q. v.). It is 180 miles long, 29 miles broad at Buenos Ayres, and 130 miles broad at its mouth, between Punta Negra and Cape San Antonio. At its mouth it is, on an average, only about 10 fathoms deep; at Monte Video it is only 3 fathoms; and at Buenos Ayres about 16 feet deep. Some conception of the vast volume of water which this estuary carries to the Atlantic may be had when it is remembered that with its affluents it drains an area of 1,250,000 square miles. The strong and irregular currents, and the sudden tempests of the La P., render its navigation extremely dangerous. It is estimated that through this estuary about one-fourth of the produce of South America is brought to market. For the navigation of its affluents, see PARAGUAY, PARANA, and URUGUAY.

**PLATĒA**, or **PLATĒÆ**, a city in the western part of Bœotia, on the borders of Attica, and at the foot of Mount Cithæron. It was about 6½ miles from Thebes. In 480 B. C., it was destroyed by the Persians, because the inhabitants had taken part with Athens in the battle of Marathon; but in the following year, it was the scene of the glorious victory won by the Lacedæmonian Greeks, under Pausanias and Aristides, over the Persian hordes commanded by Mardonius—a victory that finally delivered Greece from the threatened yoke of the invader. In the third year of the Peloponnesian war (429 B. C.), it was attacked by a Theban-Lacedæmonian force—for the Plataeans were firm friends of Athens—and heroically defended itself for more than two years, until it was starved into surrender. The little garrison of about 200 men were put to the sword, and the city was razed to the ground. Such of the Plataeans as escaped were hospitably received at Athens. By the treaty of Antalcidas (387 B. C.), their children were allowed to go back again, and rebuild their city, after an exile of 40 years; but they were again driven out by their implacable enemies, the Thebans; and half a century elapsed before the victory of Philip of

## PLATALEA—PLATING.

Macedon at Charoneia enabled the Plateans to finally return to their homes. After this, the city remained inhabited, probably till the latest days of the empire. It is mentioned in the 6th c. A. D. Some ruins of P. are still visible near the village of *Kokhla*.

**PLATA'LEA.** See **SPOONBILL**.

**PLAT-BAND,** in Architecture, a flat fascia or band, with less projection than breadth.

**PLATE,** in Heraldry, a Roundle (q. v.) argent. It is represented flat, and in the heraldry of Scotland is known as a *Bezant argent*.

**PLATE-MARKS** are legal impressions made on articles of gold or silver at the various assay offices, for the purpose of indicating the true value of the metal of which the articles are made. The marks are a series of symbols, which are embossed in a line of about three-quarters of an inch in length, and usually on every separate piece of which an article is composed. These symbols are—1. The maker's own mark or initials. 2. The standard or assay mark; viz., for gold, a crown, and figures denoting the number of carats fine. This means that pure gold is reckoned at 24 carats, and every part of alloy added reduces that standard number (see **CARAT**); so that if a piece of gold-plate or jewellery is marked with a crown and 18, it indicates that it consists of 18 parts of pure gold, and 6 parts of some other metal alloyed with it. Gold of eight carats is now legal, but as it is marked by the assay office, there can be no deception, if the public understand the plate-marks. If not, they may pay for pure gold, relying upon the hall-mark, when in reality they only receive a third part gold. For *Silver*—England, a lion passant; Ireland, a harp crowned; Edinburgh, a thistle; Glasgow, a lion rampant. 3. The hall-mark of the district office—London, a leopard's head crowned; York, three lions and a cross; Exeter, a castle with two wings; Chester, three wheat-sheaves or a dagger; Newcastle, three castles; Birmingham, an anchor; Sheffield, a crown; Edinburgh, a castle and lion; Glasgow, a tree, salmon, and ring; Dublin, the figure of Hibernia. 4. The duty-mark, indicating the payment of duty, viz., the head of the reigning sovereign. 5. The date-mark. Each office has its alphabetical mark, indicating the date of the stamp. In London, the assay year commences on the 30th of May, and the date of the current year is indicated by one of the first twenty letters of the alphabet used in regular succession; thus, the Goldsmiths' Company of London have used the following marks:

From 1716 to 1755,	Roman Capital Letters.
• 1756 • 1775,	Roman Small Letters.
• 1776 • 1795,	Old English Letters.
• 1796 • 1815,	Roman Capital Letters A to U.
• 1816 • 1835,	Small Roman Letters a to u.
• 1836 • 1855,	Old English Letters A to Z.
• 1856 •	Small Black Letters a to z.

Thus, **E S S Q I** would represent the mark on Elkington's plate, made in the present year.

**PLATE-POWDER,** a composition used for cleaning gold and silver plate and plated articles. It is also called *Rouge-powder* (see **ROUGE**). It is made by levigating rouge with three times its weight of prepared chalk, until they are thoroughly mixed into an almost impalpable powder. Sometimes Putty-powder (q. v.) is used instead of rouge, and a little rose-pink added to colour it. A plate-powder is also sometimes made by levigating quicksilver with twelve times its weight of prepared chalk, until it is thoroughly incorporated, and forms

a gray powder. It puts a remarkable brilliancy on silver-plate, but is very injurious to it.

**PLATING** signifies the covering of an inferior metal with one of the precious metals, the object being to give the appearance of silver or gold to articles chiefly intended for table use. At present, the articles are generally made of German silver, or some of the similar white-metal alloys; but formerly, copper, or an alloy of that metal with brass, was used; the disadvantage of which was that, as the coating of silver wore off, the red colour of the copper became disagreeably apparent through the thin covering of silver. Gold is rarely plated on any other metal than silver, except for purposes of deception. Previous to the introduction of electro-plating, the method generally pursued was that which has acquired the name of *Sheffield-plating*, from the large extent to which it was carried on in that town. It consists in soldering on to one or both sides of an ingot of the baser metal, a thin plate of silver. The ingot is always of an oblong shape, and is most carefully prepared on the surfaces which are to receive the silver, so that nothing shall prevent the complete union of the two. The shape and relative proportions of the ingot, and its plating of silver, are seen in the figure: *aa* is the silver on the upper and lower

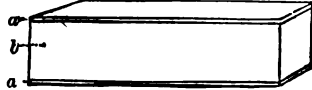

surfaces, for double-plated goods; *b*, the body of the ingot, of copper or white-metal alloy. The soldering is a process requiring much care and nicety: the plates of silver are thinly coated with a concentrated solution of borax, and are then applied to the prepared surfaces of the ingot, to which they are firmly bound with iron wire, and then placed in the *plating-furnace*, and subjected to a strong heat. This furnace is so arranged that the interior can be constantly watched, and when the proper temperature is attained, the workman knows the exact instant to withdraw it. The act of soldering is almost instantaneous, and fusion would immediately follow, if the ingot was not quickly withdrawn. When cooled, the wire is taken off, and the ingot is taken to the rolling-mill, where it is passed backwards and forwards, of course with the silver above and below, until it is rolled out into a sheet of the exact thickness required. However thin it may be made, it is found that the relative thickness between the ingot and its layers of silver is always the same. As usual in all cases of rolling or striking metal, annealing from time to time is necessary, to remove the brittleness which these operations cause.

This method does not admit of the manufacture of any portions such as ornamental moulded borders, &c.; these had therefore to be formed separately of copper, and were coated by the process called *Silvering* (q. v.). Now, however, it is found better to make them of silver rolled thin, and fill them inside with lead, to give them solidity; by this plan is avoided the annoyance of the silver rubbing off, and exposing the copper. Sheffield-plating is still made extensively, but the manufacture is rapidly declining in presence of the newer art of electro-plating. See **GALVANISM**.

Within a very recent period, and since the subject of electro-plating was treated under the article **GALVANISM**, some very remarkable applications of the process have been discovered; for instance, it is no longer confined to the deposit of silver and gold; aluminium, silicium, titanium, tungsten, molybdenum, tin, cadmium, lead, bismuth, palladium, rhodium, iridium, and the alloys

## PLATINUM.

brass and bronze, are all now deposited under patent processes. Of all these, by far the most important is the deposit of the alloys, and a very large trade has sprung up in manufactures of iron coated with brass. The importance of being able to cover a metal so cheap, yet so easily corroded as cast iron, with so ornamental an alloy as brass or bronze, can hardly be overrated. Many extensive and satisfactory pieces of this work have already been made.

**PLATINUM** (symb. Pt, equiv. 99, sp. gr. 21·5) is one of the 'noble metals,' which may be obtained in more forms than one. It is only found in the native state, usually occurring in small glistening granules of a steel-gray colour, which always contain an admixture, in varying proportions, of several metals, most of which are rarely found except in association with platinum. Sometimes, however, it is found in masses of the size of a pigeon's egg, and pieces weighing ten or even twenty pounds have occasionally been found. The following table shews the composition of crude platinum ore as obtained from different parts of the globe. The analyses were conducted by Messrs Deville and Debray.

	Colum- bia.	Calif- ornia.	Ore- gon.	Spain.	Austra- lia.	Russia.
Platinum, . . .	80·00	79·85	51·45	45·70	59·80	77·50
Iridium, . . .	1·55	4·20	0·40	0·95	2·20	1·45
Rhodium, . . .	2·60	0·65	0·65	2·65	1·50	2·80
Palladium, . . .	1·00	1·95	0·15	0·85	1·50	0·85
Gold, . . . . .	1·50	0·55	0·85	3·15	2·40	...
Copper, . . . .	0·65	0·75	2·15	1·05	1·10	2·15
Iron, . . . . .	7·20	4·45	4·30	6·80	4·30	9·60
Osmide of Iridium,	1·40	4·95	37·30	2·85	25·00	3·35
Sand, . . . . .	4·35	2·60	3·00	35·95	1·20	1·00
Osmium and loss,	...	0·05	...	0·05	0·80	2·30

Ruthenium is also almost always present, and in the above analyses is probably included with the iridium, which it closely resembles.

There are two modes of obtaining platinum in the form of ingots from the ore, both of which require notice. The method which has been universally employed, till within the last five years, was that discovered by Wollaston, the leading steps of which were as follows: After the removal of the metals associated with the platinum, by the successive action of nitric and hydrochloric acids, the platinum itself is dissolved in aqua regia, from which it is precipitated by a solution of sal ammoniac in the form of a sparingly soluble double salt, the chloride of ammonium and platinum, represented by the formula  $H_2NCl, PtCl_2$ . This salt is washed and heated to redness, by which means the chlorine and ammonia are expelled, leaving the metal in the form of a gray, spongy, soft mass, known to chemists as *spongy platinum*. In this form, it is very finely powdered under water, is next shaped by intense pressure into a mass, and is then exposed to an intense heat in a wind-furnace, the ingot being formed by hammering it upon its two ends. (If hammered on its sides, it splits.) This heating and forging must be repeated till the metal becomes homogeneous and ductile.

Deville and Debray have introduced an entirely new method for the extraction of platinum from its ores. They first form a fusible alloy of this metal with lead, by exposing the platinum ore—2 cwt. being used in a single experiment, with equal weights of galena and litharge gradually added, and a little glass to act as a flux—to full redness in a reverberatory furnace lined with clay. The sulphur of the galena is oxidised and expelled, and the liquid alloy of lead and platinum is allowed to rest for some time, to allow the osmide of iridium, which is not affected by the preceding operations, to sink to the bottom. The upper

portions of the alloy are then decanted, and cast into ingot-moulds, which are submitted to cupellation; and the metallic platinum which is left after the cupellation is melted and refined in a furnace of lime—which is employed in consequence of its being a very bad conductor of heat—by means of the oxyhydrogen blow-pipe. The platinum obtained in this manner is nearly pure, and very ductile and malleable. For details regarding this process, which has been patented both in France and in this country, the reader is referred to the memoir, 'On Platinum and the Metals which accompany it,' in the *Annales de Chimie et de Physique* for August 1859.

Platinum, as obtained by either of the above processes, exhibits a bluish-white metallic lustre; it is exceedingly malleable and ductile, and is very infusible, melting only before the oxyhydrogen blow-pipe, or in a very powerful blast-furnace, such as that used by Deville and Debray. It expands less by heat than any other metal, and it is usually regarded as the heaviest form of matter yet known; but, according to Deville and Debray, osmium and iridium are about equally dense. It is unaffected by atmospheric action, and does not undergo oxidation in the air at even the highest temperatures. It is not acted on by nitric, hydrochloric, sulphuric, or hydrofluoric acid, or in short, by any single acid; but in aqua regia it slowly dissolves, and forms a soluble bichloride. In consequence of its power of resisting the action of acids, it is of great service in experimental and manufacturing chemical processes, platinum spatulas, capsules, crucibles, &c., being employed in every laboratory; while platinum stills, weighing sometimes as much as one thousand ounces, are frequently used for concentrating oil of vitriol. Platinum is, however, corroded if heated with the alkalies or alkaline earths, and especially with a mixture of nitrate of potash and hydrated potash, an oxide being formed which combines with the alkaline bases.

The form of the metal known as *spongy platinum* has been already noticed. The metal may, however, be obtained in a state of subdivision much finer than that in which it is left on heating the double chloride of platinum and ammonium—namely, in the state known as *Platinum Black*. In this form it resembles soot. It may be prepared in various ways, of which one of the simplest is to boil a solution of bichloride of platinum, to which an excess of carbonate of soda and a quantity of sugar have been added, until the precipitate formed after a little time becomes perfectly black, and the supernatant liquid colourless. The black powder is then collected on a filter, washed, and dried by a gentle heat. In its finely comminuted state, either as spongy platinum or platinum black, it possesses a remarkable power of condensing and absorbing gases, one volume of platinum black being able to absorb more than 100 volumes of oxygen. This absorption appears to be accompanied by a conversion of some or all of the oxygen into the modification known as Ozone (q. v.), since the metal becomes capable of exerting the most energetic oxidising action, even at ordinary temperatures. For example, it can cause the combustion of a jet of hydrogen, can oxidise sulphurous acid into sulphuric acid, ammonia into nitric acid, and alcohol into acetic acid, the rise of temperature in the last case being often sufficiently great to cause inflammation. Platinum in the compact form, as foil or wire, possesses similar powers, but in a far lower degree.

Platinum may be easily alloyed with most of the metals, the alloys being in general much more fusible than pure platinum. Hence care must be taken not to heat the oxides of metals of easy reduction, such as lead and bismuth, in platinum

crucibles, as, if any reduction took place, the crucible would be destroyed by the fusion of the resulting alloy. An alloy of platinum, iridium, and rhodium is found, by the investigations of Deville and Debray, to be harder, and capable of resisting a higher temperature than the pure metal; and hence is admirably adapted for the formation of crucibles, &c.

There are two oxides of platinum, a protoxide,  $PtO$ , and a binoxide,  $PtO_2$ , neither of which can be formed by the direct union of the elements. Excepting that the change which platinum vessels undergo when containing the caustic alkalis, &c., and exposed to a red heat, is due to the formation of a superficial layer of oxide (probably binoxide), these compounds are of little interest. The *sulphides* and *chlorides* correspond in number and composition to the oxides. Of these compounds, the bichloride ( $PtCl_2$ ) alone requires notice. It is formed by dissolving platinum in aqua regia, and evaporating the solution to dryness; and it is obtained as a deliquescent, reddish-brown mass, which forms an orange-coloured solution in water, from which, on evaporation, it crystallises in prisms. It is also freely soluble in alcohol and ether. A solution of this salt is much used for the recognition and determination of potash and ammonia.

By the action of ammonia on protochloride of platinum (which is obtained by heating a solution of the bichloride to a temperature of  $450^\circ$ ), several remarkable compounds are formed, which possess strong basic characters, and are of great interest in a theoretical point of view, such as Platosamine ( $PtH_3NO$ ), Platinamine ( $PtH_3NO_2$ ), &c.

PLATO, who, along with Aristotle, represents to modern Europe the whole compass of Greek speculation, was born at Athens in the year 429 B. C., shortly after the commencement of the Peloponnesian war, and the same year in which Pericles died. He was of a good family—being connected, on the mother's side, with Solon; and on the father's side, with Codrus, one of the ancient kings of Athens. He received a good education, according to the common practice of the Greeks, in music, gymnastics, and literature. His rich and gorgeous imagination is said at first to have essayed its powers in poetry; but when about 20 years of age, having become acquainted with Socrates, he threw all his verses into the fire, and consecrated his great intellect to philosophy. When he was 20 years old, the political troubles, of which the death of Socrates was only one terrible symptom, forced him to leave Athens for a season, and he resided at Megara, with Euclid, the founder of the Megaric sect. The disturbed state of his native country, doubtless, also was one cause of the frequent travels which he is reported to have made. Of these, his three visits to Sicily, during the time of the elder and younger Dionysius, are the most celebrated and the best authenticated. That he visited Italy, is extremely probable; at all events, he was most closely connected with Archytas and the Pythagorean philosophers; though, as Aristotle (*Metaph.* i. 6) justly remarks, he borrowed from Heraclitus as well as from Pythagoras, and put a stamp of freshness and originality on all that he borrowed. After returning from his first visit to Sicily, being then in his fortieth year, he commenced teaching philosophy publicly, in the Academeia, a pleasant garden in the most beautiful suburb of Athens, and there gathered around him a large school of distinguished followers, who maintained a regular succession after his death, under the name of the Philosophers of the Academy. He lived to the age of 82; was never married; and must have possessed some independent property, as he expresses himself

strongly against teaching philosophy for fees, and we nowhere read of his having held any public office from which he could have derived emolument. Such are the few reliable facts known as to the life of Plato.

The principles of his philosophy are happily better known; for all his great works have been preserved, and have always been extensively read wherever the Greek language was known. The only danger to which the students of his philosophy have been exposed is the confusion of the doctrines distinctly taught by him with the exaggeration of these as afterwards worked out by the Neo-Platonists of Alexandria; but this is a danger which the exact critical scholarship of modern times has put out of the way for all persons who exercise common precaution in the acquisition of knowledge. The distinctive character of the Platonic philosophy is expressed by the word idealism, as opposed to realism, materialism, or sensationalism, using these words in their most general and least technical sense, the capacity of forming and using ideas being taken as an essential virtue or quality of mind, as contrasted with matter; of thought as contrasted with sensation; of the internal forces of individuals and of the universe, as contrasted with the external forms by which these forces are manifested. As such, the ideal philosophy stands generally opposed to that kind of mental action which draws its stores principally from without, and is not strongly determined to mould the materials thus received by any type of thought or hue of emotion derived from within. In other words, the philosophy of P. is essentially a poetical and an artistical philosophy; for poetry, painting, and music all grow out of idealism, or those lofty inborn conceptions by which genius is distinguished from talent. It is also, at the same time, a scientific philosophy, for the purest science, as mathematics—on which P. is well known to have placed the highest value—is a science of mere ideas or forms conditioned by the intellect which deduces their laws; and, above all, it is essentially a moral and a theological philosophy, for practice, or action, is the highest aim of man, and morality is the ideal of action; and God, as cause of all, is the ideal of ideals, the supreme power, virtue, and excellence to which all contemplation recurs, and from which all action and original energy proceed. The distinctive excellence of the Platonic philosophy is identical with its distinctive character, and consists in that grand union of abstract thought, imaginative decoration, emotional purity, and noble activity, which is the model of a complete and richly endowed humanity. The poetical element in P., so wonderfully combined with the analytical, shews itself not only in those gorgeous myths which form the peroration of some of his profoundest dialogues, but in that very dialogic form itself, of which the situation is often extremely dramatic; though this form of philosophic discussion perhaps owes its existence more to the lively temper and out-of-door habits of the Greeks, than to the special dramatic talent of Plato. On the other hand, the defects of the Platonic philosophy arise from its essential one-sidedness, as a polemical assertion of the rights of thought against the claims of the mere senses, of the stability of the eternal type against the constant change that characterises the ephemeral form. In his zeal to submit all that is external to the imperatorial power of internal conception, the philosopher of ideas is apt to forget the obstinate and unpliant nature of that external world which he would regulate, and after projecting a grand new scheme of society, according to what appears a perfect model, shews like the architect who, after drawing out the model of a

marble temple, finds he has only bricks to build it with. For this reason, extremely practical men, and those who are compelled to reason chiefly by an extensive induction from external facts, have ever felt an instinctive aversion to the Platonic philosophy; and P. himself, by some of the strange and startling conclusions, in matters of social science, to which his ideal philosophy led, has, it must be confessed, put into the hands of his adversaries the most efficient weapons by which his ideal system may be combated.

The starting-point of the Platonic philosophy, as, indeed, it must be of all philosophy, properly so called, is the theory of knowledge. This is set forth in the *Theætetus*, the *Sophistes*, and the *Parmenides*; and in the *Cratylus*, the foundations are laid for a science of language, as the necessary product of a creature energising by ideas. The Platonic theory of knowledge, as developed in the *Theætetus*, will be most readily understood by imagining the very reverse of that which is vulgarly attributed to Locke; viz., by drawing a strong and well-marked line between the province of thought and that of sensation in the production of ideas, and taking care that, in the process of forming conceptions, the mind shall always stand out as the dominant factor. In other words, the hackneyed simile of the sheet of blank paper, applied to the mind by extreme sensational philosophers, must either be thrown away altogether or inverted; the more active part of the operation must always be assigned to the mind. The formation of knowledge, according to P., may be looked on as the gradual and systematic elimination of the accidental and fleeting in the phenomenon from the necessary and permanent; and the process by which the mind performs this elimination—and it can be performed only by mind—is called *Dialectics*. This word, from *diálogos*, originally signifies only conversational discussion; thence, that discussion conducted in such scientific fashion as to lead to reliable results, i. e., strictly logical. The product of dialectics is ideas, and these ideas being the *éidē*, forms or types of things which are common to all the individuals of a species, all the species of a genus, all the genera of a family, and all the families of a class, generate classification—that is, knowledge of the permanent in phenomena—and definition, which is merely the articulate verbal expression of this permanency. The construction of the confused results of observation into the orderly array of clear conceptions, by a sort of cross-examination of the phenomena, performed by minds impassioned for truth, is exhibited as the great characteristic of the teaching of Socrates, in the *Memorabilia* of Xenophon. In the dialogues of P., the same purification of the reason, so to speak, from the clouds of indistinct sensuousness, is exhibited on a higher platform, and with more comprehensive results. For between Socrates and P., notwithstanding a deep internal identity, there was this striking difference in outward attitude—that the one used logic as a practical instrument in the hands of a great social missionary and preacher of virtue; while the other used it as the architect of a great intellectual system of the universe, first and chiefly for his own time and his own place, but, as the event has proved, in some fashion also for all times and all places.

We should err greatly, however, if we looked on P. as a man of mere speculation, and a writer of metaphysical books, like certain German professors. Neither P. nor any of the great Greeks looked on their intellectual exercises and recreations as an end in themselves. With them, philosophy did not mean mere knowledge or mere speculation, but it

meant wisdom, and wisdom meant wise action, and wise action meant virtue. The philosophy of P., therefore, with all its transcendental flights, of which we hear so much, was essentially a practical philosophy; all his discussions on the theory of knowledge and the nature of ideas are undertaken mainly that a system of eternal divine types, as the only reliable knowledge, may serve as a foundation for a virtuous life, as the only consistent course of action. Virtue, with Socrates and P., is only practical reason. As in the Proverbs of Solomon, all vice is folly, so in the philosophy of P., the imperial virtue is *phronēsis*—i. e., 'wisdom' or practical 'insight.' The other two great Greek and Platonic virtues—*sōphrosynē*, 'moderation' or 'soundmindedness,' and *dikaiosynē*, 'justice,' or the assigning to every act and every function its proper place—are equally exemplifications of a reasonable order applied to action—such an order as alone and everywhere testifies the presence of mind. The theory of morals as worked out from such principles is, of course, as certain as the necessary laws of the reason which it expresses; and accordingly, the Platonic morality, like the Christian, is of that high order which admits of no compromise with ephemeral prejudice or local usage. The contrast between the low moral standard of local respectability and that which is congruous with the universal laws of pure reason, stands out as strikingly in Plato, as the morality of the Sermon on the Mount in the Gospels does against the morality of the Scribes and Pharisees. Splendid passages to this effect occurs in various parts of P.'s writings, particularly in the *Republic* and the *Gorgias*. In perfect harmony with the Platonic theory of noble action, is his doctrine with regard to pure emotion and elevated passion. Love with P. is a transcendental admiration of excellence—an admiration of which the soul is capable by its own high origination and the germs of godlike excellence, which are implanted into it from above. The philosophy of love is set forth with imaginative grandeur in the *Phædrus*, and with rich dramatic variety in the *Banquet*, of which dialogue there is an English translation by Shelley. The philosophy of beauty and the theory of pleasure are set forth with great analytic acuteness in the *Philebus*. With P., the foundation of beauty is a reasonable order, addressed to the imagination through the senses—i. e., symmetry in form, and harmony in sounds, the principles of which are as certain as the laws of logic, mathematics, and morals—all equally necessary products of eternal intellect, acting by the creation and by the comprehension of well-ordered forms, and well-harmonised forces, in rich and various play through the living frame of the universe; and the ultimate ground of this lofty and coherent doctrine of intellectual, moral, and æsthetic harmonies lies with P., where alone it can lie, in the unity of a supreme, reasonable, self-existent intelligence, whom we call God, the fountain of all force, and the creator of all order in the universe; the sum of whose most exalted attributes, and the substantial essence of whose perfection may, as contrasted with our finite and partial aspects of things, be expressed by the simple term *ἰδὲ ἀγαθὸν*—the Good. From this supreme and all-excellent intelligence, human souls are offshoots, emanations, or sparks, in such a fashion, that they partake essentially of the essential nature of the source from which they proceed, and accordingly possess unity as their most characteristic quality, attest their presence everywhere by a unifying force which acts by impressing a type on whatever materials are submitted to it, and is filled with a native joy in the perception of such types, the product of

the same divine principle of unity, wheresoever presented. The undivided unity and unifying force which we call the soul is immortal, being from its nature altogether unaffected by the changes of decay and dissolution to which the complex structure of the material human body is exposed. The doctrine of the immortality of the soul is most fully set forth in the *Phædo*, a dialogue which combines with the abstract philosophical discussion, a graphic narrative of the last hours of Socrates, which, for simple pathos and unaffected dignity, is unsurpassed by any human composition.

The most complete and systematic exhibition of the opinions of P. will be found in the *Republic*, or ideal commonwealth, of which an excellent English translation has been recently made by Davies and Vaughan. The *Republic* is not, as the title would lead us to suppose, a political work, like the *Politics* of Aristotle. It is, as Baron Bunsen well remarked, not so much a state as a church with which this great work has to do; or at least, both a state and a church; and the church is the superior and dominating element. In the *Republic*, accordingly, we find the necessity of virtue to the very idea of social life proved in the first book; then the whole process of a complete moral and scientific education is set forth with such fulness as to throw the strictly political part of the book, including the germs of what is now called political economy, very much into the shade. The principles and government of an ideal moral organism, of which the rulers shall be types of fully developed and perfectly educated men, is the real subject of the *Republic*, which accordingly forms a remarkable contrast to the inductive results of the thoroughly practical work of Aristotle on the same subject. P.'s commonwealth is a theoretical construction of a perfect ideal state of society; Aristotle's is a practical discussion on the best form of political government possible under existing conditions. Of the value of P.'s work, both suggestively in the world of politics, and dogmatically in the region of moral and religious speculation, there can be no doubt; but as a practical treatise on politics, it is vitiated throughout, both by its original scheme, and by an inherent vice in the author's mind, which prevented him from recognising the force of the actual in that degree which necessarily belongs to such a complex art as human government. Of this fault, the author was himself sufficiently conscious, and has accordingly, in another large political treatise, the *Laws*, endeavoured, for practical purposes, to make some sort of compromise between the transcendental scheme of his *Commonwealth* and the conditions of existing society. But however he might modify individual opinions, there was a one-sidedness about P.'s mind, which rendered it impossible for him to struggle successfully with the difficulties of complex practical politics. He was too much possessed with the idea of order, and, moreover, had planted himself with too manifest a polemical attitude against Athenian democracy, to give due weight to the opposite principle of freedom, proved by experience to be so indispensable to every healthy and vigorous political development.

Physical science, in the days of P., stood on no basis sufficiently sure or broad to authorise a philosophy of the material universe with any prospect of success. Nevertheless, in his *Timæus*, the great philosopher of ideas has attempted this; and it is a work which, however valueless in the face of the grand results of modern chemical and kinetical research, will ever be consulted with advantage, as a grand constructive summary of the most important facts and theories of nature, known to the Greeks, before the accurate observations of Aristotle,

and the extended mathematics of the Alexandrian school. The great question as to what matter is, and whence, P. nowhere seems to settle very clearly; but the general tendency of ancient thought was towards a dualism, which recognised the independent existence of a not very tractable element called matter, in which P. seems to have acquiesced.

The works of P. were extensively studied by the Church Fathers, one of whom joyfully recognises, in the great teacher of the Academy, the schoolmaster who, in the fulness of time, was destined to educate the heathen for Christ, as Moses did the Jews. A lofty passion for P. likewise seized the literary circle of the Medici at the period of the revival of letters in Italy. Since that time, the tyrannous sway of Aristotle, characteristic of the middle ages, has always been kept in check by a strong band of enthusiastic Platonists in various parts of Europe. Since the French Revolution particularly, the study of Plato has been pursued with renewed vigour in Germany, France, and England; and many of our distinguished authors, without expressly professing Platonism—as Coleridge, Wordsworth, Mrs Browning, Ruakin, &c.—have formed a strong and a growing party of adherents, who could find no common banner under which they could at once so conveniently and so honourably muster as that of Plato. The amount of learned labour expended on the text of Plato during the present century, has been in proportion; and in this department the names of Bekker, Ast, and Stallbaum stand pre-eminent. Professor Jowett also, in Oxford, has made P. his standard author for many years; and a new edition of the works of the philosopher is expected immediately from his hand. Mr Grote, the historian of Greece, is engaged in a work on P., which is understood to be nearly finished. One of the best accounts of the Platonic philosophy in the English language will be found in Archer Butler's *History of Greek Philosophy*, vol. ii.

PLATOFF, MATVEI IVANOVITCH, COUNT, the Hetman of the Cossacks of the Don, and a Russian cavalry general, was born on the banks of the Don, 6th August 1757, and was descended from an ancient and noble family, which had emigrated from Greece. Having acquired a considerable reputation for wisdom and bravery, he was appointed by the Czar Alexander I. Hetman of the Cossacks; and subsequently, as a lieutenant-general in the Russian army, and afterwards as commander of the Russian irregular cavalry, he took a prominent part in the wars both with France and Turkey. After the French had evacuated Moscow, and retreated, P. hung upon their rear with the utmost pertinacity, wearying them out by incessant attacks, cutting off straggling parties, capturing their convoys of provisions, and keeping them in a state of continual terror and apprehension. The French historians state that Bonaparte's army suffered more loss from the attacks of P.'s Cossacks than from privation and exhaustion. He defeated Lefebvre at Altenburg. After the rout of the French at Leipzig, he inflicted great loss upon them in their retreat, and subsequently gained a victory over them at Laon. The inhabitants of Seine-et-Marne will long remember him by the devastations and pillage committed by his undisciplined bands. He was enthusiastically welcomed by the Parisians (to their shame), and also by the English, who presented him with a sword of honour on the occasion of his visit to London in company with Marshal Blücher. The allied monarchs loaded him with honours and decorations, and the czar gave him the title of Count. He retired to his own country, there to mourn the death of his only son who had been killed in the campaign of 1812 and died near Tcherkask in 1818.

No other Russian general ever exercised such an influence over the men under his command, and their awe of him was not greater than their affection; but this was doubtless owing to the inflexible and speedy justice which he administered to them, and to the freedom with which he left them to rob and pillage.

**PLATONIC LOVE**, the name given to an affection subsisting between two persons of different sex, which is presumed to be unaccompanied by any sensuous emotions, and to be based on moral or intellectual affinities. The expression has originated in the view of Plato, who held that the common sexual love of the race, harassed and afflicted with fleshly longings, is only a subordinate form of that perfect and ideal love of truth which the soul should cultivate. Whether such a sentiment as Platonic love can really subsist between persons of different sex, has been frequently disputed; but without pronouncing positively on a point so delicate, and depending so much on differences in our spiritual organisation, it may be safely affirmed, that wherever a feeling—calling itself by this name—exists, it has undoubtedly a tendency to develop into something more definite and dangerous.

**PLATOON** (probably from the French *peloton*) was a term formerly used to designate a body of troops who fired together. A battalion was commonly divided into 16 platoons, and each company into two platoons, the platoon thus corresponding to the present subdivision. The word is obsolete in this its original sense; but it survives in the expression 'platoon exercise,' which is the course of motions in connection with handling, loading, and firing the musket or rifle.

**PLATTE**. See NEBRASKA.

**PLATTEN-SEE**. See BALATON.

**PLATTSBURG**, a village of New York, U.S., on the west shore of Lake Champlain, at the mouth of the river Saranac, which furnishes water-power to several mills and factories. It has a custom-house, academy, and nine churches. In Plattsburg Bay was fought the naval battle of Champlain, in which the British flotilla, under Commodore Downie, was defeated by the American commodore M'Donough, September 11, 1814; while the land forces, amounting to 14,000 men, under Sir George Prévost, were defeated by General Macomb. Pop. in 1860, 6680.

**PLATYPUS**. See DUCK-BILL.

**PLATYSTOMA** (Gr. broad-mouth), a genus of fishes of the family *Siluridae*, having a very flat (depressed) snout, and a very large mouth with six long barbels; the skin quite destitute of scales; two dorsal fins; the eyes lateral, level with the nostrils. The species are numerous, some of them attaining a large size, many of them notable for their distinct and conspicuous markings. Several are natives of the rivers of the north-east of South America; and among these are some of the most beautiful and delicious of fresh-water fishes, as *P. tigrinum*, known among different tribes of Indians by various names—*Corutto*, *Colite*, *Oronni*, &c., which has an elongated body, light blue, transversely streaked with black and white, and a spreading forked tail. It is both taken by baited hooks and shot with arrows by Indians, as are several other species, some of which are found as far south as Buenos Ayres.

**PLAU'EN**, an important manufacturing town of Saxony, in a beautiful valley on the White Elster, 74 miles south of Leipzig by railway. It was the chief town of the Saxon Voigtland (q. v.), and its castle was at one time the residence of the Voigt,

or advocate, but is now used as the seat of justice and other courts. P. contains a gymnasium, a royal palace, and numerous educational and benevolent institutions. It carries on extensive manufactures of muslin, cambric, and jaconet goods, as well as embroidered fabrics and cotton goods. In September 1844, 150 buildings were destroyed by fire, and after that event, the town was almost wholly rebuilt. Pop. 14,817.

**PLAUTUS**, M. ACCIUS, or, more correctly, T. MACCIUS, the great comic poet of Rome, was born about 254 B.C. at Sarsina, a village of Umbria. We have no knowledge of his early life and education; but it is probable that he came to Rome while still a youth, and there acquired a complete mastery of the Latin language in its most idiomatic form, as well as an extensive familiarity with Greek literature. It is uncertain whether he ever obtained the Roman franchise. His first employment was with the actors, in whose service he saved an amount of money sufficient to enable him to leave Rome and commence business on his own account. What the nature of this business was, or where he carried it on, we are not informed; we know, however, that he failed in it, and returned to Rome, where he had to earn his livelihood in the service of a baker, with whom he was engaged in turning a hand-mill. At this time—a few years before the outbreak of the Second Punic War—he was probably about 30 years of age; and while employed in his humble occupation, he composed three plays, which he sold to the managers of the public games, and from the proceeds of which he was enabled to leave the mill, and turn his hand to more congenial work. The commencement of his literary career may, therefore, be fixed about 224 B.C., from which date he continued to produce comedies with wonderful fertility, till 184, when he died in his 70th year. He was at first contemporary with Livius Andronicus and Nævius; subsequently with Ennius and Cæcilius.

Of his numerous plays—130 of which bore his name in the last century of the republic—only 20 have come down to us. Many of them, however, were regarded as spurious by the Roman critics, among whom Varro in his treatise (*Questiones Plautinae*) limits the genuine comedies of the poet to 21. With the exception of the 21st, these Varronian comedies are the same as those we now possess. Their titles, arranged (with the exception of the Bacchides) in alphabetical order, are as follows: 1, *Amphitryo*; 2, *Asinaria*; 3, *Aulularia*; 4, *Captivi*; 5, *Curculio*; 6, *Casina*; 7, *Cistellaria*; 8, *Epulicus*; 9, *Bacchides*; 10, *Mostellaria*; 11, *Menæchmi*; 12, *Miles*; 13, *Mercator*; 14, *Pæulolus*; 15, *Pænulus*; 16, *Persa*; 17, *Rudens*; 18, *Stichus*; 19, *Trinummus*; 20, *Truculentus*; 21, *Vitularia*. As a comic writer, Plautus enjoyed immense popularity among the Romans, and held possession of the stage down to the time of Diocletian. The vivacity, the humour, and the rapid action of his plays, as well as his skill in constructing plots, commanded the admiration of the educated no less than of the unlettered Romans; while the fact that he was a national poet prepossessed his audiences in his favour. Although he laid the Greek comic drama under heavy contributions, and 'adapted' the plots of Menander, Diphilus, and Philemon with all the license of a modern playwright, he always preserved the style and character native to the Romans, and reproduced the life and intellectual tone of the people in a way that at once conciliated their sympathies. The admiration in which he was held by his contemporaries descended to Cicero and St Jerome; while he has found imitators in Shakspeare, Molière, Dryden, Addison, and Lessing,

and translators in most European countries. The only complete translation of his works into English is that by Thornton and Warner (5 vols., 1767—1774). Unfortunately the text of his plays, as they have come down to us, is in such a very corrupt state, so defective from lacunæ, and so filled with interpolations, that much yet remains to be done by the grammarian and the commentator before they can be read with full appreciation or comfort. Of complete editions, the best are those of Weise and Fleckeisen; while those plays edited by Ritschl are treated with such admirable acuteness and learning as to cause regret that they are yet so few.

**PLAYFAIR, JOHN**, a Scottish mathematician and natural philosopher, was born at Benvie in Forfarshire, March 10, 1748. His father, who was minister of the united parishes of Liff and Benvie, sent him to the university of St Andrews at the age of 14, to study with a view to the ministry; and here P. obtained great reputation as a diligent and successful student, especially in mathematics and natural philosophy; so much so, that while a student, he for some time discharged the duties of the Natural Philosophy chair during the illness of the professor. In 1773, he entered the ministry, and succeeded his father in the parish of Liff and Benvie. During his leisure hours, he still prosecuted his favourite studies, the fruits of these labours being two memoirs, *On the Arithmetic of Impossible Quantities*, and *Account of the Lithological Survey of Schiehallion*, which were communicated to the Royal Society of London. In 1782, he resigned his parochial charge, to superintend the education of the sons of Mr Ferguson of Raith; and in 1785, he became joint-professor of Mathematics along with Adam Ferguson in the university of Edinburgh; but exchanged his chair for that of Natural Philosophy in 1805. He took the part of Mr (afterwards Sir John) Leslie (q. v.), his successor in the Mathematical chair, and published a pamphlet full of biting satire against the 'new-sprung zeal for orthodoxy.' He became a strenuous supporter of the 'Huttonian theory' in geology, and after publishing his *Illustrations of the Huttonian Theory of the Earth* (Edin. 1802), he made many journeys for the sake of more extensive observations, particularly in 1815, when he visited France, Switzerland, and Italy. He died at Edinburgh, 19th July 1819. P., according to Jeffrey (*Annual Biography*, 1820), 'possessed in the highest degree all the characteristics both of a fine and a powerful understanding; at once penetrating and vigilant, but more distinguished, perhaps, by the caution and success of its march, than by the brilliancy or rapidity of its movements.' P. was, during the later part of his life, Secretary to the Royal Society of Edinburgh. From 1804, he was a frequent contributor to the *Edinburgh Review*, criticising the works of Laplace, Zach, and Kater, and the great trigonometrical surveys, both French and English, which had just been completed. He also wrote the articles 'Epinus' and 'Physical Astronomy,' and an incomplete 'Dissertation on the Progress of Mathematical and Physical Science,' for the *Encyclopædia Britannica*. His contributions to the *Transactions of the Royal Society of Edinburgh* are numerous and exceedingly varied, a treatise on 'Naval Tactics' even appearing among them. His separate works are the *Elements of Geometry* (Edin. 1795), containing the first six books of Euclid, with supplementary articles on Trigonometry, Solid Geometry, and the Quadrature of the Circle; and his *Outlines of Natural Philosophy* (Edin. 1812 and 1816), being the heads of his lectures delivered in the university on that subject. A third volume of

the *Outlines*, completing the work, was promised, but never appeared.

**PLEA** is a technical term in the law of the United Kingdom. In England, it has a very restricted meaning, being confined to the pleading of a defendant to an action at common law. It has a similar, though still more restricted meaning when used in Chancery proceedings.—In Scotland, it is not used in the same sense, but denotes the short legal ground on which a party, whether pursuer or defender, bases his case or pleading. Hence the pleas in law are only short propositions of law. Pleas are subdivided according to their subject-matter, into pleas dilatory and peremptory, pleas of abatement, pleas to the jurisdiction. Pleas in bar are the same as peremptory pleas; but in criminal cases in England, special pleas in bar are pleas stating some ground for not proceeding with the indictment, such as a plea of former acquittal, or *autrefois acquit*; or of conviction, or *autrefois convict*; or a plea of pardon.—In Scotland, a 'plea of panel' means a plea of guilty or not guilty. Pleas of the crown was an expression anciently used to denote the divisions of criminal offences generally, as in the well-known work called *Pleas of the Crown*, by Sir Matthew Hale, and other writers. The phrase was so used because the sovereign was supposed in law to be the person injured by every wrong done to the community, and therefore was the prosecutor for every such offence.

**PLEADING**, as a Legal term, has two meanings—a restricted and a general meaning. In the former sense, it is a generic term to denote the written formula containing the subject-matter of a litigant's demand, or claim, or of his defence or answer thereto. In its general sense, it denotes that system of rules on which the particular pleadings of litigants are framed. In the practice of English common law, the pleadings in an action are called the declaration, plea, replication, rejoinder, surrejoinder, rebutter, surrebuter, &c.—the first being a statement of the plaintiff's demand; the second, the defence thereto, and so on, each alternately answering the other, until the parties arrive at a stop, called an issue, which means a proposition of fact, which the one affirms, and the other denies. When an issue is arrived at, the parties can go no further; and the next step is to send the issue before a jury, that they may decide it. When the parties differ, not on a question of fact, but on one of law, it is called a demurrer, which must be decided by the court. In the practice of the English Court of Chancery, the pleadings are called by other names. The suit begins either by a bill or a petition, or a summons on the part of the plaintiff, and the defendant's pleading is called the answer. In Scotland, the pleadings of the parties are called the summons (including the condescendence), the defences or answers, the revised condescendence, the revised answers, &c. The peculiar technical rules to which the pleadings of parties must conform, are capable of being understood only by lawyers.

**PLEBEIANS** (Lat. *plebs*, from same root as Lat. *impleo*, to fill; and Gr. *plethos*, multitude), the common people of Rome; one of the two elements of which the Roman nation consisted. Their origin, as a separate class, is to be traced partly to natural, and partly to artificial causes. The foundation of Rome, probably as a frontier-emporium of Latin traffic (according to Mommsen's suggestion), would bring about the place a number of inferior employes, clients, or hangers-on, of the enterprising commercial agriculturists, who laid the primitive basis



of the material and moral prosperity of the city. These hangers-on were the original plebeians, or non-burgesses of Rome, whose numbers were constantly increased by the subjugation of the surrounding cities and states. Thus, tradition states that, on the capture of Alba, while the most distinguished citizens of that town were received among the Roman patricians, the greater part of the inhabitants, likewise transferred to Rome, were kept in submission to the *populus* or patricians of Rome—in other words, swelled the ranks of the plebeians. Similar transfers of some of the inhabitants of conquered towns are assigned to the reign of Ancus Martius. The order of plebeians thus gradually formed, soon exceeded the patricians in numbers, partly inhabiting Rome, and partly the adjoining country. Though citizens, they were neither comprehended in the three tribes, nor in the *curia*, nor in the patrician *gentes*, and were therefore excluded from the *comitia*, the senate, and all the civil and priestly offices of the state. They could not intermarry with the patricians.

The first step (according to traditionary belief) towards breaking down the barrier between the two classes was the admission, under Tarquinius Priscus, of some of the more considerable plebeian families into the three tribes. Servius Tullius divided the part of the city and the adjacent country which was inhabited by plebeians, into regions or local tribes, assigning land to those plebeians who were yet without it. The plebeian tribes with tribunes at their head, formed an organisation similar to that of the patricians. The same king further extended the rights of the plebeians by dividing the whole body of citizens, patrician and plebeian, into five classes, according to their wealth, and forming a great national assembly called the *Comitia Centuriata*, in which the plebeians met the patricians on a footing of equality; but the patricians continued to be alone eligible to the senate, the highest magistracy, and the priestly offices. These newly-acquired privileges were lost in the reign of Tarquinius Superbus, but restored on the establishment of the Republic. Soon afterwards, the vacancies which had occurred in the senate during the reign of the last king, were filled up by the most distinguished of the plebeian equites, and the plebeians acquired a variety of new privileges by the laws of Valerius Publicola. The encroachments on those privileges on the part of the patricians, began the long-continued struggle between the two orders, which eventually led to the plebeians gaining access to all the civil and religious offices, acquiring for their decrees (*plebiscita*) the force of law. Under the Hortensian law (286 B.C.), the two hostile classes were at last amalgamated in one general body of Roman citizens with equal rights. Henceforth, the term *populus* is sometimes applied to the plebeians alone, sometimes to the whole body of citizens assembled in the *Comitia Centuriata* or *Tributa*, and *plebs* is occasionally used in a loose way for the multitude or populace, in opposition to the senatorial party. See PATRICIAN.

PLEBISCITE, the name given, in the political phraseology of modern France, to a decree of the nation obtained by an appeal to universal suffrage. Thus, Louis Napoleon, for example, was chosen president, and subsequently emperor, by a plebiscite. The word is borrowed from the Latin; but the *plebiscitum* of the Romans properly meant only a law passed at the *Comitia Tributa*, i. e., assembly of the *plebs*, or 'commons,' as distinguished from the *populus*, or the 'nobles;' and although it was ultimately obligatory on both classes of the community, it, of course, could only refer to such matters as it was within the province of the *Comitia Tributa* to

legislate upon, and could not fundamentally alter or destroy the constitution.

PLECTOGNATHI, in the system of Cuvier, and also in that of Müller, an order of osseous fishes, but having the skeleton less perfectly ossified than osseous fishes generally; the skin furnished with ganoid scales or spines; and particularly characterised by having the maxillary and premaxillary bones anchylosed or soldered together. The gill-lid and rays are concealed under the thick skin, with only a small opening. The ribs are very short, and there are no distinctly developed ventral fins. The fishes belonging to this order are not many. They are regarded as a connecting link between the osseous and the cartilaginous fishes.

PLEDGE is the depositing of a chattel or movable with a creditor in security of a debt, and is a contract between the parties that the pledgee shall keep the chattel till the debt is paid. In England, when A pledges property with B for a debt, and other debts are incurred, B cannot retain the pledge for the additional debts; but in Scotland, this can be done. When chattels are pledged in England for debt, the pledgee may sell the goods, if the debt is not paid at the time agreed, or within a reasonable time after notice given; but in Scotland this can only be done by getting the authority of the sheriff and a warrant to sell the goods. Owing to the frequent occasions of poor and needy persons to pledge their goods in order to procure advances of money for temporary purposes, the legislature has enacted a code of special laws to regulate these contracts. See PAWNBROKING.

PLEIADES, in Greek Mythology, were, according to the most general account, the seven daughters of Atlas and Pleione, the daughter of Oceanus. Their history is differently related by the Greek mythologists: according to some authorities, they committed suicide from grief, either at the death of their sisters, the Hyades, or at the fate of their father, Atlas (q. v.); according to others, they were companions of Artemis (Diana), and being pursued by Orion (q. v.), were rescued from him by the gods by being translated to the sky; all authorities, however, agree that, after their death or translation, they were transformed into stars. Only six of these stars are visible to the naked eye, and the ancients believed that the seventh hid herself from shame that she alone of the P. had married a mortal, while her six sisters were the spouses of different gods. Their names are Electra, Maia, Taygete, Alcyone, Celaeno, Sterope (the invisible one), and Merope.

In Astronomy, a group or constellation of six stars placed on the shoulder of Taurus, the second sign of the Zodiac, and forming, with the pole-star and the twin Castor and Pollux, the three angular points of a figure which is nearly an equilateral triangle. Many believe, from the uniform agreement that the P. were 'seven' in number, that the constellation at an early period contained 'seven' stars, but that one has since disappeared; not a very uncommon occurrence.

The name *Poetical Pleiades* is frequently applied to reunions of poets in septenary groups; and this use of the word dates from the time of the Ptolemies—the originator of the first being Ptolemy Philadelphus, who, from the number of the Greek poets that flocked to Alexandria, chose out seven, whom he treated with special distinction, and denominated his *pleiad*. His example was followed by Charlemagne; and the same system was kept up by the 'Compagnie des Sept Mantenadors del gay Saber,' or the 'Compagnie des Sept Troubadours de

Toulouse, down till the 17th century. Such associations were valuable as promoting an interchange of ideas and opinions by the most eminent in the same department of letters, and creating a kind of *esprit du corps* among them.

**PLEIOCENE** (Gr. more recent), the name given by Sir Charles Lyell to a section of the Upper Tertiaries, because the organic remains found in it contain between 60 and 70 per cent. of living species; a greater proportion than exists in the older Miocene, but not so great as that found in the succeeding Pleistocene.

The beds belonging to this period are very local. They have been noticed in several places in Europe, but have been chiefly studied in Suffolk, the only locality in which they occur in Britain. Here they cover the upper beds of the London Clay; and being composed of shelly sand, they have, like similar deposits, been used for fertilising lands deficient in calcareous matter, and have received the local name of 'Crag.' They are divided into the (1) Red Crag, 50 feet; (2) Coralline Crag, 50 feet.

The Red Crag consists of beds of quartzose sands and gravel with a mixture of shells, for the most part rolled, and sometimes broken up into sand. The whole deposit, with the contained fossils, has a deep ferruginous or ochreous colour. It seems to have been formed in shallow water, the currents of which have given it a very variable character, and frequently confused the stratification, as in some modern sandbanks. The fossils have a somewhat boreal character. They consist chiefly of mollusca; but there have been also found the bones and teeth of large sharks, skates, and other fish, and the ear-bones of one or more true whales.

The Coralline Crag is generally calcareous and marly, consisting of a mass of shells and polyzoa, separated in some places by thin layers of hard limestone, and coral-like masses, which occupy the position in which they lived. It is easily separated from the Red Crag by its white colour. It has been formed at a greater depth and in more tranquil water than the newer deposit. The fossils have a more southern facies than those of the Red Crag, and indicate that they lived in an ocean with a higher temperature. Among these southern forms may be mentioned species of the genera *Conus*, *Oliva*, *Mitra*, *Voluta*, and *Pyrula*. The calcareous polyzoa are abundant and very beautiful; and several interesting forms of echini have been described. A few fossils of the same species as those occurring in the London Clay have been found in this and the Red Crag, but these are believed to have been washed out of the inferior deposits.

Mr Searles Wood has obtained 345 species of testacea from the Coralline Crag, and 230 from the Red Crag, of which about 150 are common to both; about 70 per cent. of the newer division are also recent, and about 60 per cent. of the older.

Pleiocene deposits have been observed in the neighbourhood of Antwerp and on the banks of the Scheldt, from which 200 species of shells have been obtained, two-thirds of which were already known from Suffolk. More than a half are recent species found in the northern seas, and a few are still living in the Mediterranean. Similar deposits occur in Normandy. The low hills between the Apennines and the sea on each side of Italy are formed to a considerable extent of beds belonging to this period; and the marine strata of the seven hills of Rome are of the same age. Beds of a brackish-water origin, observed on the shores of the Caspian, Aral, Azof, and Black Seas, have been referred to this period.

**PLEIOSAURUS** (Gr. literally 'more a lizard,')

i. e., than the *Plesiosaurus*), a genus of fossil sea-reptiles nearly allied to the *Plesiosaurus*, but having a very short neck, and comparatively a larger head. The jaws also are furnished with stronger teeth, which are subtriangular in cross section, with one side flattened, and bounded by prominent lateral ridges on the more convex sides. Three species have been described. They are peculiar to the Oxford and Kimmeridge clays of the Upper Oolite Period.

**PLEISTOCENE** (Gr. most recent), or **NEWER PLEIOCENE**, terms introduced by Sir Charles Lyell to designate the most recent Tertiary deposits, the organic remains of which belong almost exclusively to existing species. Within the last few years, no section of the earth's crust has received so much attention as the strata included under this name. The obscurity arising from great antiquity and metamorphic changes in deposits, and the consequent necessity of calling to some extent on the imagination in investigations into the older strata, have always thrown a peculiar charm round geology; but the examination of the little changed newer deposits, containing animals scarcely differing in genera from, and many of them the same even in species as, those now living, being based on simple observation, has been overlooked, although the best method in all obscure inquiries is that which starts from the known, and gradually proceeds to the unknown. The Palæozoic rocks have been carefully grouped and classified, and the fossils described and figured; while the order and contents of the Pleistocene deposits are little known. Their isolated nature to some extent accounts for this; but, on the other hand, as they exhibit the changes that have immediately preceded the present order of things, and so give us the first sure footing in our progress downwards, they deserve the most careful attention.

Not only in organic contents, but in the physical conditions under which they were deposited, the Pleistocene strata shew that the earth, as regards its general temperature, was, at the time of their deposition, in a condition nearly approaching to its present. There is consequently a considerable difference in the deposits and fossils of this period in the different regions of the world. The alluvial pampas of South America and the gravels of Australia exhibit, by their structure and contents, a temperature of some warmth; while corresponding deposits of Britain and the continent shew a state of cold that is scarcely conceivable at so recent a period. The whole of Northern Europe must have been under ice like the interior of Greenland at the present day. Perhaps the best classification of the deposits is one based on the relation which they bear to the temperature of the period when they were formed. The oldest Pleistocene deposits represent a time of intense cold. They were formed at the bottom of a sea into which immense glaciers forced their way. The fine mud in which the organic remains are buried was obtained from the melting glaciers. All the shells belong to species now living in arctic or boreal seas. The Bridlington beds, near Flamborough Head, consisting of sand, clay, and pebbles, with numerous marine shells, belong to this period. Of the 63 species determined by Dr Woodward, one-half are at present living only in seas north of Britain. The clay deposits on the east of Scotland, at Elie and Errol, lately described by the Rev. Thomas Brown, contain fossils that have a similar-arctic facies. The shells of the Bridlington, Elie, and Errol deposits differ from those of the other Pleistocene strata in being much more arctic, and they consequently shew that the cold had reached its climax at the time of their formation. To this period most probably belongs the boulder-clay of

PLEISTOCENE

the south of England, which contains erratics from Scandinavia. Both the clay and the boulders seem to have been transported to their present position by floating icebergs.

The temperature, however, after a time improved, reducing the extent of the ice-covering, and driving the arctic fauna northwards from our shores. In the Norwich Crag, we find a larger proportion of southern species, only one-sixth of these being truly arctic. This deposit, found in the neighbourhood of Norwich, consists of beds of sand and gravel which contain fresh-water and marine shells, and the bones of large mammalia. Contemporaneous with the Norwich Crag are the marine deposits of the Clyde, at least the older of them, for though the fossils of all the beds have hitherto been grouped together, they certainly represent two periods which differ from each other by reason of the increasing temperature. While these beds were being deposited around the shores, the ice was disappearing from the land. The glaciers were gradually creeping inwards, leaving an ever-increasing margin of bare land between the glaciers and the sea, which they covered with a continuous layer of mud and rubbed stones—the materials taken up in their progress over the surface—and so forming the boulder-clay of Scotland and the north of England. This is a remarkable deposit of unstratified mud, the character and colour of which is influenced by the rocks on which it rests, and from which it was derived. It contains numerous rounded and polished blocks of stone of various sizes, promiscuously scattered through it, the whole seeming to be the result of an irregular pell-mell hurrying forward and deposition of the materials. It has been always a puzzle to geologists (see BOULDER-CLAY); but Mr Geikie, in his recently published Memoir, by shewing it to be the terminal moraine formed by the slowly retreating sheet of glacier-ice, has given an explanation which meets all the singular phenomena connected with it. Connected with the disappearance of glaciers, are the lateral moraines which exist on many hillsides; and perhaps a little later, the long ridges of gravel which are called Kames in Scotland, and Eskers in Ireland. The loamy deposits of the valleys of the Rhine and the Danube, known as the Loess, were formed at this time by the fine mud from the glaciers, with which every torrent rushing from the icy caverns at the termination of a glacier is charged, and which is now forming a similar deposit in some places on the coast of Greenland.

When the glaciers began to disappear, mammalia again occupied the land; their remains, we have already seen, occur in the Norwich Crag. They continued to increase as the conditions for their existence improved. The caves of the British Islands and the continent were inhabited by hyenas, bears, and other wild beasts, which have left their remains buried in the mud at the bottom of the caves. The raised sea-beaches of this period contain the shells of mollusca now living in the neighbouring seas. In many places around the shores of Britain and Ireland, submarine forests are met with dipping down under low water, and exhibiting the stumps and roots of trees, in the position of growth, belonging to species now living in Britain. Some of the older peat-bogs require to be placed also among the later Pleistocene deposits.

The classification, then, of these strata, which we propose, from the light thrown on them by recent observation, may be put into the following tabular form. The subdivisions are the names of recognised deposits, and though arranged in tabular series, the order is not one of strict sequence, representing the superposition of the different beds; they are all very local deposits, and many of them, though

differing in character, were formed contemporaneously.

Post-Glacial.	{	Peat-bogs.
		Submarine Forests.
		Modern Raised Sea-beaches.
		Cave Deposits.
Glacial.	{	Loess.
		Kames and Eskers.
		Lateral Moraines.
		Boulder-clay.
		Newer Clyde Beds.
Arctic.	{	Older Clyde Beds.
		Elle, Errol, and Tirie Clay Beds.
		Bridlington Beds.

Many speculations have been made as to the causes of the remarkable change of temperature, from the comparatively warm period of the Pleiocene deposits, to the extreme cold of the early Pleistocene strata, and the subsequent gradual return to the warmer temperature of the present period. The most probable is, that it resulted from an extensive depression-of the land of the northern hemisphere in some parts, and its elevation in others during the period. Deposits of glacial shells have been found more than 1000 feet above the sea-level in Wales. A depression much less than this, in the Isthmus of Panama, would give a different direction to the Gulf Stream, and so deprive Western Europe of its benignant influences. It would also put the immense sandy Sahara under water; and that it has been so at a comparatively recent period, has been clearly established by the discovery lately of existing marine shells (including *Cardium edule*) over an extensive district of the desert. Without the Sahara, the south of Europe would have no burning dry airocco, which now melts the glaciers of the Alps; but instead, a comparatively cold sea-breeze, laden with moisture, which would to a large extent feed them. The existence of a greater quantity and a higher elevation of land near the North Pole would also depress the temperature. These and similar causes would do much, if they were not in themselves sufficient, to produce the extreme cold of the arctic period.

The classification of the British strata will suit, in a general way, the whole of the North Temperate Zone, for throughout the whole of the northern regions of Europe, Asia, and America, similar conditions existed, producing similar physical changes, and the whole region formed one zoological province inhabited by the Mammoth, Mastodon, and their contemporaries. A warmer climate prevailed at this period in South America, and the fossil animals there belong to types still peculiar to that continent, though of a size immensely greater than their living representatives. The Megatherium, Mylodon, and Megalonyx were the gigantic fore-runners of the living sloth; and the small armadillos were anticipated by the Glyptodon. The llamas, opossums, tapirs, and prehensile-tailed monkeys are the diminutive representatives of similar forms in the Pleistocene period. The peculiar marsupial fauna of Australia had also its gigantic fore-runners during this period. The skull of one species (Diprotodon, an animal between the kangaroo and the wombat), now in the British Museum, measures three feet in length. The huge wingless Dinornis, and its allies of New Zealand, were nearly allied to the small wingless Apteryx, now living in that island.

The question of the antiquity of man is intimately associated with the Pleistocene deposits. Whatever be the age of the beds in which either the remains of man or works of art have been found, it is certain that none of them pass the horizon of the boulder-clay. It is, however, equally certain that undoubted evidences of his existence contemporaneously with the mammoth and woolly rhinoceros,

## PLENISHING—PLESIOSAURUS.

with the cave-lion and hyena, have been found in Britain; and setting aside the various French and Belgian caves and gravel deposits about which geologists are, with good cause, so divided, there is evidence in the knives, pins, &c., manufactured from the bones of the large reindeer, found in caves at Bruniquel and elsewhere, that man hunted this huge extinct animal. Its contemporaries, as far as the associated remains from these caves have been determined, yet survive: these were the chamois, ibex, horse, fox, wolf, hare, raven, partridge, and salmon. However far, when measured by years, this carries back the first appearance of man on the globe, geologically speaking, the time is insignificant as compared with the vast lapse of ages represented by even a single formation; still it represents a period in which many remarkable changes have taken place, both in the climatal condition of Europe and in its animal inhabitants.

**PLENISHING**, in the law of Scotland, denotes the furniture of a house or stocking of a farm. The term is now seldom used, except in the law relating to heirship Movables (q. v.).

**PLE'ONASM** (Gr. *pleon*, more), a term employed in Rhetoric to denote superfluity of expression.

**PLESIOSAURUS**, (Gr. near to a lizard), a remarkable genus of fossil sea-reptiles, the species of which are found in the Lias, Oolite, and Cretaceous measures. Its remains are so abundant and so perfectly preserved, that we are as well acquainted with skeletons of many of its species as we are with those of any living animals. These represent a strange animal, the structure of which Cuvier considered to be the most singular, and its character

round the periphery. The cervical vertebrae consist of a centrum, neural arch, and two ribs, which articulate into two pits on the sides of the centrum. In the dorsal vertebrae, the ribs are articulated to diapophyses from the neural arch; and in the tail, they gradually descend again to the sides of the centrum. The tail is much shorter than in the ichthyosaur. In the abdominal region, the extremities of each pair of ribs are connected below by the development of the hæmal spine.

The two pair of limbs were equal in size and shape, with probably a single exception. The bones of the hind-limbs closely correspond in number, arrangement, and form with those of the fore-limbs, so that the descriptions of the one set answer to the corresponding bones of the other. The humerus is a stout and moderately long bone, curved slightly backwards, rounded at its proximal extremity, and flattened as it approaches the elbow joints. The radius and ulna are short and flat bones—the former straight, the latter reniform, with the concavity toward the radius. The carpus consists of six to eight flat round bones in a double row. The five metacarpals are long, slender, and slightly expanded at both ends. The numerous phalanges are alike in form, but progressively decrease in size. The radial digit has generally three; the second from five to seven; the third, eight or nine; the fourth, eight; and the fifth, five or six phalanges. The limbs were covered with integument, so as to form simple undivided paddles, as in the turtle.

The supposed habits of the plesiosaur are thus described by Conybeare: 'That it was an aquatic, is evident from the form of its paddles; that it was marine, is almost equally so, from the remains with

which it is universally associated; that it may have occasionally visited the shore, the resemblance of its extremities to those of the turtle may lead us to conjecture; its motion must have, however, been very awkward on land; its long neck must have impeded its progress through the water, presenting a

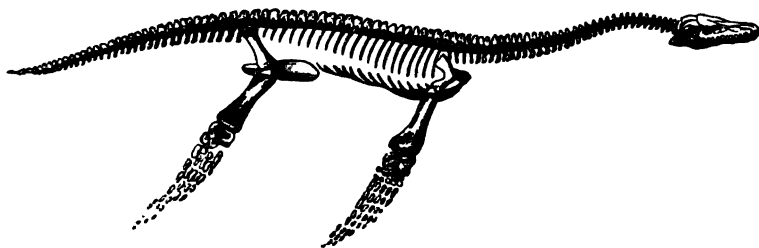

Plesiosaurus.

the most anomalous, that had been discovered amid the ruins of former worlds. In the words of Buckland: 'To the head of a lizard, it united the teeth of a crocodile, a neck of enormous length, resembling the body of a serpent, a trunk and tail having the proportions of an ordinary quadruped, the ribs of a chameleon, and the paddles of a whale.'

The skull is small and depressed. From the nostrils backwards, it is quadrate; it suddenly contracts at the nostrils, and is continued into a parallel-sided apex, which is sometimes slightly swollen at the point. No sclerotic plates have been found in the orbits. The rami of the lower jaw are remarkably expanded at their anterior ankylosed extremity. No intervening vacuity separates the angular and surangular pieces, as in the crocodiles, but they are joined throughout, as in the lizards. The teeth occupy distinct cavities; they are sharp-pointed, long, slender, circular in cross section, and with fine longitudinal ridges on the enamel. The most striking peculiarity of the vertebrae is the great length of the neck-portion, which is composed of from 20 to 40 vertebrae. The articular surfaces of the bodies of the vertebrae are either flat or slightly convex in the centre, with a concavity

striking contrast to the organisation which so admirably fits the ichthyosaur to cut through the waves. May it not, therefore, be concluded—since, in addition to these circumstances, its respiration must have required frequent access to the air—that it swam upon or near the surface, arching back its long neck like the swan, and occasionally darting it down at the fish which happened to float within its reach? It may perhaps have lurked in shoal-water along the coast, concealed among the sea-weed, and, raising its nostrils to the surface from a considerable depth, may have found a secure retreat from the assaults of dangerous enemies; while the length and flexibility of its neck may have compensated for the want of strength in its jaws, and its incapacity for swift motion through the water, by the suddenness and agility of the attack which they enabled it to make on every animal fitted for its prey which came within its reach.'

The first remains of this animal were discovered at Lyme Regis in 1822. Since then, twenty-two species have been described, the specific differences chiefly resting on peculiarities in the form and structure of the vertebrae.

## PLETHORA—PLEURISY.

**PLETHORA** (Gr. 'fulness' or 'excess'), designates a general excess of blood in the system. It may arise either from too much blood being made, or from too little being expended. The persons who become plethoric are usually those in thorough health, who eat heartily and digest readily, but who do not take sufficient bodily exercise, and do not duly attend to the action of the excreting organs. With them, the process of blood-making is always on the increase, and the vessels become more and more filled, as is seen in the red face, distended veins, and full pulse. The heart is excited and over-worked, and hence palpitation, shortness of breath, and probably a sleepy feeling, may arise; but these symptoms, instead of acting as a warning, too often cause the abandonment of all exercise, by which the morbid condition is aggravated. The state of plethora thus gradually induced may be extreme without any functions materially failing, and yet the subject is on the verge of some dangerous malady, such as apoplexy, or structural disease of the heart or great vessels, or of the lungs, kidneys, or liver.

Plethora is said to be *sthenic* when the strength and irritability of the muscular fibres (especially of the heart and arteries) are fully or excessively developed. This form commonly affects the young and active, and those of sanguineous nature. The blood is rich in red cells and fibrine; and there is a tendency to general febrile excitement, active hæmorrhages, fluxes, and inflammation. A natural cure is thus often effected by the supervention of an attack of bleeding from the nostrils or from piles, or of mucous or bilious diarrhœa. The plethora is said to be *asthenic* (Gr.  $\alpha$ , not; and *sthenos*, strength) when there is a deficiency of contractility and tone in the muscular fibre. In this case, the heart and vessels, instead of being excited (as in *sthenic* plethora) by the augmented quantity of blood, are oppressed by its load, and cannot duly expel their accumulated contents. The face is purple instead of red; the extremities cold, and the excreting organs sluggish. This form affects persons weakened by age, excesses, or previous disease. It tends to produce congestions and passive hæmorrhages, fluxes, and dropsies; and, if continued, structural changes, such as dilatation of the heart, enlarged liver, varicose veins, &c.

In *sthenic* plethora, blood-letting is the first remedy, and this, with the continued use of aperient medicine and a sparing diet, is often sufficient to complete the cure. If these means fail, recourse must be had to antimonials, salines, digitalis, and sometimes mercury or colchicum. In the *asthenic* form, Dr Williams (to whose article on 'Plethora,' in his *Principles of Medicine*, we refer our readers for further details) observes that 'the continued use of alterative aperients and diuretics, such as mild mercurials, with rhubarb, aloes, or senna, salines and taraxacum, nitric acid, iodide of potassium, &c., may prepare the way for various tonics, such as calumba, bark, and iron.' He also recommends the use of the Cheltenham, Leamington, and Llandrindod waters; first the saline, which are aperient and diuretic; and afterwards the chalybeate, which, although tonic, usually contain enough of saline matter to keep the secretions free. Food may be taken more freely than in the *sthenic* form; and in both varieties, as much exercise in the open air

should be taken as can be borne without causing exhaustion.

**PLEURÆ.** Each lung is invested externally by a very delicate serous membrane termed the *pleura*, which, after enclosing the whole organ, except at its root, where the great vessels enter it, is reflected upon the inner surface of the thorax or chest. That portion of the pleura which is in contact with the surface of the lung is called the

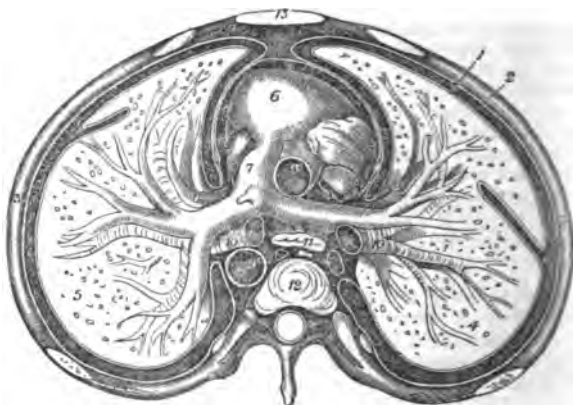

A transverse Section of the Thorax, shewing the reflections of the Pleura, and the relative position of the Viscera, &c.

(From Gray's Anatomy)

- 1, The visceral and, 2, the parietal layer of the pleura, on the right side;
- 3, 3, the ribs; 4, 5, section of the right and left lungs; 6, the heart;
- 7, the pulmonary artery, dividing into the right and left branches; 8, 8', the right and left pulmonary veins; 9, 9', the ascending and descending aorta, the intervening arch being cut away; 10, 10', the right and left bronchi; 11, the œsophagus; 12, body of dorsal vertebra; 13, the sternum.

*pleura pulmonalis*, or visceral layer; whilst that which lines the interior of the chest is called the *pleura costalis*, or parietal layer; while the space intervening between these two layers is called the *cavity of the pleura*. Each pleura, as will be at once seen by a reference to the figure, is a closed sac, and quite independent of the other. The interspace between the pleuræ on the right and left side, is termed the *mediastinum*, and contains all the viscera of the thorax excepting the lungs. The inner surface of each pleura is smooth, glistening, and moistened by a serous fluid; the outer surface is closely adherent to the surface of the lung, to the roots of the pulmonary vessels as they enter the lung, to the upper surface of the diaphragm, and to the walls of the chest. The lobes of the lungs are separated from one another by involutions or in-foldings of the visceral layer; two such involutions—one on either side—are shewn in the figure. The use of these serous sacs is much the same as that of the *Peritoneum* (q. v.); each pleura retains the lung and, to a certain extent, the greater vessels in position, while it at the same time facilitates, within certain limits, the movements of those parts which are essential to the due performance of the act of respiration.

**PLEURISY**, or inflammation of the investing membrane of the lung, is one of the most serious diseases of the chest. It is very often, but by no means invariably associated with inflammation of the *substance of the lung*, commonly known as *Pneumonia* (q. v.). Pleurisy without pneumonia is much more common than pneumonia without pleurisy. When both are present, but pneumonia preponderates, the correct term for the affection is *pleuro-pneumonia*, although it is frequently spoken of simply as pneumonia, probably in consequence

## PLEURISY—PLEURODYNIA.

of the remedies being applied mainly to it, as the more important of the two elements in the compound malady.

The pleura being a serous membrane, its inflammation is attended with the same course of events as have been already described in our remarks on the two allied diseases, *Pericarditis* and *Peritonitis*. The inflammation is of the adhesive kind, and is accompanied by pain, and by the effusion of serum, of fibrinous exudation (the *coagulable lymph* of the older writers), or of pus, into the pleural cavity. In consequence of the anatomical relations of the pleura—one part of the membrane (the parietal) lining the firm walls of the chest, while the other part (the visceral) envelops the soft and compressible lung; and these opposed surfaces being freely movable on one another—it follows that very different effects may be produced by its inflammation. For example, the visceral layer may be glued to the parietal layer, so as to prevent all gliding movement between them, and to obliterate the pleural cavity (similarly to what often happens in *Pericarditis*, q. v.); or the two surfaces which are naturally in contact, may be abnormally separated by an infusion of serum between them; or from a combination of these results, the opposite surfaces of the pleurae may be abnormally united at some points, and abnormally separated at others.

The general symptoms of pleurisy are rigors, pain in the side, fever, difficulty and rapidity of breathing, cough, and an impossibility of assuming certain positions; and of these, the most marked is the pain or *stitch in the side*, the *Point de côté* of the French writers. From the prominence of this pain, which occupies a single spot, and is of a sharp, stabbing character, the Latin writers term pleurisy *Morbis lateris*. This spot is usually about the centre of the mamma of the affected side, or just below it; but why the pain should be usually restricted to that one small spot, when the inflammation pervades a considerable extent of surface, is a question that has never received any satisfactory answer. The pain is, however, occasionally felt in other parts—as in the shoulders, in the hollow of the armpit, beneath the collar-bone, along the breast-bone, &c. Cruveilhier observes that the pain sometimes affects the loins, and simulates lumbago; while Andral and Dr Watson have directed attention to the fact, that the pain often affects the hypochondrium, and may be readily mistaken for a symptom of peritonitis, or (if occurring on the right side) of hepatitis. The pain is increased by percussion, by pressure between the ribs, by a deep inspiration, by cough, &c.; and the patient is often observed to suppress a natural desire to cough, or never to draw more than a short and imperfect inspiration. The cough is not invariably present, although it is an ordinary symptom. It is small, suppressed as far as possible by the patient, and is either dry, or accompanied by the expectoration of slight catarrh. If much frothy mucus is brought up, it is a sign that Bronchitis (q. v.) is also present, and the appearance of rust-coloured sputa indicates the co-existence of pneumonia. Although the above named symptoms, especially when most of them occur together, afford almost certain evidence of the existence of pleurisy, yet to the physician the physical signs are still more valuable, especially those furnished by percussion and auscultation.

Pleurisy far more commonly arises from exposure to cold than from any other cause, especially if a poisoned condition of the blood, predisposing to inflammation of the serous membrane, is present; but it may be occasioned by mechanical violence (as by a penetrating wound of the thorax by the splintered ends of a broken rib, &c.), or by the

accidental extension of disease from adjacent parts. The disease may terminate in resolution and complete recovery; or in adhesion, which often only causes slight embarrassment of breathing; or it may end with such a retraction of one side of the chest as to render the corresponding lung almost or totally useless: or it may cause death either directly by actual suffocation, if the effusion is very copious, and is not removed by tapping; or indirectly, by exhaustion. It is seldom, however, that simple pleurisy proves fatal.

In acute pleurisy, occurring in a robust and previously healthy subject, free blood-letting should be at once resorted to. If there is a sharp stitch in the side, and the respiration is short, quick, and restrained, the patient should be bled, in the upright position, from a large orifice in the vein, until the pain is relieved, and he can draw a full breath without discomfort, or until he is about to faint; and if the pain and difficult breathing should return, and the pulse continue firm and hard, either the venesection must be repeated, or leeches must be freely applied to the painful side. The bowels should be freely evacuated, after which calomel should be given, guarded with a little opium, to the extent of producing *slight* mercurialisation, with the view of checking the effusion of fluid. The more rapidly the system can be thus affected, the better, and hence it has been recommended (by Dr Walsh) that during the first six hours a grain and a half of calomel, combined with a sixth of a grain of opium (or more, if the pain continues acute), should be given every half-hour; while mercurial ointment is rubbed into the skin of the affected side, near the arm-pit, every fourth hour. Care must be taken that neither decided salivation nor narcotism is induced; and as soon as there is any evidence from the breath, or from the appearance of the gums, that the mercurial action has been established, the further administration of the calomel and the ointment must be suspended. After the pain and fever have ceased, we must facilitate the absorption of the fluid by diuretics. A pill composed of half a grain of digitalis, a grain of squills, and three grains of blue pill taken twice a day, usually acts efficiently; and the compound tincture of iodine of the London (*not* the British) Pharmacopœia, in doses of twenty minims, taken, largely diluted, three times a day, has been strongly recommended.

There has been considerable discussion of late years as to how far the operation of tapping the chest, and letting out the fluid, is justifiable in this disease. The best authorities are of opinion that in simple pleurisy it ought never to be performed unless (1) the life of the patient is in immediate danger from the continued pressure of the fluid in the sac; (2) unless all other means of getting rid of the fluid having failed, the patient is evidently losing strength daily; and (3) unless there is good reason to believe that the fluid consists of pus, in which case it should be let out. In all cases in which the operation is contemplated, a grooved needle should be introduced into the pleura. By this means, we not only ascertain the actual presence of fluid, but we discover its nature. If it be serous, it will flow readily along the groove, and trickle down the patient's side; if it be purulent and thick, a drop or two will probably be visible at the external orifice, and when the needle is withdrawn, its groove will be found to contain pus. The puncture thus made is quite harmless, and inflicts very little pain.

**PLEURISY ROOT.** See BUTTERFLY WEED.

**PLEURODYNIA** is a rheumatic affection of the intercostal muscles, and is characterised by acute pain in the side upon taking a full breath or coughing,

and by great tenderness on pressure. If it happens to be attended by slight febrile excitement, or by a cough, it is impossible to distinguish it from pleurisy, except by attending to the physical signs which characterise the latter disease. Cruveilhier maintains that 'pleurodynia is nothing more than adhesive pleurisy;' and in many cases of assumed pleurodynia, there is little doubt that the pain is due to old adhesions. The disease generally yields to local measures, such as blistering, or counter-irritation in a milder form by rubefacient liniments. A mixture of soap-liniment and chloroform rubbed over the affected part two or three times a day, often gives relief. In the more persistent cases, leeches may be applied with benefit.

**PLEURONECTIDÆ**, a family of fishes included in Cuvier's order *Malacopterygii*, but belonging to the order *Anacanthini* of Müller's system (see *MALACOPTERYGII*), and remarkable for a character to which there is nothing similar in any other vertebrate animals, a want of symmetry in the head, and for swimming not with the back uppermost, like other fishes, but with one side uppermost. The peculiar structure of the head adapts it to this mode of swimming, both eyes being on that side which is uppermost. Some of the bones of the head are distorted to a very considerable degree, but there is no want of symmetry in those of the body. The sides of the mouth are unequal. The body is extremely compressed, whence the P. are popularly termed *Flat Fish*, the back and belly being mere edges fringed by the dorsal and anal fins. The pectoral fins are generally unequal, also the ventral fins, those of the lower side being smaller than those of the upper. The upper side is often brown, or of some darkish colour, and variously marked; the lower side whitish. The colour of the upper side generally corresponds so much with that of the bottom, close to which these fishes swim, that they readily escape observation; and on this they seem chiefly to depend for safety, although, when hard pressed, they raise themselves in a vertical position, and suddenly throw themselves upward and forward to some distance, but then resume their ordinary posture, and as close to the bottom as possible. Their ordinary swimming is by a kind of undulating movement. They swim with great activity. They have no air-bladder. They abound chiefly where the bottom is smooth, either muddy or sandy. All of them are sea-fishes, but some are very common in brackish water, ascend rivers, and can be kept in fresh-water ponds. Many of them are in great esteem for the table. The turbot, halibut, brill, plaice, and flounder are examples of this family.

**PLEURO-PNEUMONIA**, in an epizootic form, first appeared amongst the horned cattle of Great Britain and Ireland in 1841. From time immemorial it had, however, been known in the great cattle-breeding plains of Central and Northern Europe. It consists in a sub-acute inflammation of the structure of the lungs and their investing membrane, shews a great tendency to early exudation, and is accompanied by low fever. It is contagious, but, like many other contagious disorders, it occasionally occurs independently of contagion, and is fostered by overcrowding, exposure to cold and wet, damp, dirty hovels, and other such causes, which depress the vital powers. The symptoms come on insidiously, appetite and rumination are irregular, there is fever, dulness, a short, half-involuntary cough, with quickened breathing and pulse. In cows, the yield of milk is early diminished. After three or four days, large portions of the lungs become filled with the products of

inflammation, hence the laboured breathing, quick indistinct pulse, wasting, and fatal weakness. Death generally occurs in from ten to twenty days. When pleuro-pneumonia first appeared in this country, it was greatly more fatal than it has since become, and fully four-fifths of the cattle attacked died; with prompt and rational treatment, more than one-half of the affected cases now recover. But as a favourable result is uncertain, and much flesh is lost even during a slight attack, it is still advisable, when pleuro-pneumonia breaks out in a herd, to consign to the shambles any of the cattle in good condition that have mixed with those diseased. The best treatment consists in avoiding bleeding and all reducing remedies, supporting the strength, and keeping up the action of the skin, bowels, and kidneys, in order that the poisonous products of the disease may be rapidly got rid of. For this end, the patient should be provided with a cool comfortable house, clothing to the body, bandages to the legs, a daily dose of two ounces each of nitre and common salt given in treacle and water. When the bowels are costive, gentle laxatives are required. By the second or third day, counter-irritants may be applied to one or both sides, which should first be bathed with hot water and thin mustard paste, or a mixture of cantharides and euphorbium ointments well rubbed in. By the third or fourth day, or earlier, if there is weakness, arrested secretion, and coldness of the skin, give several times daily some stimulant, such as a quart of warm ale, with an ounce or two of ginger or other stomachic, some good whisky-toddy, three-ounce doses of sweet spirit of nitre, or of spirit of ammonia. Whilst the disease continues, and even during early convalescence, all food requiring rumination must be interdicted, and mashes, flour and treacle, bruised grain, or any light digestible articles substituted for the ordinary hay, straw, or roots. As pleuro-pneumonia is in many cases propagated by contagion, the sick should be separated from the sound stock; and any premises they have occupied carefully cleansed by whitewashing, and the use of M'Dougall's, Condy's, or other effectual disinfectants. When pleuro-pneumonia prevails in a neighbourhood, all fresh purchases should be placed in quarantine, and kept perfectly away from the home-stock for at least three weeks. Attention to this simple precaution has preserved many farmers from pleuro-pneumonia, even while it has raged all around them.

**PLEXIMETER.** See **PERCUSSION.**

**PLEYEL, IGNAZ**, a musical composer of some note, born in 1757 at Rupperstahl, near Vienna. He studied music under Vanhall and Haydn, and made in early life an extensive tour in Italy, to hear the works of the best composers. In 1783, he was made *Capellmeister* of Strasburg Cathedral, and during the succeeding ten years, composed most of the works on which his popularity rests. In 1791, he visited London, and composed there three symphonies. Two years afterwards, during the frenzy of the French Revolution, he fell under suspicion, and in proof of his acquiescence in the new order of things, had to compose a musical drama for the anniversary of the 10th of August; which saved his life. After a long career in Paris as a publisher of music and pianoforte manufacturer, he retired to an estate which he had purchased near Paris, and died in 1831. His compositions, consisting of quartetts, concertantes, and sonatas, are full of agreeable melodies, sometimes light and trivial, but occasionally vigorous.

**PLICA POLONICA** is the name given to a disease of the scalp, in which the hairs become

matted together, by an adhesive and often foetid secretion, and which is especially prevalent in Poland, although it occasionally occurs in other countries. The hair is found, on microscopic investigation, to be infested with a fungus of the genus *Trichophyton*. The only treatment that is beneficial is the removal of the hair, and strict attention to cleanliness; but as it is popularly believed in Poland that this affection affords a security from all other sickness and misfortune, it is often difficult to persuade patients to have recourse to these means. For an account of the parasitic fungus that attacks the hair in this disease, and of the changes of structure which it induces, the reader is referred to Küchenmeister's *Manual of Parasites*, vol. ii. pp. 148—152.

PLINTH, the square member at the bottom of the base of a column. Also the plain projecting band forming a base of a wall.

PLINY (C. PLINIUS SECUNDUS), often called Pliny the Elder, and author of the celebrated *Historia Naturalis*, was born in the north of Italy, either at Novum Comum (Como) or Verona, 23 A.D. Whether it was his birthplace or not, the former town was certainly his family's place of residence, since he had estates in its neighbourhood; his nephew, the Younger Pliny, was born there, and inscriptions relating to members of his family have been found near it. While still young, he was sent to Rome, where his simple means and high connections secured him the best education. At the age of 23, he entered the army, and served in Germany, as commander of a troop of cavalry, under L. Pomponius Secundus, of whom, in later life, he wrote a memoir. He travelled over nearly all the frontier of that extensive province, visited the Cauca and the sources of the Danube, composed during the intervals of military duty his treatise *De Jactatione Equestri*, and commenced a history (afterwards completed in twenty books) of the Germanic wars. On his return to Rome in 52 with Pomponius, he entered on the study of jurisprudence; but his practice as a pleader proved him to have no great capacity for the legal profession; and accordingly, he retired to his native place, where he spent the greater part of the reign of Nero in miscellaneous authorship. It was during this period that he wrote his *Studiosus*, a treatise in three books on the training of a young orator from the nursery to his entrance on public life, and apparently intended to guide the education of his nephew; also his grammatical work, *Dubius Sermo*, in eight books. Shortly before Nero's death, we find him a procurator in Spain, where, in 71, he heard of his brother-in-law's decease, and of his being intrusted with the guardianship of his nephew, Pliny the Younger, whom he adopted on his return to Rome before 73. Vespasian, the reigning emperor, whom he had known while serving in Germany, received him as one of his most intimate friends; and it was at this period that he completed, in thirty-one books, and brought down to his own time, the Roman history of Aufidius Bassus. His mode of study at this time was a model of systematic assiduity. When living in the busy world of Rome, he would begin his studies by candle-light in autumn at a late hour of the night, and in winter at one or two in the morning. Before daybreak, he would call on the emperor, for whom he would proceed to execute various commissions; this done, he would return home, and resume his studies. A slender meal would follow; after which he would, in summer weather, lie in the sunshine, and take notes or extracts from the books which were read to him. The practice of jotting down important facts or

observations was habitual with him, and he was often heard to say that there was no book, however bad, from which some good could not be got. A cold bath, followed by a light meal and a short sleep, occupied another interval, after which he would study till the *cena*, or dinner-time. Even at this meal, some book was read to him, on which he would make comments. When in his country residence, he studied nearly all the time, except when in the bath; and even then, while his attendants were performing the duties incident to that luxury, he would be listening to some one who read to him, or he would be dictating to his amanuensis. When on a journey, again, he was never without a secretary at his elbow, provided with a book and tablets. By this mode of life, he collected an immense mass of materials, from which he compiled his great *Historia Naturalis*, published about 77. No fewer than 160 *volumina* of notes were found at his death, two years afterwards. The great eruption which, in 79, submerged Herculaneum and Pompeii was at its height when he was stationed off Misenum, in command of the Roman fleet. Eager to examine the phenomenon more closely, he landed at Stabiae, where he was suffocated by the vapours caused by the eruption. He was, as his nephew tells us, corpulent and asthmatic, and sunk the more readily. None of his attendants shared his fate.

Of all his works, only his *Historia Naturalis* has come down to us. It comprehends a greater variety of subjects than we now regard as included under that title. Astronomy, meteorology, geography, mineralogy, zoology, botany, everything, in short, which is a natural or non-artificial product, finds a place in P.'s Natural History. Even to this elastic interpretation of the term, he by no means rigidly adheres; the work being interspersed with digressions on such subjects as human institutions and inventions, and the history of the fine arts. It is divided into 37 books—the first of them being a dedicatory epistle to Titus, with a table of contents of the remaining books, and embraces, as we are told in the preface, 20,000 matters of importance, extracted from about 2000 volumes. Its scientific merit is not great. There is little attempt at philosophical arrangement; the observations are nearly all taken at second-hand, and shew small discrimination in separating the true from the false, or the probable from the marvellous. His meaning is often obscure, from his writing of things with which he was personally unacquainted, and from his having missed the true sense of the authors whom he cites or translates. But it cannot be denied that the work is a great monument of industry and research—most praiseworthy as having been constructed and completed amid the labour of other onerous undertakings, and amid the distractions of a life engaged in active official employment; and most valuable as supplying us with details on a great variety of subjects, as to which we have no other means of information. The best critical edition of the text is that of Sillig (Leips. 5 vols. 1831—1836). The best commentary is that of Panckoucke, which embodies, along with a French translation, the notes of Cuvier and other distinguished French savants. Pliny's work has been translated into almost all European languages.

PLINY (C. PLINIUS CÆCILIUS SECUNDUS), nephew of the preceding, and son of C. Cæcilius, frequently called Pliny the Younger, was born at Novum Comum, 61 A. D. He was still young when he lost his father, and was adopted by his uncle, under whose care, and that of his mother, Plinia, and his tutor, Virginius Rufus, his education was prosecuted. Passionately devoted to literature, he wrote a Greek



tragedy at the age of 13; studied eloquence under Quintilian; and became so famous for his literary accomplishments, that he acquired the reputation of being one of the most learned men of the age. His oratorical powers were also considerable; in his 19th year, he began to speak in the forum; and his services as an advocate before the court of the Centumviri and the Roman senate were in frequent request. He held numerous official appointments; served, while a young man, as *tribunus militum* in Syria, where he listened to the teaching of Euphrates the Stoic, and Artemidorus; was afterwards *quaestor Caesaris*; was praetor about 93, and consul in 100, when he wrote his *Panegyricus*, an adulatory eulogium of the Emperor Trajan, and containing little information as to the author and his times. He was appointed, in 103, propraetor of the province Pontica, an office which he vacated in less than two years; and he also discharged the function of curator of the banks and channel of the Tiber. He was twice married, his second wife being Calpurnia, grand-daughter of Calpurnius Fabatus, and considerably younger than her husband, by whom she was much beloved for her accomplishments and amiability. He had no issue by either marriage.

Our knowledge of P. the Younger is mainly derived from his letters or *Epistolae*, of which there are ten books. He collected them himself, and probably wrote many of them with a view to publication. They hold a high place in epistolary literature, and give us many interesting glimpses into the life of their author and his contemporaries. P. himself appears in them to considerable advantage, as a genial and philanthropic man, enamoured of literary studies, and fond of improving his estates by architectural ornament. His ample fortune was liberally bestowed; and his slaves always found in him an indulgent master. Interm health impaired throughout life his constitution, which was naturally weak; but of the time or cause of his death, we know nothing. Of the facts contained in his letters, however, the most interesting to us are those relating to the punishment of the Christians. Death appears to have been the penalty attached even to the confession of being a Christian; although the adherents of the faith admitted no other acts, on examination, than those of meeting on a fixed day before dawn, when a hymn to Christ was sung, and taking an oath to avoid theft, adultery, breach of faith, and denial of a deposit. Nothing more unfavourable to them than this could be extorted by P. from two female slaves, reputed to be deaconesses, whom he put to the torture. P. having asked Trajan how he was to stop the spreading superstition, the emperor replied that no general rule could be laid down; that he ought not to institute a search after persons supposed to be Christians; but if any were brought before him, and the charge was proved, such were to be punished, if still impenitent. The best edition of P.'s *Panegyricus* and *Epistolae* together, is that of Schaefer; of the *Epistolae* alone, that of Gierig.

**PLOCARIA**, a genus of *Algae*, of the order or suborder *Ceramiales*, having a cartilaginous frond, composed of large cells, as if jointed, and dividing into slender, tufted, and densely aggregated branches. *P. helminthochorton* is the CORSIKAN MOSS of the apothecaries' shops, once of some reputation as a vermifuge, but now little used, and believed to be of little efficacy. It is a small plant, with a filiform entangled frond, and grows on the shores of the Mediterranean. It has a strong marine odour and a salt taste. It consists in great part of a vegetable jelly or mucilage, which renders it nutritious, and contains much chloride of sodium, sulphate of lime, and carbonate of lime. As sold in the shops,

it is always much mixed with other algae.—*P. tenax* is a small plant with filiform, branched, and somewhat gelatinous frond, much used by the Chinese as a glue. It is also used in China as an article of food.—*P. candida* is used to a considerable extent as an article of food in the East. It is popularly called **CRYLON MOSS**. The frond is whitish and much branched, the branches long and somewhat clustered. It is exported to China from the islands of the Indian Archipelago, forming a portion of the cargo of almost every junk. The Chinese make it into a jelly with sugar, and use it as a sweetmeat. It consists in great part of a vegetable jelly, with a considerable quantity of starch. It has been introduced into Britain as a light and nourishing food for children and invalids, and is found particularly suitable in cases of irritation of the mucous surfaces.

**PLOCE'US**. See **WHAVER BIRD**.

**PLOCK** (Russ. Plotzk), a town of Poland, capital of the government of the same name, occupies an elevation on the right bank of the river Vistula, 78 miles west-north-west of Warsaw. Its principal buildings are the cathedral, built in 961, the bishop's palace, theatre, &c. Agriculture, and the export of grain to Danzig and other ports, are the chief employments. Pop. 10,604.

**PLOCK** (Russ. Plotzk), a government in the north of Poland, bounded on the north by Prussia, and on the south-west by Warsaw. Area, 6600 square miles; pop. 561,903, 80 per cent. of whom are Poles. Hills occur in the north and on the banks of the Narew and Vistula, which with the Bug are the chief rivers. One-third of the surface is covered with forests, and there are many marshes and lakes. The inhabitants are engaged chiefly in agriculture, and in cattle and sheep breeding.

**PLONGÉE**, in Artillery and Fortification, means a slope towards the front. Thus, in speaking of the course of a shell through the air, its plongée is from the point of greatest altitude to the point at which it strikes the earth. So, in fortification, the plongée is the top of the parapet sloping gently towards the front. This slope is ordinarily 1 in 6; but a deviation is permissible of from 1 in 9 to 1 in 4: the sharper the slope, however, the more liable is the crest of the parapet to be destroyed by an enemy's fire. Moreover, as flat a plongée as possible is desirable, that sandbags may, when required, be laid upon it to form a cover for riflemen. See **FORTIFICATION**, fig. 7.

**PLOTINUS**, the most original and important philosopher of the Neo-Platonic School, was born at Lycopolis in Egypt 205 A.D.; but such was his utter indifference to things human, 'being ashamed almost to live in a body,' that he never would divulge even his parentage. He would never allow his birthday to be celebrated, although he gave feasts on those of Socrates and Plato; nor would he ever permit a painter or sculptor to perpetuate his features, or, as he called it, to produce the image of an image—the body being to him only a faint image of existence. He deemed it tedious enough already to have to drag about this image whithersoever he went in this life. His body was altogether contemptible in his eyes; he would see no physician in his illness, and was very sparing in the use of food, refraining from meat, often even from bread. Strangely enough, his desire for the study of philosophy did not arise within him before his 28th year, when he repaired to Alexandria, and there, after having sat at the feet of the great masters for some time without feeling satisfied with their teachings, he at last became acquainted with Ammonius Saccas, and in him found the desired teacher. For ten years he

zealously attended his lectures, and although he had agreed, with two of his fellow-students, never to make known aught of Ammonius's teachings to the world, he yet became the chief representative and author of that school, less as a pupil than as an independent thinker, who taking his stand upon its theorems, developed them to their full extent. In 242 he joined Gordianus's expedition to Persia, in order to devote himself to the philosophy of India and Persia; but the emperor being murdered in Mesopotamia, he had to repair hurriedly to Antioch, whence, in 244, he went to Rome. His lectures here were attended not only by crowds of eager youths, but men and women of the highest circles flocked to hear him. Not only Platonic wisdom, in Neo-Platonic garb, but asceticism and the charm of a purely contemplative life, were the themes on which he, in ever-new variations, and with an extraordinary depth and brilliancy, held forth; and such was the impression his earnestness made upon his hearers, that several of them really gave up their fortune to the poor, set their slaves free, and devoted themselves to a life of study and ascetic piety. Dying parents intrusted their children and money to him, well knowing that an honest guardian, and one more anxious for his charges, could not be found. It is hardly surprising to find that his contemporaries coupled with his rare virtues the gift of working miracles. Sixty years old, he thought of realising Plato's dream, by founding an aristocratical and communistic commonwealth like the latter's 'Republic;' and the Emperor Gallienus was ready to grant the site of two cities in Campania for his 'Platonopolis;' but his courtiers prevented the fulfilment of this promise. P. died from a complication of diseases, in 270, at Puteoli, 66 years of age.

Although he began to write very late in life, he yet left 54 books of very different size and contents. His MS. being very carelessly written, he asked his pupil Porphyry to revise and correct it for him. The latter also divided it into six principal divisions, each subdivided again into nine books or *Enneads*. The most important parts are those which treat of Beauty, Fate, Immortality of Soul, the Good or One, the Three Original Substances, of Free Will, against Gnostics, of Providence, of the Genesis of Ideas, of the Influence of the Stars, of the Supreme Good, &c. The language is very unequal in the different portions, according to the mood and circumstances to which they individually owe their existence; but it always is original, compact, and graphic in the extreme.

P.'s system was based chiefly on Plato's theorem of the Ideas; only that while Plato assumed the Ideas to be the link between the visible and the invisible, or between the Supreme Deity and the world, P. held the doctrine of Emanation, that is, the constant transmission of powers from the Absolute to the Creation, through several agencies, the first of which is 'Pure Intelligence,' whence flows the 'Soul of the World,' whence, again, the souls of 'men' and 'animals,' and finally 'matter' itself. (For a fuller account of this part of P.'s system in its historical connection, see NEO-PLATONISMS.) Men thus belong to two worlds, that of the senses and that of Pure Intelligence. It depends upon ourselves, however, to which of the two worlds we direct our thoughts most and belong to finally. The ordinary virtues, as justice, moderation, valour, and the like, are only the beginning and very first preparation to our elevation into the spiritual realm; purification, or the exercise of *purifying* virtues, is a further step, to which we attain partly through mathematics and dialectic; and the abandonment of all earthly interests for

those of intellectual meditation, is the nearest approach to the goal. The higher our soul rises in this sphere of intellect, the deeper it sinks into the ocean of the good and the pure, until at last its union with God is complete, and it is no longer thought but vision and ecstasies which pervade it. These are a few smatches of P.'s philosophical rhapsodies, to which may be further added his mysterious belief in a kind of metempsychosis, by which souls, not sufficiently purified during life, return after death, and inhabit according to their bent, men, animals, and even plants. He further held views of his own respecting gods and demons, whom he divided into different classes, according to their degrees; and professed faith in Mantic, astrology, and magic, the conviction of the truth of which sciences he derived from his theory of the harmony in the intellectual world, reflected by the material world. Yet it is clear from his dicta on these subjects that he did not believe in these so-called sciences in the gross sense of the herd, but that he had a vague knowledge of those mysterious laws of attraction and repulsion which go through nature. P.'s philosophy, which, as it were, tried to combine all the systems of Anaxagoras, Parmenides, the Pythagoreans, Plato, and Socrates, and the Stoa into one, was the last and boldest attempt of the ancient Greek world to explain the mystery of the creation and of existence. Its influence upon modern philosophy is remarkable. From Spinoza to Schelling, the reminiscences of P., irrespective of the drift of particular parts of their systems, recur constantly.

P.'s works were well-nigh forgotten, when Marsilius Ficinus first published a Latin paraphrase of them (Florence, 1492), which was followed by the *Ed. Pr.* of the original (Basel, 1580 and 1615). The first critical edition, however, is due to Creuzer (Oxford, 1835, 4to, 3 vols.). Parts of his works were translated into German by Engelhard (Erlangen, 1820, &c.); and into English by T. Taylor (1794 and 1817). The whole of the *Enneads* has been translated into French by Bouillet (Paris, 1861, 8vo. 3 vols.).

PLOTUS. See DARTER.

PLOUGH, PLOUGHING. The first in order and importance of agricultural operations is the breaking up of the soil, and this is accomplished, in all countries where agriculture is in an advanced state, by inverting the upper stratum of earth upon which the plants grow. Such a mode not only effectually accomplishes the required object, but buries and destroys all weeds, leaving the surface clean and unencumbered. The inversion of the upper stratum is effected by turning over successive sods or slices, of the length of the field, and of varying thickness and depth, according to the nature of the soil; and the implement employed for this purpose is the *plough*. The general form of the plough is known to every one, and to the unobservant eye, it appears to be a very simple and even primitive tool; nevertheless, much mechanical skill and ingenuity have been expended in perfectly adapting it to its work. It is a combination of instruments (fig. 1) fastened to a beam, GBL; the *coulter*, K, is an iron knife-blade, for cutting the sod vertically; the *share*, CFD, which is merely a socket fitted on and not fastened to the body of the plough, has a sharp point, C, and a projecting horizontal edge, CO, on its right-hand side, its part of the work being to separate the under-surface of the sod from the subsoil; by means of the *mould-board*, H, the slice, now wholly separated from the firm ground, is raised up and turned over by the forward motion of the plough; and the *stills*, or

## PLOUGH, PLOUGHING.

handles, one of which, BL, is a continuation of the beam, the other, M, being fastened partly to the former by rods, and partly to the lower portion of

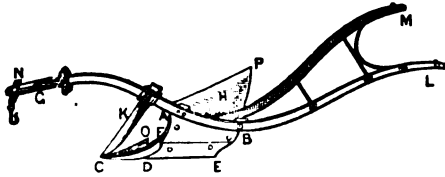

Fig. 1.

the framework (fig. 2, which also shews the point of the plough with the share removed), are for the purpose of guiding the implement. The front

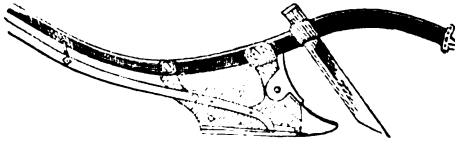

Fig. 2.

part of the beam is formed with an upward curve; at its extremity, is placed the *bridle*, N, to which the horses are attached by means of swing-trees and chains or traces, and the object of which is to enable the workman to elevate or depress the line of draught, or move it to the right hand or the left, as may be found necessary. The left sides of the coulter, share, and framework ADEB, should evidently be in the same vertical plane. The form of the mould-board is of the utmost importance, and has chiefly attracted the attention of agricultural machinists since the time when improvements on the plough were first projected. Its office being to raise and turn the sod, it is necessary that the surface should slope upwards and outwards from the front, so as to apply a pressure in both directions, and, accordingly, the surface is so shaped that from the point of the share, where it is horizontal, it gradually curves upwards, till, at the extremity, P, it inclines over away from the body of the plough. The gradual change produced on the position of the furrow-slice is seen in fig. 3, where ABCD on the left-hand side,

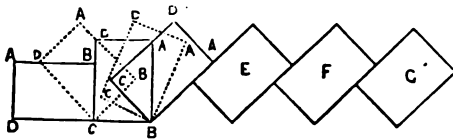

Fig. 3.

represents the slice untouched by the plough, AD being the line of section by the coulter; DC, by the share; BC, the open side from which the previous furrow (E) to the right-hand side has been separated; and the four successive rectangles, ABCD to the right, illustrate the successive changes of position of the furrow as the mould-board is pushed forward under and on its left side, till it is finally left, as represented in ABCD on the right hand; E, F, G are furrows which have previously been laid in their proper position. The advantages of laying the furrows in the position shewn are these: in the first place, the weedy side of each furrow being closely applied to the previous furrow, and kept pressed against it by

its own weight, the weeds are completely buried; secondly, the ridged surface thus presented, affords the means of covering the seed by harrowing; and lastly, the openings below increase the amount of surface accessible to air, and drain off superfluous water. The plough is wholly formed of iron; the share and the framework of malleable, and the mould-board of cast iron; while the coulter is frequently welded with steel on the right-hand side, the better to resist attrition. In most of the English (as distinguished from the Scotch) ploughs, wheels are attached at or near the front end of the beam, a contrivance which renders the implement more steady in its motion, more easily managed, and capable of doing better work in the hands of an inferior workman; but it is generally believed, in Scotland at least, that the plough without wheels, or *swing-plough*, as it is technically termed, is greatly more efficient in the hands of a thoroughly skilled ploughman. The usual dimensions of the furrow-slice in lea or hay-stubble are 8 or 9 inches in breadth by 6 in depth; and in land for green crop, 10 inches in breadth, and 7 or 8 in depth; though shallower ploughing is not unfrequently adopted, especially on thin soils.

Other kinds of ploughs are used for special purposes, such as *trench-ploughs*, which are made on the same principle as the common plough, but larger and stronger, so as to bring up a portion of the subsoil to the surface; *subsoil ploughs*, which have no mould-board, and merely stir and break up the subsoil, thus facilitating drainage; *double mould-board ploughs*, which are merely common ploughs with a mould-board on each side, and are employed for water-furrowing, or for earthing up potatoes, &c. Of each of these ploughs, there are many varieties, each maker having generally some peculiar views regarding the form and proportion of some parts or the whole of the instrument, and this is specially the case at the present time, when competition between makers has become so active. For those who wish to study minutely the best form of plough, it will be necessary to consult works on agriculture and agricultural implements. There is, however, one very peculiar form of plough much used in various parts of England, which deserves more particular notice; this is the *turn-wrest plough*. Its chief peculiarity is, that instead of one, it has two mould-boards, one on each side, and these are alternately brought into operation, so that the furrow is always turned over in the same direction. The mould-boards are firmly fastened together in front, and kept at a constant distance from each other behind, by means of struts, while the handles are movable with reference to them; the mould-board which is intended to be used being pushed away from, and the other (which for the time does the same work as the vertical surface ADEB in fig. 1) brought nearer to the line of the beam; of course, when the next furrow is ploughed, the mould-boards exchange adjustments. This form of plough is very useful in



Fig. 4.

ploughing along a hillside, as by it all the furrows can be turned over towards the hill, thus preventing the natural tendency of the soil to work itself

## PLOUGH, PLOUGHING.

downwards, leaving the upper portions bare. The form (fig. 4) here given is the rudest and least desirable form of the turn-wrest; it is that which is used in Kent, and there much esteemed.

The operation of ploughing we can only notice briefly. The usual breadth of a ridge being taken as 18 feet, the ploughman sets up a line of poles along the middle of the first ridge, to guide him in a straight line. Along this line marked with poles he drives his plough, throwing out a furrow, and after reaching the headland,\* turns his horses, and returning on the same track, throws out a furrow on the opposite side. He then enters his plough on the left side of the double furrow, at a distance of 8 to 10 inches, according to circumstances, and throws back the furrow previously thrown out on that side; returning by the other side, and doing the same with the other thrown-out furrow. This process is termed *feering*. He has now two furrows turned up and leaning against each other, and he then proceeds to add furrow to furrow on each side alternately of the first pair, till a whole ridge is completed; or he may (which is the preferable plan) plough the inner half of the first ridge and the first half of the second ridge. This process is termed *gathering*; and a repetition of it on the same land, *twice-gathering*; but this is only practised on strong wet land.

*Cleaving* is the opposite to gathering, the furrows in the former case forming the centre of the ridge of the latter, and the position of all the furrows being reversed. *Casting* or coupling ridges is now by far the most common method of ploughing, and consists in the formation of ridges of 36 feet, or twice the usual width, the first feering being made close along the side of the field, and the next at a distance of the width of two ridges, and so on.

The first essential property of every plough is, that it shall throw the furrow cleanly off the mould-board; the next, that it shall lay it in that position which best exposes the soil to the action of the air, hence care must be taken that the mould-board be neither too long nor too short, as in the former case it plasters up the surface of the furrow, and in the latter destroys its form.

The plough is one of the most ancient implements, and is mentioned in the Old Testament at a

instances consisted of little more than a pointed stick, which was forced into the ground as it was drawn forward. In fact, the earliest ploughs were neither more nor less than varieties of the *Hoe* (q. v.), worked by pressing the point into the ground

instead of by percussion. The earliest form of the Greek plough, the *autoگون* (fig. 5, a), is an example of this; it was merely the trunk of a small tree, which had two branches opposite to each other, one branch forming the share and the other the handle, while the trunk formed the pole or beam. The more improved form, the *pektion*, in use among the Greeks, was not substantially different from the modern form in use in Mysia (fig. 5). The ancient Egyptian plough in one of its early stages is represented in fig. 6, and, like the two forms above described, is devoid of all apparatus enabling the labourer



Fig. 6.



Fig. 7.—Modern Syrian Plough.

to guide it, all that he can do being to press (by his weight applied to the handle) the share into the earth. The Egyptians, however, gradually improved the form, till it assumed the appearance of a hollow wedge formed by the two handles joined at the bottom, and with the beam fastened between the handles a little above their point of junction. The share was the point of the wedge, and the handles were placed almost upright; this is in all essential particulars the 'araira' still used in many rural districts of France, and also corresponds very closely to the modern Syrian plough (fig. 7). The Romans, an essentially practical nation, largely improved on the plough, adding to it the coulter and mould-board, and occasionally attaching wheels to the beam to prevent the share from going too deep into the earth (fig. 8). A later and more improved form, in which the handles were made to incline backwards and the coulter was placed so far back as to be directly above the share, is still in use in the north of Italy. The ploughs used in the present day in most other parts of the continent are equally rude and inefficient with the French and Italian implements. The plough was almost unknown among the American aborigines, though Prescott describes a mode of ploughing practised among the Peruvians, which consisted in the dragging forward of a sharp-pointed stake by six or eight men, its sharp point, which was in front, being kept down in the ground

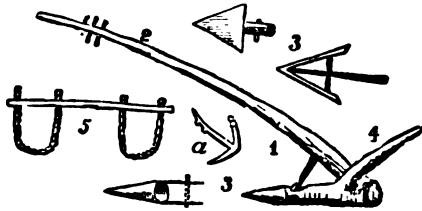

Fig. 5.

1, the Mysian plough; 2, its pole, where the oxen are attached; 3, shares of various forms; 4, the tail or handle; 5, the yoke; a, early Greek plough.

very early period, iron shares being also incidentally noticed more than seven centuries B.C. The ancient Egyptian plough was wholly of wood, and in some

\* The headlands or head ridges are two ridges, one along the top, and one along the bottom of the field, which are not ploughed till the rest of the field has been completed.

## PLOUGH, PLOUGHING.

by the pressure of the foot of another man who directed it. Britain and America, and their colonies, are the only countries in which the plough has been

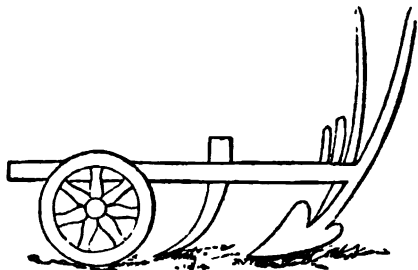

Fig. 8

brought to a state worthy of being considered effective, and even in Britain the most important amendments on it are not two centuries old. England took the lead in improvement by rendering the form more neat and effective, and by attaching wheels to aid in keeping the plough in a proper upright position. In Scotland, for some time after this, the plough was extremely rude and cumbersome, and usually drawn by 8 oxen; but in the middle of the 18th c., some Dutch ploughs were imported, and being found more effective, an impetus was thus given to attempts at improvement. James Small, who may justly be regarded as the real inventor of the Scotch or swing-plough, made great and important changes in the form and efficiency of the coulter, share, and mould-board, producing an implement at once lighter and vastly more efficient. All the swing-ploughs of successive makers are founded upon the basis of Small's plough. Wilkie of Uddingston (Lanarkshire) formed it wholly of iron, and his modification has been universally adopted in the modern ploughs. Among the various improvers of this form of cultivator may be mentioned, besides Wilkie of Uddingston, Gray of the same place, Clarke of Stirling, Cunningham, Barrowman, Ponton, Sellars, &c. In England, swing-ploughs are occasionally met with, but the wheel-plough is the one generally used; like its Scotch neighbour it had many defects, which have been gradually remedied, chiefly by Ransomes of Ipswich (the patentee in 1785 of the cast-iron share), Howard of Bedford, Hornsby of Grantham (Lincolnshire), and Busby of Bedale, the last of whom gained a medal for his mould-boards at the Great Exhibition of 1851. The English and Scotch ploughs differ from each other in many important particulars, especially in the form of the mould-boards and in the adjustment of the coulter, the first being chiefly adapted for shallow, and the latter for deep, ploughing. In the Cotswold district, a plough constructed of wood, and with a wooden mould-board (the *Beverstone Plough*), is in general use, and is found sufficiently well adapted for the shallow ploughing there practised. For further information concerning the plough and the mode of using it, see Morton's *Cyclopædia of Agriculture* (1856), Stephens' *Book of the Farm, Book of Farm Implements*, by Henry Stephens and R. Scott Burn, and other works.

*Steam-ploughing.*—Although it is not yet ten years since cultivation of the land by steam came into successful operation, it is about two centuries and a half ago since it was foreseen to be possible. So long ago as 1618, David Ramsey and Thomas Wildgosse took out letters-patent for engines and machinery to plough the ground without the aid of oxen or horses; and nine years

afterwards, other ingenious men obtained letters-patent for machines to affect a similar purpose. It is the opinion of Mr Woodcroft of the Patent Office, who compiled the *Abridgments of the Specifications Relating to Steam-culture*, that steam was the motive power intended to be employed; but as the first patent was taken out nearly 40 years before the Marquis of Worcester described the steam-engine in his *Century of Inventions*, the grounds for such an opinion do not seem quite satisfactory. In 1769, however, after the steam-engine had been applied to other purposes, there was lodged in the Patent Office a specification for a new machine or engine, to plough, harrow, and do every other branch of husbandry, without the aid of horses. The patentee was Francis Moore; and so confident was he of the merits of his plan, that he sold all his own horses, and persuaded his friends to do the same; 'because the price of that noble and useful animal will be so affected by the new invention, that its value will not be one-fourth of what it is at present.' Moore, however, was much too sanguine; his method of cultivating the land without the aid of animal power failed, as those of others before him had done.

The next invention that it is here necessary to mention was one by Major Pratt, patented in 1810. His plan was to have two engines, one on each headland, drawing, by means of an endless rope, an implement between them. In order to save the labour and loss of time in turning the plough at the ends, he attached two ploughs, back to back, making them work upon a fulcrum in the centre of a frame, so that one could be raised out of the ground when the other was working. This was the first adoption of the balance-principle, now employed in most implements used in steam-cultivation. Major Pratt's apparatus, like those of his predecessors, never came into practical operation.

In the interval between 1810 and 1832, when Mr Heathcoat, M.P., a Tiverton lace-merchant, patented the first steam-ploughing machinery that ever wrought successfully in the field, there were many inventions, but these being of little utility, need not be particularised. Mr Heathcoat's machinery was principally intended for draining and breaking up soft or swampy land. It consisted of a locomotive steam-engine, with a broad, endless, flexible floor or railway attached to the wheels, so as to prevent them from sinking in the boggy soil. Opposite to this engine, an auxiliary carriage was placed, and between the two the plough was drawn backwards and forwards by an endless chain or band—engine and carriage moving along as the work proceeded. In 1836, this plough worked with tolerable success in Red Moss in Lancashire, and in 1837 it was tried near Dumfries, under the auspices of the Highland and Agricultural Society of Scotland; but here its performance, though in some degree satisfactory, was not sufficiently so to warrant the judges in awarding to it the prize of £500, which had been offered for the first successful application of steam-power to the cultivation of the soil by the Society. The apparatus was very cumbersome and expensive to work, the engine being 25 horse-power, and the number of men and boys employed in the operation no less than ten. The amount of work done was at the rate of 8½ acres per day. Mr Heathcoat abandoned the machine after having spent about £12,000 on it.

After Mr Heathcoat, the inventors specially worthy of mention are Alexander M'Eaa, who, arranging his motive-power in the same manner as Major Pratt, made the important addition of a barrel to the plough-frame upon which the slack-rope was to be wound up; Mr Hannam of Burecoats, who, in 1849, designed an apparatus to be driven

## PLOUGH, PLOUGHING.

by an ordinary portable engine, to be stationed at the corner of the field, which was surrounded with wire-ropes in the same way as will be afterwards described in Howard's method; and Mr Tulloh Osborn, who, in 1846, patented a plan for two engines running opposite each other on the headlands, having two drums fixed to them, one for the winding of the tight, and the other for letting out the slack, gear. This apparatus was tried by the Marquis of Tweeddale for some time at Yester; but it was found, in consequence of the great power required, and other defects in detail, to be very expensive, and was ultimately given up. To the Marquis of Tweeddale, therefore, belongs the honour of being the pioneer of steam-cultivation in Scotland.

In 1855, the Messrs Fiskien of Stamfordham, Newcastle-upon-Tyne, took out a patent for a much more perfect apparatus for cultivating the land by steam than any that had previously appeared. The power was transmitted by a stationary engine to a hempen rope (the Messrs Fiskien being anxious to dispense with wire-ropes), which was worked at a high velocity, and, passing round pulleys on two self-moving anchors, turned a drum upon the plough, whose revolution imparted motion to the implement upon which it was fixed. The important features in this system were the self-propelling anchors, the arrangement of the ploughs on the balance-principle, and the mode of steerage. This plough was exhibited at the annual show of the Royal Agricultural Society of England in the year the patent was taken out, and excited great interest, but failed to obtain any award. Three years before this, the Highland and Agricultural Society of Scotland had thought so hopefully of the idea, that a grant was voted out of its funds to assist the author in maturing his project.

In 1854, Mr Fowler exhibited his patent steam-draining apparatus at the Lincoln meeting of the Royal Agricultural Society of England; and from this time may be dated the practical history of cultivation of the land by steam; for the idea that such an apparatus could be wrought advantageously in other field-operations entered the mind of a practical farmer, Mr Smith of Woolston, near

Bletchley; and under the direction of Mr Fowler, he got constructed an apparatus, which, with modifications, he has been working successfully ever since.

The inventions since that time need not be enumerated. It may be stated generally that they have included plans for engines travelling over the surface of the ground, drawing ploughs or other cultivating implements along with them; engines working on tramways, and drawing implements after them; engines moving along opposite headlands, and working implements between them by means of wire-ropes, and stationary engines driving implements also by means of wire-ropes. The first two principles have been abandoned—the one on account of the great consumption of fuel, and the large amount of wear and tear occasioned to move the engine over uneven and soft ground; and the other, on account of the expense necessary to lay down rails over a farm. The only two systems in practical operation are what are called the direct and round-about—the former where the pull of the implement is directly to and from the engine; and the latter where the implement is drawn at right angles.

These methods are best known as Fowler's and Howard's, though, perhaps, Smith should be credited with the round-about system, but Howard's name is now much more generally given to it.

Fowler's system we hope to make intelligible by the aid of cuts. The principal elements are an engine, an anchor, a wire-rope, and a balance-plough. In commencing operations, the engine is placed at the end of one of the headlands of the field, and directly opposite it on the other headland is placed the anchor. Beneath the engine there is a large sheave or drum, five feet in diameter, the groove of which drum is composed of a series of small leaf-like pieces of chilled cast-iron, each moving independently upon its own axis. The object of these is to prevent the rope from slipping (which it is apt to do in a plain groove under great strain), and this they do in a very ingenious manner, by closing on the rope as soon as it takes the bend—that is, as soon as the rope presses upon them—and they in the same manner open and release it immediately on the pressure

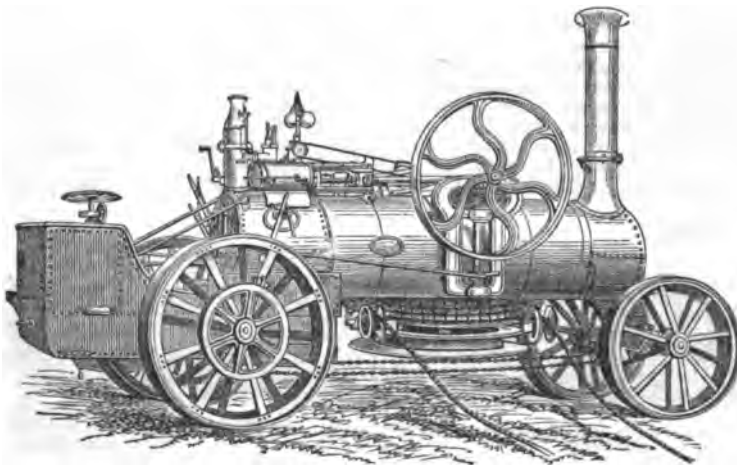

Fig. 9.—Fowler's Steam-engine.

being removed, or, in other words, as soon as the rope resumes the straight on the other side of the sheave. The position and nature of this drum on the engine will be understood by the accompanying cut. The

anchor, as will be seen from the engraving (fig. 10), is a massive square framework of wood, mounted on six sharp disc wheels, each about two feet in diameter, which cut deep into the ground, and on the lightest

## PLOUGH, PLOUGHING.

land they take such hold as effectually to resist the pull of the rope which is passed round the sheave beneath. The anchor has a self-acting motion—

the power being communicated from the engine through the medium of the ploughing-rope—which enables it to move along the headland, and

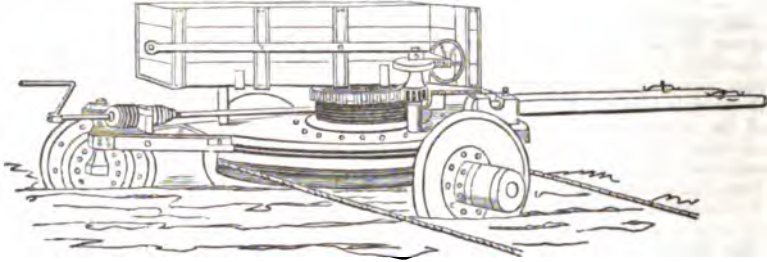

Fig. 10.—The Anchor.

keep opposite to the engine. The plough (fig. 11) is a framework of iron, balanced upon two large wheels. To each side of this framework there are attached four plough-bodies and coulters, so that four furrows are cut at one 'bout,' and the headland on which the anchor is stationed being reached, the end of the beam that was out of the ground is depressed (the other, of course, being raised), and the four plough-bodies that were out of the ground, and which point in the opposite direction, are

inserted in the soil, and turn up the furrows on the way back to the engine. By altering the position of the plough-bodies along the frame-work, a broad or a narrow furrow can be cut at pleasure. In ordinary working, an acre an hour is accomplished. The wire-rope, by which the plough is dragged through the land, passes round the sheaves on the anchor and the engine, the ends are attached to two drums upon the plough; and by a nice mechanical arrangement, the ploughman who rides

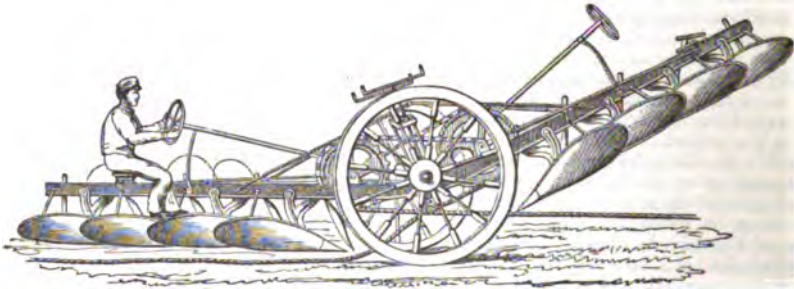

Fig. 11.—Fowler's Plough.

upon the implement is enabled to wind up, or let out slack if necessary, without loss of time. The wire-rope is made in lengths, which are easily disjoined, in order that it may be adjusted to irregularly shaped fields, or rather to fields that are not exact squares or parallelograms; for Fowler's method is not well adapted to such irregularities as prevent the engine and anchor being opposite each other. The rope is borne off the ground—a very

necessary precaution, without which the wear and tear would be alike annoying and expensive—by a number of pulleys, or 'rope-porters' as they are called, mounted on frames. The outside ones, that is, those farthest from the work, are moved along by the action of the rope; those in front of the plough are removed by boys, and placed behind the implement as it proceeds. The *modus operandi* will be patent at a glance, from the annexed plan of



Fig. 12.—Fowler's Anchor, Engine, and Plough at work.

working (fig. 12). To manage this apparatus three men and two boys are required—namely, a man at the engine, another on the plough, a third at the anchor, and the lads to look after the rope-porters. The water and coals needed for the engine must be brought by other men.

The plough-bodies can be removed from the frame, and in their place 'digging-breasts' be attached, by means of which the land is thrown up in a somewhat similar manner to that in which it is turned over by the spade. The price of the ploughing and cultivating apparatus is as follows: 14-horse

## PLOUGH, PLOUGHING.

power double-cylinder engine, with self-moving and reversing gear, with tank, steerage, 20-inch wheels, clip-drum, 150 yards headland rope, snatch-block, spuds, tools, and tool-box, complete for steam-cultivation, £614; self-moving anchor, with six discs, lifting jack, headland ropes, and all tools complete, £55; four-furrow balance-plough, fitted with slack gear, digging and scarifying breasts, £97; 800 yards best steel rope, fitted with eyes and joints, £84; 10 large, and 10 small, rope porters, £25. Total, £875. Of course, in the case of an engine of less horse-power being required, the price is proportionately lower. At the Newcastle show of the Royal Agricultural Society, in July 1864, Mr Fowler introduced two engines of 7-horse power, working simultaneously on opposing headlands. The expedition with which these engines were set down to and completed their work was a matter of admiration to all present, and the subject of special remark by the judges. These gentlemen say: 'The engines worked smoothly; and so far as we could ascertain, appeared to bear an equal share of work in either direction.' They got up steam in nearly half an hour less time than the 14-horse engine, and working with them, much less time was required to arrange the tackle. 'The engines were masters of their work; and acting in combination, appeared to

possess more power than the large engine and anchor. . . . The advantages of this system appear to be, that horses are not required to move tackle; that there is a saving of time in setting down, taking up, and removing from field to field [no unimportant consideration]; and that the two small engines are both available for ordinary farm-work, such as thrashing, driving, barn-work, &c.' The cost of the two engines, with their apparatus, is £1066. The number of hands employed is the same as at the large anchor and engine; but as a skilled labourer is necessary where only an unskilled labourer is needed in the latter case, the cost per day is 2s. more; working the large engine and anchor, including the cartage of water and oil, is estimated at 16s. per day; the two engines at 18s. Fowler has been most successful in carrying off the prizes at all the competitions of steam-ploughs, having received in this way, since 1856, nearly £3200, besides gold medals.

Howard's system consists in a stationary engine driving a windlass, having two winding drums, with direct and reverse action, placed in front of it, round which is coiled about 1600 yards of wire-rope. By a simple lever movement, the man can drop the winding drums out of gear in an instant, a contrivance which enables him to attend to the proper



Fig. 13.—Howard's General Plan.

coiling of the rope, and also to arrest, in case of accident, the plough in a moment, without stopping the engine. The engine is usually placed at the corner of the plot to be ploughed, the rope is carried round the field on rope-porters, and fixed at the corners by light anchors. A snatch-block placed in front of the windlass prevents the slack-

rope running out too fast, and trailing on the ground. The plan of working given clearly illustrates the arrangement (fig. 13). The plough, as will be seen from fig. 14, is composed of two strong iron frames balanced upon four wheels, and crossing each other at their inner ends, thereby decreasing the length of the plough, and, as a matter of course, the

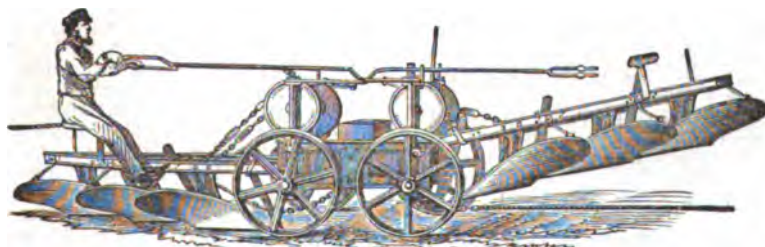

Fig. 14.—Howard's Plough.

breadth of the headland. The frames are raised and lowered in such a manner that the set of the ploughs out of work is independent of, and has no

tendency to weigh or raise out of the ground the set in work. The frames are made for two, three, or four furrows, and 'diggers' or scarifiers can be



## PLOUGHGATE OF LAND—PLOVER.

attached the same as in Fowler's. It should be mentioned that the Messrs Howard prefer the cultivator, that is, a machine to smash up the land rather than the plough, and the plough is not included in the cost given below. In this method the plough is not pulled direct between engine and anchors, but at right angles to the engine—between one anchor and another, the anchors being removed inwards by manual power, and nearer the engine every time the field is traversed by the plough. With this system there are five men and two boys required; viz. a man at the engine, another at the windlass, a third on the plough, two at the anchors, and the boys to look after the rope-porters. The cost of this apparatus—which, exclusive of engine, consists of the patent windlass, 1600 yards of patent steel wire-rope, universal joint, for connecting the windlass with engine, patent double-action steam-cultivator, with five tines, patent double snatch-block, with arrangement for slack-rope, anchors, single snatch-blocks, rope-porters, &c.—is £250; and a 10-horse portable engine is £295; making the whole £545. The cost of working this apparatus, including water-cart, and boy, and oil, is 20s. 6d. per day.

In Coleman's system, the drums upon which the rope is wound are attached to the sides of the engine, and give out and take on rope alternately. The engine moves along the headland; and the anchor, upon which there is very little strain, and which is, therefore, a very light, portable article, is shifted opposite to it by a man as the work is performed; direct action being obtained here, as in the case of Fowler's. The peculiarity of the plan consists in having two implements instead of one at work, the implements being grubbers, which smash up the ground—a practice now adopted by some farmers in England, in preference to turning the sod over with the plough. On commencing operations on this plan, the field is divided into two equal parts. The cultivators or grubbers work only one way—towards the engine. They are attached by the front to each end of a strong wire-rope, while a smaller wire-rope is fastened to their rear. The one cultivator is placed at the far side of the field, where its teeth or 'tines' are inserted in the ground; and it is pulled towards the centre of the field, tearing up the soil as it comes, the other meanwhile going out empty to meet it. When the latter reaches the middle of the field, the action of the engine is reversed, and it is dragged back to the engine, cultivating the land as it travels, while the other goes back to the headland empty. The pull out empty and working in is, of course, continued until the whole land has been tilled.

The other systems before the public are in principle the same as those described, though they are variously modified in detail.

With regard to the merits of each, it may be stated as the general opinion that Fowler's is the best for large fields. Moving along the headland, and propelling its anchor along with it, this apparatus could cultivate a field of from 350 to 400 yards in breadth, and of any length, without requiring to be shifted. Its direct action also secures that there is as little waste of power as possible. The advantages of saving time and conserving force, which these two features secure, can hardly be over-rated.

Howard's system seems to be regarded as most desirable where fields are small and irregularly shaped, as the rope can be so disposed as to enable the cultivating implement to reach almost any angle. The engine may be so placed that 40 or 50 acres may be cultivated without moving it; but the anchors, pulleys, rope-porters, &c., must be

shifted after the completion of every ten or twelve acres, and thus a considerable time is lost. There must also be some little waste of force in dragging so much rope and the implement at right angles to the engine. By this method, however, a trifling saving of water-carriage could be effected as compared with Fowler's, by having tanks at the engine-stations.

With Coleman's method, there is a little time saved at the ends in comparison with the other two, and there is also some economy in the purchase of the rope; but then there is loss of power in pulling an empty implement half through the field, and a necessary wear and tear of rope in dispensing with rope-porters, and allowing the wire to trail upon the ground.

By all the apparatus, however, tillage is much more perfectly and even cheaply performed than by horse-labour. As a rule, about three-fourths of an acre to an hour can be cultivated with either Fowler or Howard's apparatus. Where soil and climate are so variable as they are in Great Britain, it would serve no good purpose, but would be rather misleading, to name a price per acre at which steam-ploughing can be effected; but the following general statements in its favour may safely be made. That the use of the steam-plough or cultivator enables the farmer to perform his tillage operations at the best season of the year, and to free his land more quickly and effectually from weeds. Tenacious soils are rendered more friable and porous, and good drainage promoted by the efficient manner in which the subsoil can be stirred by the aid of steam. The steam-cultivator, plough, or harrows, may be frequently worked to advantage in an unfavourable season, when it would be impossible to work with horses. And not only a considerable diminution in the number of horses employed can be effected, but the horses, which are still necessary, can be kept at less expense. Consequently cultivation by steam-power, besides being more excellent, is actually cheaper, monetarily considered, than that done by horses.

There are at present about 800 or 900 steam-ploughs at work in Great Britain, and the demand for them is yearly increasing. Mr Fowler is now turning out of his Leeds' establishment about six engines with their appurtenances per week; and the Messrs Howard have also large demands. Many are exported to the continent, to the West Indies, to Egypt, and the East Indies.

**PLOUGHGATE OF LAND**, in the Law of Scotland, is an expression denoting a quantity of land of the extent of 100 acres Scots. No person is qualified to kill game in Scotland who has not a ploughgate of land, and this is still the law. *Paterson's Game-laws of United Kingdom*, p. 158.

**PLOVER** (*Charadrius*), a genus of birds of the family *Charadriadæ* (q. v.), having a straight compressed bill; the upper mandible alone slightly inflated and slightly bent at the point; the nasal groove extending about two-thirds of the length of the bill, the nostrils longitudinally cleft near the base; the legs not very long, naked a little above the tarsal joint; no hinder toe; the wings rather long and pointed, the first quill-feather the longest. The species are numerous, and are found in every quarter of the globe; many of them are birds of passage. They chiefly frequent low moist grounds, where they congregate in large flocks, and feed on worms, molluscs, insects, &c.; but some of them visit mountainous regions in the breeding-season. They fly with great strength and rapidity, and run with much swiftness. The flesh and eggs of many of them are esteemed delicacies. One of the British

## PLOVER—PLUM.

species is the Dotterel (q. v.). Another is the GOLDEN P., YELLOW P., or GREEN P. (*C. plumalis*), a rather larger bird, of a blackish colour, speckled with yellow at the tips and edges of the feathers; the throat, breast, and belly black in summer, whitish in winter. The Golden P. is a bird of passage, visiting in summer the northern parts of Europe, of the west of Asia, and of North America; and migrating to the south in winter. It is known in almost all parts of Europe, and is common in many parts of Britain, breeding in the northern parts. Great numbers frequent the sandy pastures and shores of the Hebrides and of the Orkney and Shetland Islands. It makes an artless nest, little more than a slight depression of the ground, and lays four eggs. The parent birds shew great anxiety for the protection of their young, and use various stratagems to divert the attention of an enemy. The Golden P. exhibits great restlessness on the approach of wet and stormy weather, whence its specific name *plumalis*.—The RINGED P. (*C. hiaticula*), a much smaller bird, not so large as a song

visitant. Its geographic distribution extends over most of the northern parts of the world.

PLUM (*Prunus*), a genus of trees and shrubs of the natural order *Rosaceæ*, suborder *Amygdalææ* (q. v.) or *Drupacææ*; the species of which have the stone of the fruit sharp-pointed at each end, with a longitudinal furrow passing all round, and a smooth surface; the fruit covered with a fine bloom, and the young leaves rolled up. The Common P., the Bullace, and the Sloe, are generally reckoned by botanists as distinct species, but with much doubt if they are really distinct, as the P. passes into the Bullace, and the Bullace into the Sloe by insensible gradations; although there is so wide a difference in general appearance, size of leaves, and size as well as quality of fruit, between the best cultivated plums and the sloe, that it is not without an effort we can imagine them to have sprung from a common stock. The COMMON P. (*P. domestica*) appears in a wild state in woods and hedges in many parts of England and on the continent of Europe; probably, however, often derived from the seeds of cultivated trees. It is commonly described as destitute of spines, and as further differing from the bullace in having the under-side of the leaves smooth except when they are very young; but if these characters are adopted, many of the cultivated plums must be referred to the bullace (*P. insititia*) as their original; nor does the ovate fruit afford a more certain character, some of the finest garden plums being globose or nearly so, like the bullace. The varieties called Damson (q. v.) are particularly like the bullace, except in the form of the fruit. Cultivated plums vary greatly in the size, form, colour, and flavour of the fruit. The fruit of some varieties, as the *White Magnumbonum*, is two inches long; while damsons of the same shape are not quite one inch, and a single fruit of the one is equal to at least eight or ten of the other. The best varieties of P. are among the most delicious dessert fruits; among these, the *Green Gage* (*Reine Claude* of the French) is one of the most esteemed both in Britain and on the continent of Europe; and is unsurpassed both in sweetness and flavour. The inferior varieties are used in pies, preserves, and sweetmeats. Some of them are very austere. In moderate quantity, plums are wholesome enough; but excess in the use of them is very apt to produce colic, diarrhoea, and cholera. The danger is greater, if they are eaten before being perfectly ripe. A very pleasant wine is made from plums; and in some parts of Europe a strong spirit is distilled from them after fermentation; but for this purpose they are mixed in the south of France, with honey and flour, and in Hungary with apples.—The dried fruit, variously known as *Dried Plums*, or *French Plums*, and *Prunes* (q. v.), is much used for the dessert; and the somewhat austere fruit of the *St Julien Plum*, cultivated in the south of France, becomes, when dried, the medicinal prune, used as a mild laxative. The drying of plums is effected very slowly in ovens, by a heat which is gradually increased. The process requires great care. The prunes called *Brignoles* are the produce of a variety grown principally near the little town of Brignole in Provence. The P. has been in cultivation from ancient times, and the first fine varieties were probably introduced into Europe from the East. The finer varieties are propagated chiefly by budding on stocks of the coarser kinds, which are procured either from seed or as suckers from the roots of P.-trees. The coarser varieties are propagated by suckers, without budding. A free loamy soil is best for plums. They are grown as standard, espalier, or wall trees. As standards, some



1, Ringed Plover; 2, Gray Plover; 3, Golden Plover.

thrush, is found at almost all seasons on the shores of the British Islands, frequenting sandy and shingly flats, from which the sea retires at ebb-tide. It is often to be seen also on the banks of large rivers, and not unfrequently of lakes and ponds. It is found in most of the northern parts of Europe and Asia, and in Iceland and Greenland. It is grayish-brown above, whitish beneath, with a collar of white round the neck, and below it a black—in winter, a brown—collar; the head marked with black and white; a white bar on the wing. Very similar, but smaller, is the KENTISH P. (*C. Cantianus*); and also similar and of similar habits is the smallest of the British species, the LITTLE RINGED P. (*C. minor*). Both of these are rare in Britain.—North America has a number of species of P., one of which, the AMERICAN GOLDEN P. (*C. Virginicus*), very closely resembles the Golden P. of Europe; and another, the KILDEER P. (*C. vociferus*), abundant on the great western prairies, and not unfrequent in the Atlantic states, utters, when approached by man, a querulous or plaintive cry, like the lap-wing.—The name P. is often extended to species of *Charadriadaæ* belonging to other genera, as *Squatarola*, in which the nasal grooves are short, the tip of the bill is tumid, and there is a rudimentary hind-toe. To this genus belongs the GRAY P. (*S. cinerea*) of Britain, a species rather larger than the Golden P., and chiefly known as a winter

PLUM—PLUMULARIA.

of the varieties attain a height of more than 20 feet, with a moderately spreading head. The fruit is mostly produced on spurs; but some of the finest fruit on the shoots of the former year. Among the varieties of *P.* are some which ripen their fruit early, and others which ripen late in the season. The blossom of some of the finer kinds is often protected by gardeners, like that of peaches and apricots.—The wood of the *P.*-tree is hard and fine-grained, and is used in cabinet-work, in turnery, and for making musical instruments.—The CASHMERE *P.* (*P. Bokharensis*), cultivated in Cashmere and Bokhara, is regarded as a distinct species.—The CHERRY *P.*, or MYROBALAN *P.* (*P. cerasifera* or *Myrobalanus*), is a bush very similar to the sloe, with pendulous globular red fruit. It is a native of North America, but is often cultivated for its fruit on the continent of Europe. In Britain, it seldom produces fruit.—*P. maritima* is a shrub, indigenous to sandy soils on the sea-coast of North America from New Jersey to Carolina. It has a dark purple agreeable fruit, about the size of a pigeon's egg.

The COCOA *P.* or ICACO of the West Indies is the fruit of *Chrysobalanus icaco*, a tree of the natural order *Rosaceæ*, suborder *Chrysobalanææ*. The fruit resembles a *P.*, has a sweet although slightly austere taste, and is eaten both raw and preserved.—The fruit of *Parinarium excelsum*, another of the *Chrysobalanææ*, is called Gray Plum at Sierra Leone.

PLUM, DATE. See DATE PLUM.

PLUMAGE OF BIRDS. See BIRDS and FEATHERS.

PLUMATE'LLA, a genus of zoophytes (*Polyzoa*), having the polypidom fixed, membranaceous, conifera-like, and branched; the polypes issuing from

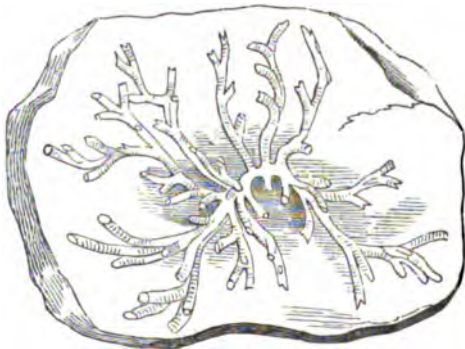

Plumatella Repens.

(From Johnston's *British Zoophytes*.)

the extremities of the branches, with a crescent-shaped disc surrounded by a single series of many tentacles. The species are found in fresh water, attached to stones, &c. *P. repens* is a common British species, sometimes spreading over a square foot, and having branches three inches long, which adhere to some surface throughout almost their whole length. The tentacles are beautifully feathered with cilia on two opposite sides.

PLUMBAGINEÆ, or PLUMBAGINA'CEÆ, a natural order of exogenous plants, herbaceous or half-shrubby; with leaves somewhat sheathing at the base, and often clustered; flowers in panicles or in heads; calyx tubular, persistent, plaited; corolla very thin, of one or five petals; stamens five; ovary superior, 1-celled, with a solitary ovule; styles generally five; fruit a Utricle (q. v.). There are about 160 known species, chiefly found on the sea-shores and in the salt marshes of temperate

regions. Some are found also in elevated regions, in all zones. Many have flowers of great beauty, and are therefore favourites in gardens. Some are occasionally used in medicine as tonics and astringents; others, being exceedingly acrid, as vesicants, particularly species of *Plumbago*. Thrift, or Sea-pink (q. v.), is the most familiar British example of the order.

PLUMBA'GO. See BLACK LEAD.

PLUMED MOTH, the popular name of a group of '*Nocturnal Lepidoptera*,' known to entomologists as *Fissipennæ* and *Pterophorites*; remarkable for having at least a pair of the wings, and often all the wings, longitudinally cleft into two or more—sometimes six—divisions, which are beautifully fringed at the edges. The wings are similar to those of other moths in their nervures, but the membrane



Plumed Moth.

which usually connects the nervures is interrupted. The Plumed Moths are extremely beautiful, but often pass unobserved in consequence of their small size. Some of them have the power of folding up the wing like a fan. Although they are ranked among the *Nocturnal Lepidoptera*, some of them fly about during the brightest part of the day.

PLUMMET, a weight of lead hung on a string, and attached to a frame, for the purpose of shewing the vertical line.

PLUMULARIA, a genus of zoophytes (*Anthozoa*); plant-like, rooted, simple, or branched; with feathery shoots and offsets; and having hydra-like polypes in small cells arranged on one side of

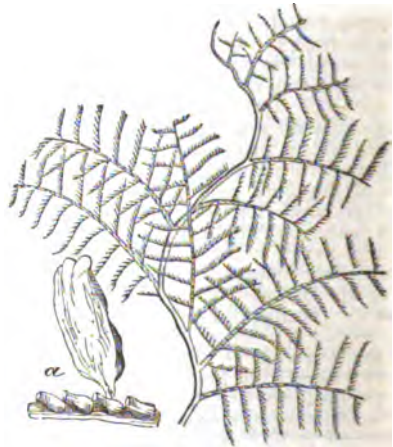

Plumularia Falcata (natural size):

a, the ovarian vesicle and four of the polype-cells of *P. falcata*, magnified. (From Johnston's *British Zoophytes*.)

the shoot or branch, usually in the axil of a horny spine. The species are numerous, inhabitants of the sea, some of them very common on the British coasts,

attached to stones, shells, sea-weeds, &c. They are very beautiful objects, even as seen by the naked eye, and still more when examined by the microscope; combining great delicacy with the utmost elegance. The polypes in a single P. are often exceedingly numerous; those of *P. falcata*, a very common British species, often to be found at low-water mark, have been calculated as 80,000 or 100,000 in number.

**PLUMULE.** See SEED.

**PLURALISM**, in Canon Law, means the possession by the same person of two or more ecclesiastical offices, whether of dignity or of emolument. Pluralism has been held unlawful from the earliest times, and is forbidden by many ancient councils, as Chalcedon, c. x. (451 A.D.), 2d Nicaea, c. xv. (787 A.D.). This prohibition, however, was not regarded as absolute and admitting no possible exception; the natural ground of the prohibition being the impossibility, in ordinary cases, of the same individual adequately discharging the duties of more than one office. It has been held, therefore, that in cases in which this impossibility does not really exist, the union of two or more offices in the hands of one person might, speaking absolutely, be permitted without infringing the divine law. Canonists therefore distinguish 'compatible' and 'incompatible' benefices or dignities. Two benefices may be incompatible in three ways—(1) if each requires residence (*ratione residentie*); (2) if the duties of both fall to be discharged at one and the same time (*ratione servitii*); or (3), if the revenue of either fully suffices for the becoming maintenance of the incumbent (*ratione sustentationis*). In other cases, benefices or dignities are considered compatible, and with the due dispensation, may be held by the same person. The rules by which dispensations from the law of residence are to be regulated, as well as the penalties for its violation, whether on the part of the patron or on that of the recipient, have formed the subject of frequent legislation, as in the 3d and the 4th councils of the Lateran, in the decretals of Innocent III. and many other popes, and especially in those of the Council of Trent. In general, it may be said that the canon law regards as incompatible (1) two benefices each having the cure of souls; (2) two 'dignities'; (3) a 'dignity' and a cure of souls; (4) a cure of souls and a simple benefice requiring residence. In other cases than these, the pope is held to have the power of dispensing. There is no department of discipline, however, in which the tendency to relaxation has been greater or more persistent; and one of the gravest of the abuses of the church was the prevalence of pluralism of 'incompatible' benefices, even of bishoprics; and although a constant effort was made to prevent this abuse, the evasions of the law were not only frequent, but even screened from punishment. In later times, the evil has in great measure disappeared in the Roman Catholic Church.

The English law, before the Reformation, in the main coincided with the canon law; and the legislation of Henry VIII. preserved the same general spirit, only substituting the dispensing power of the crown for that of the pope.

By 13 and 14 Vict. c. 98, it is provided that no incumbent of a benefice shall take and hold together with it another benefice, unless the churches are within three miles of one another by the nearest road, and the annual value of one of them does not exceed £100. Nor can two benefices be held together if the population of one exceeds 3000, and that of the other exceeds 500. The word benefice in this sense includes any perpetual curacy, endowed public chapel, parochial chapelry, or district chapelry.

But a dispensation or licence can be obtained from the archbishop, so as to allow two benefices to be held together; and if the archbishop refuse his licence, the party may appeal to the Privy Council. A special provision is also contained whereby the head ruler of any college or hall in the universities of Oxford or Cambridge, or warden of Durham University, is prohibited from taking any cathedral preferment or any other benefice. If any spiritual person holding a benefice shall accept another benefice contrary to the statute, the first benefice shall *ipso facto* become void. At the same time, provision is made by statutes for uniting benefices where the aggregate population does not exceed 1500, and the aggregate yearly value does not exceed £500.—In Ireland, no faculty or dispensation can be granted to any spiritual person to hold two or more benefices.—In Scotland, it is contrary to an old Scotch statute for a minister of the Established Church to hold two or more charges; but the question has arisen almost exclusively with reference to clergymen appointed professors before or after an appointment to a country charge, in which case a resignation is necessary of one of the offices within a certain time after the appointment; but this disqualification does not apply to city charges.

**PLUSH** (Fr. *peluche*), a variety of woven cloth, having a long shaggy pile on the upper surface. Although woven like velvet, it differs from it in the greater length of the pile, and in its not being clipped or shorn to a uniform length. Formerly, it was made of a double warp, one thread being usually double worsted yarn, the other, intended to form the pile, of goat's hair, and the weft of worsted; occasionally, only worsted was used. Now, it is made very extensively of silk and cotton, the silk taking the place of the goat's hair to form the pile. This silk plush is the material now almost universally used for making gentlemen's hats, instead of beaver-hair, as formerly. It is also worked in coloured silks, for many articles of ladies' attire. See WEAVING.

**PLUTARCH** (*Ploutarchos*), the biographer and moralist, was born at Chæroneia in Bœotia. We can only approximate to the year of his birth. He tells us himself that he was a student of philosophy at Delphi, under Ammonius, when Nero was making his progress through Greece in 66 A.D.; and we may safely infer, therefore, that in that year he was beyond the age of puberty. He lived for some years in Rome, and in other towns of Italy, where he seems to have been much occupied with public business, and with giving lessons in philosophy—a circumstance to which he attributes his having failed to learn the Latin language in Italy, and his having to postpone his studies in Roman literature till late in life. During the reign of Domitian, he was delivering lectures on philosophy at Rome; but we have not sufficient evidence for the statement, that he was preceptor to Trajan, or that that emperor raised him to consular rank. The later years of his life he spent at Chæroneia, where he discharged the duties of archon and priest of Apollo. He lived down to 106, the eighth year of the reign of Trajan; but how much longer is not known. He was married to an amiable wife of the name of Timoxena, by whom he had several sons, who reached manhood, and left descendants.

The work by which P. is best known is his *Parallel Lives* of forty-six Greeks and Romans. These are arranged in pairs, each pair forming one book (*biblion*), consisting of the life of a Greek and a Roman, and followed by a comparison between the two men. In a few cases, the comparison is omitted or lost. The heroes of these biographies are the

following: 1. Theseus and Romulus; 2. Lycurgus and Numa; 3. Solon and Valerius Publicola; 4. Themistocles and Camillus; 5. Pericles and Q. Fabius Maximus; 6. Alcibiades and Coriolanus; 7. Timoleon and Æmilius Paulus; 8. Pelopidas and Marcellus; 9. Aristides and Cato the Elder; 10. Philopemen and Flaminius; 11. Pyrrhus and Marius; 12. Lysander and Sulla; 13. Cimon and Lucullus; 14. Nicias and Crassus; 15. Eumenes and Sertorius; 16. Agesilaus and Pompeius; 17. Alexander and Cæsar; 18. Phocion and Cato the Younger; 19. Agis and Cleomenes, and Tiberius and Caius Gracchus; 20. Demosthenes and Cicero; 21. Demetrius Poliorcetes and M. Antonius; 22. Dion and M. Junius Brutus. In addition to these are placed in the editions after the 46th *Parallel Lives*, the biographies of Artaxerxes Mnemon, Aratus, Galba, and Otho. P. has no equal in ancient, and few in modern times, as a writer of 'Lives.' His power lies in his felicitous grasp of the character as a whole, and his skill in keeping minor details in subordination. It is not till the reader has seen the portrait in its completeness that his attention is attracted to accessory points. 'There are biographers (says an admirable writer in the *Quarterly Review*) who deal with the hero, and biographers who deal with the man. But Plutarch is the representative of ideal biography, for he delineates both in one.' Yet with all their artistic harmony, his lives abound with anecdotes and *bon-mots* in such profusion, that they form one of our chief authorities for the table-talk of the Greeks and Romans. Their popularity in ancient, mediæval, and modern times, with readers of every rank and age, is something extraordinary, and they have in consequence exerted a very powerful and a very salutary influence on the art of biography, as subsequently practised. The other writings of P., more than 60 in number, are included under the general title of *Moralia*, or Ethical Works. Several of these are not purely ethical in their tenor; while many of them are probably not by him, or if they are, do him small credit. Even in the best of the *Moralia*, there is no philosophical system to be found; their merits are not speculative, but practical; and their value consists mainly in their good sense, in the justness of their views on the ordinary affairs of human life; and in the benevolence of tone diffused throughout them. The best text of the *Lives* is that of Immanuel Bekker; the best translation in English is that of Dryden and others, as re-edited by Clough. The best edition of the *Moralia* is by Wytttenbach (Oxford, 1795—1800); and of the entire works, the editions of Reiske (Leip. 1774—1782) and Hutten (Tübingen, 1791—1805).

**PLUTEUS**, in Classical Architecture, a wall filling up the space between two columns. Also the space between two orders, placed over one another, as in the amphitheatres, &c.

**PLUTO** (Gr. *Ploutōn*, from *Plouto*, to be rich), originally only a surname of HADES, as the giver or possessor of riches, is, in the Mythology of Greece, the third son of Kronos and Rhea, and the brother of Zeus and Poseidon. On the tripartite division of the universe, he obtained the sovereignty of the under-world—the realm of darkness and ghostly shades, where he sits enthroned as a 'subterranean Zeus'—to use the expression of Homer, and rules the spirits of the dead. His dwelling-place, however, is not far from the surface of the earth. P. is inexorable in disposition, not to be moved either by prayers or flatteries. He is borne on a car, drawn by four black steeds, whom he guides with golden reins. His helmet makes him invisible, whence, according to some scholars,

his name of *Hades* (from *a*, priv., and *idea*, to see); although others, with at least equal probability, derive Hades from *hado* or *chado*, to receive or embrace, and translate the word the 'all-receiver.' In Homer, Hades never means a place, but always a person. Moreover, it is to be noticed that the poet does not divide the realm of the shades into two separate regions. All the souls of the dead—good and bad alike—mingle together. Subsequently, however, when the ethical conception of future retribution became more widely developed, the kingdom of the dead was divided into Elysium (q. v.), the abode of the good, and Tartarus (q. v.), the place of the wicked. This change also exercised an important influence on the conception of Pluto. The ruler of the under-world not only acquired additional power and majesty, but the very idea of his character was essentially modified. He was now regarded as a beneficent deity, who held the keys of the earth in his hand, and possessed its metallic treasures (whence his new name *Pluto* or *Plutus*), and who blessed the year with fruits, for out of the darkness underground come all the riches and swelling fulness of the soil. Hence, in later times, mortals prayed to him before proceeding to dig for the wealth hidden in the bowels of the earth.

P. married Persephone (Proserpina), the daughter of Demeter (Ceres), after carrying her off from the plains of Enna. He assisted his brothers—according to the mythological story—in their war against the Titans, and received from the Cyclops, as a reward for delivering them from Tartarus, the helmet that makes him invisible, which he lent to Hermes (Mercury) in the aforesaid war, to Perseus in his combat with the Gorgons, and which ultimately came to Meriones. The Erinyes and Charon obey his behests. He sits in judgment on every open and secret act, and is assisted by three subordinate judges, Æacus, Minos, and Rhadamanthus. The worship of P. was widely spread both among the Greeks and Romans. Temples were erected to his honour at Athens, Elis, and Olympia. Among trees and flowers, the cypress, boxwood, narcissus, and maidenhair were sacred to him; bulls and goats were also sacrificed to him amid the shadows of night, and his priests had their brows garlanded with cypress wreaths. In works of art, he resembles his brothers Zeus and Poseidon; only his hair hangs down somewhat wildly and fiercely over his brow, and his appearance, though majestic, as becomes so mighty a god, has something gloomy and terrible about it. There can be little doubt that he, as well as Pan (q. v.), helped to trick out the conception of the devil prevalent during the middle ages, and not yet extinct. If it was from Pan that the devil derived those physical characteristics alluded to in the famous *Address to the Devil* by the poet Burns:

O thou, whatever title suit thee,  
Auld Hornie, Satan, Nick, or Clootie,

it is no less certain that it is to P. he owes his position as 'king of Hell,' 'his Blackness,' and many of the insignia of his infernal royalty.

**PLUTONIC ROCKS**, the name given by Lyell to the Granitic Rocks, from the supposition that they were formed at considerable depth in the earth, and were cooled and crystallised slowly under great pressure. They were so designated in contradistinction to the Volcanic Rocks, which, though they have risen up from below, have cooled from a melted state more rapidly upon or near the surface. See GRANITE.

**PLYMOUTH**, an English seaport and market town, and a parliamentary and municipal borough

## PLYMOUTH—PLYMOUTH BRETHREN.

in the south-west of Devonshire, 246 miles west-south-west of London. It stands in the bight of Plymouth Sound (q. v.) between the estuaries of the Plym and Tamar. To the west of it is Stonehouse (q. v.), a township and coast-guard station, and still further west is Devonport (q. v.), the great naval and military station. The two former places, however, having become united by continuous lines of houses, have lost their individuality, and are (with Devonport, which is walled, fortified, and surrounded by a moat) now generally considered as one great town. Of this great centre of fashion, trade, and naval and military preparation, P. proper, which covers an area of one square mile, may be called the city, and Devonport the west-end; while Stonehouse is an intermediate district, containing chiefly factories, barracks, victualling yards, hospitals, and other institutions. P. proper extends from Mill Bay on the west to the mouth of the Plym on the east. Its site is somewhat rugged and uneven; an eminence forming the suburbs runs along its north side, and another eminence, partly occupied by the citadel, fronts the Sound. The chief buildings are the Royal Hotel, comprising an immense inn, assembly-rooms, a theatre, and the Athenæum, all partially destroyed by fire in 1862, and rebuilt in 1863; public library, containing in its Cottonian collection 300 sketches by the old Italian masters; St Andrew's Church, the tower of which dates from 1490; and Charles Church (1646—1658), dedicated, with fervent loyalty, at the Restoration, to 'St Charles the Martyr.' There are also several important educational establishments, some of which are endowed, as well as many charitable institutions. Mill Bay and Sutton Pool are two small inlets of the Sound, in which lie all the merchant-vessels bound for P. proper. Between these inlets, and running along the shore, is the eminence or high plateau of land, called the Hoe. From this ridge, whence the approach of the Spanish Armada is said to have been first descried, magnificent shore and sea views may be obtained. Its eastern end is occupied by the citadel, a fortress mounting 150 guns, which commands the entrance of the Cutwater (the lower estuary of the Plym), and of Sutton Pool. Mill Bay, on the west, is so deep that vessels of 3000 tons can lie at the pier at low-water. Here are the important Great Western Docks, covering an area of fourteen acres, and having a depth of 22 feet, constructed about the years 1855—1858. Close to these docks, and connected with them by a tram-line, are the termini of the South Devon, Tavistock, and Cornwall railways. In 1863, 5645 vessels, of 804,540 tons, entered and cleared the port. Commerce is carried on to a considerable extent with the Cape of Good Hope, the West Indies, and the Mediterranean; the coasting trade is also important, and the fisheries are productive. Pop. (1861), 62,599.

P., described by Leland as being, in the reign of Henry II., 'a mene thing, an inhabitation of fishars,' was called by the Saxons Tameorworth (town on the Tamar); after the Conquest it was called Sutton (South Town); and it was not till the reign of Henry VI. that it received the name of Plymouth (mouth of the Plym). During the 14th and 15th centuries it was frequently attacked and set on fire by the French, and in 1512 an act was passed for the strengthening of its defences, which since then have greatly increased, until now the whole shores of the Sound are well defended by cannon, and a cordon of inland forts is (November 1864) being constructed at immense cost, surrounding the Three Towns at a distance of from two to three miles.

PLYMOUTH, a town in Massachusetts, U.S., on Plymouth Bay, 37 miles south-east of Boston famous in the history of New England as the landing-place of the 'Pilgrim Fathers' from the *Mayflower*, December 11, 1620, O.S. Plymouth Rock is a granite boulder at the water's edge on which they landed. In Pilgrim Hall in a museum is preserved many relics of the first settlement of the country, among which are Governor Carver's chain and the sword of Miles Standish. The village has a good harbour and flourishing trade. Pop. (1860) 6272.

PLYMOUTH BRETHREN, a religious sect which sprang into existence about 1830—1835 in Plymouth, Dublin, and other places in the British islands, and which has extended itself considerably throughout the British dominions and in some parts of the continent of Europe, particularly among the Protestants of France, Switzerland, and Italy, and also in the United States of America. It seems to have originated in a reaction against exclusive High Church principles, as maintained in the Church of England, with everything of a kindred nature in other churches, and against a dead formalism associated with 'unevangelical' doctrine. Many of the first members of the new religious communities formed in Plymouth and elsewhere were retired Anglo-Indian officers, men of unquestionable zeal and piety; and these communities began to appear almost simultaneously in a number of places. Their origin is, however, very much to be ascribed to the labours and influence of Mr Darby, from whom the P. B. on the continent of Europe are very generally known as *Darbyites*. Mr Darby was a barrister, moving in the highest circles of society; and under deeply religious impressions, became a clergyman of the Church of England, and lived for some time in a mud-hovel in the county Wicklow, devoting himself to his work; but afterwards left the Church of England from conscientious scruples, and became an evangelist unconnected with any church. In this character, he laboured both in England and on the continent of Europe, preaching in French, English, and German. He also gave utterance to his opinions in numerous pamphlets, and in a quarterly periodical called *The Christian Witness*, which for a number of years was the 'organ' of the Plymouth Brethren. He continues to visit from time to time the communities or meetings of Plymouth Brethren. His tenets, and those of the P. B. in general, are strictly Calvinistic: original sin and predestination, the efficacy of Christ's sacrifice, the merit of his obedience, the power of his intercession, the gracious operations of the Holy Spirit in regeneration and sanctification, are prominent points. Millenarian views are also generally entertained by the P. B.; and they usually practise the baptism of adults without regard to previous infant baptism. They acknowledge the sacrament of the Lord's Supper, and administer it to one another in their meetings, usually on every Sunday, or 'first day of the week,' in this, as in everything else, refusing to acknowledge any special ministers. They utterly reject confirmation. Their most distinctive peculiarity, when contrasted with other Calvinistic churches, is their complete rejection of ecclesiastical organisation. They suppose the whole Christian body in the world to have declined from truth and duty, like Israel of old, and therefore to have been 'corporately rejected of God,' and believe the true church to consist of themselves and of other chosen ones in the various Christian churches. They refuse to recognise any form of church government, or any office of the ministry; they insist much on the equal right of every *male* member of the church to

'prophesy' or preach; and in their meetings, after each hymn or prayer, there is usually a pause, that any one, moved by the Spirit, may undertake this office. They exclude persons known to have been guilty of gross sins from participation with them in the Lord's Supper, until proof is afforded of repentance. The P. B. reject every distinctive appellation but that of Christians; although a special denomination is found necessary to designate them; and, in fact, no one not holding their views could remain associated with them. A great schism took place among them in consequence of doctrines preached at Plymouth and Bristol concerning the human nature of Christ; Mr Darby vigorously opposing what he deemed a dangerous error, and he and his adherents utterly separating from the fellowship of those who maintained or even refused to condemn it. One of the most noted (if not notable) converts to the principles of the sect was the revivalist Guinness, who was baptised in 1860 by another Plymouth brother, Lord Congleton.

On the continent of Europe, the P. B. have in many places given great trouble to the Protestant churches, by their opposition to all ecclesiastical order or organisation. See Mrs H. Grattan Guinness's *Answer to the Question: Who are the Plymouth Brethren?* (Philadelphia, 1861).

**PLYMOUTH SOUND**, a well-known roadstead on the south-west of Devonshire, important as a naval station, has considerable claims to the distinction of being called, as it frequently has been, the most beautiful estuary on the English coast. Its position at the entrance of the English Channel is much in its favour. It is two and a half miles wide, and extends inland for three miles. It penetrates into the country by means of the harbours of Hamoaze and Catwater, the estuaries of the Tamar and Plym respectively. On its west side is Cawsand Bay. The shores, which present many beautiful views, rise in hills of from 100 to 400 feet, and are dotted over with woods and with villages, and bound by coasts which are generally rocky and abrupt. Mount Edgecombe Park, the beautiful seat of the Earl of Mount Edgecombe, occupies the west shore of the sound. At the mouth of the Tamar is the small island of St Nicholas, or Drake's Island, a pyramidal rock strongly fortified. The Sound is open to the south-west, from which direction strong winds frequently blow, and violent surges are thrown in from the Atlantic. In order to protect the shipping in the harbour, a massive stone breakwater, 1700 yards in length, was constructed at a cost of about £1,500,000, and completed in 1841. See **BREAKWATER**. On a sunken rock just inside the breakwater and at its centre, a strong stone fort is (November 1864) in course of erection; and an extensive series of stone batteries are being erected at Bovisand and Picklecombe on the mainland, on either side of the entrance to the harbour. Fourteen miles south-south-west of Plymouth is Eddystone Light-house. See **EDDYSTONE**.

**PNEUMATIC DISPATCH**. This name is given to a mode of sending parcels and mail-bags through a tube by atmospheric pressure, or by a partial vacuum. Early in the present century, Mr Medhurst conceived the idea of some such contrivance. He published two pamphlets, one under the name of *A New Method of Conveying Letters and Goods by Air*; and the other, *A New System of In and Conveyance for Goods and Passengers*. He proposed to construct air-tight tunnels, with carriages moving through them on rails; and these carriages were to be propelled by compressed air from behind, or else by suction, in virtue of a vacuum formed in front of

them. He also planned, as an alternative, how there might be a parcels' carriage within the tunnel or tube, and a passenger carriage running along the top of the tube; the two being connected by an upright bar passing through a valved slit in the tube. Medhurst was laughed at by his contemporaries as a visionary; but his speculations were called to mind in later years, and led to the attempts noticed under **ATMOSPHERIC RAILWAY**.

In 1861, was announced a *Pneumatic Dispatch* project, based on a reconsideration of the causes of failure in the earlier schemes. The conveyance of passengers and of bulky goods is not here contemplated; parcels and mail-bags are the articles held chiefly in view. To test the theory, a quarter of a mile of iron tube was experimentally laid down near Battersea, with a fair average of gradients and curves purposely given to it. The tube was about 30 inches in diameter, not cylindrical, but somewhat bee-hive shape in section, and flat at the bottom, to admit two lines of rail inside. Iron carriages were made to fit the tube almost as accurately as a piston. A steam-engine was set up near one end of the tube, to draw out the air by means of a sort of centrifugal fan. When the engine had been at work some little time, it rarefied the air in the tube to such a degree that the ordinary pressure of the atmosphere pushed on the carriages (which rolled by miniature wheels on the miniature railway). It was found easy to propel in this way a train, consisting of two iron carriages of 7 cwt. each, at the rate of 30 miles an hour.

After many financial discouragements, a *Pneumatic Dispatch Company* obtained capital in 1862, and began operations in 1863. The experimental tube was removed to London, and laid down beneath the roadway of Seymour Street, Euston Square, from the Euston station of the London and North-western Railway to the N. W. district post-office in Eversholt Street—a distance of one-third of a mile. The distance is too small to be commercially important, but is sufficient to shew the soundness of the plan. Several times every day (except Sundays), mail-trains arrive at Euston Station from various parts of the country. Such letters as are destined for delivery in the N. W. postal district of the metropolis, are sorted during the journey; the bags containing them are quickly transferred from the railway post-office vans to the Pneumatic Dispatch tube, and are wafted in a minute or two to Eversholt Street. They are blown through the tube from the station northward by compressed air; but the return mail-bags are sucked through the tube southward by rarefied air: the compression in the one case and the rarefaction in the other being very slight, only a few ounces on the square inch.

The plan now (October 1864) in progress may be briefly described as follows: There will be a tube laid down from Euston Square to the General Post-office in St Martin's-le-Grand, by way of Drummond Street, Hampstead Road, Tottenham Court Road, High Street, Broad Street, Holborn, Skinner's Street, and Newgate Street—a distance of 2½ miles. The tube is of large size, nearly 4½ feet in diameter, laid down at as small a depth beneath the carriage-way of the several streets as the water and gas pipes will permit. It is chiefly of cast-iron; but some portions on a sharp curve are of brick. When the arrangements are completed, there will be a large engine-house on the south side of Holborn, near Lincoln's Inn Fields, which will supply all the power for working the whole tube in both directions. Rarefied air in one half of the tube will draw a train of iron carriages, laden with parcels and mail-bags, from Euston Station to Holborn; and compressed air will drive them through the other

## PNEUMATIC TROUGH—PNEUMATICS.

length of tube from Holborn to the General Post-office—there being suction in the one case, and pressure in the other. A reverse action will bring trains in the other direction. The necessary amount of rarefaction in the one case, and of compression in the other, will be determined by experiment; but both will be produced by means of a revolving fan of peculiar construction and large dimensions, worked by a powerful steam-engine at the Holborn Station. The sectional area of the tube being very much greater than that of the experimental tube at work in Seymour Street, carriages of much greater length, width, height, and strength can be accommodated, and more of them in one train—provided the steam-power be sufficient. If the plan succeeds, other tubes will be laid down from Holborn to Charing Cross, and in other directions, to connect the General Post-office with the district offices, and with the chief railway termini. With regard to parcels, provisional agreements have been made with Messrs Pickford and other carriers for extending the tube to certain great depôts in the city, and for carrying railway parcels to and fro between those depôts and the railway termini. If the anticipations are borne out, there will be great saving of time in the delivery of letters and parcels, and a material lessening of the number of parcels and mail-vans and carts in the over-crowded streets of the metropolis. The work will be silently going on underground, instead of visibly and noisily occupying the roadways.

The problem of *passenger* conveyance within a pneumatic tube has recently been partially solved; but the value of the system can only be determined by long and varied experience. During the parliamentary session of 1864, a scheme was brought forward for constructing a railway on this system under the whole length of Oxford Street and Holborn. It was ridiculed as an absurdity, and the bill was thrown out; but the engineer, Mr Rammell, to shew the practicability of the plan, has since laid down a bit of railway on this principle in the grounds of the Crystal Palace. It is about 600 yards long. A brickwork tunnel, about 10 feet high by 9 in width, and capable of admitting the largest broad-gauge carriage, has been constructed, with a single line of rails laid along the bottom. The tunnel has a hinged valve at each end. The route is purposely laid with severe curves and gradients, to test the principle more completely. A small stationary steam-engine works a fan or hollow disc 22 feet in diameter, which is so arranged as either to condense or to rarefy the air in the tunnel according to the adjustment of certain valves. In the one case, air rushes in from the circumference to the centre of the disc; in the other, it rushes out from the centre to the circumference: there being an open channel from the centre of the disc to the tunnel. A long roomy carriage, like an omnibus, adapted for 30 passengers, travels to and fro in the tunnel, being blown in one direction and sucked in the other. Fixed behind the carriage is a frame-work nearly as wide and high as the tunnel; and a fringe of bristles round the edge of this framework presses like a brush against the interior of the tunnel, forming a sort of air-tight piston. The motion is steady and equable; and a good speed is attained with a pressure of only  $2\frac{1}{4}$  oz. on the square inch.

**PNEUMATIC TROUGH**, is a piece of chemical apparatus originally devised by Priestley, and now in daily requisition in every laboratory. By its means, gases can be collected in vessels for experiments or examination, and can be decanted from one jar to another with as much ease as if we were dealing with liquids. The pneumatic trough consists of a vessel of water, provided with a ledge

or shelf at the depth of two or three inches from the top. The jars in which the gas is to be collected are filled with water, and placed with their mouths downward upon the shelf, which is kept a little under water, so as to prevent the entrance of air into the jars. When the edge of the jar is brought over the extremity of the tube carrying the gas, the bubbles of gas rise through the water, collect in the upper part of the jar, and displace the liquid. As soon as a jar is filled, it may be removed by sliding under its open mouth, while still under water, a plate or tray containing enough of water to cover the edge of the jar; and oxygen and many other gases may be thus preserved for hours. Another jar full of water is substituted for the removed jar. The trough is best constructed of japanned copper, and may be made of any size corresponding to that of the jars; and in the shelf a groove should be made about half an inch in width, and the same in depth, to admit the extremity of the gas-delivering tube beneath the jar.

**PNEUMATICS** (Gr. *pneuma*, spirit or breath, air) is the science which treats of the mechanical properties of æiform fluids, such as their weight, pressure, elasticity, motion, &c. The great representative of the æiform fluids is the atmosphere. The atmosphere is very frequently called 'air,' to distinguish it from the others, which are known as 'gases.' The fact of air having weight, and generally exercising pressure and resistance, was unsuspected by most of the ancients, though they were aware of the latter property in particular cases, from seeing and feeling the effects of the wind; but the idea that air in a state of rest exerts pressure on a body immersed in it, never seems to have occurred to them. Aristotle, however, asserted that air had weight, and so did several subsequent philosophers; but the truth of this opinion was not established till the time of Torricelli (q. v.), who not only shewed that it had weight and exerted pressure, but also found the amount of this weight or pressure. See **ATMOSPHERE**. Pascal (q. v.) completed the investigation, and invented the Barometer (q. v.). The experiments of these philosophers proved that what is called 'suction' is nothing more than an effect of the pressure of the air on one side of a body, unbalanced by an equal pressure of air on the opposite side of it. To this property of air we owe the working of the various kinds of Pumps (q. v.), the Barometer (q. v.), the siphon, cupping-glass, &c. But the great distinguishing feature of æiform bodies is the repulsive force which their molecules exercise over each other, and the consequent expansion of these bodies when pressure is removed, or compression when pressure is increased. The investigation of the expansibility and compressibility of air was carried on by means of the Air-pump (q. v.), an invention of Guericke (q. v.), and soon resulted in the discovery of a law by Boyle (about 1650), and Mariotte (1676), called *Mariotte's Law* (q. v.), which affirms, that 'at a given temperature the volume of a gas is inversely as the pressure.' See **GASES**. The second great law of tension and pressure is that of Dalton and Gay-Lussac (1801), which states, that 'when the tension remains the same, the density of a gas varies inversely as the temperature'—that is to say, when the temperature is increased by equal increments, the bulk is increased by equal increments. The motion of gases is subject to the same laws with that of liquids, the laws which regulate the motion of liquids depending for their efficacy not on the liquidity, but on the fluidity (see **FLUID**) of these bodies. The flow of gases in tubes seems to be retarded by friction against the sides, in the same way as that of water



is, and the diminished efflux at an orifice shews that the *vena contracta* exists for gases as well as for liquids. Abundance of examples and further explanations of the properties of air will be found under such heads as ATMOSPHERE, BALLOON, BAROMETER, DIVING-BELL, MAGDEBURG HEMISPHERES, &c.

**PNEUMOGASTRIC NERVE**, or *Par Vagus*, derives the first of its names from its supplying the lungs and stomach with nervous filaments, and the second from the wandering course which it pursues. It emerges from the medulla oblongata by eight or ten filaments, which unite and form a flat cord, that escapes from the cavity of the cranium (in association with the glossopharyngeal and spinal accessory nerve) by the jugular foramen. In this foramen, it forms a well-marked ganglionic swelling, while another is observed immediately after its exit from the skull. The nerve runs straight down the neck between and in the same sheath as the internal jugular vein and the carotid artery. Below the root of the neck, its course is different on the two sides; the right nerve running along the back of the œsophagus, is distributed to the posterior surface of the stomach, and finally merges into the solar plexus; while the left nerve runs along the front of the œsophagus to the stomach, sending branches chiefly over its anterior surface.

From anatomical considerations, based on the distribution of this nerve, and from the results of experiments on animals, it may be concluded that this is a mixed nerve, containing filaments both of sensation and motion. The pulmonary branches exercise a most important influence upon the respiratory acts, for when the pneumogastrics on both sides have been divided above the giving off of the pulmonary branches, the most severe dyspnoea comes on, the number of respirations is much diminished, and the animal breathes as if it were asthmatic; after a short time, the lungs become congested and dropsical, and the bronchial tubes filled with a frothy serous fluid; and if the cut ends of the nerves are kept apart, the animal never survives above three days. The gastric branches influence the movements of the stomach, while their destruction does not materially affect the secretion of the gastric juice or the process of chylification. Loss of voice and difficulty of breathing have been frequently traced to the pressure of an aneurism or other tumour on the recurrent or inferior laryngeal. Hooping-cough is ascribed by many high authorities to an affection of the pneumogastric nerve; and the violent spasmodic cough which accompanies enlarged bronchial glands, is probably due to the irritation of its pulmonary branches. The sympathy which exists between the digestive and the respiratory and circulating organs, is explained by the anatomical relations of this nerve. For example, both asthma and palpitation of the heart are often to be traced to some deranged state of digestion. Vomiting may be excited by irritation of the central or the distal extremities of the nerve. In disease of the brain, the vomiting, which is often an early symptom, is caused by irritation of the central extremity; and in sea-sickness, it is that extremity also which is irritated by the disturbed state of the circulation in the cranium; while by introducing emetic substances into the stomach, the vomiting is produced by the irritation of the peripheral (or distal) filaments.

**PNEUMONIA**, or Inflammation of the Substance of the Lungs, is a disease which is divided by pathologists into three distinct stages, corresponding to different degrees or periods of inflammatory action. The first stage is that of *engorgement*, in which the lung or a portion of it is gorged

with blood, is of a darker colour externally, and crepitates (or crackles) less under pressure than healthy lung does; the air that ought to exist in the pulmonary cells being in a great measure replaced by fluid. On cutting the engorged portion, the section is seen to be redder than natural, and to yield a great quantity of reddish and frothy serum. The most engorged portions will generally float in water, although they are heavier than healthy lung. If the inflammation continues, new characters appear. The affected portion of the lung ceases to crepitate under pressure, and sinks when placed in water, in consequence of its now containing no air. The spongy character of the lung is gone. It is now solid, and the cut surface so closely resembles that of liver, that the term *hepatisation*, first suggested by Laennec, is generally applied to this stage. On examining with the microscope a torn fragment of the hepatised lung, it will be seen to be composed of small red granulations pressing upon one another, which are doubtless the air-cells clogged up, thickened, and made red by the inflammation. In the third and most advanced stage, the pulmonary tissue remains, as in the last stage, dense, solid, and impervious to air; but its section, in place of being red, is now of a reddish-yellow, or straw, or drab, or stone colour, or is of a grayish tint; and the little granulations which were red in the second stage, are now whitish or gray, from the presence of pus or matter, which permeates through the pulmonary tissue, rendering it very soft and friable. To this stage, which is in reality one of *diffused suppuration*, Laennec applied the terms *gray hepatisation*, or *purulent infiltration*. Besides revealing to us the above information regarding the changes which the pulmonary textures undergo in the three stages of this disease, morbid anatomy teaches us that inflammation does not attack all parts of the lung on both sides indiscriminately. It is much more common on the right side of the body than the left. Of 210 cases collected by Andral, 121 were on the right lung alone, and 58 on the left side alone; while in 25 it was double (i. e., occurred in both lungs), and in six the seat was uncertain; so that pneumonia is more than twice as common on the right side as on the left, and only occurs on both sides together as often as once in eight times. According to Grisolle, however, whose *Traité Pratique de la Pneumonie* is the standard work on this disease, the relative frequency with which the right lung is affected is rather less than two to one (11 : 6). Moreover, pneumonia is considerably more common in the lower than in the upper lobes of the lung—a point of great importance in diagnosis. Of 88 cases observed by Andral, the inflammation was found to affect the lower lobe 47 times; the upper lobe, 30; and the whole lung at once, 11. Inflammation of the bronchial tubes so constantly accompanies inflammation of the tissues of the lung, that although bronchitis often exists without pneumonia, pneumonia never occurs without bronchitis. Moreover, a certain amount of pleurisy or inflammation of the investing membrane, accompanies pneumonia in a very large majority of cases. The alterations which take place in the tissue of the lung give rise to important modifications of the ordinary sounds yielded by auscultation and percussion; the discrimination of which, however, belong to the physician.

The following are the general symptoms, as distinguished from the physical signs, of pneumonia. The disease generally commences with inflammatory fever; and pain in the side, due to pleurisy in most cases, soon supervenes. The breathing is always more or less affected, especially when the

upper lobe is inflamed. According to Professor Gairdner, the dyspnoea of pure pneumonia is a mere acceleration of the respiration, without any of the heaving or straining respiration observed in bronchitis, or in cases where the two diseases are combined. Delirium is a very frequent, and always a dangerous symptom, indicating that the due arterialisation of the blood is much interfered with, and that the impure circulating fluid is affecting the brain. The cough is usually dry at first, but in a few hours it is accompanied by the expectoration of sputa of so characteristic a nature as to afford almost certain evidence of the presence of the disease. On the second or third day, the expectoration, which previously consisted merely of a little bronchial mucus, consists of transparent and tawny, or rust-coloured sputa, which unite in the vessel containing them into one gelatinous mass. The colour is owing to the complete blending of the blood and mucus, and in proportion to the quantity of the former, the sputa is more or less deeply tinged. So long as the expectorated matter flows readily along the side of the vessel when it is tilted, there is reason to believe, unless physical signs tell us otherwise, that the inflammation is still in the first stage; but when the sputa are so viscid that the vessel may be inverted and strongly shaken without their being detached, there is reason to fear that the pneumonia has reached the second stage. If improvement now commences, the sputa become less tenacious, less rust-coloured, and gradually like the expectoration of common catarrh. But if the disease advances, the rust-coloured sputa, although in less quantity, may go on to the end; or there may be no expectoration, either on account of its own tenacity, or of the patient's want of power to eject it, in which case the air-passages get gradually filled, and death from suffocation occurs; or there may be the expectoration of a fluid of the consistence of gum-water, and of a brownish-red colour (resembling prune-juice), which, according to Andral, affords strong evidence that the disease is in its third stage; or, lastly, pure pus may be excreted during the third stage.

In its first and second stages, this disease is tolerably amenable to treatment. Whether, when the lung has reached the third stage, it is still susceptible of repair, we cannot tell, because we have no certain sign of the commencement or establishment of this third stage during life, although we may guess that it is established, if the face has become very pale and corpse-like; if there is the prune-juice or purulent expectoration; and if the disease has lasted for a sufficient time to have advanced so far, although it would be very difficult to state, with any approach to accuracy, what the necessary time is. The average duration of pneumonia may be placed at ten days or a fortnight.

Of the causes of this disease, very little need be said. Sometimes no cause can be traced. Very often it is the consequence of exposure to cold, especially when the body was previously heated by exercise; but why such exposure should in one person cause pneumonia, in a second, pleurisy, in a third, pericarditis, and in a fourth, peritonitis, we cannot tell.

The following is a brief outline of the treatment to be adopted, provided the patient was previously strong and healthy. In the first stage, free venesection, tartarised antimony (one-third of a grain to half a wine-glassful of water every hour, and the dose to be increased to a grain or more hourly, if there is no purging or vomiting, which may often be prevented by the addition of a few drops of laudanum to each dose), and antiphlogistic regimen, generally are of service. Under this system there

are often signs of improvement in five or six hours, although sometimes there is no change for the better till twenty-four hours or more have elapsed. When the disease has reached the second stage, in preference to continuing the antimony, we should as speedily as possible get the system gently under the influence of mercury, in the mode recommended in the articles PERICARDITIS and PERITONITIS. If there is great depression of the vital powers, as indicated by a feeble and irregular pulse, and the other ordinary signs of sinking, it will be requisite to administer stimulants, such as wine and carbonate of ammonia, and to feed the patient on beef-tea.

There are few diseases in which it is of greater importance to watch the patient during convalescence than in pneumonia. The convalescence is often rather apparent than real, and as Dr Watson truly observes: 'A patient can never be pronounced perfectly secure so long as any trace of crepitation remains in the affected lung, and this may often continue long; nay, it not unfrequently ceases only on the supervention of another more surely fatal though less rapid disorder—viz., tubercular consumption.'

PO (anc. *Eridanus* and *Padus*), the largest river of Italy, rises in two springs on the north and south sides of Monte Viso, one of the Cottian Alps, close to the French frontier, and in lat. about 44° 40' N. It flows eastward for upwards of 20 miles, when, arriving before Saluzzo, it emerges from its rocky defiles, and enters upon the plain. From Saluzzo, it flows north-north-east past Turin; and arriving at the town of Chivasso, it changes its course toward the east, in which direction it flows to its embouchure in the Adriatic. Upwards of 50 miles above its mouth, it begins to form its delta, the principal branches being the *Po della Maestra*, on the north, and the *Po di Primaro*, on the south. The unhealthy marsh of the *Valli de Comacchio* extends immediately north of the Primaro branch. The Po receives from the left, the Dora Ripaira, Dora Baltea, Sesia, Ticino, Adda, Oglio, and Mincio; from the right, the Tanaro, Bormida, Trebbia, Taro, Parma, Enza, Secchia, and Panaro. At Turin, the Po is about 700 feet broad; at Pavia, 1000 feet; at Cremona, 1000 feet; and below Polesella, after throwing off the Po di Primaro branch to the south, its breadth is about 800 feet. It has an entire length of 450 miles, is navigable for small barges 60 miles from its source, and drains an area of nearly 40,000 square miles.

POA. See MEADOW GRASS.

POACHING, though not strictly a legal term, has so long been appropriated in popular parlance to describe a well-known legal offence, that it is now usually adopted in legal works. It means the unlawfully trespassing on another's lands for the purpose of catching or pursuing game; and it is likewise extended to the cognate offence of unlawfully catching or pursuing fish in another's waters.

1. *As to poaching game.*—The general law as to who is entitled to game, and in what circumstances, is stated under the head GAME. As a general rule, whoever is the proprietor of land, is the only person exclusively entitled to catch and kill the game; and where the land is let to a tenant, then, in England and Ireland, if nothing is said or agreed on the subject, it is the tenant, and not the landlord, who is entitled exclusively to the game. In Scotland, the rule is the reverse, for the landlord, and not the tenant, is there entitled to the game; but generally there is an express stipulation in leases, providing for this somewhat important right; and of course the parties may agree to anything they like on that head. Whoever, therefore, is entitled

## POACHING.

to the exclusive privilege of killing the game, can alone give permission to a stranger to go and kill game there; and if this permission is not obtained, such stranger, whether qualified or not—i. e., whether he pays the government tax or not—is a poacher, if he go and kill the game. In England, there is a Day-poaching Act and a Night-poaching Act, imposing penalties on poachers. By the Day-poaching Act (1 and 2 Will. IV. c. 32, s. 30), whoever unlawfully goes upon lands not his own to pursue or kill not only Game (q. v.), but also rabbits, woodcocks, snipes, quails, and landrails, is liable to a penalty of £2. It has been held that this offence is committed whenever a stranger has *de facto* gone upon the lands to shoot without having previously expressly obtained the permission of the party entitled to the game, even though he may have had good reason to believe that such permission, if asked, would have been granted as a matter of course, and though, after hearing of the trespass, the owner quite approved and ratified it. Moreover, any person whatever, whether interested in the lands or not, may institute the proceedings for the punishment of the poacher; and the informer is entitled to half the penalty, the other half going to the poor of the parish. When a poacher is found trespassing on lands in search of game, the person entitled to the game there, or the tenant, or a gamekeeper, or servant of either, may demand the poacher's name and place of abode, and if it is refused, may arrest such poacher, and take him before a justice of the peace; but the poacher must be taken within twelve hours before the justice, otherwise he is entitled to go at large. It is only the persons named (and not any one of the public, or even a constable) who can arrest the poacher, and it can only be done when he is caught in the act on the very lands; for if the poacher clear the fence, and go on to other lands, he cannot then be arrested at all. If game is found on the poachers at the time they are caught, and it appear to have been newly caught, the party who is entitled to arrest him is entitled to seize the game also. If the poacher when convicted do not pay the penalty within the time fixed by the justices, he may be committed to the house of correction for a period not exceeding two calendar months. The party may appeal against his conviction to the Court of Quarter Sessions; but he must either remain in custody in the interval, or give security for the costs. The offence of poaching is punished more severely when five or more go out together, shewing thereby an attempt to intimidate gamekeepers and others, and in such case, each is liable to a penalty of £5. Moreover, if any of these five or more persons, acting in concert, be armed with a gun, and use violence, each is liable to an additional penalty of £5. As to the Night-poaching Act (9 Geo. IV. c. 69), it is provided, that any person by night—i. e., between the first hour after sunset and the first hour before sunrise—unlawfully trespassing in search of game, shall for a first offence be committed by the justices to the house of correction for three months, or in some cases for six months; for a second offence, shall be committed for six months, or in some cases for twelve months; and for a third offence, shall be guilty of a misdemeanour, and be imprisoned for two years. In case such night-poachers are found on the lands and in the act, the owner or occupier of the land or his servants may arrest the poachers, and take them before justices. If the night-poacher, when arrested, use firearms, sticks, or offensive weapons, he shall be guilty of a misdemeanour, and be punishable by two years' imprisonment in addition. In case of three or more night-poachers being armed with guns, bludgeons, or other offensive weapons, each is guilty of a

misdemeanour, and is liable to imprisonment for three years. Poachers have no right to kill game on the highway any more than in fields or enclosures, for the owners of the adjoining land are entitled to the game on the highway. Under the former law, it was, as already mentioned, incompetent for any person except the owner or occupier of the lands to apprehend the poacher, and even this could only be done when the poacher was caught in the act on the lands themselves; and hence, even constables had no power to seize the poacher, though seen to be coming from such lands. But by the recent Poaching Prevention Act (25 and 26 Vict. c. 114), which applies to the United Kingdom, if a constable now meet a suspected poacher on the highway, whom he has reason to suspect of coming from land where he has been poaching, such constable may stop and search the poacher; and if game, or implements for taking game, are found on him, may seize and detain them, and summon him before the justice. When before the justices, if it be proved by circumstantial evidence or otherwise that such game was procured by poaching, or that the implements were used, the poacher may be fined in a penalty of £5, besides forfeiture of the game, and guns, nets, and other implements which he may have so used. The person convicted may appeal, if he chooses, to the next Quarter Sessions, or, in certain cases, to the Court of Queen's Bench. With regard to the poacher's property in the game he kills, it is only in those cases where he is caught in the act, and on the spot, that the game can be taken from him; and this, for obvious reasons, seldom happens. In all other cases, the general rule applies, that whoever first catches (whether legally or illegally) a wild animal, is entitled to the property in it; and as game is in the category of wild animals, the poacher, though, it may be, committing several offences in catching the game, is yet generally entitled to keep it against all comers. The law of Scotland does not materially differ from that of England as to poachers; and the Night-poaching Act applies to it equally as to England. The Scotch Day Trespass Act (2 and 3 Will. IV. c. 68) closely agrees with the English act. But it is singular, that, in the case of night-poachers, the game cannot be taken from the poacher, even when caught in the act and on the lands; though it can be so in England.—*Paterson's Game-law of the United Kingdom*, p. 172. The act conferring power on constables to stop and search poachers on the highway, also extends to Scotland. In England, the poaching of hares or rabbits by night in preserves is a misdemeanour; whereas it is only an offence punishable summarily in Scotland. In Ireland, the law as to poaching is not identical with the law of England, there being distinct statutes; but substantially the law is the same.—*Paterson's Game-law*, 182. The law of the United Kingdom has often been described as too severe against poachers, inasmuch as most of the penalties are cumulative, and the justices who administer the laws are generally game-preservers, and so inclined to convict on the smallest scintilla of evidence. But, on the other hand, it is answered, that poaching is in reality only stealing under a milder name, and that the classes who poach are divided by a thin partition from thieves, game being, in every point of view, as much the fruit of the soil as apples or turnips, and the transition from habitual poaching to stealing being not only easy, but inevitable.—See *Paterson's Game-law*.

2. *Poaching fish* is the unlawfully entering on another's fishery in order to catch fish. The law of fisheries is not uniform in the United Kingdom. In England, the general rule is, that any one of the

## POACHING.

public may fish freely in the sea and in all navigable rivers; and where he can fish, he can catch salmon as well as every other kind of fish. But there is an exception to this generality, which consists in this, that as the crown could before Magna Charta (which took away such right) legally grant a several or exclusive fishery in the sea or a navigable river to an individual, and as this was, in point of fact, often granted, it follows that it is not uncommon to find, even at the present day, an individual, generally the lord of an adjacent manor, still claiming a several fishery in these places. If he can prove that he has exercised this exclusive right as far back as one or two centuries, it will be inferred that his right dates from before Magna Charta, and therefore will be legal. When such is the case, the public have no right to fish even in a navigable river or the sea at the specified places, the sole fishery being vested in this individual owner. In streams not navigable, the rule is, that each riparian owner—i. e., the owner of the lands on the bank of the stream—has a right to a several or exclusive fishery up to the middle line of the stream. If he is owner on both sides of the stream, then he has the exclusive fishery in the whole of the stream, so far as his lands extend. As to ponds, whoever is owner of the soil, is the owner of a several fishery there, unless he has let it to another. As to lakes, it is not clearly ascertained how the fishery is to be divided between the owners of the lands abutting thereon; but much will depend on the title to the lands and the subsequent user. As a general rule, there is no such thing as a right in the public to fish anywhere except in a navigable river or the sea, and that is subject to the exception of an individual claiming a several fishery, as before mentioned. It is often supposed that, at all events, if a highway adjoins a private stream, any one may fish in the stream or angle there; but this is a delusion. Nobody is entitled to use a highway for the collateral purpose of either fishing or poaching, the use of the highway, so far as the public are concerned, being confined to the purposes of travelling or transport. The general rule as to all several, i. e., exclusive, fisheries is, that whoever goes and poaches the fish commits an offence, for which he may be summoned before justices, and fined £5, over and above the value of the fish taken; and if the fishery where he poaches is adjoining the dwelling-house of the owner of the fishery, it is a still higher offence, for it is then an indictable misdemeanour. It is immaterial what kind of fish is caught by poachers, whether salmon or trout, or minnows; and it is immaterial how the fish are caught. But a milder punishment is awarded to the poaching angler, for even though he poach in a fishery adjoining the owner's dwelling-house, he incurs only a penalty of £5; and where the fishery does not adjoin a dwelling-house, he incurs a penalty of only £2. Whenever a fish-poacher is caught in the act of poaching, he may be at once apprehended, not only by the owner of the fishery, but by anybody; but this can only be done while he is on the spot or near it, for if he escape to the highway or to other lands before being arrested, he cannot then be apprehended, but can only be summoned before justices in the usual way. In this respect, a privilege is given to anglers, for in no case can these be arrested, if angling during the daytime; they can only be summoned for the offence. The poacher, when arrested, must be taken within a reasonable time before a justice of the peace, and charged with the offence. Though anybody may arrest the fish-poacher, still it does not follow that the fish poached can be taken from the poacher; on the contrary, the rule is the same as with reference to game, that

whoever first catches the fish, whether legally or illegally, is entitled to keep it; and though game can on certain occasions be taken from the poacher, this is by reason of an express provision in the Game Act; but there is no similar provision as to poached fish, so that the poacher, whatever other punishment he may incur, does not lose his fish. With regard, however, to the poaching implements, such as nets, it is provided by an express section of the Larceny Act (24 and 25 Vict. c. 96, s. 25), that the owner of the fishery or land where the poacher is caught, or his servant, may demand, and if refused, may seize the net, rod, line, hook, or other implement used for taking the fish, but no other person can seize these. It may also be observed that the English Salmon Fishery Act (24 and 25 Vict. c. 109), though singling out salmon from all other fish for peculiar protection, does not deal specially with poachers. Its chief object is to restrain the owners of salmon-fisheries themselves from fishing at certain times and by certain means, for which purpose, a close season is declared, during which no person, whether otherwise entitled or not, can legally catch salmon. Of course, poachers are prohibited from catching salmon at the times and by the means forbidden to the owner, and in this sense come within the Salmon Act. Thus, all persons are prohibited from poisoning salmon-rivers, from fishing salmon with lights, spears, gaffs, stroke-halls, or snatches; from using fish-roe as a bait; from selling or buying salmon roe; from using nets having meshes larger than two inches; from using fixed engines, dams and weirs, destroying young of salmon, &c., &c.

The law of Scotland, as to poachers of fish, differs considerably from that of England. In Scotland, the fundamental rule is, that salmon stands on a different footing from all other fish, and *prima facie* belongs to the crown; so that no person in Scotland is entitled to fish salmon (except by angling) unless he can produce a grant or charter from the crown, conferring upon him such right. But, in point of fact, nearly all the great landed proprietors are in possession of such rights as pertinent to their lands. And the theory of the crown's original right to the salmon applies not merely to rivers, but to the sea-coasts all round Scotland. Hence the public have no right to fish with nets even in the sea, except by leave of the crown, or of the grantee of the crown, at the spot in question. Where a salmon-river belongs to several proprietors, the rule is, that none can fish by using fixed engines; but the only legal mode is the mode of fishing by net and coble (or boat). As regards poachers of salmon, the law is contained in the act 7 and 8 Vict. c. 95. By that law, whoever poaches salmon in a river, lake, or within a mile of the sea-shore, incurs a penalty of £5, besides forfeiting the boat, net, or other engine used to catch the fish. Though the law is as above stated with respect to fishing salmon with nets, yet no grant from the crown is required to enable a riparian owner to angle for salmon. Hence the right of angling for salmon passes as a pertinent of the property in the banks, and each owner is entitled to angle up to the middle of the stream. Anglers who are not riparian owners, and who have no permission from such, are therefore all poachers, and incur a penalty. The Scotch Salmon Fishery Act of 25 and 26 Vict. c. 97 contains prohibitions, like the English act, against owners of fisheries and others fishing salmon by fixed engines during close-time, &c. As regards other fish than salmon, the general rule is, that the riparian owner is entitled to catch all the fish he can, provided he do not interfere with the superior right of some crown grantee of the salmon-fishery. A person who poaches

trout or other fresh-water fish with a net, or by double-rod fishing, or cross-line fishing, or set lines, &c., incurs a penalty of £5, besides forfeiture of the fish caught. And he may be arrested if he is net-fishing, but not if he is fishing in another way. Moreover, a mere angler of trout, though a poacher, cannot be arrested, nor yet punished by any penalty; though he is liable to an action at law, which, however, is virtually no remedy at all. So, in the case of all poachers of trout (except angling poachers, who can neither be arrested, nor yet have their fish or fishing-rod taken from them by force), the owner of the fishery, or any person authorised by him, may seize the nets, boats, and fishing implements, if the poachers are found on the spot. Though angling for trout is thus privileged in Scotland above what it is in England in this respect, that the poaching angler cannot be arrested or fined by justices of the peace, but is only liable to an action, yet the poaching angler of salmon may be fined. The public have no right to angle from a highway adjoining a stream. Where a stream runs through a farm, the farmer has a right to angle for trout, unless the lease expressly forbid it; but he cannot fish for salmon with a net, or even by angling, for it interferes with the crown grantee, if there is one. It has also been held that he cannot fish for trout with a net, but this decision is supposed to be unsound, and would probably be reversed, if the point were raised. There is a special salmon statute for the river Tweed, and for the Solway and the Scotch rivers running into these, and for some other rivers; but these statutes do not substantially differ from the general law.

In Ireland, the law of poachers of fish is the same as in England in all the main points, for the same statute applies. There are also various special acts affecting the salmon and sea-fisheries of Ireland, which vary from the law of England; but as they do not peculiarly affect the law of poaching, it is unnecessary to specify them. See the whole subject explained in Paterson's *Fishery Laws of the United Kingdom*.

**POAK.** Under this name, the scrapings of the flesh-side of skins in fellmongers' and tanners' yards, together with the other animal refuse, are sold to the manure-dealers.

**POCAHONTAS**, daughter of Powhatan, an Indian chief of Virginia, was born about 1595. When she was 12 years old, Captain John Smith, the ablest leader of the colony of Jamestown, fell into the hands of Powhatan, and was about to be killed. P. rushed between the victim and the uplifted arm of the executioner, and besought her father to spare his life. The savage chieftain relented; and Smith was conducted in safety to Jamestown, where the young chieftainess with her wild train often visited him. In 1609, she gave him timely notice of a plot to destroy him, and took refuge from her father's anger with another chief. Captain Smith having returned to England, she was taken by Captain Argall, by bribery, held as a hostage, and married to John Rolfe in 1613, and baptised by the name of Rebecca. This alliance with a powerful chief secured a long peace to the colony. In 1616, she was brought to England by her husband, where she was received with great favour, and presented at court. Here also she saw Captain Smith, and at the first interview hid her face two or three hours. She had been told that he was dead. From this blow, she appears never to have recovered. She died at Gravesend, 1617, when about to embark for her native country, after giving birth to a son, from whom are descended the Randolphs and other distinguished families of Virginia.

**POCHARD** (*Fuligula*), a genus of ducks, of the oceanic section (see DUCK), having the bill as long, or nearly as long as the head, broad and very flat, a little dilated towards the tip, the lamellæ of the upper mandible not projecting beyond the margin, the wings and tail short, the tail rounded. The windpipe of the male, in all the pochards, terminates in a labyrinth composed partly of bone and partly of membrane. There are numerous species, some of them natives of the arctic regions; some found, at least in winter, on the coasts of most parts of Europe, Asia, and North America; and some in the southern hemisphere.—The COMMON P. (*F.*—or *Nyroca-serina*), also known as the DUN BIRD, and as the

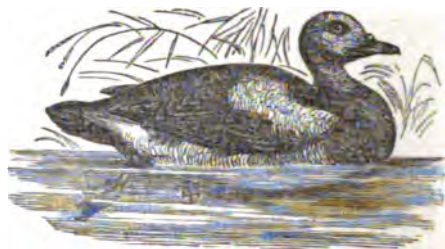

Pochard (*Fuligula serina*).

*Red-headed Pooker* and *Red-eyed Pooker*, is a frequent winter visitant of Britain. It breeds in very northern regions; and is abundant in all of them, but in winter migrates southwards, in America as far as Carolina and Louisiana, whilst in Asia it has been found even in Bengal. It is smaller than the mallard, but rather larger than the wigoeon. The head and neck are bright chestnut, the eyes red, characters which at once distinguish it from every other British duck. It is highly esteemed for the table. Great numbers are sold every winter in the London market.—Several other species are reckoned among British birds.—The TUFTED DUCK (*F. cristata*) is a frequent winter visitant of the bays, estuaries, and lakes of Britain. It is a plump and short bird; black, with a white bar on the wing; the breast, belly, and sides white. The occipital feathers are elongated.—The CANVAS-BACK DUCK (*F. Valisneria*) of North America is a species of pochard.

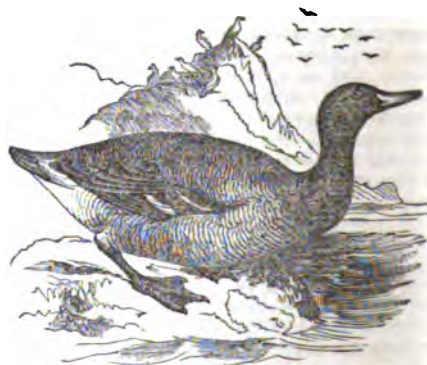

Canvas-Back Duck (*Fuligula valisneria*).

It is very like the Common P., but is much larger, and has the bill higher at the base, and less dilated towards the tip. The upper parts are also whiter. The Canvas-back Duck breeds in the northern parts of America, and migrates southward in flocks in autumn. In winter, it abounds particularly on the

Chesapeake and its tributaries, and is also common southward to New Orleans, often collecting in very large flocks, particularly towards evening. It is very shy, but vast numbers are killed, it being in very high esteem for the excellence of its flesh.

**PO'CO** (Ital.), a little, a term much used in Music, as *poco animato*, rather animated; *poco forte*, abbreviated *pf.*, rather loud; *poco a poco*, signifies by degrees, little by little; *poco a poco crescendo*, becoming loud by degrees; *poco a poco rallentando*, becoming slower by degrees.

**POD.** See **LEGUME**.

**PO'DAGRA.** See **GOUT**.

**PODA'RGUS**, a genus of birds of the family *Caprimulgidae*, nearly allied to the true Goat-suckers (q. v.), but having no connecting membrane at the base of the toes, and the middle toe not pectinated. Some interesting species are natives of Australia, strictly nocturnal in their habits, and remarkable for the difficulty with which they are roused from their sleep by day. *P. humeralis* may be pushed off a branch, and seems scarcely to waken so as to save itself from falling to the ground; and if two are sitting together, as is usually the case, one may be shot without its mate being much disturbed. But by night this bird is all activity.—Another species, *P. Cuvieri*, disturbs the night by a hoarse cry, resembling the syllables *More Pork*, by which name it is therefore known in New South Wales.

**PODE'STÀ** (Lat. *potestas*, power), an Italian municipal magistrate. The name was first applied to foreign magistrates with supreme authority, whom the Emperor Frederick Barbarossa placed over the Italian towns on subjugating them. In the 13th and 14th centuries, an officer bearing the same designation appears, at first occasionally, like the Roman dictator, afterwards in most Italian cities as a permanent magistrate, appointed either by the constituent parliament, or by the Great Council; he superseded all the ordinary magistrates, the military officers, and occasionally the judges. The cause of appointing such an officer was the jealousy that subsisted between the richer citizens and the nobles; the podestà was a stranger, generally belonging to the nobility, and prohibited, during his term of office, from forming any intimate connections in the city which he governed. His chief duty was the execution of summary justice on the lawless barons; and in the great Lombard towns, he generally obtained a predominance to the citizens. Occasionally, however, the podestà became too strong for both parties, securing his re-election during a succession of years, and becoming the despotic ruler of the city.

Podestà is the name now given in many Italian towns to an inferior municipal judge.

**PODGORITZA**, a town of European Turkey, in Albania, 35 miles north of Scutari, close to the frontier of Montenegro. It is fortified, and contains a population of 6000, almost all of whom are Mohammedans.

**PODICEPS.** See **GREBE**.

**PODIEBRAD AND KUNSTAT**, **GEORGE BOCKZO** OF, son of Herant of Kunstat and Podiebrad, a powerful and influential Bohemian noble, of the Husite party, was born in 1420. While still a youth, he threw himself, with all the ardour and resolute force of his nature, into the Husite struggles. Like the rest of his family, however, he adhered to the moderate party of the Hussites during the government of King Sigismund; but when, on the death of that monarch, the Catholic barons

(1438) carried the election of Albrecht V. of Austria (II. of Germany), P. allied himself with the Utraquist Orders in Tabor, and offered the sovereignty of Bohemia to Casimir, king of Poland. Albrecht immediately declared war against him, and invested Tabor, but was forced by P. to raise the siege, and retire to Prague. From this time, P.'s influence was firmly established among the Utraquists; after Lipa, he was the first man of the party. When Albrecht died in 1439, Lipa was appointed regent during the minority of the new king Ladislas; but five years later, Lipa himself died, and P. obtained the government of the country. He, however, was not satisfied. His ambition was to acquire the royal dignity. In 1449, he one night seized the capital, drove away all the Catholic barons, and even imprisoned his colleague in the regency, Meinhardt von Neuhaus. This outrage led to a year or so's fighting—the final result of which was that P. was acknowledged governor or regent by the whole of Bohemia. On the death of Ladislas in 1457, P. managed to get himself chosen his successor, and was crowned 7th May 1458. From this period he began to display the full power and strength of his administrative genius. He reorganised the forms of education and religion, and strove to bring about a peaceful settlement of the religious dissensions that had desolated the land. He even went the length of respectfully soliciting the papal co-operation in his humane endeavours; but his Holiness would have no dealings with this Samaritan ruler, and in December 1463 publicly proclaimed him a heretic. All the neighbouring princes sent letters to Rome, exhorting or imploring the pope to moderation; but the only answer which Pius II. gave them was placing P. under the ban of the Vatican. Shortly after, Rudolf, the papal legate, excited the Catholics of Bohemia to insurrection. P. tried every means of conciliation, but in vain. In September 1466, a German Catholic army burst into Bohemia, but this host of pseudo-crusaders was annihilated at Riesenbergy. Once more Pius excommunicated P.; and in addition, he induced Mathias (q. v.) of Hungary to invade Moravia. The Bohemian king appealed to a universal council, but he also prepared to meet force with force. Summoning back from abroad the banished Taborite warriors, he crushed the insurrection, and compelled his enemies to grant him an advantageous armistice. In 1467, his son Victorin, on the renewal of hostilities, invaded and devastated Austria, while the Hungarians who had invaded Bohemia were surrounded at Vilemov, and forced to cease from hostilities. In spite of the magnanimity shewn by P. on this occasion, Mathias acted falsely towards him, and in the following year had himself crowned king of Bohemia and Markgraf of Moravia. P. instantly summoned the Bohemian diet, and proposed to the assembled orders that they should take the king of Poland as his successor, while his own sons should merely retain the family possessions. By this means, he obtained the Poles for allies; the Emperor Friedrich also declared in his favour, while his Catholic subjects were reconciled to him, so that the Hungarians found it advisable to conclude a peace. P. died 22d March 1471. His sons, Victorin and Henry of Münsterberg, fell back into the ranks of the Bohemian aristocracy; but in the stormy days that followed, they rendered good service to their native land.

**PODIUM**, a pedestal continued horizontally, so as to form a low wall on which columns may be set. Like the pedestal, it has a base, die, and corona, all continued. When the podium breaks forward so as to form a pedestal for a column, it is called the Stylobate.

**PODOCARPUS**, a genus of trees of the natural order *Coniferae*, suborder *Taxineae*, the order *Taxaceae* of some botanists. The leaves, like those of the allied Ginkgo tree, have a remarkable resemblance to the fronds of ferns. The species are natives of New Zealand, the South Sea Islands, and the Indian Archipelago. Some of them are valuable timber trees. *P. cupressina* is one of the best timber trees of Java. It is found also throughout the neighbouring islands and the South Sea Islands. It is a beautiful tree, 50 to 80 feet high, with spreading pendulous branches; the wood is yellowish, and takes a very fine polish. *P. totarra*, the **TOTARRA** or **TOTARRA PINE**, is the most valuable timber tree of New Zealand. It grows in the southern parts of New Zealand, and its trunk has been known to attain a diameter of fully 12 feet. Its wood is equal to the best Baltic pine in durability and for ship-building. The wood of *P. elatus*, the **GAGALI** of the Fijians, is peculiarly elastic.

**PODOLIA**, or **KAMINETZ**, a government of West or 'White' Russia, north of Bessarabia, and bordering on the Austrian frontier. Area, 16,170 sq. m.; population, 1,748,466. The surface is a table-land, strewn with hills, and containing many beautiful districts. Nearly three-fourths of P. is either arable or available for pasturage. Great quantities of corn and fruits, especially melons, are produced, and the fine climate is also favourable to the growth of the vine and mulberry. Hemp, flax, and tobacco are cultivated with success, and the rearing of bees is an important branch of industry. So rich and strong is the grass in the pastures or prairies, that the cattle, of which there are immense herds, can hide themselves from view in it. The population is composed of various races, who live together unmixed. The Russniaks (until lately 'bondagers' or 'serfs') form the majority, and are over a million in number; next come the Cossacks; and then the Jews, who are almost all traders and townspeople. The aristocracy are Poles; but the officials and soldiery, Russians. The government is divided into twelve districts.

**PODOPHTHALMA** (Gr. stalk-eyed), a name often applied to a section or sub-class of Crustaceans, part of the *Malacostraca* of Cuvier, including the orders *Decapoda* (Crabs, Lobsters, &c.) and *Stomatopoda* (Shrimps, &c.). A distinguishing character,

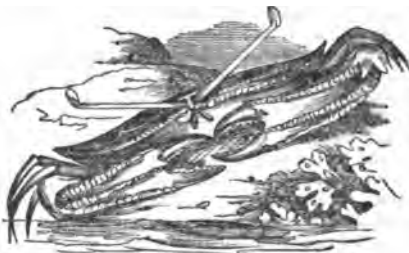

Sentinel Crab.

from which they derive their name, is their stalked and movable eyes. The stalks of the eyes are short in many, but very long in some, of which a beautiful example is presented by the Sentinel Crab of the Indian Ocean.

**PODOPHYLLIN** is the name commonly given to the resin obtained by means of rectified spirit from the root of *Podophyllum peltatum*, or *May-apple*, a plant common throughout the United States. This resin, which occurs as a pale greenish amorphous powder, has (as well as the root from which

it is derived) been introduced into the new British Pharmacopœia, in consequence of the general favour which it has experienced during the last three or four years from the medical profession in this country. It is an active purgative, and seems to have the power of relieving the liver by exciting copious bilious discharges. As its activity seems to vary in different patients, it is better to begin with a small dose of half a grain, which may be combined with extract of henbane, with the view of preventing its griping. It is likely to prove one of the most valuable additions to our pharmacopœia.

**PODOPHYLLUM**, a genus of plants variously ranked by botanists in the natural order *Ranunculaceae*, or made the type of a small distinct order, *Podophylleae* or *Podophyllaceae*, differing from *Ranunculaceae* chiefly in having a solitary carpel. The genus P. has 3 sepals, 6 to 9 petals, 12 to 18 stamens, a broad round stigma, seated almost on the top of the germen, and a many-seeded berry. *P. peltatum* is a perennial plant, with a solitary white flower in the axil of the two leaves; the fruit oval, an inch and a half long, smooth, yellowish, succulent, having a mawkish sweet and subacid taste. It is common in North America, growing in moist woods and on the shady banks of streams, and is known as **MAY-APPLE**, because it flowers and ripens its fruit very early in summer, also as *Hog-apple* and *Wild Lemon*. The fruit may be eaten, but is not agreeable. All the other parts are actively cathartic. See **PODOPHYLLIN**.

**PODURA**, a genus of small wingless insects of the order *Thysanoura* (q. v.), having a linear or cylindrical body, a distinctly articulated thorax, rather long antenna, and a long abdomen, terminating in a tail, which divides at its extremity into two branches. They bend the tail beneath the abdomen, and by suddenly



Podura villosa.

extending it, make prodigious leaps. Hence their popular name, **SPRING-TAIL**. The species of this and allied genera are numerous, and some are found on plants, some under stones and in other damp places, some on the surface of stagnant waters. Their bodies are covered with scales, which are extremely interesting objects, and are among the favourite test-objects for the powers of microscopes.

**POE**, **EDGAR ALLAN**, perhaps the finest and most original poetical genius as yet produced by America, was born at Baltimore in January 1811. Though he came of a good family, his father and mother held no higher social position than that of strolling players. They died while he was yet a mere child; and he was adopted by a Mr John Allan, a rich merchant, who had no children of his own. In 1816 the little Edgar came to England with Mr and Mrs Allan, and was sent to a school at Stoke Newington. In 1822 he returned to America, and attended an academy at Richmond in Virginia, whence he was in due time transferred to the university of Charlottesville. His talent was from the first conspicuous, but unhappily he developed along with it, and continued through life to exhibit a desperate profligacy in all kinds, almost without a parallel in the descents and degradations of genius. Expelled from the university on account of this, he returned to Mr Allan, with whom he presently quarrelled, on the ground of that gentleman's natural reluctance to become responsible for his debts. Quitting the house of his benefactor, he started for Greece, in foolish parody of Byron, to

take part in the war of independence against the Turks. Greece he did not reach; but we find him unaccountably turning up in St Petersburg, drunk and disorderly as usual, and becoming the tenant of a police-cell. The minister of the United States interested himself to procure his release, and sent him back to America. By the good Mr Allan the returning prodigal was welcomed; and on his expressing a wish to follow the profession of arms, an appointment as cadet was procured for him in the Military Academy at West Point. Almost as a matter of course, he was 'cashiered' within the year; and once more he had recourse to Mr Allan, who once more received him kindly. Presently, however, the patience even of this excellent and much-enduring man was exhausted. He had then married a second wife, and this lady an ugly rumour exists that Poe attempted to seduce. One would not willingly believe this unless on most sufficient evidence; but it is certain Mr Allan now ejected him from his premises, and would never again hold communication with him. Cast upon his own resources, he now enlisted as a private soldier, but some injudicious friends, recognising him in this position, busied themselves to procure his discharge. Some little time before this, Poe had published a small volume of poetry [*Al Araaff, Tamerlane, and Minor Poems*, Baltimore, 1829] and its success had been sufficient to encourage him in the attempt to live by his pen. Further to hearten himself in the business, he married a cousin of his own, Virginia Clemm, a beautiful and saintly creature, who in no very long time died, heart-broken, it is but too likely, by the erratic ways of her husband, who wrote a most musical lament for her, sold it, and drank the proceeds. Onward, from the date of his marriage, the life of Poe was that of the professed literary man, and may be chronicled in a single sentence. His brilliant and known ability readily procured him employment; and his frantic habits of dissipation, with the regularity of a natural law, insured his early and ignominious dismissal. He wrote in his drunken, desultory way, poems, tales, criticism, &c. In 1848 he delivered in New York a series of lectures on 'the Universe,' and published them in the form of a volume entitled *Eureka, a Prose Poem*. The work is of a speculative cast, and is considered by competent readers of it to display some distracted ability in that kind, and to leave its subject, 'the universe,' pretty much as Poe found it. A feeble attempt at teetotalism, which he shortly afterwards made, was indirectly the cause of his death. He joined a temperance society, and was for some months actually sober; but chancing to pass through Baltimore, he was waylaid by some ancient 'cronies,' and on the morning of Sunday, 7th October 1849, he was found dead drunk in the gutter, and carried to a hospital, where the same evening he died, at the early age of 35.

Scarce any such dark and disastrous career as that of Poe has a place in all the sad records of genius. From the sins and aberrations of a creature so obviously abnormal, we need not seek to 'point a moral.' Only, in charity, one may hope that the depravity, though terrible, might not be so utter as it seemed. There was about him a strange fascination; his friends loved him—those best who best knew him, and knew him in his wretchedest aberrations. By his wife and her mother he was regarded through all with an obstinacy of tender affection, not for an instant to be shaken.

Whatever may be thought of his morals, of his genius there will be little question. Slight in substance as for the most part it is, small in quantity, and in range limited, there is that in his poetry

which ranks it above everything of this kind which his country has hitherto produced. Save for some traces of imitation in its earlier specimens, his verse is eminently a peculiar and individual product. In keen, clear, lyrical quality the music of Poe at his best is scarcely surpassed by that of any other poet. Not less remarkable in their way are the collection of short tales, of which he has left two volumes. Many of these are wildly and weirdly impressive, though too frequently indulging by morbid preference in ghastly and painful effects. Over very much that Poe has written, alike in prose and in verse, there broods a shadow of misery and hopeless portentous gloom, sadly significant in its relation to the dismal tragedy of his life.

POERIO, CARLO, a noble Italian patriot, was born on the 10th of December 1803. His father, Giuseppe P., Baron Belcastro, was also highly distinguished for his love of liberty and for his sufferings in her cause. Born at Belcastro, in Calabria, in 1775, he took part in the Neapolitan revolution of 1799, and suffered imprisonment on its suppression, but was released in 1802. He also took part in the revolution of 1820, for which Ferdinand handed him over to the Austrians, who assigned him as a place of abode, first Grätz, in Styria, and afterwards Florence. On the recall of the exiles by Ferdinand, in 1833, P. returned to Naples, where he spent the rest of his life, and died 16th August 1843. He left two sons, the elder, Alessandro [born in 1802, celebrated as a poet and patriot, and died (of amputation of a limb) after the battle of Mestre, 27th October 1848], and Carlo, the subject of our notice. Carlo was educated with great care under the parental roof, and trained even from infancy, by the example of his father and brother, to place the love of his country above every other affection. In 1828 he joined the liberals of Naples, and took part in the conspiracy of Avellino, for which he was imprisoned until March 1838. He was concerned in the attempt made in 1847 to extort liberty, but was discovered, and after the movement at Reggio was sent back to prison with D'Ayala, Bozzelli, De Augustinia, Assanti, and others. The revolution in Sicily, which broke out at Palermo on the 12th January 1848, set him at liberty, and he immediately gave himself to the organisation of the famous demonstration of the 27th January 1848, which was destined to produce the constitution of the 10th February. Carlo was successively nominated Director of Police, and Minister of Public Instruction; but he soon resigned, and also refused the rank of Privy Councillor, offered to him by Ferdinand. He was appointed deputy to the parliament.

On the 18th July 1849, an unknown hand left in P.'s house a note to the following effect: 'Flee without a moment's delay. You are betrayed. Your correspondence with the Marquis Dragonetti is in the hands of the government.' As there had been no such correspondence, and as it was P.'s wish to maintain the combat to the last on the ground of legality, he did not flee. On the following day he was arrested, and his house was ransacked. Six days after, a letter of Dragonetti's was given him to read, in which he spoke of an invasion by Garibaldi, instigated by Mazzini and Palmerston. The letter was a forgery of the police! P. compared it with other authentic letters of Dragonetti, and proved it to have been forged. As the government could not bring him to trial on that pretext, it had recourse to a spy, Jervolino, who accused P. of being at the head of a sect—which never existed—called the Italian Unity, which aimed at proclaiming a republic, and murdering the king and the ministers.



P. demanded to be confronted with Jervolino, but this was refused. When this accusation also fell to the ground, Peccheda, who was at the head of the police, tried to induce the others who were indicted for political reasons to denounce P. as a revolutionist, promising them liberty as the reward. His design partly succeeded. He extorted from Romeo the printer, and from Margherita some false accusations, which the fear of death caused those unfortunate persons to make. But they were of no avail, and recourse was again had to the accusation made against P. by Jervolino; and although P. brought forward many clear proofs that the informer was paid by the police to do him harm, the court paid no attention to that, nor to any other of his objections, and concluded by inflicting on him the penalty of passing 24 years in irons, and of a heavy fine.

Thus Carlo P., a minister, and a member of parliament, a man of rare genius and of exemplary life, was cast into the hulks at Nisida, dressed as a felon, and dragging 15 pounds of chains; and thence, through the suspicions of the government, who dreaded his escape, he was conveyed from hulks to hulks, from Nisida to Procida, from Ischia to Montefusco, and finally to Montesarchio. Assassins and thieves were given him as companions in order to humble him, as if the virtue of the truly great man could be sullied by the presence of miscreants and cut-throats. He indignantly spurned the proposal to petition for his liberty.

The protests of the English and French diplomats against the iniquitous state trials, which had been instituted in Naples with the sole object of condemning persons obnoxious to the king; the letters of Mr Gladstone; the constant dread of a popular rising on behalf of the condemned political offenders, and especially of P., disturbed the mind of Ferdinand II. to such a degree that he sought some means of ridding himself of the prisoners of Montesarchio. Having failed in every attempt to force them to ask pardon, he resolved to send them to America. On the 19th January 1859, P. and 66 other prisoners, among whom were Settembrini, Spaventa, Pica, the Duke of Castromediano, Braico, Schiavoni, Argentino, Pace, Damis (all of whom are now members of the Italian parliament), were conveyed to Pozzuoli, and put on board of the *Stromboli*, which immediately set sail for New York. When they reached Cadiz, P. and his companions were put on board an American vessel, the captain of which, however, was induced to land them at Cork, whence they returned, by London, to Turin. In the following year P. was elected deputy by two colleges in Tuscany, and took his seat in parliament.

When Garibaldi (q. v.) had driven out the Bourbon dynasty, P. returned to Naples. He declined the ministerial office offered to him by Cavour, and also the governorship of the southern provinces proposed to him by Costantino Nigra, but accepted the office of privy councillor. The privy council elected him its vice-president; then, being re-elected deputy, he was proclaimed vice-president of the parliament.

POET-LAUREATE See LAUREATE

POETRY (from the Greek *poies*, to make, or to create), according to the mere etymology of the word, signifies a creation or production of any kind; but its classical equivalent, *poiesis*, was applied by the Greeks almost exclusively to designate the artistic productions of the imagination, expressed in language. Poetry is thus not necessarily associated—as many people seem to think

—with verse or rhyme. It may find expression in prose, and in point of fact has often done so, both in ancient and modern times. The Book of Ruth, for example, is decidedly poetical in substance, yet in form it is strictly prosaic. The same may be said in a still more remarkable degree of the Book of Job and the Prophetical Writings, as they appear in our English version. Jeremy Taylor, Hooker, Rousseau, Burke, Carlyle, Ruskin, Hawthorne, Emerson, and other modern prose writers, are often as richly or profoundly imaginative as poets by profession; but although the essence of poetry lies rather in the nature and adornment of the thoughts expressed than in the form of the composition, yet in general it has subjected itself to certain rules of *metre* or measure, and often also to rules of *rhyme*. The reason of this practice lies in the fact that the music so produced by the mere words is found to heighten the emotions which their meaning is calculated to produce, and thus furthers the end that the poet has in view. It is from this circumstance that the term poetry has become almost synonymous with metrical composition. Poetical compositions are of several kinds or classes, to which particular terms are applicable; the principal are the Epic (q. v.), the Lyric (q. v.), and the Drama (q. v.). To the first of these belongs the Ballad (q. v.); to the second belong the Song (q. v.) in all its varieties, serious and comic, the Hymn (q. v.), Ode (q. v.), Anthem (q. v.), Elegy (q. v.), Sonnet (q. v.), &c.; the third embraces Tragedy and Comedy. Besides these three principal kinds, others of less consequence may be mentioned, such as Didactic Poetry (q. v.), Satirical Poetry (see SATIRE), in which, however, imaginative and ideal elements in general mingle so sparingly that the stricter kind of critics exclude them from the circle of poetry altogether. The Germans have produced several treatises on the history of poetry, such as Rosenkranz's *Handbuch einer allgemeineren Geschichte der Poesie* (3 vols. Halle, 1832), and Zimmermann's *Geschichte der Poesie aller Völker* (Stuttg. 1847).

POGGE (*Aspidophorus Europæus*), a fish of the family *Sclerogenidae*, or *Mailed Cheeks*, and nearly allied to the Bullhead (q. v.), but having the body cuirassed with large bony scales from the head to the tail fin, so that it is in form nearly a pyramid with eight faces. The head is thicker than the body, with points and depressions, the snout furnished with short recurved spines. The P. is also known on the coasts of England as the *Armed Bullhead*; and on the coasts of Scotland by the names *Lyrie*, *Pluck*, and *Noble*. It is pretty common on the British coasts. It is seldom more than six inches long. Notwithstanding its uncouth appearance, its flesh is good.

POGGENDORF, JOHANN-CHRISTIAN, a German physicist, was born at Hamburg, 29th December, 1796. He studied pharmacy, chemistry, and physics; and since 1834 has been professor of the last-mentioned science at Berlin. In 1838 he became a member of the Academy of Sciences. His chief discoveries have been in connection with electricity and galvanism, and these are reckoned of great value; he has also invented a multiplying galvanometer for measuring the calorific action of currents. Since 1824 he has edited the *Annalen der Physik und Chemie*, contributing to this collection many important memoirs. He was one of the triad (Liebig and Wöhler being the other two) who prepared the *Dictionnaire de Chimie* (Brunswick, 1837—1851). The two works published by himself are the *Linten zu einer Geschichte der exacten Wissenschaften* (Berlin, 1853), and *Biographisch*

*literarisches Wörterbuch zur Geschichte der exacten Wissenschaften* (Berlin, 1858), the latter not being yet completed.

**POGONIAS**, a genus of acanthopterous fishes, of the family *Scienidae*, having two dorsal fins, one of them deeply notched, and many small barbels under the mouth. The fishes of this genus are found on the coasts of warm countries; and are remarkable for the sounds which they emit, which somewhat resemble those of a drum, and have obtained for them the name of **DRUMFISH**. It is not known how these sounds are produced; but sailors in vessels anchored near the shore, where species of this genus abound, are often prevented from sleeping, until they have become habituated to them. Some of the species attain a large size, one hundred pounds or more, and are excellent for the table.

**POINDING** (same root as *Eng. pound*), in the law of Scotland, means the seizing and selling of a debtor's goods under process of law, or under the warrant of a *debitum fundi*, in order to pay the debt. It is either real or personal. Real poinding is the attaching of goods or movables on the land over which some real or heritable security exists. It is one mode in which heritable security is made effectual. Thus, the superior of lands can point the ground to obtain payment of his feu duties; and the holder of a heritable bond can do the same in order to recover his debt. Personal poinding is the mode in which a decree of the court is made effectual by the messenger or bailiff seizing the movables of the debtor. They are then appraised or valued, and the messenger reports his execution to the sheriff, or other judge ordinary, who grants warrant to sell the goods by public roup after advertisements. The net amount of the sale is paid over to the creditor, or if no purchaser bid for them, they are delivered to the creditor at the appraised value. There is also another kind of poinding, called a poinding of stray cattle, which takes place whenever the cattle of a stranger trespass on lands, in which case the owner or occupier of the lands can seize them *brevis manu*, and keep them as a security until the damage done by the cattle is paid to the owner of the land. By an old Scotch statute, the owner of the cattle is bound to pay, besides the damage, half a merk for each head of cattle, and for the damage, penalty, and expense of keeping the cattle, the owner of the land can detain the cattle until payment. The pointer must, however, take care to keep the cattle in a proper place, and feed them. In England, the word poinding is not used, the corresponding term being *Distraining* or *Distress* (q. v.).



Point.

**POINT**, in Heraldry, a triangular figure issuing from the dexter and sinister base of the shield. It is common in French and German heraldry, and occurs in the shield of Hanover, which was a part of the royal arms of Great Britain from the accession of George I. till that of our present sovereign. A shield charged with a point is in heraldic drawing hardly distinguishable from one parted per chevron.

**POINT-BLANK**. See **GUNNERY**. The point-blank range of a cannon varies from 200 to 300 yards.

**POINT DE GALLE**, a fortified town and seaport on the south-west extremity of the island of Ceylon, stands on a low rocky promontory of the same name, in lat. 6° 1' N., long. 80° 12' E. The harbour, formed by a small bay, the entrance to which is about a mile in width, is good, although

there are numerous rocks, and a pilot is required to conduct vessels to the anchorage. Among the principal edifices, are the fort—a mile in circumference—the old Dutch church, a Roman Catholic chapel, an excellent Orphan Asylum, barracks, and light-house, 103 feet above sea-level. This town has become important within recent years, and specially since the organisation of the Peninsular and Oriental Steam-navigation Company. Vessels plying between Suez and Bombay and Calcutta, Australia, China, Penang, and Singapore, call here to coal and to tranship passengers. In 1860, 712 vessels, of 362,184 tons, entered and cleared the port. Gold and silver ornaments, workboxes, &c., are made with great taste and nicety by the native workmen. Pop. 100,000.

**POINTED ARCHITECTURE**. See **GOTHIC ARCHITECTURE**.

**POINTER**, a kind of dog nearly allied to the true Hounds (q. v.), but not reckoned one of them. It is remarkable for its habit of *pointing* at game; its whole body, and particularly its head, indicating the position of the game to the sportsman; and a well-trained P. will remain long immovable in the attitude of pointing, not going forward to disturb the game which its exquisite power of scent has enabled it to discover. It is recorded of two pointers that they stood an hour and a quarter



A Pointer standing at Game.

without moving, whilst Mr Gilpin painted them in the act. The P., when he scents game, stops so suddenly and completely, that even the fore-foot, already lifted, remains suspended in the air. Without the P., the sportsman would have comparatively little success in the pursuit of grouse; but the dog performs for him the laborious task of 'beating' the wide moors. Well-trained pointers will scarcely point at anything except 'game'; but inferior dogs often point at almost any living creature the odour of which affects their nostrils. The habit of pointing once acquired, appears to become hereditary, so that very young pointers often exhibit it in great perfection. It has been explained, with the crouching of the Setter, as 'the natural start of surprise or interest which all dogs give when coming suddenly upon the scent or sight of their natural prey; modified by cultivation, and by transmission through many generations, each, by education, improving upon the capabilities of the former.'—See Bell's *British Quadrupeds*.

The breed of pointers now most common in Britain is believed to be crossed with the foxhound, to which there is considerable resemblance in colours as well as in form. The figure is very muscular, the

## POINTS OF THE ESCUTCHEON—POISONING.

hair short, the ears pendulous, the upper lip moderately large, the tail pointed and destitute of brush. Dogs of this breed are very active, and capable of long-sustained exertion. The original breed, the *Spanish P.*, probably brought to Spain from the East, is of more bulky form, less active habit, and less capability of continued exertion. The *P.* is very forward and familiar in its manners, but is both affectionate and intelligent, although it has a reputation of inferiority in these respects to many other kinds of dogs.

**POINTS OF THE ESCUTCHEON**, in Heraldry. In order to facilitate the description of a coat-of-arms, it is the practice to suppose the shield to be divided into nine points, which are known by the following names: A, the dexter chief point; B, the middle chief; C, the sinister chief; D, the collar or honour point; E, the fess point; F, the nombril, or navel point; G, the dexter base point; H, the middle base point; and I, the sinister base point.

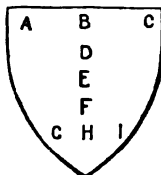

Points of the Escutcheon.

The dexter and sinister sides of the shield are so called, not in relation to the eye of the spectator, but from the right and left sides of the supposed bearer of the shield.

**POISON UDER, POISON IVY, POISON OAKS, POISON SUMACH, AND POISON VINE.** See **SUMACH**.

**POISONING, SECRET**, a mode of taking away life by poisons so slow in their operation that the gradual sinking of the victims under their influence closely resembled the effects of disease or the ordinary decay of nature. It has been practised in all ages, and several undoubted and numerous supposed instances of it are mentioned by Greek and Roman writers. It was not, however, till the 17th c. that this atrocious practice became of frequent occurrence; but from this time it rapidly increased, spread over Western Europe like an epidemic, and became gradually a regular branch of education among those who professed a knowledge of chemistry, magic, or astrology. These persons regarded the knowledge of the mode of preparing secret poisons as of the highest importance, and many of them realised large sums by the sale of their preparations, and occasionally of the secret of their composition. It was in Italy and France that this art was chiefly practised and brought to the highest perfection; but it seems also to have prevailed in England to a considerable extent, for we find that, in the 21st year of Henry VIII.'s reign, an act was passed declaring the employment of secret poisons to be high treason, and sentencing those who were found guilty of it to be boiled to death. The only undoubted instance of this crime which appears prominently in English history is the murder of Sir Thomas Overbury (q. v.) by Viscount Rochester (the favourite minion of James VI.) and his wife, the divorced Countess of Essex; though many suppose, and with some show of probability, that James VI. himself was a victim to similar nefarious practices on the part of Villiers, Duke of Buckingham; and undoubtedly such was the popular impression at the time, for Dr Lamb, a conjuror and quack, who was believed to have furnished Buckingham with the poisons, was seized by the angry populace in Wood Street, Cheapside, London, and beaten and stoned to death. But it was in Italy where this mode of poisoning was most prevalent. There, judging from the writings of various authors, it seems to have been looked upon as a not

unjustifiable proceeding to get rid of a rival or enemy by poison; and from the time of the Lombard invasion down to the 17th c., Italian history teems with instances which sufficiently shew that poison was both the favourite weapon of the oppressor, and the protection or revenge of the oppressed. The Borgias are generally singled out and held up to the horror and detestation of mankind; but as far as their poisonings are concerned, they merely employed this method of destroying their adversaries a little more frequently than their neighbours. To shew the popular feeling on this subject, we may instance the case mentioned in the memoirs of Henry II., fifth Duke of Guise, of a soldier who was requested to rid the duke of Gennaro Annese, one of his opponents in Naples. *Assassination* was the mode proposed to the soldier, but he shrank with horror from the suggestion, stating at the same time that he was quite willing to *poison* Annese. It was shortly after the date of this story (1648) that secret poisoning became so frequent; and the Catholic clergy, despite the rules of the confessional, felt themselves bound to acquaint Pope Alexander VII. with the extent of the practice. On investigation, it was found that young widows were extraordinarily abundant in Rome, and that most of the unhappy marriages were speedily dissolved by the sickness and death of the husband; and further inquiries resulted in the discovery of a secret society of young matrons, which met at the house of an old hag, by name Hieronyma Spara, a reputed witch and fortune-teller, who supplied those of them who wished to resent the infidelities of their husbands, with a slow poison, clear, tasteless, and limpid, and of strength sufficient to destroy life in the course of a day, week, month, or number of months, as the purchaser preferred. The ladies of Rome had been long acquainted with the 'wonderful elixir' compounded by La Spara; but they kept the secret so well, and made such effectual use of their knowledge, that it was only after several years, during which a large number of unsuspected victims had perished, and even then through a cunning artifice of the police, that the whole proceedings were brought to light. La Spara and thirteen of her companions were hanged, a large number of the culprits were whipped half-naked through the streets of Rome, and some of the highest rank suffered fines and banishment. About half a century afterwards, the discovery was made of a similar organisation at Naples, headed by an old woman of threescore and ten, named Toffania who manufactured a poison similar to that of La Spara, and sold it extensively in Naples under the name of *acqueta*, and even sent it to all parts of Italy under the name of 'Manna of St Nicola of Bari,' giving it the same name as the renowned miraculous oil of St Nicola, to elude discovery. This poison, now best known as the 'Acqua Tofana' or 'Acqua di Perugia,' is said by Hahnemann to have been compounded of arsenical neutral salts; while Garelli states that it was crystallised arsenic dissolved in a large quantity of water; but both agree that it produced its effect almost imperceptibly, by gradually weakening the appetite and respiratory organs. After having directly or indirectly caused the death of more than 600 persons, Toffania was at length seized, tried, and strangled in 1719. From this time the mania for secret poisoning gradually died away in Italy.

About the middle of the 17th c., this horrible practice seems to have first become prevalent in France, and under similar circumstances, the agents being married women, and their husbands the victims; and as in Italy, the extent to which the

practice was carried was first made known by the clergy. The government, acting on the information thus obtained, seized and imprisoned in the Bastille two Italians named Exili and Glaser, who were suspected of having been the manufacturers and vendors of the poisons. Glaser died in prison; but Exili, becoming acquainted with another prisoner named St Croix, communicated to him his secret, which the latter made considerable use of after his release, compounding in particular the poison known as 'succession powder,' which subsequently became so celebrated. It was the same St Croix who played such a prominent part in the tragical history of the Marquise de Brinvilliers (q. v.). Penautier, the treasurer of the province of Languedoc, and the Cardinal de Bonzy, were both pupils of St Croix, and managed, the one to pave the way for his own advancement, and the other to rid himself of his numerous creditors, by the administration of poison; but the great influence of these men, and the want of direct evidence, barred all proceedings against them. Secret poisoning now became fashionable; the passions of jealousy, revenge, avarice, and even petty spite, were all satisfied in the same way, and as a necessary consequence, other offences decreased in proportion. The prisons teemed with suspected criminals, and the 'Chambre Ardente' was instituted for the special purpose of trying these offenders. In Paris, this trade was chiefly in the hands of two women named Lavoisin and Lavigoreux, who combined with the ostensible occupation of midwife that of fortune-teller, and foretold to wives the decease of their husbands, to needy heirs that of their rich relatives, taking care at the same time to be instrumental in fulfilling their own predictions. Their houses were frequented by numbers of all classes, both from Paris and the provinces, among whom were the celebrated Marshal de Luxembourg (q. v.), the Duchess de Bouillon, and the Countess de Soissons; the two former of these, however, went merely from curiosity. Lavoisin and her confederate were at last discovered, tried, condemned, and burned alive in the Place de Grève, 22d February 1680; and from 30 to 50 of their accomplices were hanged in various cities of France. So common had this atrocious practice been, that Madame de Sévigné, in one of her letters, expresses a fear lest the terms 'Frenchman' and 'poisoner' should become synonymous. For two years after the execution of the two Parisian poisoners, the crime continued to be largely committed, being fostered by the impunity with which offenders of high rank were allowed to escape; and it was not till more than 100 persons had died at the stake or on the gallows, that the government succeeded in suppressing it. The mania for secret poisoning has not since been revived to the same extent, though isolated instances of its practice have occasionally been discovered, particularly in England, where, within the last 30 years (1864) extraordinary disclosures have at different times been made of the prevalence of this frightful crime among the labouring classes in several of the rural districts. For further information consult Beckmann's *History of Inventions*, the historians of the period of James I.'s reign, the French *Causes Célèbres*, and Mackay's *Popular Delusions*.

**POISONS.** A poison is commonly defined to be a substance which, when administered in small quantity, is capable of acting deleteriously on the body; but this definition is obviously too restricted, for it would exclude numerous substances which are only poisonous when administered in large doses, as nitre, and the salts of lead, antimony, &c. A person may be as effectually poisoned by an ounce of nitre as by five grains of arsenic, and hence the

quantity required to kill must not enter into the definition. Dr Taylor suggests the following as the most comprehensive definition that can be given: 'A poison is a substance which, when taken internally, is capable of destroying life without acting medicinally on the system;' but this definition is not perfect, for it does not include poisons that act by absorption when applied to a thin and delicate membrane, as glanders, syphilitic poison, &c., or those which must be introduced directly into the circulation by a puncture or abraded surface, as the poison of insects, scorpions, and serpents, the wourali poison, and that of animals suffering from hydrophobia. Omitting, for the present, the consideration of the cases not included in Dr Taylor's proposed definition, we may consider poisons as divisible into three classes, according to their mode of action on the system—viz., *Irritants*, *Narcotics*, and *Narcotico-Irritants*.

The *Irritants*, when taken in ordinary doses, speedily occasion intense vomiting and purging, and severe abdominal pain. They act chiefly on the stomach and intestines, which they irritate, inflame, and frequently corrode, and may thus occasion ulceration, perforation, or gangrene. Amongst those which possess corrosive properties, are the strong mineral acids, caustic alkalies, corrosive sublimate, &c.; whilst among the pure irritants which exert no destructive chemical action on the tissues with which they come in contact, may be mentioned arsenic, cantharides, carbonate of lead, &c. The *Narcotics* act specially on the brain and spinal cord. Amongst their most common symptoms are giddiness, headache, obscurity of sight or double vision, stupor, loss of power of the voluntary muscles, convulsions, and, finally, complete coma. Moreover, many of the narcotic poisons present special symptoms, in some cases strongly resembling pure special diseases. Thus there is an almost exact similarity in the symptoms of poisoning by opium and of apoplexy, whilst prussic acid and some other poisons give rise to symptoms closely resembling those of epilepsy. These poisons have no acrid, burning taste, nor do they usually give rise to vomiting or diarrhoea, and, excepting a slight fulness of the cerebral vessels, they leave no well-marked post-mortem appearance. They are few in number, and none of them belong to the mineral kingdom. The *Narcotico-Irritants* have, as their name implies, a mixed action. 'At variable periods,' says Dr Taylor, 'after they have been swallowed, they give rise to vomiting and purging, like irritants, and sooner or later produce stupor, coma, paralysis, and convulsions, owing to their effect on the brain and spinal marrow. They possess the property, like irritants, of irritating and inflaming the alimentary canal. As familiar examples, we may point to nuxvomica, monkshood, and poisonous mushrooms. . . . The fact of the symptoms occurring after a meal at which some suspicious vegetables may have been eaten, coupled with the nature of the symptoms themselves, will commonly indicate the class to which the poison belongs. Some narcotico-irritants have a hot, acrid taste, such as the aconite or monkshood; others an intensely bitter taste, as nuxvomica and its alkaloid strychnia.'

For a notice of the most important rules to be observed by the physician in all cases of suspected poisoning, both with respect to the symptoms and to the inspection of the body, we must refer to any of the standard works on poisoning, or on medical jurisprudence.

Under the head of *Irritant Poisons* may be included, (1.) Mineral Acids, as sulphuric, nitric, and hydrochloric acids; vegetable acids, and other

## POISONS.

salts, as oxalic acid, binoxalate of potash, and tartaric acid (in doses of half an ounce or more); the alkalis, as pearl-ash (carbonate of potash), soap lees (carbonate of soda), ammonia and its sesquicarbonate; and metallic compounds, as white arsenic (arsenious acid), yellow arsenic (orpiment), corrosive sublimate, bichloride of mercury, pernitrate and other salts of this metal, acetate of lead (sugar of lead) in doses of an ounce and upwards, carbonate of lead (white lead), sulphate of copper (blue vitriol), subacetate of copper (verdigris), arsenite of copper (commonly known as *Scheele's green* or *emerald green*, and much employed under the name of *extract of spinach* for colouring confectionary), tartarised antimony, chloride of antimony (butter of antimony), chloride of zinc (Sir W. Burnett's Fluid), nitrate of silver (lunar caustic), sulphate of iron (copperas or green vitriol), and chromate of potash. (2.) Vegetable Substances, viz. colocynth and gamboge in large doses, savin, croton oil, the leaves and flowers of the common elder (*Sambucus nigra*), &c.; and (3.) Animal Substances, such as cantharides, to which must be added the occasional cases in which sausages, and certain fish and molluscs, usually quite innocuous, act as irritant poisons.

The *Narcotic Poisons* include opium, hydrocyanic (or prussic) acid, oil of bitter almonds, cyanide of potassium, henbane, especially the seeds, camphor, alcohol, ether, and chloroform; while *Narcotico-Irritant Poisons* are nux vomica, meadow saffron (*Colchicum*), white hellebore, foxglove, common hemlock, water hemlock (*Cicuta virosa*), hemlock water-dropwort (*Eranthe crocata*), fool's parsley, thorn-apple, monkshood or wolf's bane, deadly nightshade, tobacco, Indian tobacco (*Lobelia inflata*), the bark and seeds of the common laburnum, the berries and leaves of the yew-tree, and certain kinds of mushrooms.

The cases in which there are antidotes qualified to neutralise chemically the action of the poison are few in number. For the *mineral acids* we must prescribe chalk or magnesia in water, with the view of neutralising them, after which milk should be given freely. The *alkalies and their carbonates* must be neutralised by vinegar and water, or lemon-juice mixed with water, after which milk should be given. For *oxalic acid* the antidote is chalk or magnesia in water, by which an insoluble oxalate of lime or magnesia is formed. For *arsenic*, the hydrated peroxide of iron has been regarded as an antidote, but its efficacy is doubtful. Vomiting should be excited by the administration of a scruple of sulphate of zinc in warm water, and after the stomach has been well cleared out, demulcent fluids, such as flour and water or milk should be given. *Corrosive sublimate* combines with albumen (white of egg), and forms an insoluble inert mass; *nitrate of silver* is neutralised by chloride of sodium (common salt) dissolved in water; *tartarised antimony* is to a great degree rendered inert by the administration of decoction of bark or gall-nuts; and *acetate of lead* is rendered inert by the administration of sulphate of magnesia, which converts it into an insoluble sulphate of lead. In all cases of suspected poisoning, in which the nature of the poison is not known, the safest course is at once to produce vomiting by sulphate of zinc, or in its absence by a dessert-spoonful of flour of mustard suspended in tepid water, and to continue the vomiting till all the contents of the stomach are discharged, after which milk should be given freely.

Most of the known gases—except hydrogen, nitrogen, and oxygen—have a poisonous action when inhaled into the lungs; but in these cases death, if it ensues, is popularly said to be due to

*suffocation*, although strictly speaking a person who dies from the effect of carbonic acid, or sulphuretted hydrogen, or of any other noxious gas, is in reality just as much poisoned as if he had taken oxalic acid or arsenic. *Carbonic acid* (q. v.), although seldom employed as an instrument of murder, is a frequent cause of accidental death, and in France is a common means of self-destruction. It is established by numerous experiments that air containing more than *one-tenth* of its volume of carbonic acid, will, if inhaled, destroy life in man and the higher animals. In its pure state it cannot be inhaled, because its contact with the larynx causes spasmodic contraction of the glottis; but when diluted with two or more volumes of air, it can be breathed, and produces symptoms of vertigo and somnolency; and so great a loss of muscular power, that the individual, if in an erect or sitting position, falls as if struck to the ground. The respiration, which at first is difficult and stertorous, becomes suspended. The action of the heart is at first violent, but soon ceases, sensibility is lost, and the person now falls into a comatose or death-like state. Those who have been resuscitated usually feel pain in the head and general soreness of the body for some days, and in a few severe cases, paralysis of the muscles of the face has remained. As a winter seldom passes without several deaths being recorded from coal or charcoal being employed as fuel in ill-ventilated rooms (often without any kind of chimney), it is expedient that every one should know what is to be done in such an emergency. The patient must, of course, be at once removed from the poisonous atmosphere, after which artificial respiration should be had recourse to. If the skin is warm, cold water may be poured on the head and spine; while if the surface be cold, a warm bath should be employed. When respiration is re-established, venesection will often relieve the congestion of the vessels of the brain. The inhalation of oxygen gas is said to have been of service in these cases. *Carbonic oxide*, which exists largely in coal gas, is at least as active a poison as carbonic acid, and is doubtless the principal cause of the effects produced by the inhalation of diluted gas. Both carbonic acid and carbonic oxide act as powerful narcotic poisons. *Sulphuretted hydrogen*, which occurs abundantly in foul drains, sewers, cess-pools, &c., is a gaseous poison whose effects are often noticed. Nothing certain is known of the smallest proportion of this gas required to destroy human life; but air containing only one eight-hundredth of its volume of this gas will destroy a dog; and when the gas exists in the proportion of one two-hundred-and-fiftieth, it will kill a horse. Dr Taylor states that the men who were engaged in the construction of the Thames Tunnel suffered severely from the presence of this gas, which was probably derived from the action of the water on the iron pyrites in the clay, and which issued in sudden bursts from the walls. By respiring this atmosphere, the strongest and most robust men were in the course of a few months reduced to an extreme state of exhaustion, and several died. The symptoms with which they were first affected were giddiness, sickness, and general debility; they became emaciated, and fell into a state of low fever accompanied by delirium. In this case the dilution was extreme; when the gas is breathed in a more concentrated form, the person speedily falls, apparently lifeless. It appears to act as a narcotic poison when concentrated; but like a narcotico-irritant when much diluted with air.

The action of the vapour of *Hydrosulphate of ammonia*, which is also commonly present in cess-pools, &c., is probably much the same as that of

sulphuretted hydrogen. The experiments of Dr Herbert Barker shew, however, that these matters do not produce similar symptoms on dogs (*On Malaria and Miasmata*, p. 212).

Many of the gases, which are only found as products of the laboratory, are in the highest degree poisonous, as arseniuretted hydrogen, cacodyl, &c.; but as few persons run the risk of inspiring them, it is unnecessary to enter into any details regarding them.

We now turn to the consideration of the poisons not included in the definition, which, for want of a better, we have adopted. The poisons that may affect the body by direct introduction into the circulation, through a puncture or abrasion, may be derived from the mineral, the vegetable, or the animal kingdom; but, with a few exceptions (as, for example, Wourali Poison, q. v.), the poisons derived from the mineral and vegetable kingdoms would act as efficiently if introduced into the stomach as if injected into the circulating blood; while the animal poisons act only by direct introduction into the blood, and are inert when introduced into the stomach. Poisoned wounds derived from the dissection of recently dead bodies, commonly known as *dissecting wounds*, are occasionally attended with most alarming symptoms, and often terminate fatally. In the case of Dr Pett, quoted by Travers in his work *On Constitutional Irritation*, the symptoms on the third day were 'a haggard and depressed countenance; violent shiverings, followed by some degree of heat; extreme alteration in appearance; countenance suffused with redness; the eyes hollow and ferrety; some difficulty of breathing, which was sudden, irregular, and amounting almost to sighing; excessive torpor, and the whole aspect resembling one who had taken an overdose of opium: on the following day there was extreme exhaustion and feebleness, and death ensued on the fifth day.' The symptoms produced by the bites and stings of insects, arachnidans, and serpents, and the treatment that should be adopted, are described in the article **VENOMOUS ANIMALS, BITES AND STINGS OF**. The poisoned wounds derived from diseased animals are sufficiently discussed in the articles **GLANDERS** and **HYDROPHOBIA**.

*In point of Law*, the use of poison to kill or injure a human being or certain animals, renders the poisoner amenable to the criminal courts. With regard to the sale of poisons, the legislature found it necessary to put some restrictions on one description—viz, arsenic—in order to prevent persons obtaining it with facility, and in such a manner as to avoid detection. The 14 and 15 Vic. c. 13, requires every person who sells arsenic to enter in his books the date and quantity and purpose of its use, all which particulars may be inquired into before the sale. It is not to be sold to one who is unknown to the vendor unless in presence of a witness who is known, and whose place of abode is recorded in the book. The arsenic must also be mixed with soot or indigo, in the proportion of half an ounce of soot or indigo to a pound of arsenic. Those who offend against the act incur a penalty of £20; but in ordinary prescriptions arsenic may be used in the ordinary way by duly qualified medical practitioners. There is no restriction on the sale of other poisons than arsenic. The offences committed by those who administer poisons to mankind are as follow: Whoever causes death by poison commits murder, for the means are immaterial if the death was caused by such means with a felonious intent. Where death is not caused, nevertheless whoever administers poison, or causes it to be administered to any person, with intent to commit murder is guilty of felony, and is liable to penal servitude for life, or

for not less than three years. Moreover, whoever attempts to administer poison, or other destructive thing, to any person with intent to commit murder, is guilty of felony, and is punishable in the same way. These offences are committed whether the poison administered, or attempted to be administered, does injury or not; and it is a sufficient committing of the offence if the poison is put in such a place that a party was likely, and was intended to take it. Moreover, even though murder was not intended, but merely an intent to endanger life or inflict grievous bodily harm, still the offence is felony, and is punishable by penal servitude varying from three to ten years. There is also a similar punishment for the attempt to administer any stupefying drug. Not only is it a crime to administer, or attempt to administer poison to human beings, but if cattle are maliciously killed by poison, the offence is felony, punishable by penal servitude of from three to fourteen years. So to kill by poison any dog, bird, beast, or other animal, ordinarily kept in a state of confinement, is an offence punishable by justices of the peace with imprisonment for six months, or a fine of £20 over and above the injury done. If any person lay poison on lands to kill game, he incurs a penalty of £10. And though tenants of farms, when entitled to kill the game on the estate, may kill hares without having taken out any game certificate, yet they are prohibited from killing such hares by poison. Moreover, by a recent act, 26 and 27 Vic. c. 113, extending to the United Kingdom, whoever sells, or offers to sell poisoned grain, seed, or meal, incurs a penalty of £10. Whoever sows, lays, or puts on ground such poisoned grain incurs a like penalty. The use of poisoned flesh is also prohibited. But the sale or use of any solution, infusion, material, or ingredient for dressing, protecting, or preparing any grain or seed for agricultural use only, if used *bona fide*, is not interfered with.

**POITIERS**, earlier *Poitiers*, a corruption of the Latin *Pictavium*, so-called by the Gallic tribe, the *Pictavi*, who inhabited the district in Cæsar's time, is one of the oldest towns in France; it is the capital of the department of Vienne, and formerly of the province of Poitou. It occupies the summit and slopes of a little eminence, round the base of which flow the Clain and the Boivre, is encircled by walls and towers, and has a very dull appearance. Pop. 25,696. It is connected by railway with Tours, from which it is 63 miles distant, and Bordeaux. Before the revolution, P. had an immense number of churches, chapels, monasteries, and nunneries; even yet these are sufficiently numerous. The principal are the church of St Jean (now converted into a *Musée*), one of the oldest Christian monuments in France; and the cathedral of St Pierre, one of the finest in France, belonging (in part) to the 12th c., and in which, or in the older edifice that occupied its site, 23 councils were held—the first in the 4th, and the last in the 15th century. It also contains the ashes of Richard Cœur-de-Lion. Its university, founded by Charles VII. in 1431, was also abolished after, 1789, but its place has been supplied by a university-academy with two faculties. P. possesses, besides, a very celebrated lyceum, and a variety of other educational institutions, a public library of 25,000 vols. and MSS., a museum, and several learned societies, of which the most distinguished is that for the cultivation of the antiquities of Western France. In and around P. are numerous Celtic and Roman remains. In the vicinity, Alaric II., the Visigoth, was defeated and slain by Clovis in 507. Somewhere between P. and Tours a great battle took place in 732, between the

Franks under Charles Martel (q. v.) and the Moors under Abd-ur Rahmān. The Moors were routed with enormous slaughter—375,000 of them (according to one old exaggerating chronicler) being left dead on the field; later still (in 1356), at Maupertuis-le-Beauvois, about 5 miles north of P., Edward the Black Prince, with some 12,000 or 14,000 Englishmen and Gascons, beat 60,000 of the troops of King Jean of France, and took the monarch himself and one of his sons prisoners.

POITOU, a former province of Western France, is now mainly comprised in the departments of Deux Sèvres, Vendée, and Vienne. It was divided into Upper and Lower P., and had for its capital Poitiers (q. v.). P. first became a possession of the English crown when Eleanor, Countess of P. and Duchess of Aquitaine, after her divorce from Louis VII. of France in September 1151, married, on Whitsunday following, Henry of Anjou, afterwards Henry I. of England. Philippe-Auguste reconquered the province in 1204, and in 1295 it was formally ceded to France. By the peace of Bretigny, in 1360, it again reverted to England, but was soon after retaken by Charles V., who gave it to his brother, the Duke of Berri. It was subsequently incorporated with the French crown.

POITRINAL, or PECTORAL, in ancient armour, was the horse's breastplate, formed of metal plates riveted together as a covering for the breast and shoulders.

PO'LA, the most important naval station of Austria, and one of the most beautiful havens in Europe, belongs to the Markgrafate of Istria. The town occupies an eminence overlooking the Adriatic Sea, 75 miles by sea south of Trieste. The bay is thoroughly sheltered, and is spacious enough to accommodate the largest fleet. The town is surrounded by bastioned walls, is protected by numerous batteries, and is overlooked by the citadel by which it and the bay are commanded. Pop. 2500.

P., a very ancient town, is said to have been founded by the Colchians, who were sent in pursuit of Jason. It was destroyed by Julius Cæsar, but rebuilt by Augustus at the request of his daughter Julia, on which account it was named *Pietas Julia*. In ancient times it had 30,000 inhabitants, and was a station of the Roman fleet. It contains numerous and interesting Roman remains, among which are a beautiful and well-preserved amphitheatre, 436 feet long, and 346 broad. A temple and several ancient gates are also extant. See Allason's *Antiquities of Pola* (Lond. 1819).

POLA'CCA, or POLONAISE, a Polish national dance of slow movement in  $\frac{3}{4}$  time. It always begins and terminates with a full bar, and a peculiar effect is produced by the position of its cadence, the dominant seventh in the second crotchet of the bar preceding the triad on the third crotchet:



The characteristic

features of the polacca are sometimes adopted in a Rondo, or other lively and brilliant composition, which is then said to be written *Alla Polacca*.

POLACCA, or POLACRE, a species of vessel in use in the Mediterranean, with three masts and a jib-boom; the fore and main-masts being of one piece ('pole-masts'), and the mizen-mast with a top and top-mast. They generally carry square sails, though a few are rigged with a peculiar form of

sail to which the term *polacre* is also applied. The fore and main-masts have, of course, neither tops, caps, nor cross-trees.

POL'LAND, called by the natives *Polska* (a plain), a former kingdom of Europe—renowned, in mediæval history, as the sole champion of Christendom against the Turks; and more recently, and at present, an object of general and profound sympathy throughout Western Europe, from its unprecedented misfortunes—was, immediately previous to its dismemberment, bounded on the N. by the Baltic Sea from Danzig to Riga, and by the Russian provinces of Riga and Pskov; on the E. by the Russian provinces of Smolensk, Tchernigov, Poltava, and Kherson; on the S. by Bessarabia, Moldavia, and the Carpathian Mountains; and on the W. by the Prussian provinces of Silesia, Brandenburg, and Pomerania. Its greatest length from north to south was 713 English miles; and from east to west, 693 miles, embracing an area of about 282,000 English square miles; an area which, in 1859, had a population of 24,000,000. This extensive tract forms part of the great central European plain, and is crossed by only one range of hills, which springs from the north side of the Carpathians, and runs north-east through the country, forming the water-shed between the Baltic and Black Sea rivers. The soil is mostly a light fertile loam, well adapted for the cereal crops, though here and there occur extensive barren tracts of sand, heath, and swamp, especially in the eastern districts. Much of the fertile land is permanent pasture, which is of the richest quality; and much is occupied with extensive forests of pine, birch, oak, &c. Rye, wheat, barley, and other cereals, hemp, wood and its products, honey and wax, cattle, sheep, and horses, inexhaustible mines of salt, and a little silver, iron, copper, and lead, constitute the chief natural riches of the country; and for the export of the surplussage of these products, the Vistula, Dnièper, Duna, and their tributaries afford extraordinary facilities.

The kingdom of P., during the period of its greatest extent, after the accession of the grand-duchy of Lithuania in the beginning of the 15th c., was subdivided for purposes of government into about 40 palatinates or voivodies, which were mostly governed by hereditary chiefs. The people were divided into two great classes—nobles and serfs. The noble class, which was the governing and privileged class, included the higher nobles, the inferior nobles (a numerous class, corresponding to the knights, gentry, &c., of other countries), and the clergy, and numbered in all more than 200,000; the serfs were the merchants, tradesmen, and agriculturists, and were attached, not, as in other countries, to masters, but to the soil. The serfs were thus much liable to ill-usage, and retained more of human energy and dignity than the generality of slaves. The nobles were the proprietors of the soil, and appropriated the larger portion of its products; the serfs in many cases receiving only as much as was necessary for the support of themselves and their families. The nobles were chivalrous, high-spirited, hospitable, and patriotic; the serfs, who had also a stake, though a small one, in the independence of the country, were patriotic and good-natured, but sluggish. The present population of the provinces included in the P. of former days, consists of Poles, Lithuanians, Germans, Jews, Russians, Roumanians, gipsies, &c. The Poles, who number 15,600,000, form the bulk of the population; the Lithuanians, 2,100,000 in number, inhabit the north-east of the country; the Germans, of whom there are 2,000,000, live mostly in towns and in villages apart by themselves, and bear the usual character for economy, industry, and that excessive

## POLAND.

love and admiration for the 'Fatherland,' which guided their politics during the last days of Polish independence; the Jews are very numerous, being reckoned at 2,200,000, but here they are poorer and less enterprising than in other countries; the remainder is composed of Russians (who are few in number, excepting in some of the eastern districts), Russian soldiery, Roumans, gipsies, Magyars, &c. Of Roman Catholics, there are about 9,400,000; Greeks, United and Non-united, 7,900,000; Protestants (mostly Lutherans and German), 2,360,000; the rest are Jews, Armenians, Moslems, &c.

*History.*—The Poles are a branch of the Slavic (q. v.) family. The name appears first in history as the designation of a tribe, the Polani, who dwelt between the Oder and Vistula, surrounded by the kindred tribes of the Masovii, Kujavii, Chrobates, Silesians, Obotrites, and others. In course of time, the Polani acquired an ascendancy over the other tribes, most of whom became amalgamated with the ruling race, whose name thus became the general designation. Polish historians profess to go as far back as the 4th c.; but the lists of rulers which they give are probably those of separate tribes, and not of the combined race now known as Poles. At any rate, the history of P., previous to the middle of the 9th c., is so largely adulterated with fables, as to be little trustworthy. Ziemowicz, said to be the second monarch of the Piast dynasty, is considered to be the first ruler whose history is to any extent to be relied upon; and it was not till a century after, when his descendant, Miecislav I. (962—992), occupied the throne, and became a convert to Christianity, that P. took rank as one of the political powers of Europe. Miecislav (as was the general custom among the Polish rulers) divided his dominions among his sons; but one of them, Boleslav I. (992—1025), surnamed 'the Great,' soon re-united the separate portions, and extended his kingdom beyond the Oder, the Carpathians, and the Dniester, and sustained a successful war with the Emperor Henry II. of Germany, conquering Cracovia, Moravia, Lusatia, and Misnia. He also took part in the dissensions among the petty Russian princes. Under him, P. began to assume unity and consistency; commerce, the impartial administration of justice, and Christianity, were encouraged and promoted; and about the same time, the distinction between the nobles or warrior class (those who were able to equip a horse) and the agriculturists was distinctly drawn. Boleslav was recognised as 'king' by the German emperors. After a period of anarchy, he was succeeded by his son, Casimir (1040—1058), whose reign, and that of his warlike son, Boleslav II. (1058—1081), though brilliant, were of little real profit to the country. The latter monarch having with his own hands murdered the Bishop of Cracow (1079), P. was laid under the papal interdict, and the people absolved from their allegiance; Boleslav accordingly fled to Hungary, but being, by order of the pope, refused shelter, he is said to have committed suicide (1081). Boleslav III. (1102—1139), an energetic monarch, annexed Pomerania, defeated the pagan Prussians, and defended Silesia against the German emperors. A division of the kingdom among his sons was productive of much internal dissension, under cover of which, Silesia was severed from P., though still nominally subject to it. Ultimately, Casimir II. (1177—1194) re-united the severed portions, with the exception of Silesia, and established on a firm footing the constitution of the country. A senate was formed from the bishops, palatines, and castellans, and the rights of the clergy and of the peasantry were accurately defined. His death was the signal for a contest among the

various claimants for the throne, which was speedily followed, as usual, by a division of the country, and during this disturbance Pomerania emancipated itself from Polish rule. About the same time, the Teutonic Knights were summoned by the Duke of Masovia to aid him against the pagan Prussians; but they soon became as formidable enemies to P. as the Prussians, and conquered great part of Podlachia and Lithuania. The Mongols swept over the country in 1241, reducing it to the verge of ruin, and defeating the Poles in a great battle near Wahlstatt. From this time, P. began to decline; various districts were ceded to the markgrafs of Brandenburg, while many districts began to be colonised by Germans. Numbers of Jews, persecuted in Western Europe about this time, took refuge in Poland. Wladislas (1305—1333), surnamed *Lokietek* (the Short), again restored unity to the country, judicial abuses and all illegally acquired privileges were abolished, and the first diet (1331) assembled for legislative purposes. In conjunction with Gedymin, Grand Duke of Lithuania, a vigorous war was carried on against the Teutonic Knights, on returning from which the aged monarch (he was now 70 years old) experienced a triumphant reception from his subjects, who hailed him as the 'father of his country.' His son, Casimir III. the Great (1333—1370), greatly increased the power and prosperity of P. by cultivating with zeal the arts of peace, amending the laws, and consolidating his territories by profitable exchanges with the neighbouring powers. In the latter part of his reign, he was compelled to defend sundry new acquisitions against the Tartars, Lithuanians, and Walachians, which he did successfully. With Casimir, the Piast dynasty became extinct, after a sway of 510 years, according to the old Polish chroniclers. His nephew, Lewis the Great, king of Hungary, succeeded him, by the will of the deceased monarch and the election of the diet; but during his reign, P. was treated merely as an appanage of Hungary. On his death without male heirs, the crown fell to Jagello (Wladislas IV.), Grand Duke of Lithuania, the son-in-law of Lewis, who founded the dynasty of the *Jagellons* (q. v.) (1386—1572), and for the first time united Lithuania and P., thus doubling the extent, though not the population of the kingdom. However, his successor, Wladislas V., was acknowledged only in P. proper, the Lithuanians preferring the rule of the younger son, Casimir. Wladislas was also chosen king of Hungary, and fell at the battle of Varna (q. v.), being succeeded in P. by Casimir IV. (1444—1492), who again united it to Lithuania. Casimir recovered West Prussia from the Teutonic Knights, and compelled them to do homage for East Prussia, rewarding the inferior nobles, or warrior class, with more extensive privileges, putting them on an equality of rank with the great chiefs of the realm, and at the same time necessarily oppressing the peasantry. Manufactures and commerce revived to a wonderful extent during his reign in the western provinces. The brief reigns of his three sons were marked only by the increased power of the two houses of the diet, which had by this time absorbed all but the symbols of supreme authority, and had converted P. from a monarchy to an oligarchy (the king possessing little power beyond what his personal influence gave him). Sigismund I. (1506—1548) surnamed the Great, the fourth son of Casimir, raised the country to the utmost pitch of prosperity. Generous and enlightened, he was beloved by the masses, whom he endeavoured to benefit physically and mentally, while his firmness and justice commanded the respect of the turbulent nobles. He wisely kept aloof from the religious quarrels which distracted Western Europe, by allowing his subjects perfect freedom of



choice in matters of religion; he was, however, forced into a war with Russia, in which he lost Smolensk; but he was partly compensated by obtaining lordship over Moldavia. His son, Sigismund II., Augustus, was a successor worthy of him. During his reign many abuses were rectified, and the extraordinary privileges of the higher nobles were curtailed or abolished; Lithuania was finally united indissolubly to P., and from this time there was to be but one diet for the united realm; each retained, however, its own army, titles, treasury, and laws. Lithuania was at the same time reduced by the annexation of Podlachia, Volhynia, and the Ukraine, to Poland. Livonia was conquered from the Knights Sword-bearers (a community similar to, though much less distinguished than the Teutonic Knights); and the power, prosperity, and opulence of the state seemed to guarantee its position as the most powerful state in Eastern Europe for a long time to come. The population almost doubled itself under the two Sigismunds; but this dynasty, whose sway was so happy for P., ceased with them; and the warrior class having tasted the sweets of freedom, determined to preserve it by rendering the monarchy elective. The election was made by the two chambers of the diet—viz., the senate or chamber of the chief nobles, and the chamber of nuncios, or representatives of the inferior nobles. He who was chosen king possessed the right of assembling the diet, but had to give a list of the subjects to be discussed; and the representatives, before setting out, were instructed as to the side they were to support. The diet only lasted six weeks, and its decisions were required to be unanimous; so that if the *liberum veto* (the right of forbidding the passing of any measure) were freely exercised even by a single member, all legislation was at a stand-still. The evil effects of these regulations were not so much felt at first, as the members were characterised by honesty and zeal for the general good; but latterly, when venality and subservience to the neighbouring powers began to shew themselves, all the measures necessary for protecting P. from dependence on her neighbours were, by a few corrupt and treacherous representatives, rendered of no avail. The first elective monarch was Henry of Valois (III. [q. v.] of France), who, however, soon abandoned the throne for that of France, and was succeeded by Stephen Batory (1575—1586), voivode of Transylvania, a man of energy and talent, who carried on war successfully against the Russians, who had attempted to seize Livonia, pursued them into the very heart of their own country, and compelled the czar to sue for peace; he also subdued the semi-independent Cossacks of the Ukraine, and to some degree introduced civilisation among them. His successor, Sigismund III. (1586—1632), who was succeeded by his sons, Wladislas VI. (1632—1648) and John Casimir (1648—1672), was of the Vasa family, and was the crown-prince of Sweden; but his election, far from cementing a bond of union between the two countries, only embittered former dissensions. These three Swedish monarchs were most unworthy successors to P.'s ablest king, as they had neither talents for governing, nor characters and sentiments congenial to a warlike nation; on the contrary, their policy was weak, tortuous, and vacillating. Yet they were always quarrelling with their neighbours, declaring war with Russia, Sweden, or Turkey, in the most imprudent and reckless manner, and often without valid pretext. But the Polish armies, though as little fostered and cared for as the other portions of the nation, were everywhere victorious; the Swedish and Muscovite armies were successively annihilated; Moscow was taken, and the Russians reduced to such an abject condition, that they

offered to make Sigismund's son, Wladislas, their czar. Sweden made a similar offer to another son of the Polish monarch; but the latter's absurd behaviour lost for P. this rich result of her great victories; and the foolish policy of the whole three not only rendered fruitless all the lavish expenditure of Polish blood and treasure, but lost to the country many of her richest provinces, and left her without a single ally; while their religious bigotry commenced that reign of intolerance and mutual persecution between the various sects which was the immediate cause of P.'s downfall. To shew the power of the Poles at this period, it will be sufficient to notice that Great P., Little P. (Galicia, Podolia, Ukraine, &c.), Livonia, Lithuania (including Samogitia and Black and White Russia, Polesia, and Tchernigov), Pomerelia and Ermeland, Courland, Moldavia, Bukovina, Walachia, Bessarabia, and Prussia, were either integral parts of the Polish monarchy, or were subject to it. The imprudent attempts of the Swedish sovereigns to amend the constitution only excited the suspicion of the nobles, and led to a further curtailment of royal authority. During the reign of this dynasty, Walachia and Moldavia were snatched by the Turks from under the Polish protectorate; Livonia with Riga was conquered (1605—1621), along with part of Prussia (1629), by Sweden; and Brandenburg established itself in complete independence. The Cossacks, who had been goaded almost to madness by the most atrocious oppression and religious persecution, rose in rebellion to a man, put themselves under the protection of Russia, and ever afterwards proved themselves the most inveterate enemies of the Poles. In the reign of John Casimir, P. was attacked simultaneously by Russia, Sweden, Brandenburg (the germ of the present kingdom of Prussia), the Transylvanians, and the Cossacks; the country was entirely overrun; Warsaw, Wilna, and Lemberg taken; and the king compelled to flee to Silesia. But the celebrated staff of Polish generals was not yet extinct; Czarniecki's sword was as the breath of the destroying angel to P.'s enemies; and after being defeated in detail, they were ignominiously expelled from the country. But in the subsequent treaties, Ducal or East Prussia was wholly given up to Brandenburg; almost all Livonia to Sweden; and Smolensk, Severia or Tchernigov, and the Ukraine beyond the Dnieper, were given to Russia. Michael Wisniowiecki (1668—1674), the son of one of the group of famous generals above alluded to, but himself an imbecile, was (contrary to his own wish [for he was well aware of his own deficiencies]) elected as their next monarch; a war with Turkey, concluded by an ignominious peace, was the chief event of his reign. But the senate rejected the shameful treaty, the Polish army was again reinforced, the Polish monarch resigned the command to John Sobieski the Hetman (q. v.), and the Turks were routed with great slaughter at Choczim (1673). After some dissensions concerning the election of a successor, John (q. v.) Sobieski (1674—1696) was chosen; but his reign, though it crowned the Poles with abundance of the laurel wreaths of victory, was productive of no good to the internal administration. As Sobieski's successor, the Prince of Conti was legally elected, and proclaimed king; but the cabinet of Versailles allowed this splendid opportunity of becoming supreme in Europe to escape; and Augustus II. of Saxony, a protégé of the House of Austria, entered P. at the head of a Saxon army, and succeeded in obtaining the throne. Augustus, unlike all his predecessors, never seemed to identify his interests with those of his Polish subjects; and though he gained their hearts by promising to

## POLAND.

reconquer for P. her lost provinces, yet this promise was chiefly made as an excuse for keeping his Saxon army in the country, in violation of the *pacta conventa* (the 'Magna Charta' of Poland). His war with the Turks restored to P. part of the Ukraine and the fortress of Kaminiac; but that with Charles XII. brought nothing but misfortune. The war with Sweden was unpopular in P.; in fact, the Poles of the eastern provinces received Charles with open arms; but his attempt to force upon them Stanislas Leszczynski as their king severely wounded their national pride. Augustus returned after the battle of Poltava (q. v.); his rival retired without a contest; a close alliance was formed with Russia, and the Russian troops which had campaigned in P. against the Swedes were, along with his Saxon army, retained. The Poles demanded their extradition, but in vain; and the Russian cabinet interfered (1717) between the king and his subjects, compelling both parties to sign a treaty of peace. This was the commencement of P.'s dependence on Russia, and her consequent decline. By the instigation of Peter the Great, the Polish army was reduced from 80,000 to 18,000; and the country was further weakened by the diffusion of effeminacy, immorality, and prodigality, through the evil example and influence of the court. Religious fanaticism also more fully developed its most odious features during his reign, and the massacre of the Protestants at Thorn (1724) and the legalised exclusion of them from all public offices was the result. The succeeding reign of Augustus III. (1733—1763) was of the same character; the government fell more and more under Russian influence, and its political relations with other countries gradually ceased. Towards the end of his reign, the more enlightened of the Poles, seeing the radical defects of the constitution, the want of a strong central government, and the dangers of the *liberum veto*, entered into a league to promote the establishment of a well-organised hereditary monarchy. But the conservative or republican party was equally strong, and relied on Russian influence; and the conflict between these parties became more embittered from the fact, that the monarchists supported the Jesuits in disqualifying all dissenters from holding public offices, while the republican party supported the dissidents. The dissidents dated their grievances from 1717, but the great conflict between them and their opponents did not break out till 1763. The cabinets of St Petersburg and Berlin now (1764) presented to the Poles Stanislas Poniatowski as their king. This gross insult, intensified by the incapacity of Stanislas for such an office, could not be borne in quiet; the king and the Russian ambassador were compelled in the diet to listen to the most spirited protests against Russian interference; but the intense national spirit of the Poles only recoiled upon themselves, for the Russian ambassador craftily incited them to insurrection, and kept alive their mutual dissensions. The monarchic or Czartoryski (so called because it was headed by a Lithuanian prince of this name) party had succeeded in abolishing the *liberum veto*, and effecting many other improvements; but they at the same time more severely oppressed the dissidents; and Russia, finding that the political policy of this party was speedily releasing P. from her grasp, joined the party of the dissidents as the champion of religious toleration! Her ambassador caused the chief leaders of the Catholic party to be secretly kidnapped, and sent to Siberia, and compelled the republicans to accept the protectorate of Russia. The 'Confederation of Bar' (so called from Bar in Podolia) was now formed by a few

zealous patriots, an army was assembled, and war declared against Russia. The confederates were supported by Turkey, which also declared war against the czarina; and Russia, alarmed at the appearance of affairs, proposed to the king and diet an alliance, which both firmly refused. Frederic the Great of Prussia, who had formerly gained the consent of Austria to a partition of P., now, in 1770, made the same proposal to Russia, and in 1772, the *first partition* was effected; Stanislas and his diet claiming the mediation and assistance of the other powers of Europe without effect. He was forced in the following year to convoke a diet for the purpose of recognising the claims of the three partitioning powers to the territories they had seized, but few members appeared, and these preserved perfect silence. The territories seized by the three powers were as follows:

	Eng. sq. Miles.	Pop.
Russia, . . .	42,000	1,800,000
Prussia, . . .	13,000	416,000
Austria, . . .	27,000	2,700,000

The whole country was now aroused to a full sense of its danger; and the diet of the diminished kingdom laboured to amend the constitution and strengthen the administration by a liberal code of laws and regulations, which gave political rights to the cities, civil rights to the peasantry, and rendered the kingly authority hereditary. In this they were encouraged by Prussia, whose king, Frederic William, swore to defend them against Russia; but in 1791, Catharine II., after great labour, obtained, by means of intrigues and bribery, the services of *five* (out of 200,000) of the Polish nobility, who protested against the new constitution which had just (May 3, 1791) been established, and drew up a document at Targowitz (q. v.), which they forwarded to the Russian court. Catharine, thus armed with a pretext for interference, advanced her army, and Prussia proving traitorous, a second fruitless resistance to the united Prussians and Russians, headed by Joseph Poniatowski (q. v.) and Kosciusko (q. v.), was followed by a *second partition* (1793) between Russia and Prussia, as follows:

	Eng. sq. Miles.	Pop.
Russia, . . .	96,000	3,000,000
Prussia, . . .	22,000	1,100,000

which the diet were forced to sanction at the point of the bayonet. The Poles now became desperate; a general rising took place (1794); the Prussians were compelled to retreat to their own country, and the Russians several times routed; but then a new enemy appeared on the scene. Austria was chagrined at having taken no part in the second partition, and was determined not to be behind-hand on this occasion; her army accordingly advanced, compelling the Poles to retreat; and fresh hordes of Russians arriving, Kosciusko, at the head of the last patriot army, was defeated; and the sack of Praga, followed by the capture of Warsaw, finally annihilated the Polish monarchy. The *third and last partition* (1795) distributed the remainder of the country as follows:

	Eng. sq. Miles.	Pop.
Russia, . . .	43,000	1,200,000
Prussia, . . .	21,000	1,000,000
Austria, . . .	18,000	1,000,000

King Stanislas resigned his crown, and died broken-hearted at St Petersburg in 1798. The subsequent success of the French against the Russians, and the tempting promises of the Emperor Napoleon to reconstitute P., rallied round him a faithful army of patriots, who distinguished themselves in the campaigns of the French against Russia and Austria; but all that Napoleon accomplished in fulfilment of his promise was the establishment,

## POLAND.

by the treaty of Tilsit (1807), of the *Duchy of Warsaw*, chiefly out of the Prussian share of P., with a liberal constitution, and the Elector of Saxony as its head. The duchy was an energetic little state, and, under the guidance of Prince Joseph Poniatowski, wrenched Western Galicia from Austria (1809), at the same time furnishing a numerous and much-valued contingent to the French armies; but the advance of the grand allied army in 1813 put an end to its existence. After the cessions by Austria in 1809, the duchy contained 58,290 English square miles, with a population of about 4,000,000. Danzig was also declared a republic, but returned to Prussia (February 3, 1814).

The division of P. was re-arranged by the Congress of Vienna in 1815, the original shares of Prussia and Austria were diminished, and that part of the duchy of Warsaw, which was not restored to Prussia and Austria, was united as the *kingdom of P.* (see next article) to the Russian empire, but merely by the bond of a personal union (the same monarch being the sovereign of each), the two states being wholly independent of and unconnected with each other; and the other parts of P. were completely incorporated with the kingdoms which had seized them. The partition of P., as thus finally arranged, was as follows:

Extent in Eng. sq. Miles.	Pop. (in 1856.)	Present Political Divisions.
Russia, . . . . . 220,500	16,000,000	Provinces of Courland, Witebsk, Kovno, Vilna, Grodno, Minsk, Mohilev, Volhynia, Kiev, Podolia; and the <i>kingdom of Poland</i> (q. v.). Posen, most of W. Prussia, and several districts in E. Prussia. Galicia, Bukovina, Zips, &c.
Prussia, . . . . . 36,000	3,000,000	
Austria, . . . . . 35,500	5,000,000	

while, as if in mockery of its spirit of independence, the town of Cracow, with a small surrounding territory, was declared free and independent, under the guardianship of Austria. The czar at first gave a liberal constitution, including biennial diets, a responsible ministry, an independent judiciary, a separate standing army, and liberty of the press; and he seemed to take pride in his title of king of P.; but his brother Constantine, having been appointed military governor, speedily put an end to the harmony between the czar and the Poles, and drove the latter into insurrection. Their discontent at first found vent in secret societies; but on November 30, 1830, Constantine and his Russians were driven out of Warsaw, and a general insurrection of the people, headed by the aristocracy, took place. Prince Czartoryski was appointed president of the provisional government, and military leaders, as Radzivil, Dembinski, Bem, &c., were soon found; but a general want of energy in the administration, dilatoriness on the part of the military leaders, and the checking of the spread of the insurrection till fruitless negotiations had been entered into with Nicholas, were errors fatal to the success of the Poles. From January 1831 till September 8th of the same year, a series of bloody conflicts were fought, in which the Prussians and Austrians, with pitiable subservience, aided the czar. At first, the Poles were successful; but the taking of the capital by Paskievitch (q. v.) soon ended the war, which was followed, as a matter of course, by imprisonment, banishment, confiscation, and enforced service in the Russian army. From this time, the independence of P. was suppressed, and in 1832 it was declared to be an integral part of the Russian empire, with a separate administration headed by a viceroy of the czar's choosing; the constitution and laws were abrogated; strict censorship of the press and the Russian spy police-system established in all its vigour; the country was robbed of its rich literary collections and works of art; and the most severe and arbitrary measures taken to Russianise the people. The outbreaks of 1833 and 1846 were punished by the gallows. Simultaneous disturbances (1846) in the Prussian and Austrian portions of P. were summarily suppressed; their leaders in Prussia were imprisoned, and only saved from death by the revolution of March 1848 at Berlin; and those in Austria were butchered by the peasantry, who preferred the Austrian to a national government. On the 6th of November 1846 the republic of Cracow was incorporated with Austria. After the accession of the Czar Alexander II. in 1855, the condition of the Poles was considerably ameliorated; an act of amnesty brought back many of the

expatriated Poles, and various other reforms were hoped for, when, in 1861, another insurrection broke out. Its origin is curious, and gives a thorough insight into the relations between the Poles and their Russian rulers. A large multitude (30,000) had assembled in the neighbourhood of the battle-field of Grochow (where two battles had been fought in the spring of 1831), to pray for the souls of those who had fallen; they were engaged in prayer and in singing religious chants, when they were charged by the Russian cavalry and *gens d'armes*, several of them killed, and numerous arrests made. This event excited intense national feeling throughout the country; and other national demonstrations, attended with similar massacres on the part of the Russians, produced such an intense dislike to the latter, that most of the Poles in the Russian service either resigned or deserted. The Russians immediately had recourse to the most severely repressive measures, forbidding all assemblages even in the churches, punishing those who appeared to mourn the death of relatives killed in the previous massacres, or who wore garments of certain shapes or colours. The application of the Polish nation to the czar (February 28) for the re-establishment of the Polish nationality, was rejected, but certain necessary reforms were promised. These reforms were on the whole very liberal, and tended greatly to allay the general excitement; but the Russian government was very naturally not trusted by the Poles, and new disturbances broke out in October of the same year. P. was then declared to be in a state of siege, and General Luders appointed military commandant under the Grand Duke Constantine, the nephew of the Grand Duke Constantine above mentioned. The country continued in a state of commotion without any very decided outbreak; attempts were made to assassinate the Grand Duke and the other Russian officials; and on January 13, 1863, Lithuania and Volhynia were also put in a state of siege. The Committee of the National Insurrection issued its first proclamation in February 1863; and a week afterwards, Mieroslavski raised the standard of insurrection in the north-west, on the Posen frontier. The Insurrection Committee continued to guide the revolt by issuing proclamations from time to time; and many districts of Augustovo, Radom, Lublin, Volhynia, and Lithuania, were speedily in insurrection. It was a mere guerrilla war, and no great or decisive conflicts took place; but the sympathy of Europe was largely enlisted on behalf of the Poles. Remonstrances from Spain, Sweden, Austria, France, and Britain conjointly and repeatedly, Italy, the Low Countries, Denmark, and Portugal, were wholly disregarded by the czar's ministers,

## POLAND—POLAR EXPEDITIONS.

and mutual reprisals continued; incendiarianism and murder reigned rampant; the wealthier Poles were ruined by fines and confiscations; and the whole population of villages were put to the sword by the Russians; while murders and assassinations marked the reign of terror of the National Committee. At last, with the officious assistance of Prussia, and the secret sympathy and support of Austria, the czar's troops succeeded in trampling out (1864) the last embers of insurrection. Great numbers of men, women, and even children, concerned in, or supposed to have favoured the revolt, were executed; crowds were transported to Siberia; and these vigorous measures seem to have restored 'tranquillity, but it is the tranquillity of the desert.' Contemporary with this last outbreak, symptoms of similar disaffection were distinctly noticeable in Prussian P., but a strong force of soldiery in the border districts, towards Russia, prevented any outbreak. It deserves to be noticed, that with the exception of the single revolt of 1846 (which perished almost of itself), no rebellion has ever taken place in the portion of P. belonging to Austria.

**POLAND, KINGDOM OF**, a province of European Russia, which was united to that empire in 1815 (see previous article), though the title of kingdom, and a peculiar form of government distinguish it from the other provinces, is surrounded by Prussia, Austria, and Western Russia or Russian Poland, and contains 48,863 English square miles, with a population (1859) of 4,764,446, of whom 3,657,140 are Roman Catholics, 599,875 are Jews, 278,896 are Protestants (Lutherans and Reformed), and 220,823 are Greek Church (mostly united). The surface of the country is in general very level, with now and then a hill, or rather undulation, which relieves the uniformity of the scene. In Radom, however, there is a range of hills, some peaks of which attain a height of 2000 feet above sea-level. The chief river of P. is the Vistula, which enters the country by its southern boundary, and flows first north and then north-west, making its exit near Thorn; two of its tributaries, the Wieprz and the Pilica, belong wholly, and a third, the Bug, partially to Poland. The Warta, one of the tributaries of the Oder, drains the west, and the Niemen, the north-east districts. The Vistula and the Niemen are wholly navigable in P.; and the Bug, Narew, and Warta are so for a considerable portion of their course. By these means of communication, the exports of the country are collected at Danzig, Stettin, Memel, and Tilsit, on the Baltic, and the imports introduced into the country. The climate is severe, the summers being very hot, and the winters excessively cold. The soil very much resembles that of the other parts of the former kingdom of Poland (see preceding article), 22,645 square miles being under cultivation, and producing magnificent crops of wheat, rye, barley, oats, and buckwheat, the usual leguminous plants, hemp, tobacco, flax, and orchard-fruits; 13,330 square miles are covered with forests of pine, birch, oak, ash, and other forest trees; 4360 square miles are laid down permanently in meadow and pastured land; and 8528 square miles are waste, and covered with heath, sand, or swamp. The kingdom is divided for administrative purposes into five provinces; viz :

Provinces.	Eng. sq. Miles.	Pop.
Augustovo, . . .	7162	628,010
Plock, . . .	6670	562,148
Warsaw, . . .	14,007	1,699,461
Radom, . . .	9525	932,603
Lublin, . . .	11,499	962,224
<b>Total,</b>	<b>48,863</b>	<b>4,764,416</b>

The population is about 97 to the square mile,

being more than three times as dense as that of the rest of European Russia. A large proportion of the country population employ themselves in the rearing and breeding of horses, cattle, and pigs; sheep are not so common; but swarms of bees abound, and there is a large export trade in honey. The population of the towns is largely employed in wool-spinning and the manufacture of woollen cloth, cotton and linen spinning and weaving, the production of liqueurs, oil, vinegar, glass and earthenware, paper, beer and porter, &c. The most of the commerce is in the hands of the Jews. The kingdom is directly governed by a *namiestnik* or lieutenant appointed by the czar, who is commander-in-chief of all the Russian troops in it. The lieutenant is aided by a secretary of state (at St Petersburg), an administrative council, and a council of state (to which the members of the administrative council belong *ex officio*). The commerce (1859) of the kingdom with Prussia and Austria is as follows: Imports, £2,741,149; exports, £2,310,661; the trade with Prussia being nearly four times as important as that with Austria. The financial returns for 1860 shew the receipts (including outstanding debts), £2,855,017, and the expenditure, £2,492,160. The chief towns are Warsaw (the capital), Lodz, Lublin, Plotsk, and Kalisz.

**POLAR CIRCLE, or ARCTIC CIRCLE.** See ARCTIC.

**POLAR EXPEDITIONS.** Under this head are classed all those voyages of discovery which have been made towards the north and south poles, and to the regions within the Arctic and Antarctic Circles. The north polar regions present a much greater land-surface than those round the south pole, and on this account possess a higher temperature, and offer a more valuable field for discovery, for which reasons, as well as by reason of their greater proximity, polar expeditions have been far more frequently directed to the north than to the south.

*Arctic Expeditions.*—Polar expeditions were commenced with a view to discover a shorter route to the golden realms of the East; but the first attempts were made by coasting along the north of Europe and America. See NORTH-EAST AND NORTH-WEST PASSAGES. It was not till 1603 that the first arctic exploring expedition, consisting of one vessel, the *Godspeed*, commanded by Stephen Bennett, started for a voyage of northern discovery; and this, as well as the succeeding expeditions of Bennett, were devoted to mosehunting rather than to geographical investigation. In 1607, Henry Hudson (q. v.) was sent out by the Muscovy Company to penetrate to the north pole, but he was stopped about the north of Spitzbergen (in lat. 81° 30') by the ice. The succeeding voyages of Jonas Poole in 1610, 1611, and 1612, and of Baffin in 1613, were not primarily voyages of discovery, and they added nothing to the previous knowledge of the polar regions; but in the expedition of Fotherby and Baffin up Davis' Strait, in the following year, the latter discovered a northern outlet to the bay called by his own name, which was denominated Smith's Sound. Fotherby was sent out again in 1615, and attempted to pass through the sea which lies between Greenland and Spitzbergen, but was again baffled, and compelled to return, after correcting some erroneous observations of Hudson. These seven expeditions were all sent out by the Muscovy Company; and the cargoes of seal-skins, oil, teeth, &c., which they brought back helped to defray the expense of their outfit. For the next century and a half, the attempts to reach the north pole were

not resumed; but the extraordinary zeal in the cause of naval discovery which sprung up in the beginning of George III's reign, produced two renewed efforts. The first of these was made in the spring of 1773 by an expedition, consisting of two vessels, under Captain John Phipps (afterwards Lord Mulgrave), and fitted out by the Admiralty purely for scientific purposes. Phipps sailed along the shore of Spitzbergen till he was stopped by the ice at Cloven Cliff; he then coasted backwards and forwards along the ice-field for nearly a month, trying the various narrow openings, some of which were two leagues in depth, till he found one which took him into open water. By a sudden change in the climate, he was frozen in, and only extricated his ships after severe labour. The highest point to which he reached was lat.  $80^{\circ} 48' N.$ , less by 49 miles than the most northerly latitude attained by Hudson; and though he had a more than usual amount of difficulties to encounter, yet his failure, along with that of Captain Cook, who attempted to reach the pole by Behring's Strait, but only penetrated to lat.  $70^{\circ} 45' N.$ , greatly disheartened other explorers. The offer of £5000 by the British parliament to the crew that should penetrate to within  $1^{\circ}$  of the pole, awaked no competition; but in 1806, Mr Scoresby, then mate of a Greenland whaler from Hull, reached a point directly north of Spitzbergen, in lat.  $81^{\circ} 30' N.$ , and therefore only about 510 geographical miles from the pole. In following expeditions, the same enterprising navigator made many geographical explorations of Jan Mayen's land and the east coast of Greenland, largely adding to our knowledge of the character and products of the arctic regions. The subsequent expeditions of Buchan and Franklin in 1818, of Clavering in 1823, of Graab (Danish) in 1828, of De Blotseville (French) in 1833, may be considered as failures, as far as geographical discovery is concerned; for, omitting the French expedition, the fate of which is still involved in mystery, none of them reached so high latitudes as the previous English expeditions. After the failure of Buchan and Franklin's expedition, the impossibility of ever reaching the pole was generally accepted in this country as fact; but Mr Scoresby, in a Memoir which he communicated to the Wernerian Society, endeavoured to prove that this supposed impossibility was by no means such; in fact, that a journey to the pole could be made without any enormous amount either of difficulty or danger. The principal obstacle to be encountered being the alternation of ice-fields and water, which prevented all advance either by ships or sledges, Mr Scoresby proposed the use of a vehicle which could be used either as a sledge or boat, and recommended a team of dogs to draw it, they being lighter (for conveyance by water, and for travelling over thin ice) and more tractable than reindeer. After some time, this suggestion began to receive a considerable share of attention, and Captain Parry (celebrated for his discoveries in the polar seas north of America) was put in command of an expedition fitted out in accordance with Scoresby's plans. He sailed from England in the *Hecla*, on March 27, 1827; but it was the 22d of June before the exploring party quitted the ship, which was left on the north shore of Spitzbergen, in charge of a small crew, and betook themselves to the boats; and in spite of the advanced season of the year, they in the first two days advanced to  $81^{\circ} 13'$ . Here they began to encounter many difficulties; the ice-fields were small, and near each other, necessitating a constant conversion of the vehicle from a sledge to a boat, which could not be effected without unloading it, an operation

which consumed much time. This hardship, however, was endurable; but, to Parry's intense chagrin, he discovered, about the 22d of July, that the ice over which they were travelling was moving southward as rapidly as they were advancing north, so that on the 24th, after having travelled apparently 22 miles in the three previous days, they found themselves in the same latitude as on the 21st. Under these circumstances, Parry resolved to return, which he accordingly did, reaching his ship on the 21st of August. The highest point reached by him was  $82^{\circ} 40'$ . This was the first and last attempt to reach the pole over the ice; and though it can in no way be considered as finally settling the question of the possibility of reaching the pole in this way, it has shewn that the only way to success is that which was followed by the north-west passage explorers, who suffered themselves to be frozen in during winter, in order that they might have so much more time in the following summer for further advance, and continued this system for two or three successive years. The failure of Parry's expedition has also suggested further improvements in the arrangements for food, clothing, and transport across the ice-fields, which will be found serviceable in case of a second attempt. In 1854, two American explorers passed through Smith's Sound, and reached Cape Constitution in  $82^{\circ} 27' N.$  lat. and saw north of this point a boundless open polar sea, teeming with animal life, which has not yet been explored.

*Antarctic Expeditions.*—The attempts to penetrate to the south pole are of very recent date, mainly because a knowledge of the southern polar regions is only valuable to Europeans from a scientific point of view. Cook and Furneaux are the first navigators who are known to have crossed the Antarctic Circle, but the former penetrated only to lat.  $71^{\circ} 10' S.$ , and neither made any discoveries of importance. Bellinghausen, a Russian navigator, reached lat.  $70^{\circ} S.$  in 1819, and two years after, discovered Alexander's Land and Peter's Land, then the most southerly islands known. In 1823, Captain Weddell reached lat.  $74^{\circ} 15' S.$ , long.  $34^{\circ} 16' W.$ , and saw beyond him an open sea to the south, but made no important additions to our geographical knowledge. In 1831, Captain John Biscoe discovered Enderby Land; and in 1839, the sealing-schooner, *Eliza Scott*, from New Zealand, discovered Sabrina Land (q. v.); and in the same year, the United States' expedition, under Captain Wilkes, set out on a career of exploration, which resulted in the discovery (January 1840) of what he with reason supposed to be a continuous coast-line, though an ice-line of from 8 to 12 miles in width prevented him from establishing its continuity beyond dispute. The (supposed continental) coast stretched from Ringold's Knoll on the east, to Enderby Land on the west, and was distinguished by the absence of currents to disturb the ice-barrier, and by a much less precipitous character than belongs to islands. In 1840, a French expedition, under D'Urville, discovered a line of coast lying directly south from Victoria (Australia) on the Antarctic Circle. But the most important discoveries of all were achieved by Captain (afterwards Sir James) Clarke Ross, who made three several voyages in 1841—1843, discovering Victoria Land (q. v.), and tracing its coast from lat.  $71^{\circ}$  to lat.  $78^{\circ} 10'$  (the highest southern latitude ever attained). In his third voyage, Ross proved that the lands discovered by D'Urville were islands of inconsiderable magnitude; and his antarctic expedition has besides supplied much important information to the students of natural history, geology, and above all of Magnetism (q. v.). Ross's geographical

## POLARISATION OF LIGHT.

discoveries have since been confirmed; but a large extent of surface within the Antarctic Circle still remains unexplored.

**POLARISATION OF LIGHT.** A ray of light from the sun or a lamp, which has not been reflected or refracted in its course to the eye, possesses no properties by which one *side* of it can be distinguished from another; if, for instance, it be divided into two by a colourless doubly-refracting crystal, such as Iceland spar, these two rays will be of apparently equal intensity in whatever position the crystal be placed (**REFRACTION, DOUBLE**). But if the ray has been reflected from a surface of glass or water, it is found that in general the intensities of the two rays into which it is divided by the doubly-refracting crystal are not only unequal, but dependent upon the position of the crystal with reference to the plane in which the light was previously refracted or reflected. This is a conclusive proof that the light has undergone some change by reflection or refraction, so that it is no longer the same all round, but possesses *sides* (in the language of Newton), or (in modern phraseology) is *polarised*. Perhaps the most complete illustration of this very important fact is to be found by using two doubly-refracting bodies—two small crystals of Iceland spar, for instance—and pasting on a side of one of them a slip of paper with a pin-hole in it. On looking through this crystal, the covered side being turned towards a bright body, we see two images of the pin-hole, *equally* bright. Look at these through the second crystal, each is in general doubled; we see four images of the pin-hole, but these are generally *unequal* in brightness; and by turning either of the crystals round the line of sight as an axis, we find that there are positions, at right angles to each other, in which only *two* images are visible. If we turn further, the lost images appear faint at first, and gradually becoming brighter, while the others become fainter in proportion; till, when we have completed a quarter of a revolution, the new images alone remain, the others having disappeared. From this it follows that each of the rays into which a single beam of light is decomposed by double refraction possesses *sides*, or is polarised; and to such an extent as to be incapable of being again doubly refracted in certain positions of the second crystal. By taking advantage of the difference of the refractive indices (**REFRACTION**) of the two rays produced by Iceland spar, and the close agreement of one of them with that of Canada balsam, Nicol constructed his 'prism,' which is one of the most useful pieces of polarising apparatus. It consists of two pieces of Iceland spar cemented with Canada balsam, and allows only one of the two rays produced by double refraction to pass through. When we look at a flame through two Nicol's prisms in succession, we find that the amount of light transmitted depends on their relative position. If they are *similarly* placed, we have the maximum amount—viz., half the incident light; if they are *crossed*, that is, if one be made to rotate through a right angle from the position last mentioned, *no* light, not even the most powerful sunlight, can pass through the transparent combination. There are certain doubly-refracting bodies, such as tourmaline, iod sulphate of quinine, &c., which by absorption stifle one of the two rays into which they divide a beam of light; and which act therefore precisely as Nicol's prism does. But they have the great disadvantage of *colouring* the transmitted light very strongly; and this renders them unfit for the study of the gorgeous phenomena of colour (perhaps the grandest displays in optics) which are produced by polarised light. But for the verification of the facts to which we now proceed, a tourmaline or a

Nicol's prism will do equally well, and will be called the analyser. And first as to the reflection of light, a cause of polarisation first detected by Malus. If we examine by the analyser light reflected from water, unsilvered glass, polished or varnished wood, jet, &c., we find that it is more or less completely polarised; but that there is a particular angle for each substance, at which if light be reflected (see **REFLECTION**) from its surface it is completely polarised; that is, can be completely stopped by the analyser in certain positions, just as a ray which has passed through a Nicol's prism. It was discovered by Brewster that this angle, called the *polarising angle*, has its tangent equal to the index of refraction of the reflecting body: or, in another form, the reflected light from a surface of glass, water, &c., is completely polarised when its direction is perpendicular to that of the corresponding refracted ray. The light reflected from the second surface of a glass plate is also completely polarised at the same angle; and one of the most useful polarisers which can be made is a pile of thin glass plates, from the surfaces of which light is reflected at the proper angle, which is for ordinary window-glass about  $54^\circ$ . The light which passes through the glass plates is partially polarised, and its polarisation is more nearly complete the greater the number of plates employed. And it appears that these rays are polarised in planes perpendicular to each other—i. e., that the analyser which extinguishes the reflected ray has to be turned through  $90^\circ$  to extinguish the refracted ray.

In order that we may arrive at some ideas as to the nature of polarisation, we must consider on the basis of the Undulatory Theory of Light (q. v.) *how* a ray of light can have sides. If we take, for a comparison, waves of sound, as we know that in them (**SOUND**) the particles of air move back and forward in the line in which the sound travels, we see that a beam of sound cannot possibly have sides, since the motions of the particles of air in it are precisely the same from whatever side we consider them. Next take waves in water, where we see the water rising and falling as the undulation (*not* the water) travels uniformly onward in a horizontal direction; and this at once gives the required analogy. So far as phenomena of Interference (q. v.; see also **DIFFRACTION**) are concerned, waves, whether in air or in water, present them, so that they merely shew us that light depends on undulations, but not the kind of undulation. But when, from the facts of polarisation, we find that a ray of light can have sides, we see that the vibrations of the luminiferous medium must be *transverse to the direction of the ray*. Common light, then, consists of vibrations which take place indifferently and in succession in all directions transverse to that of the ray; while light which is completely polarised has its vibrations limited to a *particular* transverse direction. A Nicol's prism allows no light to pass through it except that which vibrates in a particular transverse direction, depending upon the position of the axes of the pieces of Iceland spar of which it is made. Light which has passed through one Nicol's prism is sifted so as to contain none but such transverse vibrations, and will of course pass freely through a second prism, or be completely or partially stopped by it; according as the two prisms are similarly situated, or turned so that the directions of the vibrations they can transmit are inclined at right angles, or at any other angle.

It is not yet settled what the direction of these vibrations is in any particular case; whether they take place *in*, or *perpendicular to*, the plane of polarisation; and the point is extremely important in the theory of the subject, though not to the

## POLARISATION OF LIGHT.

explanation of the ordinary experimental results. To explain the nature of this difficulty, we merely mention the simple case of polarisation by reflection at a glass plate. Do the vibrations of the reflected ray take place *perpendicular* to the plane of reflection (i. e., parallel to the reflecting surface), or do they take place *in* the plane of reflection? Some high authorities are in favour of the latter hypothesis, but the general opinion of scientific men at present unquestionably leans to the former. Many delicate experiments have been made to decide the question, but their results have been irreconcilable with each other. From the results which we have just arrived at, it is evident that the oscillations, or vibrations of the luminiferous medium, of which light consists, are similar to those of the bob of a Pendulum (q. v.), the ray in this case being supposed to proceed vertically downwards. Polarised light consists of vibrations analogous to those of the ordinary pendulum, backward and forward in a line. But we have seen that any motion of the pendulum may be compounded of two such motions in planes perpendicular to each other. This is analogous to the decomposition of common light by a doubly-refracting crystal into two rays polarised at right angles. But we find in nature, and can produce artificially, motions of the luminiferous medium resembling exactly the elliptic, and circular, motions of the (conical) pendulum. They occur in nature in all cases of reflection from metallic surfaces, and also from the surfaces of highly refractive bodies, such as diamond, &c. The easiest artificial method

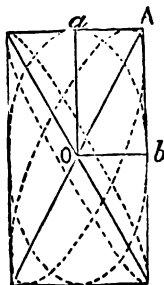

Fig. 1.

of procuring them is to allow polarised light to pass through a thin plate of a doubly-refracting crystal, such as a film of mica. Thus, if OA be the direction of vibration of the polarised light, the ray moving perpendicularly to the paper, Oa, Ob, the directions (at right angles to each other) of vibration of the two rays into which it is divided by the mica, we have only to let fall from A perpendiculars on Oa and Ob to determine the extent of the resolved vibrations in these directions. Now if the two rays moved equally rapidly through the mica, they would simply recombine on leaving it into a single plane polarised ray, whose vibrations would be represented by OA as before. But, in general, one of the rays is retarded more than the other, and the combination of two such oscillations is seen by geometrical considerations to give an ellipse whose centre is at O, and which touches each side of the rectangle of which Aa and Ab are half sides. The limiting forms of these ellipses are, of course, the diagonals of the rectangle; so that there are two cases for the light remaining plane polarised after passing through the mica, for an infinite number in which it will be elliptically polarised. Also the difference of retardation of the two rays may be such as to correspond to a description of these ellipses either right-handedly or the opposite. In particular cases the ellipse may be a circle; then it is obvious that the rectangle must become a square, that the directions of vibration of the two rays in the mica must be equally inclined to that of the original polarised ray, and that one ray must be retarded an odd number of quarter oscillations more than the other. If it be 1, 5, 9, &c., quarter oscillations, the rotation is in one direction; if 3, 7, 11, &c., it is in the opposite. Circularly polarised light cannot be distinguished by the eye, even with the

help of a Nicol's prism, from common light; but by the interposition of a thin plate of a doubly-refracting crystal, phenomena are produced which common light cannot give. Before we leave this part of the subject, it may be remarked that the composition of two equal and opposite circular vibrations produces a plane vibration, whose plane depends upon the simultaneous positions of the revolving bodies in their circular orbits. Hence a plane polarised ray may always be considered as made up of two circularly polarised rays, and if these pass through a medium which retards one more than the other, the plane of polarisation of their resultant, when they leave the medium, will in general not be the same as that of the incident ray. In other words, the plane of polarisation will have been caused to rotate through a certain angle, which will be proportional to the difference of retardation of its circular components. This is the explanation of what Biot called *Rotatory Polarisation* in quartz, turpentine, sugar, &c., and of the rotation of the plane of polarisation discovered by Faraday when a polarised ray passes through a transparent body under the action of a magnet.

In the first of these cases, the retardation is due to molecular heterogeneity; in the second, it depends upon molecular motions produced by the magnet. The effect is greater in each case the more refrangible the rays; and therefore, when the light which has passed through the medium is examined with an analyser, the successive colours of the spectrum are cut off each at a different angle, and the observed tint is that compounded of those which remain. The Saccharimeter (q. v.), for the determination of sugar in a liquid, is an application of the first case; the second has not as yet been applied to any practical purpose, but it has given most valuable information as to the ultimate nature of magnetism.

When polarised light passes through a slice of any uniaxial double-refracting crystal, nearly in the direction of its axis, it is obvious that the difference of retardation of the two rays into which it is divided will depend only upon (1) their refrangibility and (2) their inclination to the axis of the crystal. Hence, if we suppose the light to be homogeneous, the effects of interference, and subsequent application of the analyser, must be to produce appearances of bright and dark spaces, symmetrically disposed round the axis; that is, a series of concentric circular rings. The superposition of the separate sets of rings, for each colour of the spectrum, produces the appearance actually observed; a series of coloured rings, like those known as Newton's Rings, due to Interference (q. v.). Besides these, however, there is a dark or bright cross, consisting of two

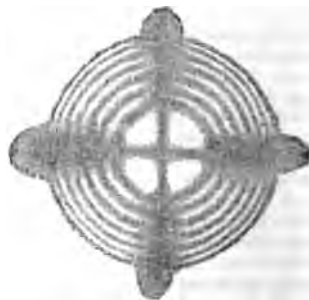

Fig. 2.—Uniaxial Crystal; Black Cross.

black or white bands, intersecting each other in the common centre of the rings. The dark bands are

due to the absolute stoppage by polariser or analyser, when placed in positions  $90^\circ$  from symmetry, of all light whose vibrations are executed in the principal planes of the polariser and analyser. A similar explanation applies to any other case. The system of coloured rings thus produced is one of the most splendid results of optical combinations yet produced; and may be seen by any one by the help of such simple apparatus as two fragments of window-glass and a piece of clear ice from the surface of a pond. In undisturbed freezing, the axis of the ice crystal is perpendicular to the surface of the water, and the cake of ice is therefore, as it were, cut for our purpose. If light be reflected at an angle of about  $54^\circ$  from the first piece of glass, pass perpendicularly



Fig. 3.—Uniaxial Crystal; White Cross.

through the ice, and be again reflected (at  $54^\circ$ ) from the second piece of glass, the phenomena above described, and rudely represented in the annexed cuts, will be at once seen, the appearances varying with the relative position of the planes in which the reflections take place from the pieces of glass. If these planes be at right angles to each other,

we have the black cross as in the first figure; if parallel, the white cross as in the second.

If, instead of a uniaxial crystal, a biaxial crystal, such as nitre or arragonite, be employed, the system of coloured rings and dark brushes is more complex; symmetry now requiring their arrangement about the two optic axes. The general appearance of the rings and brushes depends now, not only on the relative position of the polariser and analyser, but also on the position of the crystal (which is no longer symmetrical about an axis) with reference to these planes. The two following figures illustrate the nature of the change due to an alteration of the position of the crystal, the polariser and analyser being fixed in planes at right angles to each other.

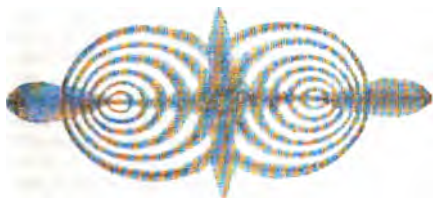

Fig. 4.—Biaxial Crystal; Black Cross.

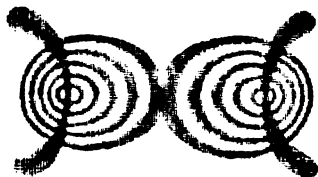

Fig. 5.—Biaxial Crystal; Black Cross changed to hyperbolas by rotating the crystal.

By employing circularly or elliptically polarised light, these appearances may be still further varied, but we cannot enter into details.

Every doubly-refracting body produces a change upon polarised light which passes through it. Hence the application of the polariser and analyser (usually glass mirrors, or Nicol's prisms) to the microscope is often of very great use in detecting crystalline, and other structural peculiarities. Solid bodies, such as glass, which are singly refractive, become doubly refractive when strained either by external forces or by unequal heating. A permanent state of strain is produced in glass when it is cooled quickly. All these phenomena are beautifully exhibited by polarised light. Again, the application of polarised light is sometimes of great importance in qualitative analysis, where only an exceedingly small quantity of a substance is procurable for examination, by enabling the chemist to determine whether a minute crystal is doubly refractive or not.

A practical application of a polarising prism may be mentioned. In salmon spearing it is often exceedingly difficult to see the fish at the bottom of the stream, on account of the glare of light reflected from the surface. But as this light is always partially, sometimes wholly polarised, a great part of it may be arrested by the analyser held in a proper azimuth; while the light escaping from the water will suffer little loss.

The light of the sky, being mainly reflected light, is of course partially polarised. The investigation of this subject has been most ably conducted by Brewster (*Trans. R.S.E.*, 1862—1863).

**POLARITY.** The north and south poles of the earth's axis are terms familiar to all; and so are the derived terms of the north and south poles of a Magnet (q. v.). A right-handed and a left-handed corkscrew, or helix, are also perfectly well known. The distinction between the members of any of these pairs leads us to the consideration of polarity, which it is difficult to define except by illustrations. In the case of the helix, it is the difference between right-handed and left-handed; not as in a magnet, the difference between the two ends. If we look closely into the question, we find that it is impossible to define the term 'right-handed rotation' in the abstract. We may define it as being the same as that of the hands of a watch, or that of the apparent motion of the celestial bodies about us in this northern hemisphere; but to a person at the equator, or to one who had never seen a watch, such comparisons would be without meaning. In fact, it is impossible to give a definition of even such a simple term as *right, down, east, &c.*, independent of reference to the motion or position of some external object. But there is, in many cases, an important scientific reality underlying, and perhaps causing these difficulties. To a spectator looking down upon the north pole of the earth, the axial rotation would appear to be left-handed, or opposite to that of the hands of a watch; while at the south pole the appearance is the reverse. In fact, as motion in a horizontal straight line appears to be from right to left, or from left to right, according to the side on which the spectator stands; so motion in a curve appears to be right-handed or left-handed, according to the side of its plane from which it is looked at. And this is now known to be the cause of the difference of poles in a magnet; the hypothesis of two magnetic fluids is dismissed, and Ampère's explanation, that in a magnet currents of electricity revolve round each particle in planes perpendicular to the direction of magnetisation, at once accounts for the dissimilarity of the poles. Such a figure as this gives a clear idea of the subject. A little electric current, such as that in the figure, in which positive electricity passes in the direction indicated by the arrow-head, acts upon external



bodies exactly as a small magnet would whose axis is, as in the cut, perpendicular to its plane, the arrow-head representing the north pole; that is, the pole which turns towards the South. Again, an electric current passing in a straight wire would at first sight appear to be altogether independent of polarity; yet it is found that such a current moving in

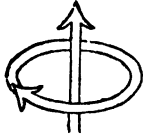

the straight line in the cut, in the direction of the arrow-head, tends to make the north pole of a magnet rotate round it in the direction indicated by the arrow-head in the circle. Again, there are certain crystals, which, when heated, become electric. One end of a prism of tourmaline, for instance, takes positive, the other negative electricity. Also certain crystals of quartz cause a ray of Polarised Light, which passes along their axis, to rotate right-handedly; others left-handedly. The difference in these cases is due to molecular arrangement, other effects of which are easily seen in the tourmaline, in the dissymmetry of the two terminals of the prism, and, in quartz, in the position of certain small faces of the crystal, so that a preliminary inspection enables us to predict the direction of the effect to be obtained from any particular specimen. The term has various other applications, amongst the least defensible of which is that to light. See POLARISATION.

PO'LDER, a word of frequent occurrence in the topography of the Netherlands, is the name given to a piece of land below the level of the sea or nearest river, which, being originally a morass or lake, has been drained and brought under cultivation. The usual mode of procedure is to form an embankment and canal of sufficient height to command a run towards the sea or a river, and when carried quite round, as in the case of the Haarlem Lake, the canal girdle is called the Ringvaart. At one or more points along the embankment, apparatus for lifting water, such as the screw of Archimedes, the inclined scoop or Eckhardt wheel, or pumps of large diameter, is placed, and worked by wind or steam-power. If the lake deepens towards the centre, it is necessary to have several embankments and canals, the one within the other. These are formed, at different levels, as the water-surface becomes lessened, connection being maintained on to the outer canal, which secures a run for the water which is drained off. In the Schermermeer polder, North Holland, there are four levels of canals, the land between them forming long parallelograms. The drainage water of the inner space is lifted into the first canal; that, again, with the drainage of the second section, is thrown into the second canal; and so on until the exterior one is reached, and a fall obtained. The polders in the Netherlands are so numerous, that we can only mention a few of the most important. The Beemster, one of the richest districts of North Holland, until 1612 a sheet of water, is crossed at right angles by long shady avenues, and dotted with comfortable farmhouses and fruitful orchards. In 1863 the pop. amounted to 3589, possessing 5835 head of horned cattle, 21,135 sheep, &c. The Zype, the Schermer, and the Purmer are also fine polders, but the most recent and striking instance is the drained Haarlem Lake (q. v.). The 50,000 acres of land thus obtained, supported, in 1863, a population of 7825, possessing 2336 horses, 7661 head of horned cattle, 13,807 sheep, &c.

POLE, CARDINAL REGINALD, born in Staffordshire in the year 1500, was the son of Sir Richard Pole, Lord Montacute, by Margaret, Countess of

Salisbury, daughter of the Duke of Clarence, the brother of Edward IV. His early education was received from the Carthusians at Sheen, whence, being liberally provided for by the king his relative, he passed to Magdalen College, Oxford, and having received deacon's orders, was advanced to several valuable preferments, through the favour of the king, Henry VIII. For the further prosecution of his studies, he went to the university of Paris, and thence to Padua, where he formed the friendship of a distinguished group of scholars and friends, all of whom subsequently took a leading part in public affairs—Contareni, Bembo, Sadoleto, and others. In 1525, he returned to England, where the highest ecclesiastical dignities awaited his acceptance. But it was about this time that Henry had resolved upon the divorce from his queen Catharine, and P. not only withheld his assistance in carrying out the project, but provoked the undying resentment of the king by his well-known treatise, *De Unitate Ecclesiasticâ*. His preferments and pension were withdrawn, and preparations were made for his impeachment. This, and probably still more extreme measures, he evaded by withdrawing from England. The king's resentment fell instead upon his elder brother, and upon his aged mother, the Countess of Salisbury. During the rest of Henry's reign, P. remained in exile. The pope, for the maintenance of whose authority, in the case of the injured Catharine, P. was regarded as a martyr, treated him with distinguished favour, and elevated him to the cardinalate. He was employed in many affairs of the highest importance, being sent as legate, in 1537, to France and the Low Countries, from both which states Henry VIII. in vain demanded his extradition. He also took an active part in the discussions on the Interim; and when the Council of Trent was opened, he was appointed one of the three legate-presidents who acted in the name of the pope, Paul III. (q. v.). On this pontiff's death in 1549, P. was all but elected to succeed. For some time after Paul's death, he resided chiefly in a monastery near Verona, in comparative retirement, until the accession of Mary called him back to active life, as the main instrument of the reconciliation of England with the papacy. On November 24, 1554, P. solemnly entered London as legate and plenipotentiary of the Roman see, possessing in an equal degree the confidence of the queen. In the arduous charge thus intrusted to him, he acquitted himself with much prudence, and, considering the circumstances of the time, with singular moderation. In the religious or politico-religious severities which marked the later history of Mary's reign, it is all but certain that P. had no share. He was created Archbishop of Canterbury, and Chancellor of the universities of Oxford and Cambridge. On the difficult and critical question of the disposal of the church property confiscated in the former reign, P., who saw the necessity of moderation, was for a time at issue with the pope; but his representations were successful in producing a more moderate policy, and the work of reunion appeared to proceed with every prospect of a complete permanent issue, when it was interrupted by the death of the queen in 1558. P. died within less than twenty-four hours afterwards. Besides the treatise *De Unitate*, already mentioned, he is also the author of a book *De Concilio*, and of other treatises on the authority of the Roman pontiff and the Reformation of England, and of very many most important letters, full of interest for the history of the time.

POLEAXE, a weapon consisting of an axe-head mounted on a long pole. There were many varieties of this arm, passing from a great hand-axe to a

axe-headed spear or halbert, several of the longer sorts bearing but little resemblance to an axe. In the navy, a poleaxe or boarding-hatchet is a hatchet with a handle about fifteen inches long, and a sharp point bending downwards at the back opposite the blade. It is used for boarding or resisting boarders.

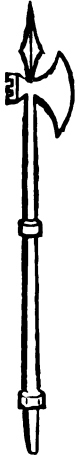

Poleaxe.

**POLECAT, or FITCHET** (*Mustela putorius*, or *Putorius fetidus*), a quadruped of the Weasel family (*Mustelida*), and commonly referred to the same genus with the weasel, stoat or ermine, &c. It is the largest British species of that genus, the length of the head and body being about a foot and a half, the length of the tail more than five inches, the form stouter than that of the weasel or of the ermine. Its colour is a deep blackish brown; the head, tail, and feet almost black, the under parts yellowish, the ears edged with white, and a whitish space round the muzzle. The hair is of two kinds—a short woolly fur, which is pale yellow, or somewhat tawny; and long shining hairs of a rich black or brownish-black colour, which are most numerous on the darkest parts. The nose is sharp, the ears short and round, the tail pretty equally covered with longish hair. There is a pouch or follicle under the tail, which exudes a yellowish, creamy substance of a very fetid odour; and this odour is particularly strong when the animal is irritated or alarmed. Hence, apparently, its name *Foumart* (*Foul Marten*), which, with various provincial



Polecat (*Mustela putorius*).

modifications, as *Fulimart*, *Thoumart*, &c., is prevalent in most parts of Britain. The origin of the names P. and Fitchet is much more uncertain.

The P. was much more common in Britain in former times than now, and is almost extirpated from some districts, through the constant war waged against it by gamekeepers and others. It eats everything that the gamekeeper wishes to preserve. It is extremely destructive in the poultry-yard, the abundance present there inviting it to drink blood and eat brains, which seem to be its favourite luxuries. The rabbit is followed by the P. into its burrow, and its ravages among poultry are partly compensated by its destruction of rats.—The taming of the P. does not seem to have been attempted. The smell prevents it.—The skin is imported from the north of Europe under the name of *Fitch*, and is used as a kind of fur, similar but inferior to that of the Marten (q. v.). It is imported to some extent from the north of Europe. To artists, the hair of the *fitch* or *fitchet* is well known as that of which their best brushes are made; the hairs used for this purpose being the long hairs already noticed,

which grow through the lighter-coloured fur of the animal.—The Ferret (q. v.) is supposed by some to be a mere variety of the polecat.—A dark-coloured kind of ferret is commonly regarded as a cross between the P. and the ferret, and is sometimes called the *Polecat-ferret*. The P. breeds in May or June, making its nest in an old rabbit burrow or similar hole, and producing four, five, or six young.—In North America, the Skunk (q. v.) is called polecat.

**POLEMONIA CÆÆ**, a natural order of exogenous plants, allied to *Convolvulaceæ*, and containing more than 100 known species, natives of temperate countries, and particularly abundant in the north-western parts of America. They are mostly herbaceous plants, with alternate and often pinnated leaves; regular hermaphrodite flowers; 5-cleft calyx; 5-lobed corolla; 5 stamens, springing from the tube of the corolla; the ovary free, surrounded with a fleshy disc; the style surmounted by a 3-cleft stigma; the fruit a capsule with 3 cells, and 3 valves; the seeds often enveloped in mucus, which contains spiral threads. Some of the species are favourite garden flowers, as *Polemonium ceruleum*, *Cobæa scandens*, and species of *Phlox*, *Iponopsis*, *Gilia*, &c. None are of value otherwise. *Polemonium ceruleum*, the only British species, and a rare plant in Britain, is well known in gardens by the curious name of *Jacob's Ladder*. It is also called *Greek Valerian*. It is not supposed to be really the *Polemonium* of the ancients, to which great medicinal virtues were ascribed by them. It has a stem from one to two feet high, pinnate leaves, and a panicle of blue (or white) flowers.

**POLENTA**, a preparation of Semolina (q. v.) or of Indian corn or maize meal, which is used as food by all classes in Italy. By the poorer classes, maize is universally used. The material is mixed with milk or water, and boiled until it is just thick enough to pour out into a dish, in which it becomes as firm as a thick jelly. Cheese is grated over it, and other condiments are added according to taste, and it is cut out in slices, and either eaten at once, or sometimes the slices are lightly fried in oil or butter. Semolina being much more expensive, is only used by the wealthier people, and many ingredients are added to suit their tastes.

**POLE-STAR, or POLARIS**, the nearest conspicuous star to the north pole of the celestial equator. The star which at the present time goes under the name of the 'pole-star' is the star  $\alpha$  in the constellation of Ursa Minor. By examining attentively the general movement of the stars throughout a clear winter's night, we observe that they describe circles which are largest at the equator, and become smaller and smaller as we approach a certain point (the north pole of the celestial equator), close to which is the star above mentioned. This 'pole-star' is, however, a little less than  $1\frac{1}{4}^{\circ}$  from the pole, and has a small but sensible motion round it. See **POLES**. Owing to the motion of the pole of the celestial equator round that of the ecliptic (see **PRECESSION OF THE EQUINOXES**), this star will in course of time (about 2100 A. D.) approach to within 28' from the north pole, and will then recede from it. At the time of Hipparchus (156 B. C.), it was  $12^{\circ}$ ; and in 1785,  $2^{\circ} 2'$  from the north pole. Its place can easily be found in the heavens, for a line drawn between the stars  $\alpha$  and  $\beta$  (called the two *pointers*, from this peculiarity) of the constellation Ursa Major, or the Great Bear, and produced northwards for about  $4\frac{1}{2}$  times its own length, will almost touch the pole-star. Two thousand years ago, the star  $\beta$  of Ursa Major was the pole-star; and about 2300 years before the

Christian era, the star  $\alpha$  in the constellation of the Dragon was not more than 10' from the north pole; while 12,000 years after the present time, the bright star Vega in Lyra will be within 5° of it.

The south pole of the celestial equator is not similarly marked by the near neighbourhood of a bright star, the only star deserving the name of the south pole-star being of the sixth or least visible magnitude.

**POLES** (Gr. *polos*, a turning-point), in *Geography*, are the two extremities of the axis round which the earth revolves; they are therefore situated the one on the north, and the other on the south side of the equator, and equidistant from all parts of it, or in lat. 90° N. and lat. 90° S. They are called the north and south poles of the earth.—In *Astronomy*, the poles, which, for distinction's sake, are frequently denominated 'celestial poles,' are those points in the heavens to which the earth's axis is directed, and round which the heavens seem to revolve. The celestial poles are valuable points of reference to astronomers and geographers, so that the determination of their position in the heavens is a matter of the utmost importance. Unfortunately, no stars mark their exact situation (see **POLE-STAR**)—though there is a minute telescopic star only a few seconds from the north pole, which may be employed instead of it in rough observations—and therefore it is necessary to adopt some means for discovering its precise position. This is effected in the following manner: A bright star (generally the pole-star) is selected, and its position in its upper and its lower *Culminations* (q. v.) is accurately noted; the point midway between these two positions of the star is the pole of the heavens. The observation of the star's two positions must be corrected for refraction, and it is for this reason that the pole-star is selected, since the effect of refraction is much the same in both positions of the star. The term 'poles' has, however, a wider application, as denoting the extremities of a line passing through the centre of a great circle perpendicular to its plane; thus, we have the poles of the horizon (viz, the zenith and nadir), the poles of the ecliptic, the poles of a meridian; and in the same sense, the terrestrial and celestial poles are spoken of as the poles of the equator and equinoctial respectively.—Pole, in *Geometry*, is used in a very indefinite sense; and in *Physics*, it denotes those points of a body at which its attractive or repulsive energy is concentrated. See **POLARITY**.

**POLIA'NTHESES.** See **TUBEROSE**.

**POLICE** (Lat. *politia*, Gr. *politica*, civil government; from *polis*, a city), are constables or peace-officers appointed in all parts of town and country for the purpose of watching property and detecting crime, and arresting offenders and maintaining public order. Though the word policeman is now, especially in towns, a household word, the legal denomination is that of constable; but he is a paid constable, to distinguish him from unpaid constables and special constables. In each parish in England, the justices of the peace have power to appoint constables to act gratuitously and compulsorily; but the vestry has power to resolve that one or more paid constables shall be appointed, in which case the justices are to make the appointment, and these paid constables supersede the unpaid constables. The salary of these parish constables is paid out of the poor-rates of the parish by the overseers. The justices also appoint a superintendent constable for each petty sessional division, to settle the fees and allowances which are to be paid to the constables for the service of summonses, and for the execution of

warrants incidental to the office of justices of the peace. In all boroughs in England, the corporation is empowered, by the Municipal Corporation Acts, to appoint a watch committee, who appoint a sufficient number of men to act as constables. The treasurer of the borough pays their salaries, wages, and allowances, as well as extraordinary expenses incurred by them. By a recent act applicable to counties, the justices are empowered to establish a sufficient police force for each county, and a chief constable is appointed to govern the whole.

The duties of constables or police-officers are exceedingly multifarious, and they receive printed regulations to guide them in the proper discharge of such duties. They have important duties in reference to the apprehension of offenders, and their powers are necessarily larger than those of private individuals. Wherever a person is seen in the act of committing a felony, it is the duty of every one, not merely of constables, to apprehend him or her without any warrant, for no warrant is needed. Persons found offending in many misdemeanours may also be apprehended by anybody without a warrant; but in other cases, a constable only can make an arrest. In case of a riot, anybody may arrest the rioter. Constables are bound to arrest hawkers trading without a licence; and vagrants who are offending against the Vagrant Acts, such as telling fortunes, loitering about premises, &c. The powers of constables are much greater than those of individuals with reference to crimes after they are committed. Thus, where the constable has not seen the offence committed, but is merely told of the fact, and he has reason to believe it, he is entitled to arrest the party charged without any warrant; he must, however, in such cases act only on reasonable suspicion. He is not justified, for example, in apprehending a person as a receiver of stolen goods on the mere assertion of the principal felon; nor is a constable justified in taking a person into custody for a mere assault without a warrant, unless he himself was present at the time the assault was committed, or reasonably apprehends a renewal of it. If a constable have a reasonable suspicion that a man has committed a felony, he may apprehend him; and so a private individual may do so. The difference between the authority of the constable and the private person in this respect is, that the latter is justified only in case it turn out that a felony was in fact committed; but the constable may justify the arrest and detention whether a felony was committed or not. It is the duty of a constable to raise a hue and cry in search of a felon, and all private individuals are bound to join in it, otherwise they may be indicted and fined. An arrest by a constable is usually made by laying hands on the party, and detaining him; but it is enough for the constable to touch him and say: 'I arrest you, in the Queen's name.' If the party arrested be in a house in hiding, the constable may demand admittance, and if he is refused, may then break open the doors; this is so in all cases where the party has committed treason or felony, or has dangerously wounded another. In cases where the constable is not authorised at common law or by some statute to arrest a party without a warrant, then he must produce a warrant signed by a justice of the peace, and shew it to the party if it is demanded; and if the constable happens not to have the warrant in his pocket at the time, even though it is not asked for, it is an illegal arrest. When a party is arrested, it is the duty of the constable to take him without any unreasonable delay before a justice of the peace, and meanwhile lodge him in safe custody. The party arrested must not be treated with harshness beyond what

is necessary for safe custody, and therefore it has been held that a constable has no right to handcuff a person whom he has apprehended on suspicion of felony, unless such person has attempted to escape, or it be necessary to prevent an escape. Nor has a constable in general a right to search a person apprehended, unless the latter conduct himself violently.

The conduct of constables in reference to public-houses is of some importance. It is an offence in publicans and beer-house keepers, and indeed the keepers of all places of public resort, to refuse to admit the constable into such house or place at any time. Thus, in the case of these places being open on Sundays at the times prohibited by statute, the constable, if he suspect that the act is being violated, may demand admittance, and thus satisfy himself as to the fact. It is owing also to this power of a constable to enter at all times, that he is enabled to detect other offences in public-houses, such as harbouring prostitutes and disorderly characters. Constables, when suspecting that a betting-house is kept, must first get a warrant from a justice of the peace, which can be obtained without notice to the parties, and can then break into the house. So as to gaming-houses. While constables have summary power of entering public-houses, still this is not to be abused; and it is a distinct offence in the keepers of all public places where wine, spirits, beer, cider, or any fermented or distilled liquors are sold on the premises, to knowingly harbour, or entertain, or suffer to remain there such constables during the time they are on duty, except when quelling disturbances or restoring order. It is an offence punishable with more than usual severity to assault constables when in the execution of their duty. Though constables are paid in great part by each county and borough, and thus by the public at large, it is often requisite for individuals to require the services of extra constables, in which case such individuals must pay for them at their own expense, as is usual in theatres and large establishments. Of late years, considerable complaint had been made as to constables interfering in the protection of game-preserved and fisheries, it being considered that the owners of those properties ought to bear the extra charge, if required, of the constables' giving more than the ordinary attention to poachers. But by the recent Act, extended powers of detecting poachers of game were given to constables, who are now entitled, whenever they suspect people on the highway of being engaged in poaching, to stop and search them, and then summon the poachers, if necessary, before justices. See POACHING.

In 1862 (the latest published returns), the total police and constabulary in England and Wales amounted to 22,161 men, of whom 177 were detectives. These are subdivided into constables of boroughs, 6286; county constables, 7969; metropolitan police, 6566; dockyard police, 712; city of London police, 628. The proportion to the population is about 1 to 905; in counties, the proportion is 1 to 1489; in the metropolis, 1 to 472. In 1862, the total police expenses amounted to £1,596,993. Each man costs on an average £53, and his clothing and accoutrements £5 more. The following are the round numbers relating to the cost of each division of police: The borough police cost £400,000; the county police, £610,977; the metropolitan police, £489,590; the dockyard police, £45,325; the city of London police, £50,296. Of these, the public revenue pays nothing towards the city of London police; it pays all the cost of the dockyard police; it pays nearly one-fifth of the other branches of the police.

In Ireland, the first regular police force was

established in 1814, which was improved in 1836 and 1839. Originally, the expense was defrayed partly out of the Consolidated Fund; but in 1846, the whole expense was borne by the Consolidated Fund, with trifling exceptions. In 1862, the total cost of the constabulary amounted to £765,428, but this included the expenses of 72 stipendiary magistrates, whose salaries vary from £300 to £500: the only part of the total cost borne by the counties, cities, and towns of Ireland was £15,697, being about one-fiftieth. The number of constables was 12,332. The above number does not include the Dublin metropolitan police, of which the number of men is 1081, the cost £87,000, and of which £50,000 is paid by a parliamentary grant.

In Scotland, the police force for the counties amounted during the same time to 909, and in the burghs to 1643; total, 2557.

**POLICE, MILITARY**, has two significations—1st, the organised body employed within an army to preserve civil order, as distinct from military discipline; and 2d, a civil police with a military organisation. The police of an army commonly consists of steady intelligent soldiers, who act under the orders of the provost-marshal, and arrest all persons out of bounds, civilians not authorised to pass the lines, disorderly soldiers, &c.; they also attend to sanitary arrangements. As in all military matters, the police of an army possess summary powers, and a sentence of the provost-marshal is carried out immediately after it is pronounced.

Of civil police with military organisation may be instanced, as specimens, the Gendarmerie (q. v.) of France, the Sbirri of Italy, and, in an eminent degree, the Irish constabulary.

**POLICY** (a corruption of the Lat. *polytycha*, [analogous to *diptycha*, i. e., two-fold, or a pair of tablets] applied in the middle ages to memoranda or registers written on a set of several tablets), as a legal term, denotes the contract of insurance (Ital. *polizza d'assicurazione*). The usual contracts are for the insurance of life, or rather against the risk of death, against fire, against loss of a ship; but the same name is given to a similar instrument adapted to meet any other risk. See INSURANCE.

**POLIGNAC**, an ancient French family, which takes its name from a castle said to have been built in the 5th c., on a rock of the Cevennes, near Puy-en-Velay, in the department of Haute-Loire, on the site of a Roman temple dedicated to Apollo, whence—according to certain rather credulous genealogists—the castle was originally called *Apollonique*, of which Polignac is affirmed to be only a later corruption. The first of the Polignacs who acquired celebrity was MELCHIOR DE P., younger son of ARMAND, 16th MARQUIS DE P., and born at Puy-en-Velay, 11th October 1661. Destined by his parents for an ecclesiastical career, he received an excellent education at Paris in the colleges of Clermont and Harcourt. In the negotiations of Cardinal de Bouillon with Pope Alexander VIII. at Rome in 1689, the young, but astute and insinuating abbé took a principal part. In 1695, he was sent to Poland as French ambassador, when John Sobieski was dying; and diplomatized and intrigued so cunningly in favour of Prince de Conti, that the latter was actually elected his successor. Events, however, frustrated this policy, and both Conti and P. had to leave Poland rather precipitately, in consequence of which the latter lost the royal favour. He now retired to his abbey at Bonport, where he spent the next four years, partly occupied in the composition of a Latin poem entitled *Anti-Lucretius*, which was intended as a refutation of the scepticism of Bayle. It appears to be a very respectable and

even able performance. In 1702—after a stroke of his usual neat flattery—he was recalled to Versailles, and rose higher into favour than ever. Named *Auditeur de Rote* in 1706, he was sent to Rome, where he devoted himself to the study of canon and civil law, was associated in the negotiations of Cardinal de la Trémoille, and honoured with the friendship of Pope Clement XI. In 1712, he was appointed French plenipotentiary at the Congress of Utrecht; and after his return, obtained the abbey of Corbie and Anchin. When Louis XIV. died, P. was at the top of his reputation and influence. During the regency of the Duke of Orleans, he took part in the conspiracy of Cellamare, and was banished to his abbey of Anchin. In 1720, he was sent to Rome, charged with the conduct of French affairs, and remained here for about ten years, and signalised his mission by healing the quarrel that was dividing the Gallican Church on the subject of the famous bull *Unigenitus*. In 1726, he was raised, in his absence, to the archbishopric of Auch; and on his return to France, spent the remainder of his days in literary repose, and in the high esteem of courtiers, scholars, and the like. He died 3d April 1742. P. succeeded Bossuet at the Académie Française in 1704, and became an honorary member of the *Académie des Sciences* (1715) and of the *Académie des Belles-lettres* (1717). See C. Faucher's *Histoire du Cardinal de Polignac* (2 vols., Paris, 1772), St Simon's *Memoires*, and D'Argenson's *Memoires*.

The other members of the Polignac family who have an historical name at all are more notorious than noteworthy. In the reign of Louis XVI., TOLANDE-MARTINE, GABRIELLE DE POLASTRON, DUCHESS DE P. (born 1749; died at Vienna, 9th December 1793), and her husband, JULES, DUC DE P. (died at St Petersburg, 1817), were among the worst, but unhappily most favoured advisers of Marie Antoinette. They obtained vast sums of the public money from their royal master and mistress, and were largely, if not mainly responsible for the frightful pecuniary extravagance of the court. The discovery of the famous *Libre Rouge* occasioned the exulting cry of Mirabeau: *Mille Écus à la Famille d'Assas pour avoir sauvé l'État; un Million à la Famille Polignac pour l'avoir perdu!* The Polignacs—knowing the deep hatred felt towards them by the French people—were the first of the *noblesse* to emigrate (16th July 1789). From the Empress Catharine of Russia, the duke received an estate in the Ukraine, and did not return to France at the Restoration. He left three sons and a daughter, of whom only one has become historical—AUGUSTE JULES ARMAND MARIE, PRINCE DE P. (born at Versailles, 14th May 1780). On the Restoration, he returned to France; became intimate with the Comte d'Artois, afterwards Charles X.; shewed an ardent attachment to the Church of Rome—or at least to its policy—and, in consequence, received from His Holiness, in 1820, the title of Prince; was appointed ambassador at the English court in 1823; and finally, in 1829, became head of the last Bourbon ministry, in which capacity he promulgated the fatal ordonnances that called France to arms, and drove Charles X. from the throne. He then attempted to flee from the country, but was captured at Granville on the 15th of August; was tried, and condemned to imprisonment for life in the castle of Ham, but was set at liberty by the amnesty of 29th November 1836. He took up his residence in England, but died at Paris, 2d March 1847.

#### POLISH LANGUAGE AND LITERATURE.

The Polish language is one of the most widely-

spread branches of the Slavic, forming (according to Dobrowsky), along with the Bohemian, the western branch. It surpasses almost all the other Slavonic tongues in euphony and flexibility, and is scarcely excelled by any language in point of brevity. It does not make use of the article, but has a most elaborate declensional system, comprising seven cases. The conjugation of the verb is equally elaborate, and enables a Pole to express transitions and delicate niceties in the conditions of time and gender quite unknown to the French, or German, or English verb. The Polish vocabulary is also uncommonly rich. The number of harsh consonants in the language, it must be admitted, is large, and this fact is a marked distinction between it and its eastern sister, the Russian, but in pronunciation, these are so much softened that its euphony is preserved. It alone of all the Slavic dialects, with exception of the old Slavic Church language, has nasal sounds *ç*, like the French *ou*; and *ç*, like the French *œ*. The letter *ł* has also a peculiarly broad snarling sound. After the introduction of Christianity, Latin, the language of the church, exercised a powerful influence on its structure and development, and subsequent to the 14th c., it adopted into its vocabulary numerous German words. In the 16th c., Polish, as a written language, rapidly attained so high a degree of perfection that it supplanted even Latin itself, until then the language of the state and of the learned. The best Polish grammars are those of Mrongovius (3d ed., Danz, 1837), Bandtke (Breslau, 1824), and Muczkowski (Crac. 1845); the most comprehensive dictionary is that of Linde, after which rank those of Bandtke (2 vols., Breslau, 1806), Mrongovius (Königsb. 1835) and Trojanski (4 vols., Posen, 1835—1846).

The history of Polish literature is divisible into five clearly marked periods. The *first* extends from a date antecedent to the introduction of Christianity down to the close of the 15th century. Of pre-Christian Polish literature, nothing has survived but some popular songs and proverbs. Among the very oldest literary monuments is a hymn to the Virgin Mary, ascribed to St Adalbert. The introduction of Christianity paved the way for a Latin literature more or less ecclesiastico-historical. Casimir III. (q. v.), surnamed the Great, did more than any other early Polish monarch for the encouragement of literature, and, among other things, founded the university of Cracow, which, from the beginning of the 15th c., long continued to be the centre of intellectual life and culture in Poland. To the 15th c. belong Jan Długosz (Lat. *Longinus*), author of a most interesting and valuable *Historia Poloniae*, in 13 books, and otherwise worthy of remembrance as an able diplomatist and philanthropist; also Jan Łaski, Archbishop of Gnesen (b. 1457, d. 1531), whose collection of the oldest Polish laws, *Commenge Inclyti Poloniae Regni Privilegium*, is of great historical importance. In 1490, the first printing-press in Poland was established at Cracow.

The *second* period of Polish literature embraces the 16th and first quarter of the 17th c., and is marked by the use of the Polish as a written language. The reigns of Sigismund I. and Sigismund II. Augustus, are regarded as the golden era of Polish literature, properly so called. The series of poets begins with Nikol. Rej (b. 1515, d. 1568), commonly called the *Father of Polish Poetry*, a native of Zoravno, in 'Little Russia,' and educated at Lemberg and Cracow. He spent his life at the court of the Sigismunds. His principal works, *Wizerunek Zynoota Czlowieka Poczciwego* (Crac. 1560) and *Apophthegmata* (Crac. 1568), are full of

sharp wit and strong satire, and though the language is rough and unpolished, it is genuinely poetical. After Rej, the brothers Jan and Piotr Kochanowski hold the highest rank. Szymonowicz or Simonides (d. 1629) acquired by his Latin odes the name of the 'Latin Pindar'; and his *Sielanki* ('Idylls,' new ed. Leip. 1837), modelled on those of Theocritus, exhibit a charming simplicity of style. Still more original, if scarcely so graceful, are the *Sielanki* (new ed., Leip. 1836) of his friend Zimorowicz (d. 1629). Sebastian Klonowicz, called *Acernus* (d. 1608), is celebrated as a satirist and descriptive poet. The Reformation, which rapidly made way in Poland, being tacitly approved of by the rulers and magnates, gave a powerful stimulus to the intellectual and spiritual activity of the nation—visible in translations of the Bible, hymn-books, and an important pulpit or sermon literature. Among the historians of this period, the most celebrated are the brothers Bielski; Lukasz Górnicki (d. 1591), author of a history of the Polish crown (*Dzieje w Koronie Polskiej*, Crac. 1637, Wars. 1804); Strzickowski (d. 1582), whose *Chronicle of Lithuania* (Königsb. 1582) is an admirable work; and Paprocki (d. 1614).

The third period of Polish literature, extending from 1620 to 1750, is coincident with the rule of the Jesuits, who first obtained a footing in Poland about 1566, through the influence of Cardinal Hosius, soon possessed themselves of the schools, and, on the whole, seriously checked the literary and religious growth of the nation. The most conspicuous poet of this retrogressive period is the Jesuit Kazimierz Sarbiewski (1595–1640), who wrote only in Latin; others more or less noteworthy are Kochowski (died about 1700); Twardowski (d. about 1660); Opalinski (d. 1655); Chrościnski, the translator of Lucan; Morsztyn, the translator of Corneille; and Elżbieta Druzbicka (d. 1760). Among the historians of this period, it may suffice to mention Starovolaki (d. 1656), author of *Polonia, sive Status Regni Poloniae Descriptio* (Wölfenbuttel, 1656), and other works; Kojalowitz, a Jesuit (d. 1677), and Kaspar Niesiecki, a Jesuit (d. 1745), whose *Korona Polska* (4 vols., Lemb. 1728–1743) is the most important work on Polish heraldry.

The fourth period, commencing with the middle of the 18th c., and extending into the first quarter of the 19th, owes its characteristics partly to the influence of the French literature of Louis XIV.'s time; partly also to the liberal patronage of literature and science by King Stanislas Augustus, the princes Czartoryski, Jablonowski, and other magnates, and the educational reforms of Stanislas Konarski (b. 1700, d. 1773). The good work begun by Konarski was carried on by Kopczynski (1735–1817), who was the first to thoroughly establish on a scientific basis the grammar of the Polish language in his *Grammatyka Norodowa*; by Piramowicz (d. 1801); by Bohomolec, the Jesuit, who translated a multitude of stage-pieces from the French; but above all, by Adam Stanislas Naruszewicz, the accomplished translator of Tacitus; and Ignacy Krasicki (1735–1801), called the 'Polish Voltaire,' the centre of the whole Polish literature of his age, whose satires and fables are reckoned the first in his native language. As poets of this Renaissance period, occur the names of Trembecki; Cajetan Wegierski, Godebski, and Wezik. The most noted dramatist is Boguslawski (d. 1829), who wrote about 80 plays—the majority of which, under the title of *Dziela Dramatyczne*, were published at Warsaw (9 vols., 1820).

The political storms that swept over Europe at the close of the 18th and the first years of the 19th c., did not quite destroy the new literary life that had burst into blossom under Stanislas Augustus.

In 1801, the historian Tadeusz Czacki, Franciszek Dmochowski, and Bishop Jan Albertrandy founded at Warsaw the 'Society of the Friends of Knowledge,' which, especially under the auspices of the state-councillor Staszyc, bore good fruit till it was dissolved in 1832, when its library of 50,000 vols. was carried off to St Petersburg. At the same time, Jozef Maximilian Ossolinski, Hugo Kolontaj, and Stanislas Potocki, by word and writing exercised a mighty influence on the renovation of the national spirit. The transition to this *newest* or *fifth* period was made by Karpinski (1745–1825), whose *Songs and Idylls* (4 vols., Warsaw, 1804; new ed., Leip. 1836) live on the lips of the Polish people; by Chancellor Voroniz (1757–1829), a richly imaginative poet, and a great orator; by Niemcewicz (1757–1841), a statesman, soldier, and author of celebrity in his own land; and by the poet Kasimierz Brodzinski (1791–1835). At Wilna, which, after 1815, became the centre of Polish literary activity, and a rallying-point for all the enthusiastic spirits of the land, several young men united, with Adam Mickiewicz (b. 1798) at their head, in a crusade against the still dominant French style of literature. We can only name some of his numerous and brilliant associates, as Malczewski (1792–1826), whose best production is his epic-lyric narrative of Ukraine life, entitled *Marya*; Goszczynski (b. 1806); Poema, 3d ed., Breslau, 1852); Bohdan Zaleski (b. 1802; *Poezye*, Pos. 1841, and later); Tomasz Padura (*Pienia*, Lemb. 1842); Odyniec (*Poezye*, Pos. 1833); Korsak (*Poezye*, Pos. 1833); Chodzko (*Poezye*, Petersb. 1829); Groza (*Poezye*, Wilna, 1836); Lucyan Siemienski (b. 1809), an excellent novelist and translator; Bielowski (b. 1806), a lyric poet and translator; Gorecki, renowned for his pungently sarcastic fables (*Bajki i Poezye nowe*, appeared at Paris in 1833); Garczynski (*Poezye*, Paris, 1833); and Slowacki, the most fertile of all the recent Polish poets. Most of these writers are either 'banished men,' or men who are, or, while living, were, forced to expatriate themselves. They belong to the 'Polish Emigration,' whose head-quarters is Paris. The most many-sided and prolific of all the modern Polish novelists, is Jozef Ignacy Kraszewski (b. 1812), who lives in Volhynia. The new national tendency of Polish literature, which naturally first shewed itself in poetry, soon became visible in other departments also. Thus, Joachim Lelewel (b. 1786) has risen to the first rank as a writer of Polish history, and a study of his works is absolutely indispensable to a knowledge of that subject; next to him (and later) in the same department stand Bandtke, Maciejowski, Count Raczynski, and Count Plater. Narbutt of Wilna wrote a very solid and comprehensive work on Lithuanian History (Wilna, 1837 *et seq.*), and Lukaszewicz of Poen has furnished numerous important contributions to the history of the Reformation in Poland. A multitude of works more or less weighty have been devoted to a record of the revolution of 1830, chiefly, of course, by Polish emigrants. In philosophy, theology, and physical sciences, Poland has nothing of consequence to shew.—The principal works on Polish literature are those of Muczkowski, Bentkowski, Ossolinski, Chodynski, and particularly the comprehensive *Historia Literatury Polskiej* (Crac. 1840, *et seq.*) of Wiszniewski.

**POLISHING MATERIALS.** See DIAMOND-GRINDING, EMERY, PASTES, and PUTTY POWDER.

**POLISHING OF METALS.** This is effected by first removing any tarnish or oxidation by means of some material which will chemically act upon it; for this purpose, sulphuric, hydrochloric, oxalic, and acetic acids are used to different metals, and in

various states of dilution. Usually, it is necessary to remove the acid with clean water, and dry rapidly, to prevent re-oxidation; and then either friction with various polishing materials, or rubbing with a smooth hard surface or burnisher, brings out the lustre of the metal.

**POLISHING OF STONE.** See **STONE**.

**POLISHING SLATE**, a mineral composed chiefly of silica, with a little alumina, lime, oxide of iron, and water; white, yellowish-white, or yellow; of a slaty texture, opaque, very brittle, and of specific gravity not much more than half that of water; so that it swims in water till its pores become filled with the liquid. It is found in Bohemia, Saxony, and Auvergne, and has been supposed to be a volcanic product, but it consists of silicious remains of *Diatomacea*. It is used for polishing glass, marble, and metals.

**POLITICAL ECONOMY.** The word economy is derived from the Greek for house-law or house-regulation. It refers to the material portion of domestic regulation, and does not, for instance, embrace the observance of religion or the communication of instruction. The most important part of it is the adjustment of the expenditure of the household to the income at their command. Hence the word economy is sometimes applied, both in a public and a private sense, to the saving of money. The term 'Political' came to be used along with it as a convenient method of expressing the application to a state of a sound system of management in relation to its affairs. In later times, however, the word, as applied to a community, came to be something totally different from its application to a household. It was thought that one could regulate a people just as a house is regulated, by adjusting the spending and the getting of the national wealth. Hence arose several doctrines now discarded—such, for instance, as 'the balance of trade,' which taught that the trade with any nation is only profitable when you sell more to that nation than you buy from it; the system of bounties upon special trades, as being more profitable to others; and lastly, the system of protection to native industry—the last relic of what may be called the positive school of economists. Political economy now means, not the art of regulating communities in this respect, but the science of those laws which Providence has established for their regulation. Hence the analogy with domestic economy ceases. Domestic economy is the positive regulation of a household—not the leaving of it to follow its own dictates; and, indeed, that there is a disposition, more or less in the head of every house, to limit its expenditure to its income, is one of the phenomena by which things right themselves, as it were, and make up those laws of nature which constitute political economy. A man knows that if he buys too much, he will become bankrupt; but we do not now order the wholesale merchant not to buy too much from this or that country, so as to place the balance of trade against us—we know that this naturally rights itself, because we must expect our own produce to pay for what we bring in. Even if we should have to pay for it in gold, that is a commodity produced by our people. The income and expenditure of the government, as apart from that of the people of the community, are of course under regulation like those of a household; but these form a separate field of operation, called Finance (q. v.). There are a few people who still hold that there is no natural system sufficient in itself to regulate the material affairs of mankind, and that these should be committed to the hands of special managers. Finding the approved doctrines of political economy going further and further from

their direction, such persons, though few in number, have been very absolute in their views, and zealous in pushing them. One class of these are called Socialists; and another, who go further lengths, are called Communists. It has not been considered necessary here to go beyond the mere description or definition of the nature of political economy, because the various parts of which it consists are given each under its own head, as BOUNTY, CAPITAL, COLONY, COMMUNISM, COMPETITION, CORN LAWS, DEMAND AND SUPPLY, EXCHANGE, FREE TRADE, LABOUR, MONOPOLY, NAVIGATION LAWS, RENT, VALUE, &c.

**POLITICAL OFFENCES**, crimes considered injurious to the safety of the state, or such crimes as involve a violation of the allegiance due by a subject to the supreme authority of the state.

By the Roman law, in the early times of the republic, every act injurious to the state was comprehended under the name *perduellio*, and visited with death. That term included conspiracy against the government, aiming at kingly power, aiding the enemies of Rome, and losing an army. The word *perduellio* afterwards fell into gradual disuse, and the chief state offences were known by the term *majestas* or *crimen læsæ majestatis*, somewhat akin to the treason of modern times. In the republican period, the crimes to which the epithet *læsæ majestatis* was most frequently applied, were the betrayal or surrender of an army to the enemy, the excitement of sedition, and such a course of administration as impaired the dignity of the state. In imperial times, acts and words disrespectful to the reigning emperor were included, and an indignity to his statue was visited nearly as severely as an offence against his person. *Læsæ majestatis* was generally punished with death, confiscation, and infamy. The criminal might even be tried after his death, to the effect of confiscating his property, and rendering his memory infamous—a practice which has been resorted to both in France and Scotland as late as the beginning of the 16th century.

In modern times, the acts brought under the category of political offences have varied much at different periods and in different countries. They have in general been more leniently dealt with under constitutional than under despotic governments. It is, however, a principle which has been generally recognised by the most constitutional of governments, that when the legislature thinks itself endangered by a secret conspiracy against the state, or an understanding with the enemies of the country, it permits the executive, for a limited time, to arrest suspected citizens, without the formalities which are required in ordinary circumstances.

In England, a large number of the graver political crimes are included under the denomination of Treason, and the treason law has sometimes been stretched so as to include offences which, by a fair construction, could hardly come within it, such as the use of violence to reform religion or the laws, or to remove the councillors of the sovereign. Even riotous assemblies with the object of destroying all property of a particular class have been held treason. Political offences also include a number of crimes against government falling short of treason, and passing under the name of Sedition, which, though they have for their ultimate object the violation of the public peace, do not aim at direct and open violence against the laws or the sovereign, but rather the dissemination of a turbulent spirit tending to produce such violence. The British government does not permit the political offenders of other countries to be included in extradition treaties; and in modern times, generally speaking, extradition does not apply to political offenders; contrary to the doctrine laid down by Grotius. In

some countries, conspiracy against the sovereign of any country in league with the state is a special offence; in Great Britain, however, this seems not to be the case. A bill introduced in 1858 to make it felony to conspire to commit a murder without as well as within her Majesty's dominions, was rejected by the House of Commons on the second reading, from the idea that it was dictated by France.

**POLITICS** (Gr. *polis*, city or state), that branch of ethics which has for its subject the proper mode of governing a state, so as to secure its prosperity, peace, and safety, and to attain, as perfectly as possible, the ends of civil society. Among the subjects which political science embraces are the principles on which government is founded, the hands in which the supreme power may be most advantageously placed, the duties and obligation of the governing and governed portions of society, the development and increase of the resources of the state, the protection of the rights and liberties of the citizens, the preservation of their morals, and the defence of the independence of the state against foreign control or conquest. While the philosophy of governing constitutes the *science* of politics, the *art* of politics consists in the application of that science to the individual circumstances of particular states. The ancient Greek writers treated politics with reference to an ideal perfect state, which each propounded according to his own speculative views, pointing out the variation of every existing government from his standard. The politics of a country, in common parlance, implies the course of its government, more especially in its relations with foreign powers.

**POLIZIANO, ANGELO**, whose name is perhaps better known under the Latin form of **POLITIANUS**, was the son of a doctor of civil law, and was born at Montepulciano in Tuscany, 14th July 1454. The family name was Ambroginis, but P. took his from his native town—in Latin, *Mons Politianus*. He studied Latin at Florence under Cristoforo Landia, Greek under Andronicus of Thessalonica, the Platonic philosophy under Marsilio Ficino, and the Aristotelian under Argyropoulos. He also devoted some attention to Hebrew. P.'s talent for poetry was early developed. When scarcely fifteen years of age, he took the Florentines with surprise by the publication of his famous *Stanze* (a poem of 1400 lines) in honour of Giulio de Medici, who had carried off the palm at a tournament. Lorenzo de Medici took notice of the brilliant lad, and at once placed him in a condition to continue his studies without any pecuniary harassments, by appointing him tutor to his two sons, and subsequently gave him a residence in his charming villa near Fiesole, where P., who was passionately fond of country life, resumed his studies with fresh ardour. In 1484, he accompanied the Florentine ambassadors to Rome, and was received in a flattering manner by the pope, at whose request he translated (into Latin) the Greek historian Herodianus, for which he received 200 golden crowns. He also made Latin versions of the *Enchiridion* of Epictetus, the *Charmides* of Plato, and other works, with such elegance, that Erasmus pronounced him a master in translation. After having filled for some years a chair of Latin literature, he commenced the teaching of Greek. His popularity as a professor was great. Pupils came to study under him from all the great cities of Italy, and even from distant parts of Europe; the principal were Francesco Pucci, Fortiguerra, Maffei de Volaterra, P. Crinitus, Guillaume Grocyen, Thomas Linacre, and Michael Angelo. His copies of Ovid, Statius, Pliny the

Younger, Quintilian, &c., and other authors, are still preserved in the different libraries of Italy, and are covered with marginal notes. His copy of the famous *Digest* of Roman law, with an elaborate philological and grammatical commentary, is still preserved in the Laurentian Library at Florence. In 1489 appeared his *Miscellanea*, a collection of critical and other observations on the ancient authors. Towards the close of his life, he entered into orders, and was made canon of the cathedral of Florence. He died 24th September 1494. Among the brilliant scholars of the classical Renaissance, P. occupies a foremost place in virtue of his vigour and originality. His intellect was indeed penetrated by an admiration of the chaste and noble literature of antiquity; but there was nothing servile in his imitations; he reproduced without difficulty—because he was himself a kindred genius—the strength of Tacitus, the elegance of Livy, and the conciseness of Sallust; his Latin poems, especially his elegies, display the beauty and ardour of his imagination. Among his vernacular pieces may be mentioned his *Canti Carnascialeschi* (Carnival or Merry Ballads), remarkable for their felicity of style, sweetness of pathos, and abundance of imagery. Another proof of his varied poetical power was his *Orfeo*, one of the earliest dramatic compositions produced in Italy. The editions of P.'s separate writings have been numberless. See Serazzi's *Vita di A. Politiano*; N. A. Bonafous *De A. Politiani Vita et Operibus* (Paris, 1845); Tiraboschi's *Storia della Letterat. Italiana*; Greswell's *Memoirs of Politiano*, and Roscoe's *Lives of Lorenzo de Medici and of Leo X.*

**POLK, JAMES KNOX**, eleventh President of the U.S. of America, was born in Mecklenburg County, North Carolina, November 2, 1795. His ancestors, who bore the name of Pollock, emigrated from the north of Ireland early in the 18th century. Though his father was a farmer in moderate circumstances, he was educated in the university of North Carolina, and studied law with Felix Grundy of Tennessee, an eminent lawyer and statesman. Admitted to the bar in 1820, he was three years after elected a member of the legislature of Tennessee, and soon after, to the Federal Congress, by the Democratic party. In 1836, he was chosen Speaker of the House of Representatives, a position he filled during five sessions with firmness and ability. After serving fourteen years in Congress, he was, in 1839, elected governor of Tennessee; and in 1844 unexpectedly nominated, as a compromise candidate, for the presidency, against Henry Clay, and elected. During his term, the Oregon boundary was settled by a compromise offered by England, though the party cry which helped to elect him was a claim for the entire territory to 54° 40' N. lat. The annexation of Texas caused, in 1846, a war with Mexico: 50,000 volunteers, added to the small regular force, sufficed to take the capital (September 14, 1847), and enabled the government to dictate terms of peace, by which it acquired California and New Mexico. Having pledged himself to a single term of office, Mr P. refused a renomination, and retired to his home in Nashville, Tennessee, where he died three months afterwards, June 15, 1849. Mr P. was a man of respectable abilities, and of a solid, firm, honest, and religious character. He was devoted to the principles of the Democratic party of Jefferson and Jackson—state rights, a revenue tariff, independent treasury, and strict construction of the constitution.

**POLKA**, a species of dance, of Polish or Hungarian origin, the music to which is in  $\frac{2}{4}$  time, and has the rhythmical peculiarity of being accented on the third quaver of the measure. It was



introduced as a fashionable dance into Western Europe about 1841.

**POLL-ACT**, a sanguinary act, passed at Trim in Ireland, by the Junto of the Pale, in 1465, under the Earl of Desmond, deputy. It ordained 'that it shall be lawful to all manner of men that find any theeves robbing by day or night, or going or coming to rob or steal, or any persons going or coming, having no faithful man of good name and fame in their company in English apparell, that it shall be lawfull to take and kill those, and to cut off their heads, without any impeachment of our sovereign lord the king. And of any head so cut off in the county of Meath, that the cutter and his ayders there to him cause the saed head so cut off to be brought to the portreffe to put it upon a stake or spear, upon the Castle of Trim, and that the saed portreffe shall testify the bringing of the same to him. And that it shall be lawful for the saed bringer of the saed head to distrain and levy by his hand (as his reward) of every man having one ploughland in the barony, two pence; and of every man having half a ploughland, one penny; and of every man having an house and goods, value forty shillings, one penny; and of every cottier having one house and smoak, one half-penny.' Much slaughter is said to have been committed under this remarkable act.

**POLL-TAX.** See **CAPITATION.**

**POLLACK** (*Merlangus pollachius*), a fish of the family *Gadida*, of the same genus with the Whiting and Coal-fish. It is common on the coasts of all parts of Britain; and in Scotland and some parts of Ireland, it is called *Lythe*. It is a very playful fish, often gamboling on the surface of the water. It attains about the same size as the coal-fish. It has three dorsal fins; the body is of a longish shape; the lower jaw is much longer than the upper; the tail is slightly forked. The flesh is reckoned superior to that of the coal-fish. Young pollacks are sometimes sold as whittings, to which, however, they are not nearly equal. No fish more readily rises to the artificial fly, and in this way great numbers are caught on the British coasts. The fly is merely a bit of white feather tied to a common bait-hook. Worsted is sometimes used instead of the feather; and flies of different colours are sometimes used together, with great success. No reel is employed, and any stick is good enough for a rod; a few yards of string make a sufficient line.

**POLLAN** (*Coregonus Pollan*; see **COREGONUS**), a fresh-water fish of the family *Salmonida*, a native of lakes in Ireland. It is particularly abundant in Lough Neagh, where it is often seen in large shoals, which issue from the deep waters, and haunt the shore from spring to autumn, when great numbers are taken by nets, and sold in the neighbouring country. The P. is from 10 to 12 inches in length; it resembles the Gwyniad, but has not the snout produced like that fish; and there are differences in the size and position of the fins. It is very like *Coregonus sikus*, a species found in the most northern parts of Norway. The spawn of the P. is deposited in November and December on the rocky or stony parts of the bottom of the lake which it inhabits. It is a well-flavoured fish. The cry of 'Fresh Pollan' is even more common in Belfast during summer than that of 'Fresh Herring.'

**POLLARDING** (*to poll*, to cut off, or shave the head) is the cutting off of the whole crown of a tree, leaving it to send out new branches from the top of the stem. Trees thus treated are called *pollards*. The new branches are never equal in magnitude to the original branches of the tree, although often more numerous, and when pollarding

is often repeated, the scars and stumps form a thick ring at the top of the stem, from which many small branches spring. Pollards are not beautiful; but pollarding is practised with advantage in districts where fuel is scarce, the branches being cut off in order to be used for fuel, and the operation repeated



Pollard Oak.

every third or fourth year. It is much more prevalent in many parts of Europe than in any part of Britain, and in Britain is almost confined to those districts of England which are furthest from coal. Willows, Poplars, Alders, Elms, Oaks, and Limes are the trees most frequently pollarded, and in some parts of Europe the White Mulberry. The trees of most rapid growth are preferred where fuel is the object; and willows, poplars, and alders are planted along water-courses, and in rows in moist meadows and bogs. Oaks are sometimes pollarded chiefly for the sake of the bark of their branches, and the whole treatment very much resembles that of copse-wood. In some parts of Germany, landscapes may be seen of open country with many scattered oak and elm pollards, presenting a very peculiar appearance.

**POLLEN.** See **STAMEN** and **FECUNDATION.**

**POLLENZA**, a well-built town in the northern part of the island of Majorca, about 2 miles west of the Bay of Pollenza, and 28 north-west of Palma. It has a Jesuits' college and some manufactures of black woollen cloth. Pop. about 6500.

**POLLIO**, **C. ASINIUS**, a politician, soldier, and author of considerable merit, and still more considerable reputation, was born in Rome 76 B.C. but belonged to a family of Marrucianian descent. His first ambition was to be an orator, and in his youth he seized every opportunity of hearing such men as Hortensius and Cicero. When civil war broke out between Cæsar and Pompey, P. sided with the former, was present at the crossing of the Rubicon, and accompanied the great general in his rapid triumphal march through Italy. He joined Cæsar in his expedition to Greece against Pompey, and took part in the decisive battle of Pharsalia, 48 B.C. At the time of Cæsar's assassination (15th March, 44 B.C.), P. was governor of Hispania Ulterior (Further Spain), and carrying on the war against Sextus Pompey. In the subsequent struggles, he

sided with the triumvirate (Antony, Lepidus, and Octavian) against the oligarchic senate; and on the triumph of the former, was appointed administrator of Transpadane Gaul, in which capacity he saved the property of the poet Virgil at Mantua from confiscation. After Antony and Octavian had quarrelled, it was P. who effected their temporary reconciliation at Brundisium, 40 B. C.; next year he conducted a successful campaign against the Parthini, a people of Illyria, and in consequence, obtained a triumph. After this event, however, he withdrew altogether from political life. He lived 18 years after the Emperor Augustus, dying at his Tusculan villa, 4 A. D., in the 80th year of his age. Besides having a reputation for oratory, P. was celebrated as a historian, poet, and critic; and there seems little reason to doubt that he was an author the loss of whose writings is to be regretted. His literary and political criticism of his contemporaries, in particular, appears to have been valuable. He also claims remembrance as a distinguished patron of men of letters, such as Catullus, Horace, Virgil, and as the founder of the first public library at Rome.

**POLLNITZ, KARL LUDWIG VON**, noted as a writer of memoirs of his time, was born near Cologne in 1692. He was equally remarkable for his talents and want of principle; and while his father's position as minister of state to the Elector of Brandenburg gave him access to court-circles, his extravagance and eccentricity, coupled with his vagabond habits, often reduced him to the greatest poverty. But after wandering all over Europe, taking service in the church in Austria, and in the army in Spain, he finally attracted the favourable notice of Frederick the Great, who appointed him his reader, and made him director of the theatre at Berlin. After having twice changed from Catholicism to Calvinism, he proclaimed himself a member of the church of Rome shortly before his death, which occurred in 1775. Among the numerous memoirs, either written by or ascribed to him, the following were the most popular in their day, and the most applauded for the powers of observation and the wit which they exhibit: *Lettres et Mém., et la Relation de ses premiers Voyages* (Amst. 1735); *Etat abrégé de Saxe sous Auguste III.* (Frankf. 1734); *Hist. secrète de la Duchesse d'Hanovre, épouse de George I.* (Lond. 1732). After his death, Brunn brought out P.'s *Mémoires pour servir à l'Histoire des quatre derniers Souverains de la Maison de Brandenbourg* (2 tomes, Berl. 1792).

**POLLOCKSHAW'S**, a municipal borough in the county of Renfrew, Scotland, is situated on the banks of the White Cart, about 2½ miles south-west of Glasgow. The name is derived from the estate of Nether-Pollock, on which the town stands, and from the Scotch word 'shaw,' which means a 'grove' or 'plantation.' P. is entirely a manufacturing town; cotton-spinning, calico-printing, silk-weaving, bleaching, and fancy dyeing, are, or until recently, were extensively carried on. Pop. 7648.

**POLLOK, ROBERT**, a Scottish poet, was born in 1799 at Muirhouse, in the parish of Eaglesham, in the county of Renfrew. After receiving the ordinary course of instruction in country schools, he was sent to the university of Glasgow, and on the completion of his curriculum in arts, he entered the Divinity Hall of the Secession Church, where he studied five years. In 1827, he was licensed to preach. By this time he had written the *Course of Time*, and its composition, together with the ardour with which he pursued his studies, brought on consumption. The poem was published by Mr Blackwood in the same year in which the author

received licence. It was highly praised, but the voice of praise fell on a dying ear. In his critical state, his medical attendants recommended residence for a time in Italy, and in compliance with their advice, he set out, accompanied by his sister. On his arrival in London, his symptoms became suddenly worse, and unable to prosecute his journey, he went to reside at Shirley Common, near Southampton, where he died on the 17th September 1827. He was interred in the churchyard at Millbrook, and over his grave an obelisk has been erected.

The *Course of Time* has run through more than twenty editions, and is extremely popular in Scotland. It is a work of genius, but curiously unequal in merit. It contains eloquent and spirited passages, but considerable portions of it read like a dull sermon turned into blank verse. The writer drew his inspiration from nature, from Milton, and the Shorter Catechism—from the last, perhaps, most of all. His Memoir, written by a brother, was published in 1843. P. also wrote *Tales of the Covenanters*, which were published anonymously.

**POLO, MARCO**, the celebrated traveller, was born of a noble family of Dalmatian origin, at Venice, about 1250. His father, Nicolo Polo, and his uncle, Matteo Polo, both eminent merchants, had, previous to his birth, set out on a mercantile expedition, visiting Constantinople, Soldaya or Sondach (on the Euxine), and Bulgar (on the Volga), the capital of Barkai, the Khan of Keptchak. Thence they travelled round the north side of the Caspian Sea to Bokhara, where they remained three years, studying the Mongol language and trading; but in 1261, some ambassadors from the Perso-Mogul khan to Kúblai (q. v.), the Grand Khan of the Mongols, happening to pass through Bokhara, the brothers Polo resolved to accompany them to Kementu, the summer residence of the Khagan. They were well received by Kúblai, who was very inquisitive concerning the peoples and mode of government in Europe, and commissioned them to act as his envoys to the pope, bearing a written request for 100 Europeans, well learned in the sciences and arts, to act as instructors to the Mongols. They reached Venice in 1269; but finding it impossible to discharge the mission with which they had been intrusted, they set out on their return in 1271, taking with them young Marco, and arrived again at the court of Kúblai Khan in 1275. Their second reception was still more honourable than the first, and the Khagan took special notice of Marco, from the rapidity with which he learned the customs and language of the Mongols. His wisdom and the nobility of his demeanour also recommended him as a fit envoy to the various neighbouring rulers; and during his residence at their several courts, P. was in the habit of closely observing the manners and customs of the country, and delivering on his return a detailed report to the Khagan. These reports were the groundwork of the book which informs us regarding the state of Central and Eastern Asia in the end of the 13th century. P.'s first mission was to the court of Annam or Tonquin (1277), and during his residence there, he acquired much information, both from his own observation and from report, concerning Tibet, Yunnan, Bengal, Mien (or Pegu), and the south of China; he was next employed to aid in making an inventory of the archives belonging to the court of the Song dynasty; and soon afterwards was appointed governor of the town of Yang-tchow, in the province of Kiang-si, in Eastern China, a post he held for three years. He also accompanied a Mongol army to the attack of the kingdom of Pegu; and closed the list of services rendered to Kúblai by accepting the embassy to Taiampa, the south

part of Cochin-China. Having thus passed 17 years in the service of the Mongol khan, and visited the chief countries and cities of Eastern Asia, travelling through kingdoms (as China) which no European had ever seen before, and acquiring much knowledge of other kingdoms (as Japan, called by P. *Zipangu*), the existence of which was not even suspected, he succeeded in obtaining permission to join the escort of a Mongol princess, who was travelling to the court of Persia. The three Polos accordingly set out in 1291, travelling through China, and thence, by sailing through the Chinese Sea and Indian Ocean, finally arrived at Teheran, where they stayed for some time; but learning that Kúblai Khan was now dead, they continued their journey, and arrived at Venice in 1295, bringing with them much wealth and many precious objects, the fruits of their trading. Marco, in the following year, fought his own galley in the great battle off Curzola, in which the Venetians, under Dandolo, were defeated by the Genoese under Doria, and was taken prisoner and immured in a dungeon at Genoa. Here he dictated, with the aid of the memoranda he had made during his travels, an account of his journey through the East, which was subsequently revised with care. After his liberation he returned to Venice, where he was appointed member of the Grand Council, and died in 1323, eleven years after his father. His work is variously entitled, but the best edition is *Il Milione di Messer Marco Polo Veneziano*, edited by Count Baldelli (Florence, 4 vols. 4to, 1827), and accompanied with a map, notes, and illustrations. P.'s narrative created an immense sensation among the learned public, and many did not hesitate to affirm that it was a pure fiction; but the Catholic missionaries and subsequent Venetian travellers into these remote regions, verified many of P.'s statements, and then came a reaction of public opinion; P.'s wonderful minuteness, extensive research, and accuracy, being the theme of universal admiration. His work was of inestimable value as a stimulant and guide in geographical research; it encouraged the Portuguese to find the way to Hindustan round the Cape of Good Hope; and it roused the passion for discovery in the breast of Columbus, thus leading to the two greatest of modern geographical discoveries. The first edition of P.'s 'Voyages' was published by Ramusio in his *Raccolta di Navigazioni e Viaggi* (Venice, 3 vols. fol. 1550—1559); and two English translations have been lately published, the one in Edinburgh (1844), and the other in London (1854). There is also a German one by Burck, with notes by Neumann (Leips. 1846).

POLO'TSK, a town of West Russia, in the government of Witebsk, and 60 miles west-north-west of the city of that name, on the banks of the Duna, where that river is joined by the Polota. It is one of the most ancient towns in Russia, having been founded in the 9th century. It is the seat of an archbishop of the Greek United Church, has a Kremlin, a district-school for the sons of nobles, several Greek and Roman Catholic churches. The town possesses a harbour, and has 15,028 inhabitants. Tanning is the only branch of trade carried on to any great extent. Under its walls, in the campaign of 1812, the Russian general, Wittgenstein, defeated the French under Oudinot and Sire.

POLTA'VA, chief town of the government of the same name, is situated on the right bank of the Worskla, a tributary of the Dnieper, in lat. 49° 35' N., and long. 34° 34' E., about 934 miles south-south-east of St Petersburg. Pop. 20,200. P. has few manufactures, and its trade displays activity only during the annual fairs, of which there are

four. The most important is called the Ilinsky, which lasts from the 1<sup>st</sup> of July to the 1<sup>st</sup> of August. At these fairs, merchandise is exposed for sale worth £4,000,000. The principal articles of traffic are cloths, woollen tissues, colonial productions, fur, wool, horses, and agricultural produce and implements. P. was founded in 1608, and is historically famous as the scene of Charles XII.'s defeat by Peter the Great in 1709. A monument in the town square commemorates the victory of the czar; and at the distance of three miles from the town is the tomb of the fallen warriors, over which Peter erected a wooden cross, and which is still known as the 'Swedish Tomb.'

POLTAVA, a government of Little Russia, between the governments of Kiev on the west, and Kharkov on the east. Area, 19,071 square miles; pop. 1,879,912. The surface is flat, with a gradual slope south-west to the banks of the Dnieper, which forms the southern boundary, and into which the chief rivers—the Sula, Psiol, and Worskla—flow. The government does not abound in wood, but possesses rich and extensive pastures. The soil is for the most part clay and fertile vegetable mould, and the climate is healthy. Agriculture and cattle-breeding are the staple occupations. Oxen are made use of in all field operations. The various manufactories, chiefly brandy-distilleries, tan-yards, and sugar and cloth manufactories were (in 1859) only 576 in number, and gave employment to no more than 15,782 hands. Numbers of the inhabitants leave this for other governments, especially those of New Russia, in search of employment; and many of the peasantry are employed with their oxen in bringing salt from the lakes of the Crimea, and fish from the Don. Commerce, which is not carried on on a great scale, is chiefly in the hands of Jews. The fairs, of which 408 take place during the year, are the seasons of the greatest commercial activity. The most important fairs are those of Poltava and Romny.

POLYA'NDRY, or POLYANDRIA, that form of polygamy which permits a woman to have several husbands. See MARRIAGE. The hot-bed of polyandry is Tibet. There a wife commonly is the wife of a whole family of brothers—the elder brother being chief husband. In the Himalayan and sub-Himalayan regions adjoining and under the influence of Tibet, it is of frequent occurrence in the same form, as in the valley of Kashmir, in Ladak, among the Koech, among the Telingese. Further south in India, we find polyandry among the Todas of the Nilgherry Hills, the Coorgs of Mysore, and the Nayars of Malabar. We find it again off the Indian coast in Ceylon; and going eastward, strike on it as an ancient though now almost superseded custom in New Zealand, and in one or two of the Pacific islands. Going northward, we meet it again in the Aleutian Islands; and taking the continent to the west and north of the Aleutians, it is found among the Koryaks, to the north of the Okhotsk Sea. Crossing the Russian empire to the west side, we meet it among the Saporogian Cossacks; and thus have traced it at points half round the globe. This is not all, however. It is found in several parts of Africa; and it occurs again in many parts of America among the red men. We have the authority of Humboldt for its prevalence among the tribes on the Orinoco, and in the same form as in Tibet. 'Among the Avaroes and the Maypures,' he says, 'brothers have often but one wife.' Humboldt also vouches for its former prevalence in Lan-cerota, one of the Canary Islands. Thus, polyandry is a phenomenon of human life independent

of race and country.—See Latham's *Descriptive Ethnology* (1859), vol. i. pp. 24, 28; vol. ii. pp. 398, 406, and 462; Humboldt's *Personal Narrative*, William's translation, 1819, vol. v. part 2, p. 549; and chap. i. vol. i. p. 84; Hamilton's *New Account of the East Indies* (Edin. 1727), vol. i. pp. 274 and 308; Reade's *Savage Africa*, p. 43; Erman's *Travels in Siberia*, vol. ii. p. 531; *Marriage Ceremonies*, by Seignior Gaya (translation), 2d edition (Lond. 1698) pp. 70 and 96; Emerson Tennent's *Ceylon*, 3d edition (1859), vol. ii. p. 429; Legend of Rupe, Grey's *Polynesian Mythology*, 1855, p. 81; *A Summer Ramble in the Himalayas* (1860), p. 202; Vigne's *Kashmir*, vol. i. p. 37; *Journal Asi. Soc. Bengal*, vol. ix. p. 834; and *Asiat. Resch.* vol. v. p. 13.

From ancient history we learn that the area over which polyandry at one time existed was even more extended; while in certain cantons of Media, according to Strabo (lib. ii. p. 798, and see Gouquet, vol. iii. book vi. c. i.) polygyny was authorised by express law, which ordained every inhabitant to maintain at least seven wives; in other cantons, precisely the opposite rule prevailed: a woman was allowed to have many husbands, and they looked with contempt on those who had less than five. Cæsar informs us that in his time polyandry of the Tibetan type prevailed among the Britons (*De Bello Gallico*, lib. v. c. xiv.). We find direct evidence of its existence among the Picts in the Irish Nennius App. li, not to mention the traces of it remaining in the Pictish laws of succession. Indeed, to pass over communities in which something like promiscuity of intercourse between the sexes is said to have prevailed—such as the Massagetæ, Agathyrsi, and the ancient Spartans—we find several among which polyandry, or a modified promiscuity, must have been the rule. Assuming, that the legal obligation laid on younger brothers in their turn to marry the wives of their deceased elder brother, is a relic of polyandry of the Tibetan type, then we must hold that polyandry prevailed at one time throughout India (*Institutes of Menu*, chap. iii. s. 173, and chap. ix. ss. 57, 58), among the ancient Hebrews (*Deut.* xxv. verses 5—11); in Siam, Burmah, in Syria among the Ostiaks, the But (Bodo), the Kasia, and the Puharies of Gurhwal. Traces of it indeed remained in the time of Tacitus among the Germans (*Tac., Germ.*, xx., Latham's edition, p. 67 and seq.). In short, polyandry may be regarded as one of the transitional forms in the advance from a state of promiscuity, on the assumption that pure promiscuity ever existed. Of the origin of this peculiar institution, our space forbids us to write; but we believe it to be connected with the want of balance between the numbers of the sexes, due to the practice of female infanticide, which is its almost invariable accompaniment. Tribes of warriors, wholly devoted to a military life, find women an incumbrance rather than a solace; and from this cause, and probably from the difficulties of subsistence, formed the practice of killing their female children, sparing them only when they were the first-born. The disparity of the sexes would lead to polyandry, and once instituted, the custom would in many cases continue to exist after the habits and necessities which produced it disappeared. In several places, as in Ladak, where polyandry prevails, the sexes are now either equally balanced, or the female sex predominates. In these cases, polygyny and polyandry are commonly found existing side by side. The subject is one which demands, and as yet has not received full investigation.

**POLYANTHUS** (Gr. many-flowered), a kind of Primrose (q. v.), much prized and cultivated by

florists. It is generally believed to be a variety of the Common Primrose (*Primula vulgaris*), produced by cultivation, in which an umbel of numerous flowers is supported on a common scape (leafless flower-stem), instead of each flower rising on its own stalk from the crown of the root; a modification to which a tendency often appears in the wild plant itself. Thus, in its habit it somewhat resembles the cowslip and oxlip, whilst in the size of its flowers it is more like the common primrose; but instead of the pale uniformity of the wild plant, it exhibits



Polyanthus.

great variety of delicate and beautiful colours. The subvarieties are innumerable, new ones being continually produced from seed, and of short duration. The seed is sown about midsummer, and flowers may be expected in abundance next year, if the young plants are properly planted out. A rich free soil is most suitable. The P. loves shade and moisture more than its congener, the auricula. It is very hardy, and seldom suffers from the most severe winters. Fine kinds are preserved for a time by dividing the root. The cultivation of the P. is prosecuted with particular assiduity and success in England.

**POLYANTHUS NARCISSEUS.** See **NARCISSEUS**.

**POLYATOMIC ALCOHOLS.** The term *Alcohol*, originally limited to one substance—viz., spirit of wine, or hydrated oxide of ethyl, has begun to be applied to a considerable number of organic compounds, many of which, in their external characters, bear little resemblance to common alcohol. Most of them are fluid and volatile, some of them are combustible, and all of them are composed of carbon, hydrogen, and oxygen, behave in a precisely similar manner towards the same decomposing agents, and are perfectly neutral to test-paper.

Every alcohol, when acted on by oxidising agents, loses two equivalents of hydrogen, and is converted into an *Aldehyde*; and by the prolonged action of the oxidising agent, the aldehyde takes up two equivalents of oxygen, and is converted into a *special acid*. Moreover, all alcohols, by the abstraction of the elements of water, yield ethers. Hence, every alcohol has its own ether, aldehyde, and special acid; the aldehydes of the alcohols termed polyatomic have, however, not been formed.

According to the theory of organic radicals, the alcohols are hydrated oxides of an alcohol radical. Thus, common alcohol, or spirit of wine, is the hydrated oxide of the radical ethyl ( $C_2H_5$ ), and is represented by the formula  $C_2H_5O,HO$ ; similarly,

wood-spirit is the hydrated oxide of the radical methyl ( $C_2H_5$ ), and is represented by the formula  $C_2H_5O.HO$ . According to the theory of chemical types (see TYPES, THEORY OF CHEMICAL), the alcohols are divided into *monatomic* and *polyatomic*. A molecule of water consists of two atoms of that substance, and is therefore represented by the formula  $H_2O_2$ , which may be arranged in the form  $H \left\{ \begin{array}{l} H \\ O_2 \end{array} \right.$ . If half the hydrogen in this typical formula

be replaced by an organic radical, such, for example, as  $C_nH_{n+1}$ ,  $C_nH_{n-1}$ ,  $C_nH_{n-2}$ ,  $C_nH_{n-7}$ , or  $C_nH_{n-9}$  ( $n$  being even in all these cases), we obtain what is termed a monatomic alcohol, one equivalent of hydrogen being here replaced. Besides the primary water-type represented by one molecule of water, there are derived or secondary and tertiary types, represented by two and by three molecules of water, and expressed in the forms  $H_2 \left\{ \begin{array}{l} H_2 \\ O_4 \end{array} \right.$  and  $H_3 \left\{ \begin{array}{l} H_2 \\ O_6 \end{array} \right.$ . If

half the hydrogen in  $H_2 \left\{ \begin{array}{l} H_2 \\ O_4 \end{array} \right.$  be replaced by an organic radical, we obtain an alcohol said to be *diatomic*, in consequence of its being formed by the replacement of two equivalents of hydrogen. Similarly, if half the hydrogen in  $H_3 \left\{ \begin{array}{l} H_2 \\ O_6 \end{array} \right.$  be replaced by an organic radical, we obtain a triatomic alcohol. The term *polyatomic* is applied to all alcohols which are not monatomic.

**POLYBASIC ACIDS.** Most of the inorganic acids combine with bases in such a manner that one atom of the acid is united with one atom of a metallic oxide to form a neutral salt. Nitric acid may be taken as an illustration of the acids possessing this property, and which may therefore be called *monobasic*. In other cases, as, for example, that of pyrophosphoric acid (see *PHOSPHORUS*), one atom of acid possesses the property of combining with two atoms of base; such acids are termed *bibasic* or *dibasic*. There are strong grounds for believing that sulphuric acid is bibasic, in which case its formula would require to be doubled, and to be written  $2HO_2S_2O_6$ . Common phosphoric and arsenic acids are examples of a third class of acids in which one atom combines with three atoms of base, and which are therefore termed *tribasic*. Whether any polybasic acids beyond tribasic acids exist, is uncertain, but it is probable that silicic acid is a *tetribasic* acid.

Amongst the organic acids, a similar relation takes place, acetic, succinic, and citric acids affording examples of the monobasic, dibasic, and tribasic class.

The following are the most important general differences shewn by acids of different degrees of basicity.

1. Each *monobasic* acid can form but one ether, which is neutral. 2. A *Monobasic* acid cannot form a stable, well-defined acid salt, or a salt with two or more metallic bases.

1. Each *dibasic* acid can form two ethers, one neutral, and the other acid. 2. *Dibasic* acids can form with each metallic base a neutral salt and an acid salt. They can also form double salts containing two metallic bases.

1. Each *tribasic* acid can form three ethers, one neutral, and two acid. 2. *Tribasic* acids can form three salts with the same metallic base, two of them acid, and one neutral.

Many attempts have been made to account for the polybasic or monobasic character of an acid, from its composition. According to Kekulé (*Lehrbuch der organisch. Chemie*, vol. 1, p. 210-219), the basicity depends not, as was formerly supposed,

on the molecular constitution of the acid, but upon the amount of oxygen contained in its radical. For further details on this subject, the reader is referred to the article ACIDS in Watt's *Dictionary of Chemistry*, vol. 1, 1863.

**POLYBIUS**, the Greek historian, was born about 204 B.C. in Megalopolis, a town of Arcadia. From Lycortas, his father, who was among the leading men of the Achæan League, he received valuable instruction in the science of politics and in the art of war. In 181, he would have visited Egypt in the capacity of ambassador, but the project of sending an embassy to that country was given up. His engaging in public affairs probably dates from this period; and he rapidly gained the confidence of his countrymen. He was one of the 1000 noble and influential Achæans, who, after the conquest of Macedonia in 168, were sent to Rome on the summons of the commissioners from that city to answer the charge of having failed to assist the Romans against King Perseus. On their arrival in Italy in 167, they were not put upon their trial, but were distributed among the towns of Etruria. Owing, perhaps, to his having formed the friendship of Æmilius Paulus, or of his sons Fabius and Scipio, he was more fortunately allocated than others of his countrymen. His residence was fixed at Rome and in the house of Paulus. Scipio, then about 18 years of age, became strongly attached to P., made him his companion in all his military expeditions, and profited greatly by his knowledge and experience. P. in his turn derived much advantage from the protection and friendship of Scipio, who gave him access to public documents, and aided him in the collection of materials for his great historical work. In 151, the surviving Achæan exiles were permitted by the Roman senate to return to Greece, and among them was P., who arrived in Peloponnesus after a residence of 17 years in Italy. He soon, however, rejoined Scipio, followed him in his African campaign, and was present at the destruction of Carthage in 146. But the outbreak of war between the Achæans and Romans summoned him again to Greece, where he arrived soon after the taking of Corinth. All his influence was now exerted to procure for the conquerors favourable terms for the vanquished; and so grateful were his countrymen for his services in their behalf, that they erected statues in his honour at Megalopolis (his native town), Mantinea, Pallantium, Tegea, and other places. It must have been about this time that P. undertook the writing of his great historical work, the materials of which he had so long been collecting. We cannot now fix with accuracy at what period of his life he visited in foreign countries the places which he had to describe in his history. We know from himself that at one time, probably while accompanying Scipio, he undertook long and laborious journeys into Africa, Spain, Gaul, and even as far as the shores of the Atlantic, in order to add to the scanty knowledge previously existing with regard to these regions. In the latter period of his life, he travelled in Egypt; and about twelve years before his death, he probably accompanied Scipio to Spain, where he witnessed the fall of Numantia. He died about 122 B.C., in his 82d year, in consequence of a fall from his horse.

As a historian, P. occupies a high rank. His work, which began where that of Aratus broke off, includes the period between 220 and 146 B.C., the year when Corinth fell, and, with it, the independence of Greece. Of the two parts into which it was divided, the first embraced a period of 53 years, commencing with the Second Punic War and the Social War in Greece, and concluding with the subjugation of the kingdom of Macedonia in 168. This, the chief

portion of his history, was designed to shew how, in the short space of 53 years, the greater part of the world had been conquered by the Romans; and in order that his countrymen might have a better knowledge than they possessed of the rise of that people, he gives a sketch of the history of Rome from its capture by the Gauls to the outbreak of the Second Punic War. This occupies the first two books, and may be regarded as an introduction to the work. The second part embraces the period from the fall of the Macedonian kingdom, in 168, to the taking of Corinth in 146. This part is to be viewed as supplementary to the first, and seems to have brought down the history of the conquest of Greece to its completion in the 39th book, while the 40th and last probably contained a chronological summary of the entire work. The style of P. is not his most striking feature, and he incurred the censure of later Greek critics for his negligence in the choice of words and in the structure of his sentences. His great merits are the care with which he collected his materials, his strong love of truth, and his sound judgment, which was materially assisted by his familiarity with political and military life. His tone is too didactic in general, and although his readers are prepared for this by his calling his work not a *Historia*, but a *Pragmatica*, still the continuity of the narrative is too often interrupted by digressions, sometimes interesting and valuable in themselves, but fatal to artistic effect. Much the greater part of his work has perished. Of the 40 books, we possess only five entire; and of the rest, merely fragments or extracts. Some of these latter, however—such as the account of the Roman army—are of considerable length and value, and four separate collections of them have been added from time to time to the remains of the work. The first of these, discovered soon after the revival of learning, in a MS. of Corfu, gives us the greater part of the 6th book, and portions of the remaining 11. The second consists of extracts made in the 10th c., entitled *Excerpta de Legationibus*, and published at Antwerp by Ursinus in 1582. The third, entitled *Excerpta de Virtutibus et Vitiis*, was published in 1634 by Valesius. The fourth, entitled *Excerpta de Sententiis*, was discovered by Cardinal Mai in the Vatican, and published by him at Rome in 1827. The history of P. was very closely followed by Livy after the period of the Second Punic War, and by Cicero in his account of the Roman constitution in his treatise *De Republica*.—The best annotated edition of P. is Schweighäuser's (Leip. 1789). The best edition of the text, including that of the Vatican fragments, is that of Bekker (Ber. 1844).

POLYCARP, Bishop of Smyrna, and one of the most illustrious of the early Christian martyrs, was born in the latter part of the 1st c. A. D., but neither the date nor the place of his birth is known. He was, however (according to a legendary fragment ascribed to an unknown Pionius), brought up at Smyrna, where his pupil, Irenæus, states that P. was taught the doctrines of Christianity by the apostles, particularly by John, with whom he had 'familiar intercourse.' The testimony of Irenæus on this point is of immense value, as it furnishes the chief historical link uniting the apostolic age—that age which is reflected in the later parts of the New Testament—with the rising church of the 2d century. The passage occurs in an expository epistle to a Roman heretic, Florinus, and is preserved by Eusebius (*Hist. Eccl.* chap. xx.). 'I can tell also the very place where the blessed Polycarp was accustomed to sit and discourse; and also his entrances, his walks, the complexion of his life, and the form of his body, and his conversations with the

people, and his familiar intercourse with John, as he was accustomed to tell, as also his familiarity with those that had seen the Lord. Also concerning his miracles, his doctrine, all these were told by Polycarp, in consistency with the Holy Scriptures, as he had received them from the eye-witnesses of the doctrine of salvation.' The fragment of Pionius (to which reference has already been made) informs us that P., when only a little child, was adopted by a rich Christian lady named Callisto, who left him heir to all her wealth; in consequence of which he was enabled to gratify his love of works of beneficence and charity. We are, however, utterly without the means of determining what truth (if any) there is in the narrative of Pionius, and can only feel certain that in some way or other he had distinguished himself at a comparatively early period, for before the death of the Apostle John (i. e., at the latest, before 104 A. D.), he was ordained Bishop of Smyrna (according to Tertullian and Jerome) by John himself; according to Irenæus, by 'the apostles;' and according to Pionius, by 'the bishops of the neighbouring churches'—statements which are quite reconcilable with each other. P. was in the exercise of his episcopal functions when Ignatius of Antioch passed through Smyrna on his road to Rome (107—116 A. D.); and we are told that the two pupils of St John, who had probably known one another in earlier years, had much delightful Christian converse. Almost half a century afterwards, P. himself visited Rome, when Anicetus was bishop there (157—168 A. D.), and had a friendly conference with his brother on the subject of the proper time to hold Easter. They could not agree—but they agreed to differ. His martyrdom, which is related at great length and in a touching manner by Eusebius (*Hist. Eccl.* chap. xiv.), took place probably in 166 A. D., during the persecution under the emperors Marcus Aurelius and Lucius Verus. When asked, or rather entreated 'to revile Christ' by the proconsul Statius Quadratus, who, being deeply impressed with the venerable appearance of the aged bishop, wished if possible to save his life, P. replied: 'Eighty-and-six years have I served him, and He never did me wrong; and how can I now blaspheme my King that has saved me.' P. was burned alive. In such profound reverence was he held by his fellow-Christians, for his almost perfect graces of character, that the Jews (who had been conspicuously zealous in collecting 'wood and straw from the shops and baths' to burn him) instigated the proconsul not to give up the corpse of the martyr to his co-religionists, 'lest, abandoning him that was crucified, they should begin to worship this one.' More convincing evidence of a saintly character has never been adduced.

P. wrote several *Epistolæ*, of which only one has been preserved, the *Epistola ad Philippenses*, valuable for its numerous quotations from the New Testament—especially from the writings of Paul and Peter. It has been frequently printed, the latest editions being those of Jacobson (*Patrum Apostolicorum quæ supersunt*, vol. ii., Oxford, 1838) and Hafele, *Patrum Apostolicorum Opera* (Tübingen, 1839). There are English versions by Cave, Clementson, and Wake.

POLYCHROME PRINTING, the art of printing in one or more colours at the same time. Although several attempts had been previously made to carry out this process, Congreve, in 1820, was the first to do it successfully with metal plates. Sir William Congreve had seen Applegath's polychromatic block-printing press, by which very rude coloured pictures were produced, and he conceived the idea of improving upon it, and doing it with

metal. His plan is extremely simple, though requiring great nicety in carrying it out. First, the picture is outlined upon a metal-plate; and supposing it intended to have two colours, then the details of only the chief colour are completed upon it, and all the parts for the other colour are cut out; and into those parts other plates are fitted, like the portions of a child's puzzle-map, but with very great exactness; and upon these the engraving for the parts of the second colour are completed. When these are done, a thickness of type-metal is attached to the back of these interior pieces, so that they can be held separately, and pushed forwards or drawn backwards at pleasure. Then they are so adjusted to the machinery of the press, that they are withdrawn when the first colour-roller passes over the surface of the main plate, and are pushed forward beyond the face of the main plate, so as to receive the colour of the second roller, which then passes over them without touching the first or main plate. Having received their coloured ink, the secondary plates are again moved back to a perfect level with the other, so as to form an entire plate, carrying two colours, which are thus, in the ordinary way, imprinted on the paper. Since Sir William Congreve's patent, very many improvements have been made, the principle, however, remaining the same, and it has now a very wide application.

**POLYCOTYLEDONOUS PLANTS**, those plants of which the embryo has more than two seedlobes or cotyledons. See **COTYLEDON** and **DICOTYLEDONOUS PLANTS**. In some of the *Coniferæ* in particular, there are numerous cotyledons; the genus *Pinus* has from three to twelve. These cotyledons are placed in a whorl, and have the gemmule of the embryo in the midst of them. Polycotyledonous plants do not form a separate division of the vegetable kingdom, but are ranked with dicotyledonous plants; for plants with two, and plants with more cotyledons, are found not only in the same natural order, but in the same genus.

**POLYCRATÉS**, 'tyrant' of Samos, is a well-known name in ancient Greek history. He was born in the first part of the 6th c. B. C., but nothing is known of him until the time when, with the assistance of his brothers Pantagnôtus and Sylosôn, he obtained possession of the island. The three brothers at first ruled conjointly, but after a short time, P. put Pantagnôtus to death, banished Sylosôn, and made himself sole despot. His energetic, unscrupulous, and ambitious character now shewed itself more conspicuously than ever. He conquered several islands of the Archipelago, and even some towns on the Asiatic mainland, waged war successfully against the inhabitants of Milêtus, and defeated their allies, the Lesbians, in a great sea-fight. His fleet amounted to 100 ships, and was probably at that time the most powerful in all Greece. P. seems to have aspired to the sovereignty of the Ægean, if not also of the cities of Ionia. His intimate alliance with Amasis, king of Egypt, proves the importance in which this daring island-prince was held even by great monarchs. According to Herodotus, Amasis drew off from his alliance through alarm at the uninterrupted good fortune of Polycratés. He dreaded, we are told, the misfortunes that the envious gods must be preparing for so lucky a mortal, and to which his friends would also be exposed. The particular incident that is said to have finally ruptured the alliance is doubtless mythical, but is so well known that we cannot afford to overlook it. Amasis is reported to have written a letter to P., earnestly advising him to throw away the possession that he deemed most valuable, and thereby avert the stroke of the

splendid gods. P., in compliance with this friendly advice, cast a signet-ring of marvellously beautiful workmanship into the sea, but next day a fisherman presented the 'tyrant' with an unusually big fish that he had caught, and in its belly was found the identical ring. It was quite clear to Amasis now that P. was a doomed man, and he immediately broke off the alliance. So, at least, Herodotus tells the story, but Grote (*History of Greece*, vol. iv. page 323) suggests—and the suggestion is far more probable—that P., with characteristic perfidy, abandoned the Egyptian for a Persian alliance, when he found the latter likely to be of more value to him in his ambitious designs. When Cambyses invaded Egypt (525 B. C.), P. sent him a contingent of forty ships, in which he placed all the Samians disaffected towards his 'tyranny,' and told the Persian king privately not to let them come back! However, they escaped in some way or other the fate which P. had designed for them, returned to Samos, and made war against the 'tyrant,' but without success. Hereupon, they went to Sparta, and succeeded in enlisting the sympathies, or, at any rate, in securing the help of both the Spartans and Corinthians. A triple force of Samians, Spartans, and Corinthians embarked for Samos, and attacked the city. After vainly besieging it for forty days, they sailed away, and P. now became more powerful than ever; but Nemesis had her victim after all. A certain Orotes, the Persian satrap of Sardis, had, for unknown reasons, conceived a deadly hatred against P., and having enticed the latter to visit him, by appealing to his cupidity, he seized and crucified him. Thus perished ignominiously, in the midst of his power and splendour, one of the most famous *thalassocrats*, or sea-kings, of Greek antiquity. He was a patron of literature and the fine arts, and had many poets and artists about his court. His intimacy with Anacreon, in particular, is quite a celebrated thing, and in his praise that joyous bard wrote many songs. To P. also, in all probability, belongs the construction, or at least the enlargement, of those great buildings which Herodotus saw at Samos.

**POLYDIPSIA** (Gr. *great thirst*) is the term now commonly applied to the disease formerly known as *Diabetes insipidus*. It is characterised, as its name implies, by extreme thirst, and by an enormous discharge of pale watery urine. The affection is one of rare occurrence, and the persons most liable to it are dyspeptics who have passed the period of middle life, and whose bodily powers are failing, although (as the case we shall immediately notice, and one recorded by Dr Watson, shew) it may begin in childhood. The two prominent features of this disease usually lead to the suspicion that true diabetes is present; but the low specific gravity of the urine, and the absence of sugar in it in polydipsia, and the reverse condition in diabetes, seem to make the distinction easy. Dr Willis, in his work *On Urinary Diseases*, records the case of a man, aged forty-five, who was admitted for an accident into the Hôtel-Dieu at Paris, and who passed, daily, on an average, thirty-four pounds of urine, and drank thirty-three pounds of water, the normal daily excretion of urine being a little less than two pounds. This person reported that he had been affected in a similar manner ever since his fifth year, and that, from the age of sixteen upwards, he had daily consumed not less than two bucketfuls of water, and discharged a commensurate quantity of urine. Little good can be effected by treatment, further than stimulating the action of the skin by the use

of Dover's powder, Turkish baths, &c., and by inducing the patient to take as little drink as may be at all consistent with his comfort.

**POLYGA'LEÆ**, or **POLYGALA'CEÆ**, a natural order of exogenous plants, herbaceous or shrubby, sometimes twining; the leaves without stipules, and generally simple; the flowers resembling papilionaceous flowers, but the odd petal inferior, and the odd sepal superior; the flower-stalks with three bracts; the calyx of five very irregular sepals; of which the two interior are usually petal-like; the corolla of three, or sometimes five petals, the anterior petal the largest, and often crested; stamens eight, monadelphous or diadelphous, or four and distinct; the ovary superior, generally 2-celled, one ovule in each cell; style and stigma simple; fruit generally a capsule opening by valves, sometimes a drupe. There are about 500 species, diffused throughout all parts of the world.—The genus *Polygala* has a persistent calyx, eight stamens, the lateral sepals large and petal-like, and hairy or wrinkled seeds. The species are very numerous, annual and perennial herbaceous plants, and small shrubs, natives chiefly of warm and temperate climates. One is found plentifully in Britain; the **COMMON MILKWORT** (*P. vulgaris*), a small perennial plant, growing in dry



Common Milkwort (*Polygala vulgaris*).

hilly pastures; with an ascending stem, linear-lanceolate leaves, and a terminal raceme of small but very beautiful flowers, having a finely crested keel. It varies considerably in size, in the size and even shape of the leaves, and in the size and colour of the flowers, which are sometimes of a most brilliant blue, sometimes purple, pink, or white.—Several species are natives of the south of Europe.—North America produces a greater number. The Cape of Good Hope and other subtropical countries produce many beautiful species, some of which have become common ornaments of greenhouses.—*P. Senega* is a North American species, with erect simple tufted stems, about one foot high, and terminal racemes of small white flowers. The root, which is woody, branched, contorted, and about half an inch in diameter, is the **SENEGA ROOT**, **SENEKA ROOT**, or **SNAKE ROOT** of the United States, famous as an imaginary cure for snake-bites, but really possessing

important medicinal virtues—stimulating, diuretic, diaphoretic, emmenagogue, and in large doses emetic and purgative—employed in catarrhs, pulmonary affections, rheumatism, low fevers, &c. Its chief active principle is *Polygalic Acid*,  $C_{22}H_{18}O_{11}$ . The root of *P. Senega* has been employed as a cure for snake-bites by the American Indians from time immemorial, and it is a curious fact, that *P. croatalarioides* is employed in the same way in the Himalaya. *P. vulgaris* is tonic, stimulant, and diaphoretic; and *P. amara*, a very similar European species, possesses the same properties in a higher degree, as does *P. rubella*, a small North American species. The root of *P. poaya*, a Brazilian species, with leathery leaves, is an active emetic, and in a fresh state, is employed in bilious fevers. Similar properties seem to pervade the whole genus. Another medicinal plant of the order is *Rattany* (q. v.) root. Species of several genera are used as tonics. The bark of the roots of *Monnina polytachia* and *M. ealiciifolia* is used in Peru as a substitute for soap. *Mundia spinosa*, a South African shrub, produces an eatable fruit.

**POLY'GAMOUS** (Gr. *polys*, many, *gamé*, marriage), in Botany, a term employed to designate those plants which produce both unisexual and hermaphrodite flowers either on the same or different plants. In the Linnæan sexual system, these plants formed a class, **POLYGAMIA**, the genera included in which were perhaps more completely disjoined from their natural allies than those of any other class of that system, forming by themselves a very heterogeneous assemblage.

**POLYGAMY**. See **MARRIAGE**.

**POLYGAM'STRICA**. See **INFUSORIA**.

**POLYGLOT** (Gr. *polys*, many; and *glotta*, tongue) means, in general, an assemblage of versions in different languages of the same work, but is almost exclusively applied to manifold versions of the Bible. The Hexapla (q. v.) of Origen contained, besides the Hebrew text, several other versions. All these, however, were in the Greek language; and the Hexapla is not commonly reckoned among the polyglots. They are divided into two classes, the greater and the lesser polyglots. To the former belong four works, known as the Complutensian Polyglot; the Antwerp or king of Spain's Polyglot; the Parisian Polyglot; and the London or Walton's Polyglot.—The Complutensian Polyglot derives its title from Complutum, the Latin name of Alcalá de Henares, where it was printed in 6 vols., folio, 1502—1517. It was published at the cost, and under the direction of the celebrated Cardinal Ximenes, who spared no expense, whether in collecting the most ancient and authentic MSS., or in bringing together the most distinguished scholars of all countries for the carrying out of his design. The Complutensian Polyglot contains, besides the Hebrew text, the Septuagint Greek and the Chaldee (each with a literal Latin version), and the Latin Vulgate.—The Antwerp Polyglot, so called from its being there printed (1569—1572), at the celebrated press of Plantin, was published at the cost of Philip II. of Spain, under the direction of the distinguished scholar, Benedict Arias Montanus. It is in eight vols. folio, and contains, in the Old Testament, the Hebrew, the Greek, the Targum of Onkelos, and the other Chaldee paraphrases, and the Latin Vulgate. In the New Testament, besides the Greek and Latin, it contains a Syriac version, printed both in Syriac and in Hebrew characters. Arias Montanus was assisted by many scholars of eminence, chiefly of Spain and the Low Countries.—The Parisian Polyglot was printed at Paris in 1645, at the cost and under the editorship of Guy Michel



le Jay. It is in ten splendid volumes, and contains, in addition to the contents of the Antwerp Polyglot, another Syriac version, and an Arabic version, together with the Samaritan version and the Samaritan text of the Pentateuch, each of these being accompanied by a literal Latin translation.—The London Polyglot was edited by Brian Walton, afterwards Bishop of Chester, and it engaged for many years a number of the most eminent linguists of the period. The number of its languages is not the same in all parts of the Bible; but it may be said to contain the Bible, or portions of it, in nine languages—Hebrew, Samaritan, Chaldean, Syriac, Arabic, Ethiopic, Persian, Greek (each of these accompanied by a literal Latin version), and Latin. It is in six vols. folio, and was published in 1654—1657; and was followed, in 1669, by the *Lexicon Heptaglotton* of Edmund Castell, two vols. folio, containing dictionaries of all the languages of the polyglot, except the Greek and Latin. Of the minor polyglots, the chief are (1) the Heidelberg Polyglot (1586), Hebrew, Greek, and Latin; (2) Wolder's Polyglot (Hamburg, 1596), Hebrew, Greek, Latin, and German; (3) Hutter's Polyglot (Nürnberg, 1599), Hebrew, Chaldean, Greek, Latin, German, and French; (4) Reineccius's Polyglot, in Syriac, Greek, Latin, and German (Leipzig, New Testament, 1712; Old Testament, 1750, 1751); (5) Bagster's Polyglot, a very valuable collection of modern versions, folio (London, 1831). It contains eight versions in the Old Testament, viz., Hebrew, Greek, English, Latin, French, Italian, Spanish, and German; and nine in the New, Syriac being added to those already named. (6) A useful 'Hand Polyglot,' containing in the Old Testament, Hebrew, Greek, Latin, Vulgate, and Luther's German version; and in the New, Greek, Latin, Luther's German, and in the fourth column, in which are presented the chief differences between this and other German versions.

Besides the Bible, many other works, or small pieces, have been published in polyglot. Of smaller pieces, the Lord's Prayer has been the favourite, of which many collections, containing a greater or less number of languages, have been published from the 16th c. downwards. Of these, the most comprehensive, and, for philological purposes, by far the most valuable, is the well-known *Mithridates* of Adelung, which contains the Lord's Prayer in upwards of 400 languages, with vocabularies and grammatical explanations of most of the specimens.

**POLYGNOTUS**, a distinguished Greek painter of antiquity, was born towards the beginning of the 5th c. B. C. He was a native of the isle of Thasos, and belonged to a family of painters, who came to Athens to practise their profession probably after the subjugation of Thasos by Cimon. P. and his brother, Aristophon, were instructed in the principles of art by their father, Aglaophon. We know almost nothing of their lives, except that P. was a friend of the Athenian general above mentioned, and is said to have been attached to his sister, Elpinice. He died about 426 B. C. P. was a contemporary of the great sculptor, Pheidias (q. v.), and flourished during the supremacy both of Cimon and Pericles; but we hear little or nothing of him under the latter ruler; and although the first painter of his day, it does not appear that he was engaged in the decoration of any of those splendid buildings with which that statesman adorned Athens. It is not at all unlikely that Pericles was averse to patronising a friend of Cimon, and, at all events, P. was absent from Athens for 14 years (449—435 B. C.) of Pericles's rule, painting at Delphi and elsewhere. His principal works (following a chronological arrangement as far as it can be

ascertained) were: 1. Paintings in the Temple of Theseus at Athens. 2. In the Stoa Poecile (or Painted Portico) at Athens, representing the Greek princes after the taking of Troy, assembled to judge of the violation of Cassandra by Ajax. 3. In the Anakeion, or Temple of the Dioscuri, a painting of the marriage of the daughters of Leukippos. 4. In the Temple of Athena Areia at Plataea, a picture of Ulysses after having slain the suitors of Penelope. 5. In the Leschê (or 'Conversazione Saloon'), a famous quadrangular court, or peristyle, surrounded by colonnades, built at Delphi by the Cnidians. The walls of this edifice were covered by P. with a series of paintings representing the wars of Troy, and the return of the Greek chiefs, and considered P.'s masterpiece. 6. In the chamber adjoining the Propylæa of the Acropolis. From the criticism of the ancients, it seems quite clear that P. was a great advance on any of his predecessors. He was the first who gave life, character, expression to painting. According to Pliny, he opened the mouth and shewed the teeth of his figures; he was the first to paint women with transparent drapery, and with rich head-dresses. Lucian also speaks of his exquisite skill in painting eyebrows and the blush on the cheek; while Aristotle extols the ethical or ideal beauty of his conceptions, saying that P. 'represented men as better than they were,' and finding a parallel for his style in the epic poetry of Homer.

**POLYGNON** (Gr. *polys*, many; *gônia*, a corner), a plane figure, bounded by a number of straight lines; the name is conventionally limited to those plane figures whose bounding straight lines are more than four in number. Polygons of 5, 6, 7, 8, &c. sides are denominated pentagons, hexagons, heptagons, octagons, &c.; and when the number of sides exceeds twelve, the figure is merely mentioned as a polygon of so many sides. The quindecagon, or figure of 15 sides, is the only common exception to this rule. Polygons have many general properties; such as, that the sum of the angles of a polygon, when increased by four right angles, or 360°, is equal to twice as many right angles as there are sides in the polygon, and that (supposing the number of sides of the polygon to be expressed by  $n$ ) the number of its diagonals is  $\frac{n(n-3)}{2}$ ; also

if a polygon of an even number of sides be circumscribed about a circle, the sums of its even and odd sides are equal; and if a polygon of an even number of sides be inscribed in a circle, the sums of its even and odd angles are equal. A polygon which has all its sides and angles equal is called a *regular* polygon. All polygons of this class are capable of being inscribed in, or circumscribed about, a circle; but though the problem is merely to divide the circumference of a circle into a number of equal parts corresponding to the number of sides in the polygon, geometry was till lately only able to perform it in those cases where the number of sides of the polygon belongs to one or other of the series 2, 4, 8, 16, &c.; 3, 6, 12, 24, &c.; or 5, 10, 20, 40, &c. Gauss (q. v.), however, in the beginning of the present century, shewed how it could be done in the case of all polygons the number of whose sides was of the form  $2^n + 1$  (provided it be a prime number), or a multiple of this prime number by any power of 2. This discovery supplies us with innumerable series representative of the numbers of the sides of polygons which can be described around or inscribed in a circle, such as 17, 34, 68, &c.; 257, 514, 1028, &c.

**POLYGNONÆ**, or **POLYGNONACEÆ**, a natural order of exogenous plants, mostly herbaceous plants, but including a few shrubs, and even trees. The

leaves are alternata, sometimes without stipules, but more generally with stipules cohering around the stem. The flowers are not unfrequently unisexual. They have an inferior, often coloured perianth, generally in four, five, or six segments; three to nine stamens inserted into the bottom of the perianth; a one-celled ovary, usually formed of three carpels, but containing only one ovule; styles and stigmas as many as the carpels of the ovary; the fruit generally a nut, often triangular, the seed with farinaceous albumen, which has an economic importance in buckwheat. A few species produce a succulent edible fruit. The order contains nearly 500 known species, natives of almost all parts of the world, but particularly abundant in the temperate regions of the northern hemisphere. Many of the species are common weeds in Britain, as different species of Dock (q. v.) and *Polygonum*. Bistort (q. v.), Buckwheat (q. v.), and Sorrel (q. v.), belong to this order.—The genus *Polygonum* has a coloured perianth of five segments, stamens in two rows, styles more or less united at the base, and two or more in number; the fruit invested by the persistent perianth. The species are very numerous. A number are natives of Britain.—KNOT-GRASS (*P. aviculare*), a very common British weed, is one of the plants remarkable for most extensive distribution over the world. It is an annual of very humble growth, but very variable, with much branched trailing stems, small lanceolate leaves, and very small flowers, two or three together, in the axils of the leaves. Thunberg says that in Japan a blue dye is prepared from this plant. *P. amphibium*, one of the species often called *Persicaria*, is abundant about margins of ponds and ditches in Britain and throughout Europe, and is remarkable for the difference between the leaves which float on the water, as is often the case, and those on stems growing erect, those of the former being broad and smooth, those of the latter narrow and rough; the spikes of flowers being also of somewhat different form, and the stamens in the flowers of the floating stems shorter than the perianth, in the upright stems about as long as the perianth; differences which might be held to indicate different species, yet both may be found growing from one root. The stems have been used on the continent of Europe as a substitute for sarsaparilla. Some other species are occasionally used for medicinal purposes. *P. hydropiper*, often called WATER PEPPER, a plant common by sides of lakes and ditches in Britain, is acrid enough to be used as a vesicant. Several species are occasionally used for dyeing, as the SPOTTED PERSICARIA (*P. persicaria*), a very common weed on dunghills and in waste places in Britain; but the only species really important on this account is that called DYERS' BUCKWHEAT (*P. tinctorium*), a native of China, biennial, with ovate leaves and slender spikes of reddish flowers, the cultivation of which has been successfully introduced in France and Flanders. It yields a blue dye scarcely inferior to indigo.—*P. orientale* has long been occasionally cultivated in flower-gardens in Britain, and is quite hardy, although a native of the West India.—*Fagopyrum cymosum*, a species of buckwheat abundant on the mountains of the north of India, affords an excellent substitute for spinach.—*Mihlenbeckia adpressa* is the Macquarrie Harbour Vine of Van Diemen's Land, an evergreen climbing or trailing shrub of most rapid growth, sometimes 60 feet in length. It produces racemes of fruit somewhat resembling grapes or currants, the nut being invested with the large and fleshy segments of the calyx. The fruit is sweetish and subacid, and is used for tarts. *Coccoloba uvifera* is the

SEASIDE GRAPE (q. v.) of the West India. See also CALLIGONUM.

POLYHYMNIA, or POLYMNIA ('the Many-hymned One'), one of the nine Muses (q. v.). She was reputed by the ancients to be the inventress of the lyre, and to preside over lyric poetry and eloquence. In works of art, she is usually represented in a pensive attitude, with the forefinger of the right hand upon the mouth.

POLYMERISM, a form of ISOMERISM (q. v.).

POLYNEMUS and POLYNEMIDÆ. See MANGO FISH.

POLYNESIA, or the region of many islands (Gr. *polys*, much or many, and *nesos*, an island), is the name usually given, with more or less of limitation, to the numerous groups of islands, and some few single islands, scattered throughout the great Pacific Ocean, between the eastern shores of Asia and the western shores of America. In its widest signification, the term P. might be understood as embracing, besides the groups hereafter to be mentioned, the various islands, large and small, of the Indian Archipelago, in one direction; and the vast island of New Holland or Australia, with its dependency of Van Diemen's Land, in another. Including these, the whole region has sometimes been called Oceania, and sometimes Australasia—generally, however, in modern times, to the exclusion of the islands in the Indian Archipelago, to which certain writers have given the name of Malaysia. In proportion, also, as the area of maritime discovery has become enlarged, it has been thought convenient by some geographers to narrow still further the limits of P., to the exclusion of Australia and Van Diemen's Land; while others, again, exclude Papua or New Guinea, New Ireland, Solomon's Isles, the Louisiade group, the New Hebrides, New Caledonia, and certain other groups and single islands, together with New Zealand, from the area of P., and give to these, in union with Australia, the collective designation of Australasia. To all these, with the exception of New Zealand, French writers have given the name of *Melanesia* or the *Black Islands*; while a similar name, *Kelenonesia*, has been given to them by Prichard and Latham—purely, however, on ethnological grounds, as we shall presently notice.

Thus, we have the three geographical divisions of Malaysia, Australasia, and P., the last mentioned of which embraces all the groups and single islands not included under the other two. Accepting this arrangement, still the limits between Australasia and P. have not been very accurately defined; indeed, scarcely any two geographers appear to be quite agreed upon the subject; neither shall we pretend to decide in the matter. The following list, however, comprises all the principal groups and single islands not previously named as coming under the division of Australasia: viz., 1. North of the equator—The Ladrone or Marian Islands, the Pelew Islands, the Caroline Islands, the Radack and Ralick chains, the Sandwich Islands, Gilbert's or Kingsmill's Archipelago, and the Galapagos 2. South of the equator—The Ellice group, the Phoenix and Union groups, the Fiji Islands, the Friendly Islands, the Navigator's Islands, Cook's or Harvey Islands, the Society Islands, the Dangerous Archipelago, the Marquesas Islands, Pitcairn Island, and Easter Island.

These islands, which extend from about 20° north of the equator to about 30° south of it, are some of them volcanic in their origin, and some of them coralline. The volcanic islands generally rise to a considerable height above the level of the ocean, and are therefore called the high

islands, in contradistinction to the coralline or low islands. They consist of basalt and other igneous formations. Of these, the principal are the Friendly Islands, one of which, Otaheite or Tahiti, has a mountain rising to the height of 10,000 feet; the Marquesas Islands, also very high; the Samoan or Navigator's Islands; and the Sandwich Islands, of which Owyhee or Hawaii possesses several both active and extinct craters, 13,000, 14,000, and even 16,000 feet high. The Galapagos group, nearest of all to South America, are likewise of igneous origin, and have several still active craters. The remaining islands are for the most part of coralline formation.

The coral islands (q. v.) may be distinguished into three classes—namely, atolls or lagoon islands, barrier reefs, and fringing reefs. The atolls are rings of coral reefs, surrounding a basin of sea-water of considerable depth, which is enclosed within this area. Examples of these are found in the Caroline Islands, the Dangerous Archipelago, and several other groups. Barrier reefs differ from the atolls chiefly in the fact of their containing an island in their centre, the island being separated from the reef by a body of deep water; while the reef is in some instances entirely converted into land, and in others the sea washes over it, except in certain portions, which project above the level of the ocean. Barrier reefs occur among the Society Islands, the Gambier Islands, and many other groups. Fringing reefs are collections of coralline formation, which are found skirting the coasts of an island in the same manner as the barrier reefs, but without any interior deep water channel. They are found in almost all the groups. From the fact of some of these islands being undoubtedly volcanic, it has been argued that all were originally of the same character; those of coralline formation being based upon the crests of submarine volcanoes, over which the coral insects have for an indefinite series of years been engaged in rearing their limestone structures. In opposition to the volcanic theory, Dr Darwin has propounded one of his own—namely, the theory of subsidence, which, after mature consideration, he believes to be the only one capable of explaining the various phenomena observable in the coral atolls, barrier reefs, and fringing reefs of the Pacific. All these he considers as being the production of saxigenous insects, working upwards from the foundations of what were originally so many islands, erect above the surface of the ocean, but which during long ages have been in a state of gradual subsidence. With respect to the atolls, he states it as his belief, that the lagoon is precisely in the place which the top of a shoal, and, in other cases, the highest part of an island, once occupied. So soon as these have sunk to a depth of from 120 to 180 feet below the surface, the coral insects (which it is agreed are never found at a lower depth) commence their operations, and these working on in countless myriads, the sunken island, or a portion of it, is in process of time again reared to the level of the surrounding sea. It would take too long to specify all the phenomena upon which Dr Darwin has based this ingenious theory, especially those connected with what are called the fringing reefs. It must be mentioned, however, that paradoxical as such a theory may seem, it has received the hearty support of no less distinguished a geologist than Sir Charles Lyell, who, in the early editions of his *Principles of Geology*, having held to the volcanic theory, has since abandoned it for that propounded by Dr Darwin. Nor is this all; for, in the last edition of Sir C. Lyell's work, we find him mentioning with approval Dr Darwin's important generalisation that the Pacific and Indian Seas, and some of the lands which border them, might

be divided into areas of elevation and areas of subsidence, which occur alternately.

Of the islands generally, we need only further observe that, although situated within the tropics, the heat of the atmosphere is delightfully tempered by a succession of land and sea breezes. The soil is exceedingly fertile, and besides the vegetable productions found growing when the islands were first discovered by Europeans, it has given a welcome home to the orange, lemon, sugar-cane, guava, cotton, potato, melon, and other fruits and plants introduced by foreign visitants. The only native quadrupeds on any of the islands when first visited were pigs, dogs, and rats; but the ox, the sheep, the goat, and even the horse, have since been successfully introduced into many of the groups. The feathered tribes are numerous, likewise the insects, and the coasts everywhere abound with a vast variety of fish and crustacea, highly important as a matter of food to the inhabitants of those islands in which quadrupeds, whether native or introduced, are found in only a small number.

For a more particular description of the several groups, we refer to the distinct articles of *FUTS*, *FRIENDLY ISLANDS*, *SANDWICH ISLANDS*, &c.; and shall now proceed to speak of the inhabitants generally under the head

**POLYNESIANS.**—This race of people, supposed at one time by certain writers to be of American origin, is now almost universally admitted to have a close affinity with the Malays of the peninsula and Indian Archipelago, and hence is classified with them by Dr Latham under his subdivision of *Oceanic Mongolida*. In physical structure and appearance, the Polynesians in general more nearly resemble the Malays than they do any other race, although differing from them in some respects, as, indeed, the natives of several of the groups also do from each other. In stature, they are generally taller than the Malays, and have a greater tendency to corpulence. In colour, also, they more nearly approach that of the Europeans. The hair is often waved or curling, instead of long and straight, and the nose is frequently aquiline. These differences, however, which may all have been produced by lapse of time and different conditions of existence, offer no barrier to the strong presumption, that at some long antecedent period these islands were colonised by Malay adventurers. The Malays are known at the present time to be expert and daring sailors, and in the 16th c. were so powerful at sea, that they had frequent naval combats with European fleets in the Indian Archipelago. In 1573, the king of Acheen, with a powerful armament, attacked and destroyed three Portuguese frigates; and in 1582, the same king attacked Malacca with a fleet of 150 sail. At a later period—namely, in 1615, one of his successors attacked the same settlement with a fleet of 500 vessels of various sizes and 60,000 men. If this was their strength and enterprise at a comparatively modern period, may they not have been as enterprising, if not quite so powerful, in far more remote times? The distance between the more western groups of P. and the eastern islands of the Indian Archipelago is not so great but that it could have been easily overcome by a hardy race of sailors, even although their vessels may have not been so well constructed as in modern times; and the same reasoning holds good with respect to the other groups extending still further east, or still more to the north or south. Each island or group, as it was attained, would only form a convenient point of departure in process of time for some other island or group more remotely situated. It is true that the affinities of language are not great between the Malays and the Polynesians; still, some affinity

has been recognised by philologists; while in their manners and customs a strong resemblance has been shewn to exist, as in the institution of caste, the practice of circumcision, the chewing of the betel-nut, and other things. Many other facts might be mentioned in favour of the theory of a Malay settlement, not only of P., but of the islands called Melanesia or Kelenonesia as well; the last mentioned being inhabited by a race almost identical with the Negritos or Pelagian Negroes of the Eastern Archipelago. Dr Latham, in treating of the Polynesians, divides them into two branches—viz., 1. The Micronesian branch, and 2. The Proper Polynesian branch. His theory as to the probable line of migration is as follows: 'The reason for taking the Micronesian branch before the Proper Polynesian, involves the following question: What was the line of population by which the innumerable islands of the Pacific, from the Pelews to Easter Island, and from the Sandwich Islands to New Zealand, became inhabited by tribes different from, but still allied to, the Protonesian Malays? That line, whichever it be, where the continuity of successive islands is the greatest, and whereon the fewest considerable interspaces of ocean are to be found. This is the general answer *à priori*, subject to modifications from the counterbalancing phenomena of winds or currents unfavourable to the supposed migration. Now, this answer, when applied to the geographical details regarding the distribution of land and sea in the great oceanic area, indicates the following line: New Guinea, New Ireland, the New Hebrides, the Fijis, and the Tonga group, &c. From hence, the Navigator's Islands, the isles of the Dangerous Archipelago, the Kingsmill and other groups, carry the frequently diverging streams of population over the Caroline Islands, the Ladrões, the Pelews, Easter Island, &c. This view, however, so natural an inference from a mere land and sea survey, is complicated by the ethnological position of the New Guinea, New Ireland, and New Hebrides population. These are *not* Protonesian, and they are not Polynesian. Lastly, they are not intermediate to the two. They *break*, rather than propagate the continuity of the human stream—a continuity which exists geographically, but fails ethnographically. The recognition of this conflict between the two probabilities has determined me to consider the Micronesian Archipelago as that part of Polynesia which is most likely to have been first peopled, and hence a reason for taking it first in order.' The islands comprised in the Micronesian branch are the Pelew Islands, the Caroline Islands, the Marian Islands, and the Tarawan or Kingsmill group. In physical appearance, the inhabitants of these groups more nearly resemble the Malays than is the case with the Polynesians Proper. In person, they are not so tall as the latter. Their language has numerous dialects, most of which would perhaps be unintelligible to the groups further south and east. In religion, they are pagans; but their mythology and traditions differ from those of the Polynesians Proper. Neither is the custom of the taboo and the use of kawa so prevalent as they are found to be among the latter. The Proper Polynesians, so called, are found in the Fiji Islands, but not to the same extent as in the following—viz., the Navigator's or Samoan Islands, the Society Islands, and Friendly Islands; also in the

Sandwich Islands, the Marquesas, the Dangerous Archipelago, &c. In physical appearance, they are the handsomest and tallest of all the natives of the Pacific Islands, with the exception, perhaps, of the New Zealanders or Maoris. The aquiline nose is commonly seen among them, and there are many varieties both of hair and complexion. Their face is generally oval, with largish ears and wide nostrils. In the islands nearest to the equator, the skin is said to be the fairest, and it is darker in the coral islands than in the volcanic. Their language is said to bear some affinity to the Tagala, and is split up into numerous dialects, all, however, to a great extent mutually intelligible among the several groups. Paganism, originally prevalent among all the groups, is becoming gradually extirpated through the efforts of the missionaries, principally English and American, as in the Samoan, Sandwich, and Society groups, where but few absolute pagans now remain. The superstition of the taboo, the use of kawa as an intoxicating drink, cannibalism, infanticide, tattooing, and circumcision, which were also formerly prevalent in all the groups, are now fast disappearing, under the influence of Christianity. Unfortunately, however, the contact of these islanders with civilisation has not been always productive of unmixed good; the introduction among them of the use of ardent spirits, and of the vices and diseases of Europeans, having thinned the population to a lamentable extent. Further particulars with respect to the natives of P. will be found in some of our articles on the groups regarded as being the most important.

**POLYPHEMUS**, in the Homeric mythology, the son of Poseidon and the nymph Thoosa, the most celebrated of the fabulous Cyclops (q. v.), who inhabited the island of Sicily. He was of immense size, and had only one eye. When Ulysses landed on that island, he entered the cave of P. with twelve companions, of which number this tremendous cannibal ate six. The others stood expecting the same fate, but their cunning leader filled P. drunk, then burned out his single eye with a blazing torch, and so escaped, leaving the blinded monster to grope about in the darkness.

**POLYPHEMUS**, a genus of *Branchiopoda* (q. v.), of the order *Cladocera*, remarkable for the extraordinary size of the solitary eye, which occupies almost the whole head. One species, *P. stagnorum*, is common in stagnant pools and ditches in some parts of Britain and of the continent of Europe. It is about the size of a flea, and moves rapidly in the water, executing all kinds of evolutions, employing both its legs and antennæ as organs of swimming. The shell, consisting of two pieces, is so transparent that all the viscera may be seen through it. The abdomen is terminated by a long tail suddenly folded back.

**POLYPHONIC** (Gr. *polys*, many, and *phoné*, voice). When a musical composition consists of two or more parts, each of which has an independent melody of its own, it is said to be polyphonic, in opposition to a homophonic composition, consisting of a principal part with a leading idea, and accessory parts employed to strengthen it. Each part of a polyphonic composition aims at melodic perfection, and while supporting the other, has an equal share in the entire effect, as in the following example:



## POLYPL.

A Fugue (q. v.) is the most perfect example of polyphonic composition. The difference between homophonic and polyphonic compositions is not always so marked as to leave it free of doubt whether a part is subordinate or independent; and many compositions consist of an alternation of homophonic and polyphonic passages. The construction of polyphonic phrases is called Counterpoint.

POLYPLI, or POLYPES, a class of animals which were, till the last few years, included in the RADIATA of Cuvier, but which, since the Radiata have ceased to be regarded as a sub-kingdom, have found a place in the sub-kingdom CELENERATA. See SUB-KINGDOMS, ANIMAL. The name *Polypli*, or *Polypes*, was given by Reaumur about the middle of the last century to these animals, on account of their external resemblance to the many-armed cuttle-fishes, which were so denominated by Aristotle; and our knowledge of these organisms, as members of the animal kingdom, hardly dates back much more than a century. All polypes are aquatic in their mode of life, and almost all of them are inhabitants of the sea, two genera only (*Hydra* and *Cordylophora*) of fresh-water polypes being as yet known. Most of them live in societies of considerable extent, supported on a common stock, to which the term *polypidom* (polyp-home) is usually given, and which is sometimes horny, and sometimes calcareous. The polypes are either embedded in cavities in the substance of the calcareous polypidom, or enclosed in minute cups or tubes, from which the body can be protruded, and into which it can be retracted at pleasure, in the horny polypidoms. The solitary species often attain a considerable size (as, for instance, many of the Actinias); but the social polypes are always minute, although the combined power of some of the species in modifying the earth's crust is neither slight nor limited in extent. 'They have built up a barrier reef along the shores of New Caledonia for a length of 400 miles; and another, which runs along the north-east coast of Australia, 1000 miles in extent. To take a small example: a single atoll (or coral island) may be 50 miles in length by 20 in breadth; so that if the ledge of coral rock forming the ring were extended in one line, it would be 120 miles in length. Assuming it to be a quarter of a mile in breadth, and 150 feet deep, here is a mound, compared with which the walls of Babylon, the great wall of China, and the pyramids of Egypt are but children's toys; and built, too, amidst the waves of the ocean, and in defiance of the storms.'—Owen, *Lectures on the Invertebrate Animals*, 2d edit., p. 143.

The bodies of these animals are generally soft, and cylindrical or oval in shape; and the mouth, which is the only aperture of the digestive canal, and is quite destitute of any masticating apparatus, lies in the centre of the anterior or free extremity of the body, and is surrounded by a fringe or circle of tentacles or arms. The skin in the social polypes is exceedingly soft and delicate; but in the solitary species, it is often of a leathery consistence. It almost always contains peculiar urticating organs, or thread-like cells, which may be regarded as one of the distinctive characters of the Coelenterata. Various arrangements of the polypes have been proposed, but it is sufficient for all practical purposes if we admit two orders—namely, the *Hydrozoa* and the *Anthozoa* (or *Actinozoa*), which differ essentially in the following points: in the *Hydrozoa*, the wall of the digestive sac is not separated from that of the somatic (or bodily) cavity, and the reproductive organs are external; while in the *Anthozoa*, the wall of the digestive sac is separated from that of the somatic cavity by an intervening space,

subdivided into chambers by a series of vertical partitions, on the faces of which the reproductive organs are developed. The HYDRA (q. v.), or Fresh-water Polype, is the type of the *Hydrozoa*. A few of these polypes are simple animals, as, for example, *Hydra*, *Corymorpha*, *Vorticifera*, and *Myriothela*; but the greater number are compound or composite, exhibiting a numerous colony, connected with one another by a common trunk or *caecocarc* (from the Gr. *koinos*, common, and *carx*, flesh), which usually presents an erect tree-like form. A sufficient idea of the form and structure of the simple polypes of the class will be obtained by a reference to the article HYDRA, and by a glance at the accompanying figure of *Corymorpha nutans*, which attains a length

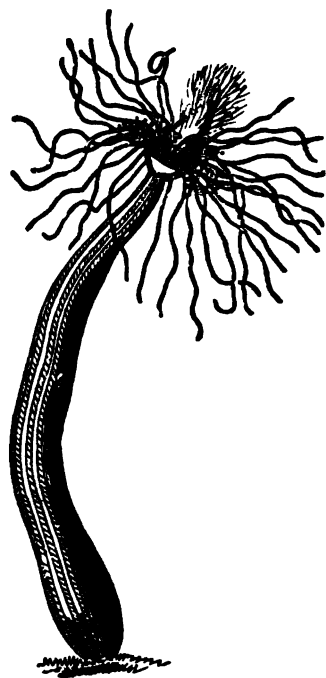

Fig. 1.—*Corymorpha nutans*.

of between four and five inches, and was discovered by Forbes and Goodsir when dredging in the north of Scotland. They observe, that when it was placed in a vessel of sea-water, it presented the appearance of a beautiful pink flower, its head gracefully nodding (whence the specific name given to it by Sars, who had previously discovered it on the Norwegian coast), and bending the upper part of the stem; it waved its long white tentacles to and fro at pleasure, but seemed to have no power of contracting them. The compound *Hydrozoa* include, *inter alia*, the orders *Sertularida* (embracing the various species of *Sertularia*, *Campanularia*, *Lammedea*, &c.) and *Tubularida* (embracing the various species of *Tubularia*, *Eudendrium*, *Bimeria*, &c.). A good idea of the nature of the compound *Hydrozoa* may be formed from the consideration of the *Campanularia dichotoma*, a common organism on our shores. The compound polype-animal, or association of polypes, resembles a miniature tree. It consists essentially of a ramified tube of irritable matter, defended by an external flexible, and frequently jointed horny skeleton, *a*; and is fed by the activity of the tentacula, *d*, and by the digestive powers of

the alimentary sacs (*g*) of a hundred polypi, the common produce of which circulates through the tubular cavities for the benefit of the whole community. The soft integument of the nutrient polypes (*d, e, g*) contains the thread-cells, to which



Fig. 2.—*Campanularia dichotoma*, magnified.

allusion has previously been made. These are protruded when the skin is irritated, and give the tentacles the appearance of being beset by minute bristles. The digestive sac of each polype is lined by a ciliated epithelium; but there is a perforation at the base communicating with the central tube, *f*. This outlet admits only of the passage of the fluid contents of the stomach, undigested matters being ejected by the mouth. There is reason to believe that sea-water enters the branches of the tube *f*, and circulates, by means of the ciliated epithelium, through the compound organism; and by this means contributes to the respiratory process. 'At certain points of these ramified polypes,' says Professor Owen, 'which points are constant in and characteristic of each species, there are developed little elegant vase-shaped or pod-shaped sacs, which are called the ovigerous vesicles, or *ovicapsules*. These are sometimes appended to the branches, sometimes to the axilla, as at *h, i, k* (in fig. 2). They are at first soft, and have a still softer lining membrane, which is thicker and more condensed at the bottom of the vesicle. It is at this part that the ova or germs are developed, and for some time these are kept in connection with the vital tissue of the polype by a kind of umbilical cord. In all the compound *Hydrozoa*, the *ovicapsules* are deciduous; and having performed their functions in relation to the development of the new progeny, drop off like the seed-capsules of plants.' On other individuals of the same species, sperm-capsules are developed, which, in form, resemble the *ovicapsules*, but in place of ova, contain spermatozoa. The act of fertilisation in most cases occurs by diffusion of the spermatozoa in the surrounding water. There is much that still requires elucidation in reference to the various modes of reproduction of this class. Many of the *Hydrozoa* have been shewn to be merely larval forms of *Medusæ*. See GENERATIONS ALTERNATION OF.

The leading anatomical distinction between the *Anthozoa*, or *Actinozoa*, and the *Hydrozoa* has been already noticed. The common *Actinia* (*q. v.*) may be regarded as the type of this class, all of which

are marine, and principally inhabit the warmer or tropical seas. Many of the larger tropical polypes of this class combine with a structure similar to that of the *Actinia* an internal calcareous axis or skeleton, which, penetrating into the interior of the organism, presents the lamellated and radiated structure recognisable in the *Fungia*, and in the skeletons of *Caryophylla*, *Madrepora*, &c. Such *Anthozoa* are termed coralligenous; and every hard structure deposited in or by the tissues of this class, and forming a uniform framework, is recognised by zoologists as a coral. Like the members of the preceding class, many of the *Anthozoa* multiply freely by gemmation, complex or compound animals or colonies of animals being formed, in which individual polypes are united by a *cenosarc* or polypidom. For a description of the mode in which communication takes place between the common body or mass and the individual polypes, we must refer to the article *ALCYONIUM*. Various arrangements of this class have been proposed by zoologists. If we exclude the consideration of fossil genera, we may divide the *Anthozoa* into two orders—the *Alcyonaria* and the *Zoantharia*.

The *Alcyonaria* may be characterised as *Anthozoa* in which each polype is furnished with eight tentacles, not simple, as in *Actinia*, but furnished with pinnate margins, with eight somatic chambers, and eight mesenteries. With the exception of one genus, they are all composite in structure; their polypes being connected with one another by a *cenosarc*, which is traversed by prolongations of the somatic cavity of each polype, a system of canals being thus formed whose parts freely communicate and are readily distensible. Carus, in the *Handbuch der Zoologie*, 1863, vol. 2 (of which he is joint author with Peters and Gerstaecker), mainly adopting Milne-Edwards's arrangement, divides the *Alcyonaria* into the three following families: 1. *Alcyonidae*; 2. *Gorgonidae*; 3. *Pennatulidae*. In the

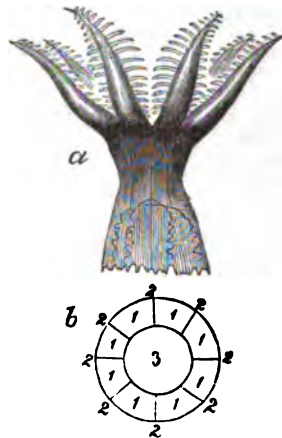

Fig. 3.—Diagram illustrating the Morphology of *Anthozoa*.

*a*, polype of *Alcyonium*; *b*, ideal section of the same; 1, 1, 1, &c., the somatic cavity, divided by the mesenteries, 2, 2, 2, &c., into eight chambers; 3, the digestive cavity.

*Alcyonidae*, he includes the beautiful organ-pipe corals, of which Green and others make a separate family. The polypidom constructed by *Tubipora musica* consists of successive stages of cylindrical tubes of a rich crimson colour, united at various heights by means of horizontal connecting plates. The tubes placed upon the upper stage are alone

inhabited by living polypes, of a violet or green colour, the occupants of those below having successively perished as fresh generations appeared



Fig. 4.—*Tubipora musica*.

above them. As an example of the *Gorgonida*, we may take *Isis hippuris*, in which the skeleton is made up of alternate joints of calcareous and horny

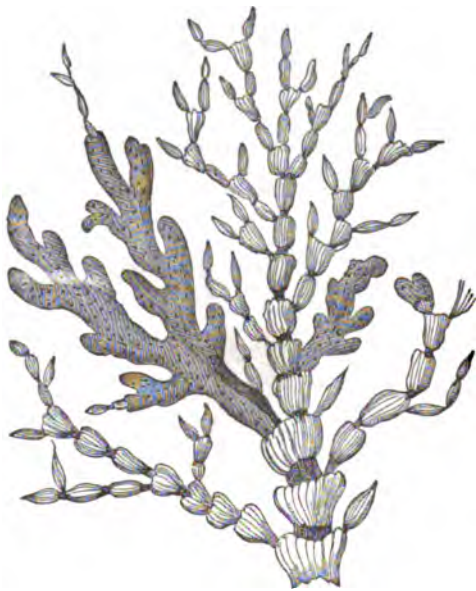

Fig. 5.—*Isis hippuris*.

matter, with the view of giving the necessary flexibility. In the *Pennatulidæ*, the polypidom is free, and no polypes are attached to its basal portion. The *Sea-pens* (*Pennatulæ*) of our own coast afford a good example of this family. See PENNATULA for description and figure.

The *Zoantharia* may be characterised as Anthozoa in which the tentacles are either simple or branched, in general numerous, and together with the mesenteries, disposed in multiples of five or six. They may be arranged in the three following sub-orders—1. *Z. Malacodermata*; 2. *Z. Sclerobasica* or *Antipatharia* (Milne-Edwards); and 3. *Z. Sclerodermata* or *Madrepores*. The first sub-order has been variously subdivided into families and sub-

families, which it is unnecessary to notice. It contains all the sea-anemones and animals allied to them, including the genera *Actinia*, *Anthea*, *Corynactis*, *Capnea*, *Adamsia*, *Ilyanthus*, *Sagartia*, *Bunodes*, *Edwardsea*, *Peachia*, &c.; and the *Zoanthida*, which are aggregated polypes arising from a common creeping root-like fleshy band, and of which at least one species, *Zoanthus Couchii*, is an inhabitant of the British sea. All the members of the second sub-order are composite structures. *Antipathes*, the type of the group, presents a stem-like, simple, or branching œnosarc, which in one species tapers to a length of more than nine feet, with a diameter, at the base, not exceeding three-tenths of an inch. The third sub-order (the *Madrepores*) is a very extensive one. It is divided into the *Madrepora aporosa* and *M. perforata*, according as the coral exhibits a solid or a porous structure. *M. aporosa* may be arranged in the following families—1. *Turbinolida* (including the sub-families *Caryophyllina* and *Turbinolina*); 2. *Oculinida*; 3. *Astræidæ*; 4. *Echinoporina*; 5. *Merulinacea*; 6. *Fungida*: while the *M. perforata* are divided into (1) *Madreporida* and (2) *Poritida*. A few of the commoner forms of *Madrepora* are delineated in the articles CORAL and MADREPORE. Amongst the most important works on this department of zoology may be mentioned Dana's *Structure and Classification of Zoophytes* (Philadelphia, 1846), and his *Report on Zoophytes*, and *Atlas of Zoophytes* (U.S. Exploring Expedition), 1849; Johnston's *British Zoophytes*, in 2 vols., to which we are indebted for many of our illustrations; Milne-Edwards and Haime, *Histoire Naturelle des Coralliaires ou Polypes proprement dits* (3 vols., 1857—1860); and Lacaze-Duthiers, *Histoire Naturelle du Corail, Organisation, Reproduction, &c.* (1864).

**POLYPODIUM**, a genus of Ferns, with spore-cases on the back of the frond, distinct, ring-shaped, in roundish sori, destitute of *indusium*. Several species, differing very considerably in appearance, are natives of Britain, where no fern is more common than *P. vulgare*. It grows on rocks, trees, dry banks, &c., and has fronds 2—18 inches long, deeply pinnatifid, with large sori.—*P. Dryopteris*,



Polypodium:

1, *P. dryopteris*; 2, *P. vulgare*.

with delicate ternate bipinnate fronds, is a fine ornament of many dry stony places in Scotland.—*P. Calaguala*, a native of Peru is said to possess

important medicinal properties—solvent, deobstruent, sudorific, &c.

**POLYPORUS.** See **AMADOU** and **DRY ROT**.

**POLYPTERUS**, a genus of fishes, ranked by Cuvier among malacopterous fishes and in the family *Clupeidae*, notwithstanding very important differences of structure; but now constituted by Müller and others into a family, *Polypteridae*, of the order of Ganoid Fishes. The shape is round and elongated; the head defended by large bony plates, the body covered with large and strong ganoid scales, which are very closely affixed to the skin. These curious fishes, existing remains of a type which was prevalent in former geologic periods, inhabit the rivers of Africa, and lodge in the soft mud. Their flesh is very pleasant. The P. of the Nile, called *Bichir* by the Egyptians, is said to be one of the finest fishes of that river. It is about 18 inches long.

**POLYPUS**, in Surgery, is an antiquated term employed to signify any sort of pedunculated tumour attached to a surface to which it was supposed to adhere like a many-footed animal, as its name indicates. The most common seat of polypus is the mucous membrane, especially that of the nostrils and uterus; but these tumours are also found in the rectum, the larynx, and the external auditory passage of the ear. The only satisfactory mode of treatment consists in their removal, which must be effected in various ways, according to their position, as by the forceps, the *ecraseur* the ligature, &c.

**POLYSTYLE**, a term applied to a building with a number of columns, but not the strict number of any of the classic arrangements.

**POLYTECHNIQUE** (*ÉCOLE POLYTECHNIQUE*), or **POLYTECHNIC SCHOOL** (Gr. *polys*, many; *techné*, art), was first established in Paris (1794) by the National Convention, under the name of *Ecole des Travaux publics* (School of Public Works). No students were admitted but those who intended to enter the public service; and though the general object of the institution was the supplying of well-educated youths to all branches, it was more particularly devoted to the thorough instruction of recruits for the corps of civil and military engineers. The institution received the name of 'Ecole Polytechnique' in 1795. The pupils were at first 349 in number, and each received, during his stay of two years in the institution, an annual stipend of 1200 francs (£48 nearly); the teachers were in most cases the most eminent savans of France—Lagrange, Prony, Monge, Hachette, Say, Vauquelin, Berthollet, Pelletier, &c., being among the number of the professors at the commencement. There was also in connection with the school a periodical called the *Journal Polytechnique*, valuable for its excellent memoirs of the professors and the more eminent pupils. In 1799, some modifications were introduced into the working of the school; the number of pupils was at the same time limited to 200, and they were put into uniform. The advantages of an institution of this sort, when ably conducted, soon made themselves evident, and the P., in consequence, rose into high estimation, not only in France, but throughout Europe, so much so, that it became common for foreign nations, when entering into a treaty with France, to stipulate for the admission of a certain number of their subjects into the institution, after passing the prescribed entrance examination. In 1804, the Emperor Napoleon introduced various modifications into its working, and gave it a military organisation; it was also removed from the Palais-Bourbon (where it had existed from its first establishment) to the old college of Navarre. One

of the new regulations was the obligation imposed upon each pupil of paying a sum of 800 francs (£32) to the institution, and also providing himself, at his own expense, with all the necessary books and instruments; but, at the same time, great liberality was shewn to deserving applicants who could not conform to this regulation; and some years later, an annual grant of 30,000 francs was made by government for their benefit, and for pensions to old pupils. The number of teachers was also increased, and all the pupils were regularly drilled, especially in the use of fire-arms and the working of heavy ordnance. The institution became more and more, as the end of the Napoleonic empire drew near, a training-school for young artilleryists and engineers; and such was the enthusiasm of the pupils in the Emperor's cause, that, after the disasters of 1814, they demanded to be enrolled *en masse* in the ranks of the French army. However, Napoleon was (to use his own words) not inclined 'to kill the hen for the golden eggs;' but he allowed them to form three out of the twelve companies of which the artillery corps of the national guard was composed. These three companies rendered important service in manning the walls of Paris, and behaved heroically in the battle of March 30, 1814. After the first Restoration, the P. being considered to be evil-disposed to the government, suffered considerable reductions; but was restored to its former importance for the brief period of the 'Hundred Days.' After the second Restoration (July 1815), the staff of professors was remodelled; Lacroix and some others were dismissed, and replaced by Poisson, Arago, Cauchy, &c. Notwithstanding these changes, the government still had its doubts as to the loyalty of the establishment, and took advantage of an outbreak, April 3, 1816, to break it up. It was reconstituted in September of the same year, under a revised code of regulations, and in 1822, the old severity of military discipline was restored. Since this time, it has preserved its loyalty to the government, and the pupils have taken an active part in the various revolutions in Paris. Its constitution, which has so frequently suffered change, was finally amended, November 1, 1852. The rules now are—1. No pupil can be admitted unless he has been successful in the public competitive examination which is held each year, the subjects and date of the examination being previously published by a decree of the Minister of War. 2. The conditions of admission to the competitive examination are, that the candidate shall be a Frenchman; that he shall be more than 16, and less than 20 years of age, on the 1st of January of that year. 3. Regular soldiers are admitted up to the age of 25 years, provided they have been on real and effective service for two years. 4. The entrance-charge is 1000 francs (£40) per annum, and the cost of outfit (to be also paid by the pupil) is determined each year by the Minister of War. 5. The duration of the course of instruction is two years; the pupils, after finishing their course, must pass a final examination; the successful candidates, if found to be physically qualified, are arranged in order of merit, and choose in order what branch of the public service they wish to enter. 6. The branches of the public service which are recruited from the P. are, the corps of land and naval artillery, military and naval engineers, the imperial marine, the corps of hydrographic engineers, that of engineers of roads, bridges, and mines, the corps of staff-officers, the superintendence of telegraphs and tobacco manufactories.

The branches at present taught are, analysis (mathematical), mechanics and machines, fortification and the military art, descriptive geometry, geodesy, physics, chemistry, architecture, French



POLYTHEISM—POLYZOA.

composition, the German language, drawing and designing (of plans, figures, and maps). The staff of instructors consists of 20 professors and masters, and 18 tutors.

Though its main object is the recruiting of the public service, yet from the P. have proceeded almost all the celebrated French mathematicians and philosophers of the last half-century.

POLYTHEISM. See God.

POLYZO'A, known also as BRYOZOA (from the Greek *bryon*, moss, and *zoon*, an animal; because many of these organisms incrust other animals or bodies like moss), and CILIOBRACHIATA (from the circumstance that their tentacles are ciliated), are so called from many individuals being united into a colony or polyzoary. Although Dr Grant, in his *Observations on the Structure and Nature of Flustra*, in 1827, and Milne-Edwards and Audouin, in their *Résumé des Recherches sur les Animaux sans Vertèbres faites aux Îles Chausesey*, in 1828, indubitably shewed that these animals more closely resembled, in the details of their organisation, the molluscous than the radiate sub-kingdom, with which they were formerly confounded, some of our most esteemed English writers (including Professor Owen) persist in retaining them among the Polypes, instead of placing them in their true position amongst the *molluscoid animals*.

Most of the P. are microscopic, but as they occur in colonies, they often collectively form sufficiently conspicuous masses, and although there is little diversity in the form or structure of the animals themselves, there is much difference in the form, arrangement, and composition of the cells or chambers in which the individual animals reside. 'In general,' says Mr Gosse, 'the form of the cell is ovate or oblong; but the general shape is variously modified, being tubular, club-shaped, horn-shaped, cradle-shaped, square, &c.' The arrangement is often shrub-like, or the cells may be arranged in close series, either adhering in irregular patches, as the *Lepralia*, or rising into broad, flexible leaves, as the

cell, with whose walls it is connected only by means of muscular bands and threads at certain points, and by the covering of the mouth of the cell. The animal may either expand itself to a considerable extent out of the mouth of the cell, or it may be altogether restricted within the latter; their movements being due partly to pressure upon the outer walls, and partly to the muscular bands, which act chiefly as retractors. On examining one of these organisms in the expanded state, the mouth is seen to be surrounded by a crown of tentacles, which are most commonly ten or twelve in number, and are clothed with vibratile cilia, which lash the water towards the mouth, and thus create numberless little whirlpools, by which nutritious matter is conducted into the oral aperture of the polyzoa. These ciliated tentacles, which are seen in C, a, in the figure, constitute one of the essential points of difference between these animals and the hydraform polypes, with which they were formerly associated. The mouth leads to a funnel-shaped cavity or pharynx b, which is succeeded by an oesophagus c, and a true digestive stomach d (between which a muscular gizzard intervenes in certain genera), after which the intestine, e, turns back upon itself, and terminates in an anus, f, near the mouth. In the separate intestine and anal orifice, we have another characteristic distinguishing these animals from the polypes. At the base of the tentacular circle, just above the anal orifice, is a nervous ganglion, which in all the P. lies on the re-entering angle, between the two extremities of the intestinal canal. No heart has as yet been discovered, the matters, which result from digestion, percolating through the intestinal walls, and becoming mixed with the fluid in which the viscera float. According to Professor Allman, three distinct modes of reproduction occur in the P., viz., by buds or gemmæ, by true ova, and by free locomotive embryos. This subject, however, requires further investigation.

Minute appendages, of a very remarkable character, are fixed to the cells of many of the genera. They are termed *Avicularia*, or 'Birds'-head Processes,' and *Vibracula*, or whip-like spines. The *Avicularia* were described by Ellis, who first noticed them (in his *Essay towards a Natural History of the Corallines*, 1758), as resembling 'a bird's head with a crooked beak, opening very wide;' they consist of a fixed and a movable nipper, like a crab's claw, the latter being worked by special muscles. These moving beaks have been often observed to seize minute animals; but as these organs have no power of passing their prey to the mouth, the P. cannot receive nourishment from this source. Mr Gosse ingeniously suggests that 'the seizure of a passing animal, and the holding of it in the tenacious grasp until it dies, may be a means of attracting the proper prey to the vicinity of the mouth.' The

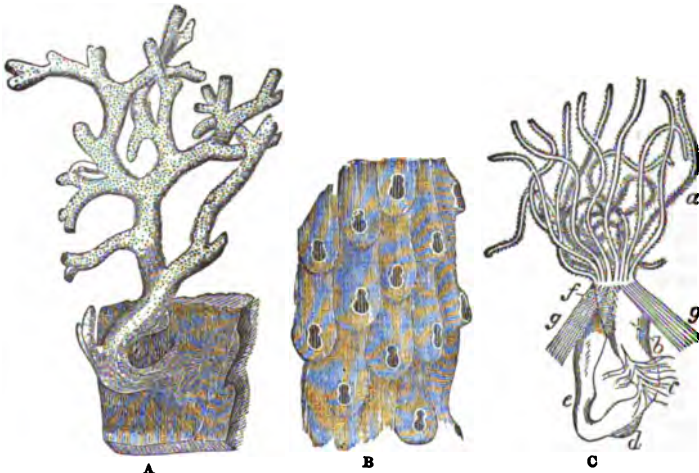

*Eschara Cervicornis* :

A, portion of its coralline fabric, of the natural size; B, portion of a young branch, enlarged, to shew the arrangement of the superficial apertures; C, an individual withdrawn from its cell and highly magnified; a, mouth; b, pharyngeal cavity; c, secreting tubes; d, the digestive stomach; e, the intestinal canal; f, the anus; g, retractor muscles.

*Flustra*, or common sea-mats, or in solid strong walls, or coral-like masses, as the *Escharæ*, or calcareous sea-mats. Each animal lives freely in its

*vibracula* consist of a long, slender movable seta or bristle, which, according to Gosse, serves 'to rid the animal of intruding vagrants, and to cleanse

away accidental defilement, by sweeping across the orifice of the cell.' Both these kinds of organs are of service in determining genera. Excellent magnified representations of the *Avicularia* and *Vibracula* may be seen on referring to figs. 13 and 11, in Mr Busk's excellent article, POLYZOA, in *The English Cyclopædia*, to which, as also to that gentleman's *Catalogue of Marine Polyzoa in the British Museum*, and to Professor Allman's 'Report on the Fresh-water Polyzoa,' published in the *Reports of the British Association for 1850*, the reader is referred for further information regarding this remarkable class of animals.

POMACEÆ, or POMEÆ, according to some botanists, a natural order of plants, but more generally regarded as a suborder of ROSACEÆ (q. v.). The plants of this order are all trees or shrubs, abundant in Europe, and chiefly belong to the temperate and colder regions of the Northern Hemisphere; they are rare in very warm climates, and are not found at all in the southern hemisphere. They have the botanical characters described in the article ROSACEÆ (q. v.), and in addition are distinguished by having the tube of the calyx more or less globose, the ovary fleshy and juicy, lined with a thin disc, its carpels adhering more or less to the sides of the calyx and to each other; the fruit a *Pome* (q. v.), 1-5-celled, in a few instances spuriously 10-celled; the ovules in pairs, collateral. Many of the species are prized for the beauty and fragrance of their flowers, some produce valuable timber; but the order is chiefly remarkable as producing a number of the very finest fruits of temperate climates. See APPLE, PEAR, QUINCE, MEDLAR, LOQUAT, HAWTHORN, CRATEGUS, AMELANCHIER, ROWAN, SERVICE, PYRACANTHA.—There are about 200 known species.

POMADE, or POMATUM, is a preparation to be used instead of liquid oil for the hair. It consists of a fine inodorous fat, such as lard or suet; but neither of these are quite free from smell, and the most careful perfumers render them so by a peculiar process. They melt them in a steam-bath, and to every  $\frac{1}{4}$  of cwt. add 1 oz. of alum and 2 oza. of salt, continuing the action of the heat till any scum ceases to rise; the scum is carefully removed, and the fat allowed to cool, after which it is levigated with cold water with great care and patience until every particle has been acted upon, and the salt, alum, and albuminous matters are perfectly washed out, after which it is remelted in the steam-bath, and any remaining water falls to the bottom: when cold, it is fit for use. The perfumer then takes portions of this prepared fat, and remelting each separately, adds a little wax or spermaceti to give it consistency, and perfumes it with some essence. The varieties of pomades are as numerous as the perfumed essences. Anciently, they were made by boiling over-ripe apples in fat, by which the peculiar smell of the fruit was communicated, and this originated the name, which is derived from *pomum*, an apple.

POMBAL, DOM SEBASTIAO JOSE DE CARVALHO, MARQUIS OF, the greatest of all Portuguese statesmen, and one of the ablest men of his time, was born 13th May 1699, at the castle of Soura, near Coimbra. His father, Manuel de Carvalho, was a captain of cavalry, and belonged to the second grade of nobility. After studying law at Coimbra, and serving a short time in the army, P. was banished from Lisbon on account of his youthful turbulence of disposition, and retired to his birthplace, where he devoted himself for a while to study. Subsequently, he married a rich widow, Donna Teresa da Noronha Almada, and repaired to court. In 1739,

he was appointed envoy-extraordinary to the court of London through the influence of his uncle, Paulo Carvalho, a position which he held for six years, after which he was sent to Vienna in a similar capacity. Here P. (whose first wife was now dead) espoused, in 1749, Leonora Ernestina, Countess Daun, niece of the famous Austrian marshal of that name. This marriage had a most felicitous influence on his future career. When P. returned to Portugal, the Portuguese queen, who was an Austrian princess, conceived a great attachment to his wife; and when her son, Joseph I., ascended the throne in 1750, she induced him to appoint P. state secretary for foreign affairs. Immediately, his splendid administrative genius burst forth like a sudden blaze of sunshine. He found his country almost without an army, without a fleet, without commerce or agriculture, and all power in the hands of unscrupulous Jesuits and grasping nobles. Among his first acts was to re-attach to the crown a great number of domains that had been unjustly alienated. Then followed the re-organisation of the army, the introduction of fresh colonists into the Portuguese settlements, the establishment of an East Indian Company, and another for Brazil, where he introduced the cultivation of coffee, sugar, cotton, rice, indigo, and cocoa. In virtue of a treaty with Spain, signed in 1753, Paraguay became an appanage of the Portuguese crown, and it was in this remote region that P. first came into collision with the Jesuits—the founders of the Paraguay missions. He got his brother, Francisco-Xavier de Mendonça, appointed captain-general of Paraguay, and is said to have given him secret instructions to ruin the Jesuits in his reports to the king. When the great earthquake happened at Lisbon in 1755, P. displayed an almost superhuman courage and energy, in consequence of which the king raised him to the rank of Count of Oeyras, and in the following year appointed him prime minister. He crushed a revolt instigated by the great nobles and the Jesuits, the latter of whom he now removed from the person of the sovereign, deprived of the power of the confessional, and in 1757 confined to their colleges. A conspiracy against the life of the king, which broke out 3d September 1758, but failed, placed his enemies completely in his power. The leaders were punished with appalling severity. The Duke of Aveiro and the Marquis of Tavora were broken alive on the wheel, the sons and the son-in-law of the former were strangled, and the wife of the marquis was beheaded. The Jesuits were suspected of complicity in the plot, and P. accused them to the pope; and when the latter would not allow the minister to proceed against them in the civil courts, he daringly caused some to be executed in prison. Father Malagrida, who had prophesied the death of the king, was delivered over to the Inquisition as a heretic, and condemned to be burned alive; and this *auto da fé* actually took place in 1761! But P. was not satisfied. He had made up his mind that the very presence of the Jesuits in Portugal was incompatible with the security of the government and the welfare of the nation, and by a royal decree of 3d September 1759, they were banished from the kingdom as rebels and enemies to the king. When they refused to leave, P. had them violently removed by soldiers, carried on board ships, and transported to the States of the Church. The pope, Clement XIII., vehemently protested, whereupon P. caused the papal nuncio to be shewn across the frontier. Shortly after, Clement XIII. died, and was succeeded in the papal see by Clement XIV.—no friend of the Jesuits, in consequence of which the differences between Portugal and the Vatican were soon made up. All this

time P. was labouring energetically to improve the cultivation of the land and the system of education. In 1770, he was created Marquis of P., and from this period to the death of the king in 1777, he was at the very height of his greatness. The accession of Joseph's daughter, Maria I.—an enemy of the minister—was immediately marked by his downfall. He was deprived of his offices; the conspirators whom he kept in prison were released; many of his institutions were abolished; and he himself was only saved from the scaffold because he held in his possession documentary proofs of the former treason of his now triumphant enemies. Maria ordered him to retire to his castle of Pombal, where he died, 8th May 1782. The peasantry always spoke of him as 'The Great Marquis,' and history has stamped the rustic verdict with its approval. When he was turned out of office, he left the queen a public purse containing 78,000,000 cruzados, and a well-ordered and flourishing state.

**POME** (Lat. *pomum*, an apple), a form of fruit of which examples are found in the apple, pear, and other fruits of the *Pomaceæ*; and in which the *epicarp* and *mesocarp* (see FRUIT) form a thick fleshy mass; whilst the *endocarp* is scaly, horny, or stony, and divided into separate cells, in which the seeds are enclosed. The fruit is crowned with remains of the calycine segments. Pomes have 1—5 cells, or spuriously 10 cells.

**POMEGRANATE** (*Punica granatum*), a fruit much cultivated in warm countries, and apparently a native of the warmer temperate parts of Asia, perhaps also of the north of Africa. It has been cultivated in Asia from the most ancient times, and is frequently mentioned in the Old Testament. It has long been naturalised in the south of Europe. In a wild state, the plant is a thorny bush, in cultivation it is a low tree, with twiggy branches, flowers at the extremities of the branches, the calyx red, the petals scarlet. It is generally referred to the natural order *Myrtaceæ*. The calyx is leathery, tubular, 5—7-cleft; there are 5—7 crumpled petals;



Section of a Pomegranate.

the fruit is as large as a large orange, with a thick leathery rind of a fine golden yellow, with a rosy tinge on one side, not bursting when ripe; the cells filled with numerous seeds, each of which is surrounded with pulp, and separately enclosed in a thin membrane, so that the P. appears to be formed of a great number of reddish berries packed together and compressed into irregular angular forms. The pulp is sweet, sometimes subacid, and of a pleasant delicate flavour, very cooling, and particularly grateful in warm climates. It is often used for the preparation of cooling drinks. A kind of P. without seeds is cultivated and much prized in India and Persia. Pomegranates have long been imported in small quantities into Britain from

Portugal and the north of Africa; but have never become an article of general demand and commercial importance like oranges. There is an ornamental variety of the P. with double flowers. The rind of the fruit is very astringent, and a decoction is used as a gargle in relaxed sore throat, and as a medicine in diarrhoea, dysentery, &c. Deriving its astringency from tannin, it is used to tan leather. The finest Morocco leather is said to be tanned with it, and small quantities are imported into Britain from the north of Africa for the preparation of the finest kinds of leather, under the name of *Pomegranate Bark*.—The bark of the roots is used as an anthelmintic, and is often successfully administered in cases of tape-worm. Its value was known to the ancients, and it has long been in use in India.—The P. tree is occasionally cultivated in hothouses or greenhouses in Britain. It bears the winters of the south of England in the open air, and is very ornamental, but the fruit is worthless. In some parts of the south of Europe it is used as a hedge-plant.

**POMEL**, a boss or ball used as an ornament on the top of pointed roof, turret, &c.

**POMERANIA** (Ger. *Pommern*), a province of Prussia, bounded N. by the Baltic, E. by West Prussia, S. by Brandenburg, and W. by the Mecklenburg duchies. Area, 12,111 square miles. Pop. (at the close of 1861) 1,389,739. P. is divided into the three governmental districts of Stettin, Stralsund, and Cöslin.

This province, which is one of the lowest and flattest in Germany, and has few hills of even moderate height, is intersected by the Oder (q. v.), which forms numerous lakes and ponds, the largest of which is the Dammer Lake. The waters of this lake and of the Oder are then carried into the Stettiner Haff, from which three outlets—those of the Peene, Swine, and Dievenow—lead into the Baltic. Between these three outlets are the two islands of Usedom and Wollin. After the Oder, the chief rivers of P. are the Inna, Rega, Persante, Wipper, and Stolpe. The shores in some parts are protected by dikes and sand-banks. The soil is generally sandy, and in many districts even stony, although near Pyritz and Stargard, on the Ploen and Maduc Lakes, and at some points of the sea-coast, it presents a tolerably fruitful character, yielding good crops of wheat, and affording rich pasture. About half of the whole area is cultivated; about a sixth is uncultivated, or under water; and the remainder is in pastures, heath, and wood. The chief vegetable products, most of which are grown in sufficient quantities to be largely exported, are—rye, wheat and other grain, flax, hemp, tobacco, and timber. Among the other exports of P. are horses, cattle, sheep, swine, geese of superior quality, feathers, butter, wool, hams, sausages, smoked poultry, &c. The sturgeon and salmon fisheries are very productive, and P. is noted for its admirable lampreys, eels, and crayfish, which are largely exported in a pickled state. The mineral products, which are inconsiderable, include bog-iron, lime, marl, alum, salt, amber found on the coast near Stolpe, and peat—which latter substance is obtained in enormous quantities, and extensively used for fuel, notwithstanding the abundant supply of wood yielded by the extensive and productive forests.

Linen and woollen fabrics, and leather, rank among the best of the industrial products; but the manufactures of P. are not of much importance. The principal branches of industry are agriculture and the rearing of horses and cattle, while the active transport-trade between the neighbouring

Prussian states and the Baltic ports constitutes a very important source of wealth to the province. The main seat of Pomeranian trade is at Stettin (q. v.), which ranks as one of the most important commercial cities of Prussia.

P., like every other part of the Prussian dominions, is well provided with educational institutions, and, besides the university at Greifswald, it has eight gymnasia, several normal and training schools, and numerous classical and other schools.

P. formed, in the earliest periods of its history, a part of the ancient kingdom of the Wends or Vandals. From the year 1062 it had its own ducal rulers, and in the beginning of the 12th c. it adopted Christianity in consequence of the preaching of Bishop Otto of Bamberg. Bogislaus XIV., who died in 1637, was the last male representative of the Wendish ducal line; and, on his death, the House of Brandenburg laid claim to the whole of the Pomeranian territories, in conformity with a compact which the latter family asserted to have been made between them and the Wendish dukes; but the country having been occupied by the Swedes during the Thirty Years' War, Prussia was obliged to content itself with the possession of Further P., or *Hinterpommern*, which was assigned to it at the Peace of Westphalia, while Sweden retained the remainder of P., with the island of Rugen (q. v.). After the death of Charles XII., and the subsequent decline of the Swedish power, Prussia was able to make good her asserted claims on the territory of P. at the Peace of Stockholm; and in 1720 Sweden was compelled to cede Southern P. and the island of Rugen, retaining only a narrow strip of land between Mecklenburg and the Baltic, which was also incorporated with Prussia in 1815, after having been first transferred by Sweden to Denmark as part indemnification for the separation from the latter kingdom of Norway, and subsequently ceded to Prussia by the Danes in exchange for the duchy of Lauenburg, and on the payment of 2½ million thalers to the latter, and of 3½ million thalers to the Swedish government.

**POMMETTÉE**, or **POMEL CROSS** in Heraldry, a cross whose extremities terminate in single knobs or pomels, like the *Bourdon* or pilgrim's staff.



Pommettée Cross.

**POMO'LOGY** (Lat. *pomum*, a fruit of any kind, an apple), a term much employed in France and Germany, and to a smaller extent in Britain, to designate the study of fruits and of their

cultivation, particularly those of the natural order *Pomaceæ* (q. v.). See **FRUIT**, **FRUIT-GARDEN**, **APPLE**, **PEAR**, &c.

**POMONA** (whose name is obviously connected with *pomum*, 'a fruit') was, among the Latins, the patron divinity of garden-produce. The poets, not, perhaps, without some allegorical design, represent several of the rural gods as her lovers—*Silvanus*, *Picus*, *Vertumnus*, &c. Of *Vertumnus*, in particular, it is related that after he had vainly tried to approach her under a thousand different forms, he at last succeeded by assuming the figure of an old woman. In this guise, he recourted to her the lamentable histories of women who had despised love, and having touched her heart, suddenly transformed himself into a blooming youth and married

her. But *Vertumnus* (connected with *verto*, 'to turn,' 'to transform') is probably nothing more than a personification of those changes by which plants advance from blossom to fruit. The worship of P.,

as was natural among a homely race of farmers and shepherds like the ancient Latins, was of considerable importance. Varro tells us that at Rome her services were under the care of a special priest, the *flamen Pomonalis*. In works of art she was generally represented with fruits in her lap, or in a basket, with a garland of fruits in her hair, and a pruning-knife in her right hand.

**POMONA**, or **MAINLAND**, much the largest and most populous of the Orkney Islands (q. v.), in which group it occupies a central position. It is open to the Atlantic on the west, and to the German Ocean on the east, while on the north Enballow and Shapinsha Sounds separate it from the islands of Ronsay and Shapinsha, and on the south, Scapa Flow separates it from Hoy and South Ronaldsha. Area, 150 square miles; population, 17,193. It is 25 miles in length, and 15 miles in extreme breadth, but is very irregular in shape. At the town of Kirkwall, the breadth of the island is only about two miles. In the west, the shores are bold and elevated, but there is a general slope towards the east. The surface is diversified with hill and lake, and consists in great part of moor and heath. Good pastures are found, however, and in the valleys there is a fertile, loamy soil. Oats, beans, and bere are produced, and sheep and swine are extensively reared. The chief towns are Kirkwall (q. v.) and Stromness (q. v.).

**POMPADOUR** (*JEANNE ANTOINETTE Poisson*), **MARQUISE DE**, a notable mistress of Louis XV., was born in Paris in 1720 or 1722. Her reputed father was a certain François Poisson, who held a humble office in the army-commissariat; but M. le Normand de Tournheim, a rich *fermier-général*, claimed for himself the honours of a dubious paternity, and brought up the little Jeanne as his daughter. She turned out a wonderfully clever child, and M. le Normand spared no pains to give her the best, or, at least, the most stylish education possible. She excelled in such accomplishments as music, elocution, and drawing; but what charmed the brilliant society that frequented the *salons* of the rich financier, was the perfect grace and beauty of her figure, and the exquisite art with which she dressed. A crowd of suitors constantly besieged her, but the one who obtained her hand was her cousin, Le Normay l'Étiole. They were married in 1741. But Madame l'Étiole, who was constantly told by her infamous mother that she was a 'morsel for a king,' was careless of her husband's honour and peace. Though he loved her to distraction—and he was a man with whose love any woman might have been content—she, cold, heartless, and ambitious, was scheming day and night to attract the notice of the monarch. Her efforts were after a time crowned with success, and Madame d'Étiole was installed in the palace of Versailles; she was soon afterwards ennobled by the title of Marquise de P., and long ruled the king, first as mistress, and afterwards as *amie nécessaire*. One reads with some astonishment of the incessant artifices she had recourse to in order to preserve her influence—the everlasting huntings, concerts, private theatricals, little suppers, and what not—anything to distract the royal mind (surely sufficiently distracted already by nature), and to make it think only of the clever purveyor of gaieties! The private theatricals, in particular, were a great success, and were 'got up' every winter from 1747 to 1753—the marquise herself proving a charming actress. The king thought the marquise extremely clever, and, when he ceased to 'love' her, was glad to avail himself of her services as his political adviser. In fact, she became premier of France; the council of ministers assembled

## POMPEII—POMPEY THE GREAT.

in her boudoir, where the most important affairs of state were settled. The choice of ministers, of ambassadors, of generals, depended on the caprice of a female; the Abbé de Bernis, the favourite of a favourite, entered the council. Foreign diplomacy turned the circumstance to account. The Austrian prime-minister induced Maria Theresa to sacrifice her pride to the exigencies of her position, and the empress-queen wrote the courtesan a letter in which she addressed her as *ma cousine*. That word turned the head of the marquise, and changed for a time the foreign policy of France. She died (15th April 1764) with the reins of government in her hands. During her life-time, immense sums from the national treasury were paid away to the marquise, and to her brother, created Marquis de Marigny. In the years 1762—1763 alone, they amounted to 3,456,000 livres. She had numerous houses and lands also given her. In 1853, M. le Roi, keeper of the town-library of Versailles, published in the *Journal de l'Instruction Publique*, a list of the expenses of the Marquise de P. during the years in which she had enjoyed the royal favour, which he had found in MS. in the archives of the department of Seine-et-Oise. They amounted to 36,000,000 livres. She was imperious and vindictive beyond measure, and with relentless cruelty doomed to perpetual imprisonment, in the dungeons of the Bastille and elsewhere, multitudes who had dared to speak about her ill-gotten gains and power. After facts like these, it is but a poor apology for the marquise to say that she encouraged savans, poets, and philosophers, patronised and protected the *Encyclopédie*, and aided in the expulsion of the Jesuits. The *Memoires* and *Lettres* published under her name are spurious.

POMPEII, a city of Campania, was built at the mouth of the river Sarnus (*Sarno*), looking out on the Bay of Naples. It stood at the base of Mount Vesuvius, between Herculaneum and Stabia. Of its early history little is known (legend ascribed its foundation to Hercules); but in more recent times it became a favourite resort for wealthy Romans, many of whom, including Cicero, had villas in the suburbs. It must have been at one time a place of considerable trade, since it was the port-town of Nola and other inland cities which studded the fertile valley of the Sarnus. The city was much damaged by an earthquake which happened on the 5th February 63 A.D., and not many years had revolved when the great and final calamity overtook it. In 79 A.D. occurred that terrific eruption of Vesuvius which, in one day, overwhelmed in irremediable ruin the towns of P., Herculaneum, and Stabia. In course of time a small village rose at or near the spot; but by and by the memory of P. was forgotten, and for centuries its very site was unknown. The difficulty of discovering its true position was increased in consequence of the changes produced by this fearful convulsion, which had hurled back the Sarnus from his ancient course, and raised the sea-beach to a considerable height, so that the re-discovered city, to which merchantmen resorted of old, is now a mile from the coast, and a considerable distance from the stream that in ancient times was wont to skirt its walls. For more than sixteen hundred years, P. lay undisturbed beneath heaps of ashes and cinders. At length, in 1689, some ruins were noticed, but it was not till 1755 that any excavations were made. These operations, begun by the Neapolitan government, have been continued till the present time (and recently with increased energy), and have been exceedingly productive of objects which interest the antiquarian and the classical scholar. The remains found are in a remarkably

good state of preservation, owing to the fact that the city was destroyed not by lava, but by showers of sand, ashes, and cinders (*lapilli*), forming a light covering, which found its way into every nook, and, as it were, hermetically sealed up the town. It would appear that in some parts at least the matter was deposited in a liquid state, and so flowed into the remotest cellars of the doomed habitations. The immense volumes of water which poured down, mixed with the ashes that had already fallen and with those that were still suspended in the air, and formed a kind of liquid mud. This is proved by the discovery of the skeleton of a woman in a cellar, 'enclosed in a mould of volcanic paste, which received and has retained a perfect impression of her form.' The depth of the superincumbent rubbish is in most places about 15 feet, but this mass has not been heaped up at one eruption. That it is the work of many eruptions is proved by the facts: (1) That as many as eight or nine different layers have been distinctly counted; and (2) That, while the upper layers are undisturbed, the lower one has evidently been moved. Comparatively few skeletons have been found, and almost no objects of great intrinsic value, such as gold and silver plate, which seems to shew that the great body of the population had found time to escape, and had returned to seek and to bury their lost friends, and to recover whatever treasures could be found. In the autumn of 1864, in excavating a temple of Juno, upwards of two hundred skeletons were found lying on the floor, the victims having evidently gone thither to seek the protection of the goddess. The plan of P. seems to have been regular, the streets (the broadest of which yet discovered is only 30 feet) crossing one another at right angles. The houses were plain and low, being seldom more than two stories high, and had all their good apartments on the ground-floor. The city was about two miles in circumference, and was surrounded by a wall. It would be impossible in our brief space to attempt even an enumeration of the objects discovered in this now famous city, or to detail the valuable results which have flowed from the work of excavation. Suffice it to say that in all the departments of social life—in the affairs of domestic and of public life, of the worship of the gods, and the shows of the arena—in architecture, painting, and sculpture—in fine, in all the appliances of comfort and of luxury in a wealthy community, we have, as it were, a living picture of a city 1800 years ago. The reader who wishes fuller information should consult Mazois' work, *Les Ruines de Pompeii* (Paris, 1812—1838); Breton's *Pompeia* (Paris, 1855); Overbeek's work (Leipzig, 1856); Sir W. Gell's well-known *Pompeiana* (4 vols. 1824—1830); and *Pompeii* (2 vols. 1831) in the series of the Society for the Diffusion of Useful Knowledge. For a popular account of the present state of P., we may refer to *Something of Italy*, by W. Chambers, 1862.

POMPELMOO'SE, or POMELO (*Citrus pomelo*), a fruit nearly resembling the Shaddock (q. v.), of which, perhaps, it ought to be esteemed a variety, although it is now distinguished by some botanists as a separate species. It is large and pale yellow. It has long been cultivated in the East Indies, and has recently been introduced into many warm countries. It has become an article of importation into Britain, and is frequently to be seen in fruit-shops. In pleasantness of taste, it resembles the best oranges. It is often preserved with wine and sugar, when it is very agreeable and refreshing in a hot climate. The rind is often candied.

POMPEY THE GREAT. Cneius Pompeius

## POMPEY THE GREAT—POMPEY'S PILLAR.

Magnus, son of Cn. Pompeius Strabo, was born in 106 B.C. At the early age of 17 he began to learn the military art under his father by service in the field against the Italians in the Social War. Though so young, he gave proof of extraordinary valour, and of remarkable energy of character. On the death of his father in 87 B.C., when he was only 19 years of age, he was left without a protector, and during the temporary triumph of the Marian party, he was for some time in considerable danger. When Sulla, to whose side he was attached, returned from Greece to Italy to oppose Marius, P. hastened into Picenum, where he had considerable estates and influence, and there raised an army of three legions, with which he successfully opposed the forces of the Marian party, compelling them to quit the district, and effecting a junction with Sulla. During the rest of the war he behaved with great prudence and valour, and with such remarkable success, that, on the restoration of peace in Italy, the conduct of the war against the remains of the Marian faction in Africa and Sicily was intrusted to him. He speedily performed his commission, and on his return to Rome was honoured with the name of **MAGNUS** (i.e., 'The Great'), and with a triumph, which, for one who had not yet held any public office, and was merely an *eques*, was an unprecedented distinction. His next exploits were the reduction of the followers of Lepidus, whom he drove out of Italy, and the extinction of the Marian party in Spain, led on by the brave Sertorius. This latter work was one of no small difficulty. P. suffered some severe defeats at the hands of Sertorius, and it was only after Sertorius had been assassinated that he was able to put an end to the war. In returning to Italy after an absence of five or six years in Spain, he fell in with and defeated the remnants of the army of Spartacus, and thus claimed the credit of concluding the Servile War. He was now the idol of the people, and though legally ineligible to the consulship, was elected to that important office for the year 70, the senate relieving him of his disabilities rather than provoke him to extremities. Hitherto P. had belonged to the aristocratic party, but as he had of late years been looked upon with suspicion by some of the leading men, he publicly espoused the people's cause. He carried a law restoring the tribunician power to the people; and aided largely in introducing the bill of Aurelius Cotta (*Lex Aurelia*), that the *judices* should for the future be taken from the *senate*, the *equites*, and the *tribuni aerarii*, instead of from the senate alone. In 67—66 B.C., P. performed a noble service to the republic in clearing the Mediterranean of the pirates who infested it in immense numbers; and during the next four years, 65—62, he conquered Mithridates, king of Pontus, Tigranes, king of Armenia, and Antiochus, king of Syria. At the same time he subdued the Jewish nation, and captured Jerusalem. On his return to Italy he disbanded his army, and entered Rome in triumph for the third time in 61 B.C. And now his star began to dim. Henceforward we find him distrusted by the aristocracy, and second to Cæsar in popular favour. After his return, he was anxious that his acts in Asia should be ratified by the senate, and certain lands apportioned among his veteran soldiers. But the senate declined to accede to his wish, and he therefore formed a close intimacy with Cæsar, who promised to secure for him the accomplishment of his objects, if he in turn would assist Cæsar in the attainment of his aims. Crassus, who possessed enormous wealth, and who in consequence exercised a wide influence at Rome, was induced to forego his grudge to P., and thus these three men formed among themselves that coalition which is commonly

called 'the First Triumvirate,' and which for a time frustrated all the efforts of the aristocratic party. This small oligarchy carried all before them; P.'s acts in Asia were ratified; Cæsar's designs were all gained; his agrarian law, distributing land in Campania among the poorer citizens was passed, and thus, too, P.'s promises to his troops were fulfilled. Cæsar's daughter, Julia, was given in marriage to P., and private relationship was thus made to bind tighter the tie of political interest. And now, for some years following, Cæsar was reaping laurels in Gaul, and rising higher in popular esteem as a warrior and statesman, while P. was idly wasting his time and his energies at Rome. But P. could not bear a rival. Jealousies sprang up; Julia died in 54 B.C., and thus father-in-law and son-in-law were sundered by a yet wider gulf, which no bridge could span. P. now returned to his former friends, the aristocracy, whose great desire was to check Cæsar's views, and strip him of his command. Cæsar was ordered to lay down his office and return to Rome, which he consented to do, provided P., who had an army near Rome, would do the same. The senate insisted on an unconditional resignation, and ordered him to disband his army by a certain day, otherwise he would be declared a public enemy. To this resolution two of the tribunes in vain objected; they therefore left the city and cast themselves on Cæsar for protection. It was on this memorable occasion that he crossed the Rubicon, and thus defied the senate and its armies, which were under P.'s command. The events of the civil war which followed have been recorded in the life of Cæsar (q. v.). It remains only to mention, that after being finally defeated at Pharsalia in 48 B.C., P. escaped to Egypt, where, according to the order of the king's ministers, he was treacherously murdered by a former centurion of his own, as he was landing from the boat. His head was cut off, and afterwards presented to Cæsar on his arrival in Egypt. But Cæsar was too magnanimous to delight in such a sight. The murderer of P. was, by his orders, put to death. The body lay on the beach for some time, but was at length buried by a freedman, Philippus, who had accompanied his master to the shore.

**POMPEY'S PILLAR.** The name of a celebrated column standing in the neighbourhood of Alexandria. It stands upon an eminence about 1800 feet south of the walls. It is a monolith of red granite, and of the Corinthian order, and stands upon a pedestal. Its total height is 98 feet 9 inches; shaft, 73 feet; 29 feet 8 inches in circumference. The shaft is well executed. On the summit is a circular depression for the base of a statue, which in some old drawings is represented standing on it. The name popularly applied to it of Pompey's pillar is an erroneous appellation given by ancient travellers, who confess they do not know whence it was derived, and still retained. The inscription on the base, however, shews that it was erected by Publius, prefect of Egypt, in honour of the Emperor Diocletian, who is styled upon it 'the invincible;' and it is supposed to record the conquest of Alexandria by Diocletian, 296 A.D., and the suppression of the rebellion of the pretender Achilleus. It appears to have been in the vicinity of a circus, forum, or gymnasium. The obelisk stood upon some fragments of Egyptian monuments of remote antiquity, consisting of a piece with the name of a monarch of the 13th Egyptian dynasty, and another with that of Psammitichus I., the former of which is now in the British Museum.—Wilkinson's *Modern Egypt*, I. p. 149 and foll.; White, *Ægyptiaca*, p. 1, and foll.; Champollion-Figeac, *L'Égypte*, p. 472; Norden, I. p. 22.

PONCE DE LEON—PONDICHERRY.

PONCE DE LEON, FRAY LUIS, a celebrated Spanish poet, was born in 1527, probably at Granada. In 1544 he entered the order of St Augustine at Salamanca, where he studied, took his degree in theology in 1560, and was appointed professor of the same in 1561. The reputation that he acquired as a learned commentator on the Bible induced some persons, who were envious of his success, to accuse him of having disregarded the prohibition of the church, inasmuch as, at the request of a friend, he made a new translation of the Song of Solomon, and brought out prominently, in his arrangement of the verses, the true character of the original—viz., that of a pastoral eclogue. This interpretation was not that adopted by the Catholic Church, and P. was summoned, in 1572, before the formidable tribunal of the Inquisition at Valladolid to answer the charges of Lutheranism, and of translating the sacred writings contrary to the decrees of the Council of Trent. The first accusation he quickly disposed of—for he had in reality no inclination to a foreign Protestantism; but the second was undoubtedly true, and P. was imprisoned. After five years he was released through the intervention of powerful friends, and was even reinstated in his chair at the university with the greatest marks of respect. The numerous auditory that assembled to witness the resumption of his lectures, were electrified when P. began with these simple words: 'As we observed in our last discourse'—thus sublimely ignoring the cause and the duration of his long absence from his lecture-room. In 1580, P. published a Latin commentary on the Song of Solomon, in which he explained the poem directly, symbolically, and mystically; and, therefore, as obscurely, says Mr Ticknor, 'as the most orthodox could wish.' P. lived 14 years after his restoration to liberty, but his terror of the Inquisition never quite left him, and he was very cautious in regard to what he gave to the world during his lifetime. He died in 1591. P.'s poetical reputation was wholly posthumous, for though his *De los Nombres de Christo* (on the Names of Christ), (Salamanca, 1583—1585), and *La Perfecta Casada* (The Perfect Wife), (Salamanca, 1583), are full of imagery, eloquence, and enthusiasm, yet they are in prose. His poetical remains were first published by Quevedo at Madrid in 1631, under the title, *Obras Proprias, y Traduciones Latinas, Griegas y Italianas: con la Paraphrasi de Algunos Salmos y Capítulos de Job*, and have since been often reprinted. These consist of translations from Virgil's *Ecloques* and the *Georgics*; from the *Odes* of Horace, and other classical authors, and from the Psalms. His original poems are few, but they are considered among the most precious in the author's language, and have given P. a foremost place among the Spanish lyrists. According to Ticknor: 'Luis de León had the soul of a Hebrew, and his enthusiasm was almost always kindled by the reading of the Old Testament. Nevertheless, he preserved unaltered the national character. His best compositions are odes composed in the old Castilian versification, with a classic purity and a vigorous finish that Spanish poetry had never till then known, and to which it has with difficulty attained since.' See Nicolas Antonio, *Bibliotheca Hispana Nova*; Ticknor, *History of Spanish Literature*; and Villemain, *Essais sur la Poésie Lyrique*.

PONCHO, an important article of male attire in Chili. It consists of a piece of woollen cloth, 5—7 feet long, 3—4 feet broad, having in the middle a slit through which the wearer passes his head, so that the poncho rests upon the shoulders and hangs down before and behind. In the fashions of recent times, the poncho has been introduced in Europe.

PONDICHERRY, the chief of the French settlements in India, situated in the district of South Arcot, in the Madras Presidency. The other French establishments are Mahé in Malabar, Karikal (q. v.) in Tanjore, Yanum in Godavari, and Chandernagore (q. v.) in Bengal. The extent of the united territories is given by M. Block at 188 square miles. P. is situated on the Coromandel Coast in 11° 56' of N. lat., and 79° 52' of E. long., and is 98 miles from Madras. The territory of P. is divided into three districts—Pondicherry, Vellenore, and Bahour—has an area of 107 square miles, and comprises 92 villages. The total population of the French establishments in India in 1840 was reckoned at 171,217; in 1863, it amounted to 221,507. The population of the town of P. in 1854, was 96,716, or 1641 Europeans and 95,075 natives. The governor of P. is the governor-general of the French possessions in India; his income is 40,000 francs a year. The salaries of the *chefs du services* of the other establishments are as follows: Chandernagore, 16,000 francs; Karikal, 10,000 francs; Yanum, 8000 francs; Mahé, 8000 francs per annum. The governor of P. has a council consisting of the *ordonnateur*, the *provisieur-général*, and the *contrôleur colonial*. The French army in India consists of two companies attached to the 1st marine regiment of infantry, consisting of 276 men, commanded by six European officers. The spinning of cotton and the fabrication of cotton-thread are the chief manufactures in the French establishments.

*History*.—The first settlement of the French in India was at Surat, in 1668. The chief of the French East India Company at that time was Carou. Subsequently, he took Trincomalee from the Dutch; but they were not long in repossessing themselves of it. Carou then turned to the Coromandel coast. In 1672, he took from the Dutch St Thomé, a Portuguese town (now a suburb of Madras); but two years later, the Dutch retook this place also. It was then that François Martin collected about 60 Frenchmen and settled them in P., which, in 1674, he had purchased, with the surrounding territory, from Gugee, who had the supervision of all Sivaje's conquests in the country. The Dutch took the town in 1693; but by the treaty of Ryswick it was restored to the French in 1697. Chandernagore was ceded to the French in 1688 by Aurungzebe. In 1727, they obtained the cession of Mahé; in 1739, they purchased Karikal from the king of Tanjore; and in 1752, Yanum was ceded to them. Dupleix was governor of P. when war broke out between France and England; and in 1746 La Bourdonnais took Madras. In 1748, Admiral Boscawen besieged P., but two months later, was compelled to raise the siege. In the same year occurred the peace of Aix la Chapelle; but it did not put an end to hostilities in India till some time later. In 1757, war recommenced. In 1758, Count de Lally became governor-general, and attacked the English settlement of Fort St David, which surrendered, and was totally destroyed. In 1761, Eyre Coote took Pondicherry. By the peace of Paris, P. was restored to the French in 1763 with reduced territory, and also Mahé, Karikal, and Chandernagore. P. was again taken by the English under Sir Hector Monro in 1778, and restored in 1783. In 1793, the English again repossessed themselves of it, but the treaty of Amiens in 1802 again restored it, but only till the following year. From this time it was held by the English till, by the treaties of 1814 and 1815, it was for the last time restored to France, reduced to the narrow limits assigned by the treaty of 1783.

Annexed is a statement exhibiting some particulars relative to such of the present French

## PONDWEED—PONIATOWSKI

possessions in India subordinate to P. as are not noticed separately in this work.

YANUM, in the Godavari District, in 16° 43' N. lat., and 83° 11' 16" E. long., about 24 miles south of Rajahmundry. The area is about 13 square miles.

MAHÉ, in the Malabar District, in 10° 42' N. lat., and 75° 38' 16" E. long. The area is only about 2½ square miles.

PONDWEED (*Potamogeton*), a genus of plants of the natural order *Naiades*, having hermaphrodite flowers, sessile upon a spike or spadix, which issues from a sheathing bract or spathe, a perianth of four scales, four sessile anthers opposite to the scales of the perianth, four pistils, which become four small nuts, and a curved embryo. The species abound chiefly in the rivers, lakes, and ditches of Britain and continental Europe, but they are found



Pondweed:  
a, expanded flower (magnified).

also in other parts of the world, and some of them in New Holland. They often present a beautiful appearance in clear streams and ponds, where they protect the spawn of fish and harbour aquatic insects, their seeds also affording food to aquatic birds. The roots are a favourite food of swans. Some of the species have the leaves all submersed, others have some of their leaves floating, and considerably different in form from the submersed leaves.

PO'NGO (*Simia* or *Pithecus Wormbit*), an ape of the same genus with the Orang (q. v.), but of much larger size, six feet or more from the heel to the crown of the head, and covered with black hair, with which dark red hair is mingled. It is a native of Borneo, Sumatra, and probably of other neighbouring islands, inhabiting the deepest recesses of the forests, and much more rarely seen by man than its congener the orang, which was at one time supposed by the most eminent naturalists to be the same species in a younger state. It is sometimes called the Black Orang. It has a very prominent muzzle, a large mouth, the face nearly naked, except the lower part, which has a beard. Little is yet known of the habits of the pongo. It is believed to feed chiefly on fruits. It possesses great strength, and like the orang, is evidently adapted by its

conformation for moving chiefly among the boughs of trees.

PONIATOWSKI, a celebrated princely family of Poland, is of Italian origin, being directly descended from the family of the Torelli, whose ancestors were Counts of Guastalla. One of the Torelli family having settled in Poland, assumed the name of P. from his wife's estate of Poniatow in that country. Those of the P. family, who make a figure in history are PRINCE STANISLAS P., who, in the war of succession to the kingdom of Poland, joined Charles XII. of Sweden in supporting Stanislas Leszczyński; his sons, STANISLAS-AGUSTUS, the last king of Poland (q. v.), and ANDREW, who rose to great distinction in the Austrian service; and Andrew's son, JOSEPH-ANTONY, PRINCE P., the celebrated Polish chief in the army of Napoleon. Joseph-Antony was born at Warsaw, 7th May 1762, and at the age of 16 entered the Austrian army, with which he made the Turkish campaign of 1787, and rose to the rank of colonel of dragoons. In 1789, he returned to Poland, and was named commander-in-chief of the army of the south, having under him Kosciusko, Wielhorski, Lubomirski, and other celebrated leaders. His army, though much inferior in numbers to that of Russia, which, in 1792, invaded the country, gained the brilliant victories of Polonné and Zielencé; but P.'s uncle, King Stanislas, by agreeing to the convention of Targowitz (q. v.), put an end to the contest in 1793. The prince then resigned his command, and went into voluntary exile, but returned in the following year to aid Kosciusko, now dictator, in his fruitless opposition to the third partition of Poland. On the proposal of Napoleon to reconstitute the kingdom of Poland, P. joined the French (1800) at the head of a Polish army, and did good service against the Russians at the battles of Golymin, Danzig, and Friedland; but the French emperor, by the treaty of Tilsit, handed over Poland to its enemies, and only the duchy of Warsaw (nominally subject to the king of Saxony) was left intact. P. was appointed generalissimo and commander-in-chief for the duchy; and so zealously did he labour for the development of its military resources, that, in 1809, when the war between France and Austria was resumed, he was able to drive the Austrians out of the Polish territory, and overrun a considerable part of Galicia. He continued to administer the military affairs of the duchy till 1812, when he joined the French army, destined to invade Russia, with a Polish army of 100,000 men. But to his intense disgust, the greater part of his army was broken up into detachments, which were incorporated with the various French legions, and P. was left with not more than 30,000 men under his direct command. At the head of this division, which always composed the extreme right of the French army, P. gathered innumerable laurels on the battlefield, and at the storming of the Russian fortresses; but he was so severely injured at Smolensko during the retreat, that he was obliged to return to Warsaw (December 1812). In the following autumn, he resumed his old place in the French army, and on October 16, received from the emperor the dignity of Marshal of France, an honour, in his own estimation, much inferior to that of 'generalissimo of the Poles,' which he already possessed. After the defeat at Leipzig (q. v.), P. was left with the remnant of his Polish division to protect the French retreat, which he accomplished by keeping the Prussians in check for several hours; at last, when his force was reduced to 300 men with 30 horses, and himself severely wounded, he retreated over the Pleisse, swimming his horse through the river; but in attempting similarly to cross the Elster, exhausted



## PONT-A-MOUSSON—PONTIANAK.

nature could no longer bear up, and he sank to rise no more, October 19, 1813. His body was recovered six days after, and was embalmed and carried to Warsaw, whence it was afterwards removed to Cracow, and placed beside the ashes of Sobieski and Kosciusko.

**PONT-À-MOUSSON**, a town of France, department of Meurthe, on the railway from Nancy to Metz, 20 miles north-west of the former of these towns. The Moselle flows through the town, which is situated in a fruitful valley. There is a fine Gothic church dedicated to St Martin. P. has some manufactures of pottery. Pop. 6437. It was the birthplace of Marshal Duroc, the favourite and friend of Napoleon.

**PONTCHARTRAIN LAKE**, in Louisiana, U.S. America, about 5 miles north of New Orleans, with which it communicates by a canal, is 40 miles long, and 24 miles in extreme width. It is navigated by small steamers, and communicates on the east with the Gulf of Mexico, and on the south with the Mississippi. Its greatest depth is from 16 to 20 feet.

**PONTECORVO**, a city of southern Italy in the province of Caserta, situated on the river Garigliano, 37 miles north-west of Capua, with 9314 inhabitants, almost all engaged in agriculture. It has an old castle, many churches, and is a bishopric. It formerly belonged to the pope; but now, since 1860, it forms part of the kingdom of Italy, and is a sub-prefecture. Napoleon I. gave the title of Prince of Pontecorvo to Marshal Bernadotte, afterwards king of Sweden.

**PONTÉ DELGADA**, a town on the south coast of the island of St Michael, one of the Azores (q. v.), in lat. 37° 40' N., and long. 25° 36' W. It is defended by the Castle of St Braz, which can mount 90 pieces of cannon, and by the forts of São Pedro and Rosto de Cão. The anchorage in the roadstead is bad and the harbour is shallow, but still the trade (which is largely in the hands of English merchants) is the most considerable of all the towns in the Azores. The chief exports are wheat, maize, and oranges. Pop. estimated differently from 16,000 to 22,000.

**PONTEFRAC** (commonly pronounced *Po'm-fret*), a market-town and municipal and parliamentary borough, in the county of York, and 24 miles south-south-west of the city of that name, on the Lancashire and Yorkshire Railway. There are two churches, viz., St Giles and All-Saints, the latter is in the Early English style, and has a handsome tower. There are a grammar, as well as national and other schools, several almshouses, a large work-house built in 1864, a splendid market hall opened by Lord Palmerston in 1860, &c. In the vicinity are extensive gardens and nurseries. Eight fairs for the sale of cattle take place annually. The trade is chiefly in corn, liquorice, and malt. Two members are returned to the House of Commons for the borough. Pop. (1861) of municipal borough, 5346; of parliamentary borough, 11,736.

The castle of P., built shortly after the Conquest, was a large and strong edifice, and stood on a commanding height. It was the scene of the imprisonment and death of Richard II., and here also Rivers, Grey, and Vaughan were put to death, at the instigation of Richard III. The remains of the castle to be seen at the present day are very meagre.

**PONTEFRAC CAKES** are small lozenges of refined liquorice, which have for centuries been made at Pontefract, and are much esteemed. They

are impressed with a rude figure of a castle, intended to represent Pontefract Castle.

**PONTEVEDRA**, a town of Spain, province of Galicia, is situated on a peninsular slope near the mouth of the river Lerez, 35 miles south of Santiago. P. is a clean and pretty place, with high old walls, granite-built houses, broad streets, and pleasant arcades. It takes its name from the bridge (*Pons Vetus*) that spans the river. The Pontevédranes are engaged chiefly in agriculture, though sea-fishing is also carried on, and there are some manufactures. Pop. 6623. The neighbourhood, of which charming views are obtained from parts of the town, is covered with villas, farms, and woodlands.

**PONTIANAK**, the capital of the kingdom of the same name on the west coast of Borneo, is situated near the junction of the Landak and Kapuas. It is built on both banks of the river, which is 900 feet broad, and thence to the sea is called the Pontianak. The city derives its importance from being the seat of the Netherlands' Resident, who rules directly and indirectly over the whole west coast, from 2° 56' S.—2° 50' N. lat., and 108° 45'—112° 50' E. long.; territories rich in vegetable and mineral wealth. The Residency is near Fort Du Bus, in 0° 2' N. lat., and 109° 1' 30" E. long.; other principal buildings being the sultan's palace, the mosque, and hospital. Pop. 7000, but rapidly increasing. Trade is the only pursuit in the town; and the rich alluvial lands are partly cultivated with rice, sugar-canes, cotton, indigo, coffee, provisions, and fruits.

Besides a number of small dependencies, the Netherlands' Resident at P. governs the important kingdoms of Landak, Mampawa, and Sambas, with the mining district of Montrado, in the north; Tayang, Simpang, and Matan or Succadana, to the south; and Sangouw, Sekadouw, and Sintang, in the interior. The produce consists of diamonds, gold, coal, tin, iron, wax, edible nests, pepper, gutta-percha, &c. There are many gold mines in Montrado and other districts; rich iron ores in Matan; gold, platina, copper, &c., in Sambas; and in former times, Landak was rich in diamonds, but the produce is now trifling. In this district was found the famed diamond of the Sultan of Matan, which weighed 367 carats. The annual produce of the mines in the Residency of P. is estimated at not less than 425,000 ounces of gold. In 1860, pop. 319,962, of whom 104 were Europeans, 24,080 Chinese, 294,123 natives, &c.

In 1856, the Dutch imports and exports were: P.—imports, £73,330; exports, £37,297. Sambas—imports, £18,312; exports, £25,267. In-bound ships at P. had a burden of 4083 tons; at Sambas, 2012½ tons: the outward-bound nearly the same. The other Netherlands' possessions in Borneo are called the Residency of the South-east Division, including the lands from Matan, in the south-west, along the south and east coasts to 0° 50' N. lat. The Resident's house is at Banjermassin, in the island of Tatas, 15 miles from the mouth of the Banjar, in 3° 34' 40" S. lat., and 114° 30' E. long. Pop. 30,000. The exports are—pepper, diamonds, gold-dust, coal, benzoin, wax, ratana, dragon's-blood, camphor, edible nests, iron, fire-arms, &c. Imports—piece-goods, powder, knives, opium, rice, salt, sugar, Chinese porcelain, silk-stuffs, corals, pearls, &c. The coal-mines of Orange-Nassau produced 15,979 tons in 1855. In 1861, on account of war between the natives and Netherlanders, it had fallen to 1839 tons. In 1856, the imports at Banjermassin amounted to £89,566, and the exports to £61,802. The in-bound ships had a burden of 12,859½ tons, and out-bound nearly the same. At Nagara, a town of 10,000 inhabitants, in Banjermassin,

are important factories of fire-arms and other weapons.

There has been constant war, on the south-east coast, since 1859. In 1860, the direct government of Banjermassin was assumed by the Resident, but (1864) the interior of the kingdom is still disturbed. In 1860, population of South-east coast Residency, 553,343, of whom 197 were Europeans, 1510 Chinese, 551,353 natives, &c. Government receipts in 1857 = £70,260; expenditure = £80,500.—See *Borneo's Westerafdeeling, Geographisch, Statistisch, Historisch* (P. J. Veth, Amsterdam); the latest Colonial Reports (1860) published by the Netherlands' government, &c.

**PONTIFEX** (of doubtful derivation) was the title borne by the members of one of the two great colleges among the ancient Romans, instituted for the purpose of preserving and cultivating religious knowledge; the other was the college of Augurs. See **AVGURES** and **AUSPICES**. It is customary to speak of the college of pontiffs as a 'priesthood'; it was not, however, strictly speaking, such—that is to say, the members were not charged with the worship of any particular divinity, nor did they conduct sacrifices. Their duties embraced the regulation of all the religious rites and ceremonies (both public and private) of a state—e. g., how the gods should be worshipped, how burials should be conducted, how the souls of the dead (*manes*) should be appeased. To them was intrusted the care of the calendar, the proclamation of festival days, &c. They also saw that every religious and every judicial act took place on the right day. 'As they had thus,' says Dr Mommsen, 'an especial supervision of all religious observances, it was to them in case of need (as on occasion of marriage, testament, or *arrogatio*) that the preliminary question was addressed, whether the matter proposed did not, in any respect, offend against divine law.' In matters of religion, they were the supreme authorities; from their decisions there was no appeal, and they themselves were responsible neither to the senate nor the people; further, they had power to inflict punishment on such priests as dared to disobey their injunctions, and deviate into schismatical courses. The words of Festus are: *rerum quas ad sacra et religiones pertinent, JUDICES ET VINDICES*. Their president was termed *pontifex maximus*.

The pontiffs, according to Roman tradition, were instituted by Numa—a mythical person, to whom the origin of nearly all the religious institutions of Rome is ascribed. But as they appear in all the Latin communities, they are regarded by Mommsen as a 'thoroughly national Italian institution,' and probably found a place in the earliest religious organisation of the Latin race. Their number was originally four, or, including the *pontifex maximus*, five, all of whom were taken from the patricians. In 300 B. C., the Ogulnian Law raised the number to nine, four of whom were to be plebeians. The first plebeian, however, who attained the dignity of *pontifex maximus* was Tib. Coruncanius, 254 B. C. Sulla, in 81 B. C., again increased the number to 15, and Julius Cæsar to 18. During the empire, the functions of *pontifex maximus* were generally discharged by the emperors themselves; and the name survived even the establishment of Christianity, occurring in inscriptions of Valentinian, Valens, and Gratianus; but at length the emperors dropped it, when it was picked up by the Christian bishops of Rome; and now this title, borrowed from a pagan cult, forms one of the sacred designations of His Holiness the Pope.

**PONTIFICAL** (Lat. *pontificalis*, belonging to a pontiff or bishop), one of the service-books of the

Church of Rome, in which are contained the several services, whether in the administration of sacraments, or the performance of public worship, in which the bishop exclusively, or at least a priest delegated by the bishop, officiates. There were many such collections for the various national churches; but that which is now in universal use throughout the Western Church is the *Pontificale Romanum*, or Roman Pontifical, as published by authority of Clement VIII in 1596, and repeatedly republished since that time. The P. contains the services for ordinations, for religious professions and receptions of monks and nuns, consecrations, benedictions, &c., as well as of the solemn administration by a bishop of those sacraments which are ordinarily administered by priests. Besides the prayers to be recited, the P. also lays down the ceremonial to be observed. The rules of this ceremonial are of two kinds—*preceptive*, the literal observance of which is obligatory; and *directive*, which admit of a certain interpretation.—Another of the service-books of bishops is called the 'Ceremoniale;' but it is chiefly confined to a description of the peculiar ceremonial with which bishops are required to celebrate solemnly those offices, as of the mass, vespers, the funeral office, &c., which are common to them with priests. The most prized editions of both these service-books are those published by authority of the learned pope, Benedict XIV.

**PONTINE MARSHES** (Lat. *Pomptina Paludes*), a low-lying district, forming the southern part of the Campagna di Roma, and extending in a south-easterly direction from Cisterna to the sea at Terracina. Its greatest length is about 30 miles, and its breadth from 4 to 11 miles. It does not reach the sea-coast on the west, being separated from it by a broad sandy tract covered with forest; but even this barrier partakes to some extent of the character of the marshes themselves, being quite as flat, and largely intermixed with swamp and lagoon. The P. M. have undoubtedly been formed by the stagnation of the streams that take their rise in the Volscian Hills, and by the accumulation of sand along the shore from Astura to the Circeian promontory, but this formation as undoubtedly belongs to pre-historic ages. There is no reason to believe that the P. M. were, in ancient times, essentially different from what they are at present. Pliny, it is true, on the authority of a contemporary, Mucianus, states that at one period they had contained 24 or even 33 cities; but no confirmation of this statement is to be found in any earlier writer, and not a single name of these cities has been preserved. The first attempt to drain the P. M. in ancient times was made in 160 B. C. by the consul, Cornelius Cethegus; but his efforts were only partially successful, for towards the close of the Republic, the region had become as marshy as ever. Julius Cæsar, among his vast schemes for the improvement of the commonwealth, projected one for the drainage of this pestilential district, but his murder prevented its complete realisation. Augustus also appears to have done something; but in the time of Juvenal, it was a mere haunt of robbers. Theodoric, the Goth, likewise tried to reclaim it; but the desolations of succeeding reigns soon reduced it to a hopeless condition, and it continued an uninhabitable region until the close of the middle ages. The first in modern times to resume the labours of the ancients was Pope Boniface VIII, who drained the district about Sezzo and Sermonetta by means of a large canal. In 1417, Martin V. made another canal, called the *Rio Martino*, which was dug to within a mile of the sea; but after his death, the project was given up. Several additional efforts were subsequently made;

but nothing was really accomplished till the time of Pope Pius VI., who, in 1778, commenced to drain the marshes, and completed the drainage in ten years. The reclamation of the land, however, has been found possible only in part. Though much is under cultivation and in pasturage, a great portion is hopelessly sterile; and the whole region is so unhealthy, that, in the summer months, the inhabitants are obliged to remove to the neighbouring mountains.—The famous Appian Way (q. v.) went through the P. M.; and after being unused for centuries, was re-opened by Pius VI.

PONTOON (through the French *ponton*, from the Latin *pons*, a bridge), the name given to buoyant vessels used in military operations for supporting a temporary bridge. Pontoon bridges have been constructed, with greater or less skill, from the earliest times. Darius passed the Hellespont and Danube by pontoon bridges, and the former was traversed by Xerxes' immense army on similar temporary bridges, very admirably formed. A pontoon train is a necessity for every army manœuvring in a country where there are rivers, and many campaigns have proved failures from the want of this cumbersome but indispensable apparatus. In most armies, the pontoons are under the charge of the engineers; but in the Austrian army there is a distinct and highly-trained corps, called *Pontonieren*. Marlborough used clumsy wooden pontoons. Napoleon and Wellington had them lighter of tin and copper. They were flat-bottomed, rectangular boats, open at the top. Anchored at stem and stern, beams were laid over from one to another, and transoms with planks crossing these beams completed the roadway of the bridge. These open pontoons were exposed to the disadvantage that they were very liable to be filled with water, and thus ceased to support the bridge. They were, moreover, very heavy, one pontoon, with appurtenances, constituting a wagon-load. As 36 were deemed necessary for the train, a pontoon equipment was a serious item in the *impedimenta* of an army. The open pontoons are now, however, obsolete, modern science having substituted closed cylindrical vessels of copper (or occasionally of India-rubber), which are far lighter, can in an emergency be rolled along, and can only be submerged if perforated. Against the last contingency, they are divided within into water-tight compartments, so that one perforation may not seriously detract from the total buoyancy of a pontoon. In the British service, two pontoons are used: the larger, with hemispherical ends, being 22 feet 3 inches in length, and 2 feet 8 inches in diameter; the smaller, cigar-shaped, with conical ends, 15 feet in length, and 1 foot 8 inches in diameter. Two of the largest used to form a raft weigh 8 cwt. 7 lbs.; the superstructure, 18½ cwt. At 24 feet apart from centre to centre, this raft, will carry infantry four deep, marching at ease; cavalry, two deep, and light field-guns; at 16 feet interval, heavy guns. A raft of three pontoons, at close distances, will support siege-ordnance. The pontoons can be used in very wide rivers as rafts, in their proper sense, or they can be connected, when the width permits, to form a bridge. In the latter case, each is towed into line, anchored above as it drops to its place, and a second time when its exact spot is reached. It is computed that each pontoon requires 1½ minutes to take its position, and that when the pontoons are placed, the roadway can be laid, if properly arranged previously, in 1½ minutes for each interval between two pontoons. A river of 600 feet may thus be bridged in less than 1½ hours. The process of throwing a bridge over in face of an enemy, is fraught with the utmost danger to the engineers employed.

Pontoon bridges have to be passed with great care, and every measure should be adopted, as breaking step, &c., which can reduce the peculiarly dangerous vibration.

PONTUS, the name given by the ancient Greeks to a country in the north-east of Asia Minor, bordering on the Pontus Euxinus (whence its name), and extending from the river Halys in the west to the frontiers of Colchis and Armenia in the east. Its southern limits were the ranges of Anti-Taurus and Paryadres, so that it corresponded pretty nearly to the modern pashaliks of Trebizond and Siwaa. On the east and south, P. is mountainous, but along the coast there are large and fertile plains, which in ancient times produced, and indeed still produce abundance of grain, fruits, and timber. Game, according to Strabo, was also plentiful. The rearing of bees was carefully attended to, and honey and wax were among the chief articles of commerce. Iron was the principal mineral.

Regarding the ancient inhabitants of P., nothing is known ethnologically. Greek colonies, indeed, flourished on the coast from the 7th c. B. C., and doubtless spread some knowledge of civilisation among the inland barbarians; but how far the latter were influenced thereby, we cannot tell. They first appear as divided into numerous tribes, virtually independent, but owing a nominal allegiance to the Persian kings, whose authority was represented by a hereditary satrap belonging to the royal family of Persia. It was one of these satraps, Ariobarzanes, who, by subjugating some of the Pontian tribes, in the year 363 B. C., during the reign of Artaxerxes II., laid the foundations of an independent sovereignty. Ariobarzanes was succeeded in 337 B. C. by Mithridates II., who took advantage of the civil confusions that followed the death of Alexander the Great, to enlarge his dominions; but the greatest of these Pontine sultans, and one of the most formidable enemies that Rome ever encountered in the east, was Mithridates VI. (q. v.). On the overthrow of this potentate by Pompey (65 B. C.), the western part of P. was annexed to Bithynia, and the rest parcelled out among the neighbouring princes. Subsequently, a grandson of Mithridates, Polemon, was installed monarch of the central part of P.; but in the reign of Nero, it was voluntarily ceded to the Roman emperor, became a Roman province, and was called *Pontus Polemoniacus*. In the reign of Constantine, it underwent a new division. The principal towns of ancient P. were Amisus, Polemonium, Pharnacia, Cerasus, Trapezus, Apsarus, Cabira, and Neocæsarea.

PONTYPOOL, a small market-town of Monmouthshire, 20 miles west-south-west of Monmouth, and 10 miles north of Newport, with both of which it is connected by railway. Japan wares were long made here, but this branch of manufacture has declined. Articles in polished iron are made, and the iron forges and coal and iron mines which surround the town employ many of the inhabitants. Pop. (1851) 3708; (1861) 4661.

PONY, the common name of many small active breeds of Horse (q. v.), belonging to different countries, from India and Africa to Iceland; but in the warmer parts of the world, chiefly found in mountainous or sterile regions. They are in general the property of man, and not truly wild, although, in very many cases, they live almost in a wild state, and receive no care or attention except when they are wanted for use. They are in general very hardy, and their strength is great in proportion to their size. They are often vicious, or at least playfully tricky to a much greater degree than is usual with larger horses. Ponies are very often covered

with rough hair, and have large shaggy manes and forelocks. The *Shetland P.* is a very good example of these small races of horse. The *Iceland P.* is scarcely different from it, and is hardy enough to endure the winter of Iceland without shelter. The *Galloway, Welsh, Dartmoor, Exmoor, and New Forest* breeds, are British races of *P.*, larger than the *Shetland*. The progress of enclosure and cultivation in their native regions has so changed the circumstances in which they long subsisted, and in which, perhaps, they originated, that scarcely any of them is now to be seen of pure and unmixed race. Sardinia and Corsica have small races of *P.*, which have subsisted unchanged from ancient times. In the Morea, there is a race of ponies, driven in herds to Attica for sale, exceedingly wild and vicious, but capable of being rendered very serviceable. But it is unnecessary to mention the many races both of Europe and Asia. They differ considerably in size, some, like the *Shetland P.*, suggesting a comparison with a large dog, some much larger. They also differ much in colour; a dun or tan colour, with a black stripe along the back, is prevalent in many of them. Ponies are seldom employed in agricultural labours; but they are of inestimable value in many wild and mountainous regions, from their hardiness and surefootedness; and are often used as saddle-horses, the largest kinds being even employed as horses for light cavalry.

**POODLE** (Germ. *Pudel*), a kind of dog, originally German, but extensively diffused throughout Europe during the wars of the French Revolution, and abundantly introduced into Britain by the soldiers who served in Spain and the Netherlands. It is very closely allied, however, to the coarser crisp-haired *Water-dog*, long well known in England, and particularly to water-fowl shooters and the fishermen of the north-eastern coasts. The *Barbet* of the French is a diminutive variety, much in request as a lady's pet. The *P.* is of a stout form, and has a short muzzle standing out abruptly from the face; the ears are of moderate length, and pendent; the tail rather short; it is everywhere covered with long curled hair, which in many of the little barbets hangs to the very ground. No kind of dog exhibits greater intelligence or greater affection; and as to both, many interesting stories are on record.

**POOLE** (so called from the inlet or *pool* on which it stands) is the chief seaport of Dorsetshire, and is situated on a wide but shallow inlet in the east coast of the county. It is built of red brick, is intricate and confused in plan, but is pierced by the High Street, a mile in length. Along the shore are capacious quays, well lined with shipping. The town is more noted for its trade than for its architecture. Sail-cloth and cordage are manufactured, and, together with potters' and pipe clay, provisions, and articles of clothing, form the principal articles of export. Ship, and especially yacht building is carried on. The harbour, into which fall the rivers Trent and Frome, is a beautiful estuary, and is a fine feature in the charming scenery of the vicinity. Its depth of water is 13 to 14 feet, and its navigable channels, being unobstructed by rocks or sands, are perfectly safe at all times. Brownsea Island, in the middle of the pool, is 6 miles in circumference. On its extreme point stands the castle of the same name. In 1863, 1315 vessels, of 89,502 tons, entered and cleared the port. Pop. (1861) 9759, who return two members to parliament.

**POOLE, MATTHEW**, a learned English divine of the Puritan age, was born at York about the year 1624, and educated at Emmanuel College, Cambridge. Very little is known regarding his life.

In 1662, he figures as preacher in the church of St Michael le Querne, in London; but was one of the 2000 ministers whom the Act of Uniformity compelled to leave the Church of England. Subsequently, he retired to Holland, and died at Amsterdam in 1679. His principal work, *Synopsis Criticorum Biblicorum* (5 vols. fol. 1669—1676), is an attempt to bring together in a condensed form the opinion of 150 biblical critics of all times and countries previous to his own. It is a work shewing great (professional) learning, and very respectable talent; but later criticism and research have done much to render it obsolete. Other productions of *P.*'s are *Annotations on Scripture*, and *The Nullity of the Roman Faith*.

**POONA, or PUNA**, the capital of a district of British India, of the same name, in the presidency of Bombay, is situated on the small river Moota, near its confluence with the Moola, in a treeless plain about 74 miles south-east of Bombay. Its present population is estimated at about 100,000; but in its palmy days, when it was the capital of the Mahratta power, it contained twice that number. A large proportion of the population consists of Brahmans. The city is divided into seven quarters, named after the days of the week, and the principal building is a palatial structure, formerly the residence of the Peishwah. Its climate is salubrious and pleasant, and it is the headquarters of the Bombay army. The cantonment for the infantry and horse-artillery is from one to two miles west of the city. The cantonment for the cavalry is at the village of Kirkee, about two miles to the north-east of the city. In 1821, soon after *P.* came into the possession of the British, a college was established for the study of Sanscrit literature, in the hope that the disaffected Brahmans (who had been all-powerful under the Peishwah) might be thus conciliated. As the modes of instruction originally adopted were entirely native, and far from efficient, the college has gradually been transformed. At present, it possesses a staff of European professors with native assistants, and is a highly respectable seminary for the study of English, Marathi, and Sanscrit. Only Brahmans were admissible into the college as first established; now it is open to the public generally. *P.* is very much resorted to, particularly in the rainy season (from June till October) on account of its pleasant and salubrious climate. The fall of rain averages from 22 to 25 inches annually; whereas at Bombay it is about four times as great. The range of the Ghauts (properly called the Sahyadree range) which rises up as a precipitous barrier 2000 feet high, with peaks considerably higher, receives the full burst of the monsoon; so that Khandalla on the top of the Ghauts is drenched with almost perpetual rain for four months. Then the clouds pass on, relieved of their watery burden, and the rainfall eastward of the Ghauts is much less. From the Ghauts, the whole country gradually slopes towards the Bay of Bengal. *P.* is about 1800 feet above the sea-level. One of the most interesting objects in the neighbourhood of *P.* is a large *bund*, or embankment, solidly built of hewn stone over the Moota-moola river for the purpose of providing a supply of water for the cantonment, and especially the bazaar or native town connected with it. It was built by the late Sir Jamsetjee Jeejeebhoy, whose charities were very great. Two forts celebrated in Maratha history are close to Poona-Singhur, about 12 miles to the south-east, and Poorundur, about 18 miles to the south. These are favourite sanatoria during the hot season (from the end of February to June). At Poorundur there is a sanatorium of considerable size for sick soldiers. *P.* was formerly a great mart for jewellery and precious

stones, but the trade in these things has quite ceased. The native manufactures have also been supplanted by the introduction of European piece-goods, and the only business that prospers is that of dealers in grain and other agricultural produce. The railway has rendered P. almost a suburb of Bombay. The works by which the railway climbs up the great mountain-barrier of the Ghauts from the low lands of the Konkan to the high table-land of the Deccan are among the boldest that have as yet been undertaken. The line up the Ghauts was opened in April 1863.

At present, great alterations are taking place around Poona. The native city has not of late years greatly altered, except that the streets have been widened and cleaned; but the cantonment is changing rapidly. The number of new buildings reared within the last three or four years is very great. Among the most striking of these will be, when it is finished, the Government College—a Gothic building, erected mainly at the expense of Sir Jamsetjee Jeejeebhoy. While speaking of education in Poona, it is but fair to the Scottish mission to say that it commenced English education in P. soon after the mission was established (in 1831), and has all along carried it on. The schools of the mission, both male and female, both for English and the vernacular (Marathi), are largely attended, even by the highest castes. The female pupils are upwards of 300 in number; and one school consists of Musulman girls. The Musulmans in India generally are far behind both Hindoos and Parsees in their desire to educate the females; in fact, a Musulman female school is as yet exceedingly rare.

POONA-WOOD is the timber of the Poon trees of India (*Calophyllum inophyllum* and *C. augustifolium*). It is very commonly used in the East Indies, particularly in ship-building, for planks and spars; these latter are usually called *Poon*, and are in general use for masts in that country. The trees are natives of Penang, and of the countries eastward of the Bay of Bengal.

POOP, in large vessels, is a sort of supplemental deck raised over the after-part of the upper deck. The best cabins are situated beneath it. In old ships, a second and even a third poop were raised above the hinder part of the poop proper, giving the vessels that immense height at the stern which is shewn in old drawings. The poop is gradually disappearing from ships built either for speed or war, as offering undue resistance to the wind in one case, and an undesirable mark to an enemy in the other.

POOR AND POOR-LAWS. Charity, like Christianity, had its origin, or earliest development, in the East. Among the primitive nations of the world, almsgiving was inculcated as a religious observance, and is prescribed as such in their sacred records. Among the European nations of antiquity, we find a provision for the poor adopted as a matter of state policy. In early times, Athens could boast of having no citizen in want; 'nor did any disgrace the nation by begging.' But war, at length, brought poverty in its train, and the Athenian people decreed the maintenance of those who were mutilated in battle; and, at a later period, of the children of those who fell. Plutarch mentions Peisistratos as the originator of the first decree, though others derive it from Solon. By the latter decree, the state provided for the orphans of its soldiers up to their eighteenth year, and then sent them into the world with a new suit of armour. The bounty given to the disabled is mentioned by Lysias, Harpocration, Aristotle, Isocrates, and others; and is variously stated at one, two, and

three oboli a day, and it seems to have been increased with the increased cost of subsistence. There were also societies for the relief of distress among the democratic states of Greece, called *Erano*—a sort of friendly society, in which the members relieved were expected to pay back the money advanced to them, when they had raised themselves to better circumstances. But it must be remembered that these so-called democratic states were in reality slave-holding aristocracies.

Among the Romans, the Agrarian and Licinian laws (years of Rome 268 and 338) were framed in order to prevent the extremes of riches and poverty in the state. They limited the extent of property in public land to be held by each citizen, and the latter directed that all such land, above the allotted portion, should be taken away from the holders, and given to those who had none. The distribution of grain at reduced prices, which at length became gratuitous, was introduced by Caius Gracchus, and lasted till the fall of the Roman empire. Augustus in vain tried to suppress it. In his time, 200,000 citizens were thus fed. Cicero makes mention of this provision as in great favour with the Roman people, because it furnished them with an abundant subsistence without labour; other Roman writers describe its results as disastrous both to agriculture and manners, creating a nation of mendicants, and causing the land to fall out of cultivation.

In the middle ages, the great body of the labouring classes were in a state of bondage, and looked to their feudal lords for maintenance. The obligation to provide for their slaves, or serfs, seems to have been fully recognised, so that many encountering, in a state of freedom, the miseries of want, went back to bondage as a refuge from destitution. The villeins in Saxon England were attached to the soil, and received from their lord a portion of land for the support of themselves and their families. But the church of Rome constituted herself the great receiver and dispenser of alms. The rich monasteries and abbeys distributed doles to the poor. Fuller, in his *Church History*, says that these alms 'made and maintained the poor,' so that beggary became a trade to which an apprenticeship was served; and Mr Hallam, in his *Constitutional History*, says the blind eleemosynary spirit of the church 'was the cause, not the cure of beggary and wretchedness.'

In the Catholic states of Europe at the present day, the church still remains, to a great extent, the public almoner. In Rome, a Commission of Aids has the general direction and administration of the principal public charities. It is composed of a cardinal-president and 15 members, among whom is the pope's chaplain. The city is divided into twelve districts, over each of which a member of the central council presides. Each parish is represented by its curé and two deputies—a layman and a *dame de charité*, named for three years—and has a secretary and a steward or treasurer, who are paid. The alms are given in money, tools, and clothes. Requests for assistance are addressed to the parochial body, from which they are sent to the district, and thence to the central council. The more urgent cases are referred to the cardinal-president, or the curé of the parish. Three brotherhoods search out cases of hidden poverty; and not only do all the religious associations, convents, and monasteries distribute relief, but there is hardly a noble or wealthy house which does not take a regular part in the assistance of the poor.

In Spain, the state supports several asylums for lunatics, the blind, and deaf and dumb. It also distributes a large sum annually among the provinces for the relief of the poor—each province being bound

## POOR AND POOR-LAWS.

to raise double the amount received from the state. The state also steps in for the relief of great calamities, and devotes a certain sum annually for the assistance of unfortunate Spaniards abroad. A general directory of the charitable and sanitary services superintends the parochial bodies charged with the distribution of assistance to the poor.

In Austria, each commune is charged with the relief of its poor. All who have legal domicile, or being unable to prove their domicile, are resident in the commune, are entitled to relief out of the general assessment. There is no special rate, and the administration is strictly municipal. In many provinces, private charity is associated with public assistance, administered by the curé, a few chosen inhabitants, who are called 'Fathers of the Poor,' and an officer accountable to the commune. This system is called the 'Poor's Institutes;' and their funds are principally derived from private sources; but they receive a third part of the property of ecclesiastics who die intestate, and certain fines, &c. Applicants are subjected to minute inquiry as to the cause of poverty, and a weekly allowance is made on a scale according to age and necessity. The infirm poor, who have no relatives to reside with, are taken into hospitals established in almost every commune, where they receive, besides lodging, fire and light, clothing, medical care, and a small allowance in money to provide for their food and other wants. Children are either provided for in the homes of their parents, put into asylums, or boarded with people of probity, who receive a monthly payment, as in Scotland. The welfare of these children is superintended by the curés, the maires, and the sanitary officers of the commune. Foundlings, lunatics, the blind, deaf, and dumb, are provided for by the state. Vagrancy is punished, and parents permitting children under fourteen to beg are liable to three months' imprisonment. Able-bodied vagrants are sent to houses of correction, and kept to work. Pawnbroking is a charitable institution in Austria, under government control; and many pawnbroking establishments rest on endowments, and lend without interest. The trade is forbidden to private persons.

In France, the relief of the poor is not compulsory, in as far as its distributors may, after making inquiry, refuse relief, except in the case of foundlings and lunatics. The Minister of the Interior has a general superintendence of the machinery of relief, as well as the immediate administration of many large hospitals and refuges. He also assists a great number of private charities. The other ministers of state give assistance on the occurrence of great calamities. The departmental funds are called upon for the compulsory relief, but the commune is the main source of public assistance. Its duty is to see that no real suffering remains unrelieved, and that the nature of the relief is such as can most easily be discontinued when the necessity ceases. The commune encourages and stimulates voluntary charities, and receives gifts for the benefit of the poor's funds. Except in Paris, the administration of the hospitals, and of the relief given at the homes of the poor, are under different management, the communes only interfering to supplement the funds of the hospitals, when these are insufficient. The maire is president both of the administration of the hospitals and of the body for giving out-door relief (the *bureau de bienfaisance*). During industrial calamities, the poor are sometimes employed in workshops supported by the public, and in public works. In Paris, since 1849, there has been a responsible director set over all the charities of the city. He manages the out-door relief through the medium of the Committees of Assistance, formerly

called *bureaux de bienfaisance*, in each *arrondissement*. He is under the inspection of a council, composed as follows: The Prefect of the Seine (president), the Prefect of Police, two members of the Municipal Council, two maires or deputy-maires, two members of the Committees of Assistance, one councillor of state or a Master of Requests, one physician and one surgeon practising at the hospitals, one professor of medicine, one member of the Chamber of Commerce, one member of the Council of Prud'hommes, and five members taken from other classes than those above mentioned. Begging is forbidden, and punished, wherever there are establishments for the relief of the poor.

In the Hanse Towns, there was introduced, in 1788, a system of voluntary contributions aided by fixed subsidies from the government. This at length resulted in government supplying all deficiencies, which in the last few years have been 80 per cent. of the cost of the general poor relief. In Holland, pauper colonies have been supported by government for the last forty years. Vagrants, after a short imprisonment, are sent to one of these, under a system of discipline quite as rigorous as an Irish intermediate prison. Paupers of good character are sent to maintain themselves and their families, by agricultural labour, in free colonies. The working of the system is pronounced costly and unsatisfactory.

In America, the system is very similar to our own. Every man is entitled by law to relief from the town of his settlement, the rate being assessed on whole towns, and not on parishes. The States have their own poor-laws, but paupers are removable from one state to another. Any American becoming a pauper loses his state rights. The acts concerning Workhouses and Paupers in the Revised Code of Massachusetts may be taken to represent generally the state of the law throughout the Union. The former provides 'that any town may erect or provide a workhouse for the employment and support of all poor and indigent persons that are maintained by, or receive alms from the town; all persons who being able to work, and not having means to maintain themselves, refuse or neglect to work; all persons who live a dissolute vagrant life, and exercise no ordinary calling or lawful business; and all such persons as spend their time and property in public-houses, to the neglect of their proper business, or by otherwise mis-spending what they earn, to the impoverishment of themselves and their families, are likely to become chargeable to the town or the commonwealth.' The idle and the vagrant may be committed to the workhouse, and kept to labour, as in a house of correction. There are provisions for enforcing the claims of kindred, and for the immediate relief of strangers. The administration is in the hands of overseers, who have discretion as to the mode of relief.

The annals of the poor in England are neither short nor simple. Severe enactments for the repression of vagabondage and mendicancy date from a very early period. In ancient Saxon times, the householder was bound to provide for the labourer, and men who had no master were, by the Folkmote, assigned to some householder; but when freedom began to prevail, this state of things naturally came to an end. No master was bound to provide for the freeman, and when he failed to provide for himself, by honest labour, he generally took to vagrant begging, often to violence. The statute of Winchester (13th Ed. I., 1285) shews the poor utterly uncared for, and the roads infested by vagrant robbers. Up to the reign of Richard II., the sole idea of English rulers was to treat pauperism as a crime, and repress it by punishment, and by the

ment us just and absurd restrictions on the freedom of labour. The 23d Ed. III forbids giving alms to vagrants, on pain of imprisonment; then also the laws of settlement had their origin in the attempt to chain the free labourer to the land. See SETTLEMENT. The 12th Richard II (1388), c. 7, is the first statute that makes provision for the impotent poor. The statutes of Henry VII endeavour to carry out, by the severest measures, the system of repression. The 27th Henry VIII, c. 25 (1535), introduced the principle of compulsory assistance, though it was by way of voluntary alms. Each parish was ordered to receive and provide for the impotent, and set the able-bodied to work. Alms were to be collected into a general fund, and indiscriminate almsgiving was forbidden, on pain of forfeiture of ten times the value given. The sturdy beggar was treated without mercy, was to be whipped when first caught, next to have his ear cropped, and for a third offence, to suffer death, as a felon and enemy to the commonwealth. This is repealed by 1st Ed. VI, c. 3 (1547), because, 'through foolish pity, it is rendered of non-effect.' Not much milder, to modern ideas, seem the substituted penalties—viz., branding, on first conviction, with a V on the shoulder, and being adjudged a slave for two years, to be claimed by any one, fed on bread and water, and caused to work by beating, &c. Running away from this tender treatment was punishable with S branded on the face, and slavery for life to the town or parish, on the roads of which the incorrigible vagrant was to work in chains, at the penalty of the town or parish. Other two acts of Edward's reign return to earlier and considerably milder measures of restraint. A little urging was now found necessary to obtain funds for the maintenance of the poor. The collectors were gently to ask every man and woman at church what they would give; but if one could not be persuaded, the bishop was to send for the recusant, and use 'charitable ways and means.' At length, the 5th Elizabeth c. 3 (1563), provided that he who obstinately refused to give should be handed over to the more persuasive arguments of the justices, who were empowered to tax him at their discretion, and send him to jail for default. Ten years later, the power of compulsory assessment is given to the justices, and abiding-places are ordered to be provided for the aged and infirm. These statutes culminated in the 43d Elizabeth, c. 2 (1601), which has formed the basis of the poor-law system of England up to the present time. It taxed every inhabitant of every parish for the relief of the poor. It directed the justices in every county to appoint three or four substantial householders in each parish to be overseers of the poor, along with the churchwardens. It ordered the relief of the impotent, and the apprenticing of children, and the providing of work for the able, by means of 'a convenient stock of flax, hemp, wool, thread, iron, and other necessary ware and stuff.' The great act of Elizabeth came but slowly into operation. Up to the reign of Charles I., there were many parishes in which no rate was assessed, and which turned away their poor; but the great evils had been remedied, and there is little legislation on the subject for the next hundred years. The 3d William and Mary, c. 2 (1691), an act relating chiefly to settlement, provides that the persons to be relieved be registered and examined by the vestry, because evils had arisen out of the unlimited power of the churchwardens and overseers giving relief 'for their own private ends,' by which the charge on the parish was greatly increased, contrary to the true intent of the statute of Elizabeth. This act also gave power to the justices to order relief in cases of emergency, a

provision which afterwards became a fruitful source of difficulty. The evils henceforth complained of were, that many had thrown themselves on the rates who ought to have been supporting themselves independently of such aid; that pauper labour was found interfering with and displacing industrial labour; that the overseers were acting with unchecked dishonesty; and justices, with unrestrained liberality, ordering the money of the industrious and prudent to be spent upon the idle and improvident. Efforts were made to remedy these abuses throughout the reigns of the first three Georges, by making the justices act with the overseers, by rendering the overseers accountable to the parishioners by means of returns and the power of inspection, and by the offer of the workhouse to all applicants for relief. This last provision, made in the reign of George I (9th Geo. I., c. 7, 1723), substituted what is called in-door relief, for the allowance made to the poor at their own homes, and introduced the workhouse system. All who refused to be lodged in the house, were to be struck off the poor's-roll, and refused relief. A great increase in the number of workhouses took place; guardians were appointed to guard the pauper children from neglect and improper conduct, and other attempts to improve their administration made; Work-house Unions were also introduced by an act called Gilbert's Act (1782), and a succession of acts passed for the protection of parish apprentices. Towards the close of the 18th c. a great relaxation took place in the treatment of the poor. The 36th Geo. III, c. 10 and 23 (1796), increased the amount, and extended the application of relief. It repealed the act forbidding relief to those who refused the workhouse, and allowed relief to be given in aid of wages. Henceforth, out-door relief became the rule under a variety of systems, of which the complaint was justly made, that they turned the poor-laws into a mode of paying wages. In 1801, the amount of the rates was reckoned at £4,000,000. In 1820, it had risen to £7,330,254. In 1817, a commission of the House of Commons stated their opinion, that, unless checked, the assessment would swallow up the profits of the land. Though the two Vestry Acts, which resulted from the commission appointed in 1817, seem to have done something to remedy the evils complained of, a new commission to inquire into the operation of the poor-laws was found necessary, and appointed in February 1832. The evidence brought before this commission revealed a disastrous state of things. The independence, integrity, industry, and domestic virtues of the lower classes were in some places nearly extinct. The great source of the evil was shewn to be the relief afforded to the able-bodied on their own account, and that of their families, in aid of wages. This aid at first reduced the expenditure in wages, and found favour with farmers and magistrates, who framed scales of relief in accordance with the wants of the people, so that they began to be paid for their necessities, and not for their industry, and fell into the temptation of increasing the former, and neglecting the latter. Five modes of out-door relief were found in operation: 1. Relief without labour; 2. Allowance given, in aid of wages, according to the number of the labourer's family; 3. The Roundmen system, the labourers being let out, by the parish, among the employers round; 4. Parish work, generally on the roads; 5. The labour-rate, the ratepayers preferring to divide among them the pauper labour, and to pay for it, however valueless, instead of raising a rate. Diminished industry ate away the very root of capital. Farmers turned off their men, or refused to employ them at low wages, thereby causing a surplus of unemployed

## POOR AND POOR-LAWS.

labour fraudulently; they then took them back from the parish at reduced wages, paid out of the rates. Under the system of allowance, there were parishes in which every labourer was a pauper, paid more for idleness than he could get for labour, paid more if he took a pauper wife, and still more for every pauper child. Paupers married at 17 and 18 years of age, and claimed the allowance the day after their marriage; and from parish after parish came the reply to the queries of the commissioners: 'All our able-bodied labourers receive allowance.' No poor man in such parishes could save; if industrious and thrifty, and it was known that he had a fund of savings, 'he would be refused work till the savings were gone,' and he had come down to the pauper level. This had gone on, till in many places pauperism swallowed up three-fourths of the rent. Nor was the mal-administration confined to the rural districts; the evidence shewed that it extended all over the country, and into the manufacturing towns, where the out-door relief was a source of constant imposture. The administration of in-door relief was also full of abuses, from want of classification, discipline, and employment. Better food and lodging was provided for idle paupers than working-people could procure—better, even, than could be afforded by many of the ratepayers. In 1834, the commissioners reported that they found the administration 'opposed to the letter and spirit of the law, and destructive of the welfare of the community.' The commissioners strongly laid down the principle, that the condition of the pauper ought to be below the lowest condition of the independent labourer, because every penny bestowed in rendering the condition of the former more eligible than that of the latter, is a bounty on indolence and vice, and recommended:

1. The cessation of out-door relief;
2. A central authority to control the administration;
3. Unions for the better management of workhouses, and the classification of their inmates;
- and 4. A complete and clear system of accounts.

The bill embodying these recommendations was brought in, March 17, 1834, passed its second reading in the House of Commons with only twenty dissenting votes, and became law on the 14th August as the 4th and 5th Will. IV. c. 76. This act was not a change of law, but of administration. The orders of the new board restricted overseers, on the formation of a union, to the collection of rates; appointed paid relieving-officers to dispense relief under the directions of the unpaid Boards of Guardians; required the gradual withdrawal of out-door relief; and enforced classification and discipline in the workhouses. A rapid formation of unions took place under the new board. In the first eight months, 112 were formed out of 2066 parishes. The pauperised districts experienced a great and immediate relief, numbers of paupers going off when they found that relief involved adequate work, or the strictly-disciplined workhouse; wages rose, and the expenditure was reduced, on an average, 20 per cent. At the accession of George I. in 1714, the poor-rates amounted, as nearly as can be estimated, to £950,000, equal to 3s. 3½d. per head on the population of 5,750,000. At the accession of George III. in 1760, the population had increased to 7,000,000, the poor-rates to £1,250,000—an average of 3s. 6½d.; while in 1834, the population, estimated from the last census, was 14,372,000, and the money expended in relief, £6,317,255—equal to 8s. 9½d. per head. In three years, the operation of the Amendment Act had reduced the expenditure one-third, viz., to £4,044,741. In 1848, the commissioners were exchanged for a public board, which is one of the government departments, with a president, in whom has been

vested the power of the commissioners, and who holds office as one of the ministers of the crown. There are 631 unions. In 1860—1861, the number of poor receiving relief in England was about 850,000, about 4½ per cent. on the population: of these, about 140,000 were relieved in workhouses. The commissioners were unable to withdraw out-door relief, which continues to be in England the most important item. With the aged, the sick, and orphans, the guardians deal at their discretion; but stringent rules for the relief of the able-bodied are in operation under the board, whose orders have the force of laws. In the rural districts, guardians are prohibited from giving relief to the able-bodied out of the house, unless under a supplemental order, in emergency. For other places, the general rule forbids relief to be given in aid of wages, and requires work to be supplied. Exceptions are made by the board on the application of the unions when necessity arises, as in the recent case of the cotton districts. The expenditure is strictly guarded and examined by public auditors, of whom there are fifty-four for England. A district medical officer, of whom one or more are appointed for each union, attends to all cases of sickness among the poor.

Scotland and Ireland have been legislated for separately. Their poor-laws are similar to the English in principle and practice; both are administered by a Central Board, which supervises the local bodies charged with relief, and in both the rate is levied on the annual value of real property. The present system in Scotland was instituted by the 8th and 9th Vict. c. 83 (1845). Scotland is divided into 883 parishes, some of them combined for workhouse accommodation. The relief is administered by a parochial board, appointed by the ratepayers, the burgh magistrates, and the kirk-session. They appoint inspectors of the poor, who act as relieving-officers. The Scotch law differs from the English and Irish in allowing no relief to able-bodied adults. Claimants must be aged, infirm, or disabled. Out-door relief is the rule. Since the introduction of the poor-law system into Scotland, the extreme misery which formerly prevailed has been greatly modified, though with some sacrifice of that independence of feeling for which the humbler orders of Scotch were at one time celebrated. As regards the working of the Scottish poor-law, its great and acknowledged defect is the constant and costly contest respecting settlements, or right to fix claims on particular parishes; and so grievous has this become that some remedy would need to be applied. In 1862, Scotland had only 39 workhouses, in connection with 188 parishes.—Ireland had no poor-laws until the year 1838, when they were introduced by the 1st and 2d Vict. c. 56. For the purpose of relief, Ireland is divided into 163 unions of townlands or parishes. Each union has a workhouse managed by a Board of Guardians, elected by the ratepayers. Every destitute person has an absolute right to relief, which is administered almost entirely in the workhouse. The average yearly population of the United Kingdom during the ten years ending 1860, was 28,104,000; average paupers in each year, 1,109,275, or 3·9 per cent. They were apportioned as follow:

	Population.	Paupers.	Per-centage.
England, . . . .	18,901,000	892,671	4·7
Scotland, . . . .	3,008,000	120,624	4·
Ireland, . . . .	6,193,000	96,860	1·5

The total expenditure in the United Kingdom during the ten years was £67,341,921, or an annual charge



POOR.

of 4s. 9d. per head on the average population of the period, apportioned as under :

	Amount of Assessment.	Per head per annum.
England and Wales, . . . . .	54,767,618	5 9½
Scotland, . . . . .	5,917,334	3 11½
Ireland, . . . . .	6,656,748	2 1½

The rate, which in the year ending 25th March 1861, was 5s. 9d. per head on the population, amounted to £5,778,943, rose in 1862 to 6s. per head, amounting to £6,077,927, and in 1863, to 6s. 4d., amounting to £6,527,036. The reports for these years show that this increase is entirely due to the distress in the cotton manufacturing districts.

There is no poor-law in our Australian colonies, but benevolent asylums for the infirm and destitute have become general, and hospitals are numerous in all the rising towns in the gold-fields.—Compare Böckh's *Public Economy of Athens*, translated by Sir G. C. Lewis; M. Dureau de la Mall's *Economie Politique des Romains*; *Report of the International Statistical Congress* (1862); *Dictionnaire de l'Administration Française* (Paris, V. Berger-Levzault et Fils); Sir George Nichol's *History of the Poor-laws*; *Report of the Poor-law Commissioners* (1835); *Reports of the Poor-law Commission and Poor-law Board from 1835 to 1862*.

**POOR, GENERAL LAWS AS TO.** The fundamental rule as to the relief of the poor is, that each parish in England and Wales is bound to maintain its own poor. For the purpose of providing the requisite machinery, overseers are required to be appointed in each parish every year on the 25th March, or within a fortnight following; and these, along with the churchwardens, who are *ex officio* overseers, have the duty of providing the requisite funds. See **OVERSEERS**. This is done by means of a poor-rate, which the churchwardens and overseers may levy on all the occupiers of land in the parish, after such rate has been confirmed by the justices. The rate specifies a certain sum in the pound which is to be levied, and the annual value of the various lands is then specified, and the amount is thus easily computed. The rate is thus a local tax on the occupier of the land, and not on the owner, unless he himself is also occupier. In all cases, the duty of raising the funds attaches to the overseers; but the actual distribution and application of them are not always in their immediate control. Owing to the mischiefs arising from the officials of each parish distributing the funds at their discretion, without uniformity of plan, a central controlling power was created in 1834, in the shape of the Poor-law Board; and authority was given to combine various parishes into one poor-law union, for the purpose of greater uniformity as well as economy. When a union is formed, the control of the expenditure is chiefly vested in the guardians of this union, who are elected by each parish, and who supervise the management of the union workhouse. They order the overseers of each parish to raise their due proportion of funds, by a contribution order issued to such overseers, who are thereon bound to levy the amount by including it in the next poor-rate. The guardians are bound to contract for the provisions, clothing, fuel, &c., supplied to the workhouse, by means of sealed tenders, unless the quantity is less than a stated amount. They pay all the expenses of prosecutions for disobeying the orders of the Poor-law Board and kindred offences. The principle on which relief is administered to the poor is, that the condition of the pauper should not be so comfortable as that of the lowest independent labourer;

otherwise, idleness and imposture would be encouraged to an indefinite extent. The guardians profess only to relieve destitution already existing, and not to enable persons to keep off impending destitution. Hence they only supply the bare necessities of life. They cannot, for example, advance or lend money to set up a poor person in trade. Minute regulations are contained in the consolidated orders of the Poor-law Board as to the classification of paupers in the workhouse, mode of admission, diet, discipline, and out-door relief. With regard to out-door relief and able-bodied paupers, it is provided, that every able-bodied person requiring relief from any parish, shall be relieved wholly in the workhouse, together with his wife and family, if any, and if not otherwise employed. But the relief may be given out of doors in cases of sudden and urgent necessity, of sickness, accident, and a few other cases. In general, relief is confined to persons actually residing in some place within the union, except in case of casual destitution, or sickness and accident. Whenever out-door relief is given to an able-bodied person, half of it is to be in the form of articles of food or fuel. Relief is given only weekly, where the pauper is not required to be received into the workhouse. No relief is to be given to able-bodied persons while they are employed for wages or hire by any person; and every able-bodied male person, if relieved out of the workhouse, shall be set to work by the guardians, and kept so employed while he continues to receive such relief. The law with regard to the relief of the poor is so far qualified, that wherever a person applies for parochial relief, if he or she has a father or grandfather, mother or grandmother, or child, who is able to maintain such pauper, then the parish officers can obtain an order from justices to compel such relative to contribute a sum towards such maintenance. So husbands or fathers of paupers are bound to contribute to such maintenance. In all cases, the pauper is relieved either in the workhouse or out of the workhouse, according to the regulations of the poor-law orders. In some cases, the guardians or overseers may employ the poor in public works; but this is seldom done, except on occasions like the Lancashire distress. The law as to the settlement of the poor is somewhat intricate, and gives rise to much litigation. There are various grounds on which this settlement is acquired. Thus, every person has, *primâ facie*, a settlement in the parish where he was born, until some other is proved; and there are so many other qualifications, that it is seldom a birth-settlement is resorted to. By marriage, a woman immediately acquires the settlement of her husband, if he has one, whether the husband be an Englishman or a foreigner. If the husband has no settlement, then the wife is thrown back on her maiden settlement. Formerly, a person acquired a settlement in a parish by hiring and service, and by residence for forty days under such hiring; but since 1834, no such settlement can be acquired. If any person shall be bound an apprentice by indenture, and reside forty days under such apprenticeship, he or she acquires a settlement thereby. So whoever shall rent a tenement in a parish, and actually occupy the same, and be rated to the poor for one whole year, the rent being not less than £10, and paid by the person so actually occupying the tenement, shall acquire a settlement. So a person acquires a settlement by acquiring an estate in land, however small in value, and residing forty days in the parish. So, if a person buy an estate, and the consideration amount to £30 at least, he shall thereby acquire a settlement. Formerly, a settlement was acquired by serving a public annual office, such as that of constable,

overseer, &c. ; but no settlement is now acquired on that ground. Unless a pauper has acquired a settlement on one or other of the grounds before mentioned in the parish or union where he receives relief, he is liable to be removed compulsorily to the parish where he last acquired a settlement. Certain persons, however, cannot be removed, and these are called irremovable paupers. Such are those paupers who have resided for three or more years in the parish or union in which they became destitute. The mode of computing these three years is, however, somewhat difficult in certain cases. While a pauper is irremovable, the expense of his relief is charged, not to the parish, but to the union fund. When a pauper is sought to be removed, it is necessary to take him before two justices of the peace for examination ; and on proper evidence of his settlement, the justices will make the order of removal, which is an authority to the overseers to take or send the pauper to the overseers of the parish of settlement. If, however, the pauper is too ill at the time to admit of removal without danger, the justices may suspend the order of removal till he is recovered. Whenever a pauper is to be removed, the removing parish is bound to give notice to the parish of settlement ; and it is on these occasions that so many obstinate and costly litigations take place as to which is the parish of settlement, for after a removal order, the costs of relief must be borne in future by the settlement parish. The latter parish may appeal to the Court of Quarter-sessions against the removal order ; and the Quarter-sessions may state a case for the opinion of the Court of Queen's Bench, if any nice point of law should arise, as frequently happens.

In Scotland, there was no systematic provision for the relief of the poor until 1845, when the statute of 8th and 9th Vict. c. 83 was passed. By this statute, a central board (called the Board of Supervision) was established, which controls the parochial board of each parish or union of parishes in a manner similar to the Poor-law Board in England. A settlement can be acquired in Scotland by residence of five years. Children follow the settlement of their parents, and wives that of their husbands ; and if no other settlement be proved, then the settlement of birth is liable. In Scotland, the mode of assessment differs from that in England, where only the annual value of lands and tenements can be rated in the hands of the occupier. The parochial board had the option of three modes of assessment : 1. One half to be paid by owners, and one half by the occupiers ; 2. One half to be paid by owners of lands, and the other half to be paid by all the inhabitants, according to means and substance other than lands ; 3. Assessing owners of lands and other inhabitants rateably according to their means and substance. But by a later act of 24th and 25th Vict. c. 37, the mode of assessing means and substance is abolished. It will thus be seen that in Scotland the poor-rate can never be imposed wholly on the occupier as it always is in England.

In Ireland, a Poor-law Act was also recently passed, and numerous amending statutes have followed, the code of laws being substantially founded on the English acts.

There are special acts of parliament regulating the conditions on which paupers are removable between England, Scotland, and Ireland respectively.

**POOR-RATE.** See **POOR** ; **OVERSEERS**.

**POOR'S-ROLL,** in the practice of the law of Scotland, means the list of poor persons who are litigants, but unable to pay the fees of court, and

therefore are allowed to sue *in forma pauperis*. As this is considered a privilege, and enables the person to secure the services of counsel and agents gratuitously, it is only granted on production of a certificate by the minister of the parish and two elders, setting forth his circumstances to their own knowledge and his general poverty. Notice is given of this to the adverse party, who is allowed time to inquire and oppose the application. When the court is satisfied of the poverty, the next thing is for the court to remit the matter to the counsel for the poor, of whom there are always two annually appointed by the Faculty of Advocates, generally young counsel, for the purpose : one of these counsel reports whether there is a *probabilis causa*, i. e., a good cause of action. If this report is made, it is considered conclusive, and the party is put on the poor's-roll. This warrant remains in force for two years, and during that time, the pauper is exempt from all fees of court, and has the gratuitous services of counsel and agents. This provision for enabling paupers to carry on litigation, which is so complete in Scotland, is unknown in England or Ireland ; for though a party may also be allowed there to sue *in forma pauperis*, no provision is made by the court for giving him the gratuitous services of counsel and attorney ; nevertheless, these sometimes volunteer to act gratuitously. See **IN FORMA PAUPERIS**.

**POPAYAN,** a city of the United States of Colombia (New Granada), South America, stands in a fertile plain, 6000 feet above sea-level, on the Cauca, in lat. 2° 27' N. It contains a cathedral and a number of conventual edifices. It was founded in 1537, and was the first city built by Europeans in this region. Under the Spaniards, it rose to considerable importance ; but an earthquake in 1834, and the continued unsettled state of the country, have done much to reduce it. It is still of some consequence as a mart for agricultural produce. A great commercial road, about 1000 miles in length, leads from P. to Truxillo, in Peru. Pop. 20,000.

**POPE** (Gr. *papas* ; Lat. *papa*, father), the title of the Bishop of Rome, and Supreme Pontiff of the Roman Catholic Church ; applied also to all priests of the Greek and Russo-Greek Church. Under very many heads, occasions have arisen requiring reference more or less detailed to the authority and the privileges ascribed to the Bishop of Rome by the church of which he is the head. We propose in the present article to explain briefly the titles of the pope, the manner of his election, the nature and functions of his office, and the authority ascribed to him by the different schools of Catholics ; and finally the chronological succession of the bishops of Rome from the earliest ages to our own day.

1. The name 'Papa' (q. v.)—the Latin equivalent of pope—was originally used of all bishops. The first known writer who applies it to the Roman bishop as his specific title, is Ennodius of Pavia, in the latter part of the 5th c., who thus addresses Pope Symmachus. It is used also by Cassiodorus ; and thenceforward gradually came to be reserved to this application, but it did not lose entirely its old and general use for many centuries later. In the modern ecclesiastical vocabulary, the pope is called the 'Sovereign Pontiff,' the 'Vicar of Christ,' the 'Head of the Church,' the 'Holy Father,' &c. He subscribes himself, since St Gregory the Great, *Servus Servorum Dei* (Servant of the Servants of God) ; and he is addressed as Your Holiness, Your Beatitude, &c.

2. The office of pope is elective. The electoral body, according to the present usage, is the College of Cardinals. Primitively, the pope, as the other bishops, was elected by the clergy and people,

although the rights of both were not the same. In more than one instance, these elections were attended with violence, and even with blood, and the electoral body was by degrees limited. At length, by a decree of Pope Nicholas II. in 1059, the right of election was vested in the cardinals. By the constitution of the College of Cardinals, provision was made for a representation of all the ancient electoral bodies; the cardinal bishops representing the bishops of the Roman synod, the cardinal priests representing the parish clergy, and the cardinal deacons representing the heads of the popular electoral districts (*regiones*) of the city. This constitution is the basis of the present electoral law. Preparatory to an election, the cardinals are shut up in what is called 'the conclave,' all communication with the outer world being interrupted until the election shall have been made. A simple majority of voices does not suffice—two-thirds of the cardinals must vote for the same candidate. There are four modes of election—'scrutiny,' 'access,' 'compromise,' and 'inspiration.' Twice each day during the conclave, the cardinals assemble, and each deposits, in a chalice placed on the altar, the name of his candidate. If the requisite number of votes are not found for any one, the papers are at once burned; and the smoke of the burning votes, which escapes through a small flue, is a signal to the expectant crowd outside that no election has taken place. This is called the 'scrutiny.' If votes be added to those already given for one candidate so as to make the required two-thirds, it is called 'access.' If the cardinals of two parties, finding that neither can hope to succeed, unite, it is called 'compromise.' If by a public movement, whether sudden or preconcerted, a particular candidate named be brought forward and carried as if by acclamation, the election is said to be by 'inspiration.' The present pope, Pius IX., was elected in this way. The greater Catholic powers—France, Austria, and Spain—were formerly understood to have the privilege, through one of their cardinals, of placing a veto upon the election of one candidate; but this right was of a very vague and undefined nature, and had no formal foundation in law. It is required by long usage, as a condition of election, that the candidate be an Italian, and that he be of mature age. Other considerations are also entertained. After election, the pope is enthroned, enters upon possession of his see, and finally, is solemnly crowned. The ceremonial of consecration is very splendid and deeply impressive. One of the ceremonies—that of burning a bunch of flax before him, with the words: 'Holy Father, thus passeth away the glory of the world!'—has often been cited for its highly symbolical character, as well as for its dramatic effect. Cardinals, in order to vote, must be present at the conclave—no voting by proxy is permitted.

3. The general nature of the office of the pope in the Roman Catholic system, and of the functions which it involves, may be inferred from the character which he is believed to hold in the church, as successor of St Peter, and vicegerent of Christ on earth. He is therefore believed to be invested with all the powers necessary for the practical government of the church. Hence he is held (1) to possess over the entire church, and each of its parts, a supreme authority not indeed arbitrary, but regulated by the law of God and by the canons. He has power (2) to examine and decide authoritatively all controversies; (3) to convoke councils; (4) to revise and confirm their decrees; (5) to issue general decrees, whether upon discipline and morals, or upon doctrine; (6) he is the centre of communion, separation from which involves the forfeiture of

the communion of the whole church; (7) he has *ultimate* authority to appoint bishops in all parts of the church, and however this right may be exercised in the first instance, as by the sovereign, by the clergy, or by a synod of bishops, it rests with the pope to confirm the election, no matter how it may have been made, and to grant 'canonical institution;' (8) he can also deprive bishops, and set others in their place; and can even, in cases of great emergency, suppress bishoprics, and change their ecclesiastical limits according to his judgment of the existing requirements of the church; (9) he has authority to judge of the doctrines taught in particular books, or by particular individuals, and to pronounce infallibly as to its conformity with the Catholic faith, or the contrary. This privilege formed the subject of the great controversy with the Jansenists as to what are called 'Dogmatic Facts.'

4. All Catholics are agreed that the pope, as primate, possesses, by divine law and in virtue of his office, full governing authority over the entire church. Of the exercise of such power, they find traces in history from the earliest times. Roman Catholic historians trace the history of the pope's primacy in St Clement's Letters to the Church of Corinth, in the action taken by Victor in the Paschal controversy, and by Stephen and Cornelius in the controversy on re-baptising heretics; in the deposition of Marcian, Bishop of Arles, at the instance of Cyprian, by Pope Stephen; in the leading part taken by the popes in the condemnation of Donatus and of the Pelagian heresy; and perhaps more than all, in the appeals made from various parts of the church by persons excommunicated by their own bishops, and the rehearing at Rome of such causes, and the confirmation or reversal of the sentence according to the result of the trial. These several facts, however, although to Catholics they appear evidences of the papal supremacy, are explained by Protestant writers in a sense which does not suppose any permanent supremacy on the part of the Roman See, and which they hold to be reconcilable with the full independence of national churches; and it is admitted by Catholics themselves, while they contend that the instances to which they appeal imply a real exercise of primacy from the beginning, that the details of that primacy have undergone a gradual and extensive development in the progress of the church. Great difference of opinion exists between the Gallican and the Ultramontane schools as to the extent and nature of the papal authority, whether in decrees of doctrine or in the government of the church. As regards doctrinal decrees, all are agreed that the judgment of the pope, in concert with the body of bishops, is infallible; but they differ as to papal decrees on doctrine issued by the pope alone, *ex cathedra*, and addressed to the whole church. See GALLICANISM. On certain points, however, both schools agree; both are agreed, for instance, as to the duty of respectful obedience on the part of all, until the general sense of the church shall have been ascertained; and should no reclamation on the part of the church take place, the decree of the pope is, in the opinion of both schools, to be received as infallible, and the doctrine propounded therein is to be held as of faith. But the Ultramontanes go beyond the Gallicans in holding this from the very moment of the decree's being issued, *ex cathedra*, and independently of any reference to the church dispersed. As to the government of the church, the Ultramontanes hold the pope to be supreme, and thus to be superior to general councils, and independent of their decrees. The Gallicans, on the contrary, hold that a general council is superior to the pope, and has power to

POPE.

bind him by its decrees. Further, the Ultramontanes hold that the pope is the source of all jurisdiction in the church, and that the bishops derive their powers *through him* from Christ. The Gallicans regard the episcopal power as received directly from Christ by virtue of the episcopal office. This difference of opinion leads to many controversies of detail as to the respective rights and powers of the pope and the bishop in the several dioceses, regarding which it is only necessary to indicate the general ground of difference of opinion.

5. The chronology of the papacy in the 1st c. is very obscure. The enumerations in the ancient writers are imperfect, and they differ as to the exact order of succession. The two most ancient catalogues, those of Irenæus and Augustine, differ in more than one particular. The chief difficulty regards Linus and Cletus. The former is believed to have been the viceregent of Peter during the interval between his first coming to Rome and his final residence there. He would therefore have been at once the contemporary of Peter and his successor (though but for a very brief period). The difficulty as to Cletus arises from the doubt whether he be the same person with Anacletus. We subjoin a catalogue drawn up after the most careful modern authorities, and arranged according to centuries:

	FIRST CENTURY.	A.D.
St Peter, . . . . .		41-67
Linus, . . . . .		68
Cletus, or Anacletus, . . . . .		uncertain date
Clement I., . . . . .		uncertain date

	SECOND CENTURY	
Evaristus, . . . . .		about 100
Alexander I., . . . . .		about 109
Sixtus I., Roman, . . . . .		119
Telesphorus, Greek, . . . . .		127
Hyginus, Athenian, . . . . .		138
Pius I., native of Aquileia, . . . . .		142
Anicetus, Syrian, . . . . .		151
Poter, Greek, . . . . .		161
Eleutherus, Greek, . . . . .		170
Victor I., African, . . . . .		186
Zephyrinus, . . . . .		197

	THIRD CENTURY.	
Callixtus I., Roman, . . . . .		217
Urban I., Roman, . . . . .		222
Pontianus, Roman, . . . . .		230
Antherus, Greek, . . . . .		236
Fabianus, probably Roman, . . . . .		236
Cornelius, Roman, . . . . .		252
(Novatianus, first antipope.)		
Lucius I., Roman, . . . . .		253
Stephen I., Roman, . . . . .		253
Sixtus II., Roman, . . . . .		257
Dionysius, Greek, . . . . .		259
Felix I., Roman, . . . . .		270
Eutychianus, uncertain, . . . . .		275
Caius, Roman, . . . . .		283
Marcellinus, Roman, . . . . .		296

	FOURTH CENTURY.	
Marcellus I., Roman, . . . . .		308
(Marcellinus having died in 304 or 305.)		
Eusebius, Greek, . . . . .		310
Melchades, African, . . . . .		310
Sylvester I., Roman, . . . . .		314
Marcus, Roman, . . . . .		336
Julius I., Roman, . . . . .		337
Liberius, Roman, . . . . .		352
(Felix II., antipope.)		
Damasus I., Spaniard, . . . . .		366
(Uracinus, antipope.)		
Siricius, Roman, . . . . .		384
Anastasius I., Roman, . . . . .		398

	FIFTH CENTURY.	
Innocent I., native of Albano, . . . . .		401
Zosimus, Greek, . . . . .		417
Boniface I., Roman, . . . . .		418
Celestinus I., Roman, . . . . .		429
Sixtus III., Roman, . . . . .		432
Leo I., Roman, called 'the Great,' . . . . .		440
Hiarius, native of Sardinia, . . . . .		461
Simplicius, native of Tibur, . . . . .		467

Felix III., Roman, . . . . .	463
Gelasius I., Roman, . . . . .	492
Anastasius II., Roman, . . . . .	496
Symmachus, native of Sardinia, . . . . .	496

SIXTH CENTURY.

Hormisdas, native of Frusino, . . . . .	514
John I., Tuscan, . . . . .	522
Felix IV., native of Beneventum, . . . . .	526
Boniface II., Roman, . . . . .	530
John II., Roman, . . . . .	532
Agapetus I., Roman, . . . . .	535
Sylvester, native of Campania, . . . . .	536
Vigilius, Roman, . . . . .	540
Pelagius I., Roman, . . . . .	555
John III., Roman, . . . . .	560
Benedict I., Roman, . . . . .	574
Pelagius II., Roman, . . . . .	579
Gregory I., Roman, styled 'the Great,' . . . . .	590

SEVENTH CENTURY.

Sabinianus, native of Tuscany, . . . . .	604
Boniface III., Roman, . . . . .	607
Boniface IV., native of Abruzzi, . . . . .	608
Deusedit or Deodatus I., Roman, . . . . .	615
Boniface V., Neapolitan, . . . . .	619
Honorius I., native of Capua, . . . . .	625
Severinus, Roman, . . . . .	638
John IV., native of Dalmatia, . . . . .	640
Theodorus I., Greek, . . . . .	641
Martin I., native of Tuderum, . . . . .	649
Eugenius I., Roman, . . . . .	654
Vitalianus, native of Signia, . . . . .	657
Deusedit II., Roman, . . . . .	672
Domnus I., Roman, . . . . .	676
Agathon, Sicilian, . . . . .	679
Leo II., Sicilian, . . . . .	682
Benedict II., Roman, . . . . .	684
John V., native of Syria, . . . . .	685
Conon, native of Thrace, . . . . .	686
Sergius I., native of Palermo, . . . . .	687

EIGHTH CENTURY.

John VI., native of Greece, . . . . .	701
John VII., native of Greece, . . . . .	705
Sisinius, native of Syria, . . . . .	708
Constantine, Syrian, . . . . .	708
Gregory II., Roman, . . . . .	715
Gregory III., Syrian, . . . . .	731
Zacharias, Greek, . . . . .	741
Stephen II., . . . . .	753
Stephen III., Roman, . . . . .	753
Paul I., Roman, . . . . .	757
Stephen IV., Sicilian, . . . . .	763
Adrian I., Roman, . . . . .	772
Leo III., Roman, . . . . .	795

NINTH CENTURY.

Stephen V., Roman, . . . . .	816
Paschal I., Roman, . . . . .	817
Eugenius II., Roman, . . . . .	824
Valentinus, Roman, . . . . .	827
Gregory IV., Roman, . . . . .	827
Sergius II., Roman, . . . . .	843
Leo IV., Roman, . . . . .	847
In this interval is placed the fabulous pope Joan (q. v.)	
Benedict III., Roman, . . . . .	855
Nicholas I., Roman, . . . . .	858
Adrian II., Roman, . . . . .	867
John VIII., Roman, . . . . .	872
Martin II. (called also Marinus I.), . . . . .	882
Adrian III., Roman, . . . . .	884
Stephen VI., Roman, . . . . .	885
Formosus, Bishop of Porto, . . . . .	891
(Sergius and Boniface VI., antipopes.)	
Stephen VII., Roman, . . . . .	896
Romanus, Tuscan, . . . . .	897
Theodorus II., Roman, . . . . .	897
John IX., native of Tibur, . . . . .	897

TENTH CENTURY.

Benedict IV., Roman, . . . . .	900
Leo V., native of Ardea, . . . . .	908
(Christopher, antipope.)	
Sergius III., . . . . .	904
Anastasius III., Roman, . . . . .	911
Lando, native of Sabina, . . . . .	913
John X., Roman, . . . . .	914
Leo VI., Roman, . . . . .	928
Stephen VIII., Roman, . . . . .	929
John XI., . . . . .	931
Leo VII., Roman, . . . . .	936
Stephen IX., Roman, . . . . .	939
Martin III. (called by some Marinus II.), . . . . .	943
Agapetus II., . . . . .	946

POPE

John XII., Ottaviano Conti, He was the first who changed his name on his elevation. (Leo VIII., antipope.)	966 963
Benedict V., Roman,	964
John XIII., Roman,	965
Benedict VI.,	972
Domnus II., Roman,	973
Benedict VII. (Conti), Roman,	974
John XIV., (Boniface VII., Franco, antipope.)	983
John XV., Roman,	985
John XVI., Roman,	986
Gregory V., German,	996
Sylvester II., Gerbert, native of Auvergne,	999

ELFTH CENTURY.

John XVII. (May—October),	1003
John XVIII., Roman,	1003
Sergius IV., Roman,	1009
Benedict VIII., native of Tusculum,	1012
John XIX., Roman (in some catalogues reckoned XX; the diversity arising from a disputed election),	1024
Benedict IX., (Sylvester, antipope.)	1033
Gregory VI., Roman,	1044
Clement II., native of Saxony,	1047
Damasus II. (Poppo),	1048
Leo IX., Bishop of Toul,	1049
Victor II., Bishop of Eichstadt,	1055
Stephen X., Frederick, Abbot of Monte Casino,	1057
Benedict X., by some styled antipope, abdicated,	1058
Nicholas II., native of Burgundy,	1059
Alexander II., native of Milan,	1061
Gregory VII., Hildebrand, native of Tuscany, (Gulbert, antipope, assumed the name of Clement III.)	1073
Victor III., native of Beneventum,	1086
Urban II., native of France,	1088
Paschal II., native of Tuscany, (Albert and Theodoric, antipopes.)	1099

TWELFTH CENTURY.

Gelasius II., native of Caleta,	1118
Callixtus II., native of Burgundy,	1119
Honorius II., Cardinal Lambert, Bishop of Ostia,	1124
Innocent II., Roman, (Anacletus, antipope.)	1130
Celestinus II., Tuscan,	1143
Lucius II., native of Bologna,	1144
Eugenius III., native of Pisa,	1145
Anastasius IV., Roman,	1153
Adrian IV., Nicholas Breakpearce, Englishman,	1154
Alexander III., Cardinal Orlando Bandinelli, native of Siena, (Victor, Paschal, and Callixtus, antipopes.)	1159
Lucius III., Cardinal Umido of Lucca,	1181
Urban III., Uberto Crivelli, Archbishop of Milan,	1185
Gregory VIII., native of Beneventum,	1187
Clement III., Paul, Bishop of Præneste,	1188
Celestinus III., Cardinal Hyacinthus, Roman,	1191
Innocent III., Cardinal Lotharius, native of Signa,	1198

THIRTEENTH CENTURY.

Honorius III., Cardinal Savelli, native of Rome,	1216
Gregory IX., Cardinal Hugo, native of Anagni,	1227
Celestinus IV., native of Milan,	1241
Innocent IV., Cardinal Sinibaldo Fieschi, native of Genoa,	1242
Alexander IV., Cardinal Rinaldo Conti, native of Anagni,	1254
Urban IV., James, Patriarch of Jerusalem, Frenchman,	1261
Clement IV., Guy, native of St Gilles, in Languedoc,	1265
Gregory X., Tebaldo Visconti, native of Piacenza,	1272
Innocent V., Cardinal Peter, native of Parentino,	1268
John XXI., Ottobono Fieschi, native of Genoa,	1276
Nicholas III., Cardinal Orsini, native of Rome,	1277
Martin IV., Cardinal Simon de Brice, Frenchman,	1281
Honorius IV., Cardinal James Savelli, native of Rome,	1285
Nicholas IV., Cardinal Jerome, native of Ascoli,	1288
Celestinus V., Pietro da Morrone of Abruzzi,	1294
Boniface VIII., Cardinal Benedetto Gaetani, native of Anagni,	1295

FOURTEENTH CENTURY.

Benedict XI., Cardinal Nicholas, native of Treviso,	1303
Clement V., Bertrand of Bordeaux, removed the papal see to Avignon,	1305
John XXII., James, native of Cahors, in France, (Nicholas, antipope.)	1316
Benedict XII., James Fournier, Frenchman,	1334
Clement VI., Peter Roger, native of Limoges, in France,	1342
Innocent VI., Stephen Aubert, native of Limoges,	1352
Urban V., William Grimoard, Frenchman,	1362
Gregory XI., Peter Roger, Frenchman, restored the papal see to Rome,	1370

Urban VI., Bartolomeo Prignano, Neapolitan, (From 1378 to 1410 occurs the great Western Schism, dur- ing which, in conflict with the line of popes inserted in the catalogue, is found a rival line residing at Avignon —Clement VII., 1378—1394; Benedict XIII., 1394—1410. The Council of Pisa, 1410, deposed both rival popes; but Benedict XIII. remained in schism till his death in 1424.)	1378
Boniface IX., Peter Tomacelli of Naples,	1390

FIFTEENTH CENTURY.

Innocent VII., Cosmo Migliorati, native of Sulmona,	1404
Gregory XII., Angelo Corradi, native of Venice,	1406
Alexander V., Peter Philargius, native of Candia,	1409
John XXIII., Cardinal Cosca, deposed by the Council of Constance,	1410
Martin V., Otto Colonna, Roman,	1417
Eugenius IV., Gabriel Condulmer, Venetian, (Felix, antipope.)	1431
Nicholas V., Cardinal Thomas, native of Sarzana,	1447
Callixtus III., Alfonso Borgia, Spaniard,	1455
Pius II., Eneas Sylvius Piccolomini, native of Siena,	1458
Paul II., Peter Barbo, native of Venice,	1464
Sixtus IV., Francis della Rovere, Genoese,	1471
Innocent VIII., Gian Battista Cibo, Genoese,	1485
Alexander VI., Rodrigo Lenzi Borgia, Spaniard,	1492

SIXTEENTH CENTURY.

Pius III., Francis Todeschini Piccolomini,	1503
Julius II., Julian della Rovere, Genoese,	1503
Leo X., Giovanni de' Medici, son of Lorenzo the Magni- ficent,	1513
Adrian VI., native of Utrecht,	1522
Clement VII., Giulio de' Medici, nephew of Lorenzo,	1523
Paul III., Alessandro Farnese, native of Rome,	1534
Julius III., Giovan Maria Gocci, native of Rome,	1539
Marcellus II., Cardinal Cervini, native of Montepulciano,	1555
Paul IV., Gianpiero Carafa, Neapolitan,	1559
Pius IV., Giovanni Angelo Medici, native of Milan,	1565
Pius V., Michele Ghislieri, native of Alessandria,	1566
Gregory XIII., Hugo Buoncompagni, native of Bologna,	1572
Sixtus V., Felice Peretti of Montalto, native of the March of Ancona,	1585
Urban VII., Gian Batista Castagna, Genoese,	1590
Gregory XIV., Nicola Sfondrati, native of Milan,	1590
Innocent IX., Gian Antonio Facchinetti, native of Bologna,	1591
Clement VIII., Ippolito Aldobrandini, native of Fano,	1592

SEVENTEENTH CENTURY.

Leo XI., Alessandro de' Medici, native of Florence,	1605
Paul V., Camillo Borghese, native of Rome,	1606
Gregory XV., Alessandro Ludovici, native of Bologna,	1621
Urban VIII., Maffeo Barberini, Florentine,	1623
Innocent X., Gian Battista Pamfili, native of Rome,	1644
Alexander VII., Fabio Chigi, native of Siena,	1655
Clement IX., Giulio Rospigliosi, native of Pistols,	1667
Clement X., Emilio Altieri, native of Rome,	1670
Innocent XI., Benedetto Odescalchi, native of Como,	1676
Alexander VIII., Pietro Ottoboni, native of Venice,	1689
Innocent XII., Antonio Pignatelli, native of Naples,	1691

EIGHTEENTH CENTURY.

Clement XI., Gian Francesco Albani, native of Urbino,	1700
Innocent XIII., Michael Angelo Conti, native of Rome,	1721
Benedict XIII., Vincenzo Maria Orsini, native of Rome,	1724
Clement XII., Lorenzo Corsini, native of Florence,	1730
Benedict XIV., Prospero Lambertini, native of Bologna,	1740
Clement XIII., Carlo Rezzonico, native of Venice,	1758
Clement XIV., Gian Vincenzo Ganganelli, born near Rimini,	1769
Pius VI., Angelo Braschi, native of Cesena,	1775

NINETEENTH CENTURY.

Pius VII., Gregorio Barnaba Chiaramonti, native of Cesena,	1800
Leo XII., Annibale della Genga, native of Romagna,	1823
Pius VIII., Cardinal Castiglioni, native of Cingoli,	1829
Gregory XVI., Mauro Cappellari, native of Belluno,	1831
Pius IX., Giovanni Maria Mastai-Ferretti, native of Sin- gaglia,	1846

Protestants generally object to the list of popes given by Roman Catholics, that there is no absolutely conclusive evidence of the apostle Peter's ever having been at Rome; although most of them admit the probability that he was there, and suffered martyrdom there. But they deny that there is any evidence whatever of his having exercised the office of bishop either there or anywhere else. They call in question many other of the names and dates in the earlier part of the list, not so much disputing the existence of the persons named, as their exercise of the office of bishop in

Rome, and still more their right to be considered bishops of Rome. According to Protestants in general, the papacy grew by a gradual assumption of power out of an ordinary bishopric, through the advantage of metropolitan position and influence, and was afterwards supported by the fable—as they deem it—of the see of St Peter.

POPE. See RUFFE.

POPE, ALEXANDER, an eminent English poet, was born in London, May 21, 1688. His parents were Roman Catholics, and to this faith the poet also nominally adhered, thus debarring himself from public office and employment. His father, a linen-merchant, saved a moderate competency, and received some accession of fortune by his marriage with Edith Turner, his second wife, and the poet's mother, a lady of a good Yorkshire family. He then withdrew from business, and settled on a small estate he had purchased at Binfield in Windsor Forest. He died at Chiswick, in 1717. His son shortly afterwards took a long lease of a house and five acres of land at Twickenham, on the banks of the Thames, whither he retired with his widowed mother, to whom he was tenderly attached, and where he resided till his death, cultivating his little domain with exquisite taste and skill, and embellishing it with a grotto, temple, wilderness, and other adjuncts poetical and picturesque. In this famous villa, P. was visited by Frederick, Prince of Wales, and by the most celebrated wits, statesmen, and beauties of the day, himself being the most popular and successful poet of his age. P.'s early years were spent at Binfield, within the range of the Royal Forest. He received some education at little Catholic schools, but was his own instructor after his twelfth year. He never was a profound or accurate scholar, but he read the Latin poets with ease and delight, and acquired some Greek, French, and Italian. He was a poet almost from infancy; he 'lisped in numbers,' and when a mere youth, surpassed all his contemporaries in metrical harmony and correctness. His pastorals and some translations appeared in Tonson's *Miscellany*, in 1709; but were written three or four years earlier. These were followed by the *Essay on Criticism*, 1711; *Rape of the Lock* (when completed, the most graceful, airy, and imaginative of his works), 1712—1714; *Windsor Forest*, 1713; *Temple of Fame*, 1715. In a collection of his works printed in 1717, he included the *Epistle of Eloisa*, and *Elegy on an Unfortunate Lady*, two poems inimitable for pathetic beauty and finished melodious versification. From 1715 till 1726, P. was chiefly engaged on his translations of the *Iliad* and *Odyssey*, which, though wanting in true Homeric simplicity, naturalness, and grandeur, are splendid poems. They realised to the fortunate and fashionable translator a sum of about £8000. He next edited an edition of Shakspeare, which proved unworthy of his reputation. In 1728—1729, he published his greatest satire—the *Dunciad*, an attack on all postasters and pretended wits, and on all other persons against whom the sensitive poet had conceived any enmity. In 1737, he gave to the world a volume of his *Literary Correspondence*, containing some pleasant gossip and observations, with choice passages of description; but it appears that the correspondence was manufactured for publication, not composed of actual letters addressed to the parties whose names are given, and the collection was introduced to the public by means of an elaborate stratagem on the part of the scheming poet. Between the years 1731 and 1739, he issued a series of poetical essays, moral and philosophical, with satires and imitations of Horace, all admirable

for sense, wit, spirit, and brilliance. Of these delightful productions, the most celebrated is the *Essay on Man*, to which Bolingbroke is believed to have contributed the spurious philosophy and false sentiment; but its merit consists in detached passages, descriptions, and pictures. A fourth book to the *Dunciad*, containing many beautiful and striking lines, and a general revision of his works, closed the poet's literary cares and toils: he died on the 30th of May 1744, and was buried in the church at Twickenham. P. was of very diminutive stature, and deformed from his birth. His physical infirmity, susceptible temperament, and incessant study, rendered his life 'one long disease.' He was, as his friend, Lord Chesterfield, said, 'the most irritable of all the genus *irritabile vatium*, offended with trifles, and never forgetting or forgiving them.' His literary stratagems, disguises, assertions, denials, and (we must add) misrepresentations, would fill volumes. Yet P., when no disturbing jealousy, vanity, or rivalry intervened, was generous and affectionate, and he had a manly, independent spirit. As a poet, he was deficient in originality and creative power, and thus was inferior to his prototype, Dryden; but as a literary artist, and brilliant declaimer, satirist, and moraliser in verse, he is still unrivalled. He is the English Horace, and will as surely descend with honours to the latest posterity.

POPEERY literally means attachment to the religion or to the party of the pope; and in this sense the word is synonymous with the profession of the Roman Catholic religion. In its use, however, it has come to involve the idea of contempt or disparagement. It may therefore be said, that the word is either intended to designate what are regarded by Protestants as the most exaggerated and superstitious among the doctrines and practices which they ascribe to Catholics, in contradistinction to the belief of the more moderate members of that church, or is designedly employed as an expression of contempt and depreciation.

POISH PLOT, the name given to an imaginary plot, on the part of the Roman Catholics in England during the reign of Charles II., the object of which was believed to be a general massacre of the Protestants. See OATES, TITUS.

POPLAR (*Populus*), a genus of trees, forming, along with willows, the whole of the natural order *Salicaceæ* or *Salicinae* (by some regarded as a sub-order of *Amentaceæ*), and having dioecious flowers arranged in catkins, both male and female flowers with an oblique cup-shaped perianth. The seeds have silky hairs, as in willows, and are readily wafted about by the wind. The species are numerous, chiefly natives of the temperate and cold regions of the northern hemisphere. They are large trees of rapid growth, with soft wood; and broad, heart-shaped, ovate, triangular, or lozenge-shaped, deciduous leaves, on rather long stalks. Many of them are very beautiful trees. The catkins appear long before the leaves, and proceed from distinct lateral buds. Few of the poplars are of much value for their timber, which is generally white, soft, and light; but from their rapid growth, they are useful as yielding firewood, where the scarcity of other fuel renders it necessary to plant trees for this purpose, and they are often planted as ornamental trees, producing an immediate effect of embellishment in a bare situation more readily than almost any other kind of tree. Besides the species known by the name Aspen (q. v.), or Tremulous Poplar, the following seem the most worthy of notice. The WHITE P., or ABLE (*P. alba*), a native of the southern parts of Europe, and reckoned

among British trees, but probably not indigenous in Britain, is a tree of 80 feet or upwards; with a fine spreading head; and roundish, heart-shaped, lobed, and toothed leaves, which are smooth, shining, and dark-green above, downy and silvery-white beneath. The wood is used by cabinet-makers, turners, and toy-makers. It is little liable to swell or shrink, which adapts it for various purposes. The tree loves low situations and clay soils. This tree has of late years suffered in Britain from some unknown cause, like the potato, dying where it previously flourished; whilst other poplars, the most nearly allied, continue to flourish in the same localities.—The GRAY P. (*P. canescens*) is very similar to the White P., but of more vigorous growth, a large spreading tree; the leaves similar to those of the White P., but not so dark-green above or so white beneath. It is not of so rapid growth as the White P.; and its wood is harder and better, makes good flooring, and is preferable to pine-deal for the neighbourhood of fireplaces, being less apt to take fire; it is also used for coarse doors, carts, barrows, &c., and not being liable to warp, is esteemed by wood-carvers. The tree generally begins to rot in the heart when forty or fifty years old. Like most of the other poplars, it fills the ground around it with suckers. Like the White P., it is a very doubtful native of Britain, and belongs to the centre and south of Europe.—The BLACK P. (*P. nigra*), a native of most parts of Europe, and perhaps of England, is a tree of 50—80 feet high, with an ample spreading head, viscid leafbuds, and deltoid or unequally quadrangular, perfectly smooth leaves. The wood is used for the same purposes as



Black Poplar (*P. nigra*).

that of the White and Gray Poplars. The 'cotton' from the seeds has been used in France and Germany for making cloth hats and paper, but these uses of it were not found profitable.—The LOMBARDY P. (*P. fastigiata* or *dilatata*) is perhaps a mere variety of the Black P., with erect instead of spreading branches. It appears to have been introduced into Europe from the East. It is very common in the Punjab and in Persia, and now also in Lombardy and other parts of Italy. It attains a height of 100, or even 150 feet, and is remarkable for its erect form, contracted head, and very rapid growth. It is often planted as an ornamental tree, although not so generally as in the end of last century, when it was thought preferable for

ornamental purposes to every other tree. It is common in the streets and squares of towns in all parts of Britain; and is particularly adapted to



Lombardy Poplar (*P. fastigiata*).

situations where a long horizontal line of any kind fatigues the eye, or as seen starting up from a mass of lower wood or shrubbery, but has a besom-like appearance when planted in unsuitable situations. The wood is of almost no value. It is generally propagated by layers.—The species commonly known as BLACK ITALIAN P. (*P. monilifera* or *aculesca*), although it is really a native not of Italy, but of North America, and is sometimes more correctly called CANADIAN P., the female catkins of which resemble a string of pearls, is frequently planted both as an ornamental tree and for the sake of its timber, which is useful for flooring, &c. The leaves are deltoid. It is of very rapid growth, and attains a height of 100—120 feet.—The BALSAM P., or TACAMAHAC (*P. balsamifera*), a very common ornamental tree in Britain, is a native both of North America and of Siberia, and has whitish ovate-oblong leaves, which in spring are of a delicate yellow tint, and have an agreeable fragrance. The leaf-buds are viscid. The erect fastigate manner of growth approaches that of the Lombardy Poplar. The resinous exudation of the buds (*Tacamahac*) is said to be diuretic and antispasmodic; and an ointment made from the buds is used for tumours, wounds, and burns. The resinous exudation of the buds of other species, as the Black P., possesses similar properties.—The COTTON-WOOD (*P. Canadensis*) of North America, particularly abundant on the upper parts of the Mississippi and Missouri, is valued as a timber tree, and has been pretty extensively planted in Britain; as has also the ONTARIO P. (*P. canadensis*), a species with the same balsamic character as *P. balsamifera*, and chiefly distinguished from it by its larger leaves. In size of leaf, no other species equals *P. heterophylla*, a native of the Southern States of North America, the leaves of which are often six inches long.

PO'PLIN (Fr. *papeline*). In the 15th c. a fabric was woven in Avignon called *papeline*, which was made of silk, and was much esteemed. An attempt to imitate it was introduced into England, and the name was corrupted to *poplin*, which has been adopted abroad as well as at home. In 1775, the manufacture was introduced to Ireland by French

Protestant refugees, and from that time to the present, Irish poplins have been famous. What the exact nature of the original *popelines* was, is not certainly known; but the best modern poplins consist of a warp of silk and a weft of worsted, which gives substance, combined with great softness and elasticity, to the material. Cotton, and even flax yarns are substituted for silk, wholly or partially, in making cheap goods, but they are very far inferior in beauty to the true poplins.

**POPOCATEPETL** (*Aztec, popoca, to smoke, and tepell, a mountain*), or in Spanish, *Volcan Grande de Mexico*, Grand Volcano of Mexico, a mountain about 10 miles south-west of the city of Mexico. It rises in the form of a cone to a height of 17,720 feet above the sea-level, and is composed chiefly of porphyritic obsidian. Forests girdle its lower parts; but at an elevation of 13,000 feet, all vegetation ceases. About the period of the Spanish conquest, it was very active, but no eruption has been recorded since 1840. It still smokes, however. Cortes, the conqueror of Mexico, attempted to reach its summit, but was unable to do so, on account of the masses of snow that covered it. This feat was first achieved by Francisco Mantano, one of Cortes's followers, who not only climbed to the top of the mountain, but had himself let down its crater, by means of ropes, to a depth of about 450 feet. In 1827, it was again scaled by the brothers Glennie, who determined its altitude barometrically, and since then, this laborious exploit has been several times performed.

**PO'PPINJAY**, a name of the Green Woodpecker (*Picus viridis*), a bird common in most of the wooded districts of England and Scotland. See **WOODPECKER**.

**PO'PPY** (*Papaver*), a genus of plants of the natural order *Papaveraceae*, having a calyx of two (or rarely three) sepals, which very soon fall off; a corolla of four (rarely six) petals; numerous stamens seated on a receptacle; the stigma crowning the germen, without a style, and in the form of 4—20 rays; the capsule opening by pores under the persistent stigma, imperfectly divided into cells by partitions as numerous as the rays of the stigma, but which do not reach the centre, the seeds extremely numerous. There are numerous species of *P.*, mostly natives of Europe and Asia, some of them found even in very northern regions, but most of them in the warmer temperate parts. They are rather large herbaceous plants, annual or perennial, mostly sprinkled with bristly hairs. They have a white milky juice; a disagreeable narcotic smell, particularly when bruised; pinnatifid or bipinnatifid leaves, more rarely jagged or toothed leaves; and large shewy flowers, which readily become double by cultivation. The capsules are curious from the manner in which they fling out their seeds when the plant is shaken by the wind; each capsule being somewhat like a round or oval pepper-box, with holes, however, not in the top, where rain might get in by them, but under the rim. By far the most important species is that known as the **OP'PIUM P.** (*P. somniferum*), also called the **WHITE P.**, and the **OIL POPPY**. See **OP'PIUM**. But the same species is important on account of the bland fixed oil of the seeds, and is much cultivated as an oil-plant. *P. oil* is as sweet as olive oil, and is used for similar purposes. It is imported into Britain in considerable quantities from India. The *P.* is also extensively cultivated for it in France, Belgium, and Germany. The use and manufacture of this oil were for a long time, during last century, strictly prohibited in France, from a mistaken notion that it must partake of the narcotic

properties of the milky juice of the plant. The seed, however, contains no opium or any narcotic principle, and was well known to the ancients as a pleasant article of food, fit to be eaten by itself or with bread. The oil expressed from it is perfectly wholesome, and is much used in France and elsewhere as an article of food. Fully one-half of the oil used for cooking and otherwise for alimentary purposes in France, is of this kind. The seeds yield about 40 per cent. of oil, and the oil-cake is useful for manure or for feeding cattle. The oil is sometimes used by painters and by soap-boilers; but it is not good for burning. In the cultivation of the *P.* for oil, the seed is often sown in autumn, where the severity of winter-frosts is not to be feared; in more northern parts, it is sown in spring, and sometimes the seed is scattered on the top of the snow with which the ground is covered. Being very small, it needs little or no harrowing. Early sowing is favourable to the size of the plant, and the abundance of produce. Hoeing and thinning are advantageous. An open but rich soil is best for the *P.*; and a sheltered situation is necessary, as in exposed situations, much of the seed is scattered by the wind. The *P.* does not exhaust the land so much as colza, rape, and some other oil-plants. Harvesting ought to begin when one-fourth of the capsules of each plant are open. It is accomplished by pulling the plants in such a manner as not to shake the seed out of the capsules, and tying them in sheafs, which are placed together in an erect or slightly sloping position, till the ripening of the capsules is completed, when the seed is taken out by shaking the capsules into a tub or on a cloth, great care being used to prevent any earth from the roots from getting mixed with them. Some farmers in Flanders sow *P.* in alternate rows with carrots. The variety of *P.* chiefly cultivated as an oil-plant has flowers of a dull reddish colour, large oblong capsules, and brownish seeds; but the white-flowered variety, with globular capsules and white seeds, is also used.—The **ORIENTAL P.** (*P. orientale*), a native of Armenia and the Caucasus, a perennial species, is often planted in gardens on account of its very large, fiery-red flowers. Its unripe capsules have an acrid, almost burning taste; but are eaten by the Turks, and opium is extracted from them.—Several species are British, all of them local, rare in some places, and troublesome weeds in cornfields in other places apparently quite similar in climate. Among them is the **CORN P.** or **COMMON RED P.** (*P. rhoeas*), with bright red flowers, and deeply pinnatifid leaves. The petals are mucilaginous and slightly bitter; they have a slight narcotic smell; and a syrup made of them is sometimes used as an anodyne in catarrhs and children's complaints; but they are more valued for the rich red colour which they yield. A variety with double flowers is cultivated in flower-gardens, under the name of *Carnation Poppy*. Among the ancients, the *P.* was sacred to Ceres.

**POPPY-HEAD**, a carved ornament, used as a finial on top of bench-ends, &c. In early examples, it is a simple fleur-de-lis, but in late Gothic, this and other wood-work become very elaborately carved.



Poppy-head.



**PORBEAGLE** (*Lamna Cornubica*, or *Iaurus Cornubicus*), a fish of the Shark family (*Squalida*), not uncommon on the British coasts. It has two dorsal fins, the first about the middle of the back, the second near the tail. The tail-fin is large and forked. The head is pointed. The gill-openings are large. The teeth are flat, triangular, smooth, sharp, and cutting. The P. is also called the **BEAUMARIS SHARK**. It attains a length of about six feet. Small companies associate in pursuit of prey, which consists of fish of various kinds. No creature is more voracious; three large hakes have been found in the stomach of a porbeagle.

**PORCELAIN.** See **POTTERY AND PORCELAIN.**

**PORCH**, a building forming an enclosure or protection for a doorway. Every one knows how much this beautiful feature is now used, and how efficient it is as a protection from the wind and weather. In Elizabethan and medieval architecture, the porch was also very common in domestic architecture. In churches, it was almost universal in this country. In France, many splendid porches or portals remain; they are amongst the most beautiful specimens of medieval art. In England, wooden



Porch of Aldham, Essex (1350).  
(From Parker's *Glossary of Architecture*.)

porches, of picturesque structure, are very common in the parish churches of the middle ages.

**PORCUPINE** (*Hystrix*), a genus of mammalia, of the order *Rodentia*, and family *Hystrioida*. This family is remarkably characterised by an armature of spines, which, like those of the hedgehogs, are, as to their structure, merely thick and strong hairs. The *Hystrioida* are plantigrade; the fore-feet have four toes and a rudimentary thumb, the hind-feet have five toes. Their general aspect is heavy and pig-like, and they have a grunting voice. The muzzle is broad and blunt; the ears short and rounded; the incisors smooth and large, two above, and two below; the molars eight above, and eight below. The name porcupine is derived from the French words *porc*, a hog, and *epin*, a spine.—The **COMMON P.** (*H. cristata*) is a native of the south of Europe, of many parts of Asia, and of most parts of Africa. It is one of the largest of rodents, being from two to three feet in length, besides the tail, which is about six inches long. The hinder part of the head and the neck are furnished with a crest of long bristles, capable of being elevated or depressed at pleasure. The muzzle and limbs are covered with very short hair; the back and sides with

spines, which are longest on the middle of the back,



Porcupine (*Hystrix cristata*).

where they are almost of the thickness of a goose-quill, and more than a foot long. The spines are supported by a slender pedicle, and they terminate in a sharp point; they are longitudinally striated, and are ringed with black and white, which gives a general gray colour to the animal. Their ordinary position is flat, with the points directed backwards; but when the animal is excited, they are erected, and it rolls itself up like the hedgehog, with spines pointing in every direction. The tail spines or quills are of very singular structure, being open thin-sided tubes, about two inches long, supported upon slender flexible pedicles; and they make a sound by rattling together when the tail is shaken. The P. is said to rattle also the spines of its body when irritated, but this is doubtful. The statement has been often made, that it throws off its spines or quills by a voluntary act, launching them at its adversaries; but it has no such power, although it is possible that quills ready to come off may be detached in moments of excitement, and fly to a small distance with sufficient force to be annoying to a pursuer. The P.'s armour, however, is strictly defensive, and it seeks to turn its back, and thus the points of its spines to an enemy. It is a solitary and nocturnal animal. It burrows in the ground, and in winter it becomes torpid. It feeds on roots, bark, fruits, and other vegetable substances, sometimes committing great depredations in gardens. The spines or quills of the P. are used for various purposes, and have a certain commercial value. It is chiefly sought on account of them; although its flesh is eaten, and was brought to the market of ancient Rome.—A larger species of P. (*H. leucurus*), with the quills of the tail quite white, is found in India, and other species inhabit different parts of the East. The **ATHERURE**, or **TUFFED-TAILED P.** (*Atherura fasciculata*), a native of India and Malacca, differs from the true porcupines in the head and muzzle not being convex, in having the quills flattened like blades of grass, and those of the tail gathered into a tuft at the end of it. The **Canada P.**, or **Urson** (q. v.), is still more different from the true porcupines; and the **Coendus** (*Syntheres*) of the warm parts of America—which are covered with short quills, and, like the urson, live among the branches of trees—are remarkably distinguished by their long prehensile tail.

**PORIFERA** (Lat. *poro-bearing*) is the term employed by Dr Grant to designate the class *Spongiae*, or *Sponges*, in consequence of the appearance which the members of this class present when a section is made through their tissue. The term *Spongiae* is used in preference by many naturalists.

PORISM—PORPHYRY.

**PORISM**, a kind of geometric proposition in high favour among ancient Greek mathematicians, but of which the notices that have come down to us are so few and meagre, that, till lately, mathematicians were not agreed about what a porism really was. The ancient works in which porisms are mentioned are the *Collectiones Mathematicæ* of Pappus, and the *Commentarii* of Proclus. Dr Robert Simson (q. v.) was the first to restore the probably original form of porisms. As defined by Playfair, 'a porism is a proposition affirming the possibility of finding such conditions as will render a certain problem indeterminate, or capable of innumerable solutions.' Good examples of porisms are given in Simson's *Opera Reliqua*; Playfair's 'Origin and Investigation of Porisms' (*Trans. of Roy. Soc. of Edin.*, vol. liii.); Wallace's paper, 'Some Geometrical Porisms, &c.' (*Edin. Trans.*, vol. liii. &c.)

**PORK** (Fr. *porc*, a hog, from Lat. *porcus*). The flesh of swine forms a very large portion of the animal food of most nations, although it is not the most nutritive, as will be seen by the following comparison of the four principal kinds of flesh-food :

	Mineral Matter.	Gelatin.	Fibrine and Albumen.	Fat.	Water.
Veal,	4.5	7.5	9.0	16.5	62.5
Beef,	5.0	7.0	8.0	30.0	50.0
Mutton,	3.5	7.0	5.5	40.0	44.0
Pork,	1.5	5.5	4.5	50.0	38.0

It has qualities, however, which especially fit it for man's use; its fatness makes it a very heat-giving food for cold and temperate climates; whilst it surpasses all other kinds of animal food in the ease with which it may be preserved by salting and drying. Hence the trade in pork is considerable in all countries where it is used, but especially so in Great Britain and America, where vast quantities are cured for the supply of ships and the army, and for home use. The quantity of pork imported into Britain from the United States is prodigious; in 1862, of pickled pork there were received nearly half a million barrels, and in addition, bacon and hams of the value of £2,477,005. Millions of hogs are raised in the state of Ohio, and the curing of swine's flesh is the staple business of Cincinnati and other towns. A more vivid idea of the extent of this vast trade cannot be given than a recent statement of the *Louisville Gazette*, that 'there were between five and six acres of barrelled pork piled up three tiers high, in open lots, and not less than six acres unpiled, which would cover eighteen acres if closely laid in a single tier on the ground; besides all which, six acres of pens were filled with hogs waiting to be killed.' America has long furnished the chief supply of mess and common pork not only for the British army, navy, and mercantile marine, but also for those of most European nations. Next to America, Ireland, and especially the neighbourhood of Cork, furnishes the largest supply of cured pork; and London and Wiltshire, and other parts of England, also furnish vast quantities of bacon and hams for general consumption.

**POROSITY**. By this term we express the experimental fact, that no kind of matter completely fills the space it occupies; in other words, that all bodies are full of minute cavities or interstices, such as are illustrated on a large scale by a sponge. On the atomic theory, it is obvious that this must be the case if the atoms of matter are spherical, or, indeed, if they have any form save one or two special ones, such as cubes or rhombic dodecahedrons. It is commonly asserted that all bodies must be porous, because they are compressible; but this is a great

mistake, since we have no reason to believe that matter is not *per se* compressible, independently of the existence of interstices. The Florentine Academicians, in their attempts to compress water, proved the porosity of silver, by flattening a sphere of that metal, filled with water, and soldered. The water escaped through the pores of the silver, and stood in fine drops on its surface. The porosity of liquids is easily shewn by mixing alcohol and water. The bulk of the mixture is considerably less than the sum of the bulks of the components, shewing that these must in part have entered each other's pores. This property of matter is of great importance in natural phenomena, as it brings the molecular forces of capillarity into play: raising the sap in vegetables, allowing rain to sink into the ground, &c.

**PORPHYRIUS**, one of that series of ancient philosophers to whom is due the reformation of the Greek philosophy known as Neo-Platonism, was probably born at Batanea in Syria (the Bashan of Scripture) in the year 233 A.D. His original name was Malchus, the Greek form of the Syro-Phœnician *Melech*, or king. The name by which he is known in history, *Porphyrius*, 'one clad in purple,' is but a Greek epithet intended as a sort of paraphrase of his name. He is said by Socrates the historian, and by St Augustine, to have been originally a Christian; but this seems improbable, although it is certain that in his youth he was a hearer of Origen, or at least held some intercourse with him at Cæsarea in Palestine. What is more certain is, that he passed at a later time to Athens, where he studied rhetoric under Longinus, the well-known author of the treatise *On the Sublime*. It was at Rome, however, whither he repaired soon after 260, that he entered upon what must be regarded as, historically considered, the career of his life. Here he became a scholar of the Neo-Platonist Plotinus, with whom, as well as with another member of the same school, named Amelius, P. entered into an animated controversy, but eventually adopted so fully the opinions of Plotinus, that he became himself, if not the leader of the school, at least the most trusted of the disciples of its master. After six years' residence in Rome, he went to Sicily, where, if St Jerome's account is to be relied on, he wrote his once celebrated treatise in 15 books against the Christians, now known only from the replies which it elicited, having been burned by order of the Emperor Theodosius. From Sicily, he went to Carthage, and afterwards to Athens; but eventually, Plotinus having died soon after P. left Rome, he returned to that city, where he continued to teach, as it would seem, until his death, which was probably about 305 or 306. For a view of P.'s position in the history of the Neo-Platonic school, see NEO-PLATONISTS. P. was a very voluminous writer. Of his works, the titles of more than 60 are still preserved, 43 of which are entirely lost. His *Life of Pythagoras*; his work *On Abstinence from Animal Food*; his *Commentary on Aristotle's Categories*, with the *Introduction*; and *On the Harmonies of Ptolemy*; and the book *Ad Marcellam*, addressed to his wife, are preserved entire. The rest are known chiefly by fragments, nor has any complete edition of his works been published.

**PORPHYRY** (Gr. purple), a term originally confined to an Egyptian rock used in sculpture, and known now as Rosso antico. It is composed, according to Delesse, of a red felspathic base, in which are disseminated rose-coloured crystals of the felspar-called oligoclase, with some plates of blackish hornblende, and grains of oxidised iron ore. The term is not now, however, used to denote any particular

rock, but is applied to any rock which, like the Rosso antico, has a homogeneous earthy or compact base, through which are scattered distinct crystals of one or more minerals of contemporary origin with the base. Thus, gray volcanic trachyte often abounds in crystals of glassy felspar, forming a trachytic porphyry; or crystals of felspar, quartz, or calcareous spar, disseminated through a base of greenstone, form a greenstone porphyry. In the same way, there are pitchstone porphyry, basaltic porphyry, claystone porphyry, &c.

**PORPOISE**, or **PORPESSE** (*Phocæna*), a genus of Cetacea, of the family *Delphinidae*, having a form similar to the dolphins, but the muzzle short, uniformly convex, and without a beak; a dorsal fin; the teeth very numerous, simple, and equal. The COMMON P. (*P. communis*) is the most plentiful of the Cetacea on the British coasts, abounding particularly on the western coasts of Ireland and of Scotland. It is found also on all the coasts of Europe from the Mediterranean northwards, on the



Porpoise (*Phocæna communis*).

coasts of North America, and in the arctic regions. It is one of the smallest of the Cetacea, its length sometimes not exceeding four feet, although individuals occur of six or even eight feet in length. The body is spindle-shaped; its greatest diameter is near the dorsal fin. The skin is perfectly smooth, and destitute of hair. There are from 40 to 50 teeth in each jaw, not conical, as in most of the Cetacea, but compressed. The eye is rather small, and the pupil in the form of a V. The opening of the ear is very minute, like a hole made with a pin. The blow-hole is crescent-shaped, with the horns of the crescent directed forwards, and is situated exactly over the eyes.

The P. is gregarious, and large numbers are often seen together, sometimes swimming in file, when their backs, appearing above the surface of the water, are apt to suggest the idea of a great serpent; sometimes gambolling, either in fine weather, or when a storm is approaching, or even in the midst of a storm. The P. feeds on fish, which its teeth are admirably adapted to catch, and herds of porpoises pursue the vast shoals of herring, mackerel, &c., into bays and estuaries. The P. sometimes ascends rivers, apparently in pursuit of salmon, as far as the water is brackish, and is not unfrequently itself caught on such occasions. It is an object of pursuit on account of its skin, its oil, and its flesh. The skin is nearly an inch thick, but is planed down until it becomes translucent, and is made into excellent leather, which is used for covering carriages and for other purposes. Little use is made of it in Britain, but it is used in America. Under the skin is a layer of fat, about an inch in depth, which yields oil of the finest quality. The flesh is dark-coloured and bloody, but was in former times highly esteemed, and

reckoned fit for the table of royalty, perhaps partly because among Roman Catholics it was accounted fish. In the time of Queen Elizabeth, it was still used by the nobles of England, and was served up with bread-crumbs and vinegar. It is now used only in very northern regions. It is a chief dainty of the Greenlanders.—The Grampus (q. v.) is commonly referred to this genus.—Another species of P. (*P. Capensis*) is found near the Cape of Good Hope.—The name P. is from the French *porc-poisson*, or the Italian *porco-pece* (Hog-fish), corresponding to the French *marouin* (Sea-hog) and the German *meerschwein*.

**PORRI'GO.** See **FAVUS** and **RINGWORM**.

**PORSE'NNA**, also **PORSENA**, **LARS** or **LARTH** (*Lar*, in Etruscan means 'lord' or 'prince'), in the early and uncertain history of Rome, appears as a powerful king of Clusium in Etruria. According to the legend told by Livy for history, when Tarquin the Proud was expelled from Rome, he sought the help, first of the Veii and the Tarquini (his Etruscan kinemen), against his revolted subjects; but their efforts not proving successful, he turned to P., who willingly espoused his cause, and marched a great army against Rome. The Etruscan king seized the Janiculum, a fortified hill on the west side of the Tiber; and would have forced his way into the city across the 'Bridge of Wooden Piles' (*Pons Sublicius*), had not a brave Roman, Horatius Cocles, kept the whole of P.'s army at bay, while his comrades behind him hewed down the bridge; after which he plunged into the Tiber, and safely swam across its waves. P., we are informed, now laid siege to Rome; and after a while, the inhabitants began to suffer so severely from famine, that a desperate expedient was had recourse to. Three hundred of the noblest Roman youths swore to peril their lives in cutting off the Etruscan king. The first on whom the lot fell was C. Mucius, who stole into the camp of P., but not knowing the person of the king, killed his secretary instead. He was instantly seized, and put to the torture; but the unshrinking audacity with which he thrust his right hand into the fire and let it burn, moved the king so much, that he pardoned him; whereupon Mucius (ever afterwards called *Sorosis*, 'the Left-handed') told him of the jeopardy in which he was placed. P. resolved to make peace with Rome at once, and his conditions, which were pretty favourable, being accepted by the sorely-pressed citizens, he withdrew his forces. This version of the story is wholly discredited by modern criticism, and is believed to have been invented by the patriotic annalists of ancient Rome to conceal the fact of a temporary Etruscan conquest, and the evidence in favour of this view is overwhelming. Tacitus even expressly affirms that P. conquered the city; Dionysius informs us that the senate sent him an ivory sceptre, a golden crown, and a triumphal robe, which was the form that had been adopted by the Etruscan cities themselves of acknowledging the supremacy of the Roman king, Tarquinius Priscus; and Pliny mentions a circumstance which is quite conclusive as a proof of the subjugation of Rome—viz., that P. forbade the citizens to use iron, except for agricultural purposes. Niebuhr, who has placed this view beyond all doubt, notices various minor incidents which are perfectly unintelligible, except on the hypothesis of an Etruscan conquest. The whole details of the ancient legend, therefore, may be regarded as fabulous—the product of patriotic unvaricacy—and what seems most reasonable to believe, is, that a great rising of the Etruscan against the Latin races took place, and that Rome, forming the Latin frontier towards

Etruria, was exposed to the first brunt of the war, and suffered a disastrous defeat; but that shortly after, the Etruscans themselves were decisively beaten, and forced back into their own territories; for after the conquest of Rome, Aruns, a son of P., proceeded against Aricia, where (according to Livy) his army was routed under the walls of that city by the combined forces of the Latin cities, with the help of Greek auxiliaries from Cuma. It is worth while quoting, as a proof of Niebühr's wonderful talent for felicitous conjecture, that he explains the long-surviving Roman custom of beginning an auction by offering for sale the goods of King P., by the supposition, that in the recovery of their independence, the Romans probably captured property belonging to their late master, which they may have publicly sold. The sepulchre of P. at Clusium is described by Varro, but his description is not credible. The ancient legend has been magnificently rendered in modern verse by Macaulay. See the *Lays of Ancient Rome*.

PORSON, RICHARD, the greatest Greek scholar England has ever produced, was born on Christmas 1753, at East Ruston, Norfolk, where his father was parish clerk. The curate of the parish conceiving a liking for the boy, on account of his omnivorous appetite for books and his marvellous memory, took charge of him, and had him educated along with his own sons. P. afterwards found a patron in Mr Norris (the founder of the Norrisian professorship at Cambridge), who sent him to Eton in 1774, where he remained four years, but did not acquire any of the ordinary distinctions, although it is evident that it was there his mind acquired a fixed bias towards classical studies. Another patron, Sir George Baker, sent him, in 1778, to Trinity College, Cambridge, of which he was elected a scholar in 1780. Next year, he won the Craven Scholarship, and subsequently, the first Chancellor's medal. In 1782, he was chosen a Fellow of Trinity. It was about this time that he began to give indications of his subtle sagacity and taste in the difficult verbal criticism of the Greek dramatists. For four years, he contributed to *Maty's Review*—his first critique being on Schulz's *Æschylus*, and his finest on Brunck's *Aristophanes*. He also opened a correspondence with Professor Ruhnken. If, however, we are to judge from a quatrain written at a later period of his life, he did more than correspond:

I went to Strasburg, where I got drunk  
With that most learned Professor Brunck;  
I went to Wertz, and got more drunken  
With that more learned Professor Ruhnken.

In 1787 appeared, in the *Gentleman's Magazine*, his sarcastic letters on Hawkins's *Life of Johnson*. For the same periodical, he also wrote his far more famous and trenchant *Letters to Travis on the Three Witnesses*. The dispute concerned the genuineness of John i. 7, 8, and was occasioned by a blundering and pretentious defence of the passage by Archdeacon Travis, against the scornful attack of Gibbon. P. naturally incurred great odium on account of the side which he took in this controversy. One old lady who had him in her will for a legacy of £300, cut it down to £30, when she heard that he had written a book against Christianity. In 1792, he resigned his fellowship, as he found that he could not conscientiously take orders in the church. Some of his friends now raised a fund to preserve him from want, and about £100 a year was secured. He was also appointed to the Regius professorship of Greek in the university of Cambridge—an office, indeed, only worth £40 a year; yet so splendid was his learning, so admirable his taste, so vigorous and

epigrammatic his style of criticism, that he might easily have—by the exercise of a moderate degree of continuous literary labour—succeeded in gaining a handsome income. But already 'two devils had him in their gripe'—procrastination and a raging thirst for drink—and they held him firm to the end of his melancholy career. The only thing he ever did in connection with his Greek professorship was to deliver a *prolectio* so excellent, that, it has been said, if he had passed from verbal to æsthetic criticism, he would have surpassed all his countrymen in that too. In 1794, he edited the plays of *Æschylus* for the Foulis press, Glasgow; and between 1797 and 1801, four of Euripides, the *Hecuba*, the *Orestes*, the *Phænissæ* and the *Medæa*. He also collated the Harleian MS. of the *Odyssey* for the *Grenville Homer*. In 1806 he was appointed librarian of the 'London Institution' with a salary of £200; but was so grossly negligent of his duties, that the directors officially notified their dissatisfaction in these emphatic words: 'We only know that you are our librarian by seeing your name attached to the receipts for your salary.' He died of apoplexy, 25th September 1808, in the 49th year of his age, and was buried with great pomp in the chapel of Trinity College, Cambridge. P.'s rage for drink was fearful. He would pour anything down his throat rather than endure the 'terrible torture of thirst.' Ink, spirits of wine for the lamp, an embrocation, are among the horrible things he is reported to have swallowed in his extremity. 'He used to return to the dining-room after the company had left it; pour into a tumbler the drops remaining in the wine-glasses, and drink off the collectanes.' In fact, his thirst was so outrageous, that P. cannot be considered a mere wilful drunkard; one must believe that he was driven into his excesses by some unknown disease of his constitution. See POLYDIPSIA. P.'s memory was as amazing as his thirst. The anecdotes told by his biographers almost surpass belief, yet are thoroughly authenticated. His critical acumen has never been matched in England. His tracts, reviews, letters, &c., were collected and edited, with a biographical notice, by Kidd, in six volumes. See 'Porsoniana' in Rogers' *Table-Talk*, and the Rev. J. Selby Watson's *Life of Richard Porson, M.A.* (1861).

PORT, in Naval Language, has at least three significations; first, a port is a harbour where ships are admitted to embark or discharge cargoes, or for other purposes—a free port being one in which the embarkation and discharge can be conducted without the payment of customs or port dues.—A port in a ship's side is the aperture for admitting light and air, or for pointing a gun through. See PORT-HOLE.—Port is also the official name for the left-hand side, when looking towards the bow of a ship—i. e., looking forwards. The term was, a few years ago, arbitrarily substituted for Larboard (q. v.).

PORT ARMS, in Musketry Drill, is derived from *portare*, to carry, and applies to a motion in which the fire-arm is supported or carried by the left arm under the guard of the piece, the arm being laid horizontally across the chest.

PORT-AU-PRINCE, or PORT-REPUBLICAN, the capital of Hayti (q. v.), is situated on the west coast, at the head of a bay of the same name, and has a fine appearance from the sea, but the interior is filthy in the extreme. The houses are chiefly of wood, and dungsteads obtrude everywhere, even in the thoroughfares. The most notable buildings are the palace and the senate-house; other public edifices are the churches, a lyceum, college, custom-house, mint, and hospital. P. carries on a trade in

PORT D'URBAN—PORT ROYAL-DES-CHAMPS.

mahogany, logwood, honey, coffee, cocoa, and raga. Pop. about 30,000. The town has suffered frequently from earthquakes.

**PORT D'URBAN, or PORT NATAL,** the only seaport of the colony of NATAL (q. v.).

**PORT ELIZABETH,** an important seaport of South Africa, commercial capital of the Eastern Province of the British colony of the Cape of Good Hope, stands on the western shore of Algoa Bay (q. v.), in lat. about 34° S., long. 25° 35' E. Many of the streets are elegant. One range of houses, consisting of four streets, which will bear comparison with the best streets in England, forms a continuous line two miles in length. In the style of its buildings, this town is superior to any other in South Africa. Its magnificent warehouses are constructed on a palatial scale, and resemble the finest in London, and its public buildings are all solid and substantial edifices. The principal are the town-house, 90 feet square and three stories high, containing the public library, the atheneum, and the municipal chambers; the public hospital, furnished with 100 beds; the Presbyterian and other churches, and the Roman Catholic cathedral. Its educational institutions are of a superior description. In 1854, under the auspices of Governor Sir George Grey, a system of schools was introduced known as the Grey Institute Schools, founded on a magnificent grant of town-lands, yielding at present (1864) a revenue of over £1000 per annum, and affording a very excellent education at a very moderate charge. The chief of these are a high-school or college, and three elementary or district training-schools.

The town was founded in 1820, and its pop. (1864) was 17,968. Its progress has been, and continues to be very rapid, and it is said to double itself in population, wealth, and extent every ten years. Its fixed or real property, as assessed in 1863 for municipal purposes, amounts in value to £1,268,765. It owes its commercial importance in great part to the circumstance of its being the emporium of the great wool trade of the colony; and besides this it carries on a rapidly-increasing home and foreign trade. The value of its home business may be estimated from the extensive transactions of its banks, which are three in number, and whose half-yearly statements for June 1864 shewed assets to the extent of over £1,500,000. Its foreign trade is with Europe, America, Brazil, Australia, Mauritius, China, and India, and the value of its exports and imports amounts to nearly £4,000,000.

The shore is open to the swell of the Indian Ocean, which often rolls in upon the beach with such violence that, until recently, cargoes could only be got to land by the use of surf-boats. Kaffirs, tempted by the high pay offered, used to come from a great distance to do the difficult and dangerous work of unloading the boats (which they did standing breast-high in the water), and carrying the bales to the shore. But this system of landing is now in great measure done away with, and ships now unload at jetties, several of which run out into the bay.

**PORT-GLASGOW,** a parliamentary burgh and seaport of the county of Renfrew, Scotland, is situated on the Clyde, about 2 miles east of Greenock and 20 miles north-west of Glasgow. It was founded in 1668 by the magistrates of Glasgow as a harbour for the ships that belonged to or traded with their city—the Clyde at Glasgow being then inconveniently shallow, and the idea of deepening the river not having yet occurred. In 1695, the town and a small adjacent district were made into an independent parish; in 1710, it was

constituted the principal custom-house on the Clyde, and for a while took the lead of Greenock; in 1773, it was incorporated as a municipality, and by the Reform Bill of 1832, it was raised to the rank of a parliamentary burgh, uniting with Kilmarnock, Rutherglen, Dumbarton, and Benfrew in electing a member of the legislature. P.-G. is rather a well-built town; the streets are in general regularly laid out, crossing each other at right angles, and the houses are of a substantial order. The principal buildings are the town-house, custom-house, and churches of the different denominations. P.-G. has extensive manufactures of sail-ropes, chain-cables, several sugar-refineries, foundries, building-yards, commodious quays and wet-docks. The deepening of the Clyde, by means of which large vessels can now ascend to Glasgow, seriously injured its commercial prosperity, but it is still the principal port on the Clyde for the importation of North American timber. Pop. (1861) 7214.

**PORT LOUIS,** the capital and principal port of the British colony of Mauritius, is situated on an inlet on the north-west coast. Its streets, though narrow, are straight, and are furnished with foot-paths, and macadamised. It contains a number of public buildings, among which are a theatre, library, hospital, and botanic garden. Its harbour is capacious, but is quite safe only during the fine season. The imports and exports of the colony are mainly transacted at P. L.; and their quantity, value, and character are mentioned under the article Mauritius (q. v.). Pop. of the port variously given at 26,000 and 35,000.

**PORT MAHO'N** (anc. *Portus Magonis*), the capital of the island of Minorca (q. v.), is beautifully situated on a deep and narrow inlet in the south-east of the island. Its harbour, sufficiently spacious to accommodate a large fleet of men-of-war, is one of the finest in the Mediterranean, and is protected by three forts. It has no architectural features worthy of special notice, but is on the whole well built. The military governor and the bishop of the island reside here. In 1860, 78 vessels of 15,162 tons entered and cleared the port. Pop. 12,600.

**PORT PA'TRICK,** a burgh of barony and fishing village of Scotland, in the county of Wigtown, and 6½ miles south-west of Stranraer. It is surrounded by hills on the land side, and its harbour is protected by two piers, but remains incomplete. It is the nearest point of Scotland to the Irish coast, being only 21½ miles north-east of Donaghadee. Pop. (1861) 1206.

**PORT PHILLIP.** See MELBOURNE.

**PORT ROYAL-DES-CHAMPS,** a convent of Cistercian nuns, near Versailles, which obtained much celebrity during the 17th century. It was founded for nuns by a member of the family of Montmorenci, in the early part of the 13th c.; and soon after its establishment, obtained from the pope the privilege of receiving lay persons, who, without taking monastic vows, desired to live in religious retirement. This portion of the P. R. institute in later times became of great importance. The discipline of the convent having been much relaxed in the 15th and 16th centuries, one of its worst abuses—that of appointing the superior, not on account of fitness, but from considerations of family or other worldly or political motives—became in the end the occasion of its complete reformation. Angélique Arnauld, sister of the celebrated brother Arnauld, was appointed, when a mere child, coadjutrix of the abbess, and on the death of this lady, although she was then only in her eleventh year, herself succeeded to the office. As Mère Angélique advanced in years, she felt moved, although still

## PORT WINE—PORTARLINGTON.

very young, by a profound sense of her responsibilities, and undertook a complete and rigid reformation of the community, which she carried out in all its details—as the strict observance of religious poverty, abstinence from meat, complete seclusion, and the most severe ascetic exercises. The community was removed to Paris in 1626, and in 1633 to a new convent, which was thenceforward called Port Royal-de-Paris; and from this time the old establishment of P. R.-des-Champs was exclusively devoted to the use of a lay community, in accordance with the original papal privilege. This community quickly became very celebrated, and soon numbered among its inmates some of the most distinguished scholars of that age, Antony Arnauld, Le Maistre, Antony and Louis Isaac le Maistre de Sacy, Nicole, Lancelot, Sericourt, and several others. Their rule of life was most austere, rising at 3 A.M., devoting many hours to prayer and spiritual reading and instruction, and a portion of the day to manual labour. One of their most important public services was the establishment of a school, for which they prepared the well-known educational books known under the name of Port Royal, the Greek and Latin Grammars, General Grammar, Geometry, Art of Thinking, &c. This school was for a time transferred to Paris, a portion of the nuns being sent back to P. R.-des-Champs; but eventually it was established at an out-farm of the latter place, called Les Granges.

P. R., however, is even more known in history through its relations with the Jansenist controversy. The nature and origin of these relations have been explained in the article JANSEN (q. v.). It only remains to relate the later fortunes of P. R. and its members, in so far as they were affected by the proceedings taken in consequence by the authorities, whether civil or ecclesiastical. The nuns of P. R. having refused to subscribe the formulary condemning the Five Propositions, a royal order was issued in 1660 for the suppression of the school, and the removal of the boarders of P. R.-des-Champs; and at length the abbess, and several other nuns, were arrested, and confined as prisoners in other monasteries. After the 'Peace of Clement IX.' they were permitted to return; but the two communities, P. R.-des-Champs and P. R.-de-Paris, were placed under separate government. This led to many disputes, and to a perpetuation in P. R.-des-Champs of the Jansenistic spirit and the Jansenistic opinions; and when the final steps for the repression of that party were taken about 1707, a formal bull was issued by Pope Clement XI. for the suppression of that convent, and the transfer of its property to P. R.-de-Paris. The nuns, accordingly, were finally dispersed and distributed over convents of different orders throughout France. The property of the convent and church were transferred to the Paris house, and all the buildings of P. R.-des-Champs were levelled to the ground, by order of the king. Most of the eminent names connected with P. R. will be found treated under separate heads.

**PORT WINE** (i. e., *Porto* or *Oporto Wine*), a species of red wine, hot and heady, which is produced chiefly in a mountainous district of Portugal, called Cima de Douro, and exported from Oporto and Lisbon. The vine from which this wine is produced is generally planted on craggy slopes with a southern exposure. The grapes are gathered from the commencement of September to the middle of October. The cultivation and gathering of the grapes for port wine employ annually 10,000 cultivators and 20,000 gatherers. The wine, when pure and unadulterated (which is very seldom the case), does not acquire its full

strength and flavour till it has stood for some years, but care must likewise be taken that it is not allowed to become too old. The colour of new port wine varies from pale rose to deep red, and changes with age, becoming a deep tawny brown, which is permanent. By far the greater portion of the wine made is mixed with spirit even during the time of fermentation, in order to give the new wine the ripeness and strength which exporters require, and which the wine does not naturally attain till it has stood for some time; the proper colour is also given by an ingredient known as *jeropiga*, which is a preparation of elder-berries, molasses, raisin-juice, and spirit. It is an excess of this *jeropiga* in the inferior sorts of port which communicates to them the medicated odour so frequently noticed. The extreme 'headiness' of port is chiefly due to the liberal admixture with spirit, and this is the case with all the sorts generally exported. From the time when port came into demand (about 1700, though it was known in England for a considerable time before this) down to 1826, its export was a monopoly in the hands of the English merchants, and the amount of wine produced increased, with tolerable steadiness, year after year till 1836, when it reached 38,459 pipes, valued at £1,122,500. The ultimate effect of this monopoly was to increase the price of port wine in England, and at the same time so to deteriorate its quality, that in course of time it became of less demand, and was gradually, to some extent, supplanted by Southern French and other wines. Since 1836 it has fluctuated, being sometimes more and sometimes less than this figure; in 1850 the exportation reached 37,487 pipes, of which 25,400 were sent to Great Britain, the rest to the other parts of the world, chiefly to Europe, America, and Brazil.

**PORTADOWN** (Ir. *Port-na-Doon*, Port of the Fort), a market and manufacturing town of the county of Armagh, Ulster, Ireland, on the Bann, 11 miles north-east of Armagh by railway. It was formerly the seat of the M'Canns, a clan tributary to the O'Neil, and formed part of the territory 'settled' by James I., and afterwards by Charles I. It is a place of considerable trade in corn, flax, and other agricultural produce, and is the seat of an extensive manufacture of linen yarns and linen. Enjoying the advantage of communication by canal with the sea at Newry, and by railway with Belfast, it has also a considerable import trade. The population in 1861 was 5524, of whom 2185 were of the Established Church, 1856 Roman Catholics, 662 Presbyterians, and the rest Protestants of other denominations. P. is also connected by the Ulster Railway with Armagh, Dungannon, and the north-west counties.

**PORTAL**, the recess of a large doorway, such as the entrance to a church. See **PORCH**.

**PORTAMENTO** (Ital. *portare*, to carry), a musical term used for the sustaining of the voice, and passing from one note to another.

**PORTARLINGTON**, a market town and parliamentary borough, partly in the King's County, partly in the Queen's County, Leinster, Ireland, on the Barrow, 44 miles west-south-west from Dublin, with which it communicates by the Great Southern and Western Railway. Pop. in 1861, 2389, of whom 1645 were Roman Catholics, and 698 Protestants of the Established Church. P. was anciently called *Cooltetoodra*; but being granted by Charles II. to the Earl of Arlington, was called by his name. By him it was sold to Sir Patrick Traill; and on the attainder of Sir Patrick, was granted by William III. to General de Rouvigny, who planted in it a colony of French

and Flemish Protestants, many of whose descendants still remain. It is now the property of the family of Dawson, created Earls of Portarlington. It returns one member to the imperial parliament. The town is neat and well built, and is provided with several schools, two national, two endowed, and also private schools of considerable reputation, at one of which the late Duke of Wellington and his brother Lord Wellesley received part of their education.

**PORTCULLIS** (Fr. *porte*, gate, and *coulisse*, from *couler*, to flow), a frame of wood strengthened

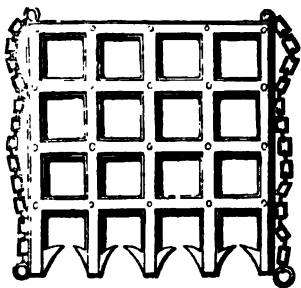

Fig. 1.

with iron in the form of a grating, and sliding in vertical grooves in the jambs of the entrance gate of a fortified place, in order to defend the gate in case of assault. The vertical bars were pointed with iron below, and struck on the ground when the grating was dropped, so as to injure whatever it fell upon.

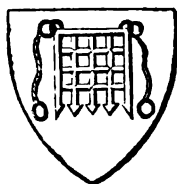

Fig. 2.

In Heraldry, the portcullis is represented with rings at its uppermost angles, from which chains depend on either side. It was a badge of the Beaufort family, and borne in virtue of their Beaufort descent by the Tudor sovereigns. Portcullis is the title of one of the pursuivants belonging to the English College of Arms, whose office was instituted by Henry VII.

**PORTE**, Sublime Porte, or Ottoman Porte, the name given to the Turkish government. The origin of this name is to be referred to the ancient oriental custom of making the gates of cities and of king's palaces places of assembly in connection with the affairs of government and of the administration of justice. In the Byzantine empire this custom was adopted, and the term was transferred from the high gate of the imperial palace to the government whose authority was there exercised. The Turks found the term in common use among the Byzantines some time previous to their establishment at Constantinople, and adopted it on the organisation of their empire. The use, among European nations, of the French term *Sublime Porte* ('Lofty Gate') is accounted for by the fact that French is the language of European diplomacy.

**PORTER**, a kind of malt liquor which came into use in London in 1722. According to Leigh, 'the malt liquors previously in use were ale, beer, and twopenny, and it was customary to call for a pint or tankard of half-and-half—i.e., half of ale and half of beer, half of ale and half of twopenny, or half of beer and half of twopenny. In the course of time it also became the practice to ask for a pint or tankard of three-thirds [or, as it became corrupted, *three threads*], meaning a third each of ale,

beer, and twopenny; and thus the publican was obliged to go to three casks for a single pint of liquor. To avoid this trouble and waste, a brewer of the name of Harwood conceived the idea of making a liquor which should partake of the united flavours of ale, beer, and twopenny. He did so, and succeeded, calling it entire, or entire butt beer, meaning that it was drawn entirely from one cask or butt; and being a hearty nourishing liquor, it was very suitable for porters and other working people. Hence it obtained the name of Porter, and was first retailed at the Blue Last, Curtain Road, Shoreditch.' The chief characteristics of porter are its dark-brown colour, peculiar bitter flavour, and agreeable freshness in drinking. Until within the last ten years it was generally brewed with malt roasted until slightly brown; now, however, under the improved system of brewing, pale malt, with the addition of some highly roasted, for the sake of colour only, is used. Enormous quantities are brewed by the London brewers. A kind much stronger than ordinary porter is also extensively brewed in London, Dublin, and elsewhere, under the name of *stout*. The name porter is now seldom used in England, beer being the general designation.

**PORTFIRE** is a sort of slow match for firing guns. It consists of a paper tube from 16 to 20 inches in length, filled with a composition thus proportioned—saltpetre 668 parts, sulphur 222 parts, mealed gunpowder 112 parts. The composition is rammed with force into the paper barrel, and then, when ignited, it burns for a considerable period. As a substitute, may be employed soft brown paper dipped in a solution of two ounces of nitre to a gallon of water, dried, and rolled up to the size of a common portfire. Another portfire consists of a rod cut square, of lime, birch, or poplar, boiled for six hours in a solution formed by dissolving one pound of nitrate of lead in one quart of water. The rod is subsequently boiled in spirits of turpentine. When thoroughly dried, one yard will burn three hours.

**PORTHOLES** are embrasures or openings in the side of a ship of war to enable the guns to be ranged in battery. The portholes are ordinarily square, of size sufficient to enable the guns to be pointed at a considerable angle. In stormy weather the ports are closed, the guns being run in. When the guns are run out, and no fighting is anticipated, half-ports are employed to keep the water out. There is a row of ports for each gun-deck, and by these rows the rating of the vessel is described as three-decker, two-decker, &c. Within the port, rings are fixed through which the ropes are passed for working the heavy guns.

**PO'RTICI** (formerly *Portico*), a town of Southern Italy, is situated on the slope of Vesuvius, near Herculaneum, 4 miles south-east from Naples, with 11,288 inhabitants. Its environs are delightful, and are dotted all over with country houses. There is a royal palace built by Charles III., but it is crossed by the high road, which divides it in two. Facing the palace is a fortress rising out of the sea, and there is a small harbour called the *Granatello*.

**PO'RTICO**, a covered space with a roof supported by columns. It is usually attached to an important building, but sometimes detached, as a shady walk. A portico is called tetrastyle, hexastyle, octostyle, and decastyle, according as it has four, six, eight, or ten columns in front.

**PORTION**, though not a legal term, is often used in the law of intestacy and legacies, and means a sum of money given to a child in discharge of the obligation incumbent on a parent; and from the circumstance of its being often given on marriage it is called a marriage-portion. By the law of Eng and

PORTIONERS—PORTLAND STONE

and Ireland, therein differing from the law of Scotland, a parent is not bound at common law to give any portion to his children. But he often does so by will; and, in the event of his dying intestate, the law does so for him. When a testator by will leaves a legacy to a daughter, child, or person, towards whom he stands in *loco parentis*, and afterwards in his lifetime gives the child a like sum of money, or even a less sum as a portion on marriage, such portion is *prima facie* presumed to be in satisfaction, or an ademption of the legacy, unless there is something in the will or settlement to rebut that presumption. But in Scotland there is no such presumption, unless the father was liable by contract to give the portion. Paterson's *Comp. of E. and S. Law*, 711. See TOCHER.

**PORTIONERS**, in the Law of Scotland, mean two or more females who succeed jointly to heritable estate in default of heirs male, corresponding to Coparceners in England. See HEIRS PORTIONERS.

**PORTLAND**, a city and seaport of Maine, U. S., situated on an arm of the south-west side of Casco Bay, lat. 43° 39' N., long. 70° 15' W., 105 miles north-east of Boston. It is beautifully situated on a peninsula three miles long by three-fourths of a mile broad, with broad shaded streets, and handsome public and private edifices. Among the former is a fire-proof iron and granite building for the United States' Courts and Custom-house; a city hall, of olive-coloured freestone, 150 by 232 feet; public halls and libraries, Charitable Mechanics' Association, Athenaeum, Society of Natural History's Hall and Cabinets, public schools, and 26 churches. There are 11 newspapers, 3 of which are daily. The harbour of P. is large, deep, well sheltered, and seldom frozen, and is the winter-station of the Canadian steamers. It is defended by Forts Preble and Scammell. There are 5 railways, including one to Quebec and Montreal, locomotive and marine engine manufactories, sugar refineries, 7 banks, and a large coasting trade. P., first named Falmouth, was settled by an English colony in 1632, and was three times burned in the wars with the French and Indians. Pop. in 1860, 26,342.

**PORTLAND BEDS**, a division of the Upper Oolites (q. v.), occurring between the Purbeck Beds and the Kimmeridge Clay, and so named because the rocks of the group form the promontory of the Isle of Portland. They consist of beds of hard oolitic limestone and freestone, interstratified with clays, and resting on light-coloured sands, which contain marine fossils. The corals found in the sands are often converted into flints, the original structure being beautifully preserved in the hard silex. The beds may be traced from the Isle of Portland, capping the oolitic hills as far as Oxfordshire. The fossils are chiefly mollusca and fish, with a few reptiles.

**PORTLAND CEMENT**. See CEMENT.

**PORTLAND ISLE**, a rocky peninsula projecting into the English Channel from the shore of Dorsetshire, 17 miles west-south-west of St Alban's Head. Its appearance suggests the shape of a *beak*, and it is therefore called also the *Bill of Portland*. It is 9 miles in circumference, is composed of oolitic limestone, and slopes southward, with an even surface from the height of 490 feet to that of 30 feet above sea-level. Its sides are extremely rugged, and are worn into fantastic caverns by the furious action of the waves. The peninsula is supposed to have been once an island, but for ages it has been connected with the mainland by *Chesil Bank*, an extraordinary ridge of loose shingle, which, after running north-west in a straight line close to the shore for about 10 miles, joins the mainland at Abbotsbury. South-

west winds prevail on this part of the coast, and during their continuance the long ridge of Chesil Bank is lashed by a frightful sea, and is the scene of frequent shipwrecks. A long narrow inlet of the sea, called the *Fleet*, extends between Chesil Bank and the shore, and is the haunt of numerous wild-fowl. *Portland Castle*, in the north of the isle, is a ponderous building, erected by Henry VIII. as a protection for this part of the coast in 1520. The peninsula furnishes the famous Portland Stone (q. v.). Portland Breakwater, built of stones obtained on the island, is partly described under the article BREAKWATER (q. v.). This great national work is not yet (January 1865) finished; in connection with it are also a naval station, harbour of refuge, and batteries. *Pennsylvania Castle*, in a most romantic district on the east coast, was built by John Penn, the grandson of the founder of Pennsylvania. *Rufus Castle*, or, as it is commonly called, *Bow and Arrow Castle*, also on the east coast, is now a ruin, and is generally said to have been built by William Rufus. On Portland Bill, the southern extremity of the island, are two light-houses, one 130, and the other 197 feet above sea-level. Between the southern point and the *Shambles*, three miles to the south-east, a dangerous surf, well known as the *Race of Portland*, is raised by the rushing of the impetuous tides. The convict prison, near the east coast, erected in 1848, consists of eight wings, besides the hospital, chapel, barracks, and cottages for the warders. It accommodates about 1500 convicts, besides the officers, and is maintained at an annual cost of upwards of £50,000, or at the rate of £33 per prisoner. The inhabitants of the island long remained a peculiar people, intermarrying, and preserving, generation after generation, the many curious customs of their ancestors. The island itself is chiefly remarkable for its abundant supply of excellent spring water, for its building-stone, and for its breed of sheep, the flesh of which, well known as Portland mutton, is celebrated for its flavour. The pop. of the parish of P. amounted in 1861 to 8468.

**PORTLAND SAGO**. See ARUM.

**PORTLAND STONE**. This celebrated building stone, of which many of the principal buildings of London, including St Paul's Cathedral, Somerset House, and many of the churches are constructed, is the oolitic limestone of Dorsetshire, constituting geologically the *Portland and Purbeck Beds*. The quarries are chiefly located in the islands of Portland and Purbeck, and in the Vale of Wardour. The quantity raised is very large. During the heavier works at the Portland Breakwater 730,000 tons per annum were required for that structure alone, and about 30,000 to 40,000 tons are sent annually to London and other places. There are three different qualities of the stone in the same quarry: the uppermost contains numerous fossils, and is of a coarse grain; it is therefore used chiefly for rough work, such as foundations. It is called *Roach* by the quarrymen. The middle bed is much broken, and is called the *rubble* or *rubby bed*, and is of little value; and the lower one is fine, white, and compact, and is called the *whit*, or *best bed*. This last is that which is used for fine building purposes. An analysis of this stone by Professor Daniell shows the following composition:

Silica,	. . . . .	1.30
Carbonate of Lime,	. . . . .	95.16
Carbonate of Magnesia,	. . . . .	1.30
Iron and Alumina,	. . . . .	0.50
Water and loss,	. . . . .	1.94

Besides which ingredients, there is often a trace of bitumen present.



## PORTLAND VASE—PORTSMOUTH.

**PORTLAND VASE.** A beautiful cinerary urn, of transparent dark-blue glass, found about the middle of the 16th c. in a marble sarcophagus near Rome (see the article **GLASS**, where it is figured and described). It was at first deposited in the Barberini Palace at Rome (and hence often called the Barberini Vase); it then became (1770) the property, by purchase, of Sir William Hamilton (q. v.), from whose possession it passed into that of the Duchess of Portland. In 1810 the Duke of Portland, one of the trustees of the British Museum, allowed it to be placed in that institution, retaining his right over it as his own property. In 1845 a miscreant named William Lloyd, apparently from an insane love of mischief or a diseased ambition for notoriety, dashed this valuable relic to pieces with a stone. Owing to the defective state of the law, only a slight punishment could be inflicted; but an act was immediately passed, making such an offence punishable with imprisonment for two years, and one, two, or three public or private whippings. The pieces of the fractured vase were carefully gathered up, and afterwards united in a very complete manner; and thus repaired, it still exists in the Museum, but is not shewn to the public. A small number of copies of the Portland Vase were made many years ago by Mr Wedgwood, and were sold at 25 guineas each.

**PORTLAW**, a small manufacturing town of the county of Waterford, Munster, Ireland, about 10 miles west-north-west of Waterford. P. has risen within the last 30 years from a small village into a town of great activity and of extensive manufactures, through the enterprise of a single family named Malcomson, by whom the cotton manufacture has been introduced with great success. The population in 1861 was 3915, of whom 3684 were Catholics, 149 Protestants of the Established Church, and the few remaining, members of the Methodist society. P. is admirably provided with schools and other institutions for the social and moral improvement of the population.

**PORTO ALEGRE**, a town of Brazil, capital of the province of São Pedro do Rio Grande, stands at the north-west extremity of the Lake of Patos, by means of which it communicates with the sea. It was founded in 1743, is well built, and contains 12,000 inhabitants. It is provided with wharfs; and its trade, though not altogether inconsiderable, has been much retarded by the frequently disturbed state of the country.

**PORTOBELLO**, a parliamentary borough and watering-place, occupies a plain on the south bank of the Firth of Forth, in the county of Edinburgh, and three miles east of the city of that name by the North British Railway. A commodious new town-hall was built here and opened in 1863. This town is a favourite resort for sea-bathing and summer quarters during the season. Besides the facilities for bathing offered by the fine sands of the shore, there is a commodious suite of baths of different kinds. A marine promenade, a mile in length, runs along the shore. P. is also a manufacturing town, and its manufacturing establishments comprise potteries, and earthenware, bottle, brick, and paper works, &c. Pop. (1861) 4366; and, in summer, between 7000 and 8000. The town derives its name from the first house built here about the time of the seizure of the town of Puerto Bello, in the Isthmus of Panama, and which was called Portobello.

**PORTO BELLO.** See **PUERTO BELLO**.

**PORTO FERRAJO.** See **ELBA**.

**PORTO NOVO**, a town in the Madras Presidency of India, situated on the Coromandal coast, in lat.

11° 31' N., and long. 79° 51' E. Both the Danes and the Dutch had formerly a factory here. The place is celebrated for the battle fought here on 1st July 1781, when Sir Eyre Coote defeated Hyder Ali. The British force consisted of only 7878 men, including artillery; Hyder's army numbered over 60,000. Coote was retiring before Hyder. After leaving P. N., he had only advanced a few miles along the seashore, when he found his path intercepted by the enemy's batteries, the sea confining him on the right, and a range of sand-hills on the left. The British army made two assaults; in one, they carried the batteries; in the other, they took advantage of an opening in the sand-hills, which Hyder had neglected to guard, and came suddenly upon the enemy's flank. A schooner of war meantime standing in close, poured her broadsides of small guns into the enemy. Their rout was complete. P. N. is celebrated for its iron foundry, which of late years has supplied much of the material for the Madras railway. The population of P. N. is about 12,000.

**PORTO RICO.** See **PUERTO RICO**.

**PORTREE.** See **SKYE**.

**PORTREEVE** (from *port* and *reeve*, Sansa *gerefa*, a word of similar origin to the German *graf*, signifying a governor or chief magistrate), the principal magistrate in a maritime town. This was the early name of the officer afterwards called mayor in London and elsewhere.

**PORTSEA ISLAND**, a small island on the south coast of Hampshire, has on its west side Portsmouth Harbour, on its south-east side Langston Harbour, on its east side Chichester Harbour, and is separated from the mainland on the north by a narrow channel, crossed by several bridges. It is four miles long, by from two to three miles broad, and contains the important towns of Portsea and Portsmouth (q. v.).

**PORTSMOUTH**, the chief naval arsenal of Great Britain, and an important seaport, market-town, and municipal and parliamentary borough, in the south of Hampshire, stands on the south-west shore of Portsea Island (q. v.), at the entrance to Portsmouth Harbour, and opposite the town of Gosport, with which it communicates by means of a steam-bridge. It is 74 miles south-west of London by the London and South-western Railway. Besides the parish of P., the limits of the municipal and parliamentary borough, which are co-extensive, include also the parish and town of Portsea, and the out-wards Landport and Southsea. The population of the borough, with its suburbs, was (1861) 94,799. P. is for the most part a mean-looking, dirty town, though, as a fortress, it is considered the most perfect in Britain. Formidable batteries defend the harbour; and bastioned ramparts, faced with masonry, planted with trees, and surrounded by trenches and outworks, enclose the town. Portsea, about a mile to the north, is similarly fortified, the line of its land-defences being distinct from that of Portsmouth. Southsea, which is situated outside the walls skirting Southsea Common, is rapidly increasing and is now a fashionable watering-place. In the town proper, there are few objects of note. Pleasing views may be had from the ramparts and batteries, as the harbour, the roadstead of Spithead, and the Isle of Wight, on the coast of which the white walls of the royal residence of Osborne House are seen gleaming among the trees. Among the few notable buildings may be mentioned the church of St Thomas, the chancel and transepts of which date from the 12th c., and which contains a ghastly cenotaph in memory of the murdered Duke of Buckingham (see *infra*). In front of the Garrison

PORTSMOUTH—PORTUGAL

Chapel is buried the brave Sir Charles James Napier (q. v.), who died in this neighbourhood in 1863. The dockyard of P., in the district of Portsea, is at present 116 acres in extent, the largest in the country. Works are, however, now (January 1865) in progress which will increase the area to a total of 293 acres. Of this immense naval establishment, the most noteworthy, if not the most recent, features are the mast and rope houses, hemp-stores, rigging-stores, sail-loft, and the dry docks, six in number, spacious enough to admit the largest vessel, and offering every facility for their speedy repair. The docks are generally 22 feet deep, lined with solid masonry, and roofed over and closed by lock-gates. Of the various building-slips, one of them, roofed and covered in, is so large that three or four vessels can be in process of construction under it at the same time. The Wood Mills contain a number of most ingenious block-making machines, the invention of Sir Isambard Brunel, in which rough timber, introduced at one end, is cut, squared, drilled, bored, and turned into the required shape. About 140,000 blocks are made here annually, and the machines require the attendance of no more than four men. In the smithy, anchors are forged by aid of a Nasmyth's hammer. The dockyard also contains the residences of the superintending officers, and a school of naval architecture.

Portsmouth Harbour, about 420 yards wide at its entrance, expands into a spacious basin, extending inland for about 4 miles, and having a breadth of 3 miles along its northern shore. Large war-vessels can enter and lie at anchor at all times of the tide. The outward entrance is defended by Monkton Fort and Southsea Castle. The position of this harbour is highly favourable. It is situated in the middle of the channel, close to the magnificent anchorage of Spithead, where 1000 ships of the line may ride without inconvenience, and is under shelter of the Isle of Wight, and opposite the French arsenal of Cherbourg.

The local trade of P. is supported by the dock-yard and the other public establishments of the town. Brewing is largely carried on in the town and vicinity. Coals, cattle, sheep, corn, and provisions are imported from our own coasts, and timber and wine from abroad. In 1863, 2495 vessels, of 188,216 tons, entered and cleared the port.

The importance of this port dates only from the reign of Henry VIII. Its defences were strengthened by Elizabeth, and afterwards in a more thorough manner by William III. Here, in a house that still remains in the High Street, and which was then an inn called the 'Spotted Dog,' the Duke of Buckingham (the 'Steenie' of King James) was assassinated by John Felton. On the 29th of August 1782, when its commander, Admiral Kempenfeldt, was writing in his cabin, the *Royal George* went down in the harbour, and nearly 1000 lives were lost.

PORTSMOUTH, a city and the only seaport of New Hampshire, U.S., is on the south bank of the Piscataqua River, three miles from the Atlantic, and 45 miles north-north-east of Boston; a well-built town, having 10 churches, Athenæum, state arsenal, academy and public schools, 2 market-houses, almshouse, 4 banks, manufactories of cotton and hosiery, 2 foundries, breweries. There is a safe and deep harbour, a United States' navy-yard, having a balance-dock, 350 feet long, and two forts, M'Cleary and Constitution. Settled in 1623. Pop. (1860) 9335.

PORTSMOUTH, a city and port of Virginia, U.S., on the west bank of Elizabeth River, opposite

Norfolk, and 8 miles from Hampton Roads. It has a court-house, scientific and military academy, 5 newspapers, 6 churches, tobacco-factories, &c., and connections with the southern railways. Its proximity to Fortress Monroe caused it to be held, during the War of Secession, by the Federal forces. Pop. in 1860, 9487.

PORTSMOUTH, a village of Ohio, U.S., on the north bank of the Ohio River, at the mouth of the Scioto, the terminus of the Scioto and Hocking Valley Railway, and Ohio and Erie Canal, 115 miles east-by-south from Cincinnati, and 90 south of Columbus. It has 14 churches, 2 iron foundries, 3 machine-shops, 2 distilleries, 6 banks, and 5 newspapers. Pop. in 1860, 6268.

PORTUGAL, the most westerly kingdom of Europe, a part of the great Spanish peninsula, lies in 36° 55'—42° 8' N. lat., and 6° 15'—9° 30' W. long. Its greatest length from north to south is 368 miles, and its average breadth from east to west about 100 miles. The kingdom of P. Proper is bounded by the Atlantic on the S. and W., and by Spain on the N. and E. Its distinctive subdivisions, with their several areas and populations, are given in the following table:

CONTINENTAL PORTUGAL.

Provinces.	Dioceses.	Area in Sq. Miles.	Pop. 1861.
MINHO,	Viana, Braga, Porto,	3094 56	887,859
TRAS OS MONTES,	Braganza, Villa-Real,	3980 76	340,186
BEIRA,	Aveiro, Coimbra, Viseu, Guarda, Castello-Branco,	6575 77	1,210,066
ESTREMADURA,	Lefria, Santarem, Lisbon,	8180 97	785,866
ALENTEJO,	Portalegre, Evora, Beja,	9898 98	311,729
ALGARVE,	Faro,	2315 25	157,666
	Total,	36,046 29	3,693,363

The insular appendages of P. are: The Azores, 1133 79 square miles, pop. (1863) 240,548. Madeira, &c., 330 75 square miles; pop. (1863) 101,420. The total area of the home territories of P. is therefore 37,510 83 square miles, and the population 4,035,330.

The colonial possessions of P. are, in *Africa*—Cape de Verde Isles, 1630 02 square miles; pop. 85,400. Senegambia, 35,437 50 square miles; pop. 1095. Islands of San-Thome and Principe, off Guinea, 448 56 square miles; pop. 12,260. Angola, Benguela, 200,602 50 square miles; pop. 2,000,000. Mozambique and dependencies, 283,500 square miles; pop. 300,000. In *Asia*—Goa, Salcete, 1440 6 square miles; pop. 363,788. Damao, Diu, 91 08 square miles; pop. 44,808. In the Indian Archipelago, 2877 square miles; pop. 850,300. In *China*—Macao, 11 76 square miles; pop. 29,587. Total of colonies 526,041 48 square miles; pop. 3,687,228.

*Physical Aspect, &c.*—P. must be regarded as essentially a littoral country, forming the Atlantic or western part of the Spanish peninsula, from which it is separated by political, rather than physical boundaries. Its mountains and rivers are, with few exceptions, mere western prolongations of those of Spain. The principal mountain ranges lie about half-way inland, leaving almost

## PORTUGAL.

the whole of its 500 miles of coastline a flat sandy tract, with few rocky headlands, and hence there are scarcely any harbours or places of safe anchorage, except at the embouchures of the larger rivers. The highest range is the Serra de Estrella, which, passing from north-north-east to south-south-west, through Beira and Estremadura, terminates in the steep acclivities of Cintra and Cap la Rocca, near Lisbon. The principal chain, which is also known as the Serra da Junto, merges in a series of ridges, which cover a tract thirty miles in length, between the Tagus and the sea. Another mountain range, named the Serra de Calderio and the Serra de Monchique, but constituting a mere continuation of the Spanish Sierra Morena, crosses the southern part of P. from east to west, and terminates in its most southern promontory of Cape St Vincent. These ranges, with the numerous mountain-spurs that intersect the northern districts in every direction, so thoroughly occupy the area of P., that there are only two or three plains of any extent in the whole country, and these are situated to the west of the Guadiana, in Alemtejo, and in Beira and Estremadura, near the Tagus and Vouga. The valleys are very numerous, and by their great fruitfulness, present a striking contrast to the barren and rugged mountains by which they are enclosed. The principal rivers enter P. from Spain. Of these, the largest are the Guadiana, which, leaving Spain near Badajoz, forms in part the boundary between the southern provinces of the neighbouring kingdom; while the Minho and Douro, flowing west, form a part of the boundary in the north and north-east. The Tagus, or Tejo, intersects P. from its northern frontier to the southern termination of the Estrella Mountains, where it enters the sea a little below Lisbon. The Mondego, the largest river belonging entirely to P., after receiving numerous affluents in its course, falls into the sea about midway between the Douro and the Tagus. The larger rivers, although obstructed at their mouth with dangerous bars, afford admirable means of internal navigation, together with the numerous lesser streams, and might through canals be connected into one great system of water-routes; but hitherto nothing has been done to improve these great natural advantages. Except a few mountain tarns, P. has no lakes. It has salt-marshes on the coast, near Setubal in Estremadura, and Aveiro in Beira, whence large quantities of salt are annually obtained by evaporation. Mineral springs are abundant in many parts of the country, but hitherto they have been almost wholly neglected.

The vicinity to the western ocean tempers the climate of P., and exempts it from the dry heat by which Spain is visited. The great inequalities of the surface produce, however, great diversities of climate; for while snow falls abundantly on the mountains in the northern provinces, it is never seen in the lowlands of the southern districts, where spring begins with the new year, and harvest is over by midsummer. Rain falls abundantly, especially on the coast, from October to March, and, as a general rule, the climate is healthy in the elevated districts even of the southern provinces; but malaria and fever prevail in low flat lands and near the salt marshes. The mean annual temperature at Lisbon is 61° Fahr.

The natural products correspond to the diversity of the physical and climatic conditions, for while barley, oats, and wheat, maize, flax, and hemp, are grown in the more elevated tracts, rice is cultivated in the lowlands, the oak thrives in the northern, the chestnut in the central, and the cork, date, and American aloe in the southern parts, while every species of European, and various kinds of

semi-tropical fruits and vegetables, are grown in different parts of the country. The soil is generally rich, but agriculture is everywhere neglected, and is scarcely made subservient to the wants of the population. The cultivation of the vine and that of the olive are almost the sole branches of industry; from the former is derived the rich red wine familiarly known to us as Port, from its being shipped at *O Porto*, 'the port.' The mineral products include gold, antimony, lead, copper, marble, slate, coal, iron, and salt, but of these the last is alone worked in sufficient quantity for exportation, and is in eager demand for the British market, on account of its superior hardness, which adapts it specially for the salting of meat for ships.

The finest cattle are reared in the north, the horses of Alemtejo and the sheep of Beira are most valued. Mules and asses are the principal beasts of burden. Goats and pigs are numerous, and are raised at a very low cost, in all the mountain districts. The rearing of bees and silk-worms is being pursued with somewhat increased energy of late years. Fish is abundant in all the rivers and on the coast. The tunny and anchovy fisheries of Algarve are of considerable importance.

*Commerce, &c.*—The commercial industry of the country falls very far below its physical capabilities, and Oporto and Lisbon are the only centres of manufacture and trade, the former of which has important silk and glove manufactories, and produces an inconsiderable quantity of linen, cotton, and wool fabrics, metal and earthenware goods, tobacco, cigars, leather, &c. In 1861—1862, 1521 large sea-going and 1106 smaller coasting vessels entered the port of Lisbon; and 1443 of the former, and 984 of the latter, left it. In the same year, 963 vessels entered, and 974 left the port of Oporto. About 600 miles of railway are now open for traffic, principally in the environs of Lisbon, Oporto, Santarem, and Vigo; but the country is almost entirely without roads, the few which exist having been made only within the last twenty years, before which time the whole of the kingdom was in the same impassable condition in which the southern provinces still remain. The scarcity and inefficiency of bridges, and the total want of canals, render internal traffic almost impracticable, and, as a matter of course, put an impassable barrier in the way of the progress of civilisation, and the growth of material prosperity.

The exports, which consist almost entirely of wine, fruits, oil, and cork, amounted in 1856 to about 16,299,035,500 reis, or (taking 1000 reis = 55d.) £3,735,196, and of these, nearly the half were taken by Great Britain and her colonies. The imports for the same year were 20,451,809,800 reis, or about £4,686,873, of which two-thirds came from Great Britain and her colonies.

The budget for 1863—1864 gives the total of the receipts, which are derived from direct and indirect taxation and from the national domains, at 15,371,266,245 reis; while the expenditure, including home and foreign debts, the charges of the state, public works, &c., is estimated at 16,910,350,057 reis; leaving a deficit for the year of 1,539,087,814 reis. The budget for the foreign possessions of P. gives for the same year the receipts at 1,032,113,904 reis; expenditure, 1,323,801,569 reis; deficit, 296,687,665 reis. The national debt, in 1862, including foreign loans, amounted to 149,853,788,545 reis.

*Army and Navy.*—The army in 1863 was rated at 20,239 men, besides about 4000 men on the retired list, and 1710 men in the municipal guard. The colonial army amounts at present to 13,834 troops, of whom about one-third are stationed in the *India*

## PORTUGAL.

dependencies of Portugal. The navy in 1863 numbered 35 vessels, carrying 296 guns. The principal naval depôts are at Lisbon and Oporto. P. has 55 fortresses, the greater number of which are mere fortified castles. Among the more important are Elvas, S. Julians Cascaes, Pininhe, Almeida, and Valença. There are six orders of knighthood—viz., the Order of Christ, founded in 1319; St Benedict of Avis; the Tower and Sword, founded in 1459, and re-organised in 1808; Our Lady of Villa Viçosa, established in 1819; and the order of St John of Jerusalem, which was separated in 1802 from that of Malta. Besides these, there is one civil service order, founded in 1288.

*Religion, Education.*—P. belongs almost exclusively to the Church of Rome, and shows little toleration to other creeds. At Lisbon and Oporto, Protestant places of worship are, however, sanctioned by the government. P. is divided into three dioceses, which are presided over by the Cardinal Patriarch of Lisbon, the Archbishop of Braga, who is primate of the kingdom, and the Archbishop of Evora; and these, with the fourteen bishops, belong to the Grandeza, or higher nobility. The number of clergy holding cures is given at 18,000. The monasteries have been dissolved since 1834, but convents for nuns still exist. P. stands below the other countries of Europe in regard to education. There is one university at Coimbra; military, naval, trade, and navigation schools, 900 elementary, and about 360 classical and higher schools. There is an Academy of Sciences and a School of Arts at Lisbon, the former of which has a library of 50,000 vols. The other public libraries are the Central Library, with 300,000 vols.; various royal libraries, as that of Lisbon, with 86,000 badly-preserved vols, and 8000 MSS.; that at the Necessidades Palace, with 28,000 vols.; and that at the Ajuda Palace, with 20,000 vols.; and the University Library at Coimbra, with 45,000 vols. The administration of the management of general education is conducted by the Junta at Coimbra, under the supervision of the ministry of Justice.

*Law, Government, &c.*—The administration of the law is effected by means of 111 courts of justice, 6 of which are located at Lisbon, where also the high court of appeal holds its sittings. The courts are public, and in some cases trial by jury is adopted. Excepting in regard to suits referring to trade, law is still administered in accordance with the Alfonsine code of the 15th c., and the Código Filippino, or code of Philip IV. of Spain.

P. is a constitutional monarchy, the crown being hereditary alike in the female and male lines. The houses of representatives are called *Cortes*, and consist of the *Camara dos Pares*, and the *Camara dos Deputados*, the former composed of grandees, chosen for life by the sovereign, and the latter of 114 members, elected by voters. The monarch is assisted by a cabinet of six ministers of state, and a council composed of members chosen for life. He bears the title of King of Portugal and of Algarve 'on both sides of the ocean.' The heir-apparent bears the title of Prince of Beira. The winter residence of the king and court is the Palace dos Necessidades at Lisbon, which at other seasons is exchanged for the palaces at Mafra, Queluz, Bemfica, and Ramalhão. The nobility is divided into *Titulados* and *Fidalgos*, and these, with the upper officials, higher clergy, &c., constitute one-eighth of the whole population; a very large number of the Fidalgos being impoverished and reduced to the condition of paupers, subsisting on charity. The arms of P. are a silver shield bearing five small blue shields, set crosswise, each of which has five silver coins laid crosswise upon it the whole being encircled by a red border

bearing seven golden castles—the arms of Algarve. The supporters are two dragons, bearing aloft the standards of P. and Algarve. The national colours are blue and white. Lisbon (q. v.), the capital, is the centre of the small amount of literary, artistic, and manufacturing activity in P.; while, besides Oporto (q. v.) there is no city whose population exceeds 20,000, and very few which have more than 10,000 inhabitants.

*Race.*—The Portuguese are a mixed race. In Algarve and Alemtejo, the Arabic element is still very perceptible, and the people of those provinces have dark-brown skins, and tall, slim, but lithe and active figures; while the natives of the more northern districts, with lighter skins, have less regular features, small eyes, and short, thick-set figures. Although the Portuguese may very probably be regarded as the remains of the original population of the peninsula, they differ essentially from their Spanish brethren, whom they now regard with inveterate hatred and jealousy on account of their attempts a few centuries ago to annihilate the independence of Portugal. They indulge in interminable verbosity, ceremonious flattery, and servile politeness, and they are inclined to extravagance and display. They are, however, intensely patriotic, brave, persevering, enterprising, hospitable, cheerful, and ready to oblige. As a people, they are dirty and slovenly; few persons among them possess any great degree of mental culture, and the lower orders are even unable to read or write, and hence the grossest superstition and bigotry prevail in every class of the population.

*History of Portugal.*—The earliest notice which we have of the western portions of the Spanish peninsula, is derived from the Romans, who followed the Carthaginians as conquerors of the territories of the ancient Iberians and western Celts. Under Augustus, the peninsula was divided into three provinces, governed by prætors, of which the western province of Lusitania comprised the greater part of the present kingdom of P., besides portions of Leon and Spanish Estremadura. When the Romans withdrew from the peninsula, which was rapidly overrun by Visigoths from the north, and at a later period by Saracens from the south, Lusitania was overwhelmed in one common ruin with Iberia or ancient Spain. About the middle of the 11th c., it fell under the sway of Ferdinand I. of Castile. In 1095, Henry of Burgundy, who had married a natural daughter of Alfonso VI., king of Castile, the successor of Ferdinand, received from that monarch the government of Portugal from the Minho to the Tagus, as a dependent fief. It is maintained, however, by Portuguese authorities, that even from this time the country was independent. His son, Alfonso I., gained signal advantages over the Arabs, and, by his gallantry and prudence, secured the affections of the people. After the great victory which he gained over the Moslems, in the plain of Ourique, in Alemtejo, in 1139, his soldiers proclaimed him king. His successes on this occasion inflicted a serious check on the advance of the Infidels, and in recompense for the services which he had thus conferred on Christendom, the pope confirmed his title, which had been unanimously ratified by the Cortes of Lamego. The Burgundian House, which continued in possession of the throne for 400 years, gave to P. some of its noblest and best kings. The immediate successors of Alfonso I. were engaged in many severe struggles with the clergy and nobles, who were always ready to combine against the sovereign; but although often baffled in their attempts to uphold the independence of the crown, the dignity of the kingdom was, on the whole, well maintained by the

## PORTUGAL.

representatives of this family, who are, moreover, distinguished as the promoters and upholders of the maritime glory of Portugal. Dinis (Dionysius), who succeeded Alfonso III in 1279, must be regarded as the founder of Portuguese commerce and mercantile enterprise. This king, moreover, encouraged the industrial arts, and protected learning, in furtherance of which he founded, in 1284, a university at Lisbon, which was transferred, in 1308, to Coimbra. Dinis was succeeded in 1325 by his son, Alfonso, surnamed the Brave, whose reign was almost wholly occupied in wars with the Castilians and the Moslems. With Alfonso's grandson, Ferdinand I, the legitimate branch of the Burgundian House became extinct in 1383. After some disturbances, his illegitimate brother, Joam (John), was recognised by the Cortes as king in 1385. His reign was eventful, not merely on account of the internal reforms which he introduced into the state, and of his steady maintenance of the prerogatives of the crown, but chiefly as being associated with the commencement of those vast and important geographical discoveries and commercial enterprises, to which P. owed the position she occupied during that and the succeeding age as the greatest maritime power of Europe. To Joam's son, Enrique (Henry) the Navigator, is due the merit of having organised various voyages of discovery, and inaugurated a regular system of colonisation, which, during the reign of Joam II. (who ascended the throne in 1481), culminated in the successive acquisition by P. of the Azores, Madeira, Cape de Verde, and other islands; in the doubling of the Cape of Good Hope under Bartholomeo Diaz; and, as the result of the latter, in the successful achievement of the passage by sea to India, which was effected, in 1497, under the command of Vasco de Gama, in the reign of Joam's successor, Manoel. The discovery of Brazil, and the settlements made there and on the western coast of India, increased the maritime power and fame of P., which were further extended under Manoel's son, Joam III., who ascended the throne in 1521. At this period, P. ranked as one of the most powerful monarchies in Europe, and Lisbon as one of its most important commercial cities. Sudden as this course of prosperity had been, its decline was almost more abrupt, and may in a great measure be referred to the influence of the priests, for the introduction into P. of the Inquisition in 1536, led to the expulsion of the numerous wealthy and industrious Jews, on whose able financial management the commercial interests of the Portuguese were largely dependent, and gave rise to an amount of social tyranny and oppression, both in the colonies and at home, which, coupled with a bad system of government, depressed the energy and crippled the resources of the nation. The influence of the Jesuits under the minority of Joam's grandson, Sebastian, and their evil counsels in urging the young king to enter upon a fatal expedition to Africa against the Infidels, led to still further miseries. The defeat of the Portuguese, and the capture and death of their young king at the battle of Alcazar in 1578, and the extinction of the old Burgundian line in 1580, after the brief reign of Sebastian's uncle, Enrique, plunged the country into difficulties and misfortunes of every kind, which lost none of their weight, although they changed in character. After a struggle for the throne between many eager candidates, none of whom found favour with the nation at large, who persisted in cherishing the delusive hope that Sebastian was still alive, and would return from the hands of his Infidel captors, Philip II. of Spain succeeded in securing to himself the crown of P., and annexing the Portuguese kingdom to the Spanish monarchy. This event proved disastrous

in the extreme to P., for, besides bringing the country to the brink of ruin, by mal-administration and misappropriation of its resources, it involved it in all the ruinous wars of Spain in the Low Countries and in Germany, a great part of the expenses of which it was made to bear; while the Dutch, in retaliation for Spanish aggressions at home, attacked the Portuguese settlements in Brazil, and almost completely deprived them of their possessions in the Indian Archipelago. The insolence of Philip IV.'s minister, Olivarez, brought matters to a crisis; and in 1640, after a forced union of 160 years, P. was freed, by a bold and successful conspiracy of the nobles, from all connection with Spain, and the Duke de Braganza, a descendant of the old royal family, placed on the throne, under the title of Joam IV. The war with Spain, which was the natural result of this act, terminated in 1668, when, by the treaty of Lisbon, the independence of P. was formally recognised by the Spanish government. For the next hundred years, P. vegetated in a state of inglorious apathy. Her ancient glory had departed never to return, the nation was steeped in ignorance and bigotry, and from having been one of the greatest maritime powers of Europe, the Portuguese were content with becoming a commercial dependent, rather than ally, of Great Britain. Under the reign of Joseph I., who died in 1777, the genius and resolution of the minister, Pombal (q. v.), infused temporary vigour into the administration, and checked for a time the downward tendency of the national credit. Pombal's efforts to rouse the people from their sloth, and infuse vigour into the government, were frustrated by the accession of Joseph's daughter, Maria, who, with her uncle-husband, Pedro III., allowed things to fall back into their old channels. The mental alienation of Maria led, in 1789, to the nomination of a regency under her eldest son, Joam. This prince, who shewed considerable capacity in early life, finding that he could not maintain even a shadow of independence on the outbreak of the war between Spain and France, threw himself wholly on the protection of England; and finally, when he learned that Napoleon had determined on the destruction of his dynasty, left P. in 1807, accompanied by all his family, and transferred the seat of his government to Rio Janeiro, the capital of Brazil. This act was immediately followed, on the part of the French, by the occupation and annexation of P.—a measure which gave rise to the Peninsular War. The victory of Vimeira, gained by the combined English and Portuguese army in 1808, freed the land from its French assailants; and in 1810, on the death of Queen Maria, the regent succeeded to the joint crowns of P. and Brazil. The continued residence of the new king, Joam VI., at Rio Janeiro, gave occasion to abuses and discontent, which resulted, in 1820, in the outbreak of a revolution at Lisbon, and the proclamation of a constitutional form of government in the place of the pre-existing absolutism. After a period of great national excitement and political disturbance, the differences between the sovereign and people were so far adjusted, that Joam agreed to and signed the constitution of P., and ratified the independence of Brazil, which was to be governed by his son, Dom Pedro, while he himself retained only the title of emperor. On the death of Joam in 1826, Pedro IV., after organising the government of P. on the model of the French charter, renounced the Portuguese crown in favour of his daughter, Doña Maria da Gloria, on condition of her marriage with her uncle, Dom Miguel. The latter, who, during the lifetime of Joam, had availed himself of

every opportunity to thwart the more liberal policy of his father and brother, waited only for the embarkation of the English troops to break the oath which he had taken to maintain the constitution, and gathering round him all who were in favour of restoring the old order of things in P., he was through their aid declared king by the Cortes, which met in June 1828. A period of indescribable confusion, misrule, and anarchy followed. The nobles, monks, and rabble ruled the land; 13,000 Portuguese citizens went into exile, while double that number of persons, suspected of favouring the Constitutional party, were kept in confinement. At length, in 1832, Dom Pedro was enabled, chiefly by means of a loan from Englishmen, to raise a fleet, and make a landing at Oporto. Admiral Napier, in the meanwhile, operated on the coast of Algarve successfully in favour of the young queen, whose cause, by these victories, and the support of an alliance with the great powers, finally proved victorious. Doña Maria made her entry into Lisbon in 1833; and in the following year Dom Miguel signed the Convention of Evora, by which he renounced all pretensions to the throne, and agreed to quit Portugal. The death of Dom Pedro in the same year, after he had effected several important reforms, proved a heavy misfortune to P., which suffered severely from the mercenary rule of those who occupied places of trust about the person of the young queen. Her marriage, in 1835, with Augustus, Duke of Leuchtenberg, his death at the end of a few months, and her second marriage, in 1836, with Prince Ferdinand of Saxe-Coburg, were followed by grave political disturbances, which in course of time were aggravated by the personal avarice and want of good faith of those in whom the young queen placed her confidence. A branch of the democrats, known as the Septembrists, from the month in which they made their first decisive stand against the government, loudly demanded the abrogation of the charter promulgated by Dom Pedro (and known as the *Carta de ley de 1826*), and the restoration of the constitution of 1820. This contest of the charters may be said to have continued through the entire reign of Doña Maria. The government was alternately in the hands of Septembrists and Chartists, towards both of whom the queen acted with a degree of duplicity that frustrated every effort at an adjustment of the national disorders. Insurrections and counter-insurrections were of frequent occurrence, the troops were not to be depended on in moments of emergency; guerrilla bands scoured the country at will, and openly defied the queen's authority. The Absolutists, or Miguelites, took advantage of the general disorder to produce a reaction in favour of the old church party. The financial embarrassments were complicated in the extreme; while the obstinacy of the nation in regard to the maintenance of the slave-trade, in defiance of treaties and pledges, brought them into temporary collision with Great Britain, the only ally on whom Doña Maria could rely. An armed intervention of the great powers in 1847 produced a partial abatement of the national disorders; and matters might have permanently improved, had not the queen's partiality for her unpopular ministers, Count Thomar and his brother Cabral, and her determination to leave the administration of affairs in their hands, exasperated the general discontent and distrust of the court, and led to the insurrection, which, without bloodshed, made the national idol, the Marquis de Saldanha, *de facto* military dictator of Portugal, and evoked a general expression of the popular wish for the queen's abdication. Saldanha's ministry, although begun under good auspices, soon manifested the

same readiness to succumb to the views of the court which had characterised former ministries. One Cortes was dissolved after another, and finally, in 1852, the government declared itself prepared to carry out necessary reforms without the concurrence of the Cortes, and to demand at a future period a bill of indemnity for its acts. At this crisis, the queen died suddenly, and her eldest son ascended the throne in 1853, as Pedro V., under the regency of the king-consort his father. The latter used his power discreetly; and by his judicious management, the financial disorders were partially adjusted; and since that period, P. has been less disturbed by party faction, the royal family have gradually recovered popularity, and the general condition of the nation is more promising. The premature and sudden death of the young king and his brother Joam in 1861, heightened these feelings of loyalty; and the present sovereign, Louis I., second son of Doña Maria, was proclaimed king in the midst of general feelings of attachment to, and sympathy with, the reigning house.

**PORTUGUESE LANGUAGE AND LITERATURE.** The Portuguese, like every other branch of the Romance family of languages, has grown out of a local form of the *Lingua Romana Rustica*, which in course of time had ingrafted upon it many elements of Arabic from the Saracenic invaders of the country, and numerous verbal and idiomatic characteristics of the Frankish and Celtic dialects, which were introduced with the Burgundian founders of the Portuguese monarchy. The earlier forms of Portuguese bore close affinity with the Galician, and although, in course of time, it presented strong resemblance to its sister language, the Castilian, in as far as both possessed numerous words of identical origin, it differed so widely from the latter in regard to grammatical structure, as almost to merit the designation of an original tongue. The antipathy existing between the Portuguese and Spaniards, and the consequent strenuous efforts of their best writers to keep their language distinct, and to resist the introduction of further Castilian elements, had the effect of making Portuguese still more dissimilar from the sister tongues of the peninsula, and the result is the production of a language differing from pure Spanish in having an excess of nasal sounds, and fewer gutturals, with a softening or hisping of the consonants, and a deepening of the vowels, which renders it the softest, but least harmonious, and the feeblest of all the Romance tongues. The earliest specimens of genuine Portuguese belong to the beginning of the 13th c., and consist for the most part of collections, or books of songs (*Cancioneiros*), which, both in regard to form and rhythm, resembled the troubadour or *minne* songs of the same period. Of these, the oldest is the *Cancioneiro del Rei Dom Diniz*, or Book of Songs, by King Diniz, who had long been regarded by the Portuguese as their earliest poet, but whose poems were supposed to be lost, till they were discovered, about twenty years since, in MS. in the library of the Vatican, and published at Paris and Lisbon in 1847. In the 14th and 15th centuries, the court continued to be the centre of poetry and art, as it had been under Diniz; but Castilian was in greater vogue than Portuguese, which was despised by the numerous royal poets, who emulated the example of Diniz, and composed love-songs and moral or didactic poems. Under the culture of these noble bards, the poetry of Portugal remained weak and effeminate, without acquiring even the tenderness and pathos which characterised the Spanish romances of that age. The poetry and literature of Portugal acquired new vigour with the growth of her maritime and commercial glory, and the *Cancioneiro Geral* (Lisb. 1516)

of the poet Garcia de Resende, which gives a general summary and extracts of all the Portuguese poets of the latter half of the 15th, and beginning of the 16th c., affords evidence of this improvement, which is most strongly exemplified in the sentimental pastorals or romances, and the national eclogues of Bernardino Ribeiro and Sá de Miranda, whose eclogues and prose dramatic imitations of Plautus and Terence, mark the transition period between the medieval lyrical and the later classical style. These first attempts at the drama were followed by Antonio Ferreira, whose *Ines de Castro* is the oldest Portuguese tragedy. But the classical school, whose chief cultivators were the courtiers of Lisbon and the professors of Coimbra, found little favour among the people at large, for the discoveries and conquests of the nation in Asia, Africa, and America, excited an enthusiasm and self-consciousness in the people, which led them to crave for something more practical and natural than the stilted style of the classicists. At this crisis, when P. was at the zenith of her material prosperity, appeared her greatest poet, Camoens, who, in his immortal epic, *Os Lusíadas*, which appeared in 1572, struck out a new path in the domain of epic poetry; while his numerous sonnets, 300 in number, his *Canções* or songs, his *Redondillas*, dramas, and other poetic productions, exhibit a versatility of genius and graceful tenderness which place him in the foremost rank of European poets.

With Camoens and his contemporary, Gil Vicente, the language and poetry of P. reached the culminating point of their development. During the dominion of Spain, the Portuguese so far lost all feeling of national independence and patriotism, that they at length renounced their native tongue, and adopted the language of their foreign rulers. With the restoration of political independence, under the sway of the Portuguese House of Braganza, a reaction took place; but the 17th and 18th centuries produced few Portuguese writers who attained more than an ephemeral and purely local reputation—bombast, or slavish imitation of Spanish and Italian writers, being the predominant characteristics of the Portuguese school of light literature. Some good historical writers belong, however, to this period, as Jacinto Freire de Andrade, whose life of Joao de Castro, Viceroy of India, still holds its place as the most perfect monument of classical prose; the great Indian missionary, the Jesuit Father Antonio Vierra, who died in 1699, and whose sermons and letters—of which a collection was published at Lisbon in 1743, and at Paris in 1838—are regarded by his countrymen as models of style and diction; F. X. da Meneses, the author of *O Portugal Restaurado* (1741), &c. In the beginning of the present century, Portuguese poetry was partially redeemed from its previous low grade by two men, who, although they professed to observe a strictly classical style, possessed a delicacy of taste, and a genial creative power, which saved them from falling into the absurdities that had generally characterised the school in Portugal. The elder of these, F. M. do Nascimento, who died in exile at Paris in 1819, although specially noted as an elegant lyricist, deserves notice for his gracefully written miscellaneous papers; while Manoel de Bocage, his less cultivated rival and contemporary, must undoubtedly be regarded as the most original and truly national of the modern poets of Portugal. His sonnets rank as the finest in the language, and these, with his numerous idylls, epigrams, and occasional poems, composed in various styles and modes of versification, have had a host of imitators, among the best of whom are the dramatist J. B. Gomes, J. M. da Costa e Silva; the satirist, T. da

Almeida; and the Brazilian, Antonio Caldas, distinguished for his sacred epics, and various imitations of Milton and Klopstock. The best of the recent Portuguese poets are M. de Albuquerque, A. de Castilho, and A. de Carvalho, and J. B. d'Almeida Garrett. The last-named, whose collected poetic and prose works appeared at Lisbon in 1840, was at once the most versatile and popular writer of his time in Portugal. In the departments of travels, geography, and history, P. has produced good writers from the earliest periods of its literary history; and in recent times, the works of H. Machado, J. Ferreira, and A. de Cajo, have well maintained the national reputation.—Portuguese literature is also cultivated in Brazil, and, of late years, with more success than in the parent country. The principal names in Brazilian poetry are, Gonçalves Dias, Macedo Abreu, and Magalhães; in history, Varnhagen, author of the *Historia general de Brazil* (1854), and P. da Silva, author of the *Brazilian Plutarch*; besides some divines, philosophers, and translators from the classics.

**PORTULACEÆ**, or **PORTULACACEÆ**, a natural order of exogenous plants, nearly allied to *Caryophyllaceæ*, from which it differs chiefly in the generally perigynous stamens, the calyx consisting of two sepals which are united at the base, and the capsule frequently opening transversely. The species are not very numerous; they are much diffused over the world, and are shrubby or herbaceous, generally succulent, mostly growing in dry places. The flowers are often large and beautiful, but ephemeral. The foliage is bland and insipid. Some species are used as salads and pot-herbs, of which the best known is Purslane (q. v.). The tuberous roots of *Claytonia tuberosa*, a Siberian plant, are used for food, as are those of the Melloco (*Melloca tuberosa* or *Ullucus tuberosus*), a Peruvian plant sometimes referred to this order. The genus *Calandrinia* furnishes some beautiful annuals to our flower-borders.

**POSEI'DON**. See NEPTUNE.

**PO'SEN**, a province of Prussia, bounded N. by Pomerania and East Prussia, E. by Poland, S. by Silesia, and W. by Brandenburg and Pomerania. Area, 11,260 square miles. Pop. at the close of 1861, 1,485,550. It is divided into the two governmental districts of Posen and Bromberg; and the principal towns are Posen, Bromberg, Gnesen, Lissa, and Inowraclaw. The principal river is the Wartha, which traverses P. from east to west, and is navigable throughout the greater part of its course, as is also the smaller Netza. The country is almost everywhere level, and its surface extensively covered with bogs, ponds, and small lakes. The soil is on the whole fruitful, and the numerous swamps and forests which covered the land during its annexation to Poland, have of late years been converted into rich meadow and good arable land, where cattle of superior quality are raised, and good crops of wheat, barley, oats, and flax are procured. The forests are extensive and productive, and contribute largely to the exports of the province, of which, however, the most important articles are corn, wool, tallow, hides, wax, and honey. With the exception of coal, which is obtained from beds near the town of Wronki, P. has no mineral products. Good broad-cloth, linens, and lace are manufactured in many of the small country-towns. Since the annexation of P. to Prussia, much has been done to supply the previous deficiency in regard to popular instruction; and there are now six gymnasia, several normal and training schools, a seminary for priests, and upwards of 2000 burgher and national schools. Nearly half the entire

population belong to the Roman Catholic Church, which is under the spiritual jurisdiction of the Archbishop of Gnesen and P., while 74,000 of the remainder are Jews. The inhabitants may still be said to be Poles, more than 800,000 persons employing Polish as their mother-tongue. P. formed an integral part of Poland till 1772, when, at the first partition of the Polish territory, the districts north of the Netze were given to Prussia. At the second and third partitions, which were made 20 years later, the remainder was incorporated in the Prussian kingdom under the name of South Prussia. In 1807, P. was included in the duchy of Warsaw; but by the act of the Congress of Vienna, it was separated in 1815 from Poland, and re-assigned to Prussia under the title of the Grand Duchy of Posen. In 1848, the Poles, who had never amalgamated with their new German compatriots, took advantage of the general political excitement of that period to organise an open rebellion, which gave the Prussian government considerable trouble, and was not put down till much blood had been spilled on both sides. On the cessation of disturbances, the German citizens of the province demanded the incorporation of P. with these Prussian states which were members of the German Confederation, and the Berlin Chambers gave their approval of the proposed measure in 1850; but on the subsidence of revolutionary sentiment in Germany, the subject was dropped, and P. returned to its former condition of an extra-German province of the Prussian monarchy.

POSEN (Polish *Poznan*), the chief town of the province of Posen, is situated on the low and sandy banks of the Wartha, 126 miles south-east of Stettin, on the Stettin and Vienna railway. Pop. at the close of 1861 was 43,879, besides 7353 troops. P., which ranks as one of the most ancient cities of Poland, became the seat of a Christian bishop in the 10th c., and was a member of the Hanseatic League during the middle ages, when it was an important trading mart between Western Europe and the Slavonic lands bordering on Asia. At the time of the great fire of 1803, when many of the older parts of the town were destroyed, P. lost the most striking features of its semi-oriental style of architecture, but it still retains a certain picturesque character, from the number of its church towers and lofty houses. Among its 15 principal churches, the most noteworthy are the cathedral, a recently restored and elaborately ornamented building, and St Stanislaus, a splendid specimen of Italian architecture. P., which is strongly fortified and enclosed within gates, has several pleasant suburbs, connected with it by means of wooden bridges. It is the see of an archbishop, the seat of the provincial government, and has a fine town-hall, two gymnasia, a public library with 20,000 volumes, training-schools for teachers of both sexes, a school for midwives, a theatre, &c. Recent restorations and improvements have rendered it one of the pleasantest-looking towns in Prussia, and it can now boast of many fine regularly built streets and squares, in which are situated the winter residences of many of the provincial Polish nobles. A considerable trade in wood, corn, wool, broad-cloth, and linen, is carried on here, principally by the Jews, and the annual fairs held in summer attract large crowds, including the nobility of the province. The chief manufactures, which are extensively sold at these fairs, are cloth, leather, carriages, copper vats and other vessels used in distilling, and tobacco; while there are likewise several breweries, distilleries, and sugar-refineries.

POSES PLASTIQUES (Fr. 'statuesque attitudes'), equivalent to *Tableaux Vivants* (q. v.).

POSILY'PO, a mountain on the north-west of Naples, close by the city, remarkable for the tunnel known as the Grotta di Posilipo, through which the road from Naples to Puzzuoli (anc. *Puteoli*) passes. The grotto is in some places 70 feet high, and 21 feet wide, and is 2244 feet long. It is very ancient. Seneca mentions it as the *Crypta Neapolitana*. Strabo assigns its construction to M. Cocceius Nerva, superintendent of aqueducts in the time of the Emperor Tiberius. Above the eastern archway of the grotto is the so-called 'Tomb of Virgil.' At the base of the hill of P. anciently stood the poet's villa, in which he composed the *Ecloques* and *Georgics*, if not also the *Aeneid*. During the middle ages, the common people firmly believed the grotto to be the work of the poet, whom they regarded as a great magician.

PO'SITIVE PHILO'SOPHY. See COMTE.

POSITIVE PRINTING, in Photography. This term is used to designate that process by which impressions from a Negative (q. v.) are produced upon suitably prepared paper. The term, however, does not belong exclusively to positives produced on paper, and intended to be viewed by reflected light, since transparent positives for examination by transmitted light are produced on glass. The means by which this kind of positives is obtained are so exactly similar to the dry negative collodion process, that a detailed notice thereof is hardly necessary in the present article, which will be confined exclusively to the means of obtaining positive proofs on paper.

Regarding, then, the negative, not so much as the picture as the means of producing one, the first thing which presents itself for notice is the paper. This may be either German or French, known in the markets under the respective names of Saxe and Rive. They are used in the simply salted condition, or more generally in the salted and albuminised state, the purpose of the albuminising being to prevent the chemicals used in the process from sinking into the paper, whereby the delicate details of the negative would become defective on the surface. The process is briefly as follows: Float the paper on the salting bath from one to five minutes; drain for one minute; hang up to dry. Float the paper on the exciting bath from five to ten minutes, according to its strength; drain, and hang up to dry. Expose in a pressure-frame under a negative. The necessary depth of impression, being obtained (a point only to be determined by experience), wash the print in common water. Some operators at this stage immerse the print in a bath containing one per cent. of ammonia for two or three minutes. This is by no means absolutely necessary; should it, however, be done, it should be afterwards washed in water for five or ten minutes; after which it is immersed in the toning bath from one to ten minutes, or until the desired tone be obtained; it is then rinsed in water for one minute, preparatory to immersion in the fixing bath. This last operation occupies from fifteen to thirty minutes, according to the strength of the fixing solution, and the depth to which the printing has been carried. The print is then copiously washed in many changes of water, and hung up to dry.

The baths referred to above are composed as follow: *Salting Bath*, water, 1 ounce; albumen, 4 ounces; good common salt, 48 grains. *Exciting Bath*, nitrate of silver, 240 grains; water, 4 ounces; glacial acetic acid, half a dram. *Toning Bath*, chloride of gold, 4 grains; water, 24 ounces; carbonate soda, 100 grains. *Fixing Bath*, hypo-sulphite of soda, 4 ounces; water, 1 pint.



The outlines of a new printing-process have recently been given to the world, which, for facility of manipulation, bids fair to supersede all others. The process is patented; it consists in coating good photographic paper with collodion, having salts of uranium and silver dissolved therein; the paper is then dried in the dark, when it is ready for printing. No *over-printing* is necessary, as no subsequent reduction takes place in the after-processes of toning and fixing. The toning is effected by immersion in a solution of chloride of gold, palladium, or platinum; by the use of which salts, and by varying the proportion of uranium in the collodion, also by varying the time of exposure, and the density of the negative, any desired tone may be obtained. Absolute permanency is claimed as one of the qualities of pictures printed by this process; this is, however, a point which time alone can determine.

A process of printing in carbon, lamp-black, or other impalpable powder, although at present (1865) surrounded by some manipulatory difficulties, possesses too many of the conditions calculated to insure that important desideratum, permanency, to be passed over without notice. The principle was first indicated by Mungo Ponton, and has since been experimented on by Portevin, Pouncy, Fargier, Gamia, and Salmon and Swan. In Pouncy's process, which may be regarded as a type of all the rest, an impalpable powder of lamp-black is intimately mixed with equal parts by increase of saturated solutions of gum-arabic and bichromate of potash. A uniform layer of this mixture is spread by means of a camel's hair-pencil on paper, and allowed to dry; it is then exposed under a negative from four to eight minutes, after which it is floated on water, impression side downwards, for five or six hours, and finally washed under the tap, and dried. The gum is rendered insoluble by the oxidising influence of the bichromate, just in proportion as the light has penetrated the negative, and in exactly the same proportion those parts protected from the solar action are dissolved and washed off. Portevin, in speaking of his method, says: 'I apply different colours, either liquid or solid, to the paper fabric, glass, or other surfaces, by mixing these colours with the bichromate and organic matter.' Other experimenters have substituted bichromate of ammonia for bichromate of potash, and gelatine for gum. The principle of this printing-process will be seen, on reference, to be similar to that involved in Photo-galvanography. See PHOTOGRAPHY

POSSÉ COMITATUS means the whole force of the county, consisting of knights and men above the age of 15, with constables, who attend the orders of the sheriff to assist in enforcing process or quelling riots. Justices of the peace can also, if apprehensive of an organised resistance, command the services of the posse comitatus, and it is the sheriff's duty to raise the necessary number of men. But practically, in modern times, constables and special constables are all the assistance given or required.

POSSESSION OF PROPERTY, in point of law, is the most intimate relation that can subsist between the owner and his property. Strictly speaking, the idea of property consists merely of a certain relation between a human being and a portion of external nature, whereby he appropriates to himself all the ordinary uses of which such external nature is capable. If it is land, he reaps the fruits, and excludes all other persons from interfering with his operations; if it is a chattel, he keeps it under his exclusive control. Possession, therefore, is nothing but the legal result of the relation of property. Possession, though originally constituting

the whole substance of property, has, as civilisation advanced, become a separable part of it; and while the radical right is now the ownership, the possession is viewed as an incident of such ownership. It is now not only separable but saleable, and constitutes the foundation of the contract between landlord and tenant, whereby the owner, by way of a lease, sells for a limited period the exclusive use, otherwise called the possession. So long, therefore, as an owner exists, he has, as a necessary consequence, the right, more or less immediately and directly, to the possession of property. When all record of ownership is lost, then the law permits a resort to first principles, and allows any person who has been in possession for a limited time to retain it, and so ultimately acquire the ownership. If the possession is suddenly or wrongfully interfered with, the usual remedy, in England, to recover possession of real property, such as land or houses, is an action of ejectment; if the property is a chattel, it is an action of trover or detinue. But the possession may be recovered also by other modes. See also OWNERSHIP and LOST PROPERTY.

PO'SSET, a dietetic preparation, made by curdling milk with some acidulous liquor, such as wine, ale, or vinegar. White wine or sherry is usually preferred, but sometimes old ale is used. The milk is boiled; and whilst it is still on the fire, the acidulous matter is added; if sherry, about a wine-glassful and a half to the pint of new milk is the proportion; or twice the quantity if ale. A teaspoonful of vinegar or of lemon-juice is sometimes used instead; one or two tablespoonfuls of treacle are added, to sweeten. Taken at bedtime, it is used for colds and coughs.

POST-CAPTAIN, an obsolete title applied to captains in the royal navy: it has been disused for many years. See CAPTAIN.

POSTE RESTANTE (Fr., to remain at the post-office till called for), a usual mode of addressing letters to persons who are merely travelling in, or passing through, a country in which they have no fixed residence. English travellers on the continent have very generally their letters so addressed to some town through which they expect to pass. The *poste restante* office is open at certain hours, and the letters are given out when called for, production of a card, passport, or other evidence of identity being sometimes required. Letters unclaimed for a certain time are opened, and either destroyed or returned to their writer. There is a *poste restante* office in London, under stringent regulations as to the conditions on which letters are given out. If the applicant for a letter be a British subject, or subject of a state not issuing passports, he must state the place from which he expects letters, and he, or the messenger who applies for him, must be provided with some proof of identity. If he be the subject of a country which issues passports, his passport must be produced. In the provincial post-offices of Great Britain, commercial travellers, tourists, and persons without a settled residence, may have their letters addressed *poste restante*, and they are kept at the post-office till called for; but residents are not allowed to have their letters so addressed, and the post-office authorities have orders to deliver them. In the British post-office, letters addressed *poste restante* are kept one month, and then returned to the writer through the dead-letter office.

POSTERN, in Fortification, is a small doorway communicating usually through the flank of a bastion between the fort and the ditch. Its object is to afford unseen egress to troops marched out to relieve sentries on the external works, to make

sallies, &c. The postern is often called the 'sally-port.'

**POSTING**, the forwarding of passengers from place to place by means of relays of horses. The application of the same words—post and postmaster—to the transmission of letters and to the stations where post-horses are kept, is, both on the continent of Europe and in Britain, a source of ambiguity. Posting was long in Britain, as it is yet in most parts of the continent, a government monopoly. A statute of Edward VI. fixed the charges of posting at 1*d.* per mile in 1548. The post-office act of 1656 confirmed the monopoly of furnishing post-horses for travellers in favour of the postmaster and his deputies; for a long time past, however, posting has been in the hands of private individuals. Post-chaises were first used in France, and introduced into England in the early part of last century. The payment is estimated per mile for each pair of horses, without regard to the number of persons conveyed; and a second pair of horses is charged at the same rate as the first.

Over the continent generally, posting is managed by the state, which retains the monopoly of supplying post-horses, and usually of forwarding the mails and diligences. The prices are fixed by government, as well as the number of horses that may be employed, which is regulated by the weight and number of persons conveyed.

**POSTIQUE**, an ornament in sculpture, marble, &c., applied or added after the work is otherwise finished.

**POST-NUPTIAL CONTRACT** means, in Scotch law, an agreement, or, as it is called in England, a settlement, made between husband and wife after the marriage has taken place, with a view to affect the property of the parties, and generally to make provision for the wife and children. As a general rule, a post-nuptial settlement is not so effectual as an ante-nuptial settlement in securing the rights of a wife, because in the former case the marriage is considered a valuable consideration in point of law, and puts it on the footing of a sale. Nevertheless, if the husband is quite solvent, he and his future creditors will be bound by the provisions of a post-nuptial contract. See **HUSBAND AND WIFE**.

**POST-OBIT** is a bond or security given by heirs and others entitled to reversionary interests, whereby, in consideration of a sum of money presently advanced, the debtor binds himself to pay a much larger sum after the death of some person, or of himself. Whenever, as is not unusual, the payment is uncertain, and depends on the obliger outliving somebody else, very high interest is required, or rather a very much larger sum is agreed to be repaid than what is advanced. These are generally usurious bargains; but the obligee or creditor can enforce payment of the full amount; though, if there is a gross case of inadequacy in the proportions amounting to fraud, a court of equity will interfere.

**POST-OFFICE**, a place for the reception of letters, and the management of the various departments connected with their dispatch and conveyance. The name originated in the posts (from Lat. *positum*, placed, fixed) placed at intervals along the roads of the Roman empire, where couriers were kept in readiness to bear dispatches and intelligence; but the posts of ancient times were never used for the conveyance of private correspondence. The first letter-post seems to have been established in the Hanse Towns in the early part of the 13th century. A line of letter-posts followed, connecting Austria with Lombardy, in

the reign of the Emperor Maximilian, which are said to have been organised by the princes of Thurn and Taxis; and the representatives of the same house established another line of posts from Vienna to Brussels, connecting the most distant parts of the dominions of Charles V. This family continue to the present day to hold certain rights with regard to the German postal system, their posts being entirely distinct from those established by the crown, and sometimes in rivalry to them.

In England, in early times, both public and private letters were sent by messengers, who, in the reign of Henry III., wore the royal livery. They had to provide themselves with horses until the reign of Edward I., when posts were established where horses were to be had for hire. Edward IV., when engaged in war with Scotland, had dispatches conveyed to his camp with great speed by means of a system of relays of horses, which, however, fell into disuse on the restoration of peace. Camden mentions the office of 'Master of the Postes' as existing in 1581, but the duties of that officer were probably connected exclusively with the supply of post-horses. The posts were meant for the conveyance of government dispatches alone, and it was only by degrees that permission was extended to private individuals to make use of them. A foreign post for the conveyance of letters between London and the continent seems to have been established by foreign merchants in the 15th c.; and certain disputes which arose between the Flemings and Italians, regarding the right of appointing a postmaster, and were referred to the privy-council, led to the institution of a 'chief-postmaster,' who should have charge both of the English and the foreign post. Thomas Randolph was the first chief-postmaster of England. The first proper postal communication for private letters in England came into operation 100 years after the institution of the foreign post. The increased intercourse between the English and Scottish capitals, brought about by King James's accession, led to a great improvement in the system of horse-posts, but their services were still confined to the conveyance of government dispatches. That king, however, instituted a foreign post for letters going abroad from England, and conferred the office of postmaster of England for foreign parts on 'Mathewe de Quester the elder, and Mathewe de Quester the younger.' This appointment was considered by Lord Stanhope, the English chief-postmaster, to interfere with his functions, and a dispute and law-plea between the heads of the two establishments was settled in 1632, after Charles I. had become king, by the retirement of Lord Stanhope, and an assignment of their office by the De Questers, under royal sanction, to William Frisell and Thomas Witherings. In 1635, Witherings was authorised to run a post night and day between London and Edinburgh, 'to go thither and back again in six days.' Eight main postal lines throughout England were at the same time instituted, and the post was allowed to carry inland letters. Two years later, a monopoly of letter-carrying was established, which has been preserved in all the subsequent regulations of the post-office. The rates of postage were 2*d.* for a single letter for a distance less than 80 miles, 4*d.* up to 140 miles, 6*d.* for any longer distance in England, and 8*d.* to any place in Scotland. An attempt, in 1649, by the Common Council of London to set up a rival post-office for inland letters, was suppressed by the House of Commons. A practice of farming the post-office revenues, which began in 1650, continued, as regards some of the by-posts, till the close of last century.

An important post-office statute was passed

## POST-OFFICE.

under the Protectorate in 1656, and re-enacted by 12 Car. II. c. 35. It ruled that there should be one general post-office and one postmaster-general for England, who was to have the horsing of all through posts and persons riding post. A tariff was established for letters, English, Scotch, Irish, and foreign, and the only non-governmental posts allowed to continue were those of the universities and the Cinque Ports.

In 1685, a penny-post was set up for the conveyance of letters and parcels between different parts of London and its suburbs. It was a private speculation, originating with one Robert Murray, an upholsterer, and assigned by him to Mr William Docwray. When its success became apparent, it was complained of by the Duke of York, on whom the post-office revenues had been settled, as an encroachment on his rights; a decision of the Court of King's Bench adjudged it to be a part of the royal establishment, and it was thereupon annexed to the crown. In this way began the London district-post, which was improved and made a twopenny-post in 1801, and continued as a separate establishment from the general post down to 1854.

The first legislative enactment for a Scottish post-office was passed in 1695, prior to which time, the posts out of Edinburgh had been very few and irregular. About 1700, the posts between the capitals were so frequently robbed near the borders, that acts were passed both by the parliament of England and that of Scotland, making robbery of the post punishable with death and confiscation. The post-offices of Ireland is of later date than that of Scotland. In the time of Charles I., packets between Dublin and Chester, and between Milford-Haven and Waterford, conveyed government dispatches; and after the Restoration, the rate of letter-postage between London and Dublin was fixed at 6d.

Act 3 Anne, c. 10, repealed the former post-office statutes, and put the establishment on a fresh basis. A general post-office was instituted in London for the whole British dominions, with chief offices in Edinburgh, Dublin, New York, and other places in the American colonies, and one in the Leeward Islands. The whole was placed under the control of an officer appointed under the Great Seal, called the Postmaster-general, who was empowered to appoint deputies for the chief offices. Rates higher than those formerly charged were settled for places in the British dominions, and also for letters to foreign parts. A survey of post-roads was ordered, for the ascertainment of distances. Letters brought from abroad by private ships were ordered to be handed over to the deputy-postmasters of the ports, who were to pay the master a penny for each letter. A complete reconstruction of the cross-post system was effected in 1720, by Ralph Allen, postmaster of Bath, to whom the Lords of the Treasury granted a lease of the cross-posts for life: at his death, they came under the control of the postmaster-general. The rates of postage were further raised by act 1 Geo. III. c. 25, which also gives permission for the establishment of penny posts in other towns, as in London. The Edinburgh penny-post was instituted in 1766, by one Peter Williamson, a native of Aberdeen, whom the authorities induced to take a pension for the good-will of the concern, and merged it in the general establishment.

Mail-coaches owe their origin to Mr John Palmer, manager of the Bath and Bristol theatres, who, in 1783, submitted to Mr Pitt a scheme for the substitution of coaches, protected by armed guards, for the boys on horseback, who till then conveyed the mail. After much opposition from the post-office authorities, his plan was adopted, and Mr Palmer,

installed at the post-office as controller-general, succeeded in perfecting his system, greatly increasing the punctuality, speed, and security of the post, and adding largely to the post-office revenue.

In 1837, a plan of post-office reform was suggested by Mr (now Sir) Rowland Hill, the adoption of which has not only immensely increased the utility of the post-office, but changed its whole administration. Its principal features were the adoption of a uniform and low rate of postage, a charge by weight, and prepayment. The change met with much opposition from the post-office authorities, but was eventually carried by a majority of 100 in the House of Commons, becoming law by 3 and 4 Vict. c. 96. The new system came into full operation on January 10, 1840. Previously to the change, members of parliament had the right of sending their letters free, but this privilege of franking was entirely abolished. A penny was adopted as the uniform rate for every inland letter not above half an ounce. Facilities for prepayment were afforded by the introduction of postage-stamps, and double postage was levied on letters not prepaid. Arrangements were made for the registration of letters; and the money-order office, by a reduction of the commission charged for orders, became available to an extent which it had never been before. As far back as 1792, a money-order office had been established as a medium for sailors and soldiers to transmit their savings, and its benefit had afterwards been extended to the general public; but the commission charged had been so high, that it was only employed to a very limited extent. The immediate result of the changes introduced in 1840 was an enormous increase in the amount of correspondence, arising in part from the cessation of the illicit traffic in letters, which had so largely prevailed before; but for some years there was a deficit in the post-office revenue. The reduction of postage-rates was, however, a reduction of taxation, and if the Exchequer lost revenue from one source, it gained it in other ways.

Since the adoption of Sir Rowland Hill's system, the most important changes in the post-offices are those which have arisen from the absorption of the whole traffic of the country by railways, and their substitution for mail-coaches in the conveyance of letters. This has greatly increased the expenses of the post-office establishment; notwithstanding which, the former gross revenue of the post-office was exceeded in 1851, and the net revenue in 1863.

According to the latest returns, there are 11,316 post-offices in the United Kingdom, of which 808 are head-offices, and 10,508 sub-offices. To these must be added a large number of road letter-boxes, making in all 14,776 public receptacles for letters—at least 10,000 more than existed under the former system. The total number of letters which passed through the post-office in 1863 was 642,000,000, an eight-fold increase from the last year of dear postage. The gross revenue of the post-office in 1863 was £3,800,000, to which should be added £130,000 for the impressed stamp on newspapers sent through the post; the expenditure £3,000,000, and the clear revenue £900,000. The amount of money transmitted by post-office orders in 1839 was £313,000; in 1863, £16,494,000.

The postal service of the three kingdoms is now under the immediate control of the postmaster-general, assisted by the general secretary of the post-office in London. There are also chief officers in Edinburgh and Dublin, with secretarial and other departmental staffs. The postmaster-general is a peer, a member of the privy-council, and generally a cabinet minister. He has a salary of £2500, and is the only officer connected with the department

## POST-OFFICE.

who leaves office on a change of government. The secretary is his responsible adviser, and has a salary of £2000. The General Post-office in London is divided into seven principal departments, each under the charge of a chief officer; a similar arrangement, on a smaller scale, being adopted in the chief offices of Edinburgh and Dublin. These departments are: 1. The Secretary's Office, which exercises a surveillance over the rest. 2. The Solicitor's Office, which has to do with the legal business of the post-office. 3. The Mail Office, which deals with all matters relating to the transmission of the mails. Attached to, and under the management of this office, are the travelling railway post-offices, which accompany the mail-trains, and in which the letters are received and arranged during transit. At many stations, the letter-bags are received and dropped by means of machinery, while the train is going at full speed. 4. The Receiver and Accountant-general's Office, which keeps account of the money received by each department, receiving remittances from branch and provincial offices, and taking charge of the payment of all salaries, pensions, and items of current expenditure. 5. The Money-order Office, which conducts the whole money-order business of the country, receiving daily accounts from each provincial postmaster. 6. The Circulation Office, which takes charge of the ordinary post-office work of London—sorting, despatching, and delivering all the letters, newspapers, and book-packets arriving in London, sorting and despatching the greater part of the foreign mails, and arranging and forwarding a large proportion of the British letters *in transitu*. 7. The Post-office Savings-bank department, established in 1861 by act 24 Vict. c. 14. This department keeps a separate account for every depositor, acknowledges the receipt of every deposit, and on the requisite notice being furnished, sends out warrants authorising postmasters to pay withdrawals. The deposits are handed over to the Commissioners for the Reduction of the National Debt, and repaid to the depositors through the post-office. The rate of interest payable to depositors is 2½ per cent. Each depositor has his savings-bank book, which is sent to him yearly for examination, and the accruing interest is calculated and allowed. The surveyors' department is the connecting link between the metropolitan and the provincial offices, each provincial postmaster being under the immediate supervision of the surveyor of his district. The number of officers employed in the British post-office, at the end of 1862, amounted to 25,380, of whom between 3000 and 4000 were attached to the general post-office in London.

One important and expensive part of the post-office establishment is the home and foreign mail-packet service. This department was, in the 17th and 18th centuries, in the hands of the post-office authorities, but was removed to the Board of Admiralty, under whose control it remained till 1860, when it was again restored to the post-office. Steam-vessels were first used for conveying the mail in 1821, and in 1833, mail-contracts were introduced, the first being with the Mona Steam Company to run steamers from Liverpool to Douglas in the isle of Man. In 1839, a contract was entered into with Mr Samuel Cunard of Halifax, Nova Scotia, for a fortnightly mail across the Atlantic for £60,000 a year. Of the home mail-packet contracts, the most important are those with the City of Dublin Steam-packet Company for conveying the Irish mails between Holyhead and Kingstown. The principal foreign contracts are for the Indian and Chinese mails, entered into by the Peninsular and Oriental Steam-navigation Company, for which £253,000 is

paid annually. The foreign mail-packets travel not less than 3,000,000 miles every year, the average cost per mile being 6s. 4d.

The post-office statute of Queen Anne contains a prohibition, repeated in subsequent acts, for any person employed in the post-office to open or detain a letter, except under a warrant from one of the principal secretaries of state. During last century, such warrants were often granted on very trivial pretences. In 1723, at Bishop Atterbury's trial, copies of his letters, intercepted at the post-office, were produced in evidence against him; and in 1735, it appeared that an organisation existed, at an immense expense, for the examination of home and foreign correspondence. In 1782, the correspondence of Lord Temple, when Lord-lieutenant of Ireland, was subjected to a system of post-office espionage. In the beginning of the present century, an improvement took place in this matter, and Lord Spencer introduced the custom, in 1806, of recording the dates of all warrants granted for the opening of letters, and the grounds on which they were issued. Since 1822, the whole warrants have been preserved at the Home Office; and a House of Commons' return in 1853 shews that, in the preceding ten years, only six letters were detained and opened—four in cases of felony, and two that they might be properly returned to those who claimed them. One of these cases of interference with the privacy of correspondence occurred in 1844, when Sir James Graham, as Home Secretary, issued a warrant for opening the letters of Mazzini, and caused certain information contained in them to be conveyed to the Austrian Minister, an act which involved the ministry of the day in considerable popular obloquy, and produced a wide-spread, though very groundless, distrust of the security of the ordinary correspondence of the country. See GRAHAM, SIR JAMES.

The following is a summary of the most important regulations of the British post-office, reference being made for the minute details to the *British Postal Guide*.

**Inland Letters.**—The rates of postage are 1d. for a letter weighing not more than half an ounce; 2d. where the weight is between half an ounce and an ounce; from one ounce to two ounces, 4d.; and so on—2d. being charged for every additional ounce. Letters weighing less than four ounces may be sent unpaid, but will be charged double postage on delivery. Letters insufficiently stamped are charged double the deficiency on delivery. Redirected letters are charged additional postage at the pre-paid rate. Letters for officers, soldiers, and seamen are, however, redirected without charge.

No letter can be conveyed by post which is more than two feet in length, breadth, or depth; nor any unpaid letter or packet weighing more than four ounces, unless ½ths of the postage have been paid. There are exceptions to this rule in the case of packets sent to or received from places abroad, packets sent to or from any government department, petitions to the Queen or either House of Parliament, and printed parliamentary proceedings. Sharp instruments, glass, &c., are not allowed to be sent in letters.

**Registration.**—The registration fee of 4d., prepaid in stamps, secures careful treatment to any letter, newspaper, or book-packet, and renders its transmission more secure, by enabling it to be traced from its receipt to its delivery. Letters may be registered for a fee of 6d. to most British colonies, and for various rates of charge to different foreign countries. Letters containing coin, if not registered, are treated as if they were, and charged on delivery with a double registration fee, in addition to the

## POST-OFFICE.

postage. The post-office is not responsible for the absolute security of registered letters.

*Foreign and Colonial Letters.*—For the rates payable, reference is made to the *British Postal Guide*. Prepayment must be either wholly in stamps or wholly in money. In some cases, prepayment is optional; in others, compulsory. When optional, an outward letter, posted with an insufficient number of stamps, is charged the deficient postage in addition, except where it has to go to Holland, the United States, or to any country through France, in which case it is treated as wholly unpaid. Where prepayment is compulsory, an insufficiently prepaid letter goes to the Returned letter-office, to be returned to the sender. Insufficiently paid letters for Russia and Poland are treated as wholly unpaid. Letters to and from Ceylon, Australia, New Zealand, the British West Indies, Honduras, and St Helena, posted wholly unpaid, or paid less than one rate, are returned. If paid one rate, where chargeable with more, they are forwarded, charged with the deficient postage and 6d. of fine. Letters for New Zealand must be fully prepaid. Letters for the remaining British colonies, wholly or partially unpaid, are charged 6d. in addition to the ordinary postage.

Letters to be sent by private ship must be so marked; their postage is 6d. for half an ounce, and (except to the North American and African colonies) they must be prepaid.

Letters to passengers on board the Cunard or Mediterranean packets must be registered, and should be addressed to the care of the officer in charge of the mails.

The post-office monopoly is applicable to letters only; and it does not include letters sent specially by private messenger.

*Newspapers.*—Newspapers stamped with the *unpressed stamp* are charged one penny for two sheets, three-halfpence for three sheets, and twopence for four sheets of printed matter. The title and date must be printed at the top of each page. The stamp must be visible outside, otherwise a fine of one penny is exacted in addition to the postage. The newspaper is required to be not above 15 days old. The cover, if there is one, must be open at both ends, and there must be no writing outside or inside, except the address of the person to whom the newspaper is sent.

A newspaper to be sent abroad must be first registered at the General Post-office. Newspapers intended for transmission to the colonies or foreign countries, must be prepaid with *postage-stamps*, although they are otherwise liable to the same regulations as English newspapers bearing impressed stamps.

*Parliamentary proceedings.*—The printed proceedings of parliament, with the words 'Parliamentary Proceedings' written or printed on the cover, may circulate throughout the United Kingdom at the following rates, of which prepayment is optional—viz., when weighing not more than 4 oz., 1d.; between 4 and 8 oz., 2d.; and so on—a penny being charged for every additional quarter of a pound or fraction of a quarter of a pound.

*Book-post.*—This branch of the post-office was first established in 1848, and further improved by regulations issued in 1855 and 1857. Books and printed or written matter of any kind, except letters, prints, maps, photographs, and all matter which may be sent by the newspaper-post, or as parliamentary proceedings, may now be sent through the book-post at the following rates: below 4 oz., 1d.; between 4 oz. and 8 oz., 2d.; between 8 oz. and 1 lb., 4d.; and so on—2d. being charged for every additional half-pound or fraction of

a half-pound. A book-packet must be prepaid, and with postage-stamps; if insufficiently paid, it is charged an additional rate over and above the deficiency; and if altogether unpaid, it is charged as an unpaid letter. If there is a cover, it must be open at the ends. No book-packet must exceed two feet in length, width, or depth, nor must it contain anything sealed against inspection. An entry on the first page of the book stating who sends it is allowed, and even recommended. No writing in the way of a letter or communication is allowed; if any such communication be found within a packet, and forming a component part of it, the whole will be charged the unpaid letter rate, and forwarded. If, however, the communication can be separated from the packet, it will be taken out, and forwarded alone, and the remainder of the packet delivered free. The book-post has been extended to all the colonies.

*Pattern-post.*—Parcels containing patterns of merchandise may be forwarded at the following fixed rates, prepaid with stamps: if under 4 oz. weight, 3d.; between 4 oz. and 8 oz., 6d.; between 8 oz. and 1 lb., 1s.; and so on—6d. being charged for every additional half-pound or fraction of half a pound. The pattern must not be of intrinsic value, nor must it contain writing inside, except the address or trade-mark of the manufacturer, and the numbers or price of the articles sent. The patterns are to be sent in covers open at the ends or sides; but samples of articles which cannot be placed in open covers, may be enclosed in bags, so tied that they can be opened at the post-office. Articles by which the contents of a letter-bag might be damaged, are prohibited to be sent in this way.

*Money Orders.*—Inland money orders may be obtained at any of the post-offices of the United Kingdom, on payment of the following commission: for a sum not exceeding £2—3d.; from £2 to £5—6d.; from £5 to £7—9d.; from £7 to £10—1s. The commission on orders payable at Gibraltar and Malta is three times, and on orders payable in the other colonies, four times the above rate. In applying for a money order, the surname and initial, at least, of one Christian name of the sender, and the name of the person to whom payable, must be given; but the designation of a firm will suffice, and the name of the person to whom the order is payable may be withheld, if it is to be paid through a bank. A money order in the United Kingdom becomes lapsed, if not presented for payment before the end of the second calendar month after that in which it was issued. A second commission for a new order will, after that time, be necessary. In the colonies, six months are allowed. If an order is not paid before the end of the twelfth calendar month after that in which it was issued, all claim to the money is lost. Sums accruing to the revenue from lapsed orders, go into a fund for assisting officers of the post-office to pay their premiums on life-assurance policies.

Petitions to Her Majesty or either House of Parliament (if open at the ends), and letters on the business of the post-office to the head-office or the district-surveyors, may be sent free.

Any person with a fixed residence may have a private box at the post-office on paying an appointed fee; but in no other case can a resident have his letters addressed to the post-office. See **POSTS RESTANTE**.

The postal system of France dates from the time of Louis XI.; but the posts were at first exclusively for the royal service, and only gradually became available for private correspondence. It was not till 1672 that any settled revenue accrued

to government from the post-office. The law of France vests in the post-office the exclusive right of carrying letters, newspapers, periodicals, packets, and papers of all kinds not exceeding a kilogramme (2 lbs.) in weight, subject to the following exceptions: 1, Letters or packets sent by one private person to another in charge of a servant or messenger; 2, registers, maps, and plans; 3, proceedings in the courts of law; 4, printed books not periodical; 5, newspapers in collective packets exceeding one kilogramme in weight; 6, letters accompanying and relating to merchandise; 7, papers relating to the personal business of a carrier. The last two must be open at the sides or ends. Besides the service, of which it has a legal monopoly, the French post-office undertakes, at special rates, to convey—1, valuable articles of small dimensions; 2, books, prints, and autographs; 3, prices-current and circulars; 4, visiting-cards; 5, money subscriptions to certain legal periodicals; 6, money by orders at a commission of 2 per cent. In 1848, a uniform rate was established for inland letters—20 centimes (2d.) for letters not exceeding a quarter of an ounce in weight, unpaid letters being charged a rate and a half. There are lower rates (10 centimes and 15 centimes) for local letters. Since 1856, there have been five distinct tariffs for postal matter not of the nature of ordinary correspondence. Postage-stamps were introduced in 1848.

The principal features of the post-office system introduced into Great Britain in 1840, have since been adopted, in a more or less modified form, over the greater part of the world. The half-ounce scale is in use in nearly the whole of Germany, in the United States of America, in Holland, Denmark, Spain, Peru, and Brazil; while France, Switzerland, and Italy have adopted the quarter of an ounce as their unit. Postage-stamps are also in almost universal use over the civilised world.—See, as regards the British Post-office, Lewins's *Her Majesty's Mails* (Lond. 1864), and the *British Postal Guide*.

**POST-OFFICE, OFFENCES AGAINST.** Owing to the conspicuous part which the post-office plays in modern civilisation, a small code of laws belongs to it, the substance of which is as follows: Every person employed by the post-office who steals a post-letter, is guilty of felony; and if it contain money or a valuable chattel, the punishment is increased. So whenever letters are stolen by strangers out of the custody of the post-office or its officers. The moment a letter is put into the post-office or delivered to the postmaster, the protection of the statutes commences. Many nice questions have, however, arisen as to the application of the rule to special circumstances, and as to what constitutes an employment by the post-office. Whoever steals, secretes, or destroys printed papers or newspapers sent by post, commits a misdemeanour. So if a letter-carrier delay the delivery willfully, except in the case where the person is dead, or the direction cannot be read, or the postage is neglected to be paid. Receivers of letters improperly taken or stolen from the post-office, are guilty of felony. By the 1st Vict. 33, s. 2, any person conveying otherwise than by post a letter not exempted from the exclusive privilege of the postmaster-general, incurs a penalty of £5 for every letter. This exclusive privilege of carrying letters extends to letters only, and not to printed books or newspapers. There are also exceptions to the general rule, that letters can only be sent by the post-office. Thus, one may send a letter by a private friend, and not by the post-office. So letters sent by messenger on purpose on the private affairs of the sender or receiver, commissions and legal

writs, merchants' letters sent by vessels or along with goods, are excepted. But no person is authorised to collect and send these excepted letters, though in the legal manner described, for this is doing the work of the post-office. Moreover, there are certain persons expressly prohibited from carrying letters even gratuitously, as common carriers, except the letters relate to goods in their carts or wagons; owners, masters, or commanders of ships, except such letters relate to goods on board; and passengers on board ships. Though no penalty or punishment is prescribed for violating these prohibitions of the Post-office Act, it is an indictable offence to contravene the statute.

**POSTULATE.** This word occurs in Geometry, and signifies something that is *demanded*, and must be granted before the demonstrations of the science can be wrought out. The postulates of Euclid have reference to certain constructions indispensable to the reasoning. They are these three: 'A straight line may be drawn from one point to another'; 'A line already drawn may be produced'; and 'A circle may be described from a given centre, with a given radius.' The object of laying down these in the shape of demands, is to fulfil one great condition of demonstrative science, which is, that nothing shall be proceeded on, in the course of the reasoning, without being explicitly stated at the outset. It has been noticed by critics that the three postulates of Euclid do not exhaust the demands actually made in the course of his demonstrations. Thus, in the 4th and 5th Propositions, Book I, this postulate is assumed: 'Any figure may be removed from place to place without alteration of form, and a plane figure may be turned round on the plane.'

The postulate is something different from the axiom. An axiom is a general and fundamental principle, such as no one can deny, and serving as the ultimate foundation (in Logic, the major premise) of deductive inferences; as, for example, 'Things equal to the same thing are equal to one another.' The postulate, in Euclid's sense, is a special accessory to the reasoning, different from the axioms.

But in Philosophy, the postulate takes a much wider sweep, and expresses the most fundamental concessions implied in all reasoning, being prerequisite in order to the establishment of the axioms themselves.

Thus, it is a postulate necessary to reasoning and discussion that a reasoner shall be consistent with himself—that he shall not affirm a thing one minute and deny it the next. The so-called Laws of Thought—Identity, Contradiction, and Excluded Middle—are so many forms of the postulate of consistency. These laws are tantamount to demanding that the same thing shall not be maintained in one form, and denied in another. If we say this room is hot, we must not, at the same time, say that it is not hot. So the ordinary law of the syllogism, 'Whatever is true of all the members of a class, is true of each,' is not so much an axiom as a postulate of consistency; we must be prepared to repeat individually the statements that we have affirmed collectively.

The ultimate premises of all truth and reasoning may be put in the form of postulates, as follows: 1. Present Consciousness must be admitted as a ground of certainty. 'I am thirsty,' 'I hear a sound,' as facts of present consciousness, are to be held as trustworthy in the highest degree, or as amounting to the highest certainty. 2. But present consciousness is not enough; it must further be conceded that Past Consciousness is a ground of certainty. Present consciousness does not amount to an experience of value for future purposes, unless

taken with past. Now, although a remembrance that is long past is often uncertain, a recent remembrance must be pronounced absolutely certain, not less than a present consciousness. That 'I was thirsty a short time ago,' I must be certain of, in order to establish the induction, 'that water quenches thirst.' 3. It must further be conceded, that 'What has been in the past, all circumstances holding the same, will be in the future.' That a thing has been, does not imply that it will be. We may admit that the sun has risen to-day, and rose yesterday, and so on, and without inconsistency, refuse to admit that it will rise to-morrow. People are generally well enough disposed to treat this as a certainty; indeed, there is a strong natural tendency of the mind to expect that the future will resemble the past, which, when corrected and regulated by experience, constitutes our belief in causation and the uniformity of nature. Still, a blind instinct is no guarantee for truth; and as the assertion of the future is a distinct position, it should be formally assumed in a separate postulate. However often a thing may have happened, we still make a leap, and, so to speak, incur a risk in venturing to predict its future recurrence. Our confidence no doubt increases with repetition, but nothing can obliterate the line between what *has been* and what *is to be*.

These three Postulates of Experience, coupled with the Postulate of Consistency, seem adequate as a basis of all the recognised axioms and truths of experience. In other words, the concession of them is enough to commit any one to the reception of all inductive and deductive evidence.

POSTULATION (Lat. 'an asking'), in Canon Law, means a presentation or recommendation addressed to the superior, to whom the right of appointment to any dignity belongs, in favour of one who has not a strict title to the appointment. It is one of the forms of proposing to the pope persons nominated, but not, strictly speaking, elected, to a bishopric. It is also used in the case of elections in which the candidate, although regularly chosen by the electors, yet labours under some legal disability which involves the necessity of a dispensation. The presentation of candidates for the episcopacy, as it exists in the Roman Catholic Church in Ireland, is called postulation.

POSTURES, the name given to the attitude observed in worship, whether private or public, but especially the latter. They are the natural expressions of the feeling which accompanies or characterises the particular devotion in which they are employed, and are used by suppliants to man as well as to God. Four postures are found to have been used by the ancient Christians in their prayer—the standing, the kneeling, the bowing or inclined, and the prostrate. Of these, the ordinary one was kneeling; but for it was substituted, during the Easter-time and on the Sundays, a standing posture, which was understood to symbolise the resurrection of our Lord. To this usage we find allusions as early as the time of Justin the Martyr. In the paintings of the catacombs, and on the ancient enamelled glasses found therein, the standing posture in prayer is accompanied by outstretched and upraised hands. The bowing posture was rather a special act of reverence accompanying a particular address or a particular part of an address, than a sustained posture. It occurred at frequent intervals in the ancient liturgy, and is still used in the Roman mass as well as (even more profusely) in those of all the various rites, Greek, Syrian, Coptic, Armenian, and Russian. The prostrate posture was the attitude of the deepest humiliation,

and was mainly used by the Penitents (q. v.), especially in that grade of public penance which was known under the name 'prostration.' It is also used still in the solemn ordination of subdeacons, deacons, and priests, as performed in the Roman Catholic Church. The question as to the use of particular postures was a subject of much controversy between the Puritans and the Church of England; and has recently been revived in the Presbyterian Church of Scotland.

POTASH AND PEARL-ASH, in Commerce. See POTASSIUM. The chief source of this important article in Britain is Canada, where it is derived from the vast quantities of wood cut down and burned in clearing the forest for culture, and also from the branches of the trees felled for timber. The ashes, mixed with a small quantity of quicklime, are put into large wooden cisterns, and covered with water. The whole is well stirred up, and allowed to settle; the next day, the clear liquor is drawn off, and evaporated to dryness in iron pots, whence it is called *potash*. When a sufficient quantity is got to fill a cask of 5 cwt., it is fused at a red heat, and poured into the cask. The mass when cold is coloured gray externally, but when broken, shews a pinkish tint internally. It is very deliquescent, and consequently the casks require to be nearly air-tight. In this state, potash contains a large quantity of foreign materials, amounting to about 40 per cent, amongst which sulphur and carbonaceous matter predominate. This is the crude American potash of commerce. If it is calcined by a reverberatory furnace, the sulphur is driven off, and the carbonaceous matter burned out; the carbonic acid, however, combines with the potash, and forms it into a carbonate. To form it into *pearl-ash*, it is then broken up, and dissolved in water in a wooden cistern, having a perforated bottom, covered with straw, through which it filters, and is afterwards evaporated in flat-bottomed iron pans. As it approaches dryness, it is stirred with iron rods, which break it up into round lumpy masses of a pearly-white colour, and in this state it is the *pearl-ash* of commerce, and contains about 50 per cent of pure potassa. All land-plants yield potash when burned, and many in much greater proportions than the timber-trees of North America; but the circumstances in which the materials are obtained, give an advantage to our colonial manufacturers, which hitherto has enabled them to compete with the whole world. The quantity imported annually of 'pots' and 'pearls,' as they are technically called, reaches the value of nearly half a million sterling. See POTASSIUM.

POTASSIUM (symb. K, equiv. 39, sp. gr. 0.865) is one of the alkaline metals. The letter K is selected as its symbol, as being the first letter of *Kali*, the Arabic word for potash, the letter P being preoccupied as the symbol for phosphorus. The following are the chief characters of this metal. It is of a bluish-white colour, and presents a strong metallic lustre. At 32°, it is brittle, and has a crystalline fracture; at a somewhat higher temperature, it is malleable; at 60°, it is soft, and of the consistence of wax; at 130°, it is completely liquid; and at a red heat, it becomes converted into a beautiful green vapour. Its affinity for oxygen is so great, that on exposure to the air, it immediately becomes covered with a film of oxide. When heated, it burns with a violet flame. Its intense affinity for oxygen is well shewn by throwing it into water, on which, from its low specific gravity, it floats. The metal abstracts oxygen from the water, and forms oxide of potassium (potash); while the liberated

POTASSIUM.

hydrogen carries off a small portion of the volatilised potassium, and taking fire from the heat evolved by the energetic chemical action, burns with a brilliant violet flame. The experiment is a very beautiful one, the burning metal swimming about rapidly on the water, and finally disappearing with an explosion of steam, when the globule of melted potash becomes sufficiently cool to come in contact with the water. At an elevated temperature, this metal removes oxygen from almost all bodies into the constitution of which that element enters; and in the laboratory it is often employed to remove any traces of oxygen from hydrocarbons, by distilling the latter with a small quantity of the metal. From the above facts, it is obvious that potassium must always be kept in some fluid, such as purified rock-oil or naphtha, which contains no oxygen.

Potassium does not occur in the native state, and can only be obtained by the reduction of its oxide, potash. There are three principal modes of reduction, all of which deserve a brief special notice, either on historical grounds or for their practical value.

1. Davy, in 1807, decomposed a fragment of hydrate of potash, by the current of a strong voltaic battery, into potassium, which separated as globules at the negative pole, and oxygen, which was evolved at the positive pole. This mode of procuring potassium yields only very small quantities, and is expensive; but the experiment was a most important one for the progress of chemistry, as shewing for the first time that potash is not, as was previously supposed, a simple body.

2. Stimulated by Davy's discovery, Gay-Lussac and Thenard, in the following year (1808), succeeded in obtaining the metal by purely chemical means in greater abundance, by decomposing potash by means of metallic iron at a white heat. The oxygen of the potash combines with the iron, and the potassium in a gaseous form is condensed in a receiver filled with naphtha, and kept cool.

3. The method now usually adopted consists in the distillation of a mixture of carbonate of potash and charcoal at a white heat, in an iron retort. If proper proportions are taken, the mixture is wholly converted into carbonic oxide and potassium, as is shewn in the equation:

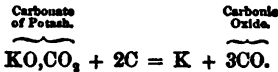

Potassium forms two compounds with oxygen, viz., a protoxide, KO, which constitutes potash, and is strongly basic, and a teroxide, KO<sub>3</sub>, which does not combine with acids, and of which it is unnecessary to say more than that it is a yellowish-brown substance, which is found when the metal is burned in an excess of oxygen gas.

Potash can be procured in the anhydrous form by oxidising thin slices of the metal in air perfectly free from moisture or carbonic acid. It is white, very deliquescent, and caustic. When moistened with water, it becomes incandescent, and the water cannot be expelled by any degree of heat. A far more important substance is the *Hydrate of Potash* or *Caustic Potash* (KO.HO). This is commonly prepared by dissolving carbonate of potash in ten times its weight of water, and gradually adding to the boiling solution a quantity of slaked lime, equal in weight to half the carbonate of potash used. The resulting compounds are carbonate of lime, which falls as a precipitate, and hydrate of potash,

which remains in solution; the changes being expressed by the equation:

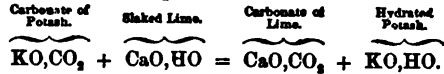

The clear supernatant fluid is removed by decantation, or by means of a syphon, into a clean silver or iron basin, and is rapidly evaporated till it flows tranquilly like oil; it is then either cast into cylinders in metallic moulds, or is poured upon a cold slab, and solidifies on cooling. It may also be obtained in acute rhombohedrons, if allowed to crystallise from a hot concentrated solution; the crystals containing four atoms of water. A solution of hydrate of potash being one of our most important chemical re-agents, it is very essential that it should be obtained pure. When obtained in the method that has been described, it is apt to be contaminated with carbonic, sulphuric, hydrochloric, and silicic acids, lime, alumina, oxides of iron, &c., any of which substances can be detected by the appropriate tests. Pure caustic potash is, however, perfectly soluble in alcohol, which does not dissolve any of the above-named impurities. Hence, by forming an alcoholic solution of potash, and by evaporating it in a silver vessel till the whole of the alcohol is expelled, we obtain this substance in a state of purity. Hydrated potash, on solidifying after fusion, occurs as a hard, grayish-white, opaque body, with a crystalline fracture, which may be readily again fused into a colourless oily fluid, but which only volatilises at a very high temperature. It is soluble in about half its weight either of water or of alcohol, and rapidly absorbs both carbonic acid and moisture from the atmosphere. It acts as a powerful caustic, and quickly destroys both animal and vegetable tissues, and hence its solutions can only be filtered through pounded glass or sand. Its affinities are so powerful that few vessels are capable of resisting its influence. Its solution must be preserved in glass bottles, into the composition of which no oxide of lead enters, as it has the property of dissolving this oxide out of the glass. Vessels containing silica (porcelain, earthenware, &c.) are decomposed, and platinum itself is oxidised when heated in contact with it. The principal uses of this substance are thus briefly summed up by Professor Miller. 'Potash decomposes the fixed oils, and converts them into soluble soaps; when fused with silicious minerals, it displaces the bases, and combines with the silica, forming silicate of potash. Potash is extensively employed in the arts: to the soap-boiler and the glass-maker, it is indispensable; when combined with nitric acid, it enters largely into the manufacture of gunpowder; and, in greater or less quantity, it furnishes important aids to a variety of processes employed in the manufactures of the country. In the laboratory, potash is in constant use for absorbing acid gases, such as carbonic acid, and for separating the metallic oxides from solutions of their salts, since, owing to the powerful affinity of the alkali for acids, it readily decomposes the salts of all the metals which produce oxides insoluble in water.' — *Elements of Chemistry*, 2d edition, vol. ii. p. 353.

The salts which potash forms with acids are for the most part readily soluble in water, and colourless, unless (as, for example, in permanganate of potash) the acid is coloured. Most of them are crystallisable, and they all communicate a violet tint, characteristic of potash, to the flame of spirit of wine and to that of the blowpipe. Many of them occur in the animal and vegetable kingdoms, and the ashes of plants contain them in large quantity. We shall now briefly notice the most



important of these salts. *Carbonate of Potash* ( $\text{K}_2\text{CO}_3$ ) is obtained by burning plants in dry pits, dissolving the ashes in water, evaporating till the sulphates, chlorides, &c., separate in crystals, and then boiling the mother liquor to dryness in iron pots. See POTASH. The quantity of pure carbonate of potash contained in it is liable to great variation, and the process termed *Alkalimetry* has been invented, with the view of rapidly determining the amount of this salt, on which the commercial value of the pearl-ash depends. Different plants furnish varying quantities of this salt, and the leaves and young shoots are the parts which furnish it most abundantly. The potash is, of course, obtained by the plants from the soil, which, when capable of supporting vegetable life, always contains that substance; and does not exist in the plants in the form of carbonate, but in union with various organic acids (such as acetic, malic, tartaric, and other acids), which, by incineration, become decomposed into carbonates. The purified carbonate of potash, employed in pharmacy and for chemical purposes, is prepared from the crude salt by adding an equal quantity of cold water, agitating, and filtering. By this means, all the less soluble foreign bodies are got rid of. The solution is then boiled down to a small bulk, and allowed to cool, when the carbonate separates in small crystals, containing 20 per cent. of water, and represented by the formula  $\text{K}_2\text{CO}_3 + 2\text{Aq}$ . Carbonate of potash is extremely deliquescent, and is soluble in less than its own weight of water, but is insoluble in alcohol. It has an acrid, alkaline taste, and its reaction upon test-paper is strongly alkaline. It is a compound of great importance, both as a chemical re-agent, and as entering largely into the preparation of most of the other compounds of potash, and into the manufacture of soap and glass. *Bicarbonate of Potash* ( $\text{K}_2\text{CO}_3 + \text{H}_2\text{CO}_3$ ) is obtained in white rhombic prisms, by passing a current of carbonic acid gas through a strong solution of carbonate of potash. These crystals are permanent in the air, but are decomposed by heat; water and carbonic acid being evolved, and the simple carbonate left. This salt is much less soluble than the carbonate, requiring four parts of cold water for its solution, which is nearly neutral to test-paper, and has a much milder taste than the preceding salt. It is employed largely in medicine for making effervescing draughts. *Sulphate of Potash* (formerly known as *sal polychrest*) is obtained by dissolving in water the acid residue of bisulphate of potash ( $\text{K}_2\text{SO}_4 + \text{H}_2\text{SO}_4$ ) which is left in the retort in the preparation of nitric acid. This solution, on being neutralised with carbonate of potash, furnishes hard transparent crystals of this salt. From its extreme hardness, this salt is used in medicine (as, for example, in Dover's Powder), for the purpose of finely comminuting vegetable matters. The *Bisulphate of Potash*, from which the preceding salt is obtained, is the *sal entium* of the older chemists. Except that it is occasionally employed as a flux it is of no special importance. *Nitrate of Potash* has been already described under the head NITRE. *Chlorate of Potash* ( $\text{K}_2\text{ClO}_3$ ) occurs in white rhomboidal tablets of a pearly lustre. It has a cooling taste like that of nitre. It fuses at a gentle heat without decomposition, but on increasing the heat, it gradually gives off all its oxygen, and is converted into chloride of potassium, according to the equation:



It is not very soluble, as it requires for its solution 16 parts of cold and 17 parts of boiling water. It even exceeds nitrate of potash as an oxidising

agent; and if combustible substances, such as carbon, sulphur, or phosphorus be heated, or forcibly rubbed with it, a detonation or explosion occurs. This salt is employed in the manufacture of lucifer-matches, in certain operations in calico-printing, and for filling the friction-tubes employed for firing cannon: the best mixture for these tubes consisting of 2 parts of this salt, 2 of sulphide of antimony, and 1 of powdered glass. A mixture known as *White Gunpowder*, consisting of chlorate of potash, dried ferrocyanide of potassium, and sugar, has been employed for blasting purposes, but its preparation is accompanied by so much danger, that it is seldom used. This salt does not occur as a natural product, but may be obtained by passing a current of chlorine gas through a hot solution of caustic potash; 6 eq. of chlorine combining with 6 eq. of potash to form 5 eq. of chloride of potassium, and 1 eq. of chlorate of potash, according to the equation:  $6\text{Cl} + 6(\text{K},\text{H}) = 5\text{KCl} + \text{K},\text{ClO}_3 + 6\text{H}_2\text{O}$ . The two salts are easily separated by crystallisation, as the chlorate is comparatively insoluble, and the chloride extremely soluble. *Hypochlorite of Potash* ( $\text{K},\text{ClO}$ ) can only be obtained in solution. Under the title of *Eau de Javelle*, it is sold as a bleaching agent. It is obtained by passing chlorine gas through a cold dilute solution of carbonate of potash, when chloride of potassium and hypochlorite of potash are formed, from which the chloride may be removed by crystallisation. The *Phosphates of Potash*, formed by the different varieties of phosphoric acid, are sufficiently noticed in the articles PHOSPHATES (in Physiology) and PHOSPHORUS. The *Silicates of Potash* are important compounds in connection with the manufacture of glass; they also enter into the composition of Fuch's *Water-glass*, or *Soluble Glass*, and have been employed by Ransome and others as a coating by which the decay of magnesian and other limestones may be prevented. The *Chromate* and *Bichromate of Potash* are sufficiently noticed in the article CHROMIUM. The haloid salts of potassium may be passed over very briefly. The *Chloride of Potassium* ( $\text{KCl}$ ) is obtained in large quantity in the preparation of chlorate of potash, or may be prepared by burning potassium in chlorine gas, when the result of the brilliant combustion which takes place is this salt. In its general characters, it closely resembles common salt ( $\text{NaCl}$ ), except that the former communicates a violet, and the latter a yellow tint to the flame of alcohol. It is a constituent of sea-water, of salt marshes, and of many animal and vegetable fluids and tissues. The *Bromide* and *Iodide of Potassium* are sufficiently noticed in the articles BROMINE and IODINE. *Fluoride of Potassium* ( $\text{KFl}$ ) possesses the property of corroding glass. There are no less than five *sulphides of potassium*, commencing with the protosulphide ( $\text{KS}$ ), and terminating with the pentasulphide ( $\text{KS}_5$ ). The latter is the main ingredient in the *Hepar sulphuris*, or *Liver of sulphur*, used in medicine. It is a brown substance, obtained by fusing, at a temperature not exceeding  $482^\circ$ , 3 eq. of potash and 12 eq. of sulphur, the resulting compounds being 2 eq. of pentasulphide of potassium ( $2\text{KS}_5$ ), and 1 eq. of hyposulphite of potash ( $\text{K},\text{S}_2\text{O}_3$ ). From this mixture, the pentasulphide may be removed by alcohol, in which it dissolves. The *Yellow* and the *Red Prussiate* (or the *Ferrocyanide* and *Ferridcyanide*) of Potash are noticed in the articles FERROCYANOGEN and FERRIDCYANOGEN. The *Cyanide of Potassium* ( $\text{KCyan}$ ) may be prepared by heating potassium in cyanogen gas, when brilliant combustion occurs, and the resulting product is this salt. It may, however, be more cheaply and easily prepared by Liebig's process, which does not, however, yield it pure, but mixed with cyanate of

## POTASSIUM.

potash—an impurity which is of no consequence for most of the applications of cyanide of potassium, as, for example, electro-plating and gilding. Eight parts of anhydrous ferrocyanide of potassium are mixed with three parts of dry carbonate of potash; the mixture is thrown into a red-hot earthen crucible, and kept in fusion till carbonic acid gas ceases to be developed, and the fluid portion of the mass becomes colourless. After a few moments' rest, the clear fused salt is decanted from the heavy black sediment, which consists chiefly of metallic iron in a state of minute division. It has recently been derived from an unexpected source. In some of the iron furnaces where raw coal is used for fuel in the hot-blast, a saline-looking substance is sometimes observed to issue in a fused state from the tuyere-holes of the furnace, and to congregate on the outside. Dr Clark of Aberdeen has shewn that this substance is mainly cyanide of potassium. This salt forms colourless deliquescent crystals very soluble in water. It exhales an odour of hydrocyanic acid, and is said to be as poisonous as that acid. Its great deoxidising power at a high temperature renders it a valuable agent in many of the finer operations of metallurgy.

The following are the ordinary tests for the potassium compounds: 1. Solution of tartaric acid added in excess to a moderately strong solution of a potassium salt, gives after some time a white crystalline precipitate of cream of tartar. See TARTARIC ACID. The result is hastened by stirring or shaking. 2. Solution of bichloride of platinum gives a crystalline yellow precipitate, which is a double salt of bichloride of platinum and chloride of potassium. If not previously acid, the mixture to be tested should be acidulated with hydrochloric acid. See PLATINUM. 3. The violet tint occurring in the presence of potassium in the outer flame of the blowpipe, or in the flame of spirit, has been already noticed. 4. The spectrum of a flame containing potassium exhibits a characteristic bright line at the extreme limit of the red, and another one at the opposite violet limit of the spectrum. See SPECTRUM ANALYSIS.

The British Pharmacopœia contains the following preparations of this metal. *Caustic Potash*, or *Hydrate of Potash* ( $\text{KO},\text{HO}$ ), which occurs in hard white pencils. From its being fused before being poured into the moulds which give it the form of pencils, it is often termed *Potassa fusa*. From its power of dissolving the animal tissues, it is sometimes used as a caustic, although its great deliquescence renders it somewhat difficult to localise its action to the desired spot. In bites of venomous serpents, mad dogs, &c., it may be applied with advantage, and it is useful in destroying warts and fungoid growths of various kinds. It can be employed with greater safety than the lancet in opening certain abscesses, especially those of the liver. *Solution of Potash*, commonly known as *Liquor potassæ*, is obtained by the process already given for the preparation of hydrate of potash—namely, by the action of slaked lime on a boiling solution of carbonate of potash. Its sp. gr. is 1.058, and hence the solution is somewhat weaker than that of the London Pharmacopœia, whose sp. gr. is 1.063, and which, according to the experiments of Mr Phillips, contains 6.7 grains of potash in 100 grains of the solution. 'One fluid ounce requires, for neutralisation, 48.25 measures of the volumetric solution of oxalic acid.' *Liquor potassæ*, in combination with a tonic infusion, is of service in cases of dyspepsia which are accompanied with excessive acidity of the stomach, such, for example, as often occur in habitual spirit-drinkers. It is also frequently given with the view of rendering

the urine alkaline, or of diminishing its acidity in cases in which that secretion is too acid. In chronic skin-diseases, especially those of a scaly nature, it often gives relief, if given in full doses, and for a sufficient time; and in chronic bronchitis it is given with advantage for the purpose of diminishing the viscosity of the bronchial mucus. The usual dose is ten drops, gradually increased to as much as a fluid drachm. Infusion of orange peel and table-beer are fluids which conceal its unpleasant taste. Veal-broth has also been recommended as a medicine in which to present it. Its too prolonged use renders the urine alkaline and sedimentary (from the deposit of phosphate of lime), and tends to impoverish the blood. *Sulphurated Potash*, or *Potassa sulphurata*—which is the new name for the sulphuret of potassium, or liver of sulphur (*Hepar sulphuris*)—is obtained by fusing together carbonate of potash and sublimed sulphur. It occurs in solid greenish masses, which are liver-brown when recently broken. It is alkaline and acrid to the taste, readily forming with water a yellow solution, which has the odour of sulphuretted hydrogen, and evolving that gas freely, on the addition of an excess of hydrochloric acid. It is sometimes given internally in doses of three grains (in the form of a pill made with soap), in obstinate skin-diseases, but is chiefly used as a lotion, bath, or ointment for these diseases. It must be recollected that this compound is an energetic narcotico-acrid poison, its action being very like that of sulphuretted hydrogen. *Acetate of Potash* ( $\text{KO},\text{C}_2\text{H}_3\text{O}_2$ ) is obtained by the action of acetic acid on carbonate of potash, and occurs in white foliaceous satiny masses. In its passage through the system, it is converted into carbonate, and thus renders the urine alkaline. In small doses, as from a scruple to a drachm, it acts as a diuretic, and is of service in some forms of dropsy. Combined with other potass-salts, it is much given in acute rheumatism. *Carbonate of Potash* ( $\text{KO},\text{CO}_2 + 2\text{Aq}$ ) is employed in medicine in the same cases as those in which solution of potash is used. In large doses, it acts, like caustic potash, as an irritant poison. It is frequently employed in the preparation of effervescing draughts, 20 grains of this salt being neutralised by 17 grains of citric acid, or 18 grains of tartaric acid, or by half a fluid ounce of lemon-juice. *Bicarbonate of Potash* ( $\text{KO},\text{HO},2\text{CO}_2$ ) may be used in the same cases as the carbonate or solution of potash. It is chiefly used for the manufacture of effervescing draughts, 20 grains of the crystallised salt being neutralised by 14 of citric acid, 15 of tartaric acid, and  $3\frac{1}{2}$  drachms of lemon-juice. *Chlorate of Potash* ( $\text{KO},\text{ClO}_3$ ) is prescribed with advantage in diseases of a low type, such as scarlatina maligna, cancrum oris, diphtheria, scurvy, &c. As it is eliminated unchanged by the kidneys, its *modus operandi* is unknown. It may be prescribed in doses of from ten to twenty grains three times a day in solution. *Citrate of Potash* ( $3\text{KO},\text{C}_2\text{H}_3\text{O}_7$ ) is obtained by neutralising a solution of citric acid with carbonate of potash, filtering, and evaporating to dryness, when the salt is deposited as a white powder of a saline, feebly acid taste, deliquescent, and very soluble in water. It is procured *extempore* in a state of solution in the effervescing draughts for which we have given prescriptions in our remarks on the carbonates of potash. It acts mildly on the skin, bowels, and kidneys, whose secretions it promotes, and is an excellent cooling diaphoretic in fevers with a hot and dry skin, being less liable to act on the bowels than the tartrate or acetate of potash. In irritability of the stomach, it is an excellent remedy, when given as an effervescing

## POTATO.

draught. It may be taken in doses of a scruple or half a drachm in solution every few hours. The therapeutic uses of *nitrate of potash* are noticed in the article NITRE. *Sulphate of potash* ( $\text{K}_2\text{O}, \text{SO}_4$ ) is useful as a mild laxative, a scruple of this salt, especially if combined with ten grains of rhubarb, usually acting mildly and efficiently. It has considerable power in repressing the secretion of milk, and has been much used for this purpose. The reason why it is an ingredient of Dover's Powder, has been already noticed.

The uses of the *tartrates of potash* are noticed in the article TARTARIC ACID. *Bromide of Potassium* (KBr) occurs in white, transparent, cubical crystals, and is occasionally employed in enlargement of the spleen and in certain forms of epilepsy. The uses of *iodide of potassium* are described in the article IODINE.

POTATO (*Solanum tuberosum*; see SOLANUM), one of the most important of cultivated plants, and in universal cultivation in the temperate parts of the globe. It is a perennial, having herbaceous stems, 1—3 feet high, without thorns or prickles; pinnate leaves with two or more pair of leaflets and an odd one, the leaflets entire at the margin; flowers about an inch or an inch and a half in breadth, the wheel-shaped corolla being white or purple, and more or less veined; followed by globular, purplish fruit, of the size of ordinary gooseberries; the roots producing tubers. The herbage has a slightly narcotic smell, although cattle do not refuse to eat a little of it, and the tender tops are used in some countries like spinach. The tubers are, however, the only valuable part of the plant.

The P. is a native of mountainous districts of tropical and subtropical America, probably from Chili to Mexico; but there is difficulty in deciding where it is really indigenous, and where it has spread after being introduced by man. Humboldt doubted if it had ever been found truly wild; but subsequent travellers, of high scientific reputation, express themselves thoroughly satisfied on this point. Except that the tubers are smaller, the wild plant differs little from the cultivated. Maize and the P. are the two greatest gifts which America has given to the rest of the world. The P. has been cultivated in America, and its tubers used for food, from times long anterior to the discovery of America by Europeans. It seems to have been first brought to Europe by the Spaniards, from the neighbourhood of Quito, in the beginning of the 16th c., and spread from Spain into the Netherlands, Burgundy, and Italy, but only to be cultivated in a few gardens as a curiosity, and not for general use as an article of food. It long received throughout almost all European countries the same name with the Batatas (q. v.), or Sweet Potato, which is the plant or tuber meant by English writers down to the middle of the 17th c., in their use of the name potato. It appears to have been brought to Ireland from Virginia by Hawkins, a slave-trader, in 1565; and to England by Sir Francis Drake, in 1585, without attracting much notice, till it was a third time imported from America by Sir Walter Raleigh in 1623. It was still a long time before it began to be extensively cultivated. Gerard, in his *Herball*, published in 1597, gives a figure of it under the name of *Batata Virginiana*; but so little were its merits appreciated, that it is not even mentioned in the *Complete Gardener* of London and Wise, published more than a century later, in 1719; whilst another writer of the same time says it is inferior to skirret and radish! It began, however, to be imagined that it might be used with advantage for feeding 'swine or other cattle,' and by and by that it might be useful for poor people, and for

the prevention of famine on failures of the grain-crops. The Royal Society took up this idea, and in 1663, adopted measures for extending the cultivation of the P., in order to the prevention of famine. To this the example of Ireland in some measure led, the P. having already come into cultivation there, to an extent far greater than in any other European country, and with evident advantage to the people. From Ireland, the cultivation of the P. was introduced into Lancashire about the end of the 17th c., soon became general there, and thence spread over England; so that, before the middle of the 18th c., it had become important as a field-crop, which it became in the south of Scotland some 20 or 30 years later; about the same time, in Saxony and some other parts of Germany; but not until the latter part of the century, in some other parts of Germany and in France. In France, the extension of P. culture was very much due to the exertions of Parmentier. In some parts of Germany, the governments took an interest in it, and promoted it by compulsory regulations.

The P. is of great importance as affording food both for human beings and for cattle; and next to the principal cereals, is the most valuable of all plants for human food. It is also used for various purposes in the arts. No food-plant is more widely diffused; it is cultivated in subtropical countries; and struggles for existence in gardens, even within the arctic circle, yielding small and watery tubers; although the effects of late spring frosts, or early autumnal frosts, upon its foliage, often prove that it is a plant properly belonging to a climate milder than that of most parts of Britain. No more important event of its kind has ever taken place than the general introduction of P. culture into the husbandry of Britain and other European countries. It has exercised a most beneficial influence on the general welfare of the people, increasing national wealth, and preventing, as a few far-seeing thinkers had anticipated, the once-frequent returns of famine. That in 1846 and 1847, terrible famine resulted in Ireland and elsewhere from the failure of the P. crop itself, was owing only to the excess to which its cultivation had been carried. The results confirmed two great laws, that plants long very extensively or almost exclusively cultivated in any district, however successfully they may be cultivated for a time, are sure to fail at last; and that the exclusive, or almost exclusive dependence of a people on one source or means of support, is unfavourable to their welfare in respect to all their interests.

Humboldt calculates that the same extent of ground which would produce thirty pounds of wheat, would produce one thousand pounds of potatoes. But potatoes are not nearly so nutritious as wheat, and the constant employment of them as the chief article of food, is not favourable to the development of the physical powers, and is consequently in its protracted influence unfavourable to mental energy. All this is too well illustrated in Ireland and the Highlands of Scotland, in a race capable of the highest development of both. It is calculated that 100 parts of good wheat-flour, or 107 parts of the grain, contain as much actual nutriment as 613 parts of potatoes. The inferiority of the P. in nutritious power is very much owing to the comparatively small quantity of nitrogenous substances which it contains, in consequence of which it is most advantageously used along with some very nitrogenous article of food, in Britain generally with animal food, in some parts of Europe with curds or with cheese. The P. tuber, in a fresh state, contains about 71—80 per cent. of water; 15—20 of starch, 3—7 of fibre or woody matter, 3—4 of gum,

## POTATO.

dextrine, and sugar, and 2 of albumen, gluten, and casein. There are considerable differences, however, in different varieties, in different stages of maturity, and in different soils and seasons.

Potatoes are used, both raw and boiled, for the feeding of cattle. For human food, they are variously prepared by roasting or boiling, but now chiefly by boiling, a process by which they are freed from all that is narcotic and noxious in their juice. The water in which potatoes have been boiled is not wholesome, and those modes of preparing them for the table which do not admit of its complete rejection, ought to be avoided.

The herbage or haulm of the P. has been used for making paper, but the results were not encouraging. The berries are sweetish, but not pleasant; nauseous when fermented, but yield by distillation a tolerable spirit.

The varieties of the P. in cultivation are extremely numerous. Any enumeration or classification of them is impossible. New ones are continually appearing, and old ones passing away. Those most advantageously cultivated in particular soils and climates, are often found to degenerate when removed to a small distance. Many of the new varieties of P. are raised in Lancashire, but particularly of the garden kinds, which generally differ from those preferred for field-culture in their greater earliness, and not unfrequently in their inferior productiveness, and in their being less *mealy* and less nutritious. Potatoes differ considerably in the character of their herbage—which is sometimes erect, sometimes straggling—and in the size and colour of their flowers; but are more generally distinguished by the size, form, and colour of their tubers, which are round, long, or kidney-shaped, white, red, dark purple, variegated, &c.

New varieties of P. are produced from seed; but potatoes are ordinarily propagated by planting the tubers, or cuttings of the tubers, each containing an eye or bud. Late crops of early potatoes are sometimes procured by cuttings of the stalks or by layers; methods which might probably be pursued with more advantage where the summer is longer than in Britain. Much has been written by gardeners and agriculturists on the comparative advantages of planting whole tubers or cuttings; but the latter method generally prevails.

Potatoes are planted in drills, made either by the spade or plough; or in *lazy beds*, which are always made by the spade, and are beds in which the sets of potatoes are covered over with earth dug out of the alleys. The alleys serve, although imperfectly, for drains in undrained land. The cultivation of potatoes as a field-crop seems to have been first attempted in lazy beds. They are still common in many parts of Ireland, but are now rare in most parts of England and Scotland. They are very suitable for strong, heavy, and somewhat moist land, and are profitably used in reducing some kinds of soil to cultivation, but are generally unsuitable for field-culture, owing to the expense of labour required. In strong heavy land, potatoes are cultivated in raised drills; in lighter and drier soils, the raising of the drills is unnecessary. Manure is generally given, consisting generally of dung and well-rotted straw from the farm-yard. Guano and other strong artificial manures are apt to produce an excessive growth of stalks and leaves, which is to be guarded against by diminishing or even withholding manure in certain soils; potatoes of too luxuriant growth being always particularly liable to diseases. The cultivation of potatoes, after they are planted, whether in the field or garden, consists chiefly in keeping the ground clear of weeds, and in earthing up the plants, to promote the formation of

tubers. Potatoes are taken up either by the fork or by turning over the drills with the plough. Garden potatoes are generally used long before they are really ripe, forming a favourite dish in a very unripe state, when they are far from being a safe article of food, and contribute not a little to the prevalence of cholera and kindred diseases in summer. Field potatoes, unless when intended for the supply of the markets of towns, like garden potatoes, are allowed to ripen thoroughly, and are then capable of being stored for winter and spring use. Early potatoes are forced in hot-beds, and in the spare ground of hothouses, that they may be obtained very early; also, after being thus brought forward in some degree, they are planted out in gardens, for a succession of young tubers. The planting of potatoes in the open air cannot be successfully practised in most parts of Britain before February or March, and in many seasons the later-planted are found as early as the earlier-planted, and more productive. The storing of potatoes is variously accomplished in dry lofts or sheds, in airy cellars or barns, and in *pits*, which are sometimes holes excavated to a small depth in the earth, and the potatoes piled up above the surface of the ground, in a conical, or in a roof-like form, sometimes mere heaps of one or other of these forms upon the surface of the ground, and covered with straw and earth to keep out light and frost. The access of light makes potatoes green, bitter, and unwholesome, as is often seen in those which, whilst growing, have been partially above ground. P. pits are often ventilated by means of pipes, as without ventilation the potatoes are apt to heat and sprout. Potatoes taken from the ground before they are quite ripe are extremely apt to heat and sprout.

The P. crop is now an important one in almost all the rotations practised in Britain, although its cultivation is in most districts not quite so extensive as before its failure from the *P. disease* in 1845 and subsequent years, and farmers are more careful not to depend too much upon it. It very commonly succeeds a grain-crop, but sometimes is advantageously planted on land newly broken up from grass.

The P. is subject to a number of diseases, of which the most important is the *P. Disease* (q. v.) or P. Murrain. Before it began to prevail, the chief diseases affecting the P. were those called *Curl*, *Scab*, *Dry Rot*, and *Wet Rot*. Of all these diseases, it would seem that one principal cause, however combined with other causes, is the exhaustion of the vegetative powers of the plant, from frequent propagation by tubers or cuttings of tubers. It is to be borne in mind that propagation by tubers is not properly reproduction, but one plant is divided into a multitude; and the whole analogy of nature seems to shew, that although it may live longer in this way and more healthfully than if left to the spot where its seed first germinated, its existence will come to an end, and the species must be preserved by reproduction from seed. It was long since observed as to *CURL*, the dread of farmers and gardeners before the *P. disease* was known, that it most readily attacks potatoes which sprung from weak sets. *Curl* is a disease affecting the foliage and general health of the P. plant, and does not seem to be necessarily connected with the presence of any vegetable parasite or insect enemy.—*SCAB* is a disease of the tubers, which become covered with brown, oblong, and finally confluent and cup-shaped spots, whilst under the surface is a powdering of minute olive-yellow grains, a fungus called *Tuber-cinia Scabies*, of the division *Hypophomycetes*.—*DRY ROT* is also ascribed to the growth of a fungus of

## POTATO-DISEASE—POTATO-FLY.

the same order, *Fusisporium Solani*, and attacks the tubers either when stored for winter or after being planted. It was very carefully investigated by Martius, and described in a memoir published in 1842. It was first observed in Germany in 1830, and caused great loss in that country throughout many years. The tissues of the P. tuber become hardened and completely filled with the mycelium of the fungus, which at last bursts forth in little cushion-shaped tufts loaded with fructification.—WET ROT differs from Dry Rot in the tubers becoming soft and rotten instead of hard and dry, and is always characterised by the presence of a fungus referred by Fries to his genus *Periola*, but which Berkeley regards as another form or stage of the same fungus which causes or is inseparably connected with Dry Rot. Both Dry Rot and Wet Rot have often been observed along with the P. disease, which, however, is always characterised by the presence of another peculiar fungus.

But, besides its value as a culinary vegetable, the P. is important in other respects. Its starch is very easily separated, and is in large proportions; hence it is cheaper than any other kind. It is manufactured on a very large scale both in this country and on the continent. It is chiefly used in textile manufactories under the name of *farina*, which is converted into dextrine or British gum. See STARCH. In Holland and in Russia, where there is much difficulty in keeping potatoes through the winter, and there is consequently a necessity for using the crop quickly, large quantities of starch are made, and this is converted into sugar or syrup. See SUGAR. The refuse of the starch-manufactories is all economised; it is pressed out from the water, and either used for pig-feeding or for manure. In the north of Europe, much spirit for drinking is made from potatoes; it is called Potato Brandy.

**POTATO DISEASE, or POTATO MURRAIN.** No subject connected with Agriculture or with Botany has given rise within so short a time to so extensive a literature as this. It has been treated in books and pamphlets, and in magazines and periodicals of every kind. The terrible famines caused by the failure of the potato crop in Ireland and other countries, particularly in 1846 and 1847, concentrated upon it the attention of the whole civilised world; and yet it remains very obscure.

The potato disease seems to have been at first confounded with Dry Rot and Wet Rot (see POTATO), which appeared a number of years before it to a formidable extent, although not to be compared with it in their ravages. This fact—and all the more if the potato disease is to be ascribed to the presence of a different and peculiar fungus—may perhaps be held as giving support to the opinion that its chief cause was really the weakening of the plant through too constant cultivation on the same land, and continued propagation by tubers alone.

The potato disease was first observed in Germany, and first assumed a very serious character near Liège in 1842. In 1844 it broke out in Canada, and all at once proved very destructive. In 1845, it was first noticed in England, and first in the Isle of Wight. But during that year, its ravages were considerable in the British Islands; much more so in the year following, when the Irish famine was the consequence, and in the same year it prevailed very extensively over almost all parts of Europe. The summer was unusually cloudy and moist, a circumstance probably not without its effect. In 1847, the disease was still prevalent, but to a smaller extent; and since that time its prevalence has gradually diminished, although it occasionally breaks out in particular localities. Meanwhile, it is to

be observed, that almost all the varieties of potato cultivated to any considerable extent before 1846, have disappeared, and been replaced by others. Less too much, however, should be inferred from this in favour of a particular theory, it must also be stated, that potatoes newly raised from seed were sometimes severely attacked by the disease during the period of its greatest prevalence.

No fully satisfactory theory as to its cause or origin has been proposed. That it has long existed in the western parts of America, may probably be true, as has been alleged, although the distinction between it and other diseases of the potato might not perhaps be noted with sufficient care; but even this would not account for its sudden appearance and terrible devastations in other parts of the world. Many observers ascribed it to insects and acari, some even to infusoria in the tissues, but the presence of none of these was found to be constant, and they appeared therefore rather to be the consequences than the cause of the disease. It is otherwise with the fungus, *Botrytis infestans* (see BOTRYTIS), which is always present, although probably, like other parasites, it generally attacks an already weakened plant. The disease generally first appears in the leaves, and thence extends to the tubers, although it has been sometimes observed to appear in the tubers of some of the early kinds of which the leaves have perished before the season when it breaks out. It sometimes also lies dormant in the tubers for months, so that after being stored apparently sound in autumn, they become diseased in the following spring. When the disease appears in the growing plant, brown spots are first to be noticed on the margins of the leaves, corrugating the leaves as they spread. Very rapid extension of the disease, and decay of the leaves and stalks, often ensue. It is on the under surface of the leaf that the *Botrytis* is found; it abounds also in the diseased tubers, which, when cut, produce an abundant crop of it from the fresh surface, and it sometimes vegetates even from the natural surface. The same fungus has been found in the berries of the Tomato (q. v.) when diseased, and on the leaves of other plants of the natural order *Solanaceæ*, but never on any plant not of that order.

The starch granules which exist within the cells of potatoes seem not to be affected by the potato disease, but remain unaltered in quality, so that as good potato starch is made from unsound as from sound tubers. On occasion of the great ravages of the disease in 1846, however, advantage was but partially taken of this fact, partly from ignorance of it; partly from an apprehension, apparently quite unfounded, that the starch might prove unwholesome; and partly from the want of machinery to grate down the diseased potatoes before rotteness had involved the whole.

**POTATO-FLY** (*Anthomyia tuber-osa*), a dipterous insect of the same genus with the Beet-fly, Cabbage-fly, Turnip-fly, &c.

In its perfect state, it is very like the House-fly. The male is about five lines long, grayish-black, bristly, with

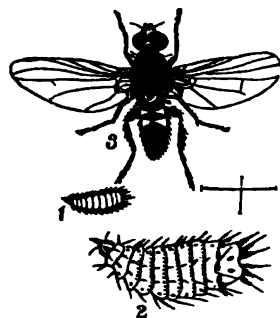

Potato-fly:

- 1, Larva or maggot, natural size;  
2, larva magnified; 3, Potato-fly.

five indistinct broad stripes on the back, and four ochreous spots on the second and third segments; the female ashy-slate colour, with two indistinct ochreous spots on the second abdominal segment. The maggots are very abundant in bad potatoes in autumn, and are very different from the maggots of the House-fly, being horny, spiny, bristly, and tawny; the long tail ending in six long bristles. The pupa is very like the larva.

**POTCHINKY**, a district town of European Russia, in the government of Nijni-Novgorod, 110 miles south-south-east of the city of that name, and 800 miles south-east from St Petersburg. It is one of the centres of the corn-trade of the country, and exports potash. Pop. 7554.

**POTEMKIN**,\* **GREGORY ALEXANDROVITCH**, the most celebrated of the Czarina Catharine II.'s favourites, was born near Smolensk in September 1736. He was descended of a noble Polish family, and at an early age entered the Russian army, and rose to be ensign in the imperial horse-guards. Happening to attract the notice of the czarina by his noble appearance and handsome athletic figure, he was forthwith (1762) attached to her household, and appointed colonel and gentleman of the bed-chamber. After a time (1774), he superseded Gregory Orlov (q. v.) in the good graces of the czarina, and became her favourite and avowed lover. He played the part of lover for only two years, when he was superseded by a younger and more amiable successor; but the ascendancy which he had acquired over the czarina was in nowise affected by this change. He knew well how to flatter her vanity, rouse her fears, and make her believe that he alone could protect her from the numerous conspiracies (some of which were real, and many mythical) which were being constantly formed against her. Catharine submitted to all his caprices, consulted him in everything, and was in almost all cases guided by his advice. P. was consequently, from 1770 till the year of his death, the true representative of the Russian policy in Europe; and Frederick the Great of Prussia, and even the haughty Hapsburgs, Maria Theresa and Joseph II., cringed at his feet, and, at the demand of the czarina, loaded him with titles and honours; though, much to his chagrin, he failed to obtain the English order of the Garter, and the French one of the Holy Spirit. P. interfered little with the internal government of Russia, beyond offering many valuable suggestions for the development of manufactures and industry, which were carried out; his important achievements being connected with the foreign policy of Russia, especially as far as it related to Turkey. It was at his instigation that the Turks were forced into war, and robbed of their territories north and east of the Black Sea, in order that Russia might possess a southern sea-board; and after this had been done, P. immediately ordered the creation of a Black Sea fleet, and the building of Kherson, Kertch, Nikolaiev, and Sebastopol. For his services, he was created governor of the Taurida (q. v.), and loaded with numerous honours and presents. In 1787, Catharine paid a visit to him at his government, and the 'hoax' which he played off on his sovereign is well described by De Segur. He caused an immense number of wooden painted houses to be constructed, and grouped into towns and villages along the route the czarina was to take, and hired people to act the part of villagers, merchants, tradesmen, and agriculturists, engaged in their various pursuits. The czarina's vanity was hugely gratified at the seeming

improvements of the country under her rule, and P. was rewarded for his dexterity by further honours and emoluments. Almost immediately after this, a war broke out with the Turks, and P. was placed at the head of the army, with Suwarof and Reppin for his lieutenants. His career was one of uninterrupted victory. Bessarabia and the two principalities were conquered, and he was about to advance on Constantinople, when the empress commanded a cessation of hostilities; but before P. had time to bring her round to his own views, he was seized with sudden illness on the road between Jassy and Nikolaiev, and died there, October 15, 1791.

**POTENT**, Cross, in Heraldry, a cross crutch-shaped at each extremity. It is also called a Jerusalem cross, from its occurrence in the insignia of the Christian kingdom of Jerusalem, which are, Argent a cross potent between four crosslets or. This coat is remarkable as being a departure from the usual heraldic rule which prohibits the placing of metal upon metal.

**POTENT COUNTER-POTENT**, one of the heraldic furs, in which the field is filled with crutch-shaped figures alternately of metal and colour, those of opposite tinctures being placed base against base, and point against point. The metal and colour are understood to be argent and azure, unless they be specially blazoned otherwise. Potent counter-potent is sometimes blazoned Vairy-cuppy.

**POTENTÉE**, a heraldic line of division which takes the form of the outline of a succession of crutch-shaped figures.

**POTENTILLA**, a genus of plants of the natural order *Rosacea*, suborder *Potentilleae*, differing from *Fragaria* (Strawberry) in the fruit having a dry instead of a succulent receptacle. The species are very numerous, natives chiefly of northern temperate regions, and some of them of the coldest north; most of them perennial herbaceous plants, with yellow, white, red, or purple flowers, and pinnate, digitate, or ternate leaves. They are often called **CINQUEFOIL** (Fr. five-leaved); and some of the species are favourite garden flowers. A few are natives of Britain; one of the rarest of which is a shrubby species (*P. fruticosa*), forming a large bush, with pinnate leaves, and a profusion of yellow flowers, often planted in shrubberies. *P. reptans*, a common British species, with creeping stems, digitate leaves, and yellow flowers, once had a high reputation as a remedy for diarrhoea, from the astringent property of its root, of which most of the species partake with it. But *P. anserina*, a very common British species, popularly known as **SILVERWEED**, having creeping stems, yellow flowers, and pinnate leaves, which are beautifully silky and silvery beneath, has an edible root, with a taste somewhat like that of the parsnip. Swine grub it up with avidity, and it was once much esteemed as an article of food in some parts of Scotland, particularly in the Hebrides,

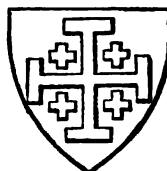

Potent.



Potent Counter-Potent.

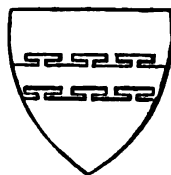

Potentée

\* The name is pronounced *Potimkin* by Russians.

where it abounds and has been a resource in times of famine.—The name P. is said to be derived from the Latin *potens*, powerful, and to allude to medicinal virtues now known to merit little regard. Tormentil (q. v.) is sometimes referred to this genus.

POTENZA (anc. *Potentia*), in South Italy, the chief town of the province of Basilicata, is situated on a hill of the Apennines, near the river Vaseute or Basento, 54 miles east of Salerno. Pop. 12,789. It is surrounded by a wall, has a fine cathedral of the Doric order, and is the seat of an archbishop. P. was shaken by earthquakes in 1273, 1694, and 1812. The province of Basilicata is that which suffers most from brigandage, because of the hills and woods which surround it.

POT-HERBS are not, as might be supposed from the name, the vegetables chiefly used for culinary purposes as supplying articles of food, but rather those which are of secondary importance, and valuable chiefly for flavouring, as parsley, fennel, &c.

POT-METAL is an alloy of lead and copper, obtained by throwing lumps of copper into red-hot melted lead. It is of a gray colour, brittle and granular.

POTO'MAC, a river of the United States, formed by two branches, which rise in the Alleghany Mountains, and unite 20 miles south-east of Cumberland, Maryland, from which point the river flows in a generally south-easterly course, 400 miles, and falls into Chesapeake Bay, where it is 6 to 8 miles broad, 75 miles from the ocean. Line-of-battle ships ascend to Washington, 120 miles from its mouth, and the tide reaches Georgetown. Between Westport and Washington, 220 miles, it falls 1160 feet. The scenery in this portion of its course is wild and beautiful, especially where it breaks through the Blue Ridge at Harper's Ferry. Its principal affluents are the Shenandoah, Savage, Monacacy, and Acquia Creek. The P. forms the greater part of the boundary between Virginia and Maryland. During the war which began in 1861, both Federal and Confederate armies crossed several times the fords of the Upper Potomac, and severe actions were fought upon its banks.

PO'TOROO, or KANGAROO RAT (*Hypsiprinus*), a genus of marsupial quadrupeds, of the family *Macropidae* (see KANGAROO), differing from kangaroos chiefly in having distinct canine teeth in the upper jaw. The first pair of incisors in the upper jaw are also longer and larger than the others. The molars decrease in size backwards; and when not worn, present four blunt tubercles. The forelimbs are proportionally longer, the hinderlimbs less powerful than in the kangaroos. The general form and habits are similar; there is the same sitting on the hind-feet with help of the tail for support, and a somewhat similar hopping, but not nearly an equal power of vigorous leaping. The stomach is large, and divided into two sacs, with several inflations; the food entirely vegetable. There are several species, all of small size, none of them larger than a rabbit, and all natives of Australia, timid and harmless creatures. They are generally clothed with a dense, and sometimes a beautiful fur; but the tail is nearly destitute of hairs, and scaly.

POTO'SI, one of the richest mining-towns of South America, the second town of Bolivia, and capital of a department of the same name, stands in a dreary and barren district, 13,330 feet above sea-level, in lat. 19° 35' S., and long. 65° 25' W., 70 miles south-west of Chuquisaca. It covers a large area, and in 1611, its population was 170,000, but

in 1858, it had fallen to 22,850, and great part of the town was in ruins. In its centre is a large square, around which are ranged the principal public edifices, as the government-house, town-house, cathedral, &c. The mint is a large building, in which the average amount now coined amounts to about 2,000,000 dollars annually. In the central square, an obelisk in honour of Bolivar was erected in 1825. English and French manufactures are imported; and as the country in the vicinity produces little or nothing, all supplies have to be brought from a distance. The Cerro (sierra) de Potosi, or Silver Mountain, is 15,200 feet high. Its summit is honey-combed with upwards of 5000 mines, and operations are now carried on at a lower level, where the influx of water, however, often compels the miners to abandon the richest mines. Up to the year 1846, the quantity of silver extracted from the mines of this mountain amounted to £330,544,311.—Bollaert's *Antiquities of South America*.

POT-POURRI, in French, the name of a mixture of sweet scented materials, chiefly flowers, dried, and usually placed in a vase with a perforated lid, in order that their perfume may be diffused through rooms in which it is placed. The principal ingredients are rose-petals, lavender flowers and stalks, violets, jessamine flowers, woodruff leaves, clove, orris-root, pimento, musk, sandal-wood rasping, cedar-shavings, &c. But it also signifies a dish of different sorts of viands, and corresponds, in this sense to the *hotch-potch* of Scotland, and the *Olla Podrida* (q. v.) of Spain.

POT-POURRI, in Music, a selection of favourite pieces strung together without much arrangement, so as to form a sort of medley.

POTSDAM, the capital of the Prussian province of Brandenburg, and next to Berlin, the handsomest and best built town in Prussia, is situated on an island at the point of junction between the small stream of the Nuthe and the river Havel, 16 miles south-west of Berlin. Population at the close of 1861, 34,869, with 6955 military. P. is divided into the Old and New Town, and is surrounded by ramparts with nine gates, from which seven bridges over the Havel and the canal lead to the suburbs. The streets are broad and regularly built, and there are fine squares, some of which are planted with trees, forming pleasant public walks. Of the many large and handsome buildings, one of the most worthy of notice is the old royal palace, an oblong parallelogram, three stories high, with a magnificent colonnade facing the fine Havel Bridge. P. has several benevolent and educational institutions connected with the state, as, for instance, two asylums for the orphan children of military men, and one for those of persons belonging to the civil service; schools for cadets, subalterns, and privates; the Luisendenkmal, an institution for providing for indigent girls of irreproachable character; a gymnasium, a high-school, and various other training and special schools. Among the churches, the most noteworthy are the Garnisonskirche, with a tower 400 feet high, a fine chime of bells, and a noble marble pulpit, below which rest the remains of Friedrich-Wilhelm I. and Friedrich II., and St Nicolai's, lately rebuilt after the model of the Pantheon at Paris. The Brandenburger-Thor, which is the handsomest of the various gates, is a triumphal arch copied from Trajan's Arch at Rome; and this, like the other gates, opens upon a fine allée of trees. P. is surrounded with pleasant public walks and gardens, wooded heights, and vine-covered banks; while in the immediate neighbourhood are numerous

royal country palaces, as Sans-Souci, the favourite residence of Frederick the Great, surrounded by a fine park, pleasure-grounds, and choicely-stocked gardens, near which stands the Ruinenberg, with artificially constructed ruins, designed to conceal the water-works which supply the fountains of the palace. Near the park is the New Palace, begun in 1763, 680 feet in length, containing nearly 100 rooms, many of which are filled with costly works of art. Near Sans-Souci is Charlottenhof, built by the late king, a pleasant villa, with lovely gardens, in which stands a Pompeian house. The Russian colony of Alexandrowka, with its Russian houses and Greek church, lies near the Pfingstberg, which is surmounted with an unfinished palace, from whence a fine view is obtained of the numerous royal parks and gardens, and the surrounding country. In the New Garden stands the Marble Palace, with arcades adorned with frescoes of the *Nibelungen Lied*.

P. is the seat of the provincial government, and of several of the state manufactories. Of these, the most important is the manufactory of arms, at which the rifles for the army are finished with all the newest applications of science, and made ready for use. A railway, 16 miles in length, connects P. with Berlin.

P. owes its creation as a town to the great elector, Friedrich-Wilhelm, who built a royal palace here between 1660 and 1673, and laid out several good streets. Prior to that period, it was an insignificant fishing village, built on the site of an ancient Wendish settlement.

POTSDAM, a township and village in New York, U.S., on Racket River, St Lawrence County, in the northern portion of the state, between Lakes Ontario and Champlain. There are quarries of sandstone, mills and factories on the falls of the river, a railway connecting it with Watertown, a bank, and 10 churches. Pop. (1860) 6737.

POTSTONE, *Lapis Ollaris* of the ancient Romans, a variety of Talc (q. v.), or rather a mineral formed by a mixture of talc with chlorite, &c. It is generally of a grayish-green colour, sometimes dark green. It occurs massive, or in granular concretions. It is soft and easily cut when newly dug up; greasy to the touch, and infusible even before the blowpipe. It becomes hard after exposure to the air. It is made into pots and other household utensils, which communicate no bad taste to anything contained in them, and when greasy are cleaned by the fire. It was well-known to the ancients; and Pliny describes the manner of making vessels of it. It was anciently procured in abundance in the isle of Siphnos (now Siphanto), one of the Cyclades, and in Upper Egypt. Large quarries of it were wrought on the Lake of Como, from about the beginning of the Christian era, to 25th August 1618, when they fell in, causing the destruction of the neighbouring town of Pleurs, in which it was wrought into culinary vessels, alabs for ovens, &c. It is quarried in the Valais, where it is called *Gillstein*; in Norway, Sweden, Greenland, and near Hudson's Bay, &c. 'Should you again visit Italy, and pass by the Great St Bernard, if the cold of that frigid region should induce you to warm yourself in the refectory of the hospitable monks of the convent, you will there see a stove of potstone.'—*Jackson on Minerals and their Uses*.

POTT, AUG. FRIEDR., a distinguished philologist, was born at Nettelrede in 1802, attended school at Hanover, studied theology and philology at Göttingen (1821), and finally (1833) became professor of the science of language in the university of Halle. Next to W. Humboldt, Bopp, and Grimm,

the name of P. stands prominent in the new science of comparative philology. The foundation of his reputation was laid by his *Etymologische Forschungen* (Etymological Researches, 2 vols., Lemgo, 1833—1836), a work second in importance only to Bopp's *Comparative Grammar*. In a well-known article in Ersch and Gruber's *Encyclopædia, Indogermanischer Sprachstamm* (2d sect. vol. 18), he gave a masterly sketch of the Aryan Languages (q. v.). In numerous articles in periodicals, and in separately published treatises (e. g., *De Borussia-Lithuanica tam in Slavicis quam in Letticis Linguis Principatu*, Halle, 1837—1841; and *Die Zigeuner in Europa und Asien*, 2 vols, Halle, 1844—1845), he carried his researches into special fields of this great province. *Die Quinare und Vigesimal Zählmethode* (The Quinary and Vigesimal Notation, Halle, 1847), and *Die Personennamen* (Proper Names, Leip. 1853), are admirable treatises, containing an overwhelming mass of information, and shewing an astonishing knowledge, not only of the Aryan languages, but of other Asiatic, African, and American races. He has since published a work on the *Difference of Races from a Philological Point of View* (Lemgo, 1856).

POTTER, JOHN, D.D., an English scholar and divine, the son of a linen-draper of Wakefield, in Yorkshire, was born in 1674, studied with great diligence and success at Oxford, where he took his degree of M.A. in 1694, and in the same year went into orders. He was appointed chaplain to Queen Anne in 1706, professor of divinity at Oxford in 1708, bishop of Oxford in 1715, and finally in 1737 attained the highest dignity in the English Church—the archbishopric of Canterbury. He died Oct. 21, 1747, and was buried at Croydon. P. was really a superior scholar, but of the dull and plodding sort. Nowhere does he flash a ray of clear searching intelligence on his subject; his habit of mind is quite uncritical, and consequently his learned labours, though creditable to his industry, have added nothing to our knowledge, and have now 'followed' their mediocre author into something very like oblivion. P.'s principal work is his *Archæologia Græca* ('Antiquities of Greece,' 2 vols. 1698), superseded for many years by Dr W. Smith's *Dictionary of Greek and Roman Antiquities*; besides which, however, we may mention his edition of *Lycophron* (1697), and of *Clemens Alexandrinus* (1715). As a church dignitary, the linen-draper's son is said to have been haughty; he was likewise very 'zealous' in matters ecclesiastical, a vigilant guardian of clerical interests, and strictly, perhaps we may even say excessively, orthodox, if such a thing be possible!

POTTER, PAUL, one of the most distinguished masters of the Dutch School. He was born at Enkhuyzen in 1625, and was the pupil of his father, Pieter Potter, an obscure painter. His progress was so rapid, that by the time he had attained the age of 16, his reputation as an artist was high. He left Amsterdam, and established himself at the Hague, where, in 1650, he was married; in 1652, however, he returned to Amsterdam, at the solicitation of the burgomaster Tulp, who commissioned him to paint a great number of works; but his health, which was delicate, gave way under constant application at his easel, and he died before he had completed his 29th year. Paul P.'s cattle-pieces are perhaps more highly valued than pictures of that class by any other master, for none have combined and brought out with such admirable technical skill so many of the qualities that give a charm to such works. His pictures bring immense prices, particularly those



painted between 1652 and 1654, when he died. He executed some admirable etchings.

**POTTER'S CLAY** or **FIGULINE**, a kind of Clay (q. v.); either slaty and massive, or more generally, earthy; yellow, yellowish-white, gray, or sometimes greenish; adhering strongly to the tongue, and forming a paste with water. The earthy variety is sometimes very loose, sometimes almost solid. P. C. is a mineral of very common occurrence in alluvial districts, and sometimes occurs in beds of considerable thickness. It occurs in many parts of Britain. It is used in potteries for the manufacture of earthenware; the different varieties of it being adapted to different kinds of earthenware. Houses are built in Egypt of pots of this material.—P. C. is also employed in agriculture for the improvement of light sandy and calcareous soils.

**POTTERY.** This term—supposed to be derived from *poterion*, the drinking-cup of the Greeks, and transmitted by the French word *poterie*—is applied to all objects of baked clay. The invention of pottery dates from the most remote period, and its application is almost universal—objects of pottery being in use amongst races even semi-barbarous. The art of moulding or fashioning vessels of moist clay, and subsequently drying them in the sun, is so obvious, that it is not above the intelligence of the rudest savage. Hence, at the most remote antiquity, the Egyptians, to whom precedence must be assigned in this art, made bricks of unbaked or sun-dried clay, cemented with straw, which were quite sufficient for the purposes of construction in a country where little or no rain falls. These bricks, in shape resembling those in use at the present day, but of larger dimensions, were impressed, at the earliest period, with the marks of the brick-maker, and later, with the names and titles of the kings for whose constructions they were made. The oppression of the Hebrews chiefly consisted in compelling them to work in the brick-fields—a task imposed on captives taken in war and reduced to slavery; and the fortresses of Pithom and Rameses, on the Egyptian frontiers, were made of bricks by the Hebrews. Kiln-dried bricks, in fact, did not come into use in Egypt till the Roman dominion, although some



Fig. 1.—Unglazed Egyptian Bottle in the British Museum.

exceptional objects of the class of bricks have been found, such as a kind of conical plug, stamped on the base with the names of the tenants of

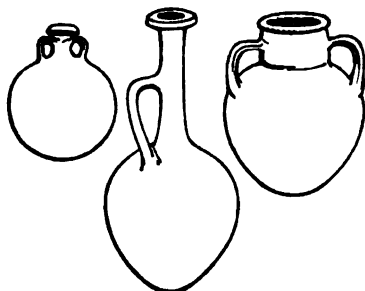

Fig. 2.—Glazed Egyptian Vases in the British Museum.

the tombs. A few other objects were made in unbaked clay; but vases of baked earthenware were in use at the earliest period of Egyptian civilisation, and are contemporary with the

Pyramids themselves. The Egyptians made a red ware, a pale-red or yellow ware, and a lustrous or polished red ware—the two first being used for vases destined for culinary and other purposes, the last for vases of more refined use, such as holding perfumes, wine, honey, and other delicacies. But the most remarkable Egyptian pottery was the so-called porcelain, made of a fine sand or frit loosely fused together, and covered with a thick silicious glaze of a blue, green, white, purple, or yellow colour. This celebrated ware, the porcelain of the old world, sometimes exhibits the most beautiful tints of blue, a colour which was produced by an oxide of copper, and which is still unrivalled. Objects were made of this material for the decoration of the dead and for the toilet. They were exported from Egypt to the neighbouring countries, and are found alike in the tombs of the Greek isles, the sepulchres of Etruria, and the graves of Greece. Most of the figures of deities, the sepulchral ones deposited with the dead, a few elegant vases, portions of inlaying, objects of the toilet, and beads and other decorations, are made of this porcelain. Still finer work of this kind was produced by carving scarabei and other small objects in steatite, and covering them with a blue glaze, so as to combine brilliancy of colour with delicacy of execution. The Egyptians had at the earliest period the simpler manipulations and tools of pottery—the potter's lathe or wheel, moulds for stamping objects, and various other tools. On the decadence of the country under the Greeks and Romans, the pottery became assimilated to the Greek and Roman.

In the contemporary empires of Assyria and Babylon, pottery was also in use at an early period. Sun-dried and kiln-dried bricks were made in the reigns of Uruk and other monarchs of the oldest Babylonian dynasties, about 2000 B. C. Platforms for elevating the larger edifices were made of them; and the bricks, like the Egyptian, were stamped with the names and titles of the monarch, to which was added the locality for which they were destined. Glazed bricks of various colours, occasionally enriched with scenes and ornamental designs, were introduced into constructions; and Semiramis is said to have adorned with them the walls of Babylon. The Assyrians and Babylonians employed this material for historical and legal purposes, making cylinders, hexagonal prisms, and purse-shaped objects of it, on which were impressed extensive writings. One of these remarkable objects contains the account of the campaign of Sennacherib against Judea and the tributes of Hezekiah. The Assyrian and Babylonian pottery resembles, but is not entirely the same as the Egyptian, being of a pale red ware, of thinner substance, finer paste, and more refined shape. At a later period, figures of deities were modelled in terra cotta. The glazed ware of Babylon and Assyria is coarser than the finest Egyptian, and is the earliest example of the employment of materials for colouring like those now in use; the glaze, however, is silicious. The objects most remarkable for size are the large coffins found at Warka, supposed by some to be the Ur of the Chaldees, with oval covers, and ornaments of the Sassanian period. The potteries of Mesopotamia continued to flourish under the Parthian and Sassanian monarchs till the conquest of Asia by the Mohammedans.

The potter's art is mentioned in the Scriptures, but few specimens of Hebrew wares have been found. Some vases have been exhumed in Phœnicia. The most remarkable pottery of antiquity was the Greek, which seems to have had another origin than the oriental. The terms *terracos* and *ostrakon* were applied by them to this material, and

## POTTERY.

they made objects and vases in sun-dried clay, terra cotta, and glazed ware. The use of bricks was by no means extensive in Greece, although some public edifices were made of them. Their first use is attributed to Hyperbius of Crete, and Euryalus or Agrolas. The bricks were made by a mould (*plasion*) and were called after the numbers of palms-length. Some were so light that they floated on water. Besides bricks, tiles, cornices, artificial ornaments, friezes, pipes for conducting water, and drains, were moulded in terra cotta. Statues and small figures, *pelinoi*, gaily and appropriately painted, covered with a *leucoma*, or white ground, and occasionally partly gilded, were in common use for votive and other purposes, and sold at a cheap price by the figurist (*koroplastos*). Dolls, cones, and various smaller objects were made by the potters; they were sometimes modelled, but more generally moulded. The Greeks claimed the invention of the potter's wheel; and the principal cities contested the honour of the art, which is mentioned in Homer, and attributed to Corcebus of Athens, Hyberbius of Corinth, or Talos, the nephew of Dædalus. Numerous vases for all the ordinary purposes of life were made by it, and others



Fig. 3.—Greek Vases of various styles.  
From the British Museum.

of large form, decorated also by separate ornaments, *emblemata*, attached to them. Large casks or *pithei* were modelled on a framework of wood. Great quantities of amphore, manufactured on the wheel, and used to contain the choice wines of Greece, were exported from Rhodes and other cities; and their debris are found in the Crimea, Alexandria, Sicily, and other cities. Some of the earlier specimens of a glazed earthenware were painted with colours in fresco or encaustic, from which afterwards came the more elaborate pictures of the glazed vases of Greece. To these succeeded two or three classes of painted ware, consisting of rude representations of animals laid upon the pale red ground of the clay in brown outline, a style prevalent at Athens and Asia Minor; which was followed by the potteries of Corinth, or the so-called Phœnician or Egyptian style. The paste of the vases is of a light red or yellow, the figures in a black or maroon colour, with portions enriched with crimson or purple; the backgrounds of a pale straw or lemon colour; the animals, of a larger size than those of the Athenian vases, intermingled with chimæras and other monsters; the backgrounds variegated with flowers—the whole derived from oriental art. Gradually, human figures, with all the characteristics of

archaic Greek art, were introduced, with accompanying inscriptions, which cannot be later than the 6th or 5th c. B. C. The subjects of these vases were derived from the oldest Greek myths. The style of this pottery by degrees improved: the paste became pale red or salmon colour; the human figures, which had been at first subordinate, replaced the friezes of animal and large ornaments. As the improvement went on, the backgrounds were made of a bright orange-red colour, the figures of a deep black; while portions, as the hair, garments, and flesh of female figures, were coloured white. The style of art became much freer, although still retaining the rigidity of the Ægean school. Names of figures represented, of the artists who painted and the potters who made the wares, were added, with speeches, and the names of celebrated beauties and athletes of the day. In these styles, the vases made on the wheel appear, while yet soft, to have had the subjects traced upon them with a finely-pointed tool; the figures were then filled in with a lucid black pigment of manganese, and then returned to the furnace. The details of the muscles and other portions were incised through the black with a sharp tool, so as to shew the lighter background, and the purples, crimsons, blues, and other colours were laid on. The subjects are chiefly derived from the war of Troy and the heroic age; and the shapes in use were oil-jars (*lecythoi*), water-pails (*hydrie*), wine-vases (*crateres*), wine-jugs (*asochoæ*), and amphore. They seem to have continued in use till about 450 or 420 B. C., when the red figures were substituted for black, by tracing, as before, the figures on the clay, then running round them a thick line of flock, and finally filling up the background entirely with black colour—the muscles and inner marking not being incised, but traced in black and brown outlines. The earlier vases of this class, which are of the strong style, resemble those of the black figures; but the style gradually improved, and resembled the art of Phidias and Zeuxis; while the letters are those in use after the archonship of Euclid, 403 B. C. The style and form of these vases altered according to the art of the period, till the ultimate disease of fictile or painted ware, about 300 B. C., when the conquests of Alexander the Great and the increase of luxury caused it to be superseded by vases in metals. In its last



Fig. 4.—Greek Vases of later style, found in Italy.

stage, the pottery became moulded, and was glazed entirely black, or else variegated with opaque white figures and ornaments. The subjects of these later vases differ considerably from the earlier, being chiefly derived from the theatre or myths of the

## POTTERY.

later poets. Vases of this description are found in Greece, the isles of the Archipelago, and Italy; into which latter country they appear to have been imported from Greece.

In Italy, indeed, the Etruscans, at an early period, and perhaps some of the principal cities in Magna Græcia, manufactured their own pottery. That of the Etruscans consists principally of three kinds—an unglazed red ware; a lustrous brown ware, made also by the neighbouring Sabines and Oscans; and a black ware, the paste or substance of which is black throughout, not superficial, as amongst the Greeks, and made by mixing some colouring material with the clay. The Etruscan pottery is rarely painted—the black ware never—but it is distinguished by having ornaments in salient and bas-relief modelled or moulded on it, and by the shapes of the vases apparently being derived from works in metal, and reproducing the fantastic combinations of oriental art. This ware, which was in use from 500 to 320 B. C., was the source from which subsequently arose the Arretine and Roman pottery. It was ornamented sometimes with incised ornaments; the subjects, however, are generally uninteresting, and it never attained a high position in art. The Etruscans, however, in later times imitated the painted vases of Greece, but their clay is much paler, the drawing coarser, and the shapes less elegant. In terra cotta statues, they particularly excelled, and supplied the Romans with the figures of their divinitæ. Even sarcophagi were made of this material.

On the decline of the pottery of the Greeks and Etruscans, a new kind of ware was made at Arezzo, or Arretium, to which has been given the name of Arretine, and which resembled the later ware of the Greeks. It is evidently imitated from works in metal, in all probability from the chased cups of silver and gold which began to come into use in Italy, and was a continuation of the later moulded wares of Greece and Italy. The vases were of a bright red or black colour; the paste, uniform in colour throughout, but covered with a lustrous silicious glaze. The red colour nearly resembles in colour and texture a coarse sealing-wax, the paste is often remarkably fine. The vases, generally of small dimension, were turned on the lathe; the ornaments were moulded separately, and attached to the vase: patterns were produced by the repetition of the same mould, or by placing bas-reliefs from various moulds on the vases. This kind of pottery was first made at Arezzo, but subsequently, or nearly simultaneously, was produced at Capua and Cumæ in the 1st c. A. D. It afterwards extended over all the Roman world, and was made in Gaul and Germany. It was called Samian ware under the republic, and was at first extremely fine, but deteriorated under the last of the twelve Cæsars, and is no longer found under the Antonines; a red ware, glazed with red-lead and copper, having been substituted for it. The names of several hundred potters are found stamped upon extant specimens of this ware, and some of them are evidently of Gaulish or British origin. These names are followed by *F. fecit*, or made; *M., manu*, or by the hand of; and *OF., officina*, or establishment. The ware was extensively imported into Britain and the remoter provinces of the empire; and wherever found, shews the influence of Roman civilisation. Furnaces for it have been found in France and Germany, but not in England. The other kinds of Roman ware were local, evidently made upon the spots where found, but with inferior ornamentation. Black-ware seems to have succeeded this, and to have been produced by confining the smoke of the furnace, and throwing it down upon the heated ware. In

Britain, varieties of this ware were made at Castor in Northamptonshire, ornamented with bas-relief, laid on by the process of depositing a fluid clay on the wet ware, and moulding it with a tool. The style of art is Gaulish. Other vases of glazed ware



Fig. 5.—Anglo Roman Vase [Castor].



Fig. 6.—Roman Vase.

were manufactured at Upchurch near Rochester, and at Crockhill in the New Forest. They have only a few ornaments, either stamped or painted in a white pipeclay on the surface. These vases are probably as late as the 3d c. A. D. Later, arose a black-ware, generally bottles or jugs, glazed externally, and with single words, invitations to

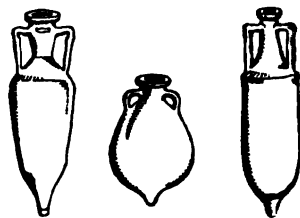

Fig. 7.—Roman Amphora.

drinking, painted on them, in a white pipeclay. Many varieties of unglazed ware, red, yellow, white, and gray, were extant in the 2d and 3d centuries. The large culinary and other vessels were made of these—such as casks (*dolia*), amphoræ, jugs (*lagenæ*), and mortars (*mortaria*)—the last at Lyon. The Romans made great use of brickwork terra cotta. All over the empire, bricks were made for public and private buildings, and stamped at Rome with the name of the proprietors of the land, the potters, and the consulate of the period, till the middle of the 3d c. A. D. Bricks were also



Fig. 8.—Roman Flange Tile.



Fig. 9.—Roman Flue Tile.

extensively manufactured by the legionaries, and bear their names and titles. The graves of the

## POTTERY.

soldiery were often constructed of them. At Rome, the last inscribed bricks are those of Theodorici; none so late have been found in Britain or Gaul. Tiles, cornices, roof-ornaments, and gutters were formed of terra cotta, so were the votive figures offered to the gods; but they all disappeared at the invasion of the northern barbarians, although they continued till then to be manufactured by local potteries.

Among the northern nations, especially the Celts and Scandinavians, long prior to the Roman conquests of Gaul and Britain, at the remote age of the Stone and Bronze Periods, large and small vases, perhaps originally employed for domestic, but subsequently for mortuary purposes, are found amongst the cromlechs, the tumuli, and graves of Northern Europe. They are formed of a coarse clay, mixed with small pebbles, and have been feebly baked by surrounding them with hay, dried ferns, or other combustible vegetable matters, which have been burned inside and around them. The interior of the walls are black; the exterior, of a pale brown colour. Their mouths are large, the ornaments, hatchings, and rude line sometimes making an elaborate pattern or tattooing all over the vase. Those from Britain were called *bascauda*, or baskets, by the Romans. A modification of this class of ware was continued under the Saxons and Merovingians, and is distinct from the Gallo-Roman and Romano-British potteries: the clay being better baked, and the ornaments, stamped or impressed from a mould, more regular. The use of pottery among these races was to a great extent superseded by glass, metal, and other substances for drinking and culinary vessels, and few or no specimens of medieval unglazed vessels are known. Terra cotta, indeed, continued to be applied for making figures from the 14th to the 18th c. in Europe; but in England, even the use of bricks, a manufacture difficult to have been lost, was restored by Alfred. Unglazed ware was, in fact, superseded or abandoned in Europe after the fall of the Roman empire; but in modern times, the use of terra cotta and such like ware is found extended all over Europe, Asia, and Africa, varying in texture and excellence from the coarse flower-pots to the thin and graceful water-bottles of the Arabs and modern Egyptians. Even the Nigritic races continue to manufacture a feebly baked earthenware, rudely coloured with pigments not baked on the ware. In the New World, the existence of unglazed earthenware seems to date from the most remote antiquity. The vases and other objects found in the northern portions of America, indeed, are of the rudest kind, and bear a striking resemblance to those of the early Scandinavian, Celtic, and Teutonic graves, in paste, shape, and ornamentation. The Mexican and Peruvian potteries, however, evince a much greater mastery of the art, and both are modelled with great spirit, gaily coloured, and profusely ornamented. Some of the oldest Peruvian wares, indeed, rival in their modelling European art; but they never attain to glazing. The other unglazed wares of the New World differ according to the localities where they have been manufactured, and in the most highly-civilised portions, reflect or rival the arts of the people by which it has been colonised. Those of the existing native races are very feeble, and the processes are sometimes accompanied by magic ceremonies. The pottery of the southern hemisphere is quite recent, as none of the races seem to have been acquainted with the art. The Fijis, indeed, have a ware glazed with the resin of a tree, but it appears to have been derived from Europe.

The knowledge of glazes originally acquired by the Egyptians and Assyrians, was continued under

the Roman empire at Alexandria, and appears to have been transmitted to the Persians, Moors, and Arabs. Fayences, and enamelled bricks and plaques, were in use among them in the 12th c., and among the Hindus in the 14th c. A. D. The Moors introduced into Spain the use of glazed tiles about 711 A. D., examples of which, called *Azulejos*, as old as the 13th c., are found in the Alhambra. Besides these, the manufacture of glazed or enamelled fayences in Spain, distinguished by a metallic iridescence, came into use from the 13th c. in Spain. In Italy, they are supposed to have been introduced as early as the conquest of Majorca by the Pisans, 1115 A. D.; but the first appearance of Italian enamelled fayence, the precursor of modern porcelain, does not date earlier than about 1420, when it was used for subjects in relief by Lucca della Robbia. About a century later, plates and other ware were manufactured at Pisaro and Gubbio, decorated with subjects derived from the compositions of Raphael and Marc Antonio, painted in gay and brilliant colours. But the establishment was abandoned in 1574, although pieces of *majolica* continued to be fabricated in various cities of Italy till the 18th century. From Italy, this enamelled ware passed into France in 1590 with Catharine de' Medici, where it was manufactured till the end of the 17th century. In 1555, the celebrated Palissy discovered at Saintes the art of glazing or enamelling a gray paste, and introduced dishes and other objects with fruit, fish, and animals moulded from life, distributed over the surface, as a kind of ornamental ware. At the same time, or earlier,



Fig. 10.—Vase of Henry II. ware.

was made what is called Henry II. ware, and which is now so precious, consisting of glazed white ornamental pieces. Glazed or Norman tiles, however, as they are called, date from two centuries before. At the close of the 13th c., glazed ware was made in Alsace; but it was not till two centuries later that *majolica* was fabricated at Nuremberg; and the manufacture was continued in various parts of Germany till the 18th century. Delft, which gave its name to its own fabric, is said to have produced a glazed ware as early as 1300, and continued to do so till the 19th century.

Holland was chiefly celebrated for its bottles of stoneware, glazed by salt, called Bellarmines, Graybeards, or Bonifaces, and for its tankards, which were imported all over Europe, in the 16th c.,

## POTTERY.

and are repeatedly found in London excavations. In England, glazed tiles for religious purposes



Fig. 11.—Tyg with two handles, 14th century.

were made by the monastic orders from the 12th to the 16th centuries; and glazed bottles, jugs, and cups are found of the time of Henry II; while Edward III. favoured the establishment of potteries in England. The English wares, however, were superseded by Delft and Dutch stonewares till the close of the 17th c., when the coarse wares made at Burslem were improved by the discovery of salt and other glazes. Some Germans, named Elera, from Nuremberg, settled there, and produced an improved ware called the red Japanese; but finding that the secret was discovered by Astbury, left for Lambeth, where they established themselves in 1710. From this period, various improvements were introduced by Astbury, Booth, and finally by Wedgewood, who discovered more suitable clays in 1759, and called to his assistance the arts of



Fig. 12.—Tyg of Staffordshire ware.

design, by the employment of Flaxman for bas-reliefs and figures. The applications of copper-plate printing and gilding were subsequently discovered. Still later, other materials, as felspar and bones, were used in the composition of this pottery. Delft-stone and other wares were made at different places, as Liverpool, Lowestoft, and elsewhere; but, after different vicissitudes, most of the potteries have disappeared except those of the stoneware at Lambeth and Vauxhall.

None of this ware, however, was of the nature of the Chinese porcelain which had been imported by the Arabs in the 13th c., was known in Italy in 1330, and was imported into France as early as 1370, and into England much later. The name porcelain, from *porcellana*, an obscure Portuguese word, supposed to mean a shell, is applied to a mixture of alumina or *kaolin* and silice or *petuntse*, which, when baked, does not fuse at a temperature as high as 140° of Wedgewood's pyrometer, and the glaze of which is incapable of being scratched by a knife. This porcelain, called 'hard porcelain,' is said to have been invented at Sin-ping in China, about 185 B. C., and rose to great importance at King-te-chin, 557 A. D., where, in 1712,

3000 furnaces were in activity, and where the manufacture is still carried on. There are about 18 renowned potteries in the empire. The art of pottery in China is said to be as old as 2599 B. C. In Japan, hard porcelain dates from 27 B. C.; translucent porcelain was made about 672 A. D.; but between 1211 and 1221, Kotosiro, a Japanese potter, went to China to improve his process. There are 18 celebrated potteries in Japan; and in modern times, the pieces exported come chiefly from Imali, in the province of Fizen. In 1644, the Dutch exported 44,943 pieces from Japan. At the beginning of the 16th c., the porcelain of China began to be extensively imported into Europe, and various unsuccessful attempts were made to discover the secret of its manufacture, but without success, both as to the material and the process. The Persians, indeed, are said to have produced translucent pottery about the 15th c. A. D.

After some trials, which resulted either in the production of a kind of opaque glass or stoneware, Böttcher or Böttger, an alchemist (who had been seized by Frederick Augustus II. in 1701), after Schnorr, in 1709, had discovered white *kaolin* at Aue, produced from it a white hard porcelain at Meissen, near Dresden; and the porcelain establishment there was founded under royal auspices. Extraordinary precautions were taken to prevent the process being discovered, by imposing oaths upon the workmen, and the process there pursued was not communicated till 1812 to Brongniart. The secret, however, was betrayed by Stöfel, a workman of Meissen, who fled to Vienna in 1720, where an imperial establishment was founded, which exists to this day. Other workmen carried the secret from those establishments all over Germany. Royal works were set up at Berlin in 1755, at St Petersburg in 1744, and at Munich in 1758. From this period, two different kinds of porcelain were made in Europe, a soft and

a hard. In France, soft porcelain was made at St Cloud in 1695, and was not discontinued till 1804. The accidental discovery, by Madame Darnet, of *kaolin* at St Yrieix la Perche, in 1765, led to the production of hard porcelain at Sèvres, where, after 1800, only this kind was made. Various places in France made both kinds; and in Italy, both were produced at La Doccia, near Florence, at Capo di Monte, near Naples, and at Venice. Other establishments flourish at Madrid and Oporto, established in the 18th century. The manufacture of soft porcelain appears to have been introduced in England, at Bow, as early as the 17th c., and the Chelsea works were



Fig. 13.—Staffordshire Minton set up still earlier, according to some, by Elera. Thence the art was transferred to Derby in 1748; and an establishment

## POTTERY.

at Worcester, founded in 1751 by Dr Wall, is said to have first printed on porcelain. Hard porcelain was made by Cookworthy at Plymouth in 1705, and afterwards at Bristol, but was subsequently abandoned as unprofitable, although again made by Minton in Staffordshire in 1850. One of the last inventions in porcelain has been the introduction of Parian, or statuary, used for the production of small figures and statues, by Copeland and Minton. Amongst the oriental nations, the production of porcelain seems limited to China and Japan, although fayences and glazed wares are manufactured all over the East. The production of a white porcelain, either soft or hard, capable of being moulded and painted with various colours, effected a revolution in the ceramic art: sculptors were employed to mould small figures and other objects by the different establishments, and the vases, which at first were decorated with rude copies or poor imitations of their Chinese originals, by degrees introduced on their surfaces the art of the country where they were made. The paintings on porcelain thus resembled those on enamel, and when the pieces were of considerable dimensions, and painted by distinguished artists, became of great value. Thus, copies of works of Raphael and of Tintoretto, in the Exhibition of 1851, were valued at £1000 and £880. Even ordinary cups, when painted with vignettes, have their value much augmented. So also the application of delicate colours, as blue, green, and rose-pink, added a charm not found in the monochrome glazed ware of the middle ages. For these, Dresden and Sèvres were formerly unrivalled; but the colours of late years have been changed, and do not equal the old. The style of art has varied in each century; the old rococo shapes having been superseded at the commencement of this century by classical shapes, and again by modified mediæval forms. The present age has been distinguished by an attempt to reproduce *majolica*, *palissy*, and other wares; by the improvement of printing in colours; by the invention of statuary porcelain, and an application of the material to other purposes, as buttons, stamped or pressed from a mould or die. Besides the ornamentation of vases, a trade-mark is often added, either stamped in or painted on the ware. This, on the early *majolica*, had the date, place, and name of the artist; but the Dresden, Sèvres, Chelsea, and other establishments introduced devices, monograms, arms, &c., as swords, anchors, crowns, and other devices. The Chinese has devices, mottoes, names of makers, and the date of the reign when made, commencing with the first monarch of the Ming dynasty about 1450, generally in red colour, and imitating the seals or stamps used for sealing documents. These marks are continued to the present day (see below).

Brongniart, *Traité des Arts Céramiques* (8vo, Paris, 1844); Birch, *Ancient Pottery* (1859); Marryat, *Pottery* (1857); Arnoux, *Lectures on the Results of the Great Exhibition* (12mo, Lond. 1851); Lardner, *Great Exhibition* (12mo, Lond. 1852, p. 123); Jacquemart and Le Blant, *Histoire de la Porcelaine* (8vo, Paris, 1862).

*Manufacture.*—The dough-like condition into which clay can be worked with water, and the hardness it may be made to acquire by burning, are qualities which have been turned to account by man from the earliest times, and it is upon these that the potter's art essentially depends; but there is great variety in clay, and it is only by knowing something of its nature and constituents, that any real advance has been effected in pottery. If a piece of clay be examined, it will be found that it consists of exceedingly minute particles, held

together by aggregation when moist; but if dried, it can be easily reduced to an impalpable powder by mere pressure; and if, instead of drying, we add an excess of water, it may be so mixed and held in suspension in the water that it appears almost to be dissolved. In time, however, it is deposited as a sediment, and when the excess of water is removed, it is a soft tenacious paste, which is so non-elastic that it will retain the smallest impression made in it without change. This minute division of its particles, and the absence of elasticity, are its most valuable qualities. But all clays are not of the same purity and quality; the commonest is that of brick-fields, which is one of the most abundant substances in nature; but it is so mixed up with iron and other foreign ingredients, that except for bricks, tiles, and the coarsest kinds of pottery, it is not used.

The purest kinds of potters' clay are called *kaolin*, and are believed to have been formed by the decomposition of rocks containing large proportions of felspar, a slightly variable compound substance, which, in general terms, may be said to be a combination of neutral silicate of alumina and the silicates of potash, soda, lime, or magnesia, together or singly. Certain kinds of granitic rocks, especially the whiter varieties, by their atmospheric decomposition, yield fine kaolin. Great experience is required in selecting and using the materials, because in nature the plastic materials are very irregularly mixed with other substances, which have a more or less deteriorating effect. Most of the best known clays contain a certain portion of free silica in addition to that in combination as natural silicate, which requires to be removed for very fine wares by boiling in caustic potash, otherwise, it proves injurious. The finest china-clay of Great Britain is obtained from Cornwall, where the decomposed granite is washed by streams of water, which carry it away into ponds called *catchpools*. The discovery of this source of china-clay was made by Mr Cookworthy about the middle of last century, and alone afforded means for improving our native pottery, which were most admirably turned to account by Mr Josiah Wedgwood, and after him, by Mr Herbert Minton, Mr Copeland, and others. Previous to this, although, as before noticed, fine pottery was made in Britain in two or three places, yet the general character of our pottery, which was chiefly manufactured in the neighbourhood of Burslem, in Staffordshire, was most miserable both in material and in design. The clay was inferior in colour, prepared with very little care, and covered with a coarse white or yellow lead glaze; but the discovery of the Cornish clay, by affording a material of excellent quality, stimulated the manufacturers to improve the general style of their manufacture. Scarcely second in importance to this discovery was Wedgwood's good taste and untiring zeal in working out that revolution in the art of the British potter, that has led to its present enormous development. In 1730, when Wedgwood was born at Burslem, in Staffordshire, that place supplied the greater part of the common household pottery of Great Britain; but so small was the trade, that it was but little more than a village encumbered with heaps of broken crockery, and its environs disfigured with clay-pits and piles of refuse; now it is the centre of a populous district called 'The Potteries,' comprising about 48 square miles. In this limited space there are now nearly 280 kilns at work, employing more than 100,000 operatives.

The method pursued in making pottery and porcelain is the same in principle everywhere; we shall therefore give the general outline of the process without entering into the minute differences which distinguish the variations produced by

## POTTERY.

different manufacturers in this and other countries. Pottery and porcelain differ chiefly in this, that the superior quality of the materials used in making the latter, gives it a peculiar translucency. For pottery, inferior materials are used, and a considerable admixture of calcined flint, bone-ashes, or native phosphate of lime, are added to the clay. The use of the calcined flint was said to have been first adopted by a Burslem potter named Astbury, who, whilst travelling to London on horseback, in the year 1720, had occasion, in passing through Dunstable, to seek the assistance of an hostler, in consequence of some disease in his horse's eyes. He noticed that the man took a piece of flint, burned it, and then reduced it to a fine powder, which he blew into the horse's eyes. Astbury noticing the beautiful whiteness of the powder, conceived the idea of using it in his pottery; and did so with great success.

The ingredients, such as the clay and calcined flints, are ground by separate means; the former in



Fig. 14.

the clay, which is thrown in lumps into the hopper-shaped upper part of the vat, is worked down, and is so cut and kneaded by the knives, that it is forced out at an opening at C, in the state of soft pap. This is aided by the knives on the lower part of the lowest arm being connected together by a plate D, which prevents all settlement at the bottom. This pap-like clay passes into a large wooden tank, in which it is agitated with water until quite incorporated, so as to resemble milk in colour and consistency. In another mill (fig. 15), of a different construction,

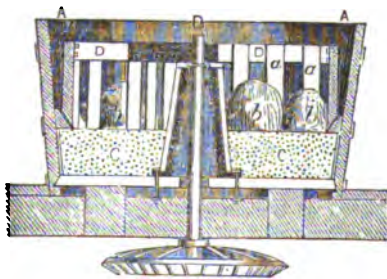

Fig. 15.

the Cornish granite and calcined flints are being reduced to a somewhat similar state. This mill is very strongly constructed, and consists of a tub-like vat A, in the centre of which turns an axle B,

moved by machinery; in the bottom of the vat is a thick stone-bed C, consisting either of chert or horn stone. From the upper part of the axle, three strong arms, D, D, D, project like the spokes of a wheel; and strongly attached to these are stout beams, a, pointing downward, and nearly touching the stone-bed C. As the axle, with its arms and beams, turns round, the beams push some large masses of the Cornish granite or of chert stone round with them, and these triturate the calcined flints and other hard materials, and stir up the water with which the vat is kept constantly supplied, whilst it overflows in a milky state, charged with the finely-divided materials, into a cistern, where it is kept stirred until it is sufficiently supplied with the solid materials, and the thickened milky liquid is then drawn off, in proper proportions, into a vat to which the prepared clay is also passed. The mixture of the two is then allowed to subside until the water is nearly clear, when it is drawn off; and the sediment is deprived of its surplus moisture, either by evaporation, or, in the best works, by a pneumatic-exhausting apparatus, which does it very quickly. The composition is then a fine plastic material of the consistency of tough dough, and is ready for the potter's use. In preparing the finer materials for porcelain, many other operations are required, all, however, having the same object, viz., the extremely minute division of the substances used.

The prepared clay is taken to the *throwing-machine*, or *potter's lathe*, which is represented in fig. 16. This consists of a fixed table A, through

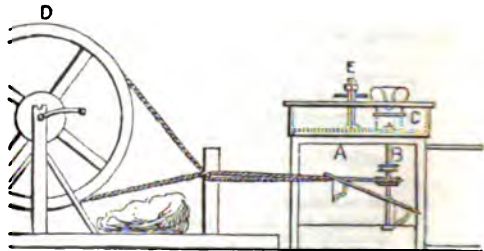

Fig. 16.

which passes the axle B, and rises a little above its surface, and having on its upper end a disc C, which revolves with it. The axle is put into rapid motion by turning the fly-wheel D, either by hand or machinery; and this causes a rapid revolution of the disc C, upon which is placed the soft mass of clay to be moulded. At E is seen an upright, with a small sliding-bar regulated by a screw; this is the guide for the potter to regulate the height of the vessel he is making. When the lump of clay is

revolving, the potter, with his hands or with proper tools, fashions it into any shape he pleases; his management of this requires considerable skill, as nearly every article requires a different configuration. But some articles are formed in moulds, the moulds being made of plaster of Paris. This answers well for fine porcelain intended to be very thin, because the plaster-mould absorbs much of the moisture in the paste, and thus partially dries



Fig. 17.

POTTERY.

it, so that it admits of handling, which in a softer state would be very difficult. The paste is used so liquid that it can be poured into the

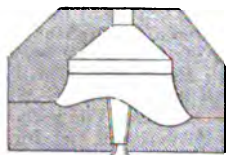

Fig. 18.

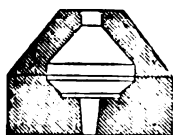

Fig. 19.

moulds. It is usual, in casting, to have a mould for each part, as seen in figs. 17, 18, 19, which represent the body, neck and lip, and foot of the cream-ewer, fig. 20.

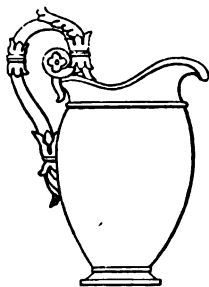

Fig. 20.

For nearly flat articles, such as dinner-plates, a plan is adopted which combines both processes: a mould, usually of plaster, fig. 21, *a*, is placed on the disc of the throwing-wheel, *b*, and a thin layer of the paste is pressed on to it, so as completely to take its form; then to the guide-post, *c*, is attached an arm, *d*, with a small brass plate, *e*, on its lower side. This plate is cut to the outline of half the plate, or dish; as it revolves, this pares down and

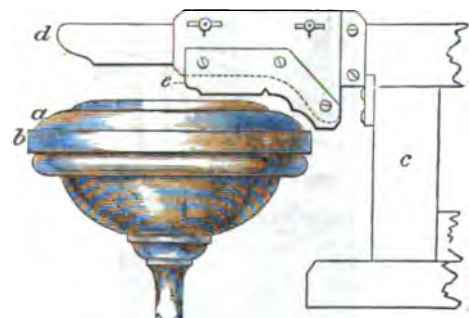

Fig. 21.

shapes the clay to its own outline, and to the thickness to which it is set,



Fig. 22.

there being an arrangement on the arm of the guide-post by which this can be effected. Sometimes, as in the case of deep vessels, moulds are used for the exterior, and the interior is formed by the hand. This process (fig. 22) insures certainty of size and shape, which is important in making large numbers of similar articles, as tea-cups, &c. The mould is lined with a thin cake of clay, and when placed on the revolving disc, it is fashioned inside by hand, and finished off with a wet sponge.

Sometimes metal or horn tools are used for producing mouldings and other raised ornaments, or for grooves, when the turning or

throwing wheel is used. If the articles made require handles or other similar accessory parts, they are always moulded, unless of very simple forms, and are attached whilst they and the body are still soft enough. They are joined by a thin fluid paste called a *slip*, and the junction is smoothed over with the wet sponge, which is one of the most useful of the potter's tools. Being formed, the articles, of whatever kind, are now taken to the drying-stove, where they are placed on shelves, and remain there some time, exposed to a heat of about 85° Fahr. When quite

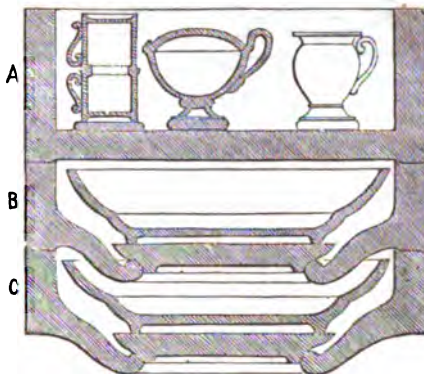

Fig. 23.

dry, they are next taken to a workshop near the kiln, and they are here carefully packed in coarse earthenware vessels, called *seggars* (fig. 23), which

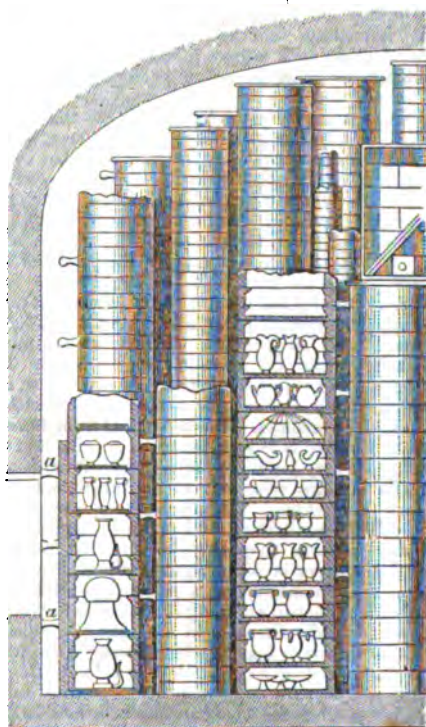

Fig. 24.

are so made that they can be piled upon one



another to a great height in the kiln, as seen in fig. 24, in which some of the seggars are seen in section, for the purpose of making the arrangement more intelligible. As the seggars are generally made large enough to hold a number of articles, which would, when highly heated, adhere if they touched, a number of curiously shaped pieces of



Fig. 25.

burned clay are used for placing between them, so as to make them rest on points; these are called *watches, cocks-purs, triangles, stils, &c.*, fig. 25.

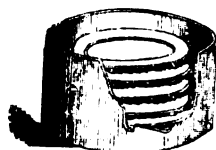

Fig. 26.

In the seggar, filled with plates (fig. 26), the plates are seen each resting on *cocks-purs*, which prevent them touching. Another object is gained by this, in burning flat articles such as plates; these, if placed one upon another, would not be fired equally, but when they are held apart, the heat affects all parts alike. The seggars are so piled in the kiln that the centre is hollow, and there are free spaces between them through which the fire can ascend; props, *a, a, a*, fig. 24, being so placed as to keep them from immediate contact with the sides all round. Thus, each seggar forms a small oven, in which one or more pieces of pottery or porcelain are baked, and the seggars prevent any unequal heating of the pieces, and also protect them from smoke. A kiln has generally eight furnaces, and it is usual to raise six piles of seggars between every two furnaces, or rather between their flues, which rise to a considerable height in the kilns. Each pile of seggars is technically called a *bung*, so that there are generally 48 or 50 bungs to the charge of a kiln. When all this is arranged, the furnaces are lighted, and great care is taken to have the best coal, as it enables the manufacturer to make a more certain calculation as to its effects, and is less liable to smoke and sulphureous vapours, which might injuriously affect the contents of the kiln. The baking or firing requires great care and attention, and there are many nice regulations connected with it to guide the workman. It usually lasts from 40 to 42 hours. The fire is then allowed to go out, and the kiln to cool very gradually, after which it is opened, and the seggars removed, to be unpacked in a separate workshop. The articles are now in the state called biscuit-ware, and require both the glaze and any patterns they may be intended to bear. Common pottery is often figured by printing the design in enamel colours on paper, and whilst the printing is still wet, applying it to the biscuit-ware; the ware absorbs the enamel ink, and the paper is removed by water, leaving the pattern on the ware. It is then fired in seggars, or a muffle, to fix the colour, and is then dipped into composition called *glaze*, of which three kinds are used in the Staffordshire potteries. The first, for common pipeclay ware, is composed of Cornish granite, 16 parts; flint, 36 parts; white-lead, 53 parts; and cullet, or broken flint-glass, 4 parts. These materials are

tritulated with water, with the same care and by similar means to those employed in forming paste, and are reduced with water to the same milk-like liquidity. Each workman has a tub of the glaze before him; and as the articles of biscuit-ware, either with or without decorations, are brought to him, he dips them in the glaze, so as to insure a uniform coating over them; and by nice management, he prevents any large drops or accumulations on one part more than another. The porous biscuit-ware rapidly absorbs the moisture, and dries up the thin film of glaze on the surface of the articles, which are again placed in seggars, and carried to the glaze-kiln, where they undergo another firing, which melts the glaze, and converts it into a perfectly transparent glass, like water, all over the surface, and renders any pattern previously printed upon it very plain. The temperature in the glaze or enamel kiln is only increased very gradually, and is kept up for about 14 hours, after which it is allowed to cool slowly, and the articles are taken out completed. So far, this description has applied to the manufacture of pottery and porcelain on a large scale, for general purposes; but when it is applied to more costly and artistic works, very special arrangements are required; and in the case of remarkably fine pieces, instead of the huge kilns, which hold frequently many thousand pieces, muffle furnaces (fig. 27) are both used for the

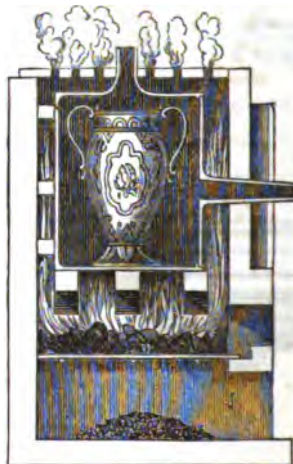

Fig. 27.

biscuit, the glaze, and the coloured and gilded decorations, which, in porcelain, are applied on the glaze, and not on the biscuit.

The decoration of porcelain has long held a high rank as a fine art; and the exquisite skill shewn in some of the finest works of the continental manufactures, and lately in those of Britain, has fairly entitled it to that rank. The colours employed are all coloured glasses ground to impalpable powders, and mixed with borax or some other fluxing material; for use, they are generally made liquid with oil of spike, and they are laid on with hair-pencils, in the same way as oil-colours. The whole process is exactly the same as in painting or staining glass; the glaze on the biscuit-porcelain being true glass, and the enamel colours being exactly the same as those used by the glass decorator. The colours may be made by mixing the materials of which glass is made with the colouring material and the flux, or simply with the already coloured glass and the flux. When the former plan is employed, the following

POTTERY.

are the colouring materials employed: oxide of chromium for green; oxide of iron for red, brown, violet, gray, and yellow; oxide of uranium for orange, yellow, black; oxide of manganese for violet, brown, black, and purple; oxide of cobalt for blue, gray, and black; oxide of antimony for yellow; oxide of titanium for yellow; oxide of copper for green; suboxide of copper for red; sesquioxide of iridium for fine black; protochromate of iron for brown; chromate of lead for yellow; chromate of barytes for yellow; chloride of silver for deepening reds and purples; purple of cassius for ruby and purple. Several of these colours are much increased in brilliancy by the addition of oxide of zinc, which of itself gives no colour; and the transparent ones are rendered opaque by the addition of oxide of tin.

Other fluxes besides borax, or borate of soda, are used—as sand, felspar, boracic acid, minium or litharge, salt, saltpetre, potash, and soda. Nothing enriches the appearance of porcelain more than good gilding; for this purpose, gold-leaf is rubbed down with oil of turpentine; or pulverulent gold is produced by precipitating a solution of gold in aqua-regia, by the addition of a solution of sulphate of iron. The gold is precipitated as a brown powder, which is washed and dried, and then worked up with one-sixteenth of its weight of oxide of bismuth

and oil of turpentine. It is painted on, then fired, and afterwards burnished. Peculiar and beautiful metallic lustres are produced upon pottery by precipitated platinum and other means; but it is not within the scope of this article to enter into all the details by which the almost numberless variations are produced in the manufacture and decoration of this material. The literature relating to its history is rich in treatises for the guidance of those engaged in the art.

The following are the chief varieties of ceramic materials, and their usual composition: 1. *Porcelain*.—At Sevres, kaolin, 48 parts; sand (pure white), 48 parts; chalk, 4 parts. At Dresden, kaolin, 62 parts; felspar, 26 parts; broken biscuit-porcelain, 2 parts. At Berlin, kaolin, 76 parts; felspar, 24 parts. In England, three mixtures are used—For common china, ground flints, 75 parts; calcined bones, 180 parts; china-clay, 40 parts; clay, 70 parts. For fine china, ground flints, 66 parts; calcined bones, 100 parts; china-clay, 96 parts; Cornish granite, 80 parts. Fine, for modelling figures, &c., Lynn sand, 150 parts; calcined bones, 300 parts; china-clay, 100 parts; potash, 107 parts. The glazes require to be varied for nearly all, so that their fusibility may be greater or less, according to the more or less fusible character of the biscuit

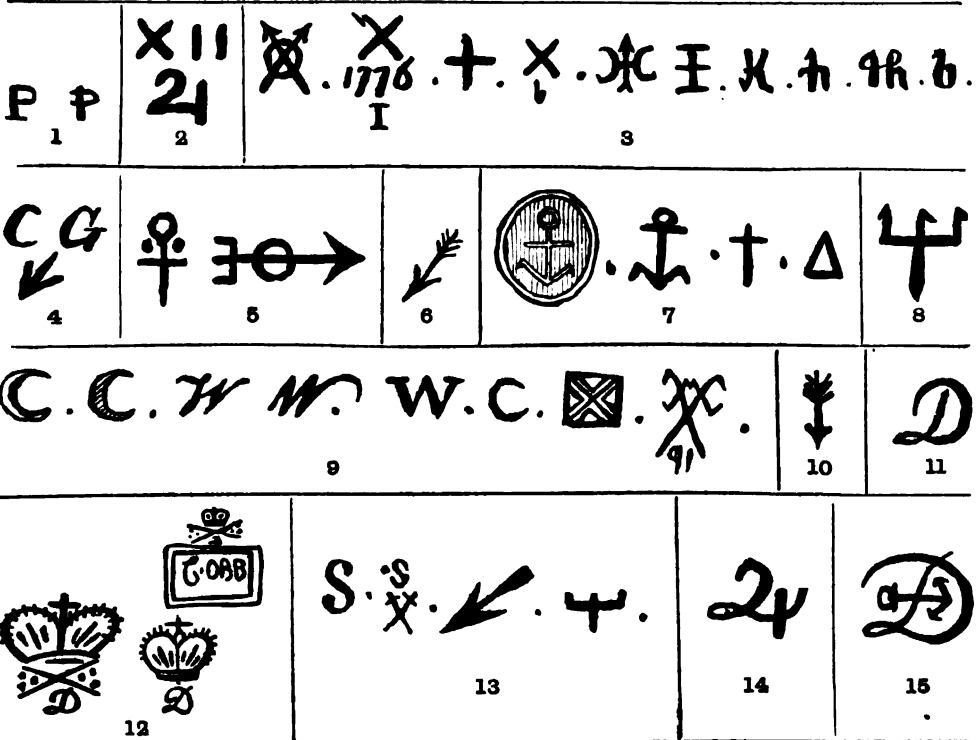

1, Pennington, Liverpool, 1760—1780; 2, Plymouth, about 1760; 3, Richard Champion, Bristol, 1772—1790; 4, Charles Green, Leeds, 1790; 5, Bow, 1730—1790; 6, Absolon, Yarmouth, about 1790; 7, Chelsea, 1730—1784; 8, Swansea, Wales, 1790; 9, Worcester, 1760—1780; 10, Yarmouth, about 1790; 11, Derby, 1761—1769; 12, Crown, Derby, 1780—1830; 13, Shropshire, 1772—1799; 14, Cookworthy, Plymouth, 1760; 15, Derby—Chelsea, 1770.

ingredients. 2. *Porcelan*.—The composition for this is the same as that for the fine English china, but it is used in a liquid state, so as to be poured into the plaster of Paris moulds. It requires very great care in the firing. 3. *Earthenware* (Fr. *Faïence*,

from *Fayenza*, the name of a place in Italy where it was made; Dutch, *Delft*, from its having been chiefly made at Delft, in Holland).—Made of various kinds of clay, varying in colour from yellow to white, according to the quality required; and

more or less of powdered calcined flints are mixed with it, to give it body and hardness. Sometimes, as in porous vessels, only clay is used. 4. *Stoneware*, such as is used for jars, bottles, drain-pipes, &c., is made of several kinds of plastic clay, mixed with felspar and sand, and occasionally a little lime, but the materials vary much in different localities.

In this country, the potteries not only supply the demand, but are estimated to export about £1,300,000 annually. The entire produce in 1851 was £2,450,000. In 1852, there were 185 establishments; 70,000 operatives were employed, and 84,000,000 pieces exported. England, France, and Germany only export; England to the greatest amount. France, which had only five or six establishments, did not produce more than £200,000 worth annually, and exported £18,000 worth. Germany, which had 40 manufactories, exported about 5000 tons. The chief exports are to North America, where, however, in the various states there are rising potteries, as Jersey, Philadelphia, Liverpool in Ohio, and other places.

Most of the celebrated manufacturers of pottery and porcelain, both at home and abroad, have employed a special mark to distinguish their works, and these are now of considerable importance in enabling us to ascertain the origin of choice specimens. On the preceding page are given some of the more important marks and monograms, so used by the earlier English makers, when their names in full were not imprinted, as was often the case.

**POTTO.** See KINKAJOU.

**POTTSVILLE**, a village of Pennsylvania, on the Schuylkill River, at the entrance of Norwegian Creek, 93 miles north-west of Philadelphia, with which it is connected by railway. It is in the midst of a rich anthracite coal and iron region, and has four iron foundries, a brass foundry, manufactures of iron safes, sashes, and wood-work; county buildings; 3 English, 3 German, and 1 Welsh paper; and 16 churches, 3 of which are Welsh. Pop. in 1860, 9444.

**POTY**, a district town, and rising seaport of Russia, in the Caucasian government of Kutais, stands at the mouth of the river Rion, on the eastern shore of the Black Sea. The Rion connects the port with the interior, and since the establishment of regular steam communication by the Russian Trade and Navigation Company in this quarter, the commerce and especially the transit-trade of this town has greatly increased. The number of inhabitants is small, but is increasing.

**POUCH, MILITARY**, a stout leather box, black or brown, lined with tin, covered with a strong flap, and ornamented with the device of the regiment, serves to carry the cartridges required by a soldier for immediate use. When cartridges are supplied for a whole day's service, two pouches are worn, one on the front point of the hip, and a larger one on a belt suspended over the left shoulder.

**POUCHED RAT** (*Pseudostoma*), a genus of *Murida*, of which there are several species, natives of parts of North America west of the Mississippi, and some of them very troublesome from the ravages they commit in fields and gardens. They have four molars on each side in each jaw. The tail is short. The cheeks are furnished with pouches, to which the name refers, the openings of which are from the outside, and not from the mouth. The pouched rats burrow in the ground, and do great mischief to root-crops.

**POUGHKEEPSIE**, a city of New York, U.S., on the east bank of the Hudson River, 75 miles north of New York, finely situated on a table-land,

about 200 feet above the river. The city has broad and handsome streets, with fine public and private edifices. The collegiate school is situated on an eminence which rises 500 feet above the river, and from which a magnificent prospect, embracing an area 2500 square miles in extent, may be obtained. P. contains a city-hall, academy, law-school, lyceum, orphan asylum, 6 public schools, an endowed female college, a rural cemetery, 4 banks, extensive iron-works; carriage, chair, and carpet factories; breweries, 21 churches, and has railway and steam-boat communication with New York and Albany. P. was settled by the Dutch in 1690; during the Revolution, it was the state capital, and the Convention met here, 1788, to ratify the constitution of the United States. Pop. in 1860, 14,726.

**POULPE** (*Octopus*), a genus of *Cephalopoda* (q. v.), of the order *Dibranchiata*; having eight feet or arms, nearly equal, united at the base by a membrane, and very long in proportion to the body. There is no shell, but it is represented by two small grains of horny substance imbedded in the back, one on each side. The arms are used for swimming in water, creeping on land, and seizing prey. Poulpes swim by contractions of the muscular web of the body, which extends upon the arms. They creep on shore in a spider-like manner, with sprawling arms. Like other cephalopods, when alarmed or annoyed, they discharge an inky fluid. One species (*O. vulgaris*) is occasionally found on the British shores, and is more common on the southern shores of Europe, and elsewhere in the Mediterranean. It is the *Polypus* of the ancients. Its arms are six times as long as its body, and each furnished with 120 pairs of suckers. (See *CEPHALOPODA*).—In warmer seas, very large species occur; and although the stories related of their laying hold of and swamping boats, seizing and killing swimmers, &c., may probably be fabulous, yet it is certain that some of them have arms at least two feet long, and there is probable reason to suppose that much larger species exist, which must be powerful and dangerous creatures. A P., with its eyes fixed on its adversary, and its beak threatening to approach, must have a sufficiently formidable aspect. It was no doubt a P. which Mr Beale encountered on the shore of the Bonin Islands, which he attempted to intercept in its retreat towards the sea, and which turned and fastened upon him, laying hold of him with its arms, and trying to bite him with its parrot-like beak.—*Natural History and Fishery of the Sperm Whale*.

**POU'TIOE.** See CATAPLASM.

**POU'LTURY** (Fr. *poule*, a hen), a collective name for useful domesticated birds. It is sometimes limited to the domesticated gallinaceous birds, but its ordinary use includes all the birds reared for economical purposes. These belong exclusively to two orders of birds, the *Gallinaceous* and *Palmiped*; the common fowl, pea-fowl, Guinea-fowl, turkey, guan, and pigeon belonging to the former; and the different kinds of duck and geese, as well as the swan, to the latter. For what relates to the different species and their varieties, we refer to these heads; devoting this article to some general remarks as to the management of poultry.

In general, the rearing of poultry is regarded as a very subordinate branch of rural economy, and it is pursued chiefly where agriculture is in a somewhat primitive state, the skilful and enterprising farmer deeming it beneath his attention, or finding that he has not time to attend to it, and often looking on the feathered inmates of his farm-yard almost as a nuisance because of their invasions of his fields. It may pretty safely be asserted that there is no good

## POULTRY.

reason for this, and that poultry properly cared for would always be found a source of profit. The farm-yard affords great advantages for the keeping of poultry, and the increasing demand of the market promises a sure return. In some parts of Britain and in Ireland, where the farms are small, poultry are very extensively kept by farmers and cottagers; but the north of France and Pomerania exceed all other parts of Europe in poultry-keeping, which there is not unfrequently the leading object of husbandry, and the traffic in the products of the poultry-yard is on a truly great scale.

There is very commonly no building erected for the special accommodation of poultry; but perches and places for nests are provided for them in a cow-house or some other farm-building; or, in very many cases, when kept by cottagers, they roost on joists of the roof, within the door of the cottage itself. In such cases, they roam at liberty during the whole day, and find much of their food in the fields and on the road sides, although the feeding of them with corn and other food is not neglected by the careful housewife. But it is often undesirable, for the sake of fields or gardens, that so much liberty should be allowed to poultry, and they may be very advantageously kept either wholly or mostly in confinement. If circumstances permit, it is good for them to be let out for an hour or two daily into a grass field, but it is not necessary, if they are provided with a warm, clean, and well-ventilated house, to which a spacious open court is attached, and are regularly supplied with abundance of food, water, sand, or fine ashes, lime, and small stones, all requisites to their healthful existence. The food must also be of various kinds. Poultry must have supplies of grain or pulse, and of soft food made of the meal of grain or pulse; the kind may depend upon convenience and cheapness; and instead of such food, boiled potatoes may to some extent be used. Bran is a very good article of food for poultry. But the same food, without variation, should not be given for any considerable time. And it is indispensable that all kinds of poultry be frequently, if not even daily, supplied with green food, as blades of kale, cabbage, cauliflower, turnips, &c., or lettuces, cresses, chickweed, sow-thistle, &c. It is pretty safe to observe the kinds which they like, and to allow them to choose for themselves. When they have no opportunity of seeking worms, snails, slugs, and insects for themselves, animal food must be given, and the refuse of the kitchen cannot be more profitably employed. It is possible at some seasons to give too much food, making the poultry too fat, and diminishing the production of eggs; but at other times, as during the season of moulting, food cannot be given too plentifully. Water must at all times be abundantly supplied.

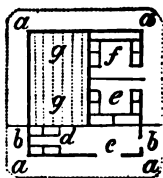

Fig. 1.—Plan of Poultry-house: aa, the court-yard; bb, for ducks and geese, the apartment for which is at c, with laying and hatching-nests; d, the roosting-house for hens and turkeys; e, the hatching-house; and f, the apartment for laying.

other material, ought to be so firm and hard as to admit of its being easily swept, and this should be oft-a-écne. The house is provided with roosting

places on the ground or above it, according to the kind of poultry, and with nests for laying in. Hatching ought to be conducted in a separate place. The court should be furnished with a 'lean-to' shed on one side, under which the birds may find shelter from sun or rain, and here they should find sand or fine ashes to fling over themselves, according to their manner, to rid themselves of insect tormentors. Lime is also necessary for them, large quantities of it being used to make eggshells, besides what the animal system otherwise requires. It may be very conveniently supplied in the form of lime rubbish from old walls, in which also occur in abundance such small stones as birds need in order to the trituration of the food in their gizzard.

In the places appropriated to hatching, it is good to have a fresh turf deposited, to prevent the eggs from becoming too dry, and it is even recommended that the eggs should be slightly moistened every day. It is said that the inner membrane of the egg is otherwise apt to become hard, so that the young chick cannot break through it.

Where purity of breed is of importance, as when fowls are to be exhibited in prize competitions,

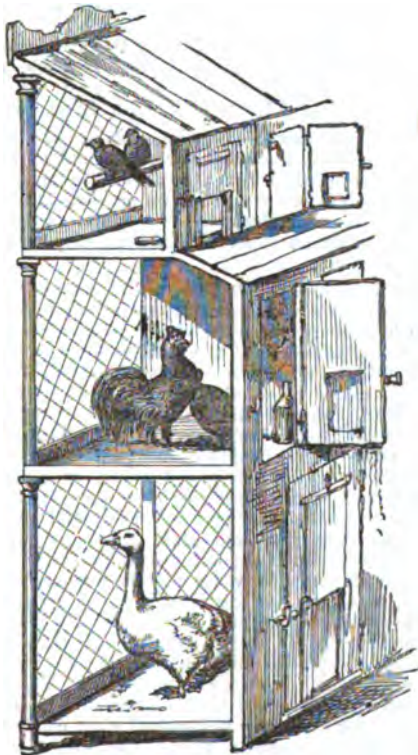

Fig. 2.—Poultry-pen.

great care must be taken to keep the different kinds perfectly separate; otherwise, intermixture to a certain extent is not undesirable. It is always, indeed, to be desired that each good kind be kept pure and in as great perfection as possible, for improvement of the stock. But even in a small poultry-house, it is desirable to have different kinds, some being particularly estimable for their flesh, some for their abundance and quality of their eggs, some for their disposition to incubate, &c. For web-footed birds, free access to water is required; but some of the

kinds are well enough provided by a pretty capacious trough.

Among the diseases of poultry, *Gapes* (q. v.) is one which very frequently demands attention, particularly in young chickens. *Pip* (q. v.) or *Roup* is another. Some of the maladies which cut off great numbers of young chickens, and still more of turkey-poults, may be in a great measure prevented by supplying abundance of nourishing and sufficiently varied food, with water and lime; and by preventing the young birds, particularly turkeys, from getting among wet grass.

It is sometimes taken for granted by writers on this subject, that all the birds which can be domesticated with advantage, have already been domesticated. The assumption is quite gratuitous, and it might as well be asserted that improvement has reached its utmost in any other direction. The concurrent supposition that the common domesticated kinds were given to man at first as domestic, is likewise unsupported by evidence, although the domestication of some of our poultry birds must be referred to a very early date. Among the *Anatides*, some progress has recently been made in the domestication of new kinds; and a beginning may even be said to have been made as to some additional gallinaceous birds.

Much valuable information on the management of poultry will be found in *The Henwife, Her own Experience in her own Poultry-yard*, by Mrs Fergusson Blair of Balthayock (Edin. 2d ed. 1861).

POUNCE, powdered rosin, or some gum resin such as mastic, sandarach, or copal, and also the powder of cuttle-fish bones. It is used for sprinkling over freshly-written writing, to prevent blotting; fine sand is often substituted for pounce. Blotting-paper has almost superseded the use of pounce in Great Britain.

POUND, in English Law, means an enclosure, of which there was generally one in every parish, or at least every manor, in which stray cattle were put and detained until the damage done by them was paid for. Whenever a stranger's or neighbour's cattle trespass on another's lands, the latter can seize them, and take them to the pound, or impound them, as it is called, *damage feasant*, and can keep them there till the expenses are repaid. There was a distinction between pound overt, or common pound, and pound covert, or close pound; in the former case, the owner of the beasts could go and feed and water his cattle while impounded, and it was his duty to do so; but not in the latter case. Now, it is compulsory for the impounder, in all cases, to supply the cattle with food, otherwise he incurs a penalty; and if impounded cattle are not sufficiently fed, a stranger who feeds them may not only trespass on lands to do so, but can recover the costs from the owner of the beasts. This was formerly an important head of law, and it is not obsolete, for the power to impound stray cattle still exists, though common pounds are disappearing, for, in point of law, they are not necessary, since the impounder can put the cattle in his own stable or field.

POUND (Sax. *pund*, Ger. *pfund*, Lat. *pondus*, 'weight') the unit of weight in the western and central states of Europe, differing, however, in value in all of them. The symbol (*lb.*), for it is equally general, and is derived from the Latin word *libra*. The old English pound, which is said to have been the standard of weight from the time of William the Conqueror till that of Henry VII., was derived from the weight of 7680 grains of wheat, all taken from the middle of the ear, and well dried. After this time, the troy pound, which was heavier by

1/4th than the old English pound, became the standard, but it was divided into only 5760 grains. Henry VIII. introduced the *avoirdupois* pound for weighing butcher meat in the market, and it gradually came to be used for all coarse goods in frequent demand; it contained 7000 troy grains. The troy and *avoirdupois* pounds, both legal measures, continued in regular use from this period—the former being gradually appropriated by jewellers and apothecaries; and, to prevent variation, a brass weight of one pound troy was constructed in 1758, and placed in charge of the clerk of the House of Commons. This weight, in 1824, was declared by act of parliament to be 'the original and genuine standard measure of weight,' and that from which the value of the ounce, grain, pound *avoirdupois*, &c. were to be deduced, but being, along with the standards of measure, destroyed in 1834, a commission was appointed to consider the best means of replacing them. After long deliberation, hearing of evidence, and sifting of suggestions, it was agreed, *inter alia*, that the standard of weight should be a piece of platinum, weighing 7000 grains (an *avoirdupois* pound), but that this piece should not be defined with reference to any natural standard. The troy pound thus ceased to be the standard, but its use was allowed to jewellers and (differently divided and subdivided) to apothecaries.

The pound-weight of silver, a common money standard among the ancient Romans, was introduced by them into the countries they conquered, and thus the term 'pound' became a designation of a certain amount of coined money. Thus, now-a-days, the English pound is considered as something (a coin or otherwise) equivalent to 20 shillings, but originally it denoted the pound of silver which was coined into 20 shillings. From Edward II.'s time, the coins were more and more diminished in size, that monarch coining 25 shillings from a pound of silver; while from the same weight of bullion his various successors coined 30, 45, 48, 96, 144, 288, in the time of Elizabeth 60, and (during the reigns of her successors) 62 shillings. George I. coined 66 shillings to the pound of silver, and this rate still continues, the term 'pound' having been completely severed from its original meaning, and appropriated to signify 20 shillings of the present coinage.

POUNDER, the term used in describing the force of a cannon employed in firing solid shot, as a '9-pounder field gun,' a '300-pounder Armstrong,' &c. See CALIBRE.

POUSSIN, NICOLAS, a painter of great celebrity, born near Le Grand-Andely, in Normandy, in 1593 or 1594, was first a pupil of Quintin Varin, then painting pictures for the church of Grand-Andely, but at the age of 18 went to Paris, studied under Ferdinand Elle, the Fleming, Lallemand, and others; but chiefly improved himself by drawing from casts, and drawings and prints after Raphael and Julio Romano, in the collection of M. Courtois, who accorded him access to them. After a long and hard struggle, he attained the object of his desire—namely, the means of visiting Rome. He was 30 years of age when he arrived there, and a considerable period elapsed after that before he obtained much employment. At length, however, he received several important commissions from the Cardinal Barberini, which he executed so successfully, that he afterwards rapidly acquired fame and fortune. After an absence of sixteen years, he returned to Paris with M. de Chantelou, and was introduced by Cardinal Richelieu to Louis XIII., who appointed him his painter in ordinary,

with apartments in the Tuileries, and a salary of £120 a year. P. returned to Rome for the purpose of giving up his establishment there, and taking his wife to Paris; but, while he was occupied with these arrangements, Louis XIII. having died, he gave up all thoughts of returning to his native country, remained in Rome, and after a very successful career, died in 1666. His reputation mainly rests on his success in aiming at the classic style. Sir Joshua Reynolds says: 'No works of any modern have so much the air of antique painting as those of Poussin.' Many prefer his landscapes, or those pictures of his in which the landscape predominates, to his compositions in which his attention has been bestowed chiefly on the figures. Upwards of 200 prints have been engraved from his works. The National Gallery has several of P.'s pictures, two of which are particularly praised, 'A Bacchanalian Dance,' and 'A Bacchanalian Festival.'

POUSSIN, GASPARD, a celebrated landscape painter, was the son of a Frenchman, settled in Rome, and was born there in 1613. He was the pupil of Nicolas Poussin, who had married his sister, and from respect to that great artist, adopted his name in place of his own, which was Dughet. He was called by the Italians Gasparo Duche, and he inscribed his etchings, eight in number, in that way. His landscapes are composed in general from studies in the Campagna of Rome and surrounding country, worked out with the feeling of a mind deeply imbued with classical associations, and tending towards melancholy reflection, by contrasting the glory of the past with the decadence of the present—ideas entirely the opposite of those of Claude, who, trusting to the never-fading beauty of nature, endeavoured, from the scenery and architectural remains in Italy, to realise the classic age in all its glory. The National Gallery possesses six specimens of P., some of them being reckoned masterpieces, as the 'Sacrifice of Isaac,' a 'Land Storm,' and an 'Italian Landscape with a View of a Town.' P. died in Rome 1675.

POW'AN (*Coregonus* [q. v.] *Cepedes*), a fish found in Loch Lomond, Scotland, and often called *Fresh-water Herring*. It is not found in any other British lake or river, and has not yet been identified with any fish of the continent of Europe, although probably it is to be found in some of the Scandinavian lakes. It resembles the Pollan (q. v.) of the Irish lakes, but is readily distinguished. The P. sometimes attains the length of sixteen inches. Great shoals are seen in Loch Lomond, rippling the surface of the water, and approaching the shores in the mornings and evenings. They are never seen in the middle of the day. The P. is highly esteemed for the table; and is in best condition in August and September. It is generally caught by nets.

POWDERED, or SEMÉE, in Heraldry, strewn with an indefinite number of small charges.

POWELL, THE REV. BADEN, an eminent English savant, son of a London merchant, was born at Stamford Hill, near London, 22d August 1798, and studied at Oriel College, Oxford, where he graduated M. A., with first-class mathematical honours, in 1817. P. took holy orders in 1820, and was appointed vicar of Plumstead, in Kent, in 1821. In 1824, he was elected a Fellow of the Royal Society; and three years later, was appointed Savilian Professor of Geometry, a chair which he held till his death, which took place in London, June 11, 1860. As a professor, his great aim was to bring about a larger recognition of the importance of physical and mathematical science, in the curriculum of learned study at Oxford, and his efforts have not been altogether in vain. To the 'Philosophical

Transactions,' the 'Reports' of the British Association, and other vehicles of scientific instruction, he contributed numerous valuable papers; but is perhaps best known by his strenuous exertions to obtain for modern science the right of modifying the views of nature and the origin of the world, expounded or thought to be expounded in the Jewish Scriptures. In this perilous department of controversy P. displayed great learning, logical power, moderation of tone, and philosophic urbanity; but his conclusions were too unmistakably rationalistic to be palatable to the orthodox. Among his works may be mentioned *A Short Elementary Treatise on Experimental and Mathematical Optics, Designed for the Use of Students* (Oxford, 1833); *Revelation and Science* (Oxford, 1833); *A Historical View of the Progress of the Physical and Mathematical Sciences* (Lond. 1834); *The Connection of Natural and Divine Truth* (Lond. 1838); *Tradition Unveiled; a Candid Inquiry into the Tendency of the Doctrines advocated in the Oxford Tracts; A General and Elementary View of the Undulatory Theory as applied to the Dispersion of Light, &c.* (Lond. 1841); *Essays on the Spirit of the Inductive Philosophy, &c.* (Lond. 1855); *Christianity without Judaism* (1857); *The Order of Nature considered with Reference to the Claims of Revelation* (1859); and *On the Study and Evidences of Christianity in Essays and Reviews* (1860).

POWER, in point of law, means an authority given to some person who would otherwise not be entitled to do the specific thing empowered. Thus an authority given to an agent to act for another is called a power of attorney; and there are numerous examples of powers contained in marriage settlements, wills, and miscellaneous deeds, which authorise one of the parties to do something in certain contingencies. Thus a power of revocation is often reserved to a party to revoke a will or deed. There is a power of appointment given to a married woman or widow to bequeath or divide certain property in certain events among her children. So a power to charge or jointure an estate, and to secure the portions of children. There are many nice and difficult rules of law applicable to matters connected with and arising out of powers. A power is created by a deed or will; and it is said to be executed when it is carried out. In Scotland, powers are generally called *Faculties* (q. v.).

POWERS, HIRAM, American sculptor, son of a farmer, and the eighth of nine children, was born at Woodstock, Vermont, July 29, 1805, and acquired the rudiments of education at a free district-school. While still a boy, he went to Cincinnati, Ohio, where he became an apprentice to a clockmaker, and about the same time formed the acquaintance of a German sculptor, who taught him to model in plaster. Subsequently, he was employed for several years making wax-figures and fitting them with machinery, for the Cincinnati museum, where his 'Infernal Regions' horrified thousands of visitors. In 1835, he went to Washington, where he executed the busts of several distinguished persons; and, with the aid of Mr Nicholas Longworth, in 1837 went to Italy to study his art, since when he has resided in Florence. In 1838, he produced his statue of 'Eve,' which excited the admiration of Thorwaldsen; and in 1839, the still more popular 'Greek Slave,' of which six copies in marble, with cast copies innumerable, were produced. Of his 'Fisher Boy,' three copies were ordered. Among his other works the chief have been 'Proserpine,' 'Il Penseroso,' 'California,' 'America' (the last for the Crystal Palace,

Sydenham); statues of Washington for the state of Louisiana, of Calhoun for South Carolina, and Webster for Boston; and busts of Adams, Jackson, Marshall, Van Buren, and other distinguished Americans.

POYNTELL, pavement or tiles laid in small lozenge form.

POZZO DI BORGO, CARLO ANDREA, a celebrated Russian diplomatist, was born at Alala in Corsica, March 8th, 1768, and was educated at the university of Pisa. Returning to Corsica, he adopted the profession of advocate, in which he soon became distinguished for his acuteness, ingenuity, and brilliant eloquence; and about this time an intimacy sprung up between him and the two young Bonapartes, Napoleon (L.) and Joseph. P.'s great ability soon gained for him the esteem of Paoli (q. v.), who made him the confidant of his plans, to the intense disgust of the Bonaparte family, who considered themselves slighted. A coolness in consequence sprung up between P. and young Napoleon, which, as their paths in life diverged more and more, passed through the various grades of antagonism, dislike, distrust, and hatred, till, when the latter swayed the sceptre of France, and the former became the supreme trusted adviser of Russia and Austria, it culminated in a deadly struggle for victory between the diplomatist and the warrior, to be ended only by the death of one or the destruction of his power. P. represented Corsica in the French National Assembly (1791—1792); but his party, that which wished to unite liberty and hereditary rule, being overpowered by their 'radical' opponents, he was compelled to return to Corsica, where he again attached himself to Paoli's party; and on the failure of that chief's plans, retired to London. Here he became the agent of the French refugees; and in 1798, having now thoroughly broken with the Bonapartes, he went to Vienna to promote an alliance of Austria and Russia against France, and accompanied the Russian army in the subsequent campaign of 1799. In 1803, he entered the Russian service as a councillor of state, from this time devoting his whole attention to diplomacy. He was at the bottom of the Russo-Austrian alliance, which was dissolved by the battle of Austerlitz (1805); but after the treaty of Tilsit, fearing lest Napoleon might insist upon his surrender, he retired to Austria, from which country Napoleon, in 1809, demanded his extradition. The Emperor Francis refused, but P., to save trouble, retired to England (1810), where he stayed for some time; and then returned to Russia. He soon after induced the Emperor Alexander to make certain custom-house regulations which offended Napoleon, and were a chief cause of the rupture which resulted in the campaign of 1812; he also suggested to the emperor, and effected the seduction of Murat, Bernadotte, and Moreau from the Napoleonic cause; and after the victorious allies had driven Napoleon across the Rhine, P., at the congress of Frankfurt-on-the-Main, drew up his famous declaration, 'that the allies made war not on France, but on Napoleon.' From this time, his whole energies were devoted to the task of keeping Alexander inflexible with regard to Napoleon's seductive offers of accommodation; but after his old antagonist's downfall, he exerted himself with equal vigour at Paris (where he signed the treaty of 1815 as Russian ambassador) and Aix-la-Chapelle (1818) to ameliorate, as much as possible, the hard conditions imposed upon France. After the accession of the Emperor Nicholas, he was, though highly esteemed, less confided in, and accordingly accepted the post of Russian ambassador in London; but retired from

public life in 1839, and settled in Paris, where he died 15th February 1842.

POZZUO'LI, a city of Southern Italy, at the east of the bay of Naples, with 14,752 inhabitants; it gives name to a sub-prefecture, and has manufactures of soap. But the interest which attaches to it is drawn from its numerous memorials of classic age. Its cathedral was the Temple of Augustus. There is the Temple of Serapis, an Egyptian god, who was invoked by the priests to render the mineral waters of the place efficacious as remedies. The interior of the temple had a portico of 24 pillars, surrounded by 70 chambers for the sick and for the priests. In the harbour there may still be seen 13 pillars, which formerly supported as many arcades, under which the inhabitants used to congregate to watch for the vessels coming from Africa. There is an arch erected to Antoninus Pius, for having restored 20 of those pillars. There are the remains of an amphitheatre which might have contained 25,000 spectators. The Solfatara (*Forum Vulcani*) is a half-extinct volcano near P., from which springs saline water, used as a remedy for cutaneous diseases. Near the Montenuovo there is the famous Lago d'Averno, enclosed among hills; and at a short distance from it there is the Sibyl's Cave (*La Grotta della Sibilla*), which, however, is nothing more than a subterranean passage from Baja to Averno. On a plain there is an extinct volcano; there Cumæ once stood, now all in ruins. In the environs of P. are to be seen the promontory of Posilipo, the Elysian Fields (*Campi Etrusci*) near the harbour of Miseno, and the Lake of Agnano, formerly the crater of a volcano.

P. was probably built by the Cumani (Greek colonists of Cumæ), who gave to its gulf the name of *Cumanus*. They called the new port *De Caerchia*, a name which was afterwards changed to *Puteoli*, in allusion perhaps to the sulphur wells or springs (*putei*) with which it abounded. Puteoli is first mentioned in history during the Second Punic War, when, by order of the senate, it was surrounded by strong walls. In 214 B. C. it repulsed Hannibal, and from this period rose in importance until, towards the close of the republic, it became virtually the port of Rome, and during the empire was really the first emporium of commerce in Italy. Puteoli was destroyed by Alaric, Genseric, and Totila, and though rebuilt by the Byzantine Greeks, it was exposed to new devastations, to earthquakes, and volcanic eruptions, and soon sank into the decay which continues to mark it.

PRACTICE, in Arithmetic, is the name given to a method, or rather a system of expedients, for shortening or avoiding the operation of compound multiplication. The nature of the expedients will be best understood by an example: Suppose that the price of 64,875 articles at £2, 17s. 6d. is required. It is obvious that the price, at £1, would be £64,875; therefore, at £2, it is £129,750; at 10s., it is the half of that at £1, viz., £32,437, 10s.; at 5s., the half of this last sum, or £16,218, 15s.; and at 2s. 6d., the half of this, or £8109, 7s. 6d. The sum of these partial prices give the whole price—thus,

	£	s.	d.		£	s.	d.
Price at 2 0 0	129	750	0 0		129	750	0 0
" " 0 10 0	32	437	10 0	(= ½ of £1),	32	437	10 0
" " 0 5 0	16	218	15 0	(= ¼ of £1),	16	218	15 0
" " 0 2 6	8	109	7 6	(= ⅕ of £1),	8	109	7 6
" " 2 17 6	129	750	0 0		129	750	0 0
					166	615	13 6

The general principle of the method is to decompose the lower denominations of the compound factor into aliquot parts of the higher unit. A

still simpler way with the above example is the following :

Price at	£	s.	d.	
"	3	0	0	
"	0	2	6	(= $\frac{1}{2}$ of £1)
"	2	17	6	

£	s.	d.
194625	0	0
8109	7	6
195434	17	6

PRÆFECT, a common name applicable to various Roman functionaries. The most important was the *Præfectus urbi*, or warden of the city, whose office existed at an early period of Roman history, but was revived under Augustus, with new and greatly altered and extended authority, including the whole powers necessary for the maintenance of peace and order in the city, and an extensive jurisdiction civil and criminal. The *Præfectus prætorio* was the commander of the troops that guarded the emperor's person.

PRÆMUNIRÉ, the name given, in English Law, to a species of offence of the nature of a contempt against the sovereign and his government, and punishable with forfeiture and imprisonment. The name is derived from the first words (*præmunire* or *præmonere facias*) of a writ originally introduced for the purpose of repressing papal encroachments on the power of the crown. The first statute of præmunire was passed in the reign of Edward I. The attacks of the popes on the rights of private patrons, by bestowing bishoprics, abbacies, &c., on favourites before they were void, were the immediate cause of various subsequent statutes of præmunire, which made it penal to endeavour to enforce the authority of papal bulls and provisions in England. By later statutes, a number of offences of a miscellaneous description have been rendered liable to the penalties of a præmunire, as (by 6 Anne c. 7) the asserting by preaching, teaching, or advisedly speaking, that any person, other than according to the Acts of Settlement and Union, has any right to the throne of these kingdoms, or that the sovereign and parliament cannot make laws to limit the descent of the crown. The knowingly and wilfully solemnising, assisting, or being present at any marriage forbidden by the Royal Marriage Act, is declared by 12 Geo. III. c. 11 to infer a præmunire.

PRÆNESTĒ. See PALESTRINA.

PRÆTOR (probably a contraction for *prætor*, from *præ-co*, to precede, also to order) was, among the ancient Romans, the title given to the consuls as leaders of the armies of the state; but it was specially employed to designate a magistrate whose powers were scarcely inferior to those of a consul. The prætorship, in this specific sense of the term, was first instituted in 366 B. C., as a compensation to the patricians for being obliged to share with the plebeians the honours of consulship. It was virtually a third consulship; the prætor was entitled *collega consulibus*; he was elected by the same auspices and at the same comitia. For nearly 30 years, patricians alone were eligible for the office; but, in 337 B. C., the plebeians made good their right to it also. The prætor's functions were chiefly judicial. Though he sometimes commanded armies, and, in the absence of the consuls, exercised consular authority within the city, yet his principal business was the administration of justice both in matters civil and criminal; and 'to the edicts of successive prætors,' says Mr G. Long, 'the Roman law owes, in a great degree, its development and improvement.' Originally, there was only one prætor; but as the city and state increased, and their relations with other nations became more complicated, others were added. In 246 B. C., a second prætor was appointed, to settle disputes

that might arise between Romans and foreigners temporarily resident at Rome, for trading or other purposes, hence called *prætor peregrinus* (foreign prætor), to distinguish him from the original *prætor urbanus* (city prætor). In 227 B. C., two new prætors were appointed, to administrate affairs in Sicily and Sardinia; and in 197 B. C., two more for the Spanish provinces, or six in all. Sulla increased the number to eight, and Julius Cæsar to sixteen. Augustus reduced the number to twelve; but at a later period we read of eighteen, if not more. The city-prætorships were reckoned the highest; and after a person had filled these offices, he sometimes received the administration of a province with the title of *proprætor* or *proconsul*.

PRÆTORIAN BANDS (Lat. *Prætorias Cohortes*, and *Prætoriani*) the name given, more particularly during the period of the Roman empire, to a body of soldiers, organised for the purpose of protecting the person and maintaining the power of the emperors. We indeed read of a *prætorias cohors*, or select guard of the most valiant soldiers attached to the person of Scipio Africanus, who, according to Festus, received six-fold pay, and the exigencies of the civil wars naturally increased their number, but it was to Augustus that the institution of them as a separate force is owing. He formed nine or ten cohorts, each consisting of a thousand men (horse and foot), but kept only three of them in Rome, the rest being dispersed in cities not far off. Tiberius, however, assembled the nine cohorts at the capital in a permanent camp, and Vitellius increased their number to sixteen. The Prætorians served at first for twelve, and afterwards for sixteen years; they received double pay; the privates were held equal in rank to the centurions in the regular army, and on their retirement each received 20,000 sesterces. They soon acquired a dangerous power, which they exercised in the most unscrupulous manner, deposing and elevating emperors at their pleasure. Aspirants for the imperial dignity found it advisable, and even necessary, to bribe them largely; while those who acquired that dignity without their assistance were accustomed on their accession to purchase their favour by liberal donations. The Prætorians, however, had no political or ambitious views; they were simply an insolent and rapacious soldiery, fond of substantial gratifications, and careless how they got them. After the death of Pertinax (193 A. D.), they actually sold 'the purple' for a sum of money to Didius Julianus; but in the same year their peculiar organisation was entirely broken up by Severus, who formed new cohorts altogether out of the best legions serving on the frontiers, which he increased to four times the number of the old. After several other changes, they were entirely abolished by Constantine (312 A. D.), who dispersed them among his regular legions.

PRA'GA. See WARSAW.

PRAGMATIC SANCTION, or RESCRIPT, a solemn ordinance or decree of the head of a legislature relating either to church or state affairs. The term originated in the Byzantine empire, and signified a public and solemn decree by a prince, as distinguished from the simple rescript, which was a declaration of law in answer to a question propounded by an individual. This name is given to several important treaties, of which the principal are: 1. An ordinance of Charles VII. of France, in which the rights of the Gallican Church were asserted in opposition to the usurpation of the pope in the appointment of bishops. Twenty years later, Louis XI., in order to please Pope Pius II., was induced to give up this P. S., which was ignominiously



dragged through the streets of Rome; but at a subsequent date, a quarrel having arisen between Louis and the pope, the P. S. was re-acted. 2. The instrument which settled the empire of Germany in the House of Austria (1439 A. D.). 3. The ordinance by which Charles VI., Emperor of Germany, having no male issue, settled his dominions on his daughter, the Archduchess Maria Theresa, which was confirmed by the diet of the empire, and guaranteed by Great Britain, France, the States General, and most of the European powers. 4. The settlement of the succession of the kingdom of Naples, which was ceded by Charles II. of Spain, in 1759, to his third son and his descendants.

**PRAGUE** (Ger. *Prag*, Slav. *Praha*), capital of the kingdom of Bohemia, is situated in 50° 5' N. lat., and 14° 30' E. long., on the slope of the hills which skirt both sides of the river Moldau, 251 miles north-east of Vienna by railway. Pop. in 1857, 142,588. P., which ranks as the third city of Germany, presents a highly picturesque appearance from the beauty of its site, and the numerous lofty towers (upwards of 70 in number) which rise above the many noble palaces, public buildings, and bridges of the city. It consists of four principal parts: 1. The Kleinseite, chiefly occupied by the public offices, and the residences of the officials; 2. The Hradachin (or palace district), surmounted by the vast imperial castle, and containing some of the most ancient and interesting churches and palaces of P.; 3. The Jews' Quarter, now known as the Josephstadt, which forms the chief business-quarter, and contains numerous churches, ecclesiastical and educational establishments; 4. The 'New Town,' containing the largest number of streets and open squares, with many modern palaces, charitable institutions, and places of public resort. P. is surrounded by walls and bastions, and has eight gates. The citadel, the ancient residence of the old dukes of Bohemia, is well fortified, and from its elevated position above the Moldau, thoroughly commands the city. P. has 55 Catholic, and 3 Protestant churches, 15 monasteries, and 10 synagogues. Among the most noteworthy of these are the Metropolitan, or St Veita, with its lofty tower, a fine but unfinished specimen of the Gothic of the 14th c., containing the remains of St Ludmilla, first duchess of Bohemia, and of seven kings and emperors of Germany, with the grave of St Wenzlaus, and the silver sarcophagus of St Nepomuk (see St JOHN or NEPOMUK), a popular saint of Bohemia; St Nicolas, or the church of the Jesuits, with its many towers and costly decorations; the Thein Church, built in 1407; the old Hussite church, with the grave of Tycho Brahe, and its marble monuments of the Slavonic martyrs, Cyril and Methodius. Among the numerous public and other buildings of note in P., the following are some of the more interesting: the Royal Palace, the Cathedral, the Theresa Institution for Ladies, the ancient Byzantine church of St George, the Hradachin Square, with the imposing palaces of the primate, the ex-emperor, and Prince Schwarzenberg; the Loretto Chapel, with its gorgeously bejewelled church vessels; the vast Czerni Palace, now used as an institution of charity; the Picture Gallery; the Praemonstratentian monastery of Strahow; the royal library; and at the summit of the Laurenzberg, the restored Church of St Lawrence. P. has, however, numerous public gardens and walks in the suburbs, which, with the several royal and noble parks open to the public in the vicinity of the city, afford varied resources for health and open air recreations. The suburb of Karolinenthal, which is traversed by the great viaduct

of the railway, and is of modern growth, has some fine buildings, numerous gardens, barracks, and manufacturing establishments; and somewhat further north is the great botanical garden, with the neighbouring public walks on the Moldau. The university, which is the most ancient in Germany, having been founded in 1348, enjoyed the greatest celebrity in the 15th c., when many thousand scholars came from foreign countries to study in its halls. It is now in a state of activity, after a prolonged period of decay, and has good medical and surgical schools; a library containing, in 1851, 109,880 volumes, and 7762 manuscripts, of which some are very rare; a fine observatory; museums of zoology and anatomy; a botanical garden, &c. P. has also 1 polytechnic, 3 gymnasia, Bohemian and German training schools, and about 20 parish schools. The manufactures include leather, cotton, and linen goods, stockings, printed cottons, machinery of various kinds, beet-root sugar, &c. P. is the great centre of the commerce of Bohemia, and the seat of an important transit trade.

*History.*—According to popular tradition, P. was founded in 722 by the Duchess Libussa. In the 13th c., its importance was fully recognised; in the 14th and 15th centuries, its munificently endowed university brought foreigners to it from every part, until the decision of the Emperor Wenzlaus to favour Bohemian students more than others drove thousands of the scholars with their professors to other spots, and led to the foundation of universities at Leipzig, Ingolstadt, Rostock, and Cracow. In 1424, P. was conquered, and almost destroyed by the Hussites, who had made a successful stand against the emperor Sigmund's army; but after the subsequent defeat and submission of the insurgents, the city was rebuilt. In the Thirty Years' War, it suffered severely, and in 1620 the battle was fought at the White Mountain, near the city, in which the Elector-Palatine, Frederick V., known as the Winter King, and son-in-law of James I. of England, was completely defeated, and compelled to renounce his assumed crown, and to give up the town into the power of the emperor. Swedes and Imperialists successively gained possession of it during the war; and a century later, during the Seven Years' War, it again fell into the hands of different victors, having been compelled, in 1744, to capitulate to Frederick the Great of Prussia; and until the war of deliverance in Germany, and the downfall of Napoleon, the city continued to suffer more or less directly from the troubles in which the house of Austria had been involved. During the last fifty years, it has, however, made rapid strides, and enjoyed prosperity and quiet, except in 1848, when the meeting of the Slavonic Congress within its walls called forth such strongly marked democratic demonstrations on the part of the supporters of Panlavism (q. v.), that the Austrian government dissolved the convocation, and restored quiet by the summary method of causing the old and new town to be bombarded for two days.

**PRAIA GRANDE.** See RIO DE JANEIRO, PROVINCE.

**PRAIRIE** (Fr. meadow) was the name given, by the early French explorers of the northern portion of the Mississippi Valley, North America, to the vast fertile plains which extend from Western Ohio and Southern Michigan, across the states of Indiana, Illinois, Missouri, Arkansas, Iowa, Kansas, and Nebraska and Dakota Territories, including the southern portions of Wisconsin and Minnesota. These great plains or savannas are sometimes flat, but oftener rolling like the long swells of the ocean,

and rise in gradual elevation from 300 to 1500 feet above the level of the sea. They are drained by numerous rivers, branches of the Ohio, Mississippi, and Missouri, or emptying into Lake Michigan, whose channels seem to have been worn to the depth of 50 to 300 feet, with vertical walls or bluffs of limestone, sandstone, displaying in some places banks of clay, sand, and loam, 200 feet in thickness. Beneath the prairies north-west of the Ohio are extensive coal-fields, with deposits of iron, lead, &c. The soil is finely comminuted, rich, and extremely fertile, varying in thickness from one or two feet, to the bottom-lands on the borders of the rivers, which are of great depth and inexhaustible fertility. These plains are destitute of trees, except in isolated groves, a few rocky ridges, and the borders of streams. They are covered with fine grasses, and brilliant flowers of various species of the helianthoid *Compositæ*. Water is found from 15 to 30 feet below the surface. These great prairies, covering an area of about 400,000 square miles, formerly fed vast herds of buffalo, deer, wild turkeys, prairie-hens or grouse, prairie-dog, squirrel, &c. In the autumn, the dried grasses, fired by the Indians, converted them into seas of flame. The lack of timber is attributed by some to the fineness of the soil. Remains of ancient mounds, fortifications, and cities shew that they were, at some distant period, inhabited by a more civilized race than the Indians found by European discoverers. These great rolling plains, or natural pastures, with only the labour of ploughing, produce large crops of wheat and maize, and, penetrated by navigable rivers, and crossed by cheaply built railways, they form one of the most easily cultivated and prolific regions of the world, and are capable of sustaining immense populations.

**PRAIRIE DOG** (*Arctomys Ludovicianus*), a very interesting species of Marmot (q. v.), an inhabitant of some of the western Prairies (q. v.) of North America. It is about the size of a squirrel or large rat; and has soft, reddish-gray fur, each hair being



Prairie Dog (*Arctomys Ludovicianus*).

red, with a white tip. The name P. D. seems to have been given to it from its frequent utterance of a sound somewhat like the bark of a very young puppy. For the same reason, it is also called the Barking Squirrel. A more correct name would be Barking Marmot, or Prairie Marmot. The P. D. does not inhabit the rich grass-covered prairies where the buffalo (bison) abounds; but those which, from want of water, exhibit a comparatively scanty vegetation; and in these it is to be found in vast numbers, being gregarious in its habits, burrowing in the ground, and throwing up mounds of earth, on

the summit of which the little creature often sits as if on watch. The whole extent of a great level prairie is often covered with these hillocks. 'Their number is incredible,' says the Honourable C. A. Murray, in his *Travels in North America*, 'and their cities, for they deserve no less a name, full of activity and bustle.' As soon as the hand is raised to a weapon or missile, they pop into their holes, with amazing rapidity, and then wheel round and look out at the enemy. Still more interesting is the frequent association of the P. D. with the burrowing owl and the rattlesnake in the same burrow; an association which has been variously described as one of strange friendship among very different creatures, in a state of nature; and as of the most opposite character, the owl and the rattlesnake being supposed to prey upon the P. D. and its young. But in so far as the owl is concerned, this is rendered very doubtful by the fact, that its *casts* seem to shew its food to consist entirely of insects. It probably finds the burrows of the marmots its only convenient retreat, and their proper inmates harmless neighbours.

**PRAIRIE HEN.** See GROUSE.

**PRAJĀPATI** (from *prajā*, creation, created beings; and *patī*, lord) is, in Hindu Mythology, a name of the god Brahmā, but also a name of those divine personages who, produced by Brahmā, created all existing beings, inclusive of gods, demons, and natural phenomena. Manu knows of ten such *Prajāpatīs* engendered, through pure meditation, by the god Brahmā—viz, Marichi, Atri, Angiras, Pulastya, Pulaha, Kratu, Prachetas or Daksha, Vasistha, Bhṛigu, and Nārada. The Mahābhārata, however, leaves out Daksha, Bhṛigu, and Nārada; and other varieties occur in the different Purāṇas. Whereas, also, these 'lords of creation,' in conformity with Manu, are in some of these works looked upon as the mind-born sons of Brahmā, some Purāṇas derive them from different parts of Brahmā's body. The only interesting point in this theory of the *Prajāpatīs* is the assumption, that the world did not immediately proceed from Brahmā, the highest god, but through the intermediate agency of beings which thus stand between him and creation.

**PRAJNĀ PĀRAMITĀ** (literally, the wisdom which has gone to the other shore, viz., of its object; i. e., absolute or transcendental wisdom, from the Sanscrit *prajñā*, wisdom, *pāram*, to the other shore, and *itā*, gone) is the title of the principal Sūtra (q. v.) of the Mahāyāna school of the Buddhists (see BUDDHISM). Its main object is metaphysical; but the commencement of the work is merely a eulogy of Buddha, and of the Bodhisattvas, who form his retinue. Other parts of it contain incidental narratives of wonderful phenomena connected with the apparition of Buddhist saints, or a description of the benefits arising from an observance of the Buddhistic doctrine, or verses in which the Buddha is praised by his disciples, and similar irrelevant matter. It is probably on account of the extent which could easily be imparted to such episodic topics, but also by amplifying the real substance of the work, that several recensions of the P. are in existence, both with the Buddhists and Tibetans (see LAMAISM); some of these do not contain more than 700 or 800 or 10,000 s'lokas, or paragraphs; but others amount to 13,000, 25,000, or 100,000 s'lokas. The following may serve as a specimen of the abstruse ideas treated of in this great work of the Buddhistic doctrine. No object has existence or non-existence; nothing belongs to eternity or non-eternity, to pain or pleasure, to vacuity or non-vacuity. All objects are without attributes and with attributes, with and without

characteristic marks. Bodhisattwa (the name for a deified saint) and Prajñā (wisdom) are synonymous terms; such a term neither arises nor perishes; it exists neither inwardly nor outwardly, because it cannot be seized; but the Bodhisattwa must accomplish his career under this fallacious name; it is his duty, however, to look neither upon form nor anything else as an eternal or non-eternal, as a pure or impure matter, &c. Then only when he is in a condition of complete indifference regarding everything, is he capable of encompassing the whole wisdom. . . . The absence of nature is the nature of everything; all objects are separated from their characteristics. All objects neither appear nor are born, nor disappear, nor cease to be, nor are they pure nor impure, nor are they acquirable nor non-acquirable. Want of understanding is the not understanding that objects are nonentities. From the want of understanding proceed all subjective notions; and through the latter one becomes incapacitated from fulfilling the behests of the sacred doctrine, and from entering the path which leads to wisdom. . . . Everything is like the echo, or a shadow, or anything else without substance. In short, the doctrine of the P. is the entire negation of the subject as well as the object; and whatever be the difference in detail between the points of view from which it looks upon subject or subject, or between its comparisons and circumlocutions, the result is always the same: that the object of ascertainment, or the highest wisdom, has no more real existence than the subject striving to attain to it, or the Bodhisattwa.—See E. Burnouf, *Introduction à l'Histoire du Bouddhisme Indien* (Paris, 1844); W. Wassiljew, *Der Buddhismus, seine Dogmen, Geschichte und Literatur* (St Petersburg, 1860).

PRĀKRIT (from the Sanscrit *prakṛiti*, nature; hence, natural, not accomplished, vulgar) is the collective name of those languages or dialects which are immediately derived from, or stand in an immediate relation to Sanscrit, or 'the accomplished' Language (q. v.) of the Hindus. These languages, however, must not be confounded with those modern languages of India which also have an affinity with the Sanscrit language; for, in the Prākṛit languages, however much they may differ from Sanscrit in their phonetic laws, the words and grammatical forms are immediately derived from that language; whereas, in the modern tongues of India, there is not only no connection between their phonetic laws and those of Sanscrit, but their grammatical forms also are wholly different from those of the ancient language; and while many of their words have no Sanscritic origin, even those which have, shew that they are not immediately drawn from that source. The Prākṛit languages comprise, besides the *Pāli* (q. v.), which generally, however, is not included amongst them, those dialects which are found in the dramas and in the oldest inscriptions. In the dramas, it is women, except female religious characters, and subordinate male personages, who are made to speak in these languages—the use of Sanscrit being reserved for the higher characters of the play—and amongst the former, again, the choice of the special Prākṛit dialect is adapted by the poet to the rank which such a subordinate personage holds, the more refined dialect being appropriated, for instance, to the wives of the king or hero of the play; an inferior Prākṛit to his ministers; others less in degree to the sons of the ministers, soldiers, town-people, and the like; down to the lowest Prākṛit, which is spoken only by servants, or the lowest classes. A work on the poetical art, the *Sāhityadarpana*, enumerates 14 such Prākṛit dialects—viz. the *Sauraseni*, *Māhārāshṭri*, *Māgadhī*,

*Avahatī*, *Prāchyā*, *Avantīkī*, *Dākṣiṇīyā*, *Sākhari*, *Bālīkī*, *Draśidī*, *Abhīri*, *Chān'dālī*, *Sāwari*, and *Paisāchi*; but Vāraruchi, the oldest known grammarian of the Prākṛit dialects, knows but four—viz. the *Māhārāshṭri*, *Sauraseni*, *Māgadhī*, and *Paisāchi*; and Lassen, in the *Indische Alterthumskunde*, holds that, of those, only the *Sauraseni* and the *Māgadhī* have a really local character—the former, as he assumes, having been the vernacular of a large district of Western, and the latter—which is also the Prākṛit in the inscriptions of King Asoka—of Eastern India; whereas the *Māhārāshṭri*, or the language of the Mahrattas, does not seem to have been the language of the country the name of which it bears; and the *Paisāchi*, or the language of the Pisācha, is obviously merely a fancy name. The principal Prākṛit dialect is the *Māhārāshṭri*; the lowest, according to some, the *Paisāchi*, of which two varieties are mentioned; but according to others, the *Apāhramo'a*—which word originally means 'a falling-off'—i. e., a dialect which completely deviates from the grammatical laws of Sanscrit, but in this special application would designate a dialect even inferior to the *Paisāchi*, and is compared by a grammarian to the language of the reptiles. On the grammar of the Prākṛit languages, see Chr. Lassen, *Institutiones Lingue Pracritice* (Bonn, 1837). The Sūtras, or grammatical rules of Vāraruchi, have been edited in the same work; but more elaborately, with a commentary, copious notes, an English translation, appendices, and an index, by Edward Byles Cowell, who has also added to this excellent edition, *An Easy Introduction to Prākṛit Grammar* (Hertford, 1854).

PRASE, a green variety of Quartz (q. v.), sometimes found crystallised in the same forms as common quartz, but more generally massive, or in prismatic and granular concretions. It is rather a rare mineral. It is sometimes cut as an ornamental stone, but is not highly esteemed.

PRATIQUE is, strictly, a limited quarantine. A ship is said to have performed pratique when her captain has convinced the authorities of a port that his ship is free from contagious disease; and he is thereupon permitted to open trade and communication with the shore.

PRAWN (*Palæmon*), a genus of crustaceans, of the order *Decapoda*, and sub-order *Macroura*, in general form resembling lobsters, crayfish, and shrimps, but belonging to a family (*Palæmonidae*) remarkable for a long serrated beak projecting from the carapace. The upper antennæ are terminated by three filaments. There are many species of P., and some of those which inhabit the seas of warm climates attain a large size. Many of them are semi-transparent, and exhibit very fine colours; they are also very active creatures, and most interesting inmates of an aquarium, but are excessively voracious, and apt to make great havoc amongst its other inhabitants. The COMMON P. (*P. serratus*) attains a length of three or four inches. It is common on the British coasts, although not so abundant as the shrimp, and is generally taken in the vicinity of rocks at a little distance from the shore, and not in rock-pools. It is more esteemed for the table than even the shrimp. Osier-baskets, similar to those employed for catching lobsters, are employed for the capture of prawns; also nets about five or six feet wide, which are pushed along by means of poles, and are called *Putting Nets*. One side of the thorax of a P. is often found remarkably distended. This is owing to a parasitic crustacean, *Bopyrus craniorum*, one of the *Isopoda*, lodged under the carapace.

## PRAXITELÉS—PRAYER FOR THE DEAD.

**PRAXITELÉS**, a celebrated sculptor of ancient Greece, of whose life nothing is known, except that he was a citizen of Athens, and lived in the 4th c. B. C. Pliny gives the date 364 B. C. apparently as that in which P. began to flourish. His principal works—all of which have now perished—were: 1. Statues of Aphrodite (at Cos, Cnidus, Thespiae, Latmian Alexandria, and Rome), of which that of Cnidus was the most famous; 2. Statues of Eros (at Thespiae, and Parium on the Propontis); 3. Statues, single and in groups, from the mythology of Dionysus (at Elis, Athens, Megara, and other places); 4. Statues of Apollo, the best of which was that representing Apollo as the Lizard-slayer. So far as we are entitled to form an opinion of the works of P. from the descriptions and criticisms of ancient writers, it would seem that they marked an epoch in the history of Greece—viz., the transition from the earnest, heroic, and reverential age preceding the Peloponnesian war, to the more corrupt and sensual times that followed it. The sculpture of Pheidias is inspired by a profound veneration for the majesty of the gods; that of P. sought to give expression to the looser and less divine conceptions of the national religion. The bewitching beauty of woman, and the intoxication of Bacchic pleasures, were his favourite subjects; but in his treatment of these, he displayed unrivalled sweetness, grace, and naturalness. His gods and goddesses were not very divine, but they were ideal figures of the fairest earthly loveliness.

**PRAYER** is a universally acknowledged part of the worship due to God; a simple and natural expression of dependence, which seems almost necessarily to follow from a belief in the existence of a god. Accordingly, we find it both where the object of worship is one Supreme Being and in systems of polytheism. It is also combined with every other part of worship. According to the Christian system, however, prayer is not the mere spontaneous approach of man to God, in the endeavour to appease his wrath, to win his favour, or to obtain from him any blessing; but the right to approach him in prayer, and the warrant to expect advantage in doing so, rest on the revelation of his own will. Nor is any truth more indisputably taught in the Bible, or more frequently brought into view, both in the Old and in the New Testament, than that God is the *hearer* of prayer.

But a difficulty presents itself, in respect to what may be called the theory of prayer. How can prayer be supposed to influence the divine mind or will? How can a belief in its power be reconciled with any view of the divine decrees, from the most absolute doctrine of predestination to the most modified scheme which recognises the Creator as supreme in the universe? Such questions bring up the same difficulty which attends all other questions of the relations between the human will and the divine, the freedom of man and the sovereignty of God. But whatever seeming inconsistencies may be implied in speculation concerning them, the necessity of prayer and the power of prayer are acknowledged equally by men of the most opposite views; and generally with an acknowledgment of the inability of the human mind to solve some of the problems which are thus presented to it. The extreme predestinarian includes prayer among the means decreed of God along with the end to which it contributes. And whilst prayer is regarded by all Christians as of great value in its reflex influence on the feelings of the worshipper, this is scarcely ever stated as its whole value; however important this view of it may be deemed as illustrating the divine wisdom in making it one of the chief 'means of grace.'

Prayer being regarded by Christians as an *ordinance* of God, it follows that they must seek to be guided in prayer by the rules of his revealed will, in so far as his will has been revealed. It is therefore held by Christians in general, in accordance with their doctrine of the Atonement (q. v.) and of the Intercession (q. v.) of Jesus Christ, that the only true way of access to God is through the mediation of Jesus Christ, and that prayer must be made in the exercise of faith in him; the worshipper taking his stand upon the ground of the obedience or 'finished work and accepted sacrifice' of Christ, and looking up to Christ as now interceding in Heaven. It is also held, in accordance with the doctrine of man's corruption, that prayer can be truly made, in faith, and for things agreeable to God's will, only by the help of the Holy Spirit. Prayer, to be acceptable, must be for things agreeable to God's will, as that will is revealed in his Word; and therefore prayer for mere temporal or earthly good must be made in entire submission to his will; but prayer may be thus made for temporal or earthly good, the will of God having been revealed to that effect—an admirable instance of the grace of God.

Adoration, thanksgiving, and confession of sins, the accompaniments or adjuncts of prayer, are very generally regarded as parts of prayer; and prayer, which is strictly mere *petition*, is defined accordingly.

The Protestant churches all hold that prayer is to be made to God alone; the mediation of Jesus Christ and the help of the Holy Ghost being duly acknowledged. But in the Roman Catholic Church, and to some extent in the oriental churches, prayer of a kind is made also to saints, the Virgin Mary, and angels. See **INVOCATION**.

Prayer, according to Christians in general, must be made not merely in form or words, but with the heart. Accordingly, Protestants hold that prayer ought to be conducted in a language known to the worshippers. The Church of Rome has, on the contrary, maintained the general use of the Latin language, where that language is unknown to most of the worshippers.

Prayer for the dead (see following article) is rejected by Protestants, as having no warrant in the Word of God. But according to the Protestant creed, prayer is to be made for all the living—not only for believers but for unbelievers.

**PRAYER FOR THE DEAD**, the practice which prevails in the Roman Catholic, Greek, and other oriental churches, of praying for the souls of the deceased, with the intention and expectation of obtaining for them an alleviation of their supposed sufferings after death, on account of venial sins, or of the penalty of mortal sins, remitted but not fully atoned for during life. The practice of praying for the dead supposes the doctrine of **PURGATORY** (q. v.), although perhaps the converse is not necessarily true. Practically, however, the two may be regarded as forming part of one and the same theory, and especially if taken in connection with the doctrine of the Communion of Saints. It being once supposed, as the Roman Catholic system supposes, that relations subsist between the two worlds, that their members may mutually assist each other, it is almost a necessary consequence of the doctrine of purgatory, that the living ought to pray for the relief of their suffering brethren beyond the grave. We can but present an outline of this doctrine and of its history. It seems certain that some such doctrine existed in most of the ancient religions, and especially in those of Egypt, India, and China. It gives significance to many of the practices of the Greeks and Romans in reference to their dead. Its existence among the Jews is attested by the well-known assurance in 2d Maccabees, chap.

xii., that 'it is a holy and wholesome thought to pray for the dead, that they may be loosed from their sins.' The continued maintenance of the practice among the Jewish race, is plain from their sacred books; and a still more interesting evidence of its use has recently been discovered in the inscriptions disinterred in several Jewish catacombs of the first three centuries, at Rome and in Southern Italy, which abound with supplications: 'May thy sleep be in peace!' 'Mayest thou sleep in peace!' 'Thy sleep be with the good!' or 'with the just!' &c. Roman Catholics contend that the doctrine, as well as the practice, is equally recognisable in the early Christian Church. They rely on the parable of Lazarus and the rich man (Luke xvi. 19—31) as establishing the intercommunion of this earth with the world beyond the grave; and on Matt. xii. 32, as proving the remisability of sin or of punishment after death; as well as on 1st Cor. xv. 29, as attesting the actual practice, among the first Christians, of performing or undergoing certain ministrations in behalf of the dead. The Fathers of the 2d, 3d, and still more of the 4th and following centuries, frequently allude to such prayers, as Clement of Alexandria, Tertullian, St Cyprian, and especially St John Chrysostom, Cyril of Jerusalem, and St Augustine. The liturgies, too, of all the rites without exception contain prayers for the dead; and the sepulchral inscriptions from the catacombs, which reach in their range from the 1st till the 5th c., contain frequent prayers in even greater variety, and more directly intercessory, or rather more directly implying release from suffering than those of the contemporary Jews. In the services of the mediæval and later church, prayers for the dead form a prominent and striking element. See *REQUIEM*. The Abyssinians have separate services for the dead of all the several conditions and degrees in life, and continue to offer the mass daily for forty days after the death. The Protestant churches without exception have repudiated the practice. In the Burial Service of the first Book of Common Prayer, authorised in the Church of England, some prayers for the deceased were retained; but they were expunged from the second Book; and no trace is to be found in that sanctioned under Elizabeth.

**PRE-ADAMITES**, supposed inhabitants of the earth anterior to Adam. The author of the opinion, or at least the writer in whose hands it first took a scientific form, was Isaac de la Peyrere, better known by his Latinised name *Pererius*. He was born of a Calvinist family of Bordeaux in 1594, and was attached to the service of the Prince of Condé. His theory was first made public in 1655, in the form of a commentary on the 12th, 13th, and 14th verses of the 5th chapter of St Paul's Epistle to the Romans, which was followed, in the same year, by the first part of a formal treatise on the Pre-adamite hypothesis, and the theological consequences to be derived therefrom. According to his hypothesis, Adam was the progenitor of the Jewish race only, and it is only of him and his race that the Bible is designed to supply the history. Other races existed on earth before that of Adam; but of them the Bible contains no record, nor did the Mosaic law regard them or impose any obligation upon them. It was only under the gospel that they began to be comprehended in the law, which through Christ was given to all the human races of the earth; and it is in this sense that, according to Peyrere, sin is said (Rom. v. 13), to 'have been in the world until the law,' but not to have been 'imputed when the law was not.' For the Pre-adamite race, as the law was not, there was no legal offence. The only evil which Peyrere recognised was natural evil. The same limited interpretation he extended to most other

details of the Mosaic history. Thus, he regarded the deluge as partial, being confined only to the Adamite race. Other miraculous narratives of the Pentateuch and even of other books he restricted similarly. As his book was published in the Low Countries, he fell under the animadversion of the Inquisition, and eventually was arrested in the diocese of Mechlin, but was released at the instance of the Prince of Condé. He afterwards went to Rome, where he conformed to the Catholic religion, and made a full retraction of his erroneous opinions. He was offered preferment by the pope, Alexander VII., but returned in preference to Paris, where he entered the seminary of Notre Dame des Vertus, in which he resided till his death in 1678. The discussion has acquired new interest by recent discoveries of supposed evidences of human art and industry, in positions which, considered geologically, appear to their discoverers to be of an age beyond those limits which the Mosaic chronology assigns to the creation of Adam.

**PREBEND** (Lat. *præbenda*, from *præbere*, to furnish), the income or other provision assigned for the maintenance of a so-called prebendary, out of the revenue of a cathedral or collegiate church. After the definite constitution of chapters for the maintenance of the daily religious services in the bishop's church, or in other churches similarly established, endowments were assigned to them, which were to be distributed (*præbendæ*) in fixed proportions among the members. These portions were called *portiones canonicæ* or *præbendæ*. To the prebend was commonly attached a residence. The person enjoying a prebend is called a prebendary.—The name prebend is also given to an endowment assigned to a cathedral church for the maintenance of a secular priest.

**PRECEDENCE**, the order in which individuals are entitled to follow one another in a state procession or on other public occasions. We find questions of precedence arising in very early ages both in Europe and in the East. Where such questions have arisen among ambassadors, as the representatives of different countries, great tenacity has often been shewn in supporting the claims to rank of the states represented. In England, the order of precedence depends partly on the statute 31 Henry VIII. c. 10, partly on subsequent statutes, royal letters patent, and ancient usages. Among questions of precedence depending on usage, there are some which can hardly be considered so settled as to be matter of right, and are in a great degree left to the discretion of the officers of the crown. Formerly, they were adjudicated on by the Constable and Marshal in the Court of Chivalry; and since that tribunal has fallen into abeyance, the practice of persons aggrieved in these matters is to petition the crown, which generally refers the disputed question to the officers of arms. In Scotland, the Lyon Court has the direct jurisdiction in all questions of precedence.

It is a general rule of precedence, that persons of the same rank follow according to the order of the creation of that rank; and in the precedence of the English peerage, it has been fixed that the younger sons of each preceding rank take place immediately after the eldest son of the next succeeding rank. Married women and widows take the same rank among each other as their husbands, except such rank be professional or official, and it is an invariable rule that no office gives rank to the wife or children of the holder of it. Unmarried women take the same rank with their eldest brother; the wife of the eldest son, of any degree, however, preceding the sisters of her husband and all other

## PRECEDENCE

ladies in the same degree with them. Marriage with an inferior does not take away the precedence which a woman enjoys by birth or creation; with this exception, that the wife of a peer always takes her rank from her husband. The following tables exhibit the precedence of different ranks as recognised in England.

TABLE OF PRECEDENCE AMONG MEN.

The Sovereign.  
 The Prince of Wales.  
 Son of the Sovereign.  
 Grandsons of the Sovereign.  
 Brothers of the Sovereign.  
 Uncles of the Sovereign.  
 The Sovereign's Brothers' or Sisters' Sons.  
 H.R.H. Prince Leopold, King of the Belgians.  
 The Archbishop of Canterbury, Primate of all England.  
 The Lord High Chancellor, or Lord Keeper.  
 The Archbishop of York, Primate of England.  
 The Archbishop of Armagh, Primate of Ireland.  
 The Archbishop of Dublin.  
 The Lord High Treasurer. } Being of the  
 The Lord President of the Privy Council. } degree  
 The Lord Privy Seal. } of Barons.  
 The Lord Great Chamberlain.  
 The Lord High Constable.  
 The Earl Marshal. } Above all of  
 The Lord High Admiral. } their degree;  
 The Lord Steward of Her Majesty's } if Dukes,  
 House-hold. } above all  
 The Lord Chamberlain of Her Majesty's } Dukes, &c.  
 Household.  
 Dukes.  
 Eldest Sons of Dukes of the Blood Royal.  
 Marquises.  
 Dukes' Eldest Sons.  
 Earls.  
 Younger Sons of Dukes of the Blood Royal.  
 Marquises' Eldest Sons.  
 Dukes' Younger Sons.  
 Viscounts.  
 Earls' Eldest Sons.  
 Marquises' Younger Sons.  
 Bishops of London, Durham, and Winchester.  
 All other English Bishops according to seniority of Consecration.  
 Bishops of Meath and Kildare.  
 All other Irish Bishops according to seniority of Consecration.  
 Secretaries of State, if of degree of a Baron.  
 Barons.  
 The Speaker of the House of Commons.  
 Commissioners of the Great Seal.  
 Treasurer of Her Majesty's Household.  
 Comptroller of Her Majesty's Household.  
 Master of the Horse.  
 Vice Chamberlain of Her Majesty's Household.  
 Secretaries of State, under the degree of Baron.  
 Viscounts' Eldest Sons.  
 Earls' Younger Sons.  
 Barons' Eldest Sons.  
 Knights of the Garter.  
 Privy Counsellors.  
 The Chancellor of the Order of the Garter.  
 The Chancellor of the Exchequer.  
 The Chancellor of the Duchy of Lancaster.  
 The Lord Chief Justice of the Queen's Bench.  
 The Master of the Rolls.  
 Lord Chief Justice of the Common Pleas.  
 Lord Chief Baron of the Exchequer.  
 Lord Justices of the Court of Appeal in Chancery.  
 Vice chancellors.  
 Judges and Barons of the degree of the Calf of the said Courts.  
 Commissioners of the Court of Bankruptcy.  
 Bannerets made by the Sovereign under the Royal Standard in open war.  
 Viscounts' Younger Sons.  
 Barons' Younger Sons.  
 Baronets.  
 Bannerets not made by the Sovereign in person.  
 Knights of the 1<sup>st</sup> stile.  
 Knights Grand Crosses of the Bath.  
 Knights of St Patrick.  
 Knights Grand Crosses of St Michael and St George.  
 Knights Commanders of the Bath.  
 Knights Commanders of St Michael and St George.  
 Knights Bachelor.  
 Companions of the Bath.  
 Cavalieri and Companions of St Michael and St George.  
 Eldest Sons of the Younger Sons of Peers.  
 Baronets' Eldest Sons.

Eldest Sons of Knights of the Garter.  
 Bannerets' Eldest Sons.  
 Eldest Sons of Knights of the Bath.  
 Knights' Eldest Sons.  
 Younger Sons of the Younger Sons of Peers.  
 Baronets' Younger Sons.  
 Esquires of the Sovereign's Body.  
 Gentlemen of the Privy Chamber.  
 Esquires of the Knights of the Bath.  
 Esquires by Creation.  
 Esquires by Office.  
 Younger Sons of Knights of the Garter.  
 Younger Sons of Bannerets.  
 Younger Sons of Knights of the Bath.  
 Younger Sons of Knights Bachelor.  
 Gentlemen entitled to bear Arms.  
 Clergymen, Barristers-at-law, Officers in the Army and Navy, who are all gentlemen, and have their precedence in their respective professions.  
 Citizens.  
 Burgesses.

TABLE OF PRECEDENCE AMONG WOMEN.

The Queen.  
 The Princess of Wales.  
 Princesses, Daughters of the Sovereign.  
 Princesses and Duchesses, Wives of the Sovereign's Sons.  
 Grand-daughters of the Sovereign.  
 Wives of the Sovereign's Grandsons.  
 The Sovereign's Sisters.  
 Wives of the Sovereign's Brothers.  
 The Sovereign's Aunts.  
 Wives of the Sovereign's Uncles.  
 Duchesses.  
 Wives of the Eldest Sons of Dukes of the Blood Royal.  
 Daughters of Dukes of the Blood Royal.  
 Marchionesses.  
 Wives of the Eldest Sons of Dukes.  
 Daughters of Dukes.  
 Countesses.  
 Wives of the Younger Sons of Dukes of the Blood Royal.  
 Wives of the Eldest Sons of Marquises.  
 Daughters of Marquises.  
 Wives of the Younger Sons of Dukes.  
 Viscountesses.  
 Wives of the Eldest Sons of Earls.  
 Daughters of Earls.  
 Wives of the Younger Sons of Marquises.  
 Baronesses.  
 Wives of the Eldest Sons of Viscounts.  
 Daughters of Viscounts.  
 Wives of the Younger Sons of Earls.  
 Wives of the Eldest Sons of Barons.  
 Daughters of Barons.  
 Maids of Honour.  
 Wives of Knights of the Garter.  
 Wives of Bannerets.  
 Wives of the Younger Sons of Viscounts.  
 Wives of the Younger Sons of Barons.  
 Wives of Baronets.  
 Wives of Knights Grand Crosses of the Order of the Bath.  
 Wives of Knights Grand Crosses of St Michael and St George.  
 Wives of Knights Commanders of the Order of the Bath.  
 Wives of Knights Commanders of St Michael and St George.  
 Wives of Knights Bachelor.  
 Wives of Companions of the Bath.  
 Wives of Cavalieri and Companions of St Michael and St George.  
 Wives of the Eldest Sons of the Younger Sons of Peers.  
 Daughters of the Younger Sons of Peers.  
 Wives of the Eldest Sons of Baronets.  
 Daughters of Baronets.  
 Wives of the Eldest Sons of Knights of the Garter.  
 Daughters of Knights of the Garter.  
 Wives of the Eldest Sons of Bannerets.  
 Daughters of Bannerets.  
 Wives of the Eldest Sons of Knights of the Bath.  
 Daughters of Knights of the Bath.  
 Wives of the Eldest Sons of Knights Bachelor.  
 Daughters of Knights Bachelor.  
 Wives of the Younger Sons of the Younger Sons of Peers.  
 Wives of the Younger Sons of Baronets.  
 Wives of Esquires of the Sovereign's Body.  
 Wives of Esquires of the Knights of the Bath.  
 Wives of Gentlemen entitled to bear Arms.  
 Daughters of Esquires entitled to bear Arms, who are Gentlemen by birth.  
 Daughters of Gentlemen entitled to bear Arms, who are Gentlemen by birth.  
 Wives of Clergymen, Barristers-at-law, Officers in the Army and Navy.  
 Wives of Citizens.  
 Wives of Burgesses.

At the coronation of Charles I., the rule of  
741

## PRECENTOR—PRECESSION.

precedency of the nobility of England was introduced in Scotland; and it was arranged that peers of England (or their sons, &c.), of a given degree, should within England take precedence of peers of Scotland of the same degree; and that this precedence should be reversed in Scotland. But by the acts of Union of Scotland and Ireland, the precedence in any given degree of the peerage has been established as follows: 1. Peers of England; 2. Peers of Scotland; 3. Peers of Great Britain; 4. Peers of Ireland; 5. Peers of the United Kingdom, and Peers of Ireland created subsequently to the Irish Union. A similar order is understood to obtain in regard to baronets. The relative ranking of the great officers of the crown in Scotland was thus settled by statute in 1623 and 1661:

Lord Chancellor.  
 Lord Treasurer.  
 Archbishop of St. Andrew.  
 Archbishop of Glasgow.  
 Earls and Viscounts according to their ranks.  
 Bishops according to their ranks.  
 Lord Privy Seal, } first of their rank.  
 Lord Secretary, }  
 Lord President of the Court of Session.  
 Lord Register.  
 Lord Advocate.  
 Lord Justice Clerk.  
 Lord Treasurer Deputa.  
 Lords of Session, according to their admission.  
 Barons and Gentlemen, being Councillors, according to their admission.

The right of the judges of the Court of Session, in Scotland, to precede baronets, has generally been admitted.

There are rules for precedence for the members of different professions, recognised among themselves, but which do not confer general social precedence. Doctors in the universities rank thus: 1. Of Divinity; 2. of Law; 3. of Medicine.

**PRECENTOR** (Lat. *præ*, before; and *cantor*, a singer), the official in a chapter, whether cathedral or collegiate, whose duty it was to lead the singing. He commenced the psalm or hymn, which was taken up, and repeated either by the celebrant or another of the body, or by the rest of the choir. In modern chapters, the precentor ranks next in dignity to the provost or dean. Among the Presbyterian bodies, the precentor is the official who raises and conducts the psalmody, and is generally provided with a desk immediately beneath the pulpit.

**PRECEPT**, a legal term, used in Scotch Law in certain departments, generally signifies an order to do something. Thus, a precept of sasine is an order by the superior of lands to his bailie to infest the vassal. A precept of *clare constat* is an order by a superior to infest the vassal's heir, so called because the superior is quite satisfied of the propinquity.

**PRECEPTORY**, the name given to certain houses of the Knights Templar, the superiors of which were called Knights Preceptor. All the preceptories of a province were subject to a provincial superior, called Grand Preceptor; and there were three of these who held rank above all the rest, the grand preceptors of Jerusalem, Tripolis, and Antioch. Other houses of the order were called 'commanderies.'

**PRECESSION**. If the earth were truly spherical and homogeneous; or if it were composed of spherical layers each of uniform density; or, more generally, if it were such that the resultant of the attractions exerted on all its parts by any other body should always pass through a definite point in its mass, its diurnal rotation would not be affected by the attraction of any other bodies. If originally rotating about a principal axis of Inertia (q. v.), it

would for ever revolve about it, and the direction of the axis would remain fixed in space. To put this in more popular language, the Pole-star (q. v.) would always be the same star. But, although the earth rotates about an axis almost exactly coinciding with its axis of figure, the attraction of various bodies, especially the sun and moon, on the oblate portion at the equator, tends to give it a rotation about an axis in the plane of the equator; and the combination of these two rotations gives rise to a shifting of the instantaneous axis of rotation in the earth and also in space. As already mentioned (see **NUTATION**), the earth's axis of revolution describes a waved curve (very nearly circular) about the pole of the ecliptic, and in a direction contrary to that of the order of the signs of the Zodiac (q. v.). This waved curve may be conceived to be described as follows. The pole of the earth, P, revolves in about 19 years in a little ellipse, whose centre, O, travels uniformly in a small circle of the sphere, AO; the centre, E, of the latter is the pole of the ecliptic. The precession is the portion AO of this circle measured from any assumed point, A; and the small arc, OP, by which the true place of the earth's pole differs from its mean place, is the nutation. The nutation is generally resolved along, and perpendicular to, EO; and the components so found are the nutation in ecliptical latitude and longitude. This rough sketch is intended merely to shew the *nature* of the phenomenon, for the curve described by P about O is only approximately elliptic. Its greatest radius-vector, however, is exceedingly small, amounting only to about eighteen

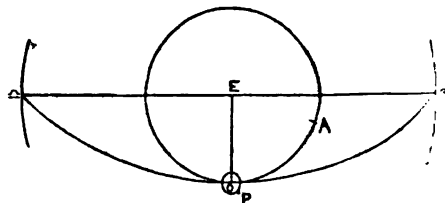

seconds of arc. AO, also, is not exactly circular, but very nearly so, as its radius, EO, is the *obliquity of the Ecliptic* (q. v.), which we know varies very little from the angle 23° 28'. The equinoxes, being 90° distant from E, and also from O, which may be taken as the mean place of P, are at  $\alpha$  and  $\omega$  in the diagram. And as O moves round E in the reverse order of the signs, so do the equinoxes, and in the same period—viz., 25,868 years. The effect is, of course, that while the earth's pole describes the small circle, AO, in the heavens, about the pole of the ecliptic, the equinoxes make one complete revolution in the ecliptic against the order of the signs. Thus, in turn, all stars lying near the circle AO become, each for a time, the *Pole-star* (q. v.). It may seem strange that the term precession should be applied to a retrograde motion; but, from the point of view of the observer, it is evident that the equinox, if on one day it arrive at the meridian of a place simultaneously with a fixed star, will next day arrive at the meridian *sooner* than the star, or will precede it in time of transit; and this is the origin of the term.

The physical explanation of the cause of precession is almost identical with that of the conical motion of the axis of a top about the vertical; the difference between the two being that, in the case of the top, the conical rotation of the axis takes place in the *same* direction as the rotation of the top about the axis, while in the case of the earth, the pole of the axis turns about the pole of the

## PRECIOUS STONES—PRECOGNITION.

ecliptic in the *opposite* direction to that in which the earth revolves about its axis. But the circumstances of the earth's motion are easily procured by a modification of the spinning-top, such as that of Troughton (used for the determination of latitudes at sea), if the centre of gravity of the whole mass be depressed *below* the point of suspension. If the axis of a top be vertical, there is no precession; similarly, when the sun or moon is in the plane of the equator, no effect is produced by them on the position of the earth's axis. When the axis of the common top is inclined, gravity tends to make it fall over; in similar circumstances, it tends to restore the axis of Troughton's top to the vertical; in either case tending to give the top a rotation about a horizontal axis perpendicular to that about which it is at the instant rotating; and the effect on the top is to cause a slow conical motion of its axis about the vertical. The sun or moon, in like manner, when not in the plane of the equator, tend to make, by their attraction, the earth turn about an axis perpendicular to that about which it is actually rotating. It is the composition of these rotations which gives rise to precession; but, though it would not be difficult to give a satisfactory investigation of the question without using formidable mathematical methods, the length of such an investigation prevents our giving it here. The simplest approximation we can give to the physical explanation, that originally given by Newton, must therefore suffice. We have seen (see PERTURBATIONS) that the node of a satellite's orbit tends always to *regrede* on the plane of relative motion of the primary and the disturbing body. Suppose, for an instant, the protuberant parts of the earth at the equator to be satellites, revolving about a spherical earth. The effect of the sun's or moon's disturbing force upon these satellites would be to make the nodes of their orbits *regrede*. And exactly the same result will follow if they be attached to the earth, only that the rate of regression will now be much slower, as the whole mass of the earth will share in the motion. This is one of the most ingenious of the wonderful series of explanations of celestial phenomena which were given in the *Principia*.

**PRECIOUS STONES**, a name almost synonymous with Gems (q. v.) in its widest sense, and partially extended to stones of larger size employed for ornamental purposes, but not to those which are used in architecture.

**PRECIPITATION**, in Chemistry, is an operation in which decomposition occurs in a fluid, either through the action of the air, or of a gas, or of a chemical agent in solution; and is accompanied by the deposition of a solid substance that was previously held in solution. The substance employed to produce the precipitation is called the *precipitant*, and the substance which is separated by its action, the *precipitate*. For example, if a solution of carbonate of protoxide of iron be exposed to the air, a precipitate of hydrated sesquioxide or peroxide of iron speedily falls; if a current of sulphuretted hydrogen gas be passed through a solution of acetate of lead, a black precipitate of sulphide of lead is thrown down from the clear and colourless solution; and if a solution of corrosive sublimate (bichloride of mercury) be added to a solution of iodide of potassium, a yellow precipitate of biniodide of mercury is thrown down. The precipitant must be added with caution, as, in many cases, an excess of it re-dissolves the precipitate. In qualitative analysis—that is to say, in determining the presence of substances without reference to their quantity—the colour, solubility, &c., of the precipitate thrown

down by numerous tests, as sulphuretted hydrogen, solutions of nitrate of silver, iodide of potassium, ferrocyanide of potassium, &c., afford the most useful information; and in quantitative analysis, the amount of precipitate thrown down from a given quantity of a solution, is often employed to determine the strength of the latter. For example, if a solution of nitrate of silver is added to an ounce of a solution of hydrocyanic acid of unknown strength, till no further precipitation ensues, we may readily calculate, from the weight of the white precipitate of cyanide of silver, how much anhydrous hydrocyanic acid was present.

**PRECOGITY** has been regarded as an indication of cerebral disease; and American physicians have not hesitated to identify this manifestation with chronic inflammation of the membranes of the brain. If it is not always, it is often associated with such intense activity of the whole system, and with morbid conditions, such as the scrofulous diathesis, as to usher in actual disease, premature decay, and early death. The decay often consists in mental feebleness and fatuity; or where no such formidable issue follows, in the reduction of what promised to be transcendent genius to commonplace mediocrity. The closing chapters of the history of many wonderful calculators—Infant Rosciuses, Infant Lyras, &c.—illustrate this. It is hence no mere poetic figure to say that the lamp of the mind lives upon and burns itself out. Yet there are numerous exceptions, such as Johnson, Mozart, Fergusson, Davy, where early genius grew into great and masculine powers. This rapid development in infancy or youth of faculties which are generally the result of protracted growth; and the intuitive acquisition of knowledge, which, under ordinary circumstances, is attained by laborious effort and cultivation, are most frequently witnessed in those of feeble and delicate constitution and of stunted frame. It is often seen as a concomitant of rickets, as in Pascal, Pope, &c.; and the dux of the school may often be pointed out from the disproportionate size of his head. While this development includes marvellous exercise of memory, of imagination, of constructive talent, of artistic genius, it rarely extends to judgment, reasoning, and sagacity. There appears to be evidence that this quality is not merely morbid, but that it exercises, reflexly, a detrimental influence upon healthy assimilation and growth, and arrests or retards that building up of the organisation, upon which the ultimate capacity and usefulness of the individual depend. Education sometimes produces such prematurity, or fosters it where it has previously existed; so that the modern form of mental exhaustion, 'the overworked brain,' may be said to originate in the school-room. It is certainly illogical to employ this fact, as has been done, against infant schools; but it is incumbent to keep such a relation in view in all educational efforts; to avoid high pressure and stimulation, to adapt the kind of instruction to the age, and, so far as may be practicable, to the strength and tendencies of the pupils; and to combine systematic physical with all intellectual training.—Brigham, *Remarks on the Influence of Mental Cultivation and Mental Excitement upon Health*; Combe, *On the Management of Infancy*; Caldwell, *Thoughts on Physical Education*.

**PRECOGNITION**, a Scotch legal term, which denotes the heads or substance of the evidence which a witness in a criminal cause proposes to give at the trial. In all cases, before a trial, it is necessary for the solicitor to see the witnesses, and elicit from them the nature of the testimony they can give; and the heads of this testimony are called the



## PREDESTINATION—PRE-EXISTENCE

precognitions, when written out. But the word has a technical meaning when applied to the examination of the witnesses before a justice of the peace or the judge-ordinary by the procurator-fiscal, previous to, and by way of enabling him to know how to frame, the charge. On such an occasion, the witnesses are examined or precognosed, a proceeding which corresponds to the evidence given in England before a magistrate or justices of the peace, and called there the depositions.

**PREDESTINATION**, a theological word, used to denote the eternal decree of God, whereby 'the elect' are foreordained to salvation. The correlative decree, whereby others are held to be foreordained to perdition (though it might with perfect correctness of language be included under the same term), is commonly distinguished by the other term—Reprobation.

The theory of Predestination had, like the doctrine of Election (q. v.), its origin in the attempts of theological system to define the relations of the human and the divine will, and to reconcile the phenomena of human freedom with the belief in divine omnipotence. God's absolute will is represented by it as determining the eternal destiny of man, not according to the foreknown character of those whose fate is so determined, but according to God's own mere choice. They who are thus foreordained to eternal life are led to believe and live by the 'irresistible grace' of the Holy Spirit. In human salvation, therefore, *God's* will is everything; *man's*, nothing. It was in the discussions between Pelagius and Augustine that the Predestinarian view of the divine 'decree' was first fully evolved; and since their time, opinion in the church has run in two great currents—the one perpetuating the influence of Pelagius, who regarded that decree as subordinated to the divine foreknowledge of human character; the other, that of Augustine, who maintained the absolutism of that decree, and its independence of all prior human conditions. Pelagius recognised a possibility of good in human nature; Augustine denied any such possibility, apart from the influences of divine grace. The one held that the choice of salvation lay in man's will; the other, that man's will had no active freedom or power of choice since the fall. In 529, the system of Augustine was established by the Council of Arausio (Orange) as the rule of orthodoxy in the Western Church; but the reaction against the strictly logical yet essentially unmoral nature of his dogma has been perpetually manifested by representatives of the more humane, though perhaps less logical doctrine of Pelagius, in every period of the church. In the days of the schoolmen, the discussions of the Scotists and Thomists—after the Reformation, the contests leading to the condemnation of Arminius in the Council of Dort, and the widening separation that now divides the disciples of Calvin from those theologians who hold broader and freer views on the subject of the *atonement*—indicate the impossibility of the human reason and conscience ever resting satisfied with a merely and absolutely logical theory of the relations between the will of God and the moral responsibility of man. The tendency of modern inquiry seems to be to abandon the discussion of a point so obviously incapable of being determined by human intelligence, and to pursue, instead, examination into the moral and practical bearing upon our human conditions of that which we are able to learn concerning God and His will. The moral meaning of that will is of vital moment to men; the extent of its power over their own wills, they apparently cannot determine.

**PREDICABLES.** This is a term in the

scholastic logic connected with the scheme of classification. There were five designations employed in classifying objects on a systematic plan: *genus*, *species*, *difference* (differentia), *property* (proprium), and *accident* (accidens). The first two—Genus and Species—name the higher and lower classes of the things classified; a Genus comprehends several Species. The other three designations—Difference, Property, Accident—express the attributes that the classification turns upon. The Difference is what distinguishes one species from the other species of the same genus; as, for example, the peculiarities wherein the cat differs from the tiger, lion, and other species of the genus *felis*. The Property expresses a distinction that is not ultimate, but a consequence of some other peculiarity. Thus, 'the use of tools' is a property of man, and not a difference, for it flows from other assignable attributes of his bodily and mental organisation, or from the specific differences that characterise him. The Accident is something not bound up with the nature of the species, but chancing to be present in it. For instance, the high value of gold is an Accident; gold would still be gold though it were plenty and cheap.

It was by an arbitrary and confusing employment of the notion of Predication, that these various items of the first attempt at a process of systematic classification, were called Predicables, or attributes that might be 'predicated,' that is, affirmed, of things. All that is needful to affirm is that a certain thing belongs to a given species or genus; and that to belong to the species is to possess the specific differences; and to belong to the genus is to possess the generic differences. We may also, if we please, *affirm* (or predicate) that the thing does belong to the species, or does possess the specific difference; but this power of affirming has no need to be formally proclaimed, or made the basis of the whole scheme.

The allied term 'Predicament' is another case where an abusive prominence is given to the idea of predication. The Predicaments, or Categories, were the most comprehensive classes of all existing things—under such heads as substance, attribute, quantity, quality, &c.; and it could be predicated of anything falling under any one head that it does so fall under. Thus, 'virtue' is an attribute; and therefore we might say that 'attribute' can be *predicated* of 'virtue.' But the notion of predicating does not indicate the main fact of the process in this case, any more than 'predicable' in the foregoing. *Classification*, and not predication, is the ruling idea in each.

**PREDICATE.** See PROPOSITION.

**PRE-ESTABLISHED HARMONY.** See LEIBNITZ.

**PRE-EXISTENCE, DOCTRINE OF.** The notion that human souls were in existence before the generation of the bodies with which they are united in this world, was anciently, and is still, widely spread throughout the East. The Greek philosophers too, especially those who held the doctrine of Transmigration (q. v.), as the Pythagoreans, Empedocles, and even Plato—if with him pre-existence is not simply a symbolical myth—were familiar with the conception. Among the early Christians, the assumption of such pre-existence was connected with the belief, that God had created the souls of men before the world, and that these were united with human bodies at generation or at birth. Subsequently, the followers of this opinion were termed *Pre-existentists*, to distinguish them from the *Traducianists*, who held that children received soul as well as body from their parents. Direct intellectual

interest in this doctrine has nearly altogether ceased in modern times, yet the dream—for whether true or false, it is and can be nothing but a dream in our present state, and with our present capabilities of knowledge—has again and again haunted individual thinkers. Wordsworth has given poetical expression to it in his famous ode—*Intimations of Immortality from Recollections of Early Childhood*:

Our birth is but a sleep and a forgetting.  
The soul that rises with us—our life's star,  
Hath had elsewhere its setting,  
And cometh from afar,  
Not in entire forgetfulness,  
And not in utter nakedness,  
But trailing clouds of glory do we come  
From God, who is our home.

Nor must we overlook the fact, that the latest philosophy of Germany—that of the younger Fichte, has revived the doctrine; while it forms the basis of one of the deepest works in modern theology, that of Julius Müller, *Die Christliche Lehre von der Sünde* (The Christian Doctrine of Sin. English, Edin. 1856).

**PREFET**, the name of an important magistrate in modern France, so called from his exercising functions somewhat similar to those of the *Præfectus urbi* at Rome. See **PRÆFECT**. In old times, the officers whose duty it was to superintend the details of administration in the provinces were called *Maitres des Requêtes*. Under Henry II., their office was rendered permanent; and at a later period, their powers were much extended, and they were known by the designation of *Intendants*. The intendants were abolished at the Revolution; and a law of 1800 first appointed préfets for the departments, with powers greatly similar to those of the intendants. The office, as it now exists, includes the superintendence of the police establishment, the enforcement of the laws, and the entire control of the administration of the departments. The préfet is the head of the executive, exercises most of the government patronage, including the appointment of a *sous-préfet* for each *arrondissement*, and in time of tumult may call out the military, or provisionally declare a state of siege. The chief check on these extensive powers is to be found in the *Conseil de la Préfecture*, which acts in some measure as a court of appeal from the decisions of the préfet.

**PREGEL**, a river of Prussia, rises in the province of East Prussia, where it is formed by the union of the Pissa and the Angerap near Insterburg. It flows almost due west past Welhau and Königsberg, and after a course of more than 90 miles, enters the Frisches Haff, about six miles below the latter town. The P. is navigable even at Insterburg; and at Königsberg, is 720 feet broad. Its principal tributaries are the Alle from the south, and the Inster from the north. The canal of Deine connects it with the Kurisches Haff.

**PREGNANCY, CONCEALMENT OF**, is a criminal offence, or rather it is taken to be the main proof of the offence of concealing the birth of a child in certain circumstances. It is only where the child is dead, and has been secretly disposed of under suspicious circumstances, that the mother is punishable. Hence, the offence consists in endeavouring to conceal the birth, and as part of such concealment, to conceal the pregnancy, the child having already died. If the woman failed to give publicity of her situation beforehand, it is presumed this was done from the improper motive, viz., to murder or destroy the child. To complete the offence, it is not necessary that the child should have been born live; but if the child can be shewn never to have lived, the prisoner must be acquitted. A usual

test of concealment is, that the mother made no preparations for her delivery, nor provided child's clothes.

**PREHNITE**, a mineral, composed chiefly of silica, alumina, and lime, the silica sometimes about 50 per cent. of the whole; but with small and variable proportions of peroxide of iron, peroxide of manganese, potash, soda, and water. It is a widely-diffused mineral, and although first discovered at the Cape of Good Hope, has been found in great beauty in some places on the continent of Europe and in Scotland. P. exhibits a great variety of forms, with considerable variety of colour; being found in crystals in fan-shaped and cockscomb-like groups, granular, reniform, fibrous, &c. It is colourless, or more generally greenish, and sometimes yellowish. See **JADE**.

**PRELATE** (Lat. *prolatus*, one set over), in Church Law, is the name given to the holders of those higher dignities in the church, to which, of their own right, is attached a proper jurisdiction, not derived by delegation from any superior official. In this sense, the name comprises not only prelates of the first class, as bishops, but also the heads of religious orders, abbots or priors of religious houses, and other similar ecclesiastical dignitaries. These, for the most part, are privileged to wear the insignia of the episcopal rank. In the Roman court, many of the officials, although not possessing episcopal or quasi-episcopal jurisdiction, have the insignia and the title of prelate. They are of two classes—the higher, called *del mantelletto* ('of the little mantle'), and the secondary, called *del mantellone* ('of the great mantle'), from the robe which they respectively bear.

**PRELUDE** (Lat. *præ*, before, and *ludo*, I play), in Music, a short preface or introduction to a piece, intended to awaken the attention of the audience, generally smooth and flowing, and consisting of a short motivo which is kept throughout; or it may be composed of a succession of harmonies uninterrupted or connected by passages. It is in the same key with the piece which it is to introduce, and to which it is intended as a preparation.

**PREMISES** is a common legal term to signify a house or building, and the outhouses and places belonging to it, all of which are treated as one thing. It is also used to denote a certain part of an English deed, which is further subdivided into the form, date, parties, recitals, testatum, and parcels. The use of the word in this sense is derived from the subject-matter of a conveyance or deed being first stated or described in full, and afterwards referred to collectively as the premises (Lat. *premissæ*, things spoken of or rehearsed before).

**PREMISS**. See **SYLLOGISM**.

**PREMONSTRATENSIAN** (called also **NORBERTINE**) ORDER, a religious order, which at one time was among the most numerous and powerful of the monastic bodies of Germany, in which country its most important houses were established. It was founded in the early part of the 12th c. by St Norbert, a native of Xanten, in the diocese of Cleves, of which church he was a canon. Struck by the prevailing irregularities and carelessness, not only of secular, but also of conventual life among the clergy and the monks, he resolved on attempting a reform of both, and obtained permission, in 1120, to found a cloister in the diocese of Laon, in France. The place selected by him was a spot in the forest of Coucy, pointed out, as he believed, in a vision, and thence called *Pré Montré*, or in Latin, *Pratum Monstratum*, 'the indicated meadow,' from which the name of the order was taken. In accordance with the double object which he

sought to attain, Norbert organised his new order, which was substantially that of the Canons Regular of St Augustine, as well with a view to the sanctification of the members, as to their usefulness in effecting the reformation of the age. Himself a man of remarkable piety and austerity of life, his rule is a return to the primitive fervour of the monastic institute; and the great work which he proposed for his brotherhood, in addition to the daily choral services of the church, was the practical instruction of the people, and the direction of consciences in the confessional. It was taken up with ardour, and spread rapidly in France and the Low Countries, and afterwards—on Norbert's being chosen, in 1127, Archbishop of Magdeburg—in Germany; the abbot of the mother-house at Coney, however, retaining the rank of general and of superior of the entire order. It does not seem at any time to have made much progress, or at least to have established many houses, in Italy or Spain. In the same spirit of reformation, Norbert established an order of nuns, which attained to equal success. In the end of the 15th c., the P. O. had no fewer than 1500 convents of men, and 500 of women, nearly all in France, Germany, and the northern kingdoms. A relaxation of the institute having taken place, in the progress of time there was a movement in the order, towards the close of the 16th c. (1573), similar to that which, in the Franciscan Order (q. v.), led to the reform of the so-called conventual Franciscans; but the reformed communities in the Premonstratensian institute remained united with the older body; and in 1630, the reformed rule was accepted by all in common. The order, however, has gradually fallen in popularity. In France, its numbers had declined very much even before the Revolution. Since that event, it may be said to have disappeared, except in Germany, where (in Austria) some magnificent, though thinly peopled houses of the order are still maintained.

PRE'NZLOW, a town of Prussia, in the province of Brandenburg, stands on the northern shore of the lower Lake Ucker, 71 miles north-north-east of Berlin. It contains a mineral spring, several baths, and, among its churches, the beautiful Gothic *Marienkirche*, one of the most remarkable brick buildings in the country; date 1325—1340. Population 13,213, who carry on several manufactures, but are chiefly engaged in growing tobacco and corn, and in breeding and trading in cattle. Here, in October 1806, a body of Prussian troops, 16,000 strong, under the Prince of Hohenlohe, surrendered, after the defeat of Jena, to the French under Murat.

PREPOSITIONS are words that express certain relations between ideas—between the idea of an action and the idea of a thing, or between the idea of one thing and the idea of another thing. 'The river runs to the sea. The glass stands on the table. The dog lies under the table. He runs round me. She runs from me. The house by the wood.' In all the instances just given, the relation is of one kind—that of place or direction. And this was the original signification of all prepositions. They gradually, however, came to express other relations. Thus: 'That depends on you. Subjects are under the sovereign. She got round her father. Vice springs from idleness. Wood is consumed by fire. Your enemy is in your power.' The transition from the palpable, physical relation to the more abstruse mental relation, is, in most cases, obvious.

A preposition is distinguished from an adverb by its always requiring an object (a noun or pronoun)

after it. In the sentence, 'He runs about,' *about* is an adverb describing the mode of running; in 'He runs about the house,' it is a preposition referring the direction of the running to a particular object.

Many relations are expressed by prepositional phrases; as, *instead of*, *with regard to*, *apart from*. The preposition *beside* is evidently an abbreviation of such a phrase—*by the side of*. This tendency in phrases to become simple prepositions, is manifest in other cases. Instead of the full expression, 'on this side of the river,' we often hear, 'this side the river,' where *this-side* has the force of a preposition, and may yet come to be written *thiside*.

Of the relations expressed in the modern forms of the Aryan tongues by prepositions, a great many were formerly expressed by cases. See DECLENSION, INFLECTION, PHILOLOGY.

Along with prepositions are classed certain particles, which, although they may not stand by themselves and govern a case, are yet used in composition with verbs in the same way as the prepositions proper; as in *outrun*, *replace*.

The simple prepositions (Eng. *in*, Dan. *i*, Lat. *in*, Gr. *en*; Eng. *on*, Gr. and Goth. *ana*, Ger. *an*, Slav. *na*; Eng. *of*, Goth. *af*, O. H. Ger. *aba* or *apa*, Ger. *ab*, Sans. *apa*, Gr. *apo*, Lat. *a*, *ab*; Eng. *by* [*be*], Goth. *bi*, Ger. *bei*, Gr. *epi*, Sans. *abhi*; &c.) belong to the primary or radical words of language. They are often identical with the pronominal roots (see PRONOUNS), and along with them form a class of roots whose primary signification is position or relation in space. All attempts, like those of Tooke, to make them derivatives from verbs, are futile. On the contrary, verbs and other parts of speech are often derived from prepositions, as *utter* from *out*; *open* and *upper* from *up*. Some prepositions have a derivative form, as *after* (from the root of *of*), Lat. *inter* (*in*); others are compounded of two prepositions, or a preposition and prepositional particle, as *upon*, *but* (*i. e.*, by out, or be out), *before*, *within*, *into*. Other prepositions, again, contain a noun, as *against* (A. S. *ongegen*, or *to gegnes*; where, from the forms in the allied languages, the element *gegen* is clearly a substantive, the primary meaning of which, however, has not been made out); *among* (A. S. *gemang* or *ongemang*, *gemang* meaning primarily mixture); *between* (*i. e.*, by or *betwixt* or *twain*). Such prepositions as *during*, *except*, were originally participles used absolutely; thus, 'during the war' = the war during or lasting, *i. e.*, while the war dured or lasted; 'except this' = this excepted (*hoc excepto*).

The study of the etymological relations of prepositions is instructive, as shewing how near to one another often lie the most opposed meanings. They are, as it were, the opposite poles of one and the same conception—correlatives depending on a common ground relation, and are thus naturally expressed by words that are radically the same. Thus, Eng. *up* corresponds to Goth. *uf*, Sans. *upa*, Gr. *hyper*, Lat. *sub*. The meaning of *up* is motion from below to above, leaving, however, the idea of the upper terminus the more prominent; *uf*, *hyper*, *sub*, on the contrary, are used to express *under*; but that the notion of upward motion lurked in these roots, is clear from such Latin compounds as *suspicio*, to look up at a thing; *sustineo*, to hold up; and it only required a slight modification—a kind of comparison—to convert them into *ufar*, *hyper*, *super*, meaning 'above'—a result which the English attains by adding the preposition *on* (*upon*). The same principle is copiously exemplified in the numerous forms and derivatives of the prepositional root FR, in Sans., Gr., Lat., and SL, PR, in which motion or removal from the speaker in the front direction

seems to be the ground idea. For example, when, in reference to any epoch, we speak of the events that have preceded and those that are predicted as to come, the same particle *pre* points in two opposite directions.

PREROGATIVE COURT, in England, was the court wherein all wills were proved, and administrations taken out. It was so called because it belonged to the prerogative of the archbishop to take charge of these matters, which formerly fell under ecclesiastical superintendence. Hence there was a Prerogative Court for the province of Canterbury, and another for the province of York. This jurisdiction was entirely taken away in 1858 from the ecclesiastics, and transferred to a new court called the Probate Court (q. v.).

PRESBURG (Lat. *Posonium*; Magyar, *Pozsony*; Slav. *Pressburek*), a town in the extreme west of Hungary, close upon the frontier of Lower Austria, is built on the left or northern bank of the Danube, 41 miles by railway east of Vienna. The neighbouring hills are clothed with vineyards. It was long the principal city of Hungary, having been made the capital in 1511, when the Turks seized possession of Buda; and even as late as the last quarter of the 18th c., it was the most beautiful, and the most populous town in the kingdom; but when Joseph II., in 1784, restored to Buda its ancient dignity of being the capital of Hungary, and the scene of the coronation of its kings, the sources of the prosperity of P. began to be dried up. Its population, in 1857, was 43,863, of whom more than two-thirds were Roman Catholics; about 7000, Lutherans; and 5000, Jews. Fully one-half of the inhabitants are German, and German is the prevalent language. The most notable buildings in the town are the (Gothic) cathedral, in which the kings of Hungary were crowned; the royal palace, a vast square structure overlooking the town, accidentally burned in 1811, and not since repaired; the Capuchin, Franciscan, and Ursuline monasteries, with beautiful churches attached to them; the Land-Haus (Hall of the Hungarian Diet), &c. The transit-trade by steam-boat and railway, especially in corn, is very great, and gives considerable animation to an otherwise quiet place. P. carries on manufactures of silks, woollens, leather, paper, tobacco, glass, and chemical products. Outside the town lies the 'King's Hill' (*Königshügel*), to which the sovereigns of Hungary were wont to ride after their coronation, and brandish their sword towards the four quarters of the heavens, signifying by that symbolic act that they would defend Hungary from danger—come whence it might. A treaty was concluded here between Napoleon and the Austrian emperor—known as the 'Treaty of Presburg'—December 27, 1805, in virtue of which Austria ceded Venice to France, and the Tyrol to Bavaria.—P. gives name to a 'county.'

PRESBYTER, PRESBYTERIANISM. Presbyter (Gr. *presbyteros*, elder) is the title of an office or dignity in the Jewish synagogue, and also of one of the grades in the Christian hierarchy. In the latter sense, the title has been the occasion of a protracted controversy as to the respective claims of the Bishop (q. v.) and the Presbyter, which, except historically, would be out of place in these pages. The word presbyter not unfrequently occurs in the Epistles and the Acts of the Apostles, and in more than one of these passages, it is certainly applied to persons whose office would seem to be in all respects the same as that which is claimed for the 'bishop' in the episcopal theory. From this identity of name, the identity of office has been inferred, and it has been hence concluded,

that the distinction of bishops and presbyters is a human and post-apostolic ordinance. Advocates of the episcopal theory admit that the name presbyter is occasionally given, both in Scripture and in the early church writers, to persons who bore the office of bishop (*episcopos*), and that the latter certainly was in all cases a presbyter; but they contend that besides being a presbyter, he was also something more and something higher. That the office of Timothy, for example, was superior to that of a presbyter, is conceived to be plain from St Paul's instruction to aim (1st Timothy v. 19) as to how he should receive testimony against a presbyter. The same is inferred from Titus i. 5. On the other hand, no example, it is affirmed, appears of a presbyter sitting in judgment on a bishop, or 'appointing bishops in every city.' But Presbyterians do not admit the validity of these arguments, inasmuch as they assert the identity of presbyter and bishop, and the right of co-presbyters both to judge a brother, and also to ordain to the office of the ministry. Episcopalians rely still more, however, on the apostolic Fathers, and those of the 3d and 4th centuries. Among the Fathers of the former period, Clement of Rome, and even more plainly, Ignatius of Antioch, point to the bishop's superiority as already established, and they are followed by Tertullian, Irenæus, Clement of Alexandria, and Cyprian. On the Presbyterian side, a remarkable passage is quoted from Jerome, in which, while repressing the pretensions of deacons to equality with presbyters, he appears to place the presbyter on the same level with the bishop in all the functions of the ministry except the power of ordination. The explanation of this passage, according to the Episcopalian view, is found in what has been already indicated by the community of name which existed even in the primitive times; while they also rely on the difference implied in the very important exception which even Jerome admits, in this very passage—viz., the power of ordaining. The offices of presbyter and bishop, according to the Roman Catholic theory, both, although in different degrees, belong to what Roman Catholics regard as the priesthood of the New Law. This priesthood the bishop possesses in its fulness, the presbyter only in part, but the functions which belong to that part are discharged alike by the presbyter and the bishop, although by the former only in subordination to the latter. What these functions are, will be detailed under the head PRIEST (q. v.); but the principle of a certain distinction of functions, and the limitation of the power of the presbyter as to one at least—that of ordination—is expressly recognised by Jerome in the passage alluded to. The name presbyter has been retained even in the Roman Catholic theory of a priesthood; but although, by the opponents of the Episcopalian doctrine, the word is used with the express design of excluding the sacerdotal idea, it has come, in the popular language of Roman Catholic theology, to be identical with Priest. From an early period, however, a distinction of rank among the presbyters came into use. Several being, in some cases, attached to a single church, one of the number received the title of *proto-presbyter* or *archi-presbyter*; but it is quite certain this office bore no analogy to that of the bishop.

In all existing Presbyterian churches, a primary element is the representation of congregations in presbyteries, &c., by their delegated elders; of whom the 'minister,' or preaching elder, is always one; and this system of representation is advocated partly on the general ground of the unity of the church, and partly on the special ground of the example of the church in the apostolic age (Acts xv.). The affairs of particular congregations are managed

by a court, styled in Scotland the Kirk-session, consisting of the minister, or ministers, if there are more than one, and the other elders, the minister or one of the ministers presiding, but each member having equal power and vote. From the decisions of this court, an appeal lies to the Presbytery, which is usually constituted of the ministers of a certain number of congregations and one 'ruling elder' from each congregation. Further appeals may be taken to *Synods* and *General Assemblies*, in churches so large that for convenience the presbyteries of a district are grouped into a 'Provincial Synod,' and all the provincial synods are subordinated to a General Assembly; but in respect of this there are considerable diversities, and the 'supreme' church court, whether *Synod* or *General Assembly*, is variously constituted by direct representation of each congregation, of each presbytery, or of each provincial synod. Nor are diversities of this kind regarded as in the least degree affecting the principle of Presbyterianism.

Presbyterian churches generally recognise an order of *Deacons* (q. v.) as existing in the church, with power only over its secular affairs; but in many Presbyterian churches this office is merged in that of the elder, and all its functions are exercised by the members of the Kirk-session. A tendency to revive the distinct office of deacon, has, however, been recently manifested in some of the Presbyterian churches.

Some Presbyterians maintain the *divine right of presbytery*, as the one system of church government authorised by the Word of God; others only maintain that Presbyterianism is *consistent* with the Word of God; whilst many Presbyterians maintain that the Presbyterian system, whatever its imperfections as existing anywhere, is, of all systems that have ever existed in the church, the most agreeable to the principles of church government which may be deduced from Scripture.

Presbyterianism, variously modified, is the form of church government subsisting in many Protestant churches, but is most perfectly developed in Britain and America. In Britain, it prevailed chiefly in Scotland, although on the revolution in the 17th c., it was for a very short time in the ascendant in England also. The *consistorial* system of the continent of Europe (see *CONSISTORY*) cannot, in any of its modifications, be regarded as essentially Presbyterian, although in some respects it approaches to Presbyterianism. The French consistorial system is more nearly Presbyterian than the German, and is not perfectly so only from the pressure of the civil power. In other churches, also, as well as in the Protestant Church of France, Presbyterianism is more or less modified by the relations of the church to the state.

#### PRESBYTERIAN CHURCH IN AMERICA.

The first Presbyterians in America were emigrants from Scotland and Ireland. The first Presbyterian congregations in America were organised in Maryland before the close of the 17th c.—the oldest, that of Snow Hill dating about 1690; and the first presbytery in Philadelphia in 1705. A synod, consisting of four presbyteries, was constituted in 1716. Dissensions ensued; but in 1758 the American Presbyterian churches were united in one; and in 1789 a General Assembly was instituted, the whole number of congregations being then 419, and of ministers 188. The increase of the church was rapid, and in 1834 it contained 22 synods, 111 presbyteries, and about 1900 ministers. In 1801, a scheme of union was adopted between Presbyterians and Congregationalists, under which hundreds of congregations were formed in the state of New York and elsewhere. About the beginning of the present century,

the Cumberland Presbyterians (q. v.) separated from the main body; and in 1838, the American Presbyterian Church was divided into two great sections, commonly known as *Old School* and *New School* Presbyterians; the former holding high Calvinistic doctrines; the latter, a somewhat modified Calvinism. Both of these churches are extended over the whole of the United States, and both of them have missions in different parts of the heathen world, their collections for missions forming a large part of the contributions for that object from the United States of America. The Old School Presbyterian Church reckoned, in 1860, 3592 congregations, with more than 2698 ministers, and 292,857 members; the New School, 1483 congregations, 1527 ministers, and 134,933 members. The Old School Presbyterians possess the following theological seminaries: 'Princeton' (Princeton, N.J.), 'Western' (Alleghany City, Pa.), 'Hampton-Sidney' (P. Edward Co., Va.), 'Columbia' (Columbia, S. C.), 'Danville' (Danville, Ky.), and 'Northwest' (Chicago, Ill.). The New School Presbyterians have the 'Union' (New York City), 'Auburn' (Auburn, N. Y.), 'Lane' (near Cincinnati, Ohio), 'Blackburn' (Carlinville, Ill.), and 'Lind' (Chicago, Ill.).—Besides the Cumberland Presbyterians, there are other minor branches of the Presbyterian Church in America, connected with different denominations in Scotland.

#### PRESBYTERIAN CHURCH IN ENGLAND.

The principles of the Puritans (q. v.) were essentially Presbyterian, although many of them were so much occupied with questions of doctrine and discipline, and with resistance to power exercised, as they believed, contrary to the word of God, that they paid little heed to the development of their principles in church government. In general, they felt so much the constraint of circumstances, that they refrained even from the attempt to constitute a church on the principles which they maintained, resting satisfied in giving effect to these principles by mere resistance in particular cases in which their consciences were aggrieved. Yet, in 1572, a presbytery was formed at Wandsworth, in Surrey, by ministers of London and its neighbourhood, separating from the Church of England; and other presbyteries were soon formed, notwithstanding the extreme hostility of Queen Elizabeth. When the Westminster Assembly met in 1643, the Puritans of England were generally inclined to adopt Presbyterianism as their system of church government, although some still preferred a modified Episcopacy, and some had adopted the principles of Independency or Congregationalism. The Presbyterians were, however, the strongest party in the beginning of the Revolution, although the Independents gained the ascendancy afterwards. The establishment of Presbyterian church government in the Church of England was voted by parliament (the Long Parliament), 13th October 1647; but it was never really established. The influence of the Independents prevented it. London and its neighbourhood were, meanwhile, formed into twelve presbyteries, constituting the Provincial Synod of London, which continued to hold regular half-yearly meetings till 1655, the meetings of presbyteries being continued till a later date; but the whole Presbyterian system was overturned by Cromwell's Committee of Tiers, appointed for the examining and approving of all persons elected or nominated to any ecclesiastical office. Cromwell's policy aimed at bringing all ecclesiastical matters under the immediate control of the civil power. The Restoration was followed by the fruitless Savoy Conference (q. v.), and soon after by the Act of Uniformity, which came into force on 24th August 1662; and on that day, about

## PRESBYTERIAN CHURCH IN IRELAND—PRESCOTT.

2000 ministers in England and Wales resigned their benefices, or submitted to be ejected from them, for conscience' sake. The first Nonconformists (q. v.) were mostly Presbyterians, but a small minority of Independents among them prevented the institution of a regular Presbyterian system, and the consequence was that the Nonconformists of England became in general practically Independent. Antinomianism and Arminianism soon appeared among them, and were followed by Socinianism or Unitarianism to such an extent, that the name *Presbyterian* became synonymous in England with *Socinian* or *Unitarian*; old endowments, legacies of Presbyterians, being in many instances enjoyed by Unitarians. Meanwhile, there existed in England a few congregations connected with the Church of Scotland and with the Scottish Secession Church; and these were formed into *churches*, connected more or less intimately with the Scottish Presbyterian churches, to which other English congregations allied themselves. Of late, the Presbyterians of England have shewn a strong inclination to dissociate themselves from the Presbyterian churches of Scotland, of which they assert a complete independence. This is particularly the case with the 'Synod of the Presbyterian Church in England,' the most intimate relations of which, however, are with the Free Church of Scotland, and which reckons a number of presbyteries in different parts of England, and has a theological college in London, and missions in China and elsewhere.

**PRESBYTERIAN CHURCH IN IRELAND.** The Irish Presbyterian Church originated in the settlement of Ulster by Scottish colonists during the reign of James I. Scottish ministers carried over to Ireland their peculiar views, and after various struggles, a Presbyterian church was founded by the formation of a presbytery at Carrickfergus on 10th June 1642. The Presbyterian population of Ulster was greatly increased in number by immigration from Scotland about the middle of the 17th c.; and notwithstanding many difficulties, from the opposition of prelates and of the civil power, the church continued to increase. It is a curious fact that the Presbyterian ministers received a pension from government, under Charles II, in 1672, which *Regium Donum* (q. v.), however, was not regularly paid, and soon ceased to be expected by the Presbyterian ministers. In the reign of William, the *Regium Donum* was augmented, although only to the paltry amount in all of £1200 a year. The sum has since, however, been repeatedly augmented, and is now £70 for each minister. A seminary for the education of ministers was also erected at Killaleagh. In 1710, the synod of the Presbyterian Church resolved to institute the preaching of the gospel to the Irish in their own language. During this period of its history, the Irish Presbyterian Church experienced the utmost opposition from the *High Church* party. Afterwards, dissensions sprung up within it, and these with reference to the most important doctrines. A body opposed to the doctrine of the Westminster Confession of Faith was organised as the Presbytery of Antrim. But the doctrine of the Westminster Confession was more and more departed from in the Irish Presbyterian Church itself, which became to a large extent Arian or Unitarian. The *Regium Donum* was augmented in 1792, and again in 1803. In 1830, a separation took place from the Arians, who then formed the *Remonstrant Synod of Ulster*, Arian views having become very prevalent among the Presbyterians of Ireland. But since that date, the Irish Presbyterian Church has continued to increase, and the Remonstrant or Arian body has

not increased in like proportion. In 1840, a union took place of the Irish Presbyterian Church forming the *Synod of Ulster*, and the *Secession Church in Ireland*, an offshoot of the Scottish Secession Church, which then reckoned 141 congregations in the north of Ireland. The Irish Presbyterian Church now consists of about 600 congregations and has not only displayed much zeal for the advancement of Protestantism in Ireland, but also of Christianity in other parts of the world, and supports a very successful mission in Guzerat.

**PRESBYTERY**, the space in the choir of a church in which the high altar is placed; the name is sometimes extended to the whole choir.

**PRESBYTERY**, in Scotch Law, is an ecclesiastical division of the country, as well as a court. In its local sense, it includes a combination of parishes, varying from four to thirty, and the General Assembly of the Church of Scotland has power to vary the size. See SCOTLAND, CHURCH OR.

**PRESCOT**, a manufacturing and market-town of Lancashire, 8 miles east of Liverpool. At Huyton, 1½ miles distant, there is a station on the London and North-western Railway. P. has long been well known for its manufactures of watch-tools, watch-movements, small files, &c. Potteries are in operation in the vicinity. Pop. (1851), 7393; (1861), 6066.

**PRESCOTT, WILLIAM HICKLING, LL.D.**, American historian, son of a distinguished lawyer and statesman, and grandson of Colonel William Prescott, an officer of the Revolution, was born at Salem, Massachusetts, on May 4, 1796. He entered Harvard College in 1811, and graduated in 1814. During his college course, he had one eye blinded by a piece of bread playfully thrown by a fellow-student, and his studies so affected the other, that he was sent abroad for his health, and travelled in England, France, and Italy. On his return to America, he married, and abandoned the study of law for literature. In 1819, he determined to devote ten years to study, and the succeeding ten to composition. He contributed, however, several papers to the *North American Review*, collected in his *Miscellanies*. In 1825, he was engaged in the study of Spanish literature, and selected materials for his *History of Ferdinand and Isabella*. While engaged in this work, his sight failed, and, with the aid of a reader who knew no Spanish, he went through the seven quarto volumes of Mariana's History. After ten years of painful labour, his work was made ready for the press, and a few copies struck off for his friends, whose warm approval secured its publication in 1837 (3 vols. 8vo, Boston and London). It met with immediate success, and was translated into French, Spanish, and German. He next devoted six years to the *History of the Conquest of Mexico* (3 vols., 1843, London and New York); and four years to the *Conquest of Peru* (2 vols., 1847). These careful, elaborate, and charmingly written works made for him a high reputation. He was chosen corresponding member of the French Institute; and, on his visit to Europe in 1850, he was received with the highest distinction. In 1855, he published two volumes of his *History of Philip II.*, and a third volume in 1858, but left it unfinished. He died at Boston, January 28, 1859. Mr Prescott was an elegant scholar and writer, a man of a cheerful humour and affectionate character, methodical in his habits, and persevering in his pursuits. He walked five miles regularly every day, composing as he walked. He devoted five hours to literary labour, two hours to novel-reading, for the refreshment of his mind—Scott, Dickens, Dumas, and Sue being his favourite authors. He gave one

## PRESCRIPTION.

tenth of his ample income in charity, and divided his time between his winter mansion in Boston, a summer residence at Nahant, and a farmhouse, where he spent the autumn. In his large library, with the light carefully regulated for his imperfect vision, he wrote with a stylus each day what he had composed, which was then copied, read over, and carefully corrected. His life, by George Ticknor, was published in 1864.

**PRESCRIPTION** is the term applied to the written direction or receipt given by the physician or surgeon to the chemist for the preparation of a medicinal substance suitable to a special case. In prescribing, the medical practitioner may either order an *official* or an *extemporaneous* compound. Official compounds (or preparations, as they are frequently termed) are those for which formulæ are introduced into the national pharmacopœias, and are therefore supposed to be always at hand in the laboratory of the dispensing chemist (such, for example, as *Mistura Ferri Composita*, *Pulvis Ipecacuanhæ Compositus*, *Confectio Aromatica*, &c.); while extemporaneous compounds are those which are devised on the instant with the view of meeting the various peculiarities which almost every case of disease presents. 'Too much importance,' as Dr Paris very truly observes, 'cannot be assigned to the art that thus enables the physician to adapt and graduate a powerful remedy to each particular case by a prompt and accurate prescription. If he prescribes upon truly scientific principles, he will rarely, in the course of his practice, compose two formulæ that shall in every respect be perfectly similar, for the plain reason, that he will never meet with two cases exactly alike.'—*Pharmacologia*, 9th ed., 1843, p. 374.

The author whom we have just quoted, and who is the highest English authority on the subject, lays down *five objects* which the physician should have in view in the construction of an extemporaneous formula or prescription. They are: 1. To promote the action of the principal medicine (or, as he terms it, the basis) of a formula. 2. To correct the operation of the basis. 3. To obtain the joint operation of two or more medicines which act in totally different ways. 4. To obtain a new and active remedy not afforded by any single substance. 5. To select an eligible form.

The *first object* may be attained (*a*) by combining different preparations of the same substance, as, for example, tincture of senna with infusion of senna in the ordinary Black Draught; or (*b*) by combining different substances of a similar action, as, for example, opium with hyoscyamus or conium; or sulphate of magnesia with the preparations of senna; or quinine with the preparations of iron. The *second object* may be obtained in various ways. For example, the addition of extract of hyoscyamus to the compound extract of colocynth renders the purgative action of the latter much less griping, but not less efficacious; the addition of dilute sulphuric acid to a solution of sulphate of magnesia renders that purgative salt less liable to gripe, and makes it sit easier on the stomach; and extract of elaterium, if given in hot brandy and water, acts equally powerfully as a hydragogue cathartic without causing the depression of the vital powers, which it often occasions if given alone. As an illustration of a mode of attaining the *third object*, we may refer to the operation of purgatives and of diuretics. If we administer a purgative which acts mainly in increasing the peristaltic motion of the intestines, their contents will be urged forward and evacuated, but the operation will be slow and difficult, and probably be accompanied with griping; but if we combine this medicine with one which acts by

increasing the flow of fluids into the intestine, the purgative action will be increased and quickened, and all griping will be avoided. A combination of foxglove, squill, and blue pill or calomel will act much more powerfully as a diuretic than any one of the substances taken alone; and they probably all act in different ways on the system. The *fourth object* is usually attained by chemical decomposition. The activity of the *Mistura Ferri Composita* is due to the carbonate of iron which it contains, and which is yielded by the double decomposition of the two ingredients of the mixture, sulphate of iron and carbonate of potash. By prescribing a mixture of solution of iodide of potassium and corrosive sublimate, we obtain an extemporaneous formation of biniodide of mercury. The Black Wash (see **LINIMENTS**) owes its active ingredient to the decomposition of calomel by lime-water. In some cases, where no chemical action is apparent or probable, a mixture of two or more drugs seems to modify the physiological effect of each ingredient. For example, Dover's Powder contains as its active ingredients ipecacuanha and opium, and yet in well-regulated doses it neither exhibits the nauseating properties of the former, nor the narcotic influence of the latter substance. The *fifth object*, the selection of the most eligible form of the remedy, is of extreme importance. The physician here has to determine whether he shall prescribe his remedy in the form of pill, powder, or mixture; whether he shall administer it as an injection into the lower bowel; whether the patient shall (in certain cases) inhale it; &c. As a general rule, we should accommodate the form and flavour of our remedies, provided we do not sacrifice their virtues, to the taste of the patient, who usually prefers pills to draughts or powders. The unpleasant taste of many medicines which must be given in the fluid form may often be obviated by the skill of the prescriber. Castor oil, cod-liver oil, and copaiba are most easily taken on the surface of orange wine, or water containing a bitter tincture, care being taken to moisten with water the edge or rim of the glass at the part applied to the mouth. The taste of solution of potash and of lime-water is best covered with milk; and the disagreeable flavour of senna is said to be concealed if its infusion is made with strong tea.

In conclusion, it may be remarked that in this country it is the custom to write prescriptions in the Latin language, to abbreviate well-known words, to use symbols for weights and measures, and to commence each prescription with the symbol *R*, which signifies *Recipe*, take. As an illustration, we append a prescription for a tonic draught:

(Name of Patient.)

R. Infus. Calumbæ,	f. ʒiʒ
Tinct. Calumbæ,	f. ʒi
Acid. Sulph. Dilut.,	℥x
Syrup. Aurant.,	f. ʒiiss

M. Fiat Haustus ter quotidie sumendus.

Date (in Latin).

(Initials or name of prescriber.)

**PRESCRIPTION**, in Law, is the limit of time within which one may acquire certain legal rights, by reason of the want of vindication by some other person of such rights, and putting in force his legal remedies. In England, however, it has a limited meaning, confined to a certain class of rights relating to lands, such as rights of way, of water-course, of fishing, shooting, &c.; while in Scotland, it is a general term, applicable to all legal rights and to real property; and hence prescription in Scotland corresponds to prescription, *plus Limitation* (q. v.), in England. Prescription in England is thus a

## PRESENTATION—PRESERVES, PRESERVED PROVISIONS.

mode of acquiring a legal right, incident to land, by the mere force of claiming and exercising it, without dispute, for a certain length of time. Thus, if a neighbouring owner has for 30 years, without interruption, actually enjoyed a right of common, such as pasture, fishery, shooting, &c., over another's lands, he will be entitled to it as a legal right for ever after, unless in certain exceptional cases; and if he has enjoyed it for 60 years, his title for ever after cannot be defeated. So, if a person has for 20 years enjoyed, without interruption, a right of way, or of watercourse, or of watering cattle, and similar Easements (q. v.) on another's lands, he will be entitled, for ever thereafter, to enjoy these, except in a few exceptional cases; and if the enjoyment has been for 40 years, he is entitled in all circumstances. So, if a person whose house adjoins another's lands, and whose windows open upon such land, has enjoyed the light coming to these windows for 20 years, he can for ever thereafter prevent his neighbour from building on his land, and thereby darkening such lights. In Scotland, prescription includes such rights as have been already mentioned, and also the other substantive rights of property. With respect to servitudes, such as right of way, water-course, fuel, feal, and divot, the right can be gained by the enjoyment for 40 years. Prescription is divided into positive and negative. By the positive prescription, whenever one enjoys lands for 40 years, and can shew an infetment, or a series of infetments, during such time, though no previous title at the commencement of such period, such person obtains a right to the property. This enactment applies to all kinds of heritable subjects, including leases and servitudes, which require no infetment, and as to which mere possession for 40 years, without interruption, will give the right. By the negative prescription of 40 years, rights are cut off, unless sued for within that period as a debt due on a heritable bond, and on all contracts whatever. Servitudes are also lost by the lapse of 40 years without enjoyment. Besides these prescriptions, there are others, called the lesser prescriptions. Thus, there is a 20 years' or vicennial prescription, applicable to certain written contracts; a ten years' or decennial prescription, applicable to actions against tutors and curators; a seven years' or septennial prescription, applicable to actions against cautioners; a sexennial or six years' prescription, applicable to actions on bills of exchange; a quinquennial or five years' prescription, applicable to actions for arrears of rent and verbal contracts; a three years' or triennial prescription, applicable to actions on ordinary merchants' accounts, for servants' wages, rent due on a verbal lease, and for work done by workmen, attorneys, &c. With regard to crimes, also, in Scotland but not in England, a 20 years' prescription applies, and no prosecution is competent after that period.

**PRESENTATION** is the act by which a patron of a living in the Established Church of Scotland appoints a minister; and it is so called because the presentee must be presented to the presbytery for inquiry into his qualifications, and for induction, if these are satisfactory. If the patron fail to present within six months, the right then devolves on the presbytery. When a presentee was objected to by the major part of the congregation, whether with or without reason, the General Assembly of the church formerly claimed the right to declare that he should not be inducted or entitled to the benefice. This declaration was contained in an act of Assembly, dated 1835, called the Veto Act. But after much litigation, it was decided by the courts of law that such Veto Act was *ultra vires* and void; and this decision led to a

secession of many ministers and people from the Established Church, and to the formation of a new dissenting church, called the Free Church (q. v.). The law is now settled that it is the presbytery, and not the people, who are to judge of the reasonableness of any objections made to the presentee, for which purpose, reasons and objections are heard on both sides, and a wide discretion is exercised by the presbytery. If the presbytery dismiss the objections, they then proceed to the trial and Induction (q. v.) of the presentee.

**PRESENTMENT** is, in English Law, the formal representation made by a grand-jury of the finding of an indictment; by churchwardens to the ordinary of the state of the parish; by the Court of Quarter Sessions of the fact of the disrepair of a bridge, &c. Presentment, with reference to bills of exchange, is the formal demand made by the creditor to the debtor, who is primarily liable, calling upon him to accept the bill or to pay it. If the bill is not paid, then notice of dishonour must be sent to the other parties secondarily liable, who are then bound. See **BILLS OF EXCHANGE**.

**PRESERVES, PRESERVED PROVISIONS, &c.** Much variety is comprehended under these terms: the first is generally understood to mean fruits preserved with sugar or brandy; and the latter, such articles of animal or vegetable food as are used ordinarily, but which are preserved by any means for the convenience of carriage, and for use beyond the time they would remain uninjured by ordinary keeping. Fruits intended for confectionary are preserved in four different ways: First, They may be preserved in the form of jam, in which the fruit is simply boiled with from one-half to equal its weight of sugar. By this method, the fruit becomes broken, and the juice set free; but all is preserved, as the latter forms a thick syrup with the sugar. Such preserves can be kept, if well made, for several years, but are best used during the first winter. A second plan is to preserve only the juice, which, when carefully strained from the solid portions of the fruit, and boiled with a third or half its weight of refined sugar, constitutes the fruit-jellies of the cooks and confectioners. Another method is called candying, and consists in taking fruits whole or in pieces, and boiling them in a clear syrup previously prepared. In this way, they absorb the syrup, and are then dried by a gentle heat, which causes the sugar of the syrup to crystallise on the surface and through the substance of the preserved fruits, which retain their form, and much, if not all their colour. The remaining method is to carefully stew them in a weak syrup of refined sugar and water, so that they are rendered soft, but are not broken. They are then transferred, with the syrup, to jars with well-prepared covers, to prevent evaporation; and pale brandy, equal in quantity to the syrup, is added. As a rule, only stone-fruits, such as peaches, plums, and cherries, are preserved in this way. Several fruits and vegetables, such as olives, cucumbers, cabbage, &c., are preserved for food in a saturated solution of salt and water poured in hot; others, in vinegar. See **PICKLES**.

But the most approved methods of preserving vegetable and animal substances for food-purposes, so as to be used as nearly as possible as if they were in the fresh state, is either to dehydrate them, or to seal them in air-tight cases. The first method was introduced by M. Chollet of Paris in 1852, and patented in England in 1854. It was, and still is, chiefly applied to vegetables, and a few kinds of fruit, such as apples and pears, which have a small amount of juice. By his method, M. Chollet



## PRESSES OF MEETING—PRESS, FREEDOM OF THE

entirely removes all moisture from the vegetables, by drying either in a vacuum or by the aid of heated air, which reduces their bulk more than one-half. They are then compressed under powerful presses, which, beside rendering them extremely portable, also makes them less liable to absorb moisture from the atmosphere, which is very desirable, as they are very absorbent. In this way, both the colour and distinctive flavour of the vegetables are completely preserved, and mere soaking in water restores them almost precisely to their original condition. The introduction of this process has been of great benefit to voyagers, as it enables ships to carry a complete supply of vegetable provisions on the longest voyage.

The method of sealing cooked provisions in airtight metallic cases, which is now so largely in use, is of comparatively recent invention, and has only been brought into use during the present century. In 1810, Augustus de Heine took out a patent in this country for preserving food in tin or other metal cases, by simply exhausting the air by means of an air-pump; but it was unsuccessful. It was followed by a number of others by various persons, all of which were more or less failures, until Wertheimer's patents, which were three in number, from 1839 to 1841. By his plan, the provisions of whatever kind are put into the metal cases, and closely packed, and the interstices filled in with water or other appropriate liquid, such as gravy in the case of flesh-food. The lids are then soldered on very securely; two small perforations are made in each lid, and the cases are set in a water-bath, in which muriate of lime is dissolved, and heat is applied until the whole boils, and the air is expelled through the small openings in the lids of the cases. When this is complete, which the operator knows by practice, the small holes are quickly soldered up, and the tins are removed from the bath. The muriate of lime is used because its solution can easily be maintained at a heat of 270° to 280° Fahr., without material evaporation. When required for use, it is usual to put the tin-case in a proper vessel, and cover it with water until it boils. The top is then removed by a knife made for the purpose, and the contents are turned out into a dish ready for the table. Henry Gunter, Stephen Goldner, and others patented plans similar in principle, but varying in the mode of applying it. Latterly, a large business of this kind has been successfully carried on by John Gillon & Co., Leith, whose cases of preserved meats and soups are well known as an article of commerce. But the plan in use now is that just described. A very ingenious and scientific plan for preserving meat fresh was invented by Professor George Hamilton of Cheshire. It consists in cutting the meat small, and putting it into jars of binoxide of nitrogen, which perfectly preserves its sweetness and ordinary appearance. This plan has been tried with success on a small scale, and was shewn in the Paris Exhibition of 1855 as a French discovery, although Professor Hamilton's paper was in Paris in 1854.

**PRESSES OF MEETING**, a name given in Scotland to the chairman of a meeting, who is often popularly believed to have some mysterious power or authority; but in point of fact, he has no more power than any other person present, and is merely, for convenience, used as a mouthpiece for putting questions and amendments to ascertain the will of the majority. In meetings of creditors under the Bankrupt Act, a preses requires to be elected before any business is done; but his power is confined to that of constituting the meeting, and preserving order, so far as the creditors mutually

agree to obey his suggestions. As a general rule, a preses, or chairman, has only a single vote, like other persons, and not a casting vote, unless where some act of parliament expressly gives it to him, according to the nature of the meeting held.

**PRESS, FREEDOM OF THE**, the expression used to denote the absence of any authorised official restraint on publication. The press is an instrument well adapted for disturbing the functions of government, and committing injuries against reputation; and when its power as a political engine was first discovered, the European governments took it into their own hands, no one being allowed to print any work till it had obtained the sanction of the proper authorities. The clergy also, on behalf of the papal hierarchy, claimed a share in the censorship, where questions of religion were concerned. In England, at the Reformation, the control of the press came to be more completely centred in the crown than elsewhere, the ecclesiastical in addition to the secular department being vested in Henry VIII. as temporal head of the church. The Company of Stationers, who came to have the sole right to print, were servants of the government, subject to the control of the Star Chamber. The censorship of the press was enforced by the Long Parliament, and was re-established more rigorously at the Restoration. It was continued at the Revolution, and the statute regulating it was renewed from time to time till 1693, when the Commons, by a special vote, struck it out of the list of temporary acts to be continued. Since that time, the censorship of the press has ceased to exist in Britain. But though there are no official restrictions on what shall and what shall not be published, the authors and publishers of criminal or injurious matter are amenable to the law of libel; and there are certain statutory requirements in force to enable them to be traced. The existing statutes which apply to all printed publications are 39 Geo. III. c. 79, amended by 51 Geo. III. c. 65, and 2 and 3 Vict. c. 12. Every person who possesses a printing-press or types for printing, and every typefounder, must give notice to the clerk of the peace. Every person selling types must give an account of all persons to whom they are sold. Every person who prints anything for hire or reward must keep one copy at least of the matter printed, and write on it the name and place of abode of the person who employed him to print it. By statute 2 and 3 Vict. c. 12, every person who shall print any paper meant to be published, must print on the front of the paper, or on the first or last leaf, his name and usual place of business; and on failure to do so, he forfeits the sum of £5, which penalty can, however, be sued for only in name of the Attorney or Solicitor-general, or the Lord Advocate of Scotland. A few exceptions exist to the above requirement in the case of papers printed by parliament or government offices, engravings, auction lists, bank-notes, bills of lading, receipts for money, and a few other instances. The statutes affecting newspapers are 60 Geo. III. and 1 Geo. IV. c. 9, 2 Geo. IV. and 1 Will. IV. c. 73, and 6 and 7 Will. IV. c. 76. The publisher of a newspaper must, under a penalty of £20, enter into a recognisance or bond of £400 or £300, together with sureties to pay any fine that may be adjudged against him for publishing a blasphemous or seditious libel. Before publication, he must furnish the correct title of his newspaper, and the names and addresses of the printer, publisher, and (with certain restrictions) of the proprietors. At the end of every newspaper must be printed the Christian name and surname of the printer and publisher. A copy must also be sent to the Stamp Office, authenticated so that it may be produced in evidence at any trial. The

penalties against newspapers can only be sued for in the name of the Attorney-general or Solicitor-general, or Lord Advocate, or an officer of Inland Revenue. Certain regulations also exist regarding plays, for which see THEATRE. Subject to these restrictions, the freedom of the press has subsisted in Britain since 1693.

A more or less rigorous censorship of the press exists in most European states. There is often no direct supervision previous to publication, but the official censor has it in his power to stop any publication which he deems objectionable, to confiscate the edition, and to prosecute the author and editor. Newspapers and pamphlets are generally subjected to a stricter censorship than larger works.

**PRESSING TO DEATH.** See **PRINE FORTE ET DURE**.

**PRESSIRO'STRES**, a tribe of birds of the order *Grallatores*, distinguished by a bill of moderate size, not so strong as in the *Cultrirostris*; whilst the hind toe is either wanting, or so short as not to touch the ground. To this tribe belong bustards, plovers, lapwings, oyster-catchers, &c.

**PRESSTI'SSIMO** (Ital. very quick) is the most rapid degree of movement known in musical composition.

**PRESTER JOHN.** See **JOHN, PRESTER**.

**PRE'STO** (Ital. quick), in Music, a direction that a piece should be performed in a rapid lively manner.

**PRESTON**, an important manufacturing and market town, a municipal and parliamentary borough in Lancashire, on the north bank of the Ribble, and at the head of the estuary of that river, 23 miles north-north-east of Liverpool. It occupies an eminence 120 feet above the Ribble, and it covers an area 2 miles square. The houses are mostly built of brick, and the town is on the whole well laid out, and is surrounded with pleasing scenery. The river is crossed by two bridges and a railway viaduct. There are 13 churches and twice that number of Catholic and dissenting chapels; among the other buildings and institutions, the chief are, a free grammar school, founded in 1663, and having an income from endowment of £150 per annum, and numerous other schools, the Institution for the Diffusion of Useful Knowledge, Town-house, Corn Exchange, House of Correction, and court-house. Linen manufactures were formerly the staple, and though still extensive, have been supplanted by the cotton manufacture, which now holds the first place. P. contains in all about 90 cotton-mills, which give employment to about 27,500 hands. There are also iron and brass foundries, iron shipbuilding yards, carriage-works, and machine shops; and malting, brewing, and ropemaking are also carried on. P. is a free port, and is reached at spring-tides by vessels drawing 14 feet. In 1863, 1064 vessels, of 61,202 tons entered and cleared the port. Its imports are chiefly corn, iron, and timber; its exports principally coal. Four great fairs are held here during the year, besides the usual weekly markets. The borough returns two members to the House of Commons.

P., that is, Priest's Town, so-called, probably, from the number of its religious edifices, the remains of some of which are still visible, is of high antiquity. It arose after the decline of Ribchester (the Roman *Rigodunum*), now a village some miles higher up the Ribble. P. was partially destroyed by Bruce in 1322; and after declaring for the king, it was taken by the forces of parliament under General Fairfax. Here also ended the ill-fated Jacobite rising of 1715, when, after a brave resistance,

the insurgents were compelled to surrender. See **DERWENTWATER**.

**PRESTON PA'NS**, an inconsiderable village of Haddingtonshire, with a station on the North British Railway, 8½ miles east of Edinburgh. Salt-pans are supposed to have been erected here as early as the 12th c., and the village was the seat of thriving manufacturing operations for many years after the Reformation. The only manufacture with which its name is now associated is that of a light bitter beer. In the vicinity, on the 21st September 1745, was fought the famous battle of P., between the royal troops under Sir John Cope, and the Jacobites under Prince Charles, in which the latter, with a loss of only about 10 officers and 120 men in killed and wounded, routed the royal forces with great slaughter, and captured their cannon, baggage, and military chest. Pop. (1861) 1577.

**PRESUMPTION** is an inference drawn by the law in certain circumstances or conditions of facts, and is used generally as a mere starting-point in an argument or litigation. Presumptions are often divided into *presumptio juris* and *presumptio juris et de jure*. The former serves as a mere starting-point, and may be rebutted by proof to the contrary. Thus, a person who has possession of goods, is presumed to be the owner till the contrary is proved. A man is presumed to be innocent until the contrary is proved. A *presumptio juris et de jure* is said to be a presumption which cannot be rebutted; but there are few instances of this. Presumptions abound in all departments of the law, and are adopted from the necessity of coming to some conclusion or other in most cases where the evidence is general or inconclusive. Thus, a common illustration is where two persons are drowned at sea, and legal rights depend on the fact which of them survived the other. In such a case, it is presumed, by the law of some countries, that the younger person survives; but there is no presumption in England. But in case of mother and child dying during delivery, the presumption is that neither survived. If a person disappear, and is not heard of, he is presumed to be living. But by an act of parliament this presumption was put an end to, or at least was not allowed to interfere with the right of a married woman to consider herself a widow, after her husband has left her, and has not been heard of for seven years.

**PRETENCE, ESCUTCHEON OF, or ESCUTCHEON SURTOUT**, in Heraldry, a small shield placed in the centre of the field of another shield. The husband of an heiress may bear the arms of his wife in an escutcheon of pretence, instead of impaling them. Feudal arms are also sometimes placed on an escutcheon of pretence, particularly in the insignia of elective sovereigns, who have been in use of bearing their own proper arms in surtout over those of the dominions to which they are entitled. The crown of Charlemagne is placed in surtout in the arms of Hanover; and from 1801 till the accession of Queen Victoria, the Hanoverian insignia occupied an escutcheon of pretence in the centre of the royal arms of the United Kingdom.

**PREVOST-PARADOL**, **LUCIEN ANATOLE**, a distinguished French littérateur, born at Paris, 8th August 1829, studied at the Collège Bourbon and the Ecole Normale; and in 1851, obtained from the Académie Française the prize for eloquence, for his *Eloge de Bernardin de Saint-Pierre*. In 1855, he was named to the chair of French Literature by the Faculty of Aix; but in the following year resigned it, and became one of the editors of the *Journal des Débats*, to which he has contributed a great number of articles remarkable for their precision and

refinement of thought. His literary and political essays are among the soundest, the most acute, the most scholarly, and the most elegant that have proceeded from the French journalists of the Empire. We may mention in particular his *Elisabeth et Henri IV.*; *Jonathan Swift* (in Latin); *Revue de l'Histoire Universelle* (1854); *Du Rôle de la Famille dans l'Éducation* (1857); *Nouveaux Essais de Politique et de Littérature* (1862).

PRIAM, in Homeric legend, was king of Troy at the time of the Trojan war. His father was named Laomedon, and his mother Strymo or Placia. P. is said to have been originally called *Podarkes* (the Swift-footed), but to have received his later and better-known appellation (from *Priamoi*, to ransom) on account of having been ransomed by his sister Hesione from Herakles, into whose hands he had fallen. His first wife was Arisbe, daughter of Merops, whom he gave away to a friend in order to marry Hecuba, by whom, according to Homer, he had nineteen sons; but as his intercourse with the other sex was not limited to Hecuba, the epic poet gives him in all 50 sons; while later writers add as many daughters. The best-known of these are Hector, Paris, Delpheobos, Helenus, Troilus, and Cassandra. P. is represented as too old to take any active part in the Trojan war; and in Homer, only once appears on the field of battle. The oldest Greek legends—i. e., the Homeric, are silent respecting his fate; but the later poets—Euripides, Virgil, &c.—say that he was slain by Pyrrhus at the altar of Zeus Herkeios, when the Greeks stormed the city.

PRICE, RICHARD, was born at Tynton, in Wales, on 22d February 1723. His father, Rice Price, was a dissenting minister, possessed of some wealth, and remarkable for his intolerance. A leading characteristic of his son's mind, on the other hand, was the calm resolution with which, from his youth, he declared his own opinions, and advocated freedom of thought for others. He declined to bend his convictions to paternal authority; accordingly, on his father's death, Richard was so poorly provided for, that, having resolved to prosecute his studies in London, he was obliged to make the journey chiefly on foot. He obtained admission to a dissenting academy, where he acquired a good knowledge of mathematics, philosophy, and theology. At the end of four years, he engaged himself as chaplain to a Mr Streatfield, with whom he lived for thirteen years. Mr Streatfield, on his death, left P. some property; and his circumstances having been further improved by the death of an uncle in 1757, he was enabled to carry out a matrimonial engagement which he had formed with a Miss Blundell.

He then settled as a preacher at Hackney; but being shortly afterwards chosen minister at Newington Green, he removed to that place, where he lived till the death of his wife in 1786, when he returned to Hackney. Meanwhile, his life had been one of considerable literary and scientific activity. His *Review of the Principal Questions and Difficulties in Morals* (Lond. 1758), though a somewhat heavy work, established his reputation as a metaphysician and a moralist. In 1769, the degree of Doctor of Divinity was conferred on him by the university of Glasgow. In the same year, he published his *Treatise on Reversionary Payments*; this was followed by the compilation and publication of the celebrated *Northampton Mortality Tables*, and various other works relating to life-assurance and annuities, forming most valuable contributions to the branch of science to which they refer. In 1776, appeared his *Observations on Civil Liberty and the Justice and Policy of the War with America*. Of this work,

60,000 copies are said to have been sold in a few months. So greatly was it admired in the United States, that, in 1778, the American Congress, through Franklin, communicated to him their desire to consider him a fellow-citizen, and to receive his assistance in regulating their finances; an offer declined principally on the ground of age. He died April 19, 1791. P. was a believer in the immateriality of the soul, holding that it remained in a dormant state between death and resurrection. Their difference of opinion on this subject led to a controversy of some celebrity between him and his friend Dr Priestley. His views respecting the Son of God were what is called Low or semi-Arminian. His moral character appears to have been a singularly beautiful one. 'Simplicity of manners,' says Dr Priestley, 'with such genuine marks of perfect integrity and benevolence, diffused around him a charm which the forms of politeness can but poorly imitate.' See *Memoirs of the Life of Richard Price, D.D.*, by William Morgan, F.R.S., Lond. 1815.

PRICHARD, JAMES COWLES, a distinguished ethnologist and physician, was born at Ross, in Herefordshire, on the 11th of February 1786. His father, Thomas Prichard, a member of the Society of Friends, and a merchant, had been married young, and was early left a widower with four children, upon whose education he bestowed the greatest care. Of these children, James Cowles, the eldest, was educated at home under private tutors. He learned Latin and Greek from a Mr Barnes; French from an *émigré* named De Rosemond; and Italian and Spanish from an Italian named Mordenti—while his father himself taught him history, for the study of which young P. shewed a strong predilection. At Bristol, where his father resided for some time in the pursuit of his business, the embryo ethnologist gave the first indications of his love for the study in which he afterwards became famous. On the quays, he met with foreigners from every country, and took much interest in observing their physical appearance, occasionally conversing with the sailors and others, as well as he was able, in their native tongues. On retiring from business, his father again took up his abode at Ross, where the son continued to pursue his studies under private tutors. When the time for choice of a profession arrived, young P. chose that of medicine as the one he thought most akin to his ethnological pursuits. He accordingly became a student of medicine, first at Bristol, afterwards at St Thomas's Hospital, London, and finally at Edinburgh, where he took his degree of M.D. Before commencing practice, however, he entered himself a student at Trinity College, Cambridge, where he read mathematics and theology for the most part. Subsequently, he studied at St John's College and Trinity College, Oxford. In 1810, he commenced practice in Bristol as a physician. His talents were soon recognised, both privately and publicly. He was first appointed physician to the Clifton Dispensary and St Peter's Hospital, and afterwards physician to the Bristol Infirmary. In 1813, he published his first work, *Researches into the Physical History of Mankind*, which at once gave him a high standing as an ethnologist. Of this, a second and enlarged edition, in two vols., appeared in 1826; and a third, still further improved and enlarged, in five vols., appeared between the years 1836 and 1847. The second and third editions of this work, each in succession, gave remarkable proofs of the extraordinary zeal with which Dr P. pursued his ethnological investigations; and not only so, for at the same time he devoted himself much to the pursuit of philology, which he rightly

judged to be absolutely necessary to an enlarged study of ethnology. In a few years, he became acquainted, not only with the Teutonic and Celtic languages, but with Sanscrit, Hebrew, and Arabic; shewing a practical result of his studies in the publication of his work entitled *The Eastern Origin of the Celtic Nations*. In this publication, which appeared at Oxford in 1831, he compared the different dialects of the Celtic with the Sanscrit, Greek, Latin, and Teutonic languages, and succeeded in proving a strong affinity between them all, from which he argued in favour of a common origin for all the peoples speaking those languages. His theory has met with general acceptance; and the work in which it appeared, says Mr Norris, 'is admitted by the most distinguished philologists to be unsurpassed in ability and soundness, while not a few deem it to be that which has made the greatest advance in comparative philology during the present century.' A previous work—namely, his *Analysis of Egyptian Mythology*, first published in 1819, had the honour of being translated into German in 1837, and edited by A. W. Schlegel, who, however, took occasion to dissent from some of the author's views. In 1843, Dr P. published the first edition of his *Natural History of Man*, in 2 vols. Two other editions of this work appeared during the author's lifetime; and a fourth, ably edited and enlarged, by Mr Edwin Norris, was given to the world in 1855. Dr P.'s other published works are for the most part on medical subjects—namely, *History of the Epidemic Fevers which prevailed in Bristol during the years 1817, 1818, and 1819*, published in 1820; *Treatise on Diseases of the Nervous System* (1822); *A Treatise on Insanity and other Diseases affecting the Mind* (1835); and *On the Different Forms of Insanity in Relation to Jurisprudence* (1842). He also contributed various articles to the *Cyclopaedia of Practical Medicine* and to the *Library of Medicine*. As a tribute to his eminence as an ethnologist, Dr P. was elected President of the Ethnological Society; while, in recognition of his researches into the nature and various forms of insanity, he received the government appointment of Commissioner in Lunacy. This occasioned his removal from Bristol to London, where, unfortunately for the interests of science, he expired of rheumatic fever, on the 22d of December 1848, at the comparatively early age of 62. Dr P.'s fame as the greatest of ethnologists, which, during his lifetime, was universally acknowledged, remains undisturbed to this day, notwithstanding any difference of opinion as to his favourite doctrine of the unity of the human race, which he constantly upheld. He was the first to raise ethnology to the rank of a science, and in his work, *The Physical History of Mankind*, he has left behind him a noble monument of his genius, skill, and perseverance.

**PRICKLE** (*Aculeus*), in Botany, a strong and hard, elongated and pointed hair. See **HAIRS**, in *Botany*.—The prickle is connected only with the bark, and not with the wood, in which it essentially differs from the spine or thorn. Prickles are sometimes straight, sometimes curved. They have often a pretty extended base—of some definite shape—by which they are attached to the bark.

**PRICKLY HEAT** is the popular name in India and other tropical countries for a severe form of the skin-disease known as *Lichen*. It more frequently attacks strangers from temperate climates than the natives, although the latter are not altogether exempt from it. The sensations of itching and stinging which attend it are intense, and give rise to an almost irresistible propensity to scratching, which of course only aggravates the

irritation. Little or nothing can be done in the way of treatment, except keeping as cool as possible, but the remedies recommended in the article **LICHEN** may perhaps slightly alleviate the symptoms.

**PRICKLY PEAR**, or **INDIAN FIG** (*Opuntia*), a genus of plants of the natural order *Cactea* (q. v.), having a fleshy stem, generally formed of compressed articulations, sometimes of cylindrical articulations; leafless, except that the youngest shoots produce small cylindrical leaves, which soon fall off; generally covered with clusters of strong hairs or of prickles; the flowers springing from among the clusters of prickles, or from the margin or summit of the articulations, solitary, or corymbose-paniculate, generally yellow, rarely white or red; the fruit resembling a fig or pear, with clusters of prickles on the skin, mucilaginous, generally eatable—that of some species pleasant, that of others insipid. The fruit imparts a red colour to the urine. The prickles of some species are so strong, and their stems grow up in such number and strength, that they are used for hedge-plants in warm countries.—The **COMMON P. P.** or **L. F.** (*O. vulgaris*), a native of Virginia and more southern parts of North America, is now naturalised in many parts of the south of Europe and north of Africa, and in other warm countries. It grows well on the barest rocks, and spreads over expanses of volcanic sand and ashes too arid for almost any other plant. It is of humble growth; its fruit oval, rather larger than a hen's egg, yellow, and tinged with purple, the pulp red or purple, juicy, and pleasantly combining sweetness with acidity. It is extensively used in many countries as a substantive article of food. In the south of England, the P. P. lives in the open air, and occasionally ripens its fruit. In America, it is cultivated considerably to the north of its native region. Lime rubbish is often mixed with the soil in which it is to be planted. The fruit is imported into Britain, to a small extent, from the Mediterranean.—The **DWARF P. P.** (*O. nana*), very similar, but smaller, and having prostrate stems, is naturalised in Europe as far north as the sunny slopes of the Tyrol.—The **TUNA** (*O. tuna*), much used in some parts of the West Indies as a hedge-plant, and also valuable as one of the species which afford food to the cochineal insect, yields a pleasant fruit. It has red flowers, with long stamens, which display a remarkable irritability.

**PRIDE**, in Heraldry. A peacock, or other bird, when the tail is spread out in a circular form, and the wings dropped, is said to be 'in his pride.'

**PRIDEAUX**, **HUMPHREY**, an English scholar and divine, was born of an ancient and honourable family at Padstow, in Cornwall, May 3, 1648. He was educated first at Westminster School, under Dr Busby; and afterwards at Christ Church, Oxford, where he took the degree of B.A. in 1672. In 1676, he published an account of the Arundelian Marbles, under the title of *Marmora Ozontensia*, which greatly increased his fame as a scholar, and in the following year, took the degree of M.A. The *Marmora* procured for P. the friendship of the Lord Chancellor Finch (afterwards Earl of Nottingham), who, in 1679, appointed him rector of St Clement's at Oxford, and, in 1681, a prebendary of the cathedral of Norwich. After several minor preferments he was collated, in 1688, to the archdeaconry of Suffolk; and in 1702, was made Dean of Norwich. He died November 1, 1724. His principal works are, his *Life of Mahomet* (1697), which was long very popular, and has gone through many editions, but is now entirely superseded; and *The Connection of the History of the Old and New Testament* (1715—1718). The last of these treats

with much learning, but less discernment, the affairs of ancient Egypt, Assyria, Persia, Judea, Greece, and Rome, as far as they bear on the subject of sacred prophecy. P. was a zealous but not an intolerant churchman, most conscientious in the discharge of his own duties, equally anxious that others should do theirs, and possessed of a considerably greater share of piety than was usual in his age.

**PRIESSNITZ, VINCENT**, the founder of Hydro-pathy (q. v.), was born at Gräfenberg (q. v.), in Austrian Silesia, October 5, 1799. He was the son of a peasant-proprietor, and received at the school of Freiwaldau an education suitable to his station, and afterwards farmed his paternal estate. It appears that a neighbour, who had been in the way of healing trifling wounds on himself and others by means of cold water, treated P. successfully in this way for a serious injury from the kick of a horse; and P., having thus had his attention directed to the virtues of cold water, and being indisputably possessed of great sharpness of intellect and aptitude for the practice of the healing art, began to give advice to his neighbours how to cure all ailments with cold water, and soon attained considerable reputation among them. Although several times brought before the authorities for unlicensed practising, the simplicity of the means he used made it impossible to interfere with him. As the number of applicants for advice went on increasing, he gradually came, by experimental modifications of the way of applying his remedy, to form a kind of system of treatment for the various cases that presented themselves. At last, about 1826, strangers began to repair to Gräfenberg, and stay there for some time for treatment; in 1829, there were as many as 49 water-patients, and in 1837, the number had risen to 586. P. continued till 1833 to carry on his farming; but after that, his practice, and the care of the establishments which he had to provide for the reception and treatment of his patients, fully occupied him. He died November 28, 1851, leaving his establishment to his son-in-law. Very different judgments have been pronounced on the character of P. and his system of treatment, mostly according to the prejudices of the critics. He himself has left nothing in writing on his method of cure.—Wunde, *Die Gräfl. Wasserheilanstalt und die P.'sche Curmethode* (6th ed. Leip. 1845).

**PRIEST** (Gr. *presbyteros*, Lat. *presbyter*, Fr. *prêtre*), the title, in its most general signification, of a minister of public worship, but specially applied to the minister of sacrifice or other mediatorial offices. In the early history of mankind, the functions of the priest seem to have commonly been discharged by the head of each family; but on the expansion of the family into the state, the office of priest became a public one, which absorbed the duties as well as the privileges which before belonged to the heads of the separate families or communities. It thus came to pass that in many instances the priestly office was associated with that of the sovereign, whatever might be the particular form of sovereignty. But in many religious and political bodies, also, the orders were maintained in complete independence, and the priests formed a distinct, and, generally speaking, a privileged class (see *Egyptian Priests*, *Indian Priests*, below). The priestly order, in most of the ancient religions, included a graduated hierarchy; and to the chief, whatever was his title, were assigned the most solemn of the religious offices intrusted to the body. In sacred history, the patriarchal period furnishes an example of the family priesthood; while in the instance of Melchizedec, king of Salem, we find the union of the royal with the priestly

character. In the Mosaic law, the whole theory of the priesthood, as a sacrificial and mediatorial office, is fully developed. The priest of the Mosaic law stands in the position of a mediator between God and the people; and even if the sacrifices which he offered be regarded as but typical and prospective in their moral efficacy, the priest must be considered as administering them with full authority in all that regards their legal value. The Mosaic priesthood was the inheritance of the family of Aaron, of the tribe of Levi. It consisted of a high priest (q. v.), and of inferior ministers, distributed into 24 classes. The age for admission to the priesthood is nowhere expressly fixed; but from 2d Chronicles xxxi. 17, it would seem that the minimum age was 20. In the service of the temple, the priests were divided into 24 classes, each of which was subject to a chief priest, and served, each company for a week, following each other in rotation. Their duties in the temple consisted in preparing, slaying, and offering victims; in preparing the shew-bread, burning the incense, and tending the lights of the sanctuary. Outside, they were employed in instructing the people, attending to the daily offerings, enforcing the laws regarding legal uncleanness, &c. For their maintenance were set aside certain offerings (see *FIRST-FRUITS*) and other gifts. They wore a distinguishing dress, the chief characteristics of which were a white tunic, an embroidered cincture, and a turban-shaped head-dress. The Jewish priesthood may be said to have practically ceased with the destruction of the temple.

In the Christian dispensation, the name primitively given to the public ministers of religion was *presbyteros*, of which the English name 'priest' is but a form derived through the old French or Norman *prestre*. The name given in classical Greek to the sacrificing priests of the pagan religion, Gr. *hierews*, Lat. *sacerdos*, is not found in the New Testament explicitly applied to ministers of the Christian ministry; but very early in ecclesiastical use, it appears as an ordinary designation; and with all those bodies of Christians, Roman Catholics, Greeks, Syrians, and other orientals who regard the Eucharist as a sacrifice (see *MASS*), the two names were applied indiscriminately. The priesthood of the Christian church is one of the grades of the Hierarchy (q. v.), second in order only to that of bishop, with which order the priesthood has many functions in common. The priest is regarded as the ordinary minister of the Eucharist, whether as a sacrament or as a sacrifice; of baptism, penance, and extreme unction; and although the contracting parties are held in the modern schools to be themselves the ministers of marriage, the priest is regarded by all schools of Roman divines as at least the normal and official witness of its celebration. The priest is also officially charged with the instruction of the people and the direction of their spiritual concerns, and by long-established use, special districts, called Parishes (q. v.), are assigned to priests, within which they are intrusted with the care and supervision of the spiritual wants of all the inhabitants. The holy order of priesthood can only be conferred by a bishop, and he is ordinarily assisted by two or more priests, who, in common with the bishop, impose hands on the candidate. The rest of the ceremonial of ordination consists in investing the candidate with the sacred instruments and ornaments of his order, anointing his hands, and reciting certain prayers significative of the gifts and the duties of the office. The distinguishing vestment of the priest is the *chasuble* (Lat. *placida*). In Roman Catholic countries, priests wear even in public a distinctive dress, which, however, in some

respects is common to them with the other orders of the clergy. In the Latin Church, priests are bound to a life of celibacy. In the Greek and oriental churches, married men may be advanced to the priesthood; but no one is permitted to marry after ordination, nor is a married priest permitted to marry a second time, should his wife die.

In the Church of England, and other Reformed Episcopal Churches, the term priest is retained as the designation of the second order of clergy, whose special office it is (1) to celebrate the Sacrament of the Lord's Supper; (2) to pronounce the forms of Absolution in the Morning and Evening Prayer, in the Communion Service, and in the Office for the Visitation of the Sick; and (3) to preach, though this last office is, by special licence, sometimes extended to deacons.

Priests only can hold a benefice with cure of souls. The age for admission into the priesthood is 24 years. (For the manner and ceremonies of admission, see ORDINATION.) Priests in the Church of England are ordinarily distinguished during divine service by a black stole of silk worn upon the surplice over both shoulders; deacons, according to the ancient use, wearing it over one shoulder only. Marriage is permitted in the Church of England to all orders of the clergy.

*Egyptian Priests.*—In the political division of Egypt, the population is supposed to have been divided into three or four castes, at the head of which was the sacerdotal, or priests. This division, however, was not very strictly observed, as the son did not invariably follow the profession of the father. That of the priest appears most honourable, and two principal classes of priests were in existence at the earliest periods—the *hont*, or prophets, and the *ab*, or inferior priests. The first were attached to the worship of all the deities of Egypt; and in the greater cities, there was *hont api*, high prophet, or priest, who presided over the others; at Thebes there were as many as four prophets of Ammon. Their duties appear to have comprised the general cultus of the deity. They also interpreted the oracles of the temples. Besides the prophets of the gods, others were attached to the worship of the king, and to various offices connected with the administration of the temples. The class of priests called *ab*, or 'pure,' were inferior, and were also attached to the principal deities and to the personal worship of the monarch. They were presided over by a superintendent, but had no high priest. A third class of priests, the *karheb*, appear in connection with funeral and other ceremonies, and some other inferior persons of the hierarchy. The *scribes* formed a caste apart, but those who were attached to the temple were of the priestly order. Besides these above mentioned, the Greeks enumerate a variety of sacred officials. The administration of the temples by the hierarchy was as follows: the temple was governed by a superintendent, or *epistetes*, called in Egyptian *mer*, either the high priest or a prophet. Under him was a vicar, and a royal officer, called *epimeletes*, or overseer, by the Greeks. These attended to the receipts and expenses. Lay brethren, or *hierodules*, attended and assisted the priests in their functions; and in addition to these, there were a kind of monks in the Serapeum, who lived within the precincts of the temple, which they were not allowed on any account to quit. At Alexandria, under the Ptolemies, there was a priest of Alexander the Great, and others attached to the worship of the deceased Ptolemies, and also one attached to the worship of the living monarch. This priest, it appears, was nominated by the king himself, and drew a revenue from the different temples of Egypt.

He was at this period the high priest of the whole country, and had no doubt superseded the former high priest of Ptah at Memphis, and of Amen-Ra at Thebes, who had formerly exercised a kind of pontificate. On solemn occasions a synod of the priests was held for purposes affecting the whole body. Some light has been thrown on the relative dignities of the hierarchy by the hieroglyphical inscription on a statue of Bakenkhonsou, a high priest of Amen-Ra, now at Munich. At the age of 16, he held a civil employment under Sethos I.; he was then made priest *ab* of Amen-Ra, which office he exercised for four years; after this, he rose to the rank of 'divine father' of the god, which office he held for 12 years; after that, he became third prophet of the same deity for 15 years; then second prophet for 12 years; and finally, at the age of 59, chief prophet or high priest of the god—held the post for 27 years, and died at the age of 86. The youthful age at which offices were held was probably owing to the careful education which the young priests had to undergo, and the habits required for the order. They were required to be scrupulously neat and clean, entirely shaven, clad in linen, and shod with papyrus sandals, and to maintain a rigid diet, in which was a careful abstaining from pork, mutton, beans, and salt, to which was added a bath twice a day, and other ablutions. They also fasted, and one of their fasts lasted 42 days; others even longer; they then lived on vegetable food alone, and exercised a rigid continence. They were, however, not unmarried, but allowed one wife. Their support was derived from various sources—as from royal and other endowments of the temples, from the gifts of votaries, and from charges on the produce of the country. On festivals, not only were they often clad in fine linen, but the addition of a panther-skin was often added to their attire; and they were anointed with perfumes and unguents. They offered water and burning incense. Although Herodotus has stated that no woman was a priestess in Egypt, many functions connected with the temples were held by women. The most important was that of 'divine wife of Amen-Ra,' called by Diodorus the *pallakis*, or concubine, of Jupiter, which was conferred upon queens and princesses only. Another title was that of 'divine hand,' or adorer of the same god, a rank also held by royal personages. During the 4th dynasty, at the time of Cheops and the pyramids, there were prophetesses; but the order does not appear to have been kept up, for at a later period there only appear the *sua*, or singing women of the gods, and the *aha*, or performers, of the principal deities, who attended with *sistra* at the festivals. Besides these, other women had charge of certain things connected with the temple, and *canephoroi*, or basket-bearers. They had no distinctive dress, and were often the wives of prophets or other priests.—Boeck, *Corp. Inscr. Græc.*, p. xxix., p. 303; Schmidt, *De Sacerdot. Ægyptior.*; Wilkinson, *Manners and Customs*, vol. i. p. 257; Devéria, *Monument de Bakenkhonsou* (Paris, 1862).

*Indian Priests.*—The priesthood of India belongs to the first caste, or that of the Brâhman's exclusively; for no member either of the Kahattriya or the Vaisya, or the S'ûdra caste is allowed to perform the functions of a priest. But as the proper performance of such functions requires, even in a Brâhman's, the knowledge of the sacred texts to be recited at a sacrifice, and of the complicated ceremonial of which the 'sacrificial acts consist, none but a Brâhman's learned in one or more Vedas (q. v.), and versed in the works treating of the ritual (see KALPA-SÛTRA), possesses, according to the ancient law, the qualification of a priest;

and so strict, in ancient times, were the obligations imposed upon a priest, that any defective knowledge on his part, or any defective performance by him of the sacrificial rites, was supposed to entail upon him the most serious consequences both in this life and in the future. As the duration of a Hindu sacrifice varies from one to a hundred days, the number of priests required at such a ceremony is likewise stated to be varying; again, as there are sacrificial acts at which verses from the R'igveda only were recited, others requiring the inaudible muttering of verses from the Yajurveda only; others, again, at which verses only of the Sāmaveda were chanted; and others, too, at which all these three Vedas were indispensable—there were priests who merely knew and practised the ritual of the R'igveda, or the Yajurveda, or the Sāmaveda; while there were others who had a knowledge of all these Vedas and their rituals. The full contingent of priests required at the great sacrifices amounts to 16. Other inferior assistants at a sacrifice, such as the ladle-holders, slayers, choristers, and the like, are not looked upon as priests. Such was the staff of priests required at the great and solemn sacrifices, which took place on special occasions, and could be instituted only by very wealthy people; from one to four priests, however, sufficed at the minor sacrifices, or those of daily occurrence. These were the rules and practices when the Hindu ceremonial obeyed the canon of the Vaidik ritual; and the latter probably still prevailed at the epic period of India, though many deviations from it are perceptible in the Mahābhārata and Rāmāyaṇa (q. v.). But at the Paurāṇik period, and from that time downwards, when the study of the Vedas had fallen into disuse, and the Vaidik rites had made room for other ceremonies which required no knowledge on the part of a priest, except that of the reading of a prayer-book, and an acquaintance with the observances enjoined by the Purāṇas, but easy to go through, almost every Brāhman, not utterly ignorant, became qualified to be a priest.—For the priesthood of the Buddhists, Jains, and Tibetans, see BUDDHISM, JAINAS, and LAMAISM.

PRIESTLEY, JOSEPH, son of Jonas Priestley, a cloth-draper at Fieldhead, near Leeds, was born at Fieldhead on 13th March 1733, O.S. His mother having died when he was six years old, he was adopted by an aunt, by whom he was sent to a free school. There he learned Latin and Greek. During vacation, he taught himself various languages, both ancient and modern. For some time he was obliged to abandon his studies, owing to weak health: he then betook himself to mercantile pursuits. With returning strength, his literary studies were resumed, and successfully prosecuted at a dissenting academy at Daventry under Mr (afterwards Dr) Ashworth, successor to Dr Doddridge. Though his father and aunt were strong Calvinists, their house was the resort of many men who held very different opinions; and the theological discussions which he was in the habit of hearing, seem to have had much effect on young P.: before he was 19, he calls himself rather a believer in the doctrines of Arminius, but adds: 'I had by no means rejected the doctrine of the Trinity or that of the Atonement.' Before leaving home, he wished to join a Calvinistic communion, but he was refused admission, the ground of refusal being, that he had stated doubts as to the liability of the whole human race to 'the wrath of God and pains of hell for ever.' During his residence at the academy, he conceived himself called on to renounce nearly all the theological and metaphysical opinions of his youth. 'I came,' he says, 'to embrace what is called the heterodox side of every

question.' In 1755, he became minister to a small congregation at Needham Market, in Suffolk, with an average salary of £30 per annum. While here, he composed his work entitled *The Scripture Doctrine of Remission, which shews that the Death of Christ is no proper Sacrifice nor Satisfaction for Sin*. His leading theological doctrine seems to have been, that the Bible is indeed a divine revelation, made from God to man through Christ, himself a man and no more, nor claiming to be more. He seems to have rejected all theological dogmas which appeared to him to rest solely upon the interpretation put upon certain passages of the Bible by ecclesiastical authority. Even the fundamental doctrines of the Trinity and of the Atonement he did not consider as warranted by Scripture, when read by the light of his own heart and understanding. It does not, however, appear that these doctrinal errors produced any morally evil results. He not only contrived to live on £30 a year; but by adding a little to his income by means of teaching, he was enabled to purchase a variety of instruments to help him in his scientific studies. In 1758, he quitted Needham for Nantwich; and in 1761 he removed to Warrington, where he was appointed successor to Mr (afterwards Dr) Aikin, as teacher of languages and belles-lettres. At Warrington, he married Miss Wilkinson, a lady of great talent and amiability. Here his literary career may be said first fairly to have begun. A visit to London led to his making the acquaintance of Franklin and of Dr Price. The former supplied him with books which enabled him to write his *History and Present State of Electricity*, published in 1767. It was followed by a work on *Vision, Light, and Colours*. In 1762, he published his *Theory of Language and Universal Grammar*. In 1766, he was made a member of the Royal Society, and a Doctor of Laws by the university of Edinburgh. In the following year, he removed to Millhill, near Leeds, where he was appointed minister of a dissenting chapel. The fact of a brewery being beside his dwelling gave a new direction to his energetic and versatile mind; he began to study pneumatic chemistry, publishing various important works connected with this science. 'No one,' says Dr Thomson, 'ever entered on the study of chemistry with more disadvantages than Dr Priestley, and yet few have occupied a more dignified station in it.' While at Leeds, he agreed to accompany Captain Cook on his second voyage; but certain ecclesiastics having objected to the latitude of his theological views, the Board of Longitude refused to sanction the arrangement, and he did not go. In 1773, he was appointed librarian and literary companion to Lord Shelburn, with a salary of £250 per annum, and a separate residence. He accompanied the earl on a continental tour in the year 1774. Having been told by certain Parisian savans that he was the only man they had ever known, of any understanding, who believed in Christianity, he wrote, in reply, the *Letters to a Philosophical Unbeliever*, and various other works, containing criticisms on the doctrines of Hume and others. His public position was rather a hard one; for while laughed at in Paris as a believer, at home he was branded as an atheist. To escape the odium arising from the latter imputation, he published, in 1777, his *Disquisition Relating to Matter and Spirit*. In this work, while he partly materialises spirit, he at the same time partly spiritualises matter. He holds, however, that our hopes of resurrection must rest solely on the truth of the Christian revelation, and that on science they have no foundation whatever. The doctrines of a Revelation and a Resurrection appear with him to have supported one another. He

believed in a Revelation, because it declared a Resurrection; and he believed in a Resurrection, because he found it declared in the Revelation. On leaving Lord Shelburn, he became minister of a dissenting chapel at Birmingham. The publication, in 1786, of his *History of Early Opinions concerning Jesus Christ*, occasioned the renewal of a controversy, which had begun in 1778, between him and Dr Horsley, concerning the doctrines of Free Will, Materialism, and Unitarianism. The victory in this controversy will probably be awarded by most men in accordance with their own preconceived views on the questions at issue. His reply to Burke's *Reflections on the French Revolution* led to his being made a citizen of the French Republic; and this led to a mob on one occasion breaking into his house, and destroying all its contents, books, manuscripts, scientific instruments, &c. He states that the sum awarded to him as damage fell £2000 short of the actual pecuniary loss. A brother-in-law, however, about this time left him £10,000, with an annuity of £200. In 1791, he succeeded to the charge at Hackney, which had become vacant by the resignation of Dr Price. He did not remain long here, however. His honestly-avowed opinions had made him as unpopular as an honest avowal of opinions generally does. He removed to America, where he was received with respect, if not with enthusiasm. He had the offer of the professorship of Chemistry at Philadelphia, which he declined. In 1796, his wife died. To the day of his death, he continued to pursue his literary and scientific pursuits with as much ardour as he had shewn at any period of his active life. He died 6th February 1804, expressing his satisfaction with his having led a life so useful, and his confidence in immortality. At Paris, his *éloge* was read by Cuvier before the National Institute. He has given us his autobiography down to 24th March 1795. He was a man of irreproachable moral and domestic character, remarkable for zeal for truth, patience, and serenity of temper. He appears to have been fearless in proclaiming his convictions, whether theological, political, or scientific. See *Memoirs of his own life*, continued by his son with observations by T. Cooper. Also *life* by John Corry.

**PRILOUKY**, a district town of Little Russia, in the government of Poltava, and 150 miles north-west of the town of that name. Tobacco, corn, cattle, and tallow are the principal articles of trade, and are sold on the spot to dealers for export to Moscow, St Petersburg, Riga, Poland, and abroad. The climate is good, and the soil fertile. Pop. 10,484, most of whom are engaged in the cultivation of tobacco.

**PRIMA DONNA** (Ital.), the first female singer in an opera.

**PRIMARY** or **PRIMITIVE LIMESTONE**, the name formerly given to crystalline limestones, because it was supposed that they belonged to the oldest primary deposits. But as it is now known that many of these limestones are of much later origin, some even as late as the Tertiary Period, the name has fallen into disuse. See **MARBLE**.

**PRIMATE** (Lat. *primus*, Fr. *primat*, first) is the title of that grade in the hierarchy which is immediately below the rank of patriarch. The title strictly belongs to the Latin Church, but in its general use it corresponds with that of *exarch* (Gr. *exarchos*) in the Greek Church, although there were some *exarchs* who were not immediately subject (as were all *primates*) to a patriarch. This arose in the Eastern Church from the variation in the limits of the patriarchates, which were not of simultaneous origin; but in the West, where the patriarch (i. e.,

the Roman bishop) was recognised as possessing universal jurisdiction, this exemption of any particular primate from superior jurisdiction could not of course arise. The primate, as such, was the head of a particular church or country, and held rank, and, in some churches, a certain degree of jurisdiction, over all bishops and archbishops within the national church. This jurisdiction, however, was confined to the right of visitation and of receiving appeals. In Africa, the Bishop of Carthage, without the title, possessed all the rank and authority of a primate. The chief primatial sees of the West were: in Spain, Seville and Tarragona, afterwards united in Toledo; in France, Arles, Rheims, Lyon, and Rouen (among whom the Archbishop of Lyon claims the title of *Primat des Primats*, 'Primate of the Primates'); in England, Canterbury; in Germany, Mainz, Salzburg, and Trier; in Ireland, Armagh, and for the Pale, Dublin; in Scotland, St Andrews; in Hungary, Gran; in Poland, Gnesen; and in the northern kingdoms, Lund. In the Church of England the Archbishop of Canterbury is styled Primate of all England; the Archbishop of York, Primate of England.

In Ireland, the Archbishop of Armagh is Primate of all Ireland, and the Archbishop of Dublin Primate of Ireland. The title of Primate in England and Ireland confers no jurisdiction beyond that of archbishop. The name *primus* is applied in the Scottish Episcopal Church to the presiding bishop. He is chosen by the bishops out of their own number, without their being bound to give effect to seniority of consecration or precedency of diocese.

**PRIMATÉS**, the name given by Linnæus to the first order of Mammalia in his system, and which he placed first (whence the name, Lat. *primus*, first), because he ranked man amongst them, and accounted them highest in the scale of nature. He assigned as the characters of the order, incisor teeth in the front of the mouth, four in the upper jaw, in one row; mammae two, pectoral. In this order he placed four genera, *Homo* (in which he included man and the orang-outang), *Simia*, *Lemur*, and *Vespertilio*; corresponding to the *Bimana* (Man alone), *Quadrumana*, and *Cheiroptera* of Cuvier. That many of the P. of Linnæus really occupy a higher place in the scale of nature, either as to organisation or intelligence, than many other Mammalia, is more than doubtful.

**PRIME** (Lat. *prima*, the first—i. e., hour), the first of the so-called 'lesser hours' of the Roman **BREVIARY** (q. v.). It may be called the public morning-prayer of that church, and corresponds in substance with the morning service of the other ancient liturgies, allowance being made for Latin peculiarities. Prime commences with the beautiful hymn of Prudentius, *Jam lucis orto sidere*, which is followed by three, and occasionally four psalms, the last portion of which consists of the opening verses of the 118th (in the authorised version, 119th) psalm, which is continued throughout the rest of the 'lesser hours.' Prime concludes with prayers appropriate to the beginning of a Christian's day.

**PRIMOGENITURE** is the rule of law under which the eldest son of the family succeeds to the father's real estate in preference to, and in absolute exclusion of, the younger sons and all the sisters. This is the rule adopted in Britain and in most European countries, though latterly the policy of the rule has been disputed, and the contrary example of France pointed to as an example or a warning, according to the theory advocated. The rule operates as follows: whenever a man dies intestate, leaving real estate—i. e., lands and houses—his eldest son is the only person entitled by law to the whole; and if



the other brothers and the sisters are not otherwise provided for out of the personality they are left testate. If the eldest son is dead, but has left an eldest son, such grandson of the deceased, in like manner, succeeds to the whole lands exclusively, and so on, following in succession, the eldest sons of eldest sons, and their next eldest sons, one by one, in their order of seniority. But when the male line is exhausted, then females do not succeed in the same way singly and by seniority, but all together succeed jointly. Such is the rule in England and in Scotland. The preference of males to females was also the Jewish rule and the Greek rule, or at least that which prevailed at Athens; but it was unknown to the Romans. It is generally said our preference of males took its origin from the feudal system, by which the devolution of land depended on the personal ability of the party to perform military service. Our Danish ancestors seem not to have acknowledged any preference of the males, but the Saxons did so. Our law does not, like the Salic law, totally exclude females, but merely postpones them until the males are exhausted. Though, however, it is the general law of England, as well as Scotland and Ireland, there is one county in England, that of Kent, where, by ancient custom—called gavelkind—a different rule prevails, and the land, instead of going wholly to the eldest son, is divided equally among all the sons. So there is an exception, called Borough English, in some boroughs and cities of England, where the land, instead of going to the eldest son, goes wholly to the youngest son. The evils said to be attendant on the law of primogeniture are alleged to be, that it often produces great hardship, by making one of the family enormously rich, and the others very poor, thereby introducing a sense of inequality and injustice among those who are apt to believe themselves equals by the law of nature. It also tends to encourage the accumulation of landed property in a few hands, and thereby cuts off the great mass of the people from the gratification of a natural desire and from one incentive to industry—viz, the acquisition of a portion of the soil. On the other hand, it is said that the cases of hardship in reality seldom occur, for, especially in modern times, an equal amount of personal property is often held by the same owners, and the rule does not apply to personalty, which is equally divided among all the children. Moreover, the great landowners seldom die intestate, but almost invariably provide for their younger children by means of charges or burdens on the family estate, and so counteract the effect of the law of primogeniture. The accumulation of landed property is said to be not an evil, but the contrary, for it enables agriculture to flourish, inasmuch as the larger the farms, the greater is the capital required, and the greater benefit to the land, and ultimately to the public. The law of primogeniture in England is not as it is or was in Scotland, stereotyped in its most odious form by the practice of entailing the lands, and so locking them up for generations in one family, excluding them from commerce, and of necessity preventing the successive heirs in possession from making improvements. The evils of the Scotch entail system have long been exposed, and led, in 1848, to a relaxation of the law, by which the practice of disentailing the property is made more easy and frequent. But in England, land cannot be locked up for a greater period than the lives of persons in existence, and for 21 years more, after which the parties entitled can sell or bring the lands into the market at their discretion; so that it is not correct to say that the accumulation of land in the great families is caused by the law of primogeniture, for practically each

successive generation can do what it likes with the property, and squander it at will. It is only by the operation of the natural feelings of family pride that the family estates are kept together in a family. The mode in which this is practically done in England is as follows: the peer or head of the family being tenant for life, and the inheritance being entailed upon his eldest son, who is about to marry, the father and son take the proper legal steps (which they can always do jointly) for unsettling the estate, and obtaining the absolute dominion over it. They then proceed to resettle the estate, making the father as before tenant for life, then the son is reduced in his turn to a tenant for life also, after the father, instead of, as before, being tenant in tail, or full proprietor. Thus, the maintenance of the family dignity is secured for another generation by settling the inheritance on the eldest male issue of the intended marriage; and when the grandson attains the age of 21, or is about to marry, he and his father act in the same way towards the next generation. The English law of landed property has been said to answer admirably all the purposes to which it is applicable, for a testamentary power is given which stimulates industry, and encourages accumulation; and while capricious limitations, such as perpetual entails, are restrained, property is allowed to be moulded according to the circumstances and wants of every family.

**PRIMROSE** (*Primula*), a genus of plants of the natural order *Primulaceæ*, having a bell-shaped or tubular 5-toothed calyx, a salver-shaped corolla with five segments, five stamens, a globose germen containing many ovules, and a many-seeded capsule opening by five valves, and generally with ten teeth at the apex. The species are all herbaceous perennials, generally having only radical leaves; and the flowers in a simple umbel, more rarely with scapes bearing solitary flowers. Almost all of them are natives of Europe and the north of Asia. Some of them are among the finest ornaments of our groves and meadows; some are found in mountainous regions. Their fine colours and soft delicate beauty have led to the cultivation of



Common Primrose (*Primula Vulgaris*).

some of them as garden flowers, probably from the very beginning of floriculture. The name *P.* (*Fr. Primevère*, Lat. *Primula*) is derived from the Latin *primus*, first, and refers to the early appearance of the flowers of some of the most common species in spring.—The COMMON *P.* (*P. vulgaris*), abundant in woods, hedgebanks, and pastures in Britain and in most parts of Europe, has obovate-oblong, wrinkled leaves, and single-flowered scapes; the flowers about an inch broad, yellowish white. This is the plant to which the English name *P.* specially belongs. Akm

PRIMULACEÆ—PRINCE EDWARD ISLAND.

to it is the COWSLIP (q. v.), or PAIGLE (*P. veris*), and perhaps still more nearly related is the OXSLIP (*P. elatior*), apparently wild in some parts of England, particularly in the eastern counties, but supposed by some botanists to be intermediate between the Common P. and the Cowslip, which they therefore regard as extreme forms of one species.—The POLYARTHUS (q. v.) is a cultivated variety of the Cowslip.—The AUBICOLA (q. v.) (*P. auricula*), an Alpine species, is a favourite garden flower.—The BIRD'S EYE P. (*P. farinosa*) and the SCOTTISH P. (*P. Scotica*) are both flowers of exquisite beauty, found in the northern parts of Britain; the latter chiefly on the coasts of Sutherland, Caithness, and the Orkney Islands. The Alps and the Himalaya Mountains produce several species.—The CHINESE P. (*P. Sinensis*) has for more than thirty years been very common in Britain, not only as a greenhouse but a window plant. It produces compound umbels of very numerous lilac or white flowers, which are displayed in autumn, winter, and spring.

PRIMULACEÆ, a natural order of exogenous plants, containing more than 200 known species, mostly natives of temperate and cold regions. They are all herbaceous, or scarcely half-shrubby, with leaves generally all radical, and no stipules. The calyx is generally 5-cleft, inferior or half-superior, regular, persistent; the corolla, with the limb divided into as many segments as the calyx, rarely wanting; the stamens inserted on the corolla, one opposite to each of its lobes; the ovary one-celled, the style solitary, the stigma capitate; the capsule with a central placenta and many seeds.—Many of the P. have flowers of much beauty, and some are very fragrant, as the Primrose, Cowslip, Auricula, Fimpernel, Loosestrife, &c.

PRIMUM MOBILE. See PTOLEMAIO SYSTEM.

PRINCE (Lat. *princeps*, from *primus*, first, and *capio*, I take), an epithet which was originally applied to the *princeps senatus* of the Roman state, and afterwards became a title of dignity. It was adopted by Augustus and his successors; hence the word was afterwards applied to persons enjoying kingly power, more especially the rulers of small states, either sovereign, as in the case of the ancient Princes of Wales, or dependent, like the rulers of certain states in Germany. The title is now very generally applied to the sons of kings and emperors, and persons of the blood-royal. In various parts of continental Europe, the title Prince is borne by families of eminent rank, but not possessed of sovereignty; and in England, a duke is, in strict heraldic language, entitled to be styled 'High Puissant and most Noble Prince;' and a Marquess or Earl as 'Most Noble and Puissant Prince.' Practically, however, in Britain, the term prince is restricted to members of the royal family. The eldest son of the reigning sovereign is by a special patent created Prince of Wales, and this is the only case in which the title prince is connected with a territorial distinction. In Germany, the ambiguity of applying the same title to the members of royal houses and princely families, not sovereign, is avoided, the former being styled 'Prinz,' the latter 'Fürst.' The German Fürst takes rank below the Duke (Herzog). Most of the counts who had a seat in the old German Diet were elevated to the dignity of Prince on their acquiescence in the dismemberment of the German empire. In a more general acceptance, the term prince is often used for a sovereign or the ruler of a state.

PRINCE EDWARD ISLAND, a British North American colony, in the south of the Gulf of St Lawrence, and separated from New Brunswick and

Nova Scotia by the Strait of Northumberland, lat about 45° 56'—47° 4' N., long. 62°—64° 23' W. Length, 134 miles; breadth, 4 to 34 miles; area, 2137 square miles. Pop. (1841), 47,034; (1848), 62,678; (1861), 80,857. The surface is undulating; but few of the hills, the chief of which are in the middle of the island, and run from north to south, are upwards of 300 feet in height. The coasts are girdled by a bold line of red sandstone cliffs, varying in height from 20 to 100 feet, and are indented with numerous bays and inlets, several of which, as Cardigan Bay on the east, the entrance to Georgetown, and Hillsborough Bay on the south, the entrance to Charlottetown (the capital of the colony), are deep and spacious, and afford safe anchorage for large vessels. Other inlets are Bedeque and Egmont Bays on the south, and Holland, Richmond, and St Peter's Bays on the north. The rivers are mostly short. The soil, which is well watered with numerous springs and rivers, rests upon red sandstone, and consists for the most part of a layer of vegetable matter above a light loam, which rests upon stiff clay above sandstone. It is of great fertility, and the agricultural products are about double the quantity required for local consumption. Of the whole area, consisting of 1,360,000 acres, 1,300,000 acres are 'good' land, and 60,000 acres are 'poor' land; and in 1851, there were under cultivation 215,389 acres; in 1861, 368,127 acres. Since the year 1848, agriculture has become a much more important branch of industry. In 1861, the inhabitants were 20,000 more in number than in 1848; and within the same time the agricultural products had increased in many instances fourfold. In 1861, the amount of spring-wheat produced was 346,125 bushels; of barley, 223,195 bushels; oats, 2,218,578 bushels; buck-wheat, 50,127 bushels; potatoes, 2,972,336 bushels; turnips, 348,784 bushels; hay, 31,100 tons. The soil and climate are admirably adapted for producing wheat, and all the cereals, fruits, and vegetables grown in temperate climes are produced here. The climate, milder than that of the continental regions in the vicinity, and free from the fogs which prevail on Cape Breton and Nova Scotia, is very healthy. P. E. I. is extremely poor in minerals; copper and bog-iron ore are known to exist in small quantities. In the neighbouring waters, extensive and profitable fisheries are carried on. In 1861, the colony owned 1239 boats engaged in the fisheries; and the total value of the fish caught—principally mackerel, alewives or gaspereaux (which belong to the herring family), herrings, cod-fish, and hake—was 220,000 dollars. Manufactures are not important, though cloth is made to some small extent. In 1860, 2314 vessels, of 173,796 tons, entered and cleared the ports of the colony, and of these 2206 were British vessels. The imports for the year ending January 31, 1863, amounted to £211,240, the exports to £150,549. The revenue of the colony for the same year was £25,861, and the expenditure £34,451; and the public debt amounted at the close of the year to £54,803. The colonial government is vested in a lieutenant-governor, aided by a House of Assembly of 30 members, a legislative council of 13 members, formerly appointed by the crown, but now (since February 1863) elective; and an executive council, who are appointed by the lieutenant-governor from the majority of the colonial parliament, and are responsible for the government as long as they are in office. Charlottetown, with two banks, two colleges, the Prince of Wales's College, and St Dunstan's (Catholic), and a population, in 1861, of 6700, is the capital. Besides the educational institutions at Charlottetown, there are also a normal and 263 elementary schools, attended by about

## PRINCE OF WALES—PRINCE OF WALES ISLAND.

11,000 pupils. In 1862, £11,000 was disbursed from the colonial treasury for public education. The island is divided into 3 counties—Prince, Queen's, and King's counties—of which the chief towns are respectively Summerside, Charlottetown, and Georgetown. All parts of the island are traversed by coach-roads; and 50 miles of telegraph, 10 miles of which are submarine, belong to the island. Of the entire population, 44,975 are Protestants of different denominations, and 35,882 are Roman Catholics. The island was first taken possession of by the British in 1745, and was retaken by them, and finally annexed to their possessions in 1758.

**PRINCE OF WALES**, the title borne by the eldest son of the sovereign of England. The native sovereigns of Wales were so designated in the days of Welsh independence; and on the conquest of Wales, the principality of Wales and earldom of Chester were bestowed by Henry III. on his son, afterwards Edward I., but as an office of trust and government, rather than as a title. It is traditionally related that Edward I. engaged to give the Welsh people a prince who would be born among them, and not know a word of English, and fulfilled the promise by bestowing the principality on his infant son, Edward, born at Caernarvon Castle. Edward, by the death of his elder brother, became heir-apparent. Edward III., his son, was never Prince of Wales; but in 1343, he invested his son Edward the Black Prince with the principality, and from that time the title of Prince of Wales has been borne by the eldest son of the reigning king. The title is, however, not inherited, and has usually been bestowed by patent and investiture, though, in a few instances, the heir to the throne has become Prince of Wales simply by being so declared. The eldest son of the sovereign is by inheritance Duke of Cornwall, a title first conferred in 1337 on Edward the Black Prince, on the death of his uncle, John of Eltham, the last Earl of Cornwall, and held, according to the terms of the grant, by the first-begotten son of the king. The title of Earl of Chester, borne by Edward III. before his accession to the throne, has since been given along with the principality of Wales. That earldom was, by 21 Richard II. c. 9, erected into a principality; and it was enacted that it should be given in future to the king's eldest son—a precedent which has since been followed, although that statute, along with all others in the same parliament, was repealed by 1 Henry IV. c. 3. On the death of a Prince of Wales in his father's lifetime, the title has been conferred on the sovereign's grandson, or next younger son, being heir-apparent. As heir of the crown of Scotland, the eldest son of the sovereign is Prince and High Steward of Scotland, Duke of Rothesay, Earl of Carrick, Baron of Renfrew, and Lord of the Isles. The high office held by the House of Stewart (see STEWART, HOUSE OF) became merged in the crown when Robert II., the representative of the family, ascended the throne of Scotland in 1371. The earldom of Carrick was conferred by Robert II. on his eldest son. The dukedom of Rothesay was created by a solemn council held at Soone in 1398, and conferred on David, eldest son and heir of Robert III.; and when David, in 1402, fell a victim to the ambition of his uncle, it was transferred to his brother James, afterwards James I. of Scotland. Renfrew was the chief patrimony of the Stewards of Scotland, to whom it was granted by the sovereign in the 12th century, their principal residence having been in the burgh of Renfrew. In 1404, King Robert III. granted the barony of Renfrew and other portions of the estates of the Stewards to his son and heir, James since which time the eldest

son of the sovereign has borne the title of Baron of Renfrew. By act of the Scottish parliament of 1469, the titles of Prince and High Steward of Scotland, Duke of Rothesay, Earl of Carrick, Baron of Renfrew, and Lord of the Isles were vested in the eldest son and heir-apparent of the crown of Scotland for ever. The present Prince of Wales was created Earl of Dublin on September 10, 1849, that dignity being destined to him and his heirs, kings of the United Kingdom of Great Britain and Ireland, for ever.

An annuity of £40,000 was settled on the Prince of Wales by 26 Vict. c. 1. He has besides the revenues of the duchy of Cornwall. These amounted previously to 1840 to between £11,000 and £16,000; since that period, they have risen to £50,000, with every prospect of increasing. Only a small part of this income has been expended since the birth of the present Prince of Wales, the yearly accumulations amounting in November 1862 to upwards of £500,000. An income of £11,000 has been settled by parliament on the Princess of Wales, to be raised to £30,000 in the event of her widowhood. The annuities of the Prince and Princess of Wales are charged on the Consolidated Fund.

The Prince of Wales has a separate household, as also has the Princess of Wales. Act 35 Geo. III. c. 125 makes provision to prevent the accumulation of debt by any future heir-apparent to the crown, and enacts that as soon as he shall have a separate establishment, the treasurer or principal officer shall make a plan of such establishment in distinct departments and classes, with the salaries and payments of each class, and of each individual officer; and the treasurer is made responsible for the punctuality of all payments, and required to submit his accounts to the Lords of the Treasury. The statute of treasons, 25-Edw. III., makes it treason to compass the death of the Prince of Wales, or violate the chastity of his consort.

By a statute of the order of the Garter, of date 1805, the Prince of Wales becomes a Knight of the Garter as soon as he receives that title.

In 1788, on the illness of George III., it was made a question whether the Prince of Wales was not, as heir-apparent, entitled to the regency; the recovery of the king prevented the necessity for a decision, but it is now held that he has no such right.

The arms of the Prince of Wales are those of the sovereign, differenced by a label of three points argent, and the present Prince of Wales bears as *surtout* the escutcheon of the house of Saxony. The supporters and crest are the same as those of royalty. The ancient coronet of the Princes of Wales was a circle of gold set round with four crosses patée, and as many fleurs-de-lis alternately. Since the Restoration, it has been closed with one arch only, adorned with pearls, surmounted by a mound and cross, and furnished with a cap trimmed with ermine, like that of the sovereign. The Prince of Wales has further a distinguishing badge, composed of a plume of three white ostrich feathers, encircled by an ancient coronet of a Prince of Wales, and accompanied by the motto 'Ich dien' (I serve). This device is said by a tradition, on which considerable doubts have been thrown, to have been first assumed by the Black Prince after the battle of Crécy, in 1346, when he took such a plume from John, king of Bohemia, whom he had slain with his own hand. The motto has been supposed to allude to the fact that the king of Bohemia served, or was stipendiary to the French king in his wars.

**PRINCE OF WALES ISLAND**, or PU'LO PINA'NG (Betel Nut Island), an important British

## PRINCE RUPERT'S DROPS—PRINCIPAL AND AGENT.

possession, lies at the mouth of the strait of Malacca, a few miles from the west coast of the Malay Peninsula, in lat.  $5^{\circ} 16' - 5^{\circ} 30' N.$ , and long.  $100^{\circ} 9' - 100^{\circ} 25' E.$ , and has an area of 154 square miles. Pop. 45,000. A belt of coco-nut and lofty areca palms runs along the coast. A slip of low land, interspersed with hills, stretches along the east side of the island, where rice, pepper, betel, fruits, provisions, &c., are planted on the level parts; nutmeg and clove-trees on the heights. This district is watered by numerous streams, cut by well-kept roads, and dotted with villas and gardens. Sugar, coffee, and pepper plantations are on the south and south-west coasts; thence rises a wooded mountain ridge, which increases in elevation towards the north, where, at the Sanitarium bungalows of Strawberry Hill, it attains a height of 2700 feet. The rocks are granite and mica schist; the soil, a rich vegetable mould.

The climate of P. of W. I. is healthy, a sea-breeze blowing every day, and rain falling during all the months of the year, except January and February. In the low lands, the thermometer ranges from  $80^{\circ}$  to  $90^{\circ}$ , and at Strawberry Hill, from  $62^{\circ}$  to  $75^{\circ}$ , affording a pleasant change within a few miles of Georgetown. From the Sanitarium, a splendid view is obtained of the plantations, town, shipping, and the lofty hills of Queda.

The products are timber, pepper, sugar, nutmegs, cloves, coffee, coco and areca nuts, ginger, sweet potatoes, rice, &c.; and the pine-apple, shaddock, plantain, banana, orange, lemon, mango, guava, &c., abound. The large spice-plantation, Glucer, produces from £12,000 to £15,000 annually. The import and export trade has an average yearly value of about £600,000. European and American manufactures, and a share of the produce of the Eastern Archipelago, China, India, Siam, and Burmah, enter the emporium of P. of W. I., thence to find their way to suitable markets.

Georgetown, the capital (pop. 25,000), is situated in the north-east of the island, and is defended by Fort Cornwallia. The governor's house and the hospital are at some distance from the town, which is the seat of government for the Eastern Straits settlements, including Malacca and Singapore. On the peninsula opposite, lies the province of Wellesley, with an area of 160 square miles, laid out in sugar, nutmeg, and clove plantations. The population of this dependency and the island amounts to upwards of 90,000, of whom 62,000 are Malays, 16,000 Chinese, 400 Europeans and their descendants, the remainder being Siamese, Burmans, Bengalese, &c.

Towards the end of last century, a Captain F. Light married the daughter of the king of Queda, from whom he received the gift of P. of W. I.; but in 1786, it was handed over to the East India Company, who retained Captain Light as superintendent, and paid the king 6000 dollars annually. By an arrangement to pay an additional 4000 dollars yearly, the province of Wellesley was afterwards ceded to the Company. Population rapidly increased, the forests were cleared for plantations, and a large trade sprung up. It has been nearly stationary for several years, except in agriculture, owing to the more favourable situation of Singapore for the general commerce of these seas.

**PRINCE RUPERT'S DROPS.** These scientific toys, so called from Prince Rupert (see RUPERT), their inventor, are simply drops of glass thrown, when melted, into water, and thus suddenly consolidated. They have usually a form somewhat resembling a tadpole. The thick end may be subjected to smart hammering on an anvil without its breaking; but if the smallest fragment of the tail be nipped off,

the whole flies into fine dust with almost explosive violence. The phenomenon is due to the state of strain in the interior of the mass of glass, caused by the sudden consolidation of the crust. The crust is formed while the internal mass is still liquid. This tends to contract on cooling, but is prevented by the molecular forces which attach it to the crust. It is therefore somewhat in the state of the dog-head of a gun on full-cock, which will stand a smart blow without falling; while a slight touch applied to the trigger allows the spring to act. Another example of the same state of constraint is the Bologna phial—a glass cup with its sides thin, but the bottom very thick. It also is cooled as quickly as possible. A bullet may be dropped into it with safety from a considerable height; but if a small, sharp-edged fragment of flint be dropped in, so as to scratch the surface in the slightest degree, the molecular forces are set free, and the whole falls to pieces.

**PRINCE'S METAL.** See TIN.

**PRINCETON,** a township and village in New Jersey, 40 miles north-east of Philadelphia, and 11 miles north-east of Trenton; the site of a celebrated Presbyterian theological seminary founded in 1812. It has a bank, newspaper, several churches, the College of New Jersey, founded in 1748, which was presided over by Rev. Aaron Burr and Rev. Jonathan Edwards; it has 19 professors, 300 students, and a library of 24,000 volumes. P. was the scene of a battle fought 3d January 1777, between Americans under Washington, and British troops under Colonel Mawhood. The latter were defeated. Pop. in 1860, 3772.

**PRINCIPAL,** a presiding governor, or chief in authority. The word is applied to the head of a college or university in Scotland.

**PRINCIPAL,** in Music, the name of a stop or row of metal mouthpipes in an organ, the pitch of which is an octave higher than the open diapason, and an octave lower than the fifteenth. It serves to blend these stops, as well as to increase the volume of sound. The principal is the stop first tuned, and all the other stops are tuned from it.

**PRINCIPAL,** the name given to the chief rafters and braces in a Roof (q. v.).

**PRINCIPAL AND ACCESSORY.** See ACCESSARY.

**PRINCIPAL AND AGENT.** The law of principal and agent is founded on the absolute necessity of having some one to act for another in times and places when the latter is not personally present, and this necessity pervades nearly all branches of the law; and as a general rule, the act of the agent is just as binding on the principal, and produces the same effect, as regards his liability, as if the principal had acted in person. Agents are divided into many classes; indeed, nobody can escape, in one capacity or another, being occasionally the agent of somebody else. Attorneys, solicitors, advocates, brokers, auctioneers, &c., may be said to make a business of agency. A wife is, in Law, for many purposes of household management, the agent of the husband, and so are the children. Mercantile agents are generally called factors or brokers. The contract between principal and agent implies that the agent shall keep within the limits of his commission, and that the principal will ratify and accept all his contracts, and relieve him of the liabilities. The remuneration of the agent is generally called his commission. As the agent binds his principal, it follows that the principal can be sued by third parties who deal with the agent. The

nice distinctions that exist in the law on this subject as to the mutual rights and liabilities of the parties are too numerous to be here noticed.

**PRINCIPAL AND SURETY.** See **SURETY.**

**PRINCIPATO, CITRA and ULTRA,** formerly the name of two provinces of the kingdom of Naples. *Principato Citra*, now forming the province of Salerno in the reorganised kingdom of Italy, is a maritime province, bounded on the S.W. by the Mediterranean, and on the N. by the province of *Principato Ultra*, now called Avellino. The united area of the two provinces is 3405 square miles; pop. 883,877. Principal towns in Principato Citra are Salerno (from which it derives its present name), Sarno, and Pagani; in Principato Ultra, Avellino (from which it takes its present name), Ariano, and Cervinara.

**PRINTERS, LAW AS TO.** There are various restrictions on the sale and use of printing-presses, which have been imposed in consequence of the extended and secret influence often exercised by them; and the law of treason and libel is intimately associated with the press. By an act of 39 Geo. III. c. 79 (amended by 51 Geo. III. c. 65, and 2 and 3 Vict. c. 12), entitled an act for suppressing seditious and treasonable practices, reciting the mischief produced by the publication of irreligious, treasonable, and seditious libels, and the difficulty of tracing the authors, it is enacted that every person having a printing-press, or types for printing, shall give notice thereof to the clerk of the peace where the same is intended to be used, and shall obtain a certificate of registration, otherwise he is liable to a penalty of £20. But the Queen's printers for England and Scotland, and the university presses of Oxford and Cambridge, are excepted. So letter-founders and makers of types must register themselves under a like penalty; and they must keep an account of all the persons to whom types and presses are sold, which account may be inspected by a justice of the peace. So printers must keep a copy of every paper they print for hire or reward, and shall endorse thereon the name of the person employing them to do so, under a penalty of £20. Every printer who shall print a book or paper without having the printer's name and address on the first or last leaf thereof, shall, by the act 2 and 3 Vict. c. 12, s. 2, forfeit £5 for every copy printed; but the only person who can sue for or enforce this penalty is the Attorney or Solicitor General of England, or the Lord Advocate of Scotland. But for the previous penalties, any informer may sue, and the justices may mitigate the penalties to £5. It follows from these enactments that a printer cannot recover his expenses for labour and materials in printing a work, unless he has complied with the statutory requirements. On a recent occasion, in which a printer in England who sued for his account was met with a defence founded on these statutes, it was discovered by the London printers that few of them had registered themselves, and accordingly they took occasion to repair the error. With regard to the printing trade, many customs prevail which do not differ in point of law from the customs affecting other trades, it being the rule that customs of a peculiar trade are binding unless specially excluded. As to obscene prints, see **OBSCENE.**

**PRINTING** is the art of producing impressions, from characters or figures, on paper or any other substance. There are several distinct branches of this important art—as the printing of books with movable types, the printing of engraved copper and steel plates (see **ENGRAVING**), and the taking of impressions from stone, called **Lithography** (q. v.). We have now to describe the art of printing books

or sheets with movable types, generally called *letter-press printing*, and which may undoubtedly be esteemed the greatest of all human inventions.

The art of printing is of comparatively modern origin, only 400 years having elapsed since the first book was issued from the press; yet we have proofs that the principles upon which it was ultimately developed existed among the ancient Assyrian nations. Entire and undecayed bricks of the famed city and tower of Babylon have been found stamped with various symbolical figures and hieroglyphic characters. In this, however, as in every similar relic of antiquity, the object which stamped the figures was in one block or piece, and therefore could be employed only for one distinct subject. This, though a kind of printing, was totally useless for the propagation of literature, on account both of its expensiveness and tediousness. The Chinese are the only existing people who still pursue this rude mode of printing by stamping paper with blocks of wood. The work which they intend to be printed is, in the first place, carefully written upon sheets of thin transparent paper; each of these sheets is glued, with the face downwards, upon a thin tablet of hard wood; and the engraver then, with proper instruments, cuts away the wood in all those parts on which nothing is traced; thus leaving the transcribed characters in *relief*, and ready for painting. In this way, as many tablets are necessary as there are written pages. No press is used; but when the ink is laid on, and the paper carefully placed above it, a brush is passed over with the proper degree of pressure. A similar kind of printing by blocks, for the production of playing-cards and rude pictures of scriptural subjects, was in use in Europe towards the end of the 14th century. But in all this there was little merit. The great discovery was that of forming every letter or character of the alphabet separately, so as to be capable of rearrangement, and forming in succession the pages of a work, thereby avoiding the interminable labour of cutting new blocks of types for every page. The credit of discovering this simple yet marvellous art is contested by the Dutch in favour of Laurence Coster (q. v.), between 1420 and 1426; and by the Germans, on behalf of Johann Gansfleisch of the Gutenberg (q. v.) family, about 1438. In all probability, the discovery was made almost simultaneously—such a theory being consistent with the general social progress at the period, and the secrecy which both inventors at first maintained respecting their art. The types first employed were of wood; but soon the practice of casting them in metal was introduced. See **TYPES.** The earliest of these metal types resembled the black letter in use by transcribers, and one great aim of the first printer was to produce books which should closely resemble the works in manuscript hitherto in use. Between 1450 and 1455, Gutenberg succeeded in printing a Bible, copies of which are now exceedingly rare and valuable. It is in quarto size, double columns, the initial letters of the chapters being executed with the pen, in colours. Besides this Bible, some other specimens of the work of Gutenberg, the produce of his press at Mayence, have been discovered. The Dutch, at Haarlem, preserve and shew with reverential care similar specimens of early printing by Coster. Mayence, Strasburg, and Haarlem were indisputably the places where printing was executed before the art was extended to Rome, Venice, Florence, Milan, Paris, Tours, and other continental cities. Previous to 1471, it had reached these and various other places; and about the same year, Caxton (q. v.) introduced the art into England, by setting up a press in Westminster Abbey.

## PRINTING.

Printing was introduced into Scotland about 30 years after Caxton had brought it to England; in 1551, it reached Dublin, and to other quarters it found its way very slowly. While coming into notice, its progress had been interrupted by the broils consequent on the Reformation; and soon afterwards, it was retarded by the civil war in Great Britain. Even the Restoration acted detrimentally, for it led to an act of parliament which prevented more than 20 printers carrying on their art in England. Printing, in short, has in almost every country been an ill-used art; and is still in various countries practised under fiscal restrictions. In Germany and Holland, where it originated, it has, on account of sundry obstructions, gained little way—the work produced at Mayence and Haarlem being, for example, still of a very inferior kind; while, in recent times, in England and the United States, the art has attained to extraordinary proficiency. Printing is now conducted in all the British colonial possessions, but in few is the work of a superior character—the best perhaps being that produced at Melbourne in Victoria.

Retarded by the jealousy of governments, printing for some ages derived little advantage from mechanical ingenuity. Originating at the middle of the 15th, the art continued to be conducted until the middle of the 17th c. in a very clumsy manner. The press resembled a screw-press, with a contrivance for running the form of types under the point of pressure; force having been thus applied, the screw was relaxed, and the form withdrawn with the impression executed on the paper. The defects of this very rude mechanism were at length partially remedied by an ingenious Dutch mechanic, Willem Jansen Blaau, who carried on the business of a mathematical instrument-maker at Amsterdam. He contrived a press, in which the carriage holding

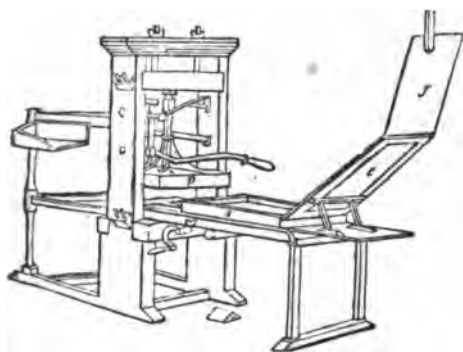

Fig. 1.—Old Common Press.

the form was wound below the point of pressure, which was given by moving a handle attached to a screw hanging in a beam having a spring, which spring caused the screw to fly back as soon as the impression was given. This species of press, which was almost entirely formed of wood, continued in general use in every country in Europe till the beginning of the present century. With certain lever powers attached to the screw and handle, it is represented above.

In connection with this representation of the old common press, the process of printing may be described. The form, being laid on the sole of the press (s), is fixed at the sides, so as to render it immovable from its position. There are two men employed: one puts ink on the form, either by means of stuffed balls or by a composition-roller,

and the other works the press. The latter lifts a blank sheet from a table at his side, and places it on what is called the *tympa*n (t), which is composed of parchment and blanket-stuff, fitted in a frame, and tightened like the top of a drum—and hence its name—and which, by means of hinges connecting it with the sole, folds down like a lid over the form. As the sheet, however, would fall off in the act of being brought down, a skeleton-like slender frame, called a *frisket* (f), is hinged to the upper extremity of the *tympa*n, over which it is brought to hold on the paper. Thus, the *frisket* being first folded down over the *tympa*n, and the *tympa*n next folded down over the form, the impression is ready to be taken. This is done by the left hand of the pressman winding the carriage below the *platten* (p), or pressing surface, and the impression is performed by the right hand pulling the handle attached to the screw mechanism. The carriage is then wound back, the printed sheet lifted off, and another put on the *tympa*n, the form again inked, and so on successively. In the above engraving, the press appears with the *frisket* and *tympa*n sloping upwards, ready to receive the sheet, the *frisket* being sustained from falling backwards by a slip of wood depending from the ceiling. One of the greatest niceties connected with this art is the printing of the sheet on the second side in such a manner that each page, nay, each line, shall fall exactly on the corresponding page and line on the side first printed. To produce this desirable effect, two iron points are fixed in the middle of the sides of the frame of the *tympa*n, which make two small holes in the sheet during the first pressure. When the sheet is laid on to receive an impression from the second form, these holes are placed on the same points, so as to cause the two impressions to correspond. This is termed producing *register*; and unless good *register* is effected, the printing has a very indifferent appearance. However improved, a press of the above description could not impress more than half a sheet; and the practice was to first squeeze so much of the sheet, then relax the handle, wind the second half below the *platten*, and print it in turn. Thus, each sheet required four squeezes to complete it—two on each side. It is not without a degree of wonder that one reflects on the rudimentary clumsiness of the whole operation; and it seems not less marvellous, that it was by no other process that the best typography could be produced until the conclusion of the 18th century.

The first improvement upon the printing-press was made by the celebrated Earl of Stanhope. He constructed the press of iron, and that of a size sufficient to print the whole surface of a sheet, and he applied such a combined action of levers to the screw as to make the pull a great deal less laborious to the pressman; the mechanism altogether being such as to permit much more rapid and efficient working. A multitude of improvements speedily succeeded that of Earl Stanhope, in most of which the screw was dismissed, the pressure being generally effected by levers, or by the simple and efficient principle of straightening a joint. Among those which have gained a large share of approbation may be mentioned the *Columbian press*, which is of American invention. This press, a representation of which is annexed, was brought to Great Britain in 1818 by Mr George Clymer of Philadelphia, and patented. The pressing-power in this instance is procured by a long bar or handle acting upon a combination of exceedingly powerful levers (a, a, a) above the *platten*; the return of the handle or levers being effected by means of counterpoises or weights (c, c). For ease and facility of *pull*, this press is preferred by most workmen; and certainly the

powerful command which the leverage enables the workman to exercise, is favourable to delicacy and exactness of printing—his arm feeling, as it were,

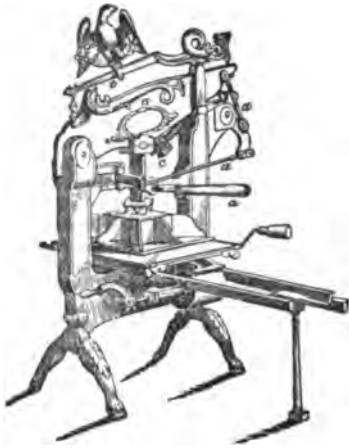

Fig. 2.—Columbian Press.

through the series of levers to the very face of the types. In the present day, the old wooden press of Blaeu is entirely discarded from use.

To secure good printing, the following points are essential. 1. The types, carefully set, fixed with precision in forms, rendered level all over, so that all parts may be pressed alike, and the whole properly cleaned by a wash of potash lye. 2. A uniform inking of the surface, to give uniformity of colour. 3. The paper damped equally, neither too much nor too little, so as to take an impression easily and evenly. 4. An equable, firm, and smart pressure, and with that degree of steadiness in the mechanism that the sheet shall touch and leave the types without shaking and blurring. 5. Care in adjusting the pointers (or gauge), so that perfect register may be secured in printing the second side. 6. Such frequency in changing *fly* or under-sheets on the tympan, that the first side shall not get dirtied by off-setting when printing the second side. 7. The laying of small patches on the tympan, where, from any inequality, it seems necessary to bring up the pressing surface to a thorough equality. A regard to all these circumstances constitutes the duty of a pressman. Bad printing is usually a result of old and worn types, want of proper cleaning, and an inferior kind of ink.

Printing by hand-presses of an improved kind con-

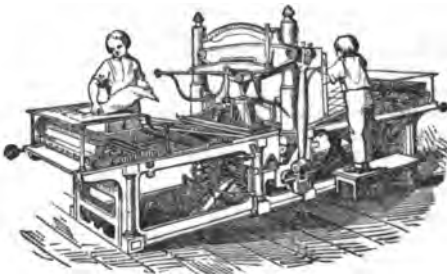

Fig. 3.—Flat-pressure Machine.

tinues to be used in the case of limited impressions, or where extra care and elegance in typography

are required; also where machinery is unattainable; but in general circumstances, and more particularly to meet the demand for popular reading, printing is now executed by one or other of the varieties of cylinder-presses, moved by steam-power. Attempts have indeed been made to introduce flat-pressure machines, by which as many as 700 sides can be printed per hour; but these, though possessing the advantage of superseding severe bodily labour, and demanding only the services of a boy to lay on, and another to take off the sheets, have never become common. We offer a representation of a machine of this kind, made by J. Brown & Co., engineers, Kirkcaldy. More success, as regards flat-pressure machines, has been attained in the United States, where much fine work is provided by a clever adaptation of this kind, particularly in New York, Boston, and Philadelphia. No flat pressure, however, can compete, in point of speed, with the pressure which is communicated by revolving iron cylinders.

Cylinder-printing is the great modern fact in the history of the art, progress in which department has been facilitated by the invention of inking rollers made of a certain composition, to supersede the old process of inking by stuffed balls (see ROLLERS). In 1790, Mr Nicholson, the editor of the *Philosophical Journal*, procured a patent for certain improvements in printing, which patent embodies almost every principle since so successfully applied to printing-machines; and although he did not carry his views into practical effect, little has been left for subsequent engineers to do, but to apply, in the most judicious manner, the principles he laid down in his patent. Whether Mr Nicholson's ideas were known to Mr König, a German, is now uncertain; but to him is due the distinguished merit of carrying steam-printing first into effect. Arriving in London about 1804, he first projected improvements on the common press; but after a while, he turned his attention to cylinder-printing. The first result of his experiments was a small machine, in which the two leading features of Nicholson's invention were embraced (the cylinders and the inking-rollers), which he exhibited to Mr Walter, proprietor of the *Times* newspaper; and on shewing what further improvements were contemplated, an agreement was entered into for the erection of two machines for printing that journal. Accordingly, on the 28th of November 1814, the public were apprised that the number of the *Times* of that date was the first ever printed by machinery, steam-propelled. At this period, but few persons knew of any attempts going on for the attainment of this object; whilst among those connected with printing, it had often been talked of, but treated as chimerical.

After the utility of cylindrical printing had been thus proved, it was thought highly desirable that the principle should be applied to printing fine book-work, where accurate register is indispensable. This was, to a certain extent, attained by using two large cylinders, the sheet of paper being conveyed from the bottom of the first cylinder (where it had received the first impression) by means of tapes, leading in a diagonal direction to the top of the second cylinder, round which the sheet was carried till the second side was printed. The first machine of this description was erected at Mr Benaley's office, where it continued at work for some years, till more modern machines superseded it.

In the course of 1818, Messrs Applegath and Cowper took out a patent for improvements in cylindrical printing machinery. The chief improvements were, the application of two drums placed betwixt the cylinders to insure accuracy in the

## PRINTING.

register, over and under which the sheet was conveyed in its progress from one cylinder to the other, instead of being carried, as in König's machine, in a straight line from the one cylinder to the other; and the mode of distributing the ink upon tables instead of rollers—two principles which have secured to machines of this construction a decided preference for fine work. Machines of this construction were made by Applegath and Cowper for the principal printing establishments in London, Paris, Edinburgh, and many other cities; and it is nearly upon the model of their machines that other manufacturers now construct their steam-presses for the execution of ordinary book-work. Printing-machines may be divided into two distinct classes—those for printing book-work, in which register is required, and those for printing newspapers, in which register is not sought for, and speed is of first consequence.

Applegath and Cowper's book-machine, as just mentioned, remains the best of its kind. The machine, moved by steam-power, from which the annexed engraving is taken, is one of this description. It is about 15 feet long by 5 broad, and consists of a very strong cast-iron frame-work, secured

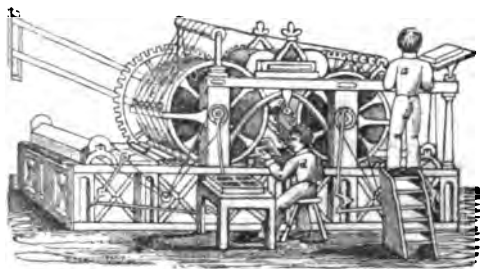

Fig. 4.—Book-Machine.

together by two ends and several cross-bars. To this frame, all parts of the machine are fixed. In external figure, as seen in the cut, it is a large apparatus, of imposing appearance. On approaching it when at work, we perceive two cylinders, as large as hogheads, revolving on upright supports; two smaller cylinders or drums revolving above them; and beneath, within the framework, a table, on which lie the types at both ends, going constantly backward and forward. A belt from a steam-engine, acting upon a shaft in the frame, gives motion to the whole apparatus. It will further be observed that a boy, marked *a* in the cut, is standing on the top of some steps feeding in sheets of paper, each of which, on being delivered, is swept round the first cylinder *b* (being held on by tapes), gets its impression below from the types, is carried over and betwixt the drums above, and then brought round on the second cylinder *c*; now it gets its second side printed, and issuing into the space between the cylinders, is seized by the boy *d*, who lays it on a table completely printed. The whole operation is accompanied with a loud noise, from the revolving of the cylinders, the working of the notched wheels, and the driving of the table to and fro by a rack beneath, but without any strain on the mechanism, or risk of injury to the attendants. On minutely examining the parts, we observe that at each end there is an apparatus of rollers taking ink from a ductor or reservoir of that material, and placing it upon a portion of the moving table beneath; here other rollers distribute it, while others take it off and roll it upon the pages of types, ready for each impression.

The two printing cylinders are nearly nine feet in

circumference each, and are placed about two feet apart. They are accurately turned, so that the surfaces of the type-carriages and the cylinders may be perfectly parallel. The axis of each cylinder works in brass bearings in the upright framework, where, by means of screws, the degree of pressure with which the cylinders are allowed to rest upon the types may be regulated to any degree of nicety. Over about two feet of the circumference of each cylinder which forms the printing-surface, two folds of cloth, called blankets, are stretched by means of rollers placed inside the cylinder. The lower blanket is seldom changed, but the upper one, on the second cylinder (which stands in the stead of what are called slip-sheets in hand-press printing), must be shifted as soon as the ink which it has absorbed from the printing on the first side of the sheet begins to set off, or soil the paper, when receiving the second impression. This shifting is speedily effected, by unrolling a sufficient quantity of the cloth off one roller, and winding it up on the other, to present a clean portion to the printing surface.

The cylinders have a continuous rotary motion towards each other, given by two large toothed wheels, whilst the type-carriages move backward and forward under them. The movements are so contrived that the type-carriages shall have gone and returned to the same point during the period that the cylinders have made one entire revolution; consequently, each successive impression is taken from the types by the same part of each cylinder. The two drums placed between the cylinders are for the purpose of causing the sheet of paper to pass smoothly and accurately from one printing cylinder to the other. To preserve the sheet in its proper place on the cylinders, and carry it forward through the different parts of its journey from the hand of the one boy to that of the other, there is an extensive apparatus of tapes, some of which are observable in the cut. These tapes are half an inch broad, and are formed into series of endless bands, arranged at certain distances apart, so as to fall into the interstices and margins of the forms, and therefore escape being crushed between the types and cylinders. The machine may be stopped at any instant by turning the handle of a lever, which shifts the belt from the fast to a loose pulley, without stopping the engine.—Such is the form of the machine that has printed the present work, which may be taken as a fair specimen of what this kind of press can, with carefulness, produce, at the rate of 700 sheets complete per hour.

Non-registering machines for rapid printing are of various kinds, according to the degree of speed which is demanded. In those first introduced, the principle was that of pressure by a cylinder on a form of types laid upon a table, which was passed beneath it by a forward and retrograde motion; the inking being effected as in the above described perfecting machines. Having received one side by this means, the sheets were afterwards printed on the second side; such second impression containing the news up till the latest hour of going to press. This species of single cylinder printing-machine was well adapted for newspapers of which only a few thousand copies were wanted; and for this purpose, it is still in use, particularly in provincial towns in Great Britain. As presses of this sort, however, do not usually yield more than 4000 or 5000 impressions per hour, they are quite unfitted for printing newspapers having a circulation of 20,000 copies and upwards, the whole of which must be promptly produced by a certain hour every morning. The liberation of newspapers from the obligatory penny-stamp in 1855, caused so great an increase of



## PRINTING.

circulation, that none of the ordinary processes, including that just referred to, was at all adequate for the work required. Recourse had to be made to an entirely new method of printing, the invention of which is due to Richard M. Hoe of New York.

Hoe's process consists in placing the types on a horizontal cylinder, revolving on its axis, against which the sheets are pressed by exterior and smaller cylinders. A similar process, by means of an upright cylinder, had been employed by Mr Applegath for printing the *Times* in 1848; but the expense involved in its construction and working prevented it coming into general use. Hoe's process was therefore the first successful attempt to print on this singularly ingenious and effective principle. As types must necessarily stand on a flat surface, in order to be held together and properly printed, it will seem incomprehensible how they should be built up on the exterior of an iron drum, and there yield legible impressions. Yet, this is done by Hoe's process. The pages of type are arranged in segments of a circle, each segment forming a frame that can be fixed on the cylinder. These frames are technically called *turtles*. Each column of type stands on a level strip of the turtle, while between the columns the brass rules for printing the lines are of a

bevelled shape—the bevel corresponding to the convexity of the turtle; so that by means of this bevelling, the form of type is susceptible of being tightened up and made ready for press. The forms occupy only a portion of the main cylinder, the remainder affording space for the inking apparatus. The smaller surrounding cylinders for effecting the pressure are arranged in a frame-work, in connection with slopes, by which the sheets are fed in blank, and come out printed. The size of the main cylinder, the number of exterior cylinders, and the rate of speed at which the whole machine is kept working, determine the number of impressions printed per hour. Such is the method of working Hoe's rotary machines, which, as wanted, are made with 2, 4, 6, 8, or 10 subsidiary cylinders; those of the largest dimensions being now employed in printing the daily newspapers in New York. The first introduced into Europe (with the exception of one made for the Paris newspaper, *La Patrie*, in 1848) was one with six cylinders for printing *Lloyd's Weekly Newspaper* in London, in 1857. Upwards of forty of these machines, of different sizes, are now in operation in London, Manchester, Liverpool, Leeds, Birmingham, Edinburgh, Glasgow, and other cities in Great Britain, where cheap daily

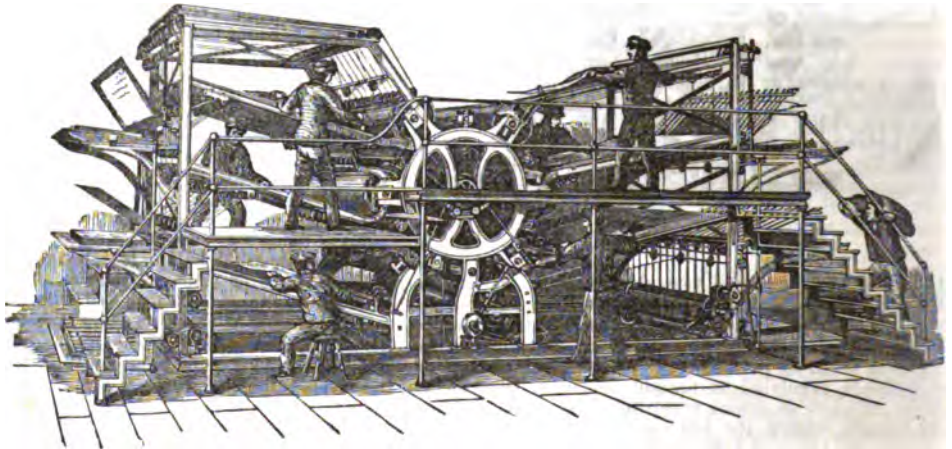

Fig. 5.—Hoe's Machine.

newspapers are produced. Some idea of the process of working may be obtained from the annexed cut, representing a rotary machine with six cylinders, which is employed, along with two of larger dimensions (viz., one with 8, and another with 10 cylinders), in printing the *Manchester Examiner and Times*. The working of the six-cylinder machine is thus described: 'The large cylinder being put in motion, the type imbedded in it is carried, successively, to the six impression-cylinders, which are placed horizontally to the large one, and arranged at proper distances around it. These subsidiary cylinders give the impression to six sheets of paper introduced, one at each cylinder. For each impression-cylinder there are two inking-rollers, which revolve on the distributing surface, and take up a supply of ink, and, at the proper moment, pass over the type, giving it the requisite amount of ink, after which they again fall to the distributing surface. Six persons are required to feed in the sheets, which, after receiving the impression, are carried out, by means of tapes, to the end of the machine, and laid regularly in heaps by self-acting flyers. In order to produce 12,240 impressions in

one hour, each feeder must lay in sheets at the rate of 34 per minute, or 2040 per hour. In each revolution of the large cylinder, therefore, six sheets receive each its impression; and as it moves, say, at the rate of 34 revolutions in a minute, 204 impressions are necessarily produced, giving in 60 minutes, or one hour, 12,240 impressions. In the 8 and 10 cylinder machines, the number of impressions produced per hour would be, respectively, 16,320, and 20,400; but the larger machines are not run at so great a speed as 34 revolutions per minute, and the actual number produced is, therefore, rather less. The productive power of the machine is only limited by the skill and dexterity of the feeders or layers-on. In the *New York Herald* printing-office, the manipulative power of the feeders has been so much increased by practice, that 2500 is by no means an unusual number of sheets to be laid on by each workman in an hour. Applying this to the six-cylinder machine, and supposing the main cylinder to revolve at the rate of 42 revolutions per minute, with six skilful feeders, each capable of laying on 42 sheets in a minute, it follows that 252 impressions would be produced;

and as the number of revolutions performed in one hour would be 2520, the aggregate number of impressions produced within the hour would amount to 15,120.' A machine of this kind can be set up for about £3500; one with eight cylinders, for £4500; and with ten cylinders, for £5500. By machines with ten cylinders, such as those now used in printing the *London Times*, *Daily Telegraph*, *Morning Star*, *Standard*, and *Manchester Examiner and Times*, as many as 20,000 impressions can be thrown off per hour. But to this is to be added another marvel in typography. By taking a stereotype-cast of the forms when ready for press, which can be done in a few minutes, two sets of types, so to speak, are produced, from which duplication as many as 40,000 impressions can be taken in the hour; it being, in fact, by this means that the proprietors of the *Times* and other popular prints are able to supply, at an early hour every morning, the extensive demand for their papers. See STEREOTYPING.

A still further development of the art of rapid printing is at present (January 1865) in progress. A machine has been constructed in London for the purpose of printing a continuous sheet of paper, previously damped, unrolled from a cylinder, and which receives, as it passes through the machine, impressions on both sides of the sheet. The impressions are given from stereotype forms, fastened on horizontal cylinders. As the sheet passes along from that part of the machine where it receives the impression, it is out by a very ingenious process, and the detached portions (which are, in fact, single copies of the newspaper) are carried forward and deposited, one above another, in heaps. The great difficulty to be overcome at this final stage of the process arises from the extreme rapidity with which the sheets come out of the machine, but the inventor confidently expects to overcome it. Should this machine be successful, it will be an important step in advance even of Hoe's presses. The space occupied by it will be very much less, and the necessity of having feeders to lay on the sheets will entirely be done away with, thereby effecting a large saving in expenses. By this machine, the sheet will be printed simultaneously on both sides, which cannot be done by Hoe's or any other press. It will, in reality, do the work of two of Hoe's machines, and with an immense saving as regards room, the wages of layers-on, &c. Various other novel projects have been suggested for facilitating the art of letterpress-printing, to notice which would exceed the space at our disposal.

*Anastatic Printing* (so called from *anastasis*, resuscitation, raising up again) originated in Germany about 1840, and is the process of executing impressions from zinc-plates to which an impression has been transferred from existing printed books or sheets. The first step in the process is to damp a printed sheet with water, and then moisten it with dilute nitric acid, after which the sheet is pressed firmly and evenly on a prepared zinc-plate. The acid now eats out the plate in all parts except where there is print, which, from its oleaginous character, has absorbed neither water nor acid. The result, after due time, is the production of a typographic surface on the plate, somewhat resembling the appearance of stereotype, and from which may be printed a fac-simile of the original. This very ingenious process, which has been made the subject of a patent in Great Britain, may be rendered available for procuring fac-simile copies of books and prints, but is not likely ever to be carried to a great length in competition with fresh typography. Recently-printed matter is most easily

transferred; with old books, the transfer is effected with difficulty, and only by exercising a degree of care which ordinary operators are not disposed to take.

W. O.

PRINTING, NATURE. See NATURE-PRINTING.

PRINT-WORKS, in point of law, are regulated by the statute 8 and 9 Vict. c. 29, so far as regards the labour of children, young persons, and women; and the statute applies to all buildings where persons are employed to print figures, patterns, or designs by means of blocks or cylinders, &c., on any woven fabric of cotton, wool, hair, fur, silk, flax, hemp, or jute. The works are subject to the inspection of the factories' inspectors, to whom particulars of the business and place are to be duly sent. Children under 8 years of age are not to be employed. Surgical certificates of age are to be given. No child under 13, or female, is to be employed during the night. Children under 13 must be sent by the parent to school for at least 60 days in the year, and certificates of these school attendances must be obtained before a child can be employed in a print-work. A register is to be kept of all the persons employed, and the times of employment; and any employment of a child, young person, or woman contrary to the act, subjects the occupier of the works to a penalty. Minute regulations for securing observance of the act are contained in the act itself.

PRIOR. See MONASTERY.

PRIOR, MATTHEW, an English poet, was born, it is supposed, in London, where his father was a joiner, on the 21st July 1664. He was educated, through the liberality of an uncle, at Westminster School; and in 1682, he was sent by the Earl of Dorset, whose friendship he had formed, to St John's College, Cambridge. Here he took his B.A., obtained a fellowship, and made the acquaintance of Charles Montagu, afterwards Earl of Halifax, in conjunction with whom he produced *The City Mouse and Country Mouse*, written to ridicule Dryden, in which it did not in the least succeed, although it lives yet in virtue of its own wit, polish, and grace.

After 1688, P. was introduced to court by the Earl of Dorset, and was appointed secretary to the embassy which was sent to the Hague in 1690. His conduct gave satisfaction to King William; and the lucky and well-mannered poet was appointed afterwards to several posts of a similar description. He was a favourite at the courts of Holland and France. In 1701, P. entered parliament; and soon after he deserted the Whigs, and went over to the Tory party. In 1711, he was sent by government to Paris with private proposals for peace, and on his return, he brought with him one of the French ministers, who was invested with full powers to treat. At P.'s house, shortly after, the representatives of the British government met the French plenipotentiary; and his connection with this meeting was made the ground of a charge of treason, on which he was committed to prison, but released after a confinement of two years, without a trial. He had now nothing to live by except his fellowship and his wits. The publication of his poems by subscription, however, brought him 4000 guineas; and at the same time, Lord Harley, son of the Earl of Oxford, bought a small estate in Essex, and conferred it on him for life. At the age of 57, he died at the seat of the Earl of Oxford, September 18, 1721. A monument was erected to him in Westminster Abbey.

P. was one of the few poets who was also a diplomatist and man of the world. He filled his public offices with credit to himself, and he had the knack of making friends amongst those who had the giving

of places and pensions. His poems, which comprise odes, songs, epistles, epigrams, and tales, are not much read. He has no fire, no enthusiasm, but everything is neat, pointed, well turned; and his lighter pieces are graceful and witty. If there is little inspiration in his verse, there are the polish and felicity of a scholar and man of society.

PRISCIAN (Lat. *Priscianus*), surnamed CÆSARIENSIS, either because he was born or educated in the town of Cæsarea, is perhaps, in point of reputation, the first of Latin grammarians, though one of the last in point of time. He belongs to the middle of the 5th c., if he is not even considerably later, for he is mentioned by Paulus Diaconus as a contemporary of Cassiodorus (468—562 A.D.). He taught Latin at Constantinoë, probably to the imperial court, for he enjoyed a government salary. The work which has mainly preserved his name is his *Commentariorum Grammaticorum Libri XVIII.*, dedicated to his patron the consul Julianus. The first 16 books treat of the different parts of speech as conceived by the ancients; the remaining two are devoted to syntax, and in one MS. bear the separate title of *De Constructione libri duo*. P.'s Commentary is, for the time, a solid and comprehensive work, the production of a man of great learning and good sense, and is enriched with quotations from many Greek and Latin authors no longer extant. The epitome executed by the German bishop, Rabanus Maurus (flor. in the 9th c.), was very popular in the middle ages. Besides the Commentary, P. wrote six smaller grammatical treatises, and two hexameter poems of the didactic sort, *De Laude Imperatoris Anastasii*, and a free translation of the *Periegesis* of Dionysius. The first edition of P. appeared at Venice (1470); the best is that by Krehl (2 vols., Leip. 1819—1820).—The phrase, 'to break the head of Priscian,' means to grossly violate the rules of grammar.

PRISCILLIAN, the author, or rather the chief propagator in Spain, during the latter part of the 4th c., of the doctrines professed by the sect known from his name as PRISCILLIANISTS. The first seed of their doctrines is said to have been carried into Spain by a Memphian named Marcua. P. was a man of noble birth; and by his eloquence and ascetic life obtained so much consideration, that a numerous party, including some priests, and at least two bishops, attached themselves to his school. His doctrine was substantially that of the Manicheans (q. v.). He taught expressly the *Dualism* and the *Docetism* of that sect, and it is equally certain that he adopted the moral consequences as to marriage, &c., by which they had rendered themselves obnoxious even to the civil authorities in the East and Africa. He was warmly opposed by two bishops, Idacius and Ithacius; and the council of Cæsar-Augusta (Saragossa) having in the year 380 condemned his doctrines, a decree for his banishment was issued in the same year. He not only obtained, however, a reversal of this decree, but succeeded in effecting the banishment of his chief opponent, Ithacius. By an appeal to the usurper Maximus at Treves, Ithacius caused P. and several of his followers to be brought to trial, and put to death, in 385; a proceeding which was regarded with so much abhorrence by St Martin of Tours, St Ambrose, and other bishops, that they separated from the communion of Ithacius. The sect did not die out with its founder, though there was a considerable reaction against it at the close of the 4th c.; and at all times through the medieval period we find its traces under various names and forms, especially in the north of Spain, in Languedoc, and in Northern Italy.

PRISM, in Geometry, a solid figure which can

be most easily conceived of if we imagine a number of plane figures (triangles, quadrilaterals, &c.) exactly similar in form and size to be cut out of paper or any thin plate, and piled one above the other, and then the whole pile to become one body. It will thus be seen that the top and bottom of the prism are similar, equal, and parallel to each other, and that the sides are plane figures, rectangular if the prism be 'right' (i. e., if in the above illustration the pile of plane figures be built up perpendicularly, and rhomboidal if the prism be 'oblique' (i. e., if the pile slope to one side); but under all circumstances the sides of a prism must be parallelograms. The top and bottom faces may be either triangles, squares, parallelograms, or quadrilaterals of any sort, or figures of 5, 6, 7, &c. sides, provided only both are alike; and the number of sides in the plane figure which forms the top or bottom, of course determines the number of faces of the prism; thus, in a triangular prism, there are 5 faces in all (3 sides and 2 ends); in a quadrangular prism, 6 faces (4 sides and 2 ends), &c. If two prisms, one being 'right,' and the other 'oblique,' have their bases of equal area, and be of the same vertical height, their solid content is the same, and is found by multiplying the area of the base by the vertical height. The Parallelepiped (q. v.) is a quadrangular prism, and the cube is a particular case of the parallelepiped.—PRISM, in Optics, is a triangular prism of glass or other transparent substance, its two ends being isosceles triangles, and having most frequently a very acute vertical angle, which gives the prism the appearance of a long wedge. The prism is a most important instrument in experiments on the refraction of light, and, in the hands of the most eminent optical philosophers, has been the means of largely adding to the science of optics. See REFRACTION.

PRISON DISCIPLINE means the method in which criminals, or other persons subjected to imprisonment are managed. In this, which is its original sense, prison discipline, as actually practised, may be good or bad in the estimation of the person speaking of it. Of late, however, the term has obtained a new meaning, having been used to express not merely the practice of ruling prisons, but the science of properly ruling them. It has gone even further, and sometimes has been used to express the principles of penal administration, or the philosophy and practice of punishment. This has arisen from the circumstance, that gradually other punishments have been dropped in this country, and detention within edifices and the grounds attached to them has become almost the only method of punishment for crimes. Torture, exposure in the pillory, and other like dedications of the offender to public vengeance, have been long abandoned as barbarous. Death-punishment has been much narrowed in its application; and transportation, apart from any question as to its effectiveness, has been rendered impracticable, except within a very narrow compass. We get nothing from the practice of the times anterior to Christianity, nor yet from that of the middle ages, to help us in estimating modern systems of prison discipline. They are a development of civilisation; and, contradictory as it may seem to say so, of personal liberty. The institution of slavery renders any such system unnecessary. It removes the function of punishing ordinary criminals from the public administration of the affairs of a state, and places it in private hands. Hence, we have no criminal law, properly speaking, coming down to us from antiquity. The *corpus juris*, so full of minute regulations in all matters of civic right, has very little criminal law, because the criminals became slaves,

## PRISONERS OF WAR—PRITHU.

and ceased to be objects of the attention of the law. When imprisonment became a function of the state in the administration of justice, it was often carelessly, and hence tyrannically, exercised, because the practice of awarding it as a punishment arose more rapidly than the organisation for controlling its use. On several occasions, grave abuses have been exposed by parliamentary inquiries and otherwise in the practice of prison discipline in this country. The exertions of Howard, Mrs Fry, and other investigators awakened in the public mind the question, whether any practice in which the public interest was so much involved, should be left to something like mere chance—to the negligence of local authorities, and the personal disposition of jailers. The tendency lately has been to regulate prison discipline with extreme care. The public sometimes complain that too much pains is bestowed on it—that criminals are not worthy of having clean well-ventilated apartments, wholesome food, skilful medical attendance, industrial training, and education, as they now have in this country. There are many arguments in favour of criminals being so treated, and the objections urged against such treatment, are held by those who are best acquainted with the subject to be invalid; for it has never been maintained by any one that a course of crime has been commenced and pursued for the purpose of enjoying the advantages of imprisonment. Perhaps those who chiefly promoted the several prominent systems expected from them greater results, in the shape of the reformation of criminals, than any that have been obtained. If they have been disappointed in this, it can, at all events, be said that any prison in the now recognised system is no longer like the older prisons, an institution in which the young criminals advance into the rank of proficient, and the old improve each other's skill by mutual communication. The system now received is that of separation, so far as it is practicable. Two other systems were tried—the silent system and the solitary system. The former imposed entire silence among the prisoners even when assembled together; the latter endeavoured to accomplish their complete isolation from sight or communication with their race. By the separate system, the criminals are prohibited from communicating with each other; but they are visited by various persons with whom intercourse is more likely to elevate than to debase—as chaplains, teachers, scripture-readers, the superior officers of the prison, and those who have the external control over it.

**PRISONERS OF WAR** are those who are captured from the enemy during naval or military operations. By the laws or recognised principles of war, the entire people of a vanquished town, state, or nation become the absolute property of the victors; but civilisation has greatly modified this stern rule, and, except when a country is devastated for military reasons, it is rare for non-combatant citizens to be subjected to penalties of conquest, beyond the levying of contributions in money or provisions. The combatants who have laid down their arms become prisoners of war. Their lives and liberty are at the disposal of their conquerors, and even in modern times, their lives are sometimes taken, as, for instance, when Napoleon put the Turkish prisoners to death at Jaffa in 1799; otherwise, prisoners of war are kept in confinement until peace ensues, or they are exchanged for prisoners of their conqueror's nation, held in captivity by their own countrymen. It is unusual to subject prisoners of war to penal discipline; but the loss of liberty and hard fare (for, of course, they are allowed no more than a bare subsistence) render captivity

sufficiently irksome. In ancient times, the treatment of prisoners of war was far more severe. In the Greek wars, it was no uncommon thing to put the whole adult male population of a conquered state to the sword, while the women and children were enslaved. Although the putting to death of prisoners became less frequent, they and their families were commonly reduced to slavery to as recent a period as the 13th century. About that time, the more humane custom of exchanging prisoners came into practice. Notwithstanding frequent exchanges, large numbers of prisoners accumulate during war. In 1811, about 47,600 French were prisoners in England, while 10,300 English languished in the prisons of France. See **PABOLE**.

**PRISRE'ND**, a town of European Turkey, in the eyalet of Uskup (Albania), on the Rieka, 80 miles east of Scutari. It is one of the most beautiful, rich, and industrious towns in Turkey, with a citadel situated upwards of 1100 feet above sea-level. It contains an immense number of bazaars, and carries on an active trade in flints, saddlery, glass, copper, and steel wares. Among its edifices are 15 mosques. Pop. upwards of 20,000.

**PRISTI'NA**, a town of European Turkey, in the eyalet of Uskup, 30 miles north-north-east of Prisrend, stands on a hill, and is the most considerable town in Old Servia. Pop. about 9000.

**PRISTIS**. See **SAWFISH**.

**PRITHU** is the name of several legendary kings of ancient India. It is, however, especially one king of this name who is the favourite hero of the Purāṇas. His father was Ven'a, who perished through his wickedness; for when he was inaugurated monarch of the earth, he caused it to be everywhere proclaimed that no worship should be performed, no oblations offered, and no gifts bestowed upon the Brahmans. The Rishis, or Saints, hearing of this proclamation, entreated the king to revoke it, but in vain; hence they fell upon him, and slew him. But the kingdom now being without a king, as Ven'a had left no offspring, and the people being without protection, the sages assembled, and consulted how to produce a son from the body of the dead king. First, then, they rubbed his thigh; from it, thus rubbed, came forth a being called Nishāda; and by this means the wickedness of Ven'a having been expelled, they proceeded to rub the right arm of the dead king, and by this friction engendered P., who came forth resplendent in person, and in his right hand the mark of the discus of Vishnu, which proved him to be a universal emperor, one whose power would be invincible even by the gods. The mighty P. soon removed the grievances of the people; he protected the earth, performed many sacrifices, and gave liberal gifts to the Brahmans. On being informed that, in the interval in which the earth was without a king, all vegetable products had been withheld, and that, consequently, the people had perished, he in great wrath marched forward to assail the earth. The earth, assuming the figure of a cow, fled before him; but seeing no escape from the power of the king, at last submitted to him, and promised to renew her fertility, provided that he made all places level. P. therefore uprooted mountains, levelled the surface of the earth, established boundaries of towns and villages, and induced his subjects to take up their abode where the ground was made level. The earth now fulfilled her promise; and as P., by thus granting her new life, became, as it were, her father, she was henceforth called Prithivī. However little the worth of this piece of popular etymology—for *prithivī*, or *prithu*, 'earth,' the feminine of *prithu* (Greek *platu*) means etymologically

'the large' or 'wide'—the legend of P. itself seems to record some historical fact regarding the civilising influences exerted by a great king of Hindu antiquity.

**PRIVATE**, the title applied in the British army to a common soldier of the cavalry and infantry; the corresponding rank in the artillery being gunner or driver, and in the engineers, the sapper. The pay of a private is one shilling a day in the infantry, and 1s. 3d. in the cavalry—exclusive, in each case, of one penny a day for beer-money. A private in the cavalry is sometimes called a trooper.

**PRIVATEER**, a ship owned by a private individual, which, under government permission, expressed by a Letter of Marque (q. v.), makes war upon the shipping of a hostile power. To make war upon an enemy without this commission, or upon the shipping of a nation not specified in it, is piracy. Privateering was abolished by mutual agreement among European nations by the Treaty of Paris in 1856. It is doubtful, however, how far that abolition would stand in a general war, for privateering is the natural resource of a nation whose regular navy is too weak to make head against the maritime power of the enemy, especially when the latter offers the temptation of a wealthy commerce.

**PRIVET** (*Ligustrum*), a genus of plants of the natural order *Oleaceæ*, containing a number of species of shrubs and small trees with opposite leaves, which are simple and entire at the margin; the flowers small, white, and in terminal panicles; the calyx slightly 4-toothed; the corolla funnel-shaped and 4-cleft; the stamens two, projecting beyond the tube of the corolla; the berries 2-celled. **COMMON P.** (*L. vulgare*) is a shrub growing in bushy places and about the borders of woods in the middle and south of Europe, and in some parts of Britain, now also naturalised in some parts of North America. It has half-evergreen, smooth, lanceolate leaves; and berries about the size of peas, black, rarely white, yellow, or green. The flowers have a strong and sweetish smell; the leaves are mildly astringent, and were formerly used in medicine; the berries, which hang on the shrub during winter, have a disagreeable taste, but serve as food for many kinds of birds; they are used for dyeing red, and with various additions, green, blue, and black. A rose-coloured pigment obtained from them is used for colouring maps. The wood is hard, and is used by turners, and by shoemakers for making wooden pegs. P., although not spiny, is much used for hedges, often mixed with some spiny shrub, or with beech. It bears clipping well, and grows well in the smoke of towns, also under the shade of trees.—A number of species of P. are natives of different parts of the East, and some of them have begun to be introduced into shrubberies in Britain.—All kinds of P. grow readily from cuttings.

**PRIVILEGE** (Lat. *privilegium*, from *privata lex*, a private law), a special ordinance or regulation, in virtue of which an individual or a class enjoys certain immunities or rights from or beyond the common provisions of the general law of the community. It differs from a *dispensation* inasmuch as the latter merely relaxes the existing law for a particular case or cases, while the privilege is a permanent and general right. Of ancient and medieval legislation, the law of privilege formed an important branch; and, in truth, the condition of the so-called 'privileged classes' was in all respects different, socially, civilly, and even religiously, from that of the non-privileged. In canon law, there were two privileges enjoyed by the clergy, which deserve especial notice, from the

frequency of the historical allusions to them—the 'privilege of the canon' (*privilegium canonicum*) and the 'privilege of the forum' (*privilegium fori*). By the former, the person of the clergyman, of whatever degree, was protected from violence by the penalty of excommunication against the offender; by the latter—known in England as 'benefit of clergy' (q. v.)—the clergyman was exempted from the ordinary civil tribunals, and could only be tried in the ecclesiastical court. Most of the purely civil privileges are abolished throughout Europe by modern legislation.

**PRIVILEGED DEBTS**, in the Law of Scotland, such debts as are first paid out of certain funds. Thus, when a man dies, a certain sum is allowed out of his estate for Mournings (q. v.) to the widow and children. In case of bankruptcy, servants' wages are privileged to a certain extent.—**PRIVILEGED DEEDS** are holograph deeds, which are exempted from the statute which requires other deeds to be signed before witnesses.

**PRIVY-CHAMBER**, GENTLEMEN OF THE, officers of the royal household of England, instituted by King Henry VII., to attend on the king and queen at court, and in their progresses, diversions, &c. For a number of years past, no services have been required of these officers, and no salary or fee is attached to the office. There are also four Gentlemen Ushers of the Privy-chamber, who are in regular attendance on the sovereign, waiting in the Presence-chamber, and attending on the royal person; they have the honour of conducting her Majesty, in the absence of the higher officers.

**PRIVY-COUNCIL** (*consilium regis privatum*), an assembly of advisers on matters of state appointed by the sovereign. The Privy-council of England existed at a very early period in the history of the country. It was in its beginning a small permanent committee, or minor council, selected by the king out of the great council, or parliament; and in its powers were included—what still forms one of its functions—the right to inquire into all offences against the state, and to commit offenders for trial before the proper courts of law. It also frequently assumed the cognizance of questions of private right, a practice against which the statute 16 Charles I. c. 10 was directed, enacting that neither king nor council should have any jurisdiction in matters regarding the estates and liberties of the subject, which should be tried in the ordinary tribunals of the country. The Council in early times consisted of the Chancellor, the Treasurer, the Justices of either bench, the Escheaters, the Serjeants, some of the principal Clerks of the Chancery, and other members nominated by the king, who were generally bishops, earls, and barons. The Star-chamber and Court of Requests were both committees of Privy-council. The number of members, which had originally been 12, was gradually increased; and when the large number had become inconvenient, the sovereign sought the advice of a select body of the more influential among them. Charles II. limited the number of councillors to 30, 15 of whom comprised the chief officers of state and the *ex officio* members, to whom were added 10 peers and 5 commoners named by the sovereign; and it was intended that the Council, thus remodelled, should practically resume its original duties, and have the control of every part of the executive administration. The Court of Privy-council has, however, long ceased to discharge the function of advising the crown on the general affairs of government and state policy, a select number of the body, under the denomination of the Cabinet Council, forming the recognised executive council of the crown. See **MINISTRY**. The

## PRIVY-COUNCIL.

list of privy-councillors now includes the members of the royal family, the Archbishops of Canterbury and York, the Bishop of London, the great officers of state, the Lord Chancellor and judges of the Courts of Equity, the Chief Justices of the Courts of Common Law, the Ecclesiastical and Admiralty Judges, and the Judge Advocate, several of the Puisne Judges, the Speaker of the House of Commons, the Ambassadors, some of the Ministers Plenipotentiary and Governors of Colonies, the Commander-in-chief, the Master-general of the Ordnance, the First Lord of the Admiralty, and generally also a Junior Lord of the Admiralty, as well as necessarily all the members of the Cabinet. The Vice-president of the Board of Trade, the Paymaster of the Forces, and the President of the Poor-law Board, are also generally members of the Privy-council; and sometimes other persons who have filled responsible offices under the crown. It is now understood that no members attend the deliberations of Council except those who are especially summoned. In ordinary cases, only the ministers, the great officers of the Household, and the Archbishop of Canterbury, are summoned; but on some extraordinary occasions, summonses are sent to the whole Council—this was last done to receive her Majesty's communication of her intended marriage. Meetings of Council are usually held at intervals of three or four weeks at her Majesty's residence; and the attendance of six privy-councillors at least, with one of the clerks of Council, is considered necessary to constitute a council.

A privy-councillor must be a natural-born subject of Great Britain. The office is conferred by the sovereign's nomination, without any patent or grant, and completed by taking the oath of office. The duties of a privy-councillor, as defined by this oath, are—to the best of his discretion, duly and impartially to advise the king; to keep secret his counsel; to avoid corruption; to strengthen the king's council in all that by them is thought good for the king and his land; to withstand those who attempt the contrary, and to do all that a true councillor ought to do to his sovereign lord. The office of privy-councillor formerly fell by the demise of the crown; but by 6 Anne, c. 7, the Privy-council continues to exist for six months' longer, unless sooner determined by the successor. Immediately on the decease of the sovereign, the Privy-council now assembles and proclaims his successor, the Lord Chancellor affixing the Great Seal to the proclamation. The members of the Privy-council are then re-sworn as council of the successor, and take the oath of allegiance, after which a privy-council is held, and the sovereign makes a declaration of his designs for the good government of the realm, and subscribes the requisite oaths.

The king in Council, or a committee of the Lords of Council, have been empowered by various statutes to issue orders which are to have the force of law, parliament thus delegating its authority to regulate such matters as may be more conveniently regulated by Order in Council. In cases of extreme public emergency, at a time when parliament was not sitting, Orders in Council have sometimes been issued in contravention of the existing law, and the indemnification of parliament has afterwards been sought. See **ORDERS IN COUNCIL**. The sovereign, with the advice of the Privy-council, is also empowered to issue proclamations, which, however, must be in accordance with, and in furtherance of, the law of the land. See **PROCLAMATION**.

Almost every act of importance done by the sovereign in person is performed in Council—such as declarations of, or public engagements by, the sovereign, and consent to marriages by members

of the royal family. Among the functions of the Privy-council are also the appointment of sheriffs in England and Wales, and the issuing of orders for the laying on or removing of quarantine, or for granting reprisals, or for embargoes. The sovereign in Council has still more ample authority in all that relates to the colonies, including the making and enforcing of laws in such colonies as have no representative assemblies; and approving or disallowing the legislative acts of such as do possess them.

A large part of the business of the Privy-council is transacted by committees, to which petitions and other matters are submitted by the queen in Council. Among the permanent committees of Privy-council are the Board of Council for Trade and Foreign Plantations (see **TRADE, BOARD OF**); the Committee of Council for Education, appointed in 1839, to distribute the sum voted annually for educational purposes; and the Judicial Committee of Privy-council. This last-named committee consists of the Keeper of the Great Seal, the Chief Justices, the Master of the Rolls, the Chief Baron and other great judicial officers, with any two other privy-councillors who may be named by the sovereign. It was established by 3 and 4 Will. IV. c. 41, for the purpose of deciding certain questions of right or privilege, particularly with regard to the colonies, and hearing appeals in certain classes of cases, which, notwithstanding the above-cited act of Charles I., still fell under the jurisdiction of the Privy-council. Among these are appeals from the Courts of Equity, colonial appeals both at Common Law and in Equity, as also those causes which, prior to its abolition by 2 and 3 Will. IV. c. 92, were reviewed by the Court of Delegates (see **DELEGATES, COURT OF**), as the supreme court of appeal in ecclesiastical and maritime cases. The powers of the judicial committee of the Privy-council have been enlarged and regulated by 6 and 7 Vict. c. 38. The powers possessed by the General Board of Health, instituted by 11 and 12 Vict. c. 18, and 17 and 18 Vict. c. 95, are now, by 21 and 22 Vict. c. 97, vested in the Privy-council. The acts of committees of the Privy-council are designated Acts of the Lords of the Council, in contradistinction from Orders in Council, made by the sovereign, who is personally present, by advice of the Privy-council. The crown may refer to a Committee of Council any petition or claim of right for which the ordinary tribunals afford no remedy. The Lords of Council constitute a Court of Record for the investigation of offences against the state, the offenders being committed for trial before the ordinary tribunals. Certain state investigations, not of a criminal kind, have also been held to fall within their jurisdiction, such as the inquiry into the insanity of George III., the claim of Queen Caroline to be crowned as consort of George IV., and questions regarding alleged illegal marriages of the royal family.

The Privy-council is styled collectively 'Her Majesty's most Honourable Privy-council.' Privy-councillors are entitled to the designation 'Right Honourable' prefixed to their name, and take precedence next after Knights of the Garter. The personal security of a member of Privy-council was formerly guarded by certain statutes, visiting with fine a blow struck in his house or presence, and making it felony to conspire against him or assault him in the execution of his office; but these immunities were done away with by 9 Geo. IV. c. 31.

The Lord President of the Council is the fourth great officer of state, and is appointed by letters-patent under the Great Seal. The office is very

ancient, and was revived by Charles II. in favour of the Earl of Shaftesbury.

Scotland possessed a Privy-council, which was merged in that of England by 6 Anne, c. 6. There is a Privy-council for Ireland, which at present consists of 58 members, who are sworn pursuant to a sign-manual warrant directed to the Lord Lieutenant.

**PRIVY-COUNCIL (COMMITTEE OF) ON EDUCATION.** Till within the last thirty years, popular or primary education in England was left in the hands of individuals and societies. The only Societies of importance which endeavoured to overtake the enormous educational destitution which prevailed, were the British and Foreign School Society, founded under the patronage of George III.; and the National Society, of more recent date. The first-mentioned Society endeavoured to get rid of all religious difficulties by avoiding the use of catechisms in the school, and confining themselves to the use of the Bible alone. The Church party, however, felt that in accepting for the children of the country a religious training so vague, they were untrue to their principles, and would probably fail to secure for the young any efficient religious instruction at all. Accordingly, the National Society was set on foot as a specially Church institution. The object of both these Societies was, by means of contributions collected from benevolent persons, to aid in the foundation and maintenance of elementary schools throughout England and Wales.

The prevailing destitution was, however, too widespread to be met by voluntary associations, and it consequently became necessary that the State should take some share in the education of the people. Parliamentary grants of small amount were made, which were distributed by the Treasury under regulations issued in 1833, the chief of which was as follows: 'That no application be entertained by the Treasury unless a sum be raised by private contribution equal, at least, to one-half of the total estimated expenditure.' These grants were for the purpose of erecting school-buildings. In 1839, after considerable opposition, it was resolved to increase the parliamentary grant, and to appoint a Committee of Her Majesty's Privy-council to administer it. On the 3d June 1839, an order of Council laid down, that the grants of previous years not yet appropriated, as well as the grant for the current year, should be expended for the erection of schools, and that £10,000 voted for Normal Schools in 1835 should be given in equal proportions to the British and Foreign and the National Societies. The Privy-council Committee did not at first contemplate aiding any schools but those in connection with the two Societies which we have just named; but in September of 1839, they resolved to aid other schools, where special circumstances prevented their affiliation to the Societies. In the course of a year or two it came practically to this, that *all schools were aided in which the Bible was daily read from the authorised version.*

The various religious denominations, under the influence, partly, of the strong pecuniary inducement held out by the Committee of Council, now began to exert themselves to erect schools, and to claim state aid. The Committee of Council, seeing the large probable increase in the number of schools requiring to be maintained partially out of the state funds, had their attention specially directed to the principles of their administration, and the conditions on which alone aid was to be granted. The first measure of importance was the appointment of inspectors of schools. These were appointed by Her Majesty; but the Church

of England was permitted to exercise a veto on those nominated for the inspection of Church schools, and the dissenting education committees were allowed a similar privilege with reference to those nominated for dissenting schools. No school was to be admitted to government aid in any form which did not declare its willingness to submit to inspection. The next measure of importance was the determining of the conditions on which aid should be given, first, for the erection, and, secondly, for the maintenance of schools. Grants for the former purpose were given in proportion to the number of children to be educated and the amount of money raised by private contribution.

In 1846, the first step seems to have been made towards making grants for the *maintenance* of schools. It was resolved to apprentice promising boys to their teachers—these boys to give assistance in the school-work, and to be paid annual stipends by government. The masters were to give special instruction to these boys in terms of a programme drawn up by the Committee of Council, and they were to be paid a small sum per annum for discharging this duty. At the same time, it was resolved to distribute gratuities annually among deserving teachers.

The course of instruction for these apprentices, who were to be designated pupil-teachers, extended over five years, and their remuneration was arranged as follows: First year, £10; second, £12, 10s.; third, £15; fourth, £17, 10s.; fifth, £20. To schools taught by the humbler class of teachers, stipendiary monitors were allowed at a smaller rate of stipend.

In contemplation of the close of the apprenticeship of pupil-teachers, it was further resolved to grant them a scholarship or bursary, to enable them to pursue their studies at one of the numerous male and female normal schools which had come into existence; and at the conclusion of their training, to allow a grant of money to the normal school to which they had resorted. The Queen's Scholarship, as the bursary was called, was fixed at £20; and the grants to the normal school at £20, £25, and £30, according as they had trained the student for one, two, or three years—two-thirds of these sums being allowed in the case of female students. It was further necessary to contemplate the completion of the normal-school training, and to endeavour to secure for the public service the well-trained teachers who had been educated at the public expense. Accordingly, it was resolved to grant to teachers sums ranging from £15 to £30 per annum (and two-thirds of these sums in the case of females), provided the school-buildings in which they taught, and the character of their teaching, were satisfactory to Her Majesty's inspectors. A condition, afterwards added, was, that the teacher should receive from local sources, including school-fees, not less than twice the amount paid by government, of which one-half should be from voluntary subscriptions. The amount which the teacher might claim, besides being payable only on the conditions stated above, was made partially dependent on the grade of certificate obtained at the normal school. The certificate was, and still continues to be, granted on the student's passing a satisfactory examination in all the subjects taught in elementary schools, in addition to physical geography, and either mathematics or Latin.

These are the principles of administration which have continued to regulate the action of the Privy-council, both as to the class of schools aided and the manner of aiding them, up to the present date. The consequence has been an astonishingly rapid increase in the number of primary schools and

normal schools or colleges; of the latter, there are about 40 in England and Scotland.

Two years ago, a new code was introduced, which came into full operation in June 1863. The provisions of this code were suggested by a Royal Commission, appointed to inquire into the state of primary instruction. They reported a want of sufficient attention in elementary schools to the younger children and to the more elementary branches. It had so happened that, in 1853, a Minute had been issued by the Privy-council enabling schools to claim, in addition to the augmentation of teachers' salaries referred to above, a capitation fee for every child who had attended 176 days in the course of the year. Accordingly, with a view to simplify their administration, and to render it more efficient, the Privy-council, by the New or Revised Code, resolved to pay henceforth only in the form of capitation grants (a system already partially adopted), a sum of 12s. for each child, subject to a deduction of 2s. 8d. for every child who fails in reading; and similar deductions for those who fail in writing and arithmetic. The managers of each school are, under the Revised Code, required to pay the teacher, who has no longer any direct connection with government, and to engage an additional teacher, either adult or in the form of a pupil-teacher, when the average attendance reaches 90. These pupil-teachers will be examined annually as heretofore by Her Majesty's inspector, but they have no direct connection with government, as formerly. The managers select and pay them as they select and pay the principal master or mistress (as the case may be), trusting to local subscriptions, fees, and the government capitation grants, for the means of discharging their obligations, and maintaining the school in efficiency.

The above sketch of the Privy-council system applies also to Scotland, with this difference, that when the Revised Code was issued the opportunity was regarded as a favourable one for considering whether there were not peculiarities in the educational system of Scotland, which might make it advisable either to separate educational administration there from that of England, or to found a national system on the basis of the time-honoured system of parochial schools—excellent in themselves, but too few to supply the wants of the country. With these objects in view, a Royal Commission was issued in 1864, which is now (January 1865) taking evidence on the whole question as it affects Scotland.

**PRIVY-PURSE, KEEPER OF THE**, an officer of the royal household charged with the payment of the private expenses and charities of the sovereign. He is independent of the great officers of the household, and has no control over any official or household charges. The office is of modern creation.

**PRIVY-SEAL**, the seal appended to grants which are afterwards to pass the Great Seal, and to documents of minor importance which do not require the Great Seal. The officer who has the custody of the Privy-seal was at one time called the Keeper, and afterwards the Lord Privy-seal. As early as the reign of Edward III., he was a member of the king's council, and a responsible minister of the crown. The Lord Privy-seal is now the fifth great officer of state, and has generally a seat in the cabinet. His office is conferred under the Great Seal during pleasure. Since the reign of Henry VIII., the Privy-seal has been the warrant of the legality of grants from the crown, and the authority for the Lord Chancellor to affix the Great Seal. Such grants are styled letters-patent, and the office of the Lord Privy-seal is one of the

departments through which they must pass to secure their validity. Until recently, all letters-patent for the grant of appointments to office under the crown, of patents of invention, charters, naturalisations, pensions, creation of honours, pardons, licenses in mortmain, &c., required to pass from the Signet Office to the Privy-seal Office, in the form of Signet bills, verified by the Signet Seal and superscription, and the signature of the clerk of the Signet. These Signet bills were the warrant for the Privy-seal; and on the Privy-seal being attached to them, they were forwarded to the Lord Chancellor, by whom the patents were engrossed and completed in the office of the Great Seal. The statute 11 and 12 Vict. c. 82, abolished the Signet Office, and enacted that warrants under the royal sign-manual, prepared by the Attorney-general and Solicitor-general, setting forth the tenor and effect of the letters-patent to be granted, addressed to the Lord Chancellor, and countersigned by one of the principal secretaries of state, should be a sufficient authority for the Privy-seal being affixed; and that the sign-manual so signed, countersigned, and sealed, should be sufficient warrant to the Lord Chancellor to pass letters-patent under the Great Seal. This statute abolished the previously-existing offices of Clerks of the Signet and Clerks of the Privy-seal.

There is a Privy-seal in Scotland, which is used to authenticate royal grants of personal or assignable rights. Rights such as a subject would transmit by assignation, are transmitted by the sovereign under the Privy-seal.

**PRIZE, PRIZE-MONEY**, terms having reference to property captured from an enemy, or to enemy's property captured from a neutral in time of war. The circumstances under which such capture is justifiable are stated under CAPTURE, as regards naval operations; military prize and its distribution to the army are described under BOOTY. It remains only, therefore, to notice the procedure taken in respect to vessels and property captured by the navy. On a ship being taken, she must be sent to a port belonging to the capturing power, where the Court of Admiralty, on full evidence, adjudicates whether she be lawful prize or not. If the decision be affirmative, the prize is then sold; or if a ship-of-war, a certain allowance per gun is granted by the state. The produce of the sale or grant is lodged in the hands of the Accountant-general of the Navy, for distribution to the officers and men who assisted at the capture. The net produce of the sale or grant is first divided rateably among any ships (if there be more than one) concerned in the capture. The share of each ship is then divided into eight equal parts. If she were employed under the orders of a flag-officer, he gets one-eighth, and the captain two-eighths; if not, the captain has three-eighths; one-eighth is divided among the lieutenants and officers of corresponding relative rank; one-eighth is shared by the junior commissioned officers and warrant officers; one-eighth goes to the midshipmen and petty officers; and the remaining two-eighths among the seamen, marines, and boys.

**PRIZE-COURT** is a court which adjudicates the property in vessels captured at sea from a belligerent; and the rule is, that when a captor brings home a prize, the tribunal of his own country has jurisdiction to declare whether he is entitled to it, which decision is binding everywhere. A prize-court differs from other courts in this, that the property of foreigners is brought within its jurisdiction, not by consent, as is implied with regard to the ordinary municipal courts, but by force. By



natural law, one would suppose that the tribunals of the captor's country are no more the rightful exclusive judges of captures in war, made on the high seas from under the neutral flag, than are the tribunals of the neutral country. Nevertheless, such is the rule of international law, which vests this jurisdiction in the prize-court. In Britain, the court is created by commission under the Great Seal, and the judge of the Admiralty Court is usually appointed. Lord Stowell was the judge during the French war, and, during the time he sat as judge, delivered many important judgments in this difficult branch of the law.

PROA, commonly known as the 'flying proa,' is a peculiarly-shaped canoe in use by the natives of the Eastern Archipelago, and especially by the Ladrone pirates. It is about 30 feet in length by 3 in width, and has the stem and stern equally sharp, so as to sail backward or forward without being turned round. One side is flat, and in a



Proa.

straight line with the stem and stern; the other side is rounded, as in ordinary boats. This peculiar formation would make it liable to be easily upset, were it not for a framework which projects to windward, supporting a weight which counterbalances the pressure of the wind on the sail. The sail resembles the ordinary lug-sail, and is formed of mat. Slight variations from this form are found, but the principle of construction is the same.

PROBABILISM (Lat. *probabilismus*, a barbarous technical word, from *probabilis*, probable), in Roman Catholic theology, means the doctrine regarding the use of so-called 'probable opinions' in guiding the conscience as to the lawfulness or unlawfulness of any particular action. The word came prominently into discussion in the 17th c., and seems now fully accepted as a technical name. As the ground of the doctrine, it is assumed that, in human actions, absolute certainty is not always attainable as to their lawfulness or unlawfulness. Short of this certainty, the intellect passes through the stages of 'doubt' and of 'probability.' In the former, it is swayed between conflicting views, so as to be unable to decide, or even to approach towards deciding, what is true. In the latter, although there is a conflict of views, yet the reasons in their favour are not so equal that the intellect cannot see preponderating motives in favour of the truth of one or of the other. Moreover, in the conflict of views, another element will arise, as to their comparative 'safety,' that is,

the greater or less danger of moral culpability which they involve; and this greater or less moral 'safety' of a view may, or may not, coincide with its greater or less 'probability.' The doctrine of 'probabilism' is founded upon these distinctions; and it presents itself in four different schools, all of which agree in professing that it is lawful, in certain cases, to act upon opinions which are merely 'probable.' Opposed to all these four, is the school of *Anti-probabilism*, which rejects altogether the use of probable opinions, and requires that an opinion shall be absolutely morally certain, in order that it may be lawful to act upon it. The four schools of probabilism are called: *Probabilism Simple*, *Equiprobabilism*, *Probabiliorism* (from *probabilior*, more probable), and *Tutorism* (from *tutor*, more safe). The first holds that it is lawful to act upon any probable opinion, no matter how slight its probability. The second requires that the opinion shall be 'solidly probable,' but holds that, provided it be really probable, it is lawful to act upon it, even though the conflicting opinion should be equally probable. The third, in the conflict of probable opinions, will only permit us to act on the more probable of the two; but permits this even when the less probable adverse opinion is the 'more safe.' The fourth requires that in all cases the more safe opinion shall be followed, even when the less safe opinion is much the more probable. It is commonly said that the system of probabilism is modern; but this is only true of the discussions regarding it, for the doctrine itself, in some of its forms, is as old as the study of ethics, even considered as a moral science. The disputes regarding it arose with the science of casuistry, when men, in the 16th and 17th centuries, began to reduce morals to a system. It formed a leading subject of the controversy between the Jesuits and the Jansenists, although it is a great, while it is a very common, mistake to suppose that all the Jesuits were probabilists, and that all the Jansenists were opposed thereto. Very few Jesuits, indeed, were of the school which is chiefly assailed in the *Provincial Letters* (see PASCAL), that of Probabilism Simple. Without entering into the history of this very curious controversy, it will be enough to say that the Roman Church, while condemning the two extremes—the extreme of anti-probabilism, which excludes all use even of the most probable opinions, and the lax extreme of simple probabilism, which accepts even the slightest probability as sufficient—has left the intermediate opinions for free discussion. The great modern master on the subject is St Alfonso de Liguori, whose system may be described as a kind of practical probabiliorism, in which, by the use of what are called reflex principles, an opinion which *objectively* is but probable, is made *subjectively* the basis of a certain and safe practical judgment. There can be no doubt that the system of probabilism has been pushed by some individual divines to scandalous extremes; but it is only just to add that these extremes have been condemned by authority in the Roman Church; and that, on the other hand, the principles of the higher Roman schools of probabilism are substantially the same as those of all moralists, whether of the old or of the new schools of ethics.

Protestants, however, and with them some Roman Catholics, reprobate probabilism in all its schools or forms, as a mere scheme for the delusion of conscience and excuse or justification of immorality. They maintain the Scriptural or Christian rule, and the only rule of true morality, to be that no man is entitled on any account to do that of which he doubts whether it is contrary or agreeable

PROBABILITY.

to the law of God. Every man must often choose between two courses, as to which is the most expedient; but this they hold to be a totally different thing. It is also urged against the probabilists, that they make the authority of *doctors*, or learned theologians, sufficient justification for a man's doing that which otherwise he would deem it unlawful to do; asserting that it will keep him safe at the judgment seat of God.

**PROBABILITY, THE MATHEMATICAL THEORY OF.** Of all mathematical theories which can be made in any sense popular, this is perhaps the least generally understood. There are several reasons for this curious fact, of which we may mention one or two. *First*.—As by far the simplest and most direct elementary illustrations of its principles are furnished by games of chance, these have been almost invariably used by writers on the subject; and the result has been a popular delusion, to the effect that the theory tends directly to the encouragement of gambling. Nothing can be more false than such an idea. Independent of moral considerations, with which we have nothing to do here, no arguments against gambling can be furnished at all comparable in power with those deduced from the mathematical analysis of the chances of the game. *Second*.—In many problems, some of them amongst the easiest in the theory, the very highest resources of mathematics are taxed in order to furnish a solution. One reason is very simple. The solutions, however elementary, involving often nothing but the common rules of arithmetic, sometimes lead to results depending upon enormous numbers, and very refined analysis is requisite to deduce *easily* from these what would otherwise involve calculations, simple enough in character, but of appalling labour. Higher mathematics here perform, in fact, something analogous to *skilled labour* in ordinary manufactures. The simplest illustration of this is in the use of LOGARITHMS (q. v.), which reduce multiplication, division, and extraction of roots to mere addition, subtraction, and division respectively. Powerful as logarithms are, analysis furnishes instruments almost infinitely more powerful. The large numbers which occur in probabilities are usually in the form of *products*, and we may exemplify the above remarks as follows.

To find the value of the product 1.3.5.7, no one would think of using anything but common arithmetic; but, if he were required to find the value of 1.3.5.7.9.....49, he would probably have recourse to logarithms, *merely to avoid useless labour of an elementary kind*. But in very simple questions in probabilities, it may be requisite to find (approximately) the value of a product such as 1.3.5.7.9.....23999—i. e., that of the first 12,000 odd numbers. No one in his senses would dream of attempting this by ordinary arithmetic, but it is the mere labour, not the inherent difficulty, which prevents him. Few would even attempt it by means of logarithms; for, even with their aid, the labour would be very great. It is here that the higher analysis steps in, and helps us *easily* to a sufficiently accurate approximation to the value of this enormous number. Thus, it appears that this objection to the study of the theory of probabilities is not applicable to their principles, which are very elementary, but to the mere mechanical details of the processes of solution of certain problems. *Third*.—There are other objections, such as the (so-called) religious one, that 'there is no such thing as chance,' and that 'to calculate chances is to deny the existence of an all-ruling Providence,' &c.; but, like many other similar assertions, these are founded on a total

ignorance of the nature of the science; and, therefore, although pernicious, may be safely treated with merited contempt. The authors of such objections remind us of the Irishman who attempted to smash Lord Ross's great telescope, because 'it is irreligious to pry into the mysteries of nature.'

It appears to us that the best method of explaining the principles of the subject within our necessarily narrow limits, will be to introduce definitions, &c., as they may be called for, in the course of a few elementary illustrations, instead of elaborately premising them.

*First Case*.—The simplest possible illustrations are supplied by the common process of 'tossing' a coin, with the result of 'head' or 'tail.' Put H for head, and T for tail. Now, the result of one toss, unless the coin should fall on its edge (which is practically impossible), *must* be either

H or T.

Also, if the coin be not so fashioned as to be more likely to fall on one side than the other (as, for instance, is the case with loaded dice), *these events are equally likely*; or, in technical language, *equally probable*. To determine numerically the likelihood or the probability of either, we must assign some numerical value to *absolute certainty*. This value is usually taken as *unity*, so that a probability, if short of absolute certainty, is always represented by a proper fraction. Suppose that *p* (a proper fraction) represents the probability of H, then evidently *p* is also the probability of T, because the two events are equally likely. But one or other *must* happen; hence, the sum of the separate probabilities must represent certainty. That is,

$$p + p = 1, \text{ or } p = \frac{1}{2}$$

Thus we have assigned a numerical value to the probability of either H or T, by finding what proportion each bears to certainty, and assigning to the latter a simple numerical value.

Suppose, as a contrast, the coin to be an unfair one, such as those sometimes made for swindling purposes, with H on each side. Then we *must* have in one toss

H or H;

i. e., H is *certain*, or its probability is 1. There is no possibility of T, and therefore its probability is 0. Absolute impossibility is therefore represented by the numerical value of the probability becoming zero.

*Second Case*.—Suppose a 'fair' coin to be tossed twice in succession. The event *must* be one of the four—

H, H; H, T; T, H; or T, T.

Now all four are evidently equally likely; i. e., their probabilities are equal. But one of them *must* happen—hence the sum of their probabilities amounts to certainty, or 1. That is, each of the four cases has a probability measured by the fraction  $\frac{1}{4}$ .

Here we may introduce a new term. What are the *odds* against H, H? The answer is, the chance or probability of H, H is  $\frac{1}{4}$ ; that is, *one case in four* is favourable, hence *three* are unfavourable, and the odds are said to be 3 to 1 against the event. *In general the odds against any event is the ratio of the probability that it will not, to the probability that it will, happen.*

Thus, in the first case above, the odds against H in one toss are even.

*Third Case*.—What is the chance of throwing both head and tail in two tosses of a coin? Remark that this is *not* the same question as, 'What is the

PROBABILITY.

chance of head followed by tail, in two tosses? The latter question was answered in the *Second Case*, for the chance of H, T was there shewn to be  $\frac{1}{4}$ . The present event contemplates either H, T or T, H—and its probability is therefore  $\frac{1}{4} + \frac{1}{4}$ , or  $\frac{1}{2}$  since each has the separate probability  $\frac{1}{4}$ . Or we may reason thus: Of the four possible cases of two tosses of a coin, two give both head and tail—all four are equally probable—hence the probability is 2 in 4, or 1 in 2; i. e.,  $\frac{1}{2}$ .

*Fourth Case.*—What is the chance of throwing H in two tosses? Remark that this is not the same question as, 'What is the chance of H once only in two tosses?' The latter question is that of the Third Case merely put in a different form. Nor will it do to answer our question thus:

$$\text{Chance of H in first throw} = \frac{1}{2}$$

$$\text{Chance of H in second throw} = \frac{1}{2}$$

$$\text{Therefore chance of H in two throws} = \frac{1}{2} + \frac{1}{2} = 1.$$

For by this reasoning it would appear that we must get head once at least in two throws; which is obviously absurd, for we may have T, T.

This very elementary example shews how delicate the reasoning in this subject is, and how liable one is to make (complacently) the most preposterous mistakes.

The error of the above process is introduced by the fact, that we have not considered that if H be obtained in the first throw, our object is attained, and no second throw is required. The correct work is this—

$$\text{Chance of H in first throw} = \frac{1}{2}$$

If H come, the game is finished.

$$\left. \begin{aligned} \text{Chance of T in the first throw, in which} \\ \text{case we must throw again,} &= \frac{1}{2} \\ \text{Subsequent chance of H in second throw} &= \frac{1}{2} \end{aligned} \right\}$$

Combining these, we have—

$$\text{Chance of H at second throw only} = \frac{1}{2} \times \frac{1}{2} = \frac{1}{4}$$

$$\text{Add chance of H at first throw} = \frac{1}{2}$$

$$\text{Sum, or chance of H in two throws} = \frac{3}{4}$$

A simpler method is this. The possible throws, all equally likely, are, as before—

H, H; H, T; T, H; and T, T.

The first three of these satisfy the requirements of the question; i. e., the required event has 3 chances in 4 in its favour, or its probability is  $\frac{3}{4}$ .

*Fifth Case.*—The chance of H in any one throw is  $\frac{1}{2}$  (by *First Case*). The chance of H, H is  $\frac{1}{4}$  (*Second Case*). Now  $\frac{1}{4} = \frac{1}{2} \times \frac{1}{2}$ ; i. e., the chance of the joint occurrence of two independent events, at least in this simple case, is the product of their separate probabilities. Contrast this with the principle, already several times employed, that the probability of an event which may arise from one of a number of causes (no two of which can coexist), is the sum of the

separate probabilities. Simple proofs of these statements, in all their generality, will now be given, along with various other important propositions.

(A.) If an event may occur in  $p$  ways, and fail in  $q$  ways—all being equally likely—the probability of its happening in one trial is  $\frac{p}{p+q}$ , and of its failing,

$$\frac{q}{p+q} \text{—and the odds in its favour are } p:q.$$

The simplest way of conceiving this, and many other hypothetical cases, is to suppose one ball to be drawn from a bag which contains a number of balls, differing from each other in colour, or in some other quality not distinguishable by the touch. Suppose the bag to contain  $p$  white balls (W), and  $q$  black ones (B), and one ball to be drawn; what is the chance of its being white?

Here there are  $p$  chances in favour of a white ball being drawn, and  $q$  chances against it—these being all equally likely, or having equal probabilities—the chance of W is therefore  $p$  in  $p+q$ ; i. e., is expressed by the fraction,

$$\frac{p}{p+q}$$

The chance against W is  $q$  in  $p+q$ , or

$$\frac{q}{p+q}$$

And the sum of these fractions is 1, or certainty, as it ought to be—for the ball drawn must be either W, or not W.

(B.) If an event may occur in  $p$  ways, and fail in  $q$  ways, all being equally likely—what are the chances of (a) its happening twice, (b) its happening the first, and failing the second, (c) its failing the first time, and happening the second, and (d) its failing twice, in two trials?

Taking the illustration in (A) above, we see that there are  $p$  independent ways of succeeding in the first case, and  $p$  in the second; hence, there are  $p \times p$ , or  $p^2$  independent ways of succeeding twice. For any one of the first  $p$  may occur along with any one of the second. But the whole possible number of ways of experimenting twice is  $(p+q)(p+q)$ , or  $(p+q)^2$ ; hence, the

$$\text{Chance of (a) i. e. succeeding twice, is } \frac{p^2}{(p+q)^2}$$

$$\text{Similarly, chance of (b) is } \frac{pq}{(p+q)^2}$$

$$\text{" " " (c) is } \frac{qp}{(p+q)^2}$$

$$\text{" " " (d) is } \frac{q^2}{(p+q)^2}$$

The sum of these is  $\frac{p^2 + 2pq + q^2}{(p+q)^2} = 1$ , as it ought.

(C.) An attentive consideration of (B) shews us that when we have the independent probabilities of two events, the probability that they will jointly occur is the product of their separate probabilities.

$$\text{Thus, for W, in first trial, chance is } \frac{p}{p+q}$$

$$\text{" " second " " " } \frac{p}{p+q}$$

Whose product is  $\frac{p^2}{(p+q)^2}$ ; the probability of W is each of two successive trials.

$$\text{Again, for W, in the first trial, chance is } \frac{p}{p+q}$$

$$\text{" B " second " " } \frac{q}{1+q}$$

PROBABILITY.

Whose product is  $\frac{pq}{(p+q)^n}$ , which is found above to be the chance of WB. And so on.

(D.) This may be generalised as follows—the process will be evident to all who can understand the very elementary algebra employed :

$$\text{Certainty} = 1 = \frac{(p+q)^n}{(p+q)^n} = \frac{p^n + np^{n-1}q + \frac{n \cdot n-1}{1 \cdot 2} p^{n-2} q^2 + \dots + q^n}{(p+q)^n}$$

by the Binomial (q. v) Theorem of Newton. Now the parts of this expression—i. e.,

$$\frac{p^n}{(p+q)^n}, \frac{np^{n-1}q}{(p+q)^n}, \dots, \frac{q^n}{(p+q)^n}$$

represent, obviously, the chances of W n times, W n-1 times and B once, W n-2 times and B twice, ....., B n times, in n trials, where the order of occurrence is not considered.

If the order be considered, the chance of any arrangement, such as WBWBWW, for instance, is evidently

$$\frac{p \cdot q \cdot p \cdot p \cdot q \cdot q \cdot q \cdot p}{(p+q)^8} = \frac{p^4 q^4}{(p+q)^8}$$

But the chance of 4W and 4B in 8 trials, without respect to order, is as above, the term containing  $p^4 q^4$  in the expansion of  $(p+q)^8$ , divided by  $(p+q)^8$ —i. e.,

$$\frac{70 p^4 q^4}{(p+q)^8}$$

To take a simple example: if there be 2W and 1B in a bag, and each ball be replaced immediately after drawing, the chance of W 4 times in succession is  $\frac{2^4}{3^4} = \frac{16}{81}$ .

Of the particular combination WBWB, the chance is  $\frac{2}{3} \cdot \frac{1}{3} \cdot \frac{2}{3} \cdot \frac{1}{3} = \frac{4}{81}$ .

But the chance of W twice and B twice, without respect to order, is  $6 \frac{2^2 \cdot 1^2}{3^4} = \frac{24}{81}$ ; the numerator of the fraction being the term of  $(2+1)^4$  which contains the product  $2^2 \cdot 1^2$ .

(E.) From the preceding results it is obvious that the probability of the joint occurrence of any set of independent events is the product of their separate probabilities.

(F.) We may vary the process by supposing that there are several bags, each containing some balls, which may be white or black; but the number in each bag, and the proportion of white to black, being any whatever. One ball only is to be drawn, what is the chance that it is W?

If n be the number of bags, the chance that the ball will be drawn from any particular bag is  $\frac{1}{n}$  [see (A)]. And if in that bag there be p of W and q of B, the chance that W will be drawn from it is  $\frac{p}{p+q}$  [see (A)].

Hence the chance that W is drawn, and from the particular bag, is,

$$\frac{1}{n} \cdot \frac{p}{p+q} \text{ by (E).}$$

And the whole chance that W is drawn is the sum of all the chances,  $\frac{1}{n} \cdot \frac{p}{p+q}$ , for each of the bags.

Thus, let there be 5 bags, containing, respectively, WB, WW, BB, WWB, WWW; our chance is

found as follows: The chance of the ball being drawn from any particular bag is  $\frac{1}{5}$ ; since all are equally likely to be chosen. Then, supposing the first chosen, the chance of W is  $\frac{1}{2}$ ; if the third be chosen, the chance of W is 0, &c. Hence, on the whole, the chance of W is

$$\frac{1}{5} \cdot \frac{1}{2} + \frac{1}{5} \cdot 1 + \frac{1}{5} \cdot 0 + \frac{1}{5} \cdot \frac{2}{3} + \frac{1}{5} \cdot 1 = \frac{19}{30}$$

(G.) Hence, if an event may happen in consequence of any one of a set of causes, such that the action of one excludes that of the others; its probability is the sum of the products formed by multiplying the chance of the action of each cause by the chance that that cause, if operating, will produce the desired event.

We might easily extend this very simple series of results, but our limits restrict us to an attempt to shew more the extent of the subject than the details of its application to any particular set of questions. We therefore reluctantly pass to the consideration of an inverse problem or two.

(H.) An event has occurred, which may have arisen from any one of a set of mutually exclusive causes: to determine the probability that any particular cause was the efficient one—the probability of the event's happening, when any particular one of the causes operates, being known.

As a simple example will shew us how to proceed in the most general case, take the 5 bags of (F) above. The chances of drawing W from them are, in order,  $\frac{1}{2}, 1, 0, \frac{2}{3}, 1$ . Suppose W has been drawn, what is the chance that it was drawn from any particular bag? It is obvious that the chance of W having been drawn from any particular bag is proportional to the chance that, if that bag had been selected, W would have been drawn from it. Hence, if  $p_1, p_2, p_3, p_4, p_5$  be the chances that the several bags furnished the W actually drawn, we have

$$p_1 : p_2 : p_3 : p_4 : p_5 :: \frac{1}{2} : 1 : 0 : \frac{2}{3} : 1,$$

with the additional condition, that the ball must have been drawn from one of the bags, and therefore

$$p_1 + p_2 + p_3 + p_4 + p_5 = 1.$$

From these, by elementary algebra, we have

$$p_1 = \frac{3}{19}, p_2 = \frac{6}{19}, p_3 = 0, p_4 = \frac{4}{19}, p_5 = \frac{6}{19}$$

And a very simple application of algebra will easily conduct us to the general formula for any such case.

(I.) If the nature of a cause is known only by its results, we have an interesting case of simultaneous application of the direct and inverse methods.

Thus, a bag contains 3 balls, each of which may be either black or white. A ball has been drawn from it on two occasions—replacing before drawing—and on each of these occasions the ball was W. What is the chance that a third drawing will give a black ball?

The contents of the bag are obviously one of the following—viz., W,W,W; W,W,B; or W,B,B—since it contains one W at least. Now, if WWW be the contents, the probability of the observed event (two W in succession) is  $1 \times 1 = 1$ .

$$\text{If W,W,B, } \frac{2}{3} \times \frac{2}{3} = \frac{4}{9}$$

$$\text{If W,B,B, } \frac{1}{3} \times \frac{1}{3} = \frac{1}{9}$$

PROBABILITY.

Hence the probabilities that these are, respectively, the contents of the bag are as  $1 : \frac{4}{9} : \frac{1}{9}$ , or as  $9 : 4 : 1$ ; and are therefore  $\frac{9}{14}, \frac{4}{14}$ , and  $\frac{1}{14}$  respectively, since their sum must be 1 or certainty.

Now for the chance of B in the third drawing; if WWW be the contents (of which the chance is  $\frac{9}{14}$ ), the chance of B is 0. Hence we have one part of the chance for B, viz.  $\frac{9}{14} \times 0 = 0$ . Similarly, the other parts are  $\frac{4}{14} \times \frac{1}{3} = \frac{4}{42}$  and  $\frac{1}{14} \times \frac{2}{3} = \frac{2}{42}$ . The whole chance of B in the third drawing is therefore

$$0 + \frac{4}{42} + \frac{2}{42} = \frac{1}{7}$$

As exercises on the above principles, we will take first a few simple questions from Life Assurance, the subject to which, above all others, the elementary theory of Probability has been of the most indispensable service. We purposely choose the very simplest that the subject can furnish, but they are quite sufficient to shew the great value of the theory.

A Table of Mortality (q. v.) gives the numbers alive at each successive year of their age, out of a given number of children born. If  $A_n$  and  $A_{n+1}$  be the numbers in the table corresponding to the  $n^{\text{th}}$  and  $n + 1^{\text{th}}$  years of age; the inference from the table is, that, of  $A_n$  individuals now alive, and of  $n$  years of age,  $A_{n+1}$  will live one additional year at least. Hence the chance that any one of them die during the year is

$$\frac{A_n - A_{n+1}}{A_n}$$

Call this  $1 - p$ , then  $p$  is the chance that any one of them will survive the year.

Questions. Of two individuals, one  $n$  years old, and the other  $n_1$ , what are the chances that

- (a.) Only one lives a year?
- (b.) One, at least, lives a year?
- (c.) Both do not live a year?

Calling the individuals A and B, the chance of A living out the year is  $p$ , and the chance of his dying within the year is  $1 - p$ . For B these are  $p_1$  and  $1 - p_1$ . Hence

$$\left. \begin{aligned} \text{(a.) A lives and B dies—chance } & p(1 - p_1). \\ \text{B lives and A dies—chance } & (1 - p)p_1. \end{aligned} \right\}$$

Hence answer to (a) is  $p + p_1 - 2pp_1$ .

(b.) This includes, in addition to the conditions of (a), the chance that both survive, which is  $pp_1$ .

Hence answer to (b) is  $p + p_1 - pp_1$ .

(c.) In this case the chance that both do live a year is  $pp_1$ . Hence chance of (c) is  $1 - pp_1$ .

As another very instructive example, let us take the question,

'In how many throws of a die is it even betting that an ace will be thrown?'

This may, of course, be worked directly, proceeding in the following manner:

$$\text{Chance of ace in first throw} = \frac{1}{6}$$

Then, remembering that there is no second throw unless the first fails,

$$\text{Chance of ace in second throw} = \frac{5}{6} \cdot \frac{1}{6}; \text{ and so on.}$$

Hence the odds against ace in 1 throw are  $5 : 1$ .

" " " " 2 throws  $25 : 11$ ;  
and so on. But great care is requisite in this mode of working the problem.

The simplest procedure is this:

Chance against ace in 1 throw	$\frac{5}{6}$ .
" " " 2 throws	$\frac{25}{36}$ .
" " " 3 "	$\frac{125}{216}$ .
" " " 4 "	$\frac{625}{1296}$ .
Hence odds against ace in 1 throw	5 : 1.
" " " 2 throws	25 : 11.
" " " 3 "	125 : 91.
" " " 4 "	625 : 871.

That is, the odds are considerably against ace occurring in three throws, being about 11 to 8; while in four they are slightly in its favour, as 29 : 27 nearly. One is sure, therefore, of winning in the long run, if he can get any one to give him repeatedly an even bet against ace appearing in four throws of a die.

It is to be observed that when we say 'in the long run,' we mean that the most likely event may not be that which will happen in the first trial, nor perhaps for many trials (because, unless its probability is 1 or certainty, it is, of course, possible that it may never occur). But what is certain is this, that if a sufficient number of trials be made, we can have any amount of probability (short of certainty) that the ratio of the number of successful trials to the number of failures, will be in the ratio expressed by the odds in favour of success in any one trial.

And this introduces us to another department of the theory of Probabilities, what is called *Expectation*. We begin with a simple case, not involving what is called *Moral Expectation*, to which the next example will be devoted.

Suppose A, B, and C have made a pool, each subscribing £1; and that a game of pure chance (i.e., not dependent on skill) is to be played by them for the £3. What is (previous to play) the value of the expectation of each? By the conditions, all are equally likely to win the pool, hence its contingent value must be the same to each; and, obviously, the sum of these values must represent the whole amount in question. The worth of the expectation of each is therefore £1. That is, if A wishes to retire from the game before it is played out, the fair price which B or C ought to pay him for his share is simply £1. But this is obviously  $\frac{1}{3} \times £3$ ; i.e.,

the value of the pool multiplied by his chance of getting it. Here we have taken an extremely simple case, because we have not room for the general proof (though it is closely analogous to that just given) that

*The value of a contingent gain is the product of the sum to be gained into the chance of winning it.*

So far, it has been assumed that the payment of his stake (which may be wholly lost) has not morally affected the position of any of the players; i.e., that the stake is a sum whose loss would in no wise embarrass him. And it is only with such cases that the strict mathematical theory can deal; for we cannot estimate with mathematical accuracy the value of the stake as depending on the fortune (the *possessions*, not the *luck*) of the player. The attempts which have been made to supply this apparent deficiency in the theory have, of course, not been very generally accepted. Still there is no doubt that two men of very unequal fortunes are placed in very different circumstances when they have subscribed equal sums to a pool which they have equal chances of gaining. The most commonly

## PROBABILITY.

received method of *approximating* to a solution of such a question (for it is obvious that here we have left mathematical certainty behind) is that proposed by Daniel Bernoulli; which is, that the value of a small gain, or the inconvenience of a small loss, is directly proportional to the amount of the gain or loss (which is probably correct), and inversely proportional to the fortune of the person affected (which may be nearly true, except in very extreme cases). The application of this hypothetical principle necessitates, in general, the use of the integral calculus; but, to shew the *mathematical folly* of gambling, we quote one of Bernoulli's results.

A, whose whole fortune is £100, bets £50 even with B on an event of which the chance is  $\frac{1}{2}$ . What is the moral value of A's fortune after making the bet (and before it is decided)? By applying the above method, he finds it to be £87. Thus A, by making the bet, has depreciated by 13 per cent. the value of his property. This is an extreme case, of course; and the method employed in obtaining the result is questionable; still, it is certain that no legitimate method could shew that A had otherwise than impaired his fortune by entering upon any such transaction. This, of course, is on the supposition that the bet is a *fair* one; if A be a swindler, and get from B more than the proper odds against the event, he may, of course, improve to any extent the value of his fortune. But such would be a question of flats and sharpers, not a question of probability.

A very excellent example of *moral* as distinguished from *mathematical* probability is furnished by the famous 'St Petersburg Problem.'

A and B play at heads and tails. A is to pay B £2 if H comes at the first throw, £4 if at the second and not before, £8 if at the third and not before; and so on, doubling each time. What should B pay (before the game) for his expectation?

Applying the mathematical method, we see that

$$\text{Chance of H at first throw} = \frac{1}{2};$$

in which case B gets £2, of which the contingent value is  $\frac{1}{2} \times £2 = £1$ .

$$\text{Chance of H at second throw, and not before} = \frac{1}{4};$$

when B is to get £4, whose value is therefore  $\frac{1}{4} \times £4 = £1$ .

$$\text{Chance of H at third throw, and not before} = \frac{1}{8};$$

contingent value of B's £8 is therefore  $\frac{1}{8} \times £8 = £1$ .

And so on, for ever.

Hence B's expectation (mathematical) is £1 + £1 + £1 + &c. for ever, or an infinite sum. Now it is obvious that no man, in his senses, would pay even a moderately large sum for such a chance. Here the *moral* expectation comes into play; but the mathematical solution is perfectly correct, if we interpret it properly. *It does not attempt to tell what will be the actual result in any one game—this is pure chance*—but it tells us what will be the average to which the results of larger and larger numbers of games must continually tend. In other words, if B had an inexhaustible purse, he might safely pay any amount to A before each game, and be sure of winning in the long run, after an indefinitely great number of games were played. But this, though theoretically exact, is not applicable to mundane gambling—where limited purses and limited time

circumscribe the field requisite for the proper development of the mathematical result.

Before quitting this part of the subject, we may give a couple of instances in which the mathematical theory may be easily tested by any one who has a little leisure. One of these we will develop at length, as a final instance of the simple calculations generally involved.

'To find the chance of throwing any given possible number with two dice.'

As the faces of the dice are numbered from 1 to 6—the smallest throw is 2, and the greatest 12.

In one throw, the chances are—

$$\text{For } 2 = 1 + 1; \frac{1}{6} \cdot \frac{1}{6} = \frac{1}{36};$$

the probabilities being *multiplied* (E) because the events are independent. For

$$3 = 1 + 2, \text{ or } 2 + 1; \frac{2}{36};$$

$$4 = 1 + 3, 2 + 2, \text{ or } 3 + 1; \frac{3}{36};$$

$$5 = 1 + 4, 2 + 3, 3 + 2, \text{ or } 4 + 1; \frac{4}{36};$$

$$6 = 1 + 5, 2 + 4, 3 + 3, 4 + 2, \text{ or } 5 + 1; \frac{5}{36};$$

$$7 = 1 + 6, 2 + 5, 3 + 4, 4 + 3, 5 + 2, \text{ or } 6 + 1; \frac{6}{36};$$

Then, in the inverse order—

$$8 = 2 + 6, 3 + 5, 4 + 4, 5 + 3, \text{ or } 6 + 2; \frac{5}{36};$$

and so on—the fact being that if we read the *lower* sides of the dice when the throw is 8, they will give 6, and so on—the sum being always 14.

The mathematical expectation for any one throw is therefore

$$\begin{aligned} & \frac{1}{36} \cdot 2 + \frac{2}{36} \cdot 3 + \frac{3}{36} \cdot 4 + \frac{4}{36} \cdot 5 + \frac{5}{36} \cdot 6 + \frac{6}{36} \cdot 7 \\ & + \frac{5}{36} \cdot 8 + \frac{4}{36} \cdot 9 + \frac{3}{36} \cdot 10 + \frac{2}{36} \cdot 11 + \frac{1}{36} \cdot 12 \end{aligned}$$

In all—

$$\frac{1}{36}(2 + 6 + 12 + 20 + 30 + 42 + 40 + 36 + 30 + 22 + 12);$$

$$\text{or } \frac{1}{36} \cdot 252 = 7.$$

The meaning of this is, *not* that we shall probably throw seven the first time, nor second, nor perhaps for many throws; but that if we throw a number of times, add the results, and divide by the number of throws, the final result will be more and more nearly equal to seven, the greater be the whole number of throws. It is very instructive to make the experiment, say on 100 throws of two dice, as in backgammon. If the mathematical result be not closely verified by such a trial, *the dice are loaded*; or, at least, are ill-made.

Another illustration, and a very excellent one, is furnished by the following theorem.

If the floor be ruled with equidistant parallel lines, and a straight rod, whose length is equal to the distance between any two contiguous lines, be dropped upon it at random, the chance of its falling on one of the lines is  $\frac{2}{\pi}$ , where  $\pi$  is the ratio of the circumference of a circle to its diameter (see QUADRATURE OF THE CIRCLE). The deduction of this result from the theory of Probabilities requires the use of the integral calculus, and cannot be given here; but we may put the above theorem to the test of practice in the following way. Let the rod

PROBABILITY.

be tossed a number of times, then the greater this number, the more nearly shall we have

$$\frac{\text{Twice number of throws}}{\text{Number of times the rod falls on a line}} = \pi$$

= 3.14159, &c.;

and therefore, by simply continuing this process long enough, we may obtain as accurate a value as we choose of the ratio of the circumference to the diameter of a circle.

To shew how the theory of Probabilities would tend, if generally known, to the discouragement of gambling, would require a treatise—as every species of game would have to be treated—we shall therefore only take one case, about as bad a one as can be. This is when a man makes a 'book' on a horse-race, so as to 'stand to win,' whatever be the result of the race. This is, of course, immoral; for, as it can make no matter who accepts his bets, suppose them all taken by one individual. The latter must therefore have been 'done' into a complex transaction by which he is *certain to lose*. The method of making such a 'book' is simple enough; it consists mainly in betting *against* each horse. Thus, if three horses, A, B, C, are to start, and he can get the following bets taken—

£4 : £3 against A,  
 £5 : £4 " B,  
 £6 : £5 " C;

his book stands thus :

If A win, he wins £4 + £5 - £4 or £5.  
 " B " " £5 + £3 - £5 = £3.  
 " C " " £4 + £3 - £6 = £1.

Now, to examine this case, suppose the *correct* odds to have been laid against A and B, what ought in fairness to be the odds as regards C?

Chance of A winning is . . .  $\frac{3}{7}$   
 " B " " " . . .  $\frac{4}{9}$   
 Chance of A or B winning =  $\frac{3}{7} + \frac{4}{9} = \frac{55}{63}$

Hence, chance of C winning =  $\frac{8}{63}$ ; and therefore the legitimate odds against C are 55 to 8, whereas our betting-man has got a *fool* to accept 6 to 5.

The true cause of the detestation which attaches to gambling, is not so much the ruin, insanity, suicide, &c., in which it not unfrequently ends, as the fact, that a gambler's work in no case increases the wealth or comfort of the state; all it can effect is a more or less rapid and dishonest transfer of these from one state of distribution to another. It is as useless, so far as regards production, as the prison-crank.

There is a common prejudice as to '*runs of luck*,' which are popularly supposed *not* to be compatible with the mathematical theory. This, also, is a complete delusion. To take a very simple case, the reader will easily see that, if he writes down all the possible cases which may occur in six tosses of a coin, the odds are 19 : 13 in favour of a run of three at least.

To give an instance of the principle of interpretation which we have several times above applied to the mathematical result—viz., that the greater the number of trials, the more nearly will the average result of these trials coincide with it—let us recur to heads and tails. Suppose a coin tossed ten times, and let H<sup>n</sup> stand for H n times, then we have

$$1 = \left(\frac{1}{2} + \frac{1}{2}\right)^{10}$$

$$= \frac{1}{2^{10}} \left(1 + 10 + \frac{10 \cdot 9}{1 \cdot 2} + \frac{10 \cdot 9 \cdot 8}{1 \cdot 2 \cdot 3} + \dots\right)$$

of which the terms are [as in (D)] the probabilities of H<sup>10</sup>, H<sup>9</sup>T, H<sup>8</sup>T<sup>2</sup>, &c. respectively; the order not being taken account of. The largest term is the 6th, and its value is  $\frac{252}{2^{10}} = \frac{252}{1024}$ , or about  $\frac{1}{4}$ . This is the chance of H<sup>6</sup>T<sup>4</sup>, without regard to order, in ten throws. Although the most probable result, inasmuch as the chances of H<sup>6</sup>T<sup>4</sup> and H<sup>4</sup>T<sup>6</sup> are each about  $\frac{1}{5}$  only, and those of the other possible combinations much smaller—yet it has not a very large chance. But the chance of a result *not deviating much from the most probable one*, is very much larger: in the above case, the chance of having not less than 3H, and not less than 3T, is as much as  $\frac{912}{1024}$ . But this tendency of the bulk of the results to coincide very closely with the most probable one, is much more evident as we take a greater and greater number of trials. Thus, in 100 trials with the coin, we have—

$$1 = \left(\frac{1}{2} + \frac{1}{2}\right)^{100}$$

$$= \frac{1}{2^{100}} \left(1 + 100 + \dots + \frac{100 \cdot 99 \cdot 98 \dots 51}{1 \cdot 2 \cdot 3 \dots 50} + \dots\right)$$

[Now we begin to see how the higher analysis comes in. Who is to work out by common arithmetic the value of the fraction  $\frac{100 \cdot 99 \cdot 98 \dots 51}{1 \cdot 2 \cdot 3 \dots 50}$ ? Some calculating boy *might*, with no very enormous labour—but, wait a moment, we may wish to have the result of a million of trials, and what calculator (arithmetical) will tell us the value of

$$\frac{1,000,000 \times 999,999 \times \dots \times 500,001}{1 \times 2 \times \dots \times 500,000} ?$$

In this case, the most probable result is H<sup>50</sup>T<sup>50</sup>, without regard to order, but its chance is only about  $\frac{2}{25}$

[The exact value is  $\frac{1}{2^{100}} \cdot \frac{100 \cdot 99 \cdot 98 \dots 51}{1 \cdot 2 \cdot 3 \dots 50}$

Had there been 1000 throws, the chance of H<sup>500</sup>T<sup>500</sup> (the most likely combination) would have been about  $\frac{1}{38}$ . But, as the number of throws increases,

the number of terms grouped close to the largest in the expansion, and whose sum far exceeds that of all the rest, becomes a smaller and smaller fraction of the entire number of terms. Hence the chance that in 1000 tosses there should not be more than 600 nor less than 400 H, is much greater than that of not more than 60 nor less than 40 H in 100 throws; and so on.

Thus it is that all our statistical results, say the ratios of the numbers of births, marriages, suicides, &c. to the whole population—or that of the male to the female births—or that of the dead letters to the whole number posted, &c.—though perhaps never the same in any two years, yet fluctuate between very narrow limits. And thus it is that the theory of Probabilities has been the means of solidly establishing, beyond almost the possibility of failure, when properly applied, the inestimable securities afforded by life-assurance.

Another very important application of the theory is to the deduction of the *most probable* value from a number of observations (astronomical, meteorological,

PROBATE COURT—PROCESSION OF THE HOLY GHOST.

&c.), each of which is liable to error. We may confidently assert that, but for this, astronomy could not have taken the gigantic strides by which it has advanced during the present century. But the '*Method of Least Squares*,' as it is called, which is furnished for this purpose by the theory of probabilities, is far beyond the scope of elementary mathematics, and can therefore only be referred to here. Its fundamental features may be seen in the above process of determining the probability that the result of a number of trials shall lie within certain limits on each side of the most probable result.

The theory of Probabilities has been applied to many other important questions, of which we may mention only two—the value of evidence, and the probability of the correctness of the verdict given by various majorities in a jury. But for these, and for the further development of what we have given above from the simplest points of view, we must refer to the various treatises on the subject. Of these, the most accessible to an English reader are the very valuable works of Galloway and De Morgan. Poisson, Gauss, and especially Laplace, have also treated the subject in the most profound manner. But the difficulty of understanding Laplace's great work is such, that few have ever mastered it completely; and it is therefore particularly satisfactory that the late Professor Boole, in his *Laws of Thought*, has shewn how to dispense with a great part of the analysis which renders Laplace's work so formidable.

**PROBATE COURT** is a court created in England in 1858, in lieu of the old Prerogative Courts, to exercise the exclusive jurisdiction in all matters touching the succession to personal estate. The rules on which its jurisdiction is founded are, that whenever a man dies he must either leave a will or not. If he leave a will, then it must be produced and verified, so as to demonstrate to all parties interested that it is an authentic will, and has been duly executed and signed in presence of witnesses, and therefore that the right to the personal estate is vested in the executors named by the will. The will is sworn to by the witnesses, on being produced; and if the evidence is satisfactory, it is registered, and the original deposited in the court, when copies are made. This process is called proving the will, and the act of court is called the probate of the will. If there is no will, then the rule being, that the personal estate devolves on the next of kin and widow, if any, it is necessary that an application be made to the court to appoint one of the next of kin to be the administrator, and take charge of the payment of debts. This is called taking out administration, and the act of the court appointing the administrators is called letters of administration. Numerous difficulties often arise as to irregularities in the making of wills and as to the party entitled to administration, and it is the function of the Court of Probate to dispose of these.

**PROBOSCIDEA**, a section of *Pachydermata*, of which the characters are given under that head, contains one recent and one fossil genus, *Elephas* (see ELEPHANT) and *Mastodon* (q. v.); so that the P. seem not to have been numerous at any period of the world's history. Notwithstanding the great size of these creatures, comparative anatomists have pointed out various resemblances in their dentition, osteology, &c., to rodents.

**PROBOSCIS MONKEY.** See NASALUS.

**PROBUS, MARCUS AURELIUS**, Emperor of Rome, was born at Sirmium, in Pannonia. His father, Maximus, served first as a centurion, and afterwards as a tribune in the Roman army, and died in

Egypt, leaving to his only son a good name and a moderate income. P. early entered the army, and had the good fortune to attract the favourable notice of the Emperor Valerian, who elevated him before the legal period to the rank of tribune. His subsequent conduct justified his rapid promotion, for he greatly distinguished himself against the Sarmatians on the Danube, and subsequently in Africa, Egypt, Asia, Germany, and Gaul, winning golden opinions from Valerian's successors, Gallienus, Claudius II., Aurelian, and Tacitus. By the last-named emperor, he was appointed governor of the whole Asiatic possessions of Rome, and declared to be the chief mainstay of the Roman power; and such was the zealous attachment evinced for him by his soldiers, whose respect and love he had equally won by his firm discipline, by his care in providing for their wants and comforts, and his liberality in the distribution of plunder, that, on the death of Tacitus, they forced him to assume the purple; and his rival, Florianus, having been removed, P. was enthusiastically hailed emperor by all classes (276 A. D.). His brief reign was signalised by brilliant and important successes; the Germans, who, since Aurelian's time, had made Gaul almost a part of Germany, were driven out with enormous slaughter, pursued into the heart of their own country, compelled to restore their plunder, and to furnish a contingent to the Roman armies. Pursuing his victorious career, P. swept the inimical barbarians from the Rhetian, Pannonian, and Thracian frontiers, and forced Persia to agree to a humiliating peace. Various aspirants to the imperial purple were also put down. On his return to Rome, P. celebrated these fortunate achievements by a triumph, and then, the external security of the empire being established, devoted himself to the development of its internal resources. The senate was confirmed in its privileges; liberal encouragement was given to agriculture; numerous colonies of barbarians were established in thinly-peopled spots, that they might adopt a civilised mode of life; and all branches of industry were protected and promoted. But P. was at a loss what to do with his army, as the Romans had now no enemies either at home or abroad; and fearing that their discipline would be deteriorated by a life of inactivity, he employed the soldiers as labourers in executing various extensive and important works of public utility. Such occupations, considered as degrading by the soldiers, excited among them the utmost irritation and discontent; and a large body of troops, who were engaged in draining the swamps about Sirmium, giving way to these feelings, under the excitement produced by the presence of the emperor, murdered him, 282 A. D. P. possessed great military genius, combined with equal administrative talent, and added to these a wisdom, justice, and amiability equal to that of Trajan or the Antonines.

**PROCESS** is the system of action by which a court calls parties into court for purposes of litigation. There are numerous rules governing the steps of process, but these are all of a technical nature.

**PROCESSION OF THE HOLY GHOST**, that doctrine regarding the Third Person of the Blessed Trinity which teaches that as the Son proceeds (or is born) from the Father, so the Holy Ghost proceeds (or emanates) from the Father and from the Son, but as from one principle. The question of the origin of the Holy Ghost was not distinctly raised in the early controversies, which fell chiefly upon the Second Person. In the Creed of Nicæa, no allusion whatever is made to the subject; and in the Creed of Constantinople, the Holy Ghost is said simply to 'proceed from the Father.' Nevertheless, this was



understood in the Latin Church to mean that, as the Son proceeds from the Father, the Holy Ghost proceeds from both Father and Son; and in the course of the 7th and 8th centuries, the words 'and from the Son,' for greater distinctness, came to be added to the creed in several churches—as the West. In the controversy with the Latins, Photius (q. v.) took exception to this addition, as unauthorised, and made the addition one of the grounds for his charge of heresy against them, which was resumed on the consummation of the schism under Michael Cerularius. In the union of the Greek and Latin churches at Florence (1437), an article of agreement on this head was adopted, and the words *Filioque* were sung twice over both in Latin and in Greek, in the solemn mass which celebrated the union. But this union had no root in the popular mind, and the dispute still continues as of old to divide the churches.

**PROCESSIONAL** (Lat. *processionale*), the service-book which contains the prayers, hymns, and general ceremonial of the different processions. Many ancient books of this class have been preserved. The processional approved for common use is that of Rome, of which many editions have been published.

**PROCESSIONS**, as solemn and religious rites, are of very great antiquity. With the Greeks and Romans, they took place chiefly on the festivals of Diana, Bacchus, Ceres, and other deities; also before the beginning of the games in the Circus; and in spring, when the fields were sprinkled with holy water to increase their fertility. The priests used to head them, carrying images of the gods and goddesses to be propitiated, and either started from certain temples or from the Capitol. Among the Jews, certain processions around the altar were (and still are to a certain extent) usual on the Feast of Tabernacles; and from them the Mohammedans have adopted their mode of encompassing the sanctuary seven times at Mecca (q. v.). Processions form a prominent part of the Buddhist worship. The practice was early adopted in the Christian Church. The Reformation abolished it; and even in the Roman Catholic Church, especially in mixed countries, processions are less frequent or popular now than in former years. They are there either supplicatory processions or cross processions, and are either directed to a certain distant place, to some miraculous image or object, or they are confined to the streets of the cities and the churches. Banners, crosses, and images are generally carried in front; the clergy follow; and the people make up the rear, singing hymns or reciting prayers. In some Protestant states, they are still permitted, under certain restrictions. There is no doubt that, whatever their general intrinsic value, they offer in many instances one of the most strikingly picturesque features of the Roman faith; and that they answer a certain instinctive want in the multitude. For extensive pilgrimages, as such, their history and rites, we refer to **PILGRIM**, **MECCA**, **FESTIVALS**, &c.

**PROCHEIN AMI**, the old Norman-French for next friend, still often used in English law, means the person in whose name an infant sues in a court of law, or a married woman in a court of equity. The chief object is to have a person responsible for costs. See **NEXT FRIEND**.

**PRO'CIDA**, an islet of Italy, between the island of Ichia and the shores of Naples, and separated from both of these by sea-ways about a mile in width, is three miles long and one mile broad. Pop. 13,810. On its shores is the city of the same name, with a commodious harbour, a fine regal palace, and

a horrible state-prison, recently rendered famous by Carlo Poerio, who was confined there in chains.

**PROCLAMATION**, a public notice given by the sovereign to his subjects. The power of issuing proclamations is part of the prerogative of royalty as the fountain of justice. They sometimes consist of an authoritative announcement of some matter of state, or act of the executive government affecting the duties and obligations of subjects. The demise of the crown, and accession of a new sovereign, a declaration of war, and the issue of new coin, are all occasions on which a royal proclamation is issued. A proclamation may also be issued to declare the intention of the crown to exercise some prerogative or enforce some law which has for a long time been dormant or suspended. In time of war, the crown by a proclamation may lay an embargo on shipping, and order the ports to be shut. But the most usual class of proclamations are admonitory notices for the prevention of offences, consisting of formal declarations of existing laws and penalties, and of the intention to enforce them; such as the proclamation against vice and immorality, appointed to be read at the opening of all courts of Quarter Sessions in England.

Proclamations are only binding when they do not contradict existing laws, or tend to establish new ones, but only enforce the execution of those which are already in being, in such manner as the sovereign judges necessary. A proclamation must be under the Great Seal. Statute 31 Henry VIII. c. 8 declared that the king's proclamations should be as binding as acts of parliament; an enactment which, while it subsisted, made an entire revolution in the government; but was repealed by 1 Edw. VI. c. 12. In later times, it was attempted to be maintained by the crown lawyers that the king might suspend or dispense with an existing law by proclamation; a power, however, which act 1 Will. and Mary c. 2 declared not to exist.

**PRO'CLUS**, called the Successor (*Diadochos*)—i. e., of Syrianus, as the head of the Athenian school—a celebrated Neo-Platonist, was born in Constantinople in 412. He was of Lycian origin, and received his first instruction at Xanthus, in Lycia. He then studied at Alexandria under Arión, Leonaras, Hero, and especially under Heliodorus, with whom he applied himself chiefly to Aristotelian and Platonic philosophy. From thence he went to Athens, where a certain Plutarch, a philosopher, and his daughter, Asclepiogenia, became his instructors—the latter a priestess of Eleusis, chiefly in theurgic mysteries. The vivid imagination and enthusiastic temperament which in his childhood already had led him to believe in apparitions of Minerva and Apollo, naturally convinced him, when all the influences of the Mysteries (q. v.) were brought to bear upon him, still more of his immediate and direct intercommunication with the gods; and he distinctly believed himself to be one of the few chosen links of the Hermaic chain through which divine revelation reaches mankind. His soul had, he thought, once lived in Nicomachus the Pythagorean, and, like him, he had the power to command the elements to a certain extent, to produce rain, to temper the sun's heat, &c. The Orphic Poems (q. v.), the writings of Hermes, and all that strangely mystical literature with which the age abounded, were to him the only source of true philosophy, and he considered them all more or less in the light of divine revelations. That same cosmopolitan spirit in religious matters which pervaded Rome towards her end, had spread throughout all the civilised 'pagan' world of those

days, and P. distinctly laid it down as an axiom, that a true philosopher must also be a hierophant of the whole world. Acquainted with all the creeds and rites of the ancient Pantheons of the different nations, he not only philosophised upon them in an allegorising and symbolising spirit, as many of his contemporaries did, but practised all the ceremonies, however hard and painful. More especially was the practice of fasting in honour of Egyptian deities, while on the one hand, it fitted him more and more for his hallucinations and dreams of divine intercourse, on the other hand more than once endangered his life. Of an impulsive piety, and eager to win disciples from Christianity itself, he made himself obnoxious to the Christian authorities at Athens, who, in accordance with the spirit of religious intolerance and fanaticism which then began to animate the new and successful religion against which P. waged constant war, banished him from this city. Allowed to return, he acted with somewhat more prudence and circumspection, and only allowed his most approved disciples to take part in the nightly assemblies in which he propounded his doctrines. He died in 485, in his full vigour, and in the entire possession of all his mental powers, for which he was no less remarkable than for his personal beauty and strength.

Respecting his system, some modern philosophers have exalted it to an extent which his own works would hardly seem to warrant. Victor Cousin holds that he has concentrated in it all the philosophical rays which emanated from the heads of the greatest thinkers of Greece, such as Pythagoras, Plato, Aristotle, &c. P. recognises a certain kind of unity of the Creator, or rather of the divine mind, of which he took the human to be a fragment; and he speaks of the 'One' and 'The First.' The human soul he considered wrapped up in various more or less dense veils, according to the degree of perfection attained; and he further assumed a certain sort of solidarity between the souls of those who naturally, or by certain immutable circumstances, were linked together, such as children and parents, rulers and subjects; and he carried this doctrine so far as to assert, that the children must naturally participate in their parents' faults. Faith alone, he further held, was essential to the attainment of Theurgy, which, comprising mantic and supernatural inspiration, is preferable to all human wisdom; and in this he chiefly differs from Plotinus (q. v.), with whose system he agrees in most other respects. He further tries to recognise and to fathom the original mysterious One by combination of figures, strongly reminding us of Gnosticism and the later Kabbala. His way of developing the finite beings out of the infinite Unit is also peculiar. A whole series of triads, at the head of each of which again stands a unit, goes in various gradations through the creation, the lower powers emanating from the higher, which are the thinking and creative ideas, &c. See PLOTINUS, GNOSTICS.

Of his manifold works, there have survived several hymns, which, by the true poetical and religious spirit which pervades them, stand out most favourably among the generally inane Orphic hymns. Of his astronomical and mathematical writings, there have survived a short summary of the chief theories of Hipparchus, Aristarchus, Claudius Ptolemæus, and others, a work *On the Heavenly Spheres*, a Commentary on Euclid, and a work—only known in a Latin translation—*On the Effects of the Eclipses of the Sun and Moon*. His grammatical works consist of some commentaries on Homer, Hesiod, &c. The greater part of his writings is devoted to philosophy. These are partly commentaries and paraphrases of Platonic dialogues, and partly the embodiments

of his own ideas in a systematic form. We thus have a work—again preserved in Latin only—*On Providence and Fate, On the Ten Doubts about Providence, &c., On Platonic Theology*, and other minor works, extant in a more or less fragmentary form, and repeatedly edited, with translations and modern commentaries. The most important of his works, however, is the *Philosophical and Theological Institution*, in which P. geometrically, as it were, evolves his doctrines by heading each of its 211 chapters by a kind of proposition, which he proceeds to demonstrate, appending corollaries in some instances. He chiefly treats in it of unity and multiplicity, on productive causes and effects, on the highest good, on that which suffices in itself, on immobility, perfection, eternity, divinity, and intelligence; on the soul, &c. Next in importance stand his commentaries on Plato's *Timæus*, which, however, now only embraces a third of this dialogue, a similar commentary on Plato's *Parmenides*, in seven books, on *Cratylus*, the *First Alcibiades*, and fragments on other Platonic writings. Some other works attributed to P. have by modern investigators been pronounced to be spurious.

PROCONSUL, a Roman magistrate not holding the consulship, who was invested with powers nearly approaching those of a consul, not, however, extending over the city and its vicinity. The proconsul was, at first, one who had held the office of consul, whose *imperium* was prolonged to enable him to bring an unfinished campaign to a close. The duration of the office was a year. During the latter period of the republic, when the consuls were expected to spend the year of their consulate at Rome, they were generally appointed at its close to undertake, as proconsuls, either the conduct of a war in some province, or its peaceful administration. Occasionally, the office of proconsul, with the government of a province, was conferred on a person who had never held the consulship. Under Constantine, parts of certain dioceses came to be governed by proconsuls.

PROCOP, ANDREW, the Hussite leader, known as P. the Elder, or the Holy, or the Shaven, in allusion to his having received the tonsure in early life, was born towards the close of the 14th c., and belonged to a noble family of Prague. After having travelled with an uncle for some years through France and Spain, he returned to Bohemia at the outbreak of the religious wars, in which Ziska (q. v.) took so prominent a part, and at once entered the ranks of the insurgent Hussites. His military genius soon raised him to the rank of an influential commander; and on the death of Ziska in 1424, P. was elected by the Taborites, who formed an important section of the Hussites, as their leader, and from this period till 1427, his history presents an almost unbroken series of daring attacks upon the Austrians. In the meantime, another body of Taborites, who called themselves Orphans, had overrun Lausitz, and burned Lauban, under the leadership of a man, subsequently known as Procop the Lesser, or Younger, who now, in concert with the more distinguished P., attacked Silesia, and took part in those internal feuds of the Hussite factions by which Bohemia was almost wholly ruined. The threatened approach of three German armies, which had been levied by the neighbouring states to carry on an exterminating crusade against the heretics, was alone able to restore unanimity to the divided Hussites, who, under the leadership of the two Procop, offered a desperate and successful resistance to the larger numbers of the Germans, subsequently pursuing their enemies with fire and sword through Silesia, Moravia, and

Hungary, as far as Presburg. In 1429, P. made inroads into the German states as far as Magdeburg, and returned to Bohemia laden with spoil, and followed by a numerous band of captive nobles and knights; and in the following year, at the head of 50,000 men-at-arms, and half as many horsemen, he again broke into Misnia, Franconia, and Bavaria, and after having burned 100 castles and towns, and destroyed 1400 villages and hamlets, and carried off a vast amount of treasure, turned his arms against Moravia and Silesia. The Emperor Sigismund at this crisis offered to treat with him, but the imperial demand, that the Hussites should submit to the decision of a council, afforded P. a pretext for breaking off all negotiations with the imperial court. A second German crusading army now advanced in 1431, but was thoroughly defeated at Riesenburg. These successes, which were followed by others of nearly equal importance in Silesia, Hungary, and Saxony, where the princes had to purchase peace at the hands of the two Procoops, on humiliating terms, induced the council of Basel to propose a meeting between the Hussite leaders and ten learned Catholic doctors. The meeting lasted fifty days, but was productive of no good result, and P. returned to Bohemia, where, combining his forces with those of Procop the Lesser, he laid siege to Pilsen. The council, on this, passed an act, known as the Basel Compact, by which the Hussites were allowed the use of the cup in the Lord's Supper, and the Bohemians were designated by the title of the 'First Sons of the Catholic Church.' The Taborites and Orphans, under the leadership of the two Procoops, refused, however, to have anything to do with the pope, and hence dissensions arose between them and the more moderate of the Hussites. After many lesser encounters between these factions, a decisive battle was fought near Lipau in 1434, in which P. was induced, by a feint of the enemy, to leave his intrenchments. His followers at first fought desperately against the troops of the Bohemian nobles, who were commanded by Meinhard of Neuhaus; but at length, under the influence of a sudden panic, they gave way, and took to flight. P., after vainly striving to re-form their broken lines, threw himself into the midst of the enemy, and was killed. Procop the Lesser, following in his steps, was also slain, and with these two brave Hussite leaders the cause of the Taborites perished.

PROCOPIUS, an eminent Byzantine historian, was born at Cæsarea, in Palestine, about the beginning of the 6th c., went to Constantinople when still a young man, and acquired there so high a reputation as a professor of rhetoric, that Belisarius, in 527, appointed him his private secretary. P. accompanied the great warrior in all his important campaigns in Asia, Africa, and Italy, and appears to have displayed remarkable practical as well as literary talent, for we find him placed at the head both of the commissariat department and of the Byzantine navy. He returned to Constantinople shortly before 542, was highly honoured by Justinian, and appointed prefect of the metropolis in 562. His death occurred, it is thought, about three years later. P.'s principal works are his *Historia*, in 8 books (two on the Persian war, from 408 to 553; two on the war with the Vandals, from 395 to 545; four on the Gothic war, going down to 553); *Ktismata*, or six books on the buildings executed or restored by Justinian; and *Anekdota*, or *Historia Arcana* (of doubtful genuineness), a sort of *chronique scandaleuse* of the court of Justinian, in which the emperor, his wife Theodora, Belisarius, his wife Antonina, and other distinguished persons, are depicted in the darkest colours. The most valuable

of these productions is undoubtedly the first, in which P. writes with the clearness, weight, and fulness of knowledge that might be expected of a man who had been an eye-witness of much of what he narrates, and who had occupied a position that fitted him to thoroughly understand what he had seen. He is the principal authority for the reign of Justinian. His style is pure, vigorous, and flexible. The best edition of his complete works is that by Dindorf (3 vols., Bonn, 1833—1838).

PROCRUSTES (Gr. 'the Stretcher'), the surname of a celebrated robber of Attica, named Damastes, or Polypemon. According to the ancient legend, he was wont to place all persons who fell into his hands upon a bed which was made either too long or too short for them, and where he racked their limbs till they died. This he continued to do until Theseus overpowered him, and made him suffer the tortures he had inflicted on others. The story has given rise to a figurative expression. When an author is subjected by a critic to a cruel or unfair mode of criticism, he is said to be stretched on 'the bed of Procrustes.'

PROCTER, BRYAN WALTER, an English poet, better known as BARRY CORNWALL, was born in 1787, and educated at Harrow. He studied law, was called to the bar in 1831, and for many years was one of the Commissioners of Lunacy, but resigned in 1860, and was succeeded by his friend Mr Forster, the historical essayist. His *Dramatic Scenes and other Poems* were published in 1819, and since that period he has produced several volumes both of verse and prose, the most important being *Mirandola, a Tragedy*. As a poet, P. belongs to the school of Keats and Hunt, and through all his works the influence of the old English dramatists may be traced like a vein through an agate. *Mirandola* was produced at Covent Garden Theatre, where it had considerable success. It is not, however, on his *Dramatic Scenes* or his tragedies, but on his songs, that P.'s reputation rests. He may fairly be considered the best of our modern English song-writers. The best collection of his songs is that published in 1851.

PROCTOR (formed by contraction from *lat. procurator*, one who cares for another) is the name given to the practitioners in Courts of Admiralty, and in the Ecclesiastical and Prerogative Courts. It corresponds to attorney or solicitor in the other courts. By a recent statute, which abolished the exclusive jurisdiction of the Admiralty and Prerogative Courts, now the Probate Court, all proctors were put on the same footing as attorneys and solicitors, and the power to practise in the new courts indifferently was given to each; and at the same time compensation was given for the loss of their monopoly. The mode by which one becomes a proctor is therefore the same as that by which one becomes an Attorney or Solicitor (q. v.).

PROCTORS, officers in the universities of Oxford and Cambridge (two in number in each), whose duties are to preserve the peace of the university, to repress disorders among the students, and inflict summary academical punishment. They have the command of the academical constabulary force, and have also an extensive police jurisdiction in the town. The proctors must be Masters of Arts, and are chosen by the colleges according to a certain rotation. They nominate two pro-proctors to be their deputies and assistants. The summary authority of the proctors extends both to undergraduates and Bachelors of Arts. They have also a legislative authority as assistants to the heads of houses, and vote in the election of some of the professors and other officers.

**PROCURATOR-FISCAL**, a legal practitioner in Scotland of some consequence, owing to his being the public prosecutor for a local district. He is generally a local procurator, or law-agent, and is appointed by the sheriff of the county, or in cities and towns by the magistrates. His business is to take the initiative in the prosecution of crimes. There being no coroner's inquisition in Scotland, he does the work which that functionary does in England. Whenever he has reason to believe a crime has been committed, his duty is to apply for a warrant to arrest the alleged criminal, or to summon him before the sheriff, when the witnesses are cited, and are precognosed—that is, they give what evidence they are in possession of. All the inquests and examinations of the procurator-fiscal are conducted privately; neither the press nor the public being allowed to be present. This arrangement, as tending to huddle up that which should be fully known—as, for example, the cause of catastrophes attended with loss of life—has latterly been the subject of earnest remonstrance. If the procurator-fiscal is informed of a crime which he thinks was either not committed, or of which there is no evidence satisfactory, he gives his concurrence merely to the private party who suggests it, but does not himself initiate the proceeding. When the procurator-fiscal takes the precognitions of the witnesses, he sends a copy of them to the crown counsel, of whom the Lord Advocate is the chief; and if these counsel think the evidence is strong enough, and warrants more than suspicion, the prosecution is proceeded with to trial. The procurators-fiscal are now paid by salaries according to the population of the district.

**PRODIGY**. See **OMEN**.

**PRODUCTION OF DOCUMENTS** is often required in legal proceedings, or in the course of a suit, in Scotland, as well as in other countries; but it depends on the nature of the suit when and under what conditions the documents must be produced. As a general rule, whenever a right is founded on a document, that document must be produced or shewn to the court which has to determine the nature of the right.

**PRODUCTIVE, and UNPRODUCTIVE, LABOUR**. See **LABOUR**.

**PROFESSOR**, an officer in a university whose duty it is to instruct students, or read lectures on particular branches of learning. In the early times of universities, the degrees conferred on students were licenses to act as public teachers; and the terms Master, Doctor, and Professor were nearly identical in signification. As, however, the body of graduates ceased in the course of time to have any concern in public teaching, a separate class of recognised teachers sprang up, paid sometimes with salaries, in other instances by fees. These were called professors; and in the German and Scottish universities became the governing body, and sole recognised functionaries for the purpose of education. In the universities in which collegiate foundations prevailed, as Oxford and Cambridge, they became, on the other hand, only secondaries or auxiliaries, attendance on their lectures not being generally deemed indispensable, and the necessary business of instruction being carried on by the functionaries of the several colleges.

The word professor is occasionally used in a loose way to denote generally the teacher of any science or branch of learning, without any reference to a university. It has been assumed as a designation not only by instructors in music and dancing, but by conjurers.

**PROFILE**, the outline of a section through a cornice or other series of mouldings.—The outline of a capital when drawn geometrically; the outline of the human face in a section through the median line; &c.

**PROGNOSIS** (from the corresponding Greek word) is the term employed in medicine to indicate the opinion or decision of the physician regarding the probable course and issue of a disease. The physician is guided in arriving at his decision by his knowledge of the course which the disease usually follows; and as some diseases almost always end in recovery, and others almost invariably terminate fatally, the final result may often be predicted with great confidence. In forming a prognosis, the physician must, however, not only take into his consideration the natural history of the individual disease, but numerous modifying influences, such as age, sex, mode of life, previous state of health, &c.

**PROGRESS OF TITLES**, in Scotch Law, means the series or chain of conveyances by which a proprietor of lands establishes his right to property. As these titles are the sole evidences of property, the progress of titles—i. e., a short statement of the nature of each conveyance, in their historical order—is first given to a purchaser, to shew that the vendor is able to sell. See **SALE OF LAND**.

**PROGRESSION**, in Arithmetic, is the succession, according to some fixed law, of one number after another. A series of numbers so succeeding one another is said to be 'in progression.' Progression may be of various kinds, but the three forms of most frequent occurrence are *Arithmetical Progression* (q. v.), *Geometrical Progression* (q. v.), and *Harmonical Progression*. The conditions of the harmonical progression of a series are frequently stated as follow: *three numbers are in harmonical progression, when the first has to the third the same ratio that the excess of the first over the second has to the excess of the second over the third*, i. e.,  $a, b, c$  are in harmonical progression when  $a:c::a-b:b-c$ ; but a much simpler conception of it is obtained by means of one of its properties, viz., that if the terms of a harmonical series be inverted, they form a series in arithmetical progression; thus, 1, 2, 3, 4, 5, 6, &c. is an arithmetical progression; and  $1, \frac{1}{2}, \frac{1}{3}, \frac{1}{4}, \frac{1}{5}, \frac{1}{6}$ , &c. is a harmonical progression;  $1, \frac{1}{2}, 0, -\frac{1}{2}, -1$ , &c. is an arithmetical progression; and  $1, 2, \infty$  (infinity),  $-2, -1$ , &c. is a harmonical progression. This series is principally important in connection with the theory of music, in determining the length of the strings of instruments. See **MUSIC**.

**PROGRESSION, MUSICAL**, the regular succession of chords or movement of the parts of a musical composition in harmony, where the key continues unchanged, is called Progression; where a new key is introduced, it is not progression, but Modulation (q. v.). Musical compositions move from note to note either by degrees, when the interval does not exceed, or by skips where it does exceed a whole tone. Motion in music of two parts is of three kinds: oblique, when one part repeats or holds on the same note, while the other moves up or down; direct, when both parts move in the same direction; and contrary, when one moves up, and the other down. In progressing from chord to chord, it is in general desirable to retain every note common to both chords in the same part in which it appeared in the first chord, and to assign every new note to that part in the second chord which is nearest to it. There are certain chords which require to be followed by certain others in order to resolve them (see **RESOLUTION**); and there are certain progressions which must in ordinary cases be avoided, more particularly consecutive fifths and consecutive octaves,

the latter being, however, admissible when employed to strengthen a part.

**PROHIBITION.** Prohibitive duty refers to a practice, obsolete in this country, of prohibiting the importation of goods, with the view of encouraging native industry. See **FREE TRADE**.

**PROHIBITION** is a writ in England proceeding out of a superior court of law to prohibit or prevent an inferior court from proceeding to hear or dispose of a suit or matter over which it has no jurisdiction. —In Scotch law, the same word means a technical clause in a deed of entail by which the heir of entail is prohibited from selling the estate, or contracting debt, or altering the order of succession under pain of forfeiture, which forfeiture is declared by another supplemental clause called a resolutive clause.

**PROJECTILES, THEORY OF,** is the investigation of the path or *trajectory*, as it is called, of a body which is projected into space in a direction inclined to that of gravitation. A body thus projected is acted upon by two forces, *the force of projection*, which, if acting alone, would carry the body onwards for ever in the same direction and at the same rate; and *the force of gravity*, which tends to draw the body downwards towards the earth. The force of projection acts only at the commencement of the body's motion; the force of gravity, on the contrary, continues to act effectively during the whole time of the body's motion, drawing it further and further from its original direction, and causing it to describe a curved path, which, if the body moved in a vacuum, would be accurately a parabola. This is readily seen by considering fig. 1, in which A represents the point from which the body is projected (suppose the embrasure of a fort); AB the direction of projection (horizontal in this instance); Al the distance which would be passed over by the projectile in unit of time if gravity did not act; 1—2, the distance which would

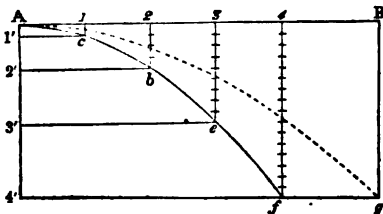

Fig. 1.

similarly be described in second unit of time; 2—3, 3—4, &c. the distances corresponding to the third, fourth, &c. units of time—all these distances being necessarily equal, from the impulsive nature of the force of projection; A1', again, represents the distance which the projectile would fall under the action of gravity alone in the first unit of time; 1'—2' the distance due to gravity in the second unit of time; 2'—3' the distance due to the third unit, &c., the distances A1', A2', A3', &c., being in the proportion of 1, 4, 9, &c. (see **FALLING BODIES**); hence, by the well-known principle of the *Composition of Forces and Velocities* (q. v.), we find at once, by completing the series of parallelograms, that at the end of the first unit of time the body is at c, at the end of the second at b, at the end of the third at a, &c. Now, as the lines 1'c, 2'b, 3'e, &c. increase as the numbers 1, 2, 3, &c., and the lines A1', A2', A3', &c. as the numbers 1<sup>2</sup>, 2<sup>2</sup>, 3<sup>2</sup>, it follows that the curve Acbe is a Parabola (q. v.). As, by the second law of motion, each force produces its full effect undisturbed by the other, it follows that the projectile reaches f in

the same time as it would, without being projected, have taken to fall to 4'. A greater velocity of projection would make it take a wider flight; but at the end of four seconds, it must still be at some point in the same horizontal line—at g, for example.

In order to determine exactly the motion of a projectile, and to find its range, greatest altitude, and time of flight, it will be necessary to examine its nature more technically—for which some slight knowledge of algebra and trigonometry is requisite. Let the body in this instance be projected obliquely to the direction of gravity, from the point A (fig. 2) in the direction AT, and let the velocity of projection *v* be sufficient, if gravity were not to act, to carry it to T in *t* units of time, and let the force of gravity, if allowed to act upon it at rest, carry

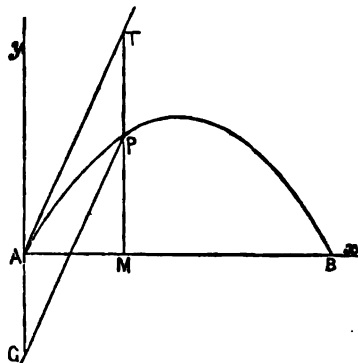

Fig. 2.

it to G in the same time; then, as before, the body, under the action of both forces, will be found at P (which is found by completing a parallelogram of which AT and AG are the sides) at the end of *t* units of time, having fallen through a distance equal to TP (not at once, but in a constant succession of minute deflections, as indicated in fig. 1) in that time. Let *t* represent the time of flight, *v* the velocity due to projection, *g* the accelerating force of gravity, and let A be the angle of elevation TAB; then AT = *vt*, TP =  $\frac{1}{2}gt^2$ , TM = *vt* sin. A; and consequently PM (or *y*) = *vt* sin. A -  $\frac{1}{2}gt^2$  (I), and AM (or *x*) = *vt* cos. A. Now, if we find from the last two equations the values of *t*, and equate these values, we obtain, by an easy algebraic process, the equation  $y = x \tan. A - \frac{gx^2}{2v^2 \cos.^2 A}$ ;

and if the height through which the body must fall to acquire a velocity equal to the velocity of projection be called *h*, then  $v^2 = 2g \cdot h$ ,  $h = \frac{v^2}{2g}$

$4h = \frac{2v^2}{g}$ , and  $\frac{1}{4h} = \frac{g}{2v^2}$ , substituting which in the equation, we obtain  $y = x \tan. A - \frac{x^2}{4h \cos. A}$  (II),

as the equation to the path of a projectile, where *x* is the horizontal distance, and *y* the corresponding height above the level of the point of projection. Suppose, now, that we wish to find the *time of flight* on the horizontal plane, it is evident that at the end of its flight the projectile will be at B, and *y* will be equal to zero; hence, putting *y* = 0 in equation I, we obtain  $t = \frac{2v \sin. A}{g}$ . The *range* or

distance AB is similarly found by putting *y* = 0 in equation II, when *x* is found to be equal to  $4h \sin. A \cos. A$ , or  $2h \sin. 2A$ . The *greatest altitude*

is evidently the point which the projectile has attained at the end of half the time of flight,

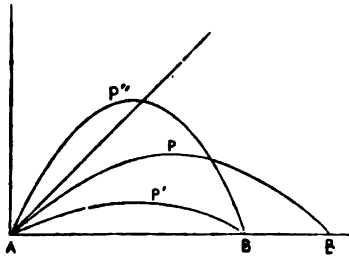

Fig. 3.

or after it has traversed half its horizontal range, hence, by putting  $x = 2h \sin. A \cos. A$  in equation II, or  $t = \frac{v \sin. A}{g}$  in equation I, we obtain  $y = h \sin.^2 A$ . A slight examination of the expression for the range will shew that it is greatest when the body is projected upwards at an angle of  $45^\circ$  to the horizon, and that a body projected at a greater angle than  $45^\circ$  has the same range as one projected at an angle correspondingly less (fig. 3).

These results, however, do not correspond to the actual circumstances of the case, except when the projectile possesses considerable density and its motion is slow, for in all other cases, the resistance of the air, which increases in a rapid ratio with the velocity of the projectile, causes it to deviate very considerably from a parabolic orbit, especially during the latter half of its course (fig. 4).

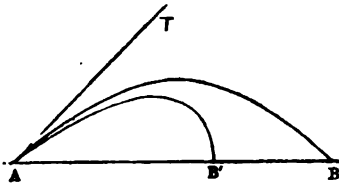

Fig. 4.

The problem of the motion of a projectile thus complicated becomes of considerable difficulty; partly because our knowledge of the law of resistance of the air is imperfect (it was supposed by Newton to be proportioned to the square of the velocity), and partly because the law varies with every minute change in the form, size, and density of the body projected, so that, under these circumstances, the beautiful and simple theory sketched above is practically useless. The chief illustrations of the theory of projectiles are the motion of missiles thrown by the hand, or arrows impelled from a bow, in both of which cases the resistance of the air is comparatively ineffective, the velocity being small: in the far more important case of ball-practice, whether with fire-arms or heavy ordnance, its effects are so powerful as to render the laws of gunnery mere deductions from experience. See RIFLE AND RIFLED ORDNANCE, and GUNNERY.

**PROJECTION** is the representation on any surface of objects or figures as they appear to the eye of an observer. It thus includes Perspective (q. v.), and is most simply illustrated by the shadow of an object thrown by a candle on a wall; the shadow being the projection, and the place of the light the position of the eye. The theory of

projections is of great importance, both in mathematics and geography, being, in the former case, perfectly general in its application; while in the latter only the projection of the sphere is required. Projections of the sphere are of various kinds, depending upon the position and distance of the eye from the sphere, and the form of the surface on which the projection is thrown; thus, we have the *orthographic*, *stereographic*, *globular*, *conical*, and *cylindrical* or *Mercator's* projections, all of which are treated under the article MAP. Another projection frequently employed is the *gnomonic*. In the gnomonic projection, the eye is supposed to be situated at the centre of the sphere, and the surface on which the projection is thrown is a plane surface which touches the sphere at any one point (called the *principal point*). It is evident that a map constructed on the gnomonic projection is sensibly correct only for a circular area whose circumference is at a small angular distance from the principal point. From the position of the eye in the gnomonic projection, it follows that all great circles, or portions of great circles, of the sphere are represented by straight lines, for their planes pass through the eye. The distance of two points on the sphere, when measured along the surface, is least if they are measured along a great circle; and as the distance of the projections of these points on the plane is represented by a straight line, which is the shortest distance between two points on a plane, this projection, if employed in the construction of mariners' charts, would at once shew the shortest course. Maps of the earth's surface have been projected by the gnomonic method, the surface of projection being the interior surface of a cube circumscribing the sphere, and the complete series consequently amounting to six maps; but it is not fitted for the construction of maps of large portions of the earth's surface. The gnomonic projection derives its name from its connection with the mode of describing a gnomon or Dial (q. v.). The orthographic and stereographic projections were employed by the Greek astronomers for the construction of maps of the heavens; the former, or *analemma*, being the best known and most used. The stereographic, called *planisphere* by the Greeks, is said to have been invented by Hipparchus, and the gnomonic is described by Ptolemy. The others are of modern invention.

In Mathematics, the theory of projections is general in its application, and has been employed within the last few years to generalise the ancient geometry, and as a powerful aid to algebra. Its basis is the investigation and determination of those properties which, being true of a figure, are also true of its projections, such properties being necessarily dependent, not on the 'magnitude,' but on the 'position' of the lines and angles belonging to the figure. These properties are generally denominated *projective properties*. For instance, the three conic sections, the parabola, ellipse, and hyperbola, are merely various projections of a circle on a plane, and all 'positional' properties of the circle are at once, by this theory, connected with similar properties of the three conic sections. The theory is also largely employed in demonstrative mechanics.—See, for further information, *Mulcahy's Modern Geometry*, *Salmon's Conic Sections*, *Monge's Géométrie Descriptive*, *Poncelet's Propriétés des Figures Projectives*, and *Poisson's Traité de Mécanique*.

**PROLAPSUS ANI** is a common affection of the termination of the intestinal canal, and consists in an eversion of the lower portion of the rectum, and its protrusion through the anus. It may depend on a naturally relaxed condition of the parts, as in infancy, or may be caused by violent straining, in

cases of costiveness, piles, &c. Whenever it occurs, the parts should be washed, and, if possible, replaced by careful pressure with the hand; and if they do not easily return, the forefinger should be oiled, and pushed up into the anus, and it will convey the protruded intestine with it, after which the patient should retain the recumbent position for some hours. If it cannot be returned by the above means, surgical assistance should be at once sought. In order to remove the tendency to prolapsus, the patient should regulate his bowels so as to avoid costiveness, should sponge the parts after every evacuation with cold water or soap and water, and if necessary, use astringent injections, as, for example, a weak solution of sulphate of iron, one grain to the ounce. Dr Druiitt (in his *Surgeon's Vade Mecum*) recommends a plan first suggested by Dr M'Cormac—namely, that when the stools are passed, the skin near the anus should be drawn to one side with the hand, so as to tighten the orifices. If, after the adoption of these means, the bowel continues to descend, certain surgical means must be resorted to, as destroying a small portion of the relaxed mucous membrane by the application of nitric acid, or pinching up a few folds of the protruded membrane with the forceps, and applying ligatures to them.

**PROLAPSUS UTERI**—known also as **PROCDENTIA** or **DESCENSUS UTERI**, by writers on the diseases of women; and as 'falling down of the womb,' or 'bearing down,' among non-professional persons—consists essentially in a depression of the womb below the natural level in the pelvis. It is a common affection amongst all ranks, and is most frequent in women beyond the middle age who have borne large families. It has, however, been met with in women who have not borne children, in virgins, and even (although very rarely) in children. It may occur in every degree, from the case in which the mouth of the womb is a little lower than its natural level, to that in which the womb itself projects externally, and forms a protruding tumour as large as a melon. In the latter case, it displaces by its traction the bladder, rectum, and other important structures. The prolapse is termed *imperfect* as long as there is no external protrusion, and *perfect* when the womb is protruded externally. The causes of these different degrees of prolapse are the same, and the symptoms differ only in intensity. The immediate causes are, according to Sir C. Clarke: (1.) Relaxation of the ligaments of the uterus; (2.) a want of due tone in the canal leading from the uterus to the external surface. The latter is probably the chief cause. After many child-bearings, it remains dilated, and its walls lose their resisting power. Similar effects result from repeated uterine hæmorrhage, leucorrhœa (popularly known as the *Whites*), and general debility. Under these conditions, a very slight downward force will depress the womb; and this force is supplied by the increased weight of the organ itself, if the patient sit up or walk soon after delivery, by violent vomiting or straining (when the bowels are constipated), by the endeavour to lift heavy weights, &c.

The symptoms arise partly from the pressure of the womb on other organs, partly from the simultaneous displacement of adjacent parts (as the bladder, rectum, &c.), and partly from reflex action (see **NERVOUS SYSTEM**). Patients with only a slight displacement usually complain of a sensation of fulness in the pelvis, of weight and bearing down, of dragging from the loins, often amounting to pain in the back, these symptoms being aggravated when the upright position is assumed. Strangury (q. v.) is occasionally present, and if the womb descend low or protrude, there is always more or less difficulty in evacuating the contents of the bladder and

rectum. The digestive organs soon become affected through reflected nervous influence. It is a remarkable fact, that the general health is often much worse in those cases in which there is a slight depression, than in those in which the prolapse is complete, and the womb forms an external tumour.

The treatment varies with the degree of displacement. In the milder cases, medicines should be administered with the view of giving tone to the mucous membrane of the relaxed canal; while in the severe cases, mechanical support is requisite. In comparatively mild cases, prolonged rest in the horizontal position should be enforced, and cold water (from half a pint to a pint) should be slowly injected, night and morning, into the canal leading to the uterus, by means of an elastic bottle, the patient being in the recumbent position as she receives the injection. If this treatment is insufficient, astringent injections, as decoction of oak-bark or of galls, or a solution of alum (an ounce to the pint of water), should be tried. If, however, there is any congestion or inflammation of the parts, astringents must be avoided. In a case of complete prolapse, the first duty of the practitioner is to attempt to restore the womb to its natural position. It is sometimes necessary to place the patient in a warm bath, or to apply fomentations or leeches to the tumour before it can be replaced; and occasionally, irreducible cases occur, in which it may be necessary to remove the organ altogether. But suppose it returned to its position, a repetition of the prolapse has to be prevented. The ordinary method is by the introduction of a pessary—an instrument of an oval or globular form, and usually made of box-wood, which mechanically supports the uterus in its normal position. See the works of Churchill, West, and others *On the Diseases of Women*. In some cases, a compress and bandage will afford sufficient support; while in other cases a surgical operation similar to that which is performed for *Prolapsus Ani* (q. v.) is expedient.

**PROLÉTAIRES**, a term used by the French (from whom it has been partially adopted by recent English and German writers) to denote the lowest and poorest classes of the community. It is derived from the Latin *proletarii*, the name given in the census of Servius Tullius to the lowest of the centuries, who were so called to indicate that they were valuable to the state only as rearers of offspring (*proles*).

**PROMETHEUS** (Forethought), the son of the Titan Iapetus and of Clymene, brother of Atlas, Menœtius, and Epimethus (Afterthought)—or, according to other legends, the son of Iapetus and Asia, or of Uranus and Clymene, or of Eurymedon and Here—the father of Deucalion, Hellen, Lykus, and Chymærus. The myth of P. is one of the oldest of Greek antiquity, being mentioned by Hesiod, and is briefly as follows:—Once, under the reign of Zeus, men and gods were disputing with one another at Mecone; P., with a view to outwit Zeus, cut up a bull, and divided it into two parts, hiding the meat and the intestines in the skin, and putting a bad piece (the stomach) at the top of it; while he laid in another heap the bones, which were covered with fat. Zeus pointed out the unequal division, but was asked to choose, whereupon he guessed the deceit practised, and selected the good portion; but irate at the stratagem, he avenged himself on the mortals by withholding from them the fire necessary for the cooking of the meat; whereupon P. stole it in a hollow staff, and brought it to them. Zeus, to punish the mortals, caused Hephestus to mould a virgin of rapturous beauty, Pandora, whom Epimethus was warned

## PROMISE—PROMOTION.

enough to receive as a present from Hermes; and thus brought, through her box, all imaginable ills that flesh is heir to upon humanity. P. himself was chained to a rock, and an eagle sent to consume his liver in daytime, while Zeus caused it to grow again at night. Herakles, however, killed the eagle, and, by the permission of Zeus, delivered the suffering Prometheus. Thus far Hesiod's legend. Æschylus, in his tragedy with the name of the hero, has perpetuated another view of the myth. P., according to him, is an immortal god, a friend of the human race, who does not shrink even from sacrificing himself for their salvation. He is the long-suffering hero, who, although overcome by Zeus's superior might, yet does not bend his mind. He at first assists Zeus against his own kindred, the Titans, and even opens his head at the birth of Minerva. But when Zeus, having come to the throne, conceived evil plans against mankind, wishing to destroy them entirely, in order to create a new race, P. throws himself into the breach; and while taking from them the evil gift of foreseeing the future, gives them the two infinitely superior gifts of hope and of fire. He is the inventor of architecture, astronomy, writing, figures, medicine, navigation, the mystery of prophecy, the arts of working in metal, and all other arts which embellish and adorn life. For these boons conferred on the human race, he is, by Zeus's order, chained to a rock in Scythia by Hephestus, who fulfils this task reluctantly. Here he is visited by the Oceanides, by Io, who tells him of her own miserable wanderings, and by Hermes, who endeavours to find out that which P. only knows, viz. who will be the son of Zeus and his successor. Refusing to divulge this secret, he is struck by Zeus's lightning, and hurled into Tartarus, whence he only re-issues after a time to undergo new sufferings. He is now fastened to Mount Caucasus, and the eagle, an offspring of Earth and Tartarus, comes to torment him daily. Cheiron, the Centaur, at last offers himself to supply P.'s place in Hades—for on no other condition was he to be liberated than that some other immortal should offer himself in his stead. Cheiron, incurably wounded by Herakles, is accepted by Zeus.—Other legends give varying accounts. One makes P. the creator of man out of earth and water—Zeus having, after the flood of Deucalion, ordered both him and Here to make man out of the mud left, and the winds to breathe life into them; and at Panopeus, in Phocia, a piece of that creative earth was in after times shewn to the wonder-struck multitude. It was also at his suggestion that Deucalion and Pyrrha built the vessel that bore them safely through the floods. P. had a sanctuary at Athens, and torch-races took place in his honour. Many have been the explanations of this myth, one of which is, that it represents the human mind, which, in the consciousness of its own power, refuses to obey implicitly the will of Zeus; another, that it embodies the first struggles between the ancient (Pelagian) powers of nature and the awaking of the mind, as represented by Zeus and the Olympians, &c. The subject is fully discussed in Welcker's *Æschylische Trilogie Prometheus* (Darmstadt, 1824).

**PROMISE**, in English Law, is often used to denote one side of a contract or agreement, either by word of mouth or in writing which is not under seal. In England, an action cannot be brought on a promise unless some consideration was given for it; but in Scotland, a consideration is not necessary, provided the promise was made in earnest and with deliberation. A promise of marriage means a mutual promise, each being an equivalent

for the other; and accordingly, if one breaks the promise, the other can sue for breach of it. See **MARRIAGE**.

**PROMISSORY-NOTE** is a contract by which A, the promiser, agrees to pay B, the promisee, a sum of money, either on request or on a future day. A is called the maker of the note, and B the payee of the note. The law affecting notes is substantially the same in all respects, and is always treated as part of that of Bills of Exchange (q. v.).

**PROMOTION**, a term which has been applied to the granting of a degree by a university. The practice of conferring the title of doctor by authority and after examination, seems to have originated in the university of Bologna, in the middle of the 12th century. Degrees were at first conferred by *cooptation*, i. e., admission by the common consent of the body of doctors; but in the beginning of the 13th c., Honorius III. placed promotions under the control of the archdeacon of Bologna.

**PROMOTION**, in the **ARMY AND NAVY**. The efficiency of any body of men depends upon the energy of the individuals composing it: the root of that energy is emulation; and emulation can only be secured by maintaining a proper current of promotion. The efficiency of a service is thus dependent on the system of promotion adopted; and so important, consequently, does promotion become, that in the present article it is purposed to glance at the rules observed in the principal armies of the continent, before describing the system which obtains in the British service.

In the *Army of France*, it is a common saying, that every conscript has a marshal's *bâton* in his knapsack. Speaking of the times of the revolutionary war, this was doubtless true, for battalions chose their chief officers from their own ranks—a conscript of one year was often a lieutenant-colonel the next, and perhaps a brigadier-general the following. In the quieter times of recent years, however, progress is slower; and although promotion is open to all, and a considerable proportion of the officers do rise from the ranks, yet it is very rarely indeed that an officer, who has so risen, ever attains a higher grade than that of captain. Conscripts are enrolled for seven years; junior commissions are—if the rule of the service were strictly followed—given, one-third to men from the ranks, one-third to cadets from the military schools, and one-third by imperial patronage. In practice, it appears that in the Artillery and Engineers, two-thirds of the first commissions are given to pupils from the Polytechnique, and the remainder to men from the ranks; while in the Line, two-thirds of the officers rise from the ranks, and one-third come from the Military School of St Cyr. Before officers can be promoted, certain service in each rank is required, viz. as 2d lieutenant, two years; as lieutenant, two years; as captain, four years; as major, three years; and as lieutenant-colonel, two years. These periods are, however, curtailed in time of war. Promotion takes place in the regiment up to the rank of captain, two-thirds by seniority, and one-third by selection. From captain to major (*chef d'escadron ou de bataillon*), promotion is divided equally between seniority and selection; while to all higher ranks it falls exclusively to selection. The selection is made on reports by the inspectors-general of the several arms—their reports being founded on personal observation, and the testimony of senior regimental officers. To maintain rapidity of promotion there is a fixed age at which officers *must* retire, viz. lieutenant-general, 65; major-general, 62; Colonel, 60; lieutenant-colonel, 58; major, 56; captain, 53; lieutenant, 52.



In *Austria*, all officers are at first cadets; but a large proportion of these cadets are nominated from men in the ranks by their comrades. The men themselves are conscripts, enrolled for eight years. Promotion goes by seniority, and in the regiment, with occasional selection from other regiments.

The organisation and officering of the *Prussian* army are both peculiar. Every Prussian subject, of whatever rank, is bound to serve from the age of 20 to 25; but in practice, this service is reduced to a year in the case of professional men. Every officer must serve in the ranks; but not necessarily for more than a day. Young gentlemen intended for officers enter the ranks as *aspiranten*. They do duty as common soldiers for from six to nine months, and pass two examinations. Afterwards they remain nine months at a Division School, or twelve months at an Artillery and Engineer School. They then become eligible for appointment as officers when vacancies occur, which, however, they cannot obtain unless recommended by the officers of their respective regiments. Two-thirds of the first commissions are given to these *aspiranten*, and one-third to pupils from the cadet schools.

In the *Italian* army, one-third of the sub-lieutenants are promoted from the ranks. Of subsequent promotion, two-thirds go by seniority, and one-third by selection.

It is always urged against the *British* system of army promotion that it is too exclusive, and confines the commissions to the upper classes of society; and there is no doubt that promotion from the ranks is much rarer than in almost any other army. But, on the other hand, it is argued, the constituents of the force are very different. Soldiers in Britain are not conscripts, who necessarily comprise men of all classes and all degrees of education, but are taken, as a rule, from an extremely low and very uneducated class of society. Again, Britain has a true middle class, which is wanting in almost every continental nation. Its army is not, therefore, necessarily aristocratic because it is not officered from the ranks. Lastly, the habits of the different classes of society differ so greatly, that unless the soldier be very superior to his comrades, promotion to a commission is a small boon.

With regard to the actual system of promotion which obtains: in the ranks, promotion from private up to company-sergeant takes place in the company, and is made by the regimental officers. The promotion of company-sergeants to be staff-sergeants is made throughout the regiment. All these promotions are by selection entirely. Of the commissioned officers, the quarter-masters and riding-masters are appointed almost exclusively from the ranks; but they have no further promotion to look forward to—sergeants and sergeants-major are occasionally gazetted to ensigncies or lieutenantcies without purchase, but not very frequently. The junior combatant officers acquire their commissions either by a competitive examination, without purchase, or by a pass-examination with purchase. The Artillery and Engineers are non-purchase corps, and are officered entirely by cadets from the Royal Military Academy, whose subsequent promotion is by seniority only. The Cavalry, Military Train, Guards, and Line are purchase corps. The vacancies, if caused by officers selling out, are filled by officers buying in; if caused by death or augmentation, they are filled from Sandhurst Military College by cadets, who are selected through competitive examination, and who do not purchase, or by gentlemen buying subaltern commissions: a small proportion of these vacancies are also filled from the ranks. The promotion of officers, up to the

rank of captain, is exclusively regimental, and by seniority, qualified, in purchase corps, by purchase. See PURCHASE SYSTEM. Above the rank of captain, the same principle holds for *substantive* or *regimental* rank; but officers may hold at the same time *army* or *brevet* rank, conferred for distinguished service, or for mere seniority in the general list of the whole army. This brevet rank cannot be purchased, does not affect the position in a regiment, and adds but a small sum to the officers' pay; but it is of great importance, inasmuch as colonels rise by seniority alone to be general officers, and colonel is almost exclusively a brevet rank (the only exceptions being in the Artillery and Engineers, where colonel is a regimental rank). Under these rules, it sometimes happens that an officer who has never held higher regimental rank than captain, may become successively, for good service, brevet-major, brevet-lieutenant-colonel, and brevet-colonel, until he succeeds, in his turn, to the rank of major-general. See also STAFF.

In the Navy, the promotion of sailors to be petty officers is made by the captain of the ship; petty officers are appointed to be warrant-officers by the admiral of the station, subject to Admiralty confirmation. The commissioned officers are appointed and promoted by patronage solely. When a ship is first commissioned, the captain is allowed to nominate one cadet, the Admiralty name the rest. Promotions are made by selection by the Admiralty, except death vacancies which occur abroad; these are filled up by the admiral commanding on the station from the officers of his fleet. Above the rank of captain, all promotions take place by absolute seniority. There is no purchase of commissions in the navy.

PRONA'OS, the area or space before the cell of a temple, through which it was entered.

PRONG-HORN, or PRONG-HORNED ANTELOPE (*Antilope furcifera*, *Dicranocerus furcifer*, or *Antilocapra Americana*), a species of antelope inhabiting the great western prairies of North America. It is the *Cabrit* or *Cabree* of the Canadian voyageurs,



Prong-horned Antelope (*Antilope furcifera*).

is also called *Goat* by the fur-traders, and sometimes receives the name of *Spring-buck*. It is common between the Saskatchewan and the Missouri, and also on the Columbia, and is found in plains and on low hills, where there is no wood, or only scattered clumps of trees; never in mountainous districts, nor in forests. Its size is nearly that of

## PRONOUNS.

the roe; in its general form and gait it resembles the chamois. In summer, the hair of the P. is smooth and flexible, but as winter approaches it lengthens; each hair becomes thick, its interior becomes white and spongy, and it loses its flexibility, at last becoming brittle, so that its point is easily rubbed off; but this singular fur forms a very close and warm covering for the animal. The P. is generally seen in small herds, sometimes solitary. It is very curious about any strange object, and advantage is sometimes taken of this by Indian hunters, who crouch, run a few yards, and stop again; the prong-horns wheeling around them, coming nearer, and becoming still more curious, till they are within shot.

**PRONOUNS**, one of the classes of words or parts of speech, possessing a special interest both logical and philological. 'I am sick.' 'Thou knowest the truth.' 'John was here, but he went away again.' 'Peter struck the boy, who had done him no harm.' 'What do you want?' The words in italics in these sentences are called *Pronouns*, because they stand for (Lat. *pro*) nouns, or names of persons and things; and they are generally said to be used to prevent the too frequent repetition of the nouns. Yet the pronoun and the noun are not exact equivalents for each other. No noun can be an exact substitute for *I*, *thou*, or *who*. Pronouns are symbols, names, or highly-generalised marks, applied to objects to signify, not any inherent attribute, but merely their relations to the act of speaking. They might therefore be called *relational names*. *I*, for instance, is a name applicable to all subjects that can be conceived as speaking. In such a sentence as 'I am sick,' in which the state, 'sick,' is affirmed about some one, the exact force of *I* may be thus expressed: The person of whom 'sick' is affirmed is one with the person making the affirmation. Who the individual person is, the pronoun *I* gives no indication; it is implied that this is known from some other source. Those present learn it by hearing whence the sound comes; in a book, it is gathered from the context.

In like manner, *thou* is a generalised name for all persons spoken to. What it means or connotes is—with reference to the example above given—that the person affirmed to know the truth, and the person to whom the affirmation is addressed, are one and the same. What particular person it denotes must be learned, as before, from circumstances. If the clause, 'he went away again,' stood by itself, what person is denoted by *he* would be still more vague than in the case of *I* and *thou*. *He* merely implies that a person, neither the speaker nor the spoken to, but one known in some way, is the subject of the assertion. Who it is, is determined, in the example, by *John*, with which *he* stands in close relation. *Who* designates some person already named, referring us back to that name (the antecedent) for determining the individual. *What* connotes that the subject is unknown.

Pronouns are usually divided into Personal and Relative.

**1. Personal Pronouns.**—The several objects concerned in a speech or sentence stand in one or other of the three relations of speaker (First Person), object spoken to (Second Person), object spoken about (Third Person). Pronouns expressive of these relations are called Personal Pronouns. They are (in the nominative case), 1st person, *I*, *we*; 2d, *thou*, *ye* or *you*; 3d, *he*, *she*, *it*, *they*.

Along with the personal pronouns, and most nearly related to the pronouns of the third person, may be classed the words *one* and *that* in certain constructions. In phrases like, 'One cannot be sure of that,' *one* is an indefinite pronoun, designating

any person whatever. It is distinct from the numeral adjective *one*, being derived from the French *on*, which is a corruption of *homme*, man. When we say, 'I like peaches, but let me have a ripe *one*, or ripe *ones*,' we have now the numeral used as another indefinite pronoun. The first of these indefinite pronouns is applied only to persons; the second, both to persons and things.

When we say, 'Give me *this*, and keep *that*,' *this* and *that* may be considered as demonstrative adjectives, with some noun understood—this (thing). But in the expression, 'He mistook his own room for *that* of the stranger,' *that* appears to be as much a pronoun as *one*.

**2. Relative Pronouns** (including *Interrogative*).—Relative Pronouns, besides standing for nouns, have the power of conjunctions. They join sentences and clauses, by relating or referring back directly to something just named. The relatives in English are three—*who*, *which*, and *that*. See RELATIVE PRONOUNS.

*What* is used for *that which*, thus embracing both relative and antecedent. In phrases like 'such a storm as now burst on them,' *as* is used with the force of a relative pronoun. Perhaps the full expression would be 'such a storm as (the storm that) burst.'

**3. Interrogative Pronouns** are those used in asking questions; they are *who*, *which*, and *what*.

These are the *simple* pronouns. But a variety of compounds are formed by joining these simple pronouns with other words, such as *himself*, *whatever*, *any one*.

Pronouns, as we have seen, express the most abstract relations in language. They are, in fact, the most attenuated and colourless signs of thought conceivable—the highest effort, apparently, of man's generalising powers. Accordingly, in the days of purely *a priori* speculation on the origin and growth of language, it was held to be indisputable that pronouns must have been the latest product of the language-making faculty; and they have been appealed to as a conclusive argument against the theory that the meaning of all words, when they are traced to their origin, is grounded on sensible properties and relations of material things. The philologist, on the contrary, pursuing his investigations on the historico-comparative method, sees irresistible proof that pronouns, in the Aryan family of languages at least, were among the earliest words in use. In fact, besides their independent use, the same elements are found as suffixes forming the inflections (see INFLECTION) of the predicative roots, and first making them real words capable of entering into a sentence. In the beginning, however, they were far from being the impalpable abstractions they afterwards became, and really form the strongest proof of the theory they were supposed to upset. They were, in fact, simply demonstrative particles, indicating palpable relations of space or position ('that' or 'there,' 'this' or 'here,' 'what' or 'where?'). We can easily see how the indication of the vocal sign would at first be helped out and made precise by gesticulation; or more probable still, the gesticulation was at first the fundamental sign, and the word a natural involuntary utterance accompanying it, and in process of time taking its place.

Of the various demonstrative radicals still traceable in the Aryan tongues as pronouns and suffixes, one of the most universal and outstanding is the sound *ta* or *sa* for 'that' or 'this,' 'there.' It is seen in the Sanscrit *sa* (mas.), *sa* (fem.), *tad* (neut.); Lat. (*is*)*te*, (*is*)*ta*, (*is*)*tud*; Gr. *ho*, *he*, *to*; Goth. *sa*, *od*, *thata*; A.-S. *se*, *seð*, *thæt*; as also in the numerous allied adverbs, e. g., Lat.

*tum, tunc*; Ger. *dann*; Eng. *so, as, then, thus*. Another demonstrative radical, *ma*, seems to have been used to call attention to the speaker—to point to the immediate or central 'here'; in short, to the 'me.' Besides occurring in the oblique cases of the first personal pronoun, the element *ma* or *m* enters largely into the suffixes of the first person of verbs in the older languages, such as Greek and Latin. The only remnant of it in English is in *I am*. The nominative case of the first person pronoun in Sansc. is *aham*, which is conjectured to be a mutilation of a fuller form, *ma-gha-m*; in Gr. and Lat. *ego*, Goth. *ik*, Ger. *ich*, A.-S. Eng. *I*, Ital. *io*, Fr. *je*, the *m* has completely disappeared. In the oblique cases it has been better preserved. The root of the 2d pers. pron. seems to have been the syllable *tu* or *tva*, indicating a position intermediate between the central 'here' and the more distant and contrasted 'there.' The form of this pronoun is more constant throughout the allied languages than that of any other: Sansc. *tvam*, Lat. *tu*, Gr. *ty* or *sy*, Ger. *du*, Eng. *thou*, Fr. *tu*, Ital. *tu*.

The pronouns of the first and second person are invariable in respect of gender, and are never used as adjectives; the pronouns of the third person not only take the form of adjectives in respect of gender, but are often—especially in the older languages—joined to nouns, in which case they are rather demonstrative (or relative) adjectives than pronouns; as Lat. *ille homo*, Eng. *that book*. It is difficult to trace any etymological relations between the singular and the plural in the first and second pronouns—e. g., between Lat. *tu* and *vos*, or Eng. *thou* and *you*; but this is not to be wondered at when we reflect that 'we' is not equal to 'I' and 'I,' but to 'I' and 'he,' or 'I' and 'thou,' and that 'you' is as much 'thou' and 'he' as 'thou' and 'thou.' The plurals must therefore have been compounded of several elements, which, by coalescence and abrasion, have become irrerecognisable.

The declension of the English personal pronouns is to be found in any elementary grammar. That of the third person is made up of fragments of several Anglo-Saxon words. The Anglo-Saxon pronoun was thus declined:

Sing.	Nom.	<i>he</i> (he), <i>heo</i> (she), <i>hit</i> (it)
	Gen.	<i>his</i> <i>hire</i> <i>his</i>
	Acc.	<i>hine</i> <i>hi</i> <i>hit</i>
	Dat.	<i>him</i> <i>hire</i> <i>him</i>
└──────────┘		
Plur.	Nom. Acc.	<i>hi</i>
	Gen.	<i>hira</i> (heora)
	Dat.	<i>him</i> (heom)

The cases marked in italics are still used in modern English, only that *him* and *her* do duty in the accusative as well as dative. *His*, as the genitive of the neuter, has been supplanted in recent times by the secondary genitive *its*, a word which does not occur once in the English version of the Bible. *She* does not represent the Anglo-Saxon *heo*, but *seo*, the feminine of the article. The modern plurals *they*, *their*, *them*, have no direct etymological connection with the singular *he* (she, it); they are taken from the demonstrative or article *that* (that, the), which has, in the plural, nominative and accusative *tha*, genitive *thara*, dative *tham*. *Them*, like *him*, was thus originally a dative case. Is it a lingering memory of the demonstrative origin of *them* that keeps alive the vulgar error of 'them things'?

Such being the arbitrary, or rather chance way in which the English pronominal system has been built up out of the wrecks of the Anglo-Saxon, there is no good reason why *them*, *him*, *her*, should not have been used in the nominative as well as in

the accusative; and, in fact, in certain connections, these forms, together with *me*, are habitually so used, although grammarians have hitherto refused to sanction the usage. Such expressions as, 'It is me;' 'better than him, than them,' &c., are not confined to the uneducated; in familiar conversation, the most cultivated use them habitually, and in preference to what are considered to be the correct forms, which are felt somehow to be stiff and pedantic. This usage has the analogy of the French in its favour (e. g., *c'est moi*), and some English philologists have begun to defend it on principle. See Alford, *The Queen's English*.

From politeness and other rhetorical motives, various substitutes take the place of the usual personal pronouns. The English language departs little from the normal usage, except in *you* for *thou*, and in the regal and editorial *we*. A French shopkeeper, instead of 'What do you wish to see?' says: 'What does the gentleman (or lady) wish to see?' All modern languages use such substitutions as, 'Your Majesty, your Excellency, wishes;' but the Italian, in speaking further of the *Excellenza*, says: 'It (*ella*, she) wishes.' The Germans use regularly *they* (*sie*) for *you*, and one never hears *you* except from the pulpit. In Hebrew, politeness took the form of saying: 'Thy servant said,' for 'I said.' Similarly, the Chinese use: 'little man, subject, thief, blockhead,' for 'I;' and an American backwoodsman speaks of himself as 'this 'oss,' or 'this here child.'

#### PROOF. See EVIDENCE.

**PROOF OF FIRE-ARMS.** Guns of all descriptions are proved before being issued for service. Muskets are tested by being fired with heavier bullets and larger charges of powder than they will in the ordinary way be required to carry. Cannon are subjected to a series of tests. First, they are gauged to ascertain that the dimensions are correct, the utmost variation permitted being 3 inch externally, and .033 in the diameter of the bore; but the position of the bore may deviate .25 inch from the line of the piece's axis. The next trial is by firing twice with heavy charges—the bore being subsequently minutely examined, to detect flaws or crevices in the metal. A cavity exceeding in depth 2 inch, if behind the first reinforce ring, or .25 if before that ring, condemns the piece. After the proof by firing, water is forced at a great pressure into the bore, in order that it may permeate any honeycombs or flaws: the next day, the bore is examined by means of a mirror, which casts a strong light into it. Flaws are then easily detected; for while the rest of the bore is thoroughly dry, water will continue for some time to weep or run from the holes, and will stand over them in drops. This operation completes the proof. When a gun bursts in proof, the remainder of the guns of the same sort then in proof are subjected to another round.

In the case of guns of hitherto untried form, some are tested to bursting, as specimens of the power and endurance of the whole number. For Proof of Powder, see *EPROUVETTE*.

**PROPAGANDA** (Lat. *De Propaganda Fide*, Regarding the Propagation of the Faith), the name of a Congregation, and also of a College, in Rome, the object of which is to direct and forward the propagation of the Catholic religion, especially among the heathen; although Christian dissenters from the Roman Church are not absolutely excluded from its operations. Pope Gregory XIII. (1572—1584) gave to some of the cardinals a special charge over the oriental missions, and caused catechisms and other religious books to be printed for the use of oriental Christians. The work which Gregory

XIII. originated, was fully organised by Gregory XV., who, by a bull of June 22, 1622, established a Congregation of cardinals for this purpose, which his successor, Urban VIII., extended and endowed, and to which he annexed a college for the education of missionaries to the several countries; one great feature of which has been to provide for such work natives of the several countries, who are conveyed to Rome at an early age for the purpose of being specially educated in all the necessary learning of a missionary. The Congregation consists of a number of cardinals appointed for life, one of whom is prefect, and who are assisted by a secretary, and by a number of consulters, clerks (*minutanti*), and other officials. Originally, their meetings were held weekly, and in the presence of the pope; now they are monthly, there being, however, weekly conferences (*congressi*) of the prefect, secretary, and consulters; and all important business is submitted to the pope in person by the prefect or the secretary. This Congregation conducts the affairs not only of the missionary countries, properly so called, but also of those—as England, the northern kingdoms, &c.—in which the hierarchical organisation is not, or has not been full and formal. The College of the P. is a noble institution, containing nearly 200 pupils of all countries, tongues, and complexions, who are not only maintained and educated gratuitously from a very early age, but are equipped and sent forward to their several destinations at the charge of the institution. The P. College contains a most valuable library, and museum of curious objects of missionary interest; and a polygot printing-press of great extent and variety of resources in the printing art. Its great festival is the Epiphany of our Lord, or of His ‘manifestation to the Gentiles;’ and this feast is celebrated by an exhibition of exceeding interest and curiosity, in which are delivered recitations in every language represented in the College or its missions, amounting often to 60 or 80. Of this festival, the celebrated Cardinal Mezzofanti (q. v.) used to be the guiding spirit, as well as to strangers its chief centre of attraction. It continues to be one of the chief literary sights of the Roman winter.

**PROPAGATION OF THE FAITH, ASSOCIATIONS FOR ROMAN CATHOLIC.** The earliest and the highest in dignity of these has been already described under the head PROPAGANDA (q. v.). But the present century has produced several private associations, the resources of which arise entirely from voluntary annual contributions, and the organisation of which is most complete and most extensive. The first of these is that founded at Lyon in 1822, under the title ‘Œuvre de la Propagation de la Foi,’ with a branch at Paris, and subordinate branches in the other Catholic kingdoms. It is under the direction of a council, which communicates as well with the local associations through which the funds are supplied by small weekly, monthly, or yearly contributions, as with the missions to the aid of which the fund so raised is applied, by an apportionment regulated according to the necessities of each. The piety of contributors is stimulated by the exhortations of the popes, and the granting of indulgences to those who, with the other requisite dispositions, shall aid in the work. The journal of the society, entitled *Annales de la Propagation de la Foi*, is a very interesting bi-monthly collection of letters and reports from the different missions connected with the central body. The receipts of this association for the year 1863 were 4,788,496 fr., 86 c. Of this sum, by far the largest proportion was raised in France—3,307,248 fr. Italy came next, though at a long interval,

contributing 420,653; Belgium gave 271,597; Germany, 251,873; the British Islands, 127,000. Spain, once the great propagator of the Gospel in the New World, contributed but 12,549; but it is to be observed that Spain maintains for her own missionary enterprises a large and liberal establishment in connection with the mission of the Philippines and the South Sea.

Another association of somewhat later date is the ‘Leopoldiner-Verein,’ established at Vienna in 1829, the chief object of which is to assist the missions of German origin, especially in America. This association also has its own journal, entitled *Berichte der Leopoldinen Stiftung*. It is under the presidency of the Archbishop of Vienna. A third is that established in Bavaria as an offshoot of the Lyon association, under the name ‘Ludwigs-Missions-Verein.’ Like that of Vienna, its chief, although not exclusive object, is the support of German missions. The Ludwigs-Verein is conducted under the auspices of the Archbishop of Munich. All these associations, although quite independent in their management and direction, nevertheless maintain close relations with the Propaganda of Rome, and are often guided by the recommendations of the Cardinal Prefect in the distribution of their funds to particular missions.

**PROPER**, in Heraldry. A charge borne of its natural colour, is said to be proper. An object whose colour varies at different times and in different examples, as a rose, which may be white or red, cannot be borne proper.

**PROPHECY** (Gr. *propheteia*) is a word of pregnant signification. According to its usual acceptation in modern English, it implies prediction—the telling of events about to happen beforehand. But neither according to the original meaning of the word prophet in Hebrew (*nabi*) or in Greek (*prophetes*), nor according to historical usage of the verb *prophecy* in English, can such a meaning be considered exclusive. The etymological force of the Hebrew word, according to the best authorities, denotes ‘a person who, as it were, bursts forth with spiritual utterances under divine influence, or simply one who pours forth words.’ The *Nabi* is the medium of special divine communication—according to some, the man inspired by God to whom divine communications are made; but more distinctively, according to others, the man who delivers the burden of the divine thought imparted to him, who makes known the declarations of God. Besides the more authoritative expression *Nabi*, there are two other expressions (*Rosh* and *Chozeh*) used in the Hebrew original with something of the same meaning, and which are translated in our English version ‘seer.’ The exact meaning of the several words in their relation to one another has been much disputed. The best view, upon the whole, seems to be that which considers *Nabi* to denote specially the official function of the prophet, the *order* to which he belonged; and the other expressions to point peculiarly to the nature of the prophetic gift—the intuition or vision of the divine. The one may stamp more the objective function of the prophet as a *teller* or *utterer* of the divine, the other more his subjective capacity as a seer of the divine.

The original and proper import of the word *prophecy*, therefore, may be said to be the utterance of the divina. The prophet is the ‘interpreter of the divine will.’ He is expressly called ‘the interpreter and the messenger of Jehovah.’ The idea of prediction is not of course excluded; but this idea is not a radical and necessary part of the meaning of the word, nor was it at all necessarily an element

## PROPHECY.

of the prophetic office. This is apparent from the use of the word even in our English Bibles and our older theological literature. The 'sons of Asaph,' for example, it is said (1 Chron. xxv. 3) 'prophesied with a harp, to give thanks and to praise the Lord,' in the sense of merely singing or uttering God's praise under the dictate of the divine Spirit. It is said also of Philip the Evangelist (Acts xxi. 9) that he had 'four daughters, virgins, which did prophesy,' in the sense merely or mainly of declaring the gospel. In like manner, Bacon speaks in his day of 'an exercise commonly called *prophesying*,' which consisted in the exposition of a portion of Scripture by successive ministers at a meeting appointed for the purpose; and the well-known title of one of Jeremy Taylor's books, *The Liberty of Prophesying*—i. e., the liberty of preaching—recalls the same use of the word.

Prophecy among the Jews was a distinct office or function constituted under the divine sanction. The prophets were an *order* instituted, or at least reformed and more thoroughly organised by Samuel. There were prophets, indeed, before; Abraham is called a prophet (Gen. xx. 7), and Moses also (Deut. xviii. 15; xxxiv. 10); Aaron is the 'prophet of Moses' (Ex. vii. 1), and Miriam is 'a prophetess' (Ex. xv. 20); but it was Samuel who first established the office as a systematic part of the Jewish religion. For this purpose, he gathered together companies of young men of promising spiritual attainments, who were trained under his superintendence for various religious duties—the exposition of the theocratic law, and the conduct of the theocratic worship, especially of its elaborate musical departments (1 Sam. x. 5; 1 Chron. xxv. 6). The use of the psaltery and tabret, pipe, harp, and cymbal, was the peculiar business of the prophets. The young men were set apart to make proficiency in these instruments; they were placed under an elderly head or president, who received the name of father, and they were called his sons. They were 'all under the hands of their father for song in the house of the Lord, with cymbals, psalteries, and harps, for the service of the house of God' (1 Chron. xxv. 6). The prophetic institutions have been called by modern divines 'Schools of the Prophets;' but this name does not occur in Scripture, nor even in our authorised version. 'Sons of the Prophets' is the only collective name applied to the separate companies into which they were formed by Samuel. These companies were located in special spots: in Ramah, the birthplace and residence of Samuel; in Bethel, Gilgal, Jericho, and ultimately Jerusalem. They lived in huts made of the branches of trees; wore a simple, characteristic dress; had their meals together, and were found in numbers sometimes of 50, sometimes even of 400. For a prophet not to have been trained in one of these institutions, was deemed, as Dean Stanley says (*Jewish Church*, vol. i. p. 429), 'an exceptional case.' Some, like Isaiah in Jerusalem, or Elisha in Samaria, lived in great towns, in houses of their own. The higher prophets had inferior prophets or servants attendant upon them, whose duty it was to pour water upon their hands, and secure provisions for them (2 Kings, iii. 11; v. 22). Thus, Moses had Joshua and others; Elijah had Elisha; Elisha had Gehazi. Many of them were married, and had families; for example, Moses, Samuel, Deborah, David, Hosea, Isaiah, Ezekiel. The wife was sometimes, as in the case of Isaiah, called 'the prophetess.'

The prophets, according to this description, were a peculiar order of teachers among the Jews; prophecy, a distinctive part of the divine economy, by which God trained and educated the 'chosen

people.' Beginning in a definite, though still unorganised form, with Moses (for it is only incidentally that Abraham is called 'a prophet'), it assumes a regular organisation in the hands of Samuel, just when the earlier form of the theocratic government was passing away, and the monarchy was established. It grew up alongside the older institution of the Levitical priesthood without any professed or formal opposition to the latter, but playing a part distinct, and often practically opposed to it. The priests ministered at the altars of sacrifice, and discharged all the official rites of purification enjoined by the Jewish law. They were only secondarily teachers of the people. The prophets, again, while joining in the rites of the tabernacle and temple, were primarily and mainly teachers. Their function was moral, and not ritual; they upheld the ethical, spiritual, and eternal side of religion, apt to be obscured under the hardening tendencies and ambitious officialism of an influential priesthood. They were the great preachers of a righteous government of the world, and of future retribution amidst the confusions and evils of their time; and prophecy was the ever-renewing and reforming element in the constantly corrupting and decaying policy of Judaism. More particularly, the prophets were both the national historians and poets of the Jewish people, the narrators of its past deliverance, the heralds of its coming glories. The books of Joshua, Judges, Samuel, and Kings, are included among the prophetic books of the Old Testament in the Jewish canon; while the acts of David by Gad and Nathan, of Solomon and Jeroboam by Nathan and Iddo, along with other historical and biographical pieces, have unhappily perished. It is needless to point to the splendid collection of the later prophetic books, beginning with Joel, as containing, along with much direct historical matter also, the most exalted specimens of poetry to be found in any language.

But that which by many has been supposed to be the distinctive character of prophecy, and the special function of the prophets, remains to be noticed. According to the general view of theologians in modern times, prophecy is peculiarly *predictive*, and the essential characteristic of the prophet is supposed to be the power of *foretelling future events*. This view is not warranted, we have seen, either by the etymology of the word, or a comprehensive survey of the facts; but it is, nevertheless, undeniable that the Hebrew prophets directed their attention especially to the future, and 'made predictions concerning the fortunes of their own and other countries, which were unquestionably fulfilled.' 'There can be no reasonable doubt, for example,' writes one of the most liberal of modern theologians, 'that Amos foretold the captivity and return of Israel, and Micah the fall of Samaria, and Ezekiel the fall of Jerusalem, and Isaiah the fall of Tyre, and Jeremiah the limits of the captivity. It was the distinguishing mark of the Jewish people,' adds the same writer, 'that their golden age was not in the past, but in the future; that their greatest hero (as they deemed him to be) was not their founder, but their founder's latest descendant. Their traditions, their fancies, their glories, gathered round the head, not of a chief, or warrior, or sage that had been, but of a king, a deliverer, a prophet, who was to come. Of this singular expectation, the prophets were, if not the chief authors, at least the chief exponents.\*' The reality of a succession of Messianic predictions, is admitted by even very advanced theologians; and the more usual opinion, it is well known, regards

\* Dean Stanley, *Jewish Church*, vol. i. p. 466.

these predictions from the time of Moses to the time of Malachi as admitting of no question, from the supposed clearness, fulness, and particularity with which they announce a deliverer, and describe his functions. 'That salvation should come through the family of Abraham, Isaac, Jacob, Judah, David; that at the time of the final absorption of Jewish power, Shiloh (the tranquilliser) should gather the nations under his rule; that there should be a great prophet typified by Moses, a king descended from David, a priest for ever typified by Melchizedek; that there should be born into the world a child, to be called Mighty God, Eternal Father, Prince of Peace; that there should be a righteous servant of God on whom the Lord should lay the iniquity of us all; that Messiah, the Prince, should be cut off, but not for Himself; that an everlasting kingdom should be given by the Ancient of Days to one like the Son of Man. It seems impossible to harmonise so many apparent contradictions. Nevertheless, it is an undoubted fact, that at the time seemingly pointed out by one or more of these predictions, there was born into the world a child of the house of David, and therefore of the family of Abraham, Isaac, Jacob, and Judah, who claimed to be the object of these and other predictions; who is acknowledged as Prophet, Priest, and King, as Mighty God, and yet as God's righteous servant, who bears the iniquity of all; who was cut off, and whose death is acknowledged not to have been for His own, but for others' good; who has instituted a spiritual kingdom on earth, which kingdom is of a nature to continue for ever, and in whose doings and sufferings on earth a number of specific predictions were fulfilled. Then we may say that we have here a series of prophecies which are so applicable to the person and earthly life of Jesus Christ, as to be thereby shewn to have been designed to apply to Him; and if they were designed to apply to Him, prophetic prediction is proved.'—Smith's *Dictionary of Bible*, art. Prophecy.

Such is the common view of prophecy. It has, indeed, been maintained by certain writers that *literal prediction* has no place in prophecy; that Isaiah did not foretell the Babylonian Captivity, or the fall of Tyre, nor Jeremiah the Seventy Years' Captivity, nor Nahum the ruin of Nineveh; and that the Messianic prophecies were merely 'ardent hopes and poetical descriptions' of a glorious future, into which the prophetic mind naturally projected itself. Such delineations were 'in essence nothing but *forebodings*—efforts of the spiritual eye to bring up before itself the distinct form of the future; to make such presentiments into *historical declarations*, is to mistake their character.'—Davidson's *Introduction*, vol. iv. But this is not the ordinary theory of prophecy, either among Jews or Christians. Both alike recognise the reality of the predictive element, however differently they may interpret and apply the prediction. They contend not only for a special spiritual elevation in the prophet—an intenser degree of the same divine intuition which God gives to all who worship Him in love and reverence—but for a gift of light vouchsafed to him different from any ordinary endowment. Prophecy is not merely the effluence of the divine Spirit enriching and exalting all the natural faculties, but it is the direct communication of God Himself, to the prophet unveiling the future for the guidance of His church, and the glory of His name.

The further study of the subject may be pursued by readers in numerous volumes, amongst which the following may be recommended: John Smith, *Select Discourses on Prophecy*; Lowth, *De Sacra*

*Poesi Hebræorum*; Davison, *Discourses on Prophecy*; Butler, *Analogy of Religion*; Horne, *Introduction to Holy Scripture*; Eichhorn, *Die Hebräischen Propheten*; Ewald, *Die Propheten des Alten Bundes*; Hengstenberg, *Christology of the Old Testament*; Fairbairn, *Prophecy*; Davidson, *Introduction to the Old Testament*; Stanley, *Lectures on the Jewish Church*.

PROPOLIS, a substance used by bees in the construction of their combs, to give to the fabric a strength which it could not have if made of wax alone. See BEE. It is also used for closing up chinks of the hive. It is a resinous unctuous substance of a reddish-brown colour, a somewhat bitter taste, and an agreeable aromatic odour, and is collected from the buds of trees. Huber found bees eagerly to appropriate the viscous exudation which abounds on poplar buds. P. probably differs a little in chemical composition according to the tree it is obtained from, but it consists chiefly of resin. It is brought to the hive on the legs of bees, and adheres to them so strongly that the assistance of other bees is necessary for its removal. The name is from the Greek *pro*, before, and *polis*, a city; because the most exposed parts of a bee-hive exhibit this substance in greatest abundance. Foreign bodies introduced into a bee-hive, and which the bees are unable to remove, are covered with propolis.

PROPORTION, in Arithmetic and Geometry, is a particular species of relation subsisting between groups of numbers or quantities. Notwithstanding that the idea of proportion is found to exist in perfection in the mind of every one, yet a good definition of it is a matter of extreme difficulty. The two definitions which, on the whole, are found to be least objectionable are that of Euclid, and the ordinary arithmetical definition. The latter states proportion to be the 'equality of ratios,' and throws us back on the definition of the term *Ratio* (q. v.); which may most simply be considered as the relation of two numbers to each other, shewn by a division of the one by the other. Thus, the ratio of 12 to 3, expressed by  $\frac{12}{3}$ , or 4, denotes that 12 contains 3 four

times; and the ratio of 8 to 2 being also 4, we have from our definition a statement that the four numbers, 12, 3, 8, and 2, are in proportion, or, as it is commonly expressed, 12 bears to 3 the same ratio that 8 does to 2, or 12:3::8:2. In the same way, it is shewn that 3:8::13½:36; for  $\frac{3}{8}$  expresses the ratio of the first to the second, and

$\frac{13\frac{1}{2}}{36} = \frac{27}{72} = \frac{3}{8}$  It will be gathered from the two

arithmetical proportions here given, and from any others that can be formed, that 'the product of the first and last terms (the extremes) is equal to the product of the second and third terms (the means);' and upon this property of proportional numbers directly depends the arithmetical rule called 'proportion,' &c. The object of this rule is to find a fourth proportional to three given numbers—i. e., a number to which the third bears the same ratio that the first does to the second, and the number is at once found by multiplying together the second and third terms, and dividing the product by the first. Proportion is illustrated arithmetically by such problems as, 'If four yards cost six shillings, what will ten cost?' Here, 15 being the fourth proportional to 4, 6, and 10, fifteen shillings is the answer. The distinction of proportion into *direct* and *inverse* is not only quite unnecessary, but highly mischievous, as it tends to

## PROPOSITION—PROROGATION.

create the idea, that it is possible for more than one kind of proportion to subsist. *Continued proportion* indicates a property of every three consecutive or equidistant terms in a 'Geometrical Progression' (q. v.)—for instance, in the series 2, 4, 8, 16, 32... ,  $2:4::4:8, 4:8::8:16, \&c.,$  or  $2:8::8:32, \&c.$  In the above remarks, all consideration of *Incommensurable Quantities* (q. v.) has been omitted.—The definition given by Euclid is as follows: Four magnitudes are proportional, when, any equimultiples whatever being taken of the first and third, and any whatever of the second and fourth, according as the multiple of the first is greater, equal to, or less than that of the second, the multiple of the third is also greater, equal to, or less than that of the fourth—i. e., A, B, C, D are proportionals, when, if *m*A is greater than *n*B, *m*C is greater than *n*D; if *m*A is equal to *n*B, *m*C is equal to *n*D; if *m*A is less than *n*B, *m*C is less than *n*D; *m* and *n* being any multiples whatsoever. The apparent cumbrousness and circumlocution in this definition arise from Euclid's endeavour to include incommensurable quantities; throwing them out of account, it is sufficient to say that four magnitudes are proportional, if, like multiples being taken of the first and third, and like of the second and fourth, when the multiple of the first is equal to the multiple of the second, the multiple of the third is equal to the multiple of the fourth. Abundance of illustrations of the general definition will be found in the Fifth Book of Euclid, and of the particular one in the notes appended to some of the later editions of the same work; it will be sufficient here to give an arithmetical instance of the working of the particular definition. Taking the four numbers of a previous example—12, 3, 8, 2; of 12 and 8 take multiples by 4, and of 3 and 2 by 16, then  $12 \times 4$  (the multiple of the first) =  $3 \times 16$  (the multiple of the second), and  $8 \times 4$  (the multiple of the third) =  $2 \times 16$  (the multiple of the fourth). In this example, the two multiples were so taken that the multiple of the first would be equal to the multiple of the second, and when it was found that the multiple of the third was also equal to the multiple of the fourth, the proportionality of the four numbers was established.

**PROPOSITION.** This is the technical name for the final constituent, or ultimate element, of whatever we call knowledge—what we can believe or disbelieve. 'Fire melts wax;' 'the harvest is good;' 'Rome stands on the Tiber;' 'the moon is not inhabited'—are propositions. All information, whether historical, scientific, or practical, may be resolved at last into simple statements such as these; and all such statements are propositions. In every proposition, there are two parts: something spoken about, called the Subject; and something said, affirmed, or declared of what is spoken about, called the Predicate. In the first example given, 'Fire' is the subject, 'melts wax' is the predicate or affirming part, to which a verb is necessary. In the second example, 'Harvest' is the subject, 'is good' the predicate. But sometimes this last part is resolved further into Predicate (good) and Copula (is). The predicate then simply means the quality or fact affirmed, while the copula gives the affirmation. In the previous case, the copula is contained in the predicate (melts).

Propositions are *affirmative* or *negative*, according as we declare that a thing is, or that it is not: 'the moon is (not) inhabited.' As some propositions contain the form of a condition, and some the form of an alternative, these are called *hypothetical*, in opposition to which the rest are called *categorical*. If A is B, C is D, is the *conditional* form of the

hypothetical class. Either A is B, or C is D, is called the *disjunctive* form.

Propositions are further divided, according to their quantity, or according to the extent of the subject, into *universal*, *particular*, *singular*, and *indefinite*: 'all the moving powers are originally derived from the sun' (universal); 'some men are wise' (particular); 'Socrates is wise' (singular). The 'indefinite' means the uncertain or ambiguous in form, as 'wine is good;' many of this form are known to be universal, as 'man is mortal.'

In inquiring into the ultimate import or meaning of propositions, Mr John Stuart Mill has come to the conclusion that they fall under five classes, distinguished according to the nature of the quality predicated. The five universal and comprehensive predicates are—Existence, Co-existence (sometimes taking the form of Order in Place), Succession (Order in Time), Causation, Resemblance. Every fact, or piece of information, consists in the affirmation of some one of these five general attributes. Existence by itself expresses a very limited class, since we usually specify circumstances of time, place, &c., in the same assertion: 'There is an ether for conveying light and heat,' is a proposition of Existence; but it would be more usually stated as having locality (Order in Place, or Co-existence), 'an ethereal medium is diffused over all space.' Existence is the only one of the five attributes that can be affirmed of one thing; all the rest require at least two things. The attribute of Co-existence appears in a very large number of propositions: all geographical statements and local descriptions; all the natural conjunctions of properties (the animal frame consists of digestive organs, a nervous system, &c.), affirm co-existence. The attribute of Succession is seen in history, and in all the changing aspects of things. The attribute of Causation is a special case of Succession, so important as to be raised to the rank of a first-class predicate. The facts of physical and mental science involve not merely succession, but cause and effect: 'Heat expands bodies;' 'practice improves the human faculties.' The concluding attribute—Resemblance—is of very wide occurrence. The propositions of numerical or mathematical science all involve some assertion of equality or inequality, proportion or disproportion: 'Twice three is (equal to) six;' 'triangles in the same base and between the same parallels are equal.' Throughout all our knowledge, the affirmation of likeness, or of unlikeness, is a fundamental fact; but, in mathematics, it constitutes the characteristic predicate, or the sole affirmation.

**PROROGATION**, the continuance of parliament from one session to another. Parliament is prorogued by her Majesty's command, signified in her presence by the Lord Chancellor, or Speaker of the House of Lords, to both Houses, or when her Majesty is not personally present, by writ under the Great Seal, or by Commission. Prorogation not only suspends all business, but quashes all proceedings pending at the time, except impeachments by the Commons, and writs of error and appeals before the House of Lords. A bill must be renewed after a prorogation, as if it had never been introduced. A prorogation for a single day has sometimes been resorted to, to enable a bill to be brought in a second time, it being a rule that no second bill of the same substance with a prior one can be introduced in the same session. Thus parliament was prorogued by William III. from the 21st to the 23d of October 1689, in order to renew the Bill of Rights, regarding which a difference had arisen between the Upper and Lower House that was fatal to it. By 37 Geo. III. c. 127, after parliament has been prorogued

## PROSECUTION—PROSECUTOR.

to a particular day, her Majesty may, by proclamation, or all together on any other day, not less than 14 days distant, to which day parliament then stands prorogued. See PARLIAMENT.

**PROSECUTION**, though often used in a general sense, as applicable to all kinds of litigation, is also used technically to denote the institution of criminal proceedings against a party. There are two ways in which a prosecution commences in England. One is to summon, or, in the graver cases, to arrest and bring the offender before a justice of the peace, when the witnesses are examined, and if the justice thinks a *prima facie* case is made out, he commits the offender for trial. Another way is without any such preliminary inquiry before a justice, for the prosecutor to go with witnesses before a grand jury, and in all cases this is a step in the prosecution. The grand jury hear the witnesses, and if they think there is a *prima facie* case, they find a true bill; if otherwise, they ignore the bill. The bill means an indictment. When the indictment is found, the prisoners are arraigned at the bar, and asked by the judge whether they plead guilty or not guilty; and in general they plead not guilty. A jury of twelve are then sworn, and try the case, and find a verdict of guilty or not guilty, whereupon the judge sentences the prisoner to punishment, which varies according to the enormity of the offence. In general, a new trial cannot be held in criminal cases, though, if an error is committed, the conviction is often quashed.

**PROSECUTOR** is the person who takes the initiative in punishing crimes. In England, there is no public prosecutor, and the prosecution of crimes is left to the spontaneous action of the injured party. Hence it often happens that many crimes go unpunished, for the mere want of its being anybody's business to attend to this part of the public interest. It is true that the attorney-general is sometimes the prosecutor on behalf of the public, but this only happens in rare and exceptional cases connected with political government or some monstrous and abnormal crime. In all cases, therefore, it may be accurately stated that it is left to the uncontrolled discretion of anybody to commence a prosecution, however great a stranger to the circumstances. But though he may take the initiative, yet in the ordinary course, a stranger seldom undertakes such a duty, and for very sufficient reasons. If a party is robbed by a servant or clerk, or by burglars, he naturally desires to prosecute them; if a person is murdered, some one of the relatives naturally prosecutes. Therefore, there is in most cases a sufficient motive impelling some party, or friend of the party injured by the crime, out of mere revenge, if for no other reason, to commence a prosecution. But it follows that, as there is no public prosecutor, and as he who acts as such is a volunteer, he does so more or less at his own expense, and in the first instance must always do so. He must employ his own attorney and counsel, who, of course, require to be paid for their services. It is true that the expenses of prosecuting most crimes are supposed to be ultimately repaid by the county in which the trial takes place; but this allowance is a wretched pittance, and is seldom one-fourth of the real expenses incurred by the private prosecutor. Hence, in the end, the prosecutor finds that he loses a great deal of money as well as time in carrying on a prosecution. Indeed, in practice, the result is, that no person to whom his money is of much consequence ever prosecutes a second time, and the first time he almost invariably does so in ignorance of the pecuniary result, there being a vague kind of popular belief that the expenses are repaid. Few people, indeed, fail to

repent of embarking in such a litigation; and the prudent and experienced are in the habit of remarking, that prosecutions are only kept going by the unbroken succession of young and inexperienced persons who do not know better. A person who prosecutes a small larceny of five shillings may incur expenses of from five to fifteen pounds, which is money out of pocket when his attorney's bill is paid. But not only is there great expense and loss in the mere prosecution itself; there are far more grievous consequences. If it happen—and it seems in about half of the cases it really does happen—that the prisoner is not found guilty, or the case breaks down from defective evidence or otherwise, the first thing that the prisoner does is to bring an action for false imprisonment or for malicious prosecution, against the prosecutor. It is said that attorneys infest all the police courts and petty sessions, by keeping an organised service of watchers to pick up cases of this kind, which are called speculative actions. The speculative attorney promises to take the chance of gaining the action, and, of course, as it costs the prisoner nothing, he readily lends his name, and, out of revenge, joins keenly in the attempt to recover large damages. It is true that in all such cases the prosecutor ought not in theory to lose the verdict, if he acted under a reasonable and honest belief that a crime had been committed; but however plausible this defence may be in theory, it is a very different thing to establish it in practice. At the trial of the action, counsel on such occasions enlarge on the monstrous oppression of having given an innocent man into custody, blasting his character and reputation for life, and attributing the prosecution to spite or malice; and as the presumption is always in favour of innocence, it is astonishing how easily a jury may be led away by a spurious sympathy in favour of the quondam prisoner. It is thus entirely a lottery in such cases how the verdict will go, and verdicts of ten, fifty, or a hundred pounds of damages are often obtained, simply because of the accidental defect of some conclusive piece of evidence, with which the defendant in the action had probably no more to do than any other person. When the quondam prosecutor is a person of substance and position—and, of course, a speculative attorney will not sue those who are not so—he often finds it prudent to compromise the action by paying a lump sum, rather than run the risk of a trial. Many attorneys in the metropolis and large towns of England carry on a large and lucrative business by systematically bringing these speculative actions against unsuccessful prosecutors. The evils of this state of the law have been often complained of, but have not yet been remedied, probably because other systems of prosecuting crime are open to objections.—In Scotland, a well settled system of public prosecutors has long been in operation, which avoids most of the evils already described. The Lord Advocate is *ex officio* the public prosecutor, and there are counsel called advocates-depute who assist him, besides a local functionary called a Procurator-Fiscal (q. v.) in all parts of the country. The public prosecutor's duty and business is to act on all reasonable suggestions that a crime has been committed, but he is not compelled to prosecute. If he refuse to do so, a private party may at his own risk, with the concurrence of the Lord Advocate, insist on the prosecution; but he may be called on to find caution or give security. The usual course is for the procurator-fiscal to take the precognitions; i. e., the examination of witnesses before the sheriff, a copy of which is laid before the crown-counsel, and if they are satisfied that a *prima facie* case is made out,



the proceeding is carried on to trial; but if there is not sufficient evidence, the prisoner is ordered to be at once discharged. The entire expense of prosecuting crime in Scotland, whether at the higher or local tribunals, is borne by the public; the persons specially injured having nothing whatever to do in the matter except to appear as witnesses when called upon. This system has worked for three centuries with entire satisfaction.

**PROSELYTES** (Gr. *pros-elytos*, one who comes from without, a stranger; Hebr. *Gerim*) was the name given by the Jews to those heathens who became converts to Judaism. There were two kinds of proselytes distinguished: 'Proselytes of the Gate,' that is, heathen strangers, who, in order to be allowed to reside in Palestine, had undertaken to submit to the 'Seven Commandments of the Sons of Noah,' that prohibit blasphemy, idolatry, murder, incest, theft, disobedience to the authorities, and the eating of flesh with the blood on it: commandments which probably had grown out of certain restrictions originally put upon the 'strangers' by the Mosaic Law (Exodus, xii. 19; xx. 10, &c.). These 'Proselytes of the Gate,' or 'Sojourners,' could not claim all the privileges of an Israelite, could not redeem their first-born, and, at a later period, were not allowed to live in Jerusalem; yet they were permitted to offer whole burnt-offerings, and otherwise contribute towards the religious wants of the commonwealth. The second class of proselytes was formed by the *Gere hatsedet* (Pious Proselytes), or *Gere haberith* (Proselytes of the Covenant). These accepted all the dogmas and customs of Judaism to their fullest extent, and were called 'Complete Israelites.' The new candidates were first strictly asked for their motives, and the classification of those who were not to be admitted runs as follows: those whose motive is love (husband for the sake of following his wife's faith, or *vice versa*); Proselytes of the Tables of the Kings (i. e., those who covet court-favour); Esther-Proselytes (who wish to escape some threatening danger, cf. Esther, viii. 7); and Lion-Proselytes (those who, from a superstitious fear, wish to enter Judaism, like the Samaritans, 2d Kings, xvii. 26). If, on the other hand, the motives were satisfactory, the candidate was further cautioned against attaching himself to a persecuted people, and warned that sufferings of all kinds would be his lot in this life. If all this did not deter him, he was 'brought under the wings of God.' He was fully instructed in the religion and history of the people, and shewn the special Providence that guided them and watched over them. If a male, he was circumcised, and, in case of his being circumcised already (for instance, if he belonged to another nation practising this rite), a few drops of blood were drawn 'from the blood of the covenant,' a special prayer was said for him, and a new name was given to him, while for that of his father, Abraham was substituted. After the healing of the wound, Baptism (Tebillah) followed, and he had further to offer up a Sacrifice (Korban). Females had likewise to undergo baptism and to bring a sacrifice. All natural relations were then cancelled, the Proselyte was considered like 'a new-born child,' and the Holy Ghost was supposed to come upon him.

The desire to proselytise, which became strong among the political leaders during the Maccabean period, and which led to the 'bringing into the Congregation' of entire nations, such as the Idumæans under John Hyrcan, the Iturians under Aristobulus, contrasted strongly and most characteristically with the utter contempt in which the new-comers were held by the people, and with the suspicion with which they were regarded, and

their (after all) limited social rights and ambiguous position. The Talmud speaks of them in no measured terms, and there is no doubt that, on the whole, they must have acted a very dubious part. They were called the Leprosy of Israel; it was the Proselytes and other reprobates who stood in the way of the coming of the Messiah; and up to the twenty-fourth generation were they to be distrusted. Yet, notwithstanding all this, conversions were very frequent, especially among the better classes—and here, again, among women principally—in Damascus, Greece, Asia Minor, Rome; so much so, that even the Roman legislation was compelled, in the 1st c. a. d., to provide for cases of Judaizers. It is a curious fact, worth remembering, that one of the main features of the times of the Messiah was to be, according to Jewish tradition, the utter abolition of proselytism, and the entire ceasing of all distinctions of an opprobrious nature among men. The evil repute into which the term Proselyte had fallen in the times of Christ also caused the early converts to Christianity to adopt the name of Neophytes (newly planted) instead.

**PROSERPINA**, the Latin form of the Greek PERSEPHONE (also PERSEPHATTA, PERSEPHASSA, PHEREPHASSA; in Homer, PERSEPHONEIA), was, according to the common myth, the daughter of Zeus and Demeter (Ceres) or of Styx. The story of her abduction by 'gloomy Dis,' while gathering flowers on the plains of Enna, in Sicily, in company with Artemis and Athena, does not occur in Homer, who simply represents her as the wife of the king of Hades, and as the majestic queen of the Underworld—a subterranean Hera (Juno). It is first given by Hesiod, and is manifestly an allegory of the seasons. See CERES. In the mystical Orphic Hymns, P. appears as the all-pervading goddess of nature, who produces and destroys everything, and she has been mixed up and identified with other mystical goddesses, Rhea, Artemis, Hekate, &c. She was generally worshipped under the name of *Kore*, 'maiden,' along with her mother Demeter. The chief seats of her worship were Sicily and Magna Græcia; but she had also temples at Corinth, Megara, Thebes, and Sparta. In works of art, P. is represented sometimes as the grave and earnest spouse of Pluto, sitting on a throne beside her sombre husband, with a sceptre and a little box; but more frequently as a blooming virgin, the picture of her mother, in the act of being carried off to Hades.

**PRO'SODY** (Gr. *prosdia*, literally, 'belonging to song or hymn') is the name given, both by the ancients and moderns, to that part of grammar which treats of the rules of rhythm in metrical composition. See METRE, RHYME, BLANK VERSE.

**PROSPECT**, in Roman Law, was recognised as a legal incident of a house, or an urban servitude, so that no adjoining owner was entitled to obstruct the prospect or view of a man's house. But if this meant more than that the light should not be sensibly obstructed, it is not recognised in English or Scotch law. See LIGHT.

**PRO'SSNITZ**, a manufacturing town of Austria, in Moravia, in the fruitful plain of Hanna, stands on the Rumza, 12 miles south-west of Olmütz. It contains a convent, and a linen, and several cloth factories. Brandy is extensively distilled. Pop. 11,400.

**PROSTITUTES, LAW AS TO.** It is not an offence, in this country, for a person to carry on a course of prostitution in his or her own person; but when others are incited, or forced to that course, it may become so, in certain circumstances. Thus,

for a person to keep a disorderly house, is an indictable offence, which is punishable by fine and imprisonment, and the parish officers in England are bound to institute the prosecution, the expenses of which are paid out of the poor-rates. It is, however, only the person who keeps the house who is punishable, and no punishment can be imposed on the frequenters of the house in any circumstances. The law may be said to be passive so far as the mere fact of prostitution or immoral intercourse is concerned, and gives neither party any remedy against the other, civil or criminal, arising out of that state of the relations between man and woman. Thus, if a man give a woman a bond, providing her an annuity in consideration of her living with him in concubinage, the law will not enforce it, because it is an immoral consideration. So, if a woman take lodgings, or buy dresses, for the purpose of carrying on a course of prostitution, the law will not enforce the payment of rent, or the price of the goods sold, because the tendency is immoral. In some countries, as in France, the law takes direct cognizance of the fact of prostitution, and deals with prostitutes for various sanitary purposes; but in this country, the subject was entirely ignored, except indirectly in the cases above-mentioned, and until 1864, when a statute was passed, which to a certain extent introduced the French procedure. The statute 27 and 28 Vict. c. 85, applied only to certain naval and military stations—viz., Portsmouth, Plymouth, Woolwich, Chatham, Sheerness, Aldershot, Colchester, Shorncliffe, the Curragh, Cork, and Queenstown, but not to Scotland. In those places a justice of the peace may now, on information, order a woman to be taken to a certified hospital for medical examination; and if she is found to have a contagious disease, she may be detained in the hospital for medical treatment during not more than three months. A woman who refuses to submit to examination, or leaves the hospital without being duly discharged, is liable to be imprisoned for one or two months; and occupiers of houses alluring prostitutes to frequent their houses when having a contagious disease, incur a penalty of £10, or three months' imprisonment.

**PROSTYLE.** A temple with a portico in front. When it had a portico at both ends, it was termed amphiprostyle.

**PROTAGORAS,** the Greek Sophist, was a native of Abdera, where he was born of humble parentage, probably about 480 B.C. He was the first who took the name of 'Sophist,' or taught for pay. When he went to Athens, is not precisely known; but he is conjectured to have gone thither about the middle of the century, and he seems to have enjoyed the friendship of Pericles. Accused of atheism by one of his own scholars, he was banished from Athens, and his writings were ordered to be publicly burned. He died, probably in 411 B.C. The basis of his speculation is the proposition, that 'man is the measure of all things,' which was developed by him in a way that involved the most thorough-going scepticism. The *Theætetus* and *Protagoras* of Plato are devoted to a refutation of P.'s doctrines, which, as delineated by the great philosopher, appear shallow, confused, and untenable. All P.'s works are lost, though some were extant as late as the time of Porphyry.

**PROTEACEÆ,** a natural order of exogenous plants, containing about 650 known species of shrubs and small trees, chiefly natives of South Africa and of Australia, and forming a remarkable feature of the vegetation of these regions. Some of them, as species of *Protea* and *Banksia* (q. v.), are frequently

cultivated in gardens and greenhouses, being prized for their singular and elegant appearance, and their curious and often beautiful flowers. They have usually umbellate branches; their leaves are evergreen, and remarkably hard, dry, and woody, divided or undivided, and without stipules. The perianth is four-leaved or four-cleft; the stamens, four, one of them sometimes sterile, perigynous, opposite to the segments of the perianth; the ovary superior, consisting of a single carpel; with one, two, or many ovules; the style simple, the stigma undivided; the fruit dry or succulent, and opening or not opening, many fruits often collected in a kind of cone. The timber of some of the larger species is used for various purposes; others supply much of the firewood of the Cape of Good Hope and Australia. The nuts or seeds of some are eaten, as those of *Brabejum stellatum* in South Africa, and of *Guevina Avellana* (also called *Quadrifida heterophylla*) in Chili. Those of the latter are much esteemed, and are called *Avellans* and *Nebu*.

**PROTECTION—PROTECTIVE DUTY,** in Political Economy, terms applied to a practice, now in disuse in Britain, of discouraging, by heavy duties and otherwise, the importation of foreign goods, under the notion that such a practice increased the prosperity of the country at large. See **FREE TRADE**.

**PROTECTOR,** a title which has sometimes been conferred in England on the person who had the care of the kingdom during the sovereign's minority. The Earl of Pembroke was Protector in 1216, in the minority of Henry III. Humphry, Duke of Gloucester, held the same office in the minority of Henry VI., from 1422 to 1447. Richard, Duke of Gloucester, was Protector in 1483, prior to his ascending the throne as Richard III. The Duke of Somerset, one of King Henry VIII.'s sixteen executors, was in 1548 constituted Protector during the minority of Edward VI., with the assistance of a council, consisting of the remaining fifteen executors; a dignity, however, which he enjoyed but a few months. Oliver Cromwell, in December 1653, took the title of Lord Protector of the Commonwealth of England, Scotland, and Ireland. In 1658, his son Richard succeeded to his title and authority, but was never formally installed in the Protectorate, which he resigned in the following year.

**PROTEIN AND THE PROTEIN BODIES.** Under the term *Protein Bodies*, chemists include the following substances: Albumen, Fibrin, Syntonin or Muscle-fibrin, Casein, Globulin, and Hamato-crystallin. Albumen, fibrin, and casein are common both to the animal and vegetable kingdom; while the three others occur only in the animal kingdom (namely, in muscular tissue, in the crystalline lens of the eye, and in the blood-cells). The most careful analyses have shewn that in their composition, these substances are almost identical, and that they all contain about 53·6 per cent. of carbon, 7·1 of hydrogen, 15·6 of nitrogen, and 22·1 of oxygen, with a varying quantity of sulphur not exceeding 1·6 per cent. These substances are as similar in many of their properties, and in the products of their decomposition, as in their ultimate composition, and hence chemists were naturally led to entertain the view that they possessed a common radical. Mulder (q. v.) announced, in 1833, that he had discovered this radical, which, from its importance, he named **PROTEIN** (Gr. *protéuo*, I hold the first place), and that he had found that albumen, fibrin, casein, &c. (which at that period were known as the *albuminous bodies*, the *albuminoid group*, or the *albuminales*), were combinations of

## PROTEST—PROTEUS.

this protein with sulphur and phosphorus, or simply with sulphur. The composition of this protein is represented according to the discoverer, by the formula  $C_{25}H_{25}N_5O_{10}2HO$ . Liebig and several of his pupils have, however, shewn that Mulder's protein always contains a small but variable amount of sulphur; and they deny, on what are generally deemed sufficient grounds, the existence of protein as a separate body. The term *protein bodies*, or *protein compounds*, is, however, commonly retained both by physiologists and chemists, as being the most convenient one for representing a class of compounds, which, whether Mulder's theory is correct or not, deserve their name from their constituting the group which form the most essential articles of food.

The **PROTEIN BODIES** may be generally described as nearly colourless, neutral, nitrogenous bodies, soluble in potash solution, and not yielding gelatin when boiled with water. They all present two modifications, differing essentially from one another; in one of which they are soluble, and in the other nearly or quite insoluble. They exist naturally only in the soluble modification, although not necessarily in a state of solution. Most of them are transformed into the insoluble state by boiling, by the mineral acids, and by numerous salts; and one of them, fibrin, undergoes this modification on simple removal of the blood, or other fluid containing it, from the organism. This passage from the soluble into the insoluble form, is termed *coagulation*, but we do not know what chemical change takes place in the process.

The *soluble protein bodies*, in their dried state, form pale yellow, translucent masses, devoid of smell and taste, which are soluble in water, but insoluble in alcohol and ether. They are precipitated from their watery solutions by alcohol, by the mineral acids, by tannic acid, but not by the vegetable acids generally; and by many mineral oxides and salts. The *insoluble protein bodies*, when freshly precipitated, are of a white colour, in flakes or small clots, or viscid and glue-like: when dried, they may be reduced to a whitish powder.

The products of the decomposition of the protein bodies are very numerous, and the study of these products is of great importance, as tending to elucidate the changes which the tissues undergo in the body during their disintegration.

**PROTEST** is in law a legal document, drawn up by a notary-public, giving notice of some act of a public nature, as the protest of a bill of exchange.

**PROTESTANT**, a term first applied to the adherents of Luther, from their protesting against the decree passed by the Catholic states at the second diet of Speier in 1529. This decree had forbidden any further innovations in religion, and enjoined those states that had adopted the Reformation so far to retrace their steps as to reintroduce the Mass, and order their ministers to avoid disputed questions, and to use and explain the Scriptures only as they had hitherto been used and explained in the church. The essential principles involved in the protest, and in the arguments on which it was grounded, were: 1. That the Catholic Church cannot be the judge of the Reformed churches, which are no longer in communion with her. 2. That the authority of the Bible is supreme, and above that of councils and bishops. 3. That the Bible is not to be interpreted and used according to tradition or use and wont, but to be explained by means of itself—its own language and connection. As this doctrine, that the Bible, explained independently of all external tradition, is the sole authority in all matters of faith and discipline,

is really the foundation stone of the Reformation, the term Protestant was extended from those who signed the Speier protest, to all who embraced the fundamental principle involved in it; and thus Protestant churches became synonymous with Reformed churches. The essence of Protestantism, therefore, does not consist in holding any special system of doctrines and discipline, but in the source from which, and the way in which it proposes to seek for the truth in all matters of faith and practice; and thus a church might, in the progress of research, see reason to depart from special points of its hitherto received creed, without thereby ceasing to be Protestant. The Symbols or Confessions of the Protestant churches were not intended as rules of faith for all time, but as expressions of what was then believed to be the sense of Scripture. When, at a later time, it was sought to erect them into unchangeable standards of true doctrine, this was a renunciation of the first principle of Protestantism; and a return to the Catholic principle; for, in making the sense put upon Scripture by the Reformers the standard of truth, all further investigation of Scripture is arrested, the authority of the Reformers is set above that of the Bible, and a new tradition of dogmas and interpretation is created, which differs from the Catholic tradition only in beginning with Luther and Calvin, instead of with the apostolic fathers. See **REFORMATION**.

**PROTEUS**, in the Homeric or oldest Greek mythology, appears as a prophetic 'old man of the sea' (*halios gerōn*), who tends the seal-flocks of Poseidōn (Neptune), and has the gift of endless transformation. His favourite residence, according to Homer, is the island of Pharos, off the mouth of the Nile; but according to Virgil, the island of Karpathos (now *Skarpanto*), between Krete and Rhodes. Here he rises at mid-day from the floods, and sleeps in the shadow of the rocky shores, surrounded by the monsters of the deep. This was the time when those who wished to make him prophesy sought to catch him. But it was no easy task. P., unlike most vaticinal personages, was very unwilling to prophesy, and tried to escape by adopting all manner of shapes and disguises. When he found his endeavours hopeless, he resumed his proper form, and then spoke out unerringly about the future.

**PROTEUS**, a genus of perennibranchiate Batrachia (q. v.), having a long, smooth, naked, eel-like body; four small and weak legs; the



*Proteus (P. anguinus).*

fore-feet three-toed—the hinder, four-toed; the tail compressed and forming a kind of fin; the head lengthened and flattened; the eyes extremely small, and covered by the skin; the ears concealed in the flesh; the gills external and permanent, reddish, very conspicuous, between the head and the fore-legs. Notwithstanding the permanent external

## PROTEUS—PROTO-NOTARY.

gills, there are also lungs in the form of simple slender tubes, terminated by a vesicular dilatation. The only known species, *P. anguinus*, is found in subterranean lakes, in the great limestone caverns in Carniola. It seems to live chiefly in the mud which forms the bottom of the lakes or pools; but almost nothing is known of its habits. It is of a pale rose or flesh colour, 10 or 12 inches long, seldom above half an inch in thickness. Specimens have been kept alive in confinement for several years, in a darkened aquarium, apparently without food. One which ate a worm died soon after. The blood-corpuscles of the *P.* are extremely large.

**PROTEUS**, a name given by many naturalists to certain animalcules remarkable for changefulness of form; on which account also, as the name *P.* has been otherwise appropriated in science, they now receive the generic name *Amœba* (Gr. vicissitude).

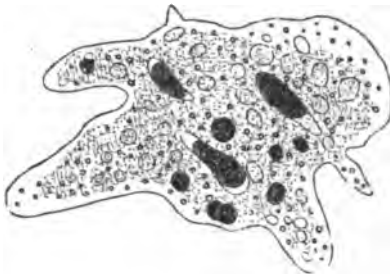

Proteus or Amœba (very highly magnified).

They are *Protozoa*, and ranked among the *Rhizopoda*. See these heads. They are found in fresh water, and are generally from  $\frac{1}{100}$ th to  $\frac{1}{50}$ th of an inch in diameter, when they assume a somewhat globose form, which, however, they exchange for almost every imaginable shape, so that they cannot be described as having any proper or definite shape whatever. They are of a soft gelatinous substance, and in their movements, seem to flow over objects rather than to crawl, or even glide. Yet when one of them is divided by a knife, there is no perceptible escape of any fluid, but each part shrinks up, and becomes a separate individual. They multiply by spontaneous division, or by detaching a lobe from the body; but a true reproduction by ova has also been discovered, the parent becoming a mere sac for the ova, and perishing. Their organisation is very imperfectly understood. The diaphanous substance of which they consist (*sarcodæ*) is, except in young individuals, full of minute corpuscles or granules; there are also to be seen in it empty spaces (*vacuoles*) of no very definite form. For locomotion, a portion of the substance of the creature is protruded, often to a very considerable length, and the rest of the body seems to be drawn after it. There is no mouth, stomach, or alimentary cell; but the organic particles or minute animalcules which serve for food are surrounded by the jelly-like substance, and speedily absorbed into it, every part being apparently equally adapted for finding and using food in this way, as well as for locomotion.

**PROTOCOCCUS** (Gr. first-grain), a genus of *Palmellaceæ* (q. v.), to which Red Snow (q. v.) is commonly referred.—Another species is *P. pluvialis*, not unfrequent in stagnating rain-water. It passes through various stages of growth, in which it has been described under various generic and specific names. In some of its stages, in which it moves by means of two long cilia, it has often been mistaken

for an animalcule. Its colour is usually green, but sometimes red; and the red matter often appears as a mere central nucleus, which has been mistaken for the eye of the animalcule. In its ordinary form, it consists of a mass of colourless *protoplasm* (see *CELLS*), with red or green granules diffused in it, surrounded by a *primordial utricle* (see *CELLS*), and undergoing division into halves, which are soon surrounded by separate envelopes, and undergo division again; the new cells thus formed, and they are formed with great rapidity, being sometimes set free by the dissolution of the original enveloping membrane, more frequently remaining imbedded in a gelatinous substance formed from it. The new cells often send forth two vibratile filaments or cilia, which spring almost from one point, often a kind of beak; and move with considerable rapidity; and in this state also, they multiply by binary subdivision; or they rest, become *encysted*, and divide into four. If slowly dried, the *P. pluvialis* retains life, and resumes its functions when again moistened.

**PROTOCOL** (Gr. *prôtos*, first, and *kolla*, glue), a word used in two senses: 1. The rough draft of an instrument or transaction; and more particularly the original copy of a government dispatch, treaty, or other document. 2. A record or register. In Scotland, every notary, on admission to office, formerly received from the Clerk-register a book called his protocol, in which he was directed to insert copies of all the instruments which he might have occasion to execute, to be preserved as in a record. At one time, these protocols were attempted to be made available as records of sasines, but many causes operated to prevent their being thus used; they have, however, often been found serviceable, when regularly kept, to supply the loss of a missing deed.

**PROTOGENE** (Gr. first-born), a granitic rock, composed of the same ingredients as true granite, except that the mica is replaced by talc. It received its name because it was supposed to have been the *first-formed* granite. It abounds in the Alps, and is found also in Cornwall. The clay produced by its decomposition is greatly valued for the manufacture of china.

**PROTOGENES**, a celebrated painter of ancient Greece, was born at Kaunos in Caria, and practised his art at Rhodes. Very little is known concerning him, except that he was a contemporary of Apelles, who was the means (see *APELLES*) of first drawing the attention of the Rhodians to his extraordinary merits. Pliny says that when Demetrios Poliorketes was endeavouring to conquer Rhodes, he took the utmost precautions to prevent any injury from happening to the studio of *P.*, who then lived in a little cottage (*casula*) on the outskirts of the city, and even stole away at times from the turmoils of the siege to visit the painter, quietly and earnestly pursuing his work amid 'the din of arms and the thunder of the battering-engines.' *P.* died about 300 B.C. He was a careful and elaborate painter, sparing no pains to secure a brilliant, natural, and finished piece of workmanship; and was apparently held in the highest estimation by the ancients. Cicero says that his pictures were perfect in every respect. The principal were 'A Satyr resting and holding his Pipes;' 'The *Paralos* and *Ammonias*' (or sacred ships of the Athenians, executed for the Propylææ at Athens); and 'The *Theamothetæ*' (for the Athenian Senate-house of the Five Hundred).

**PROTO-NOTARY** (Gr. *prôtos*, first, and Lat. *notarius*, notary), the name given to a notary appointed by the Holy See. Among the officials of the court of Rome is a body, twelve in number,

called the College of Notaries, who are to be distinguished from honorary or extraordinary apostolic notaries. The former are said to date from a very early time, and are charged with the official registration of all the solemn acts of the pope, whence they have a very special duty in relation to canonisations of saints, &c. Their number was fixed by Sixtus V. at twelve, and they enjoy many privileges. An apostolic notary-extraordinary, although called proto-notary, does not enjoy the same privileges. The proto-notary extraordinary may be named not only by the pope, but also by a LEGATE (q. v.), and under certain restrictions, by the Roman College of Notaries.

**PROTOPHYTES** (*Protophyta*, Gr. first plants), a name now frequently employed to designate the lowest or simplest organisms in the vegetable kingdom, corresponding to the *Protozoa* of the animal kingdom. They are regarded as among the *Algae* (q. v.). Many of them are mere simple cells, which multiply by division, although perhaps they may yet be found to have also another mode of reproduction; others consist of cells united by a gelatinous substance, and the aggregate in some is a shapeless mass; in others, a plant-like structure, the form resulting from the mode in which the division of cells takes place. In none of them do the cells assume determinate characters in any part of the structure, so as to constitute different organs; in which they differ from all higher plants. It is sometimes very difficult to distinguish P. from *Protozoa*; and perhaps the surest distinctive character is the nature of their food. Some of the *Protozoa*, having no mouth, as the *Proteus*, or *Amoeba*, might be regarded as plants rather than animals; but they subsist by consuming organic particles, vegetable or animal, whilst P. live by appropriating inorganic substances, chiefly from the air or water around them. Among the P. are *Palmellaceæ* (q. v.).

**PROTOPLASM.** See **CELLS**.

**PROTOZOA** (Gr. *proton*, first, and *zōon*, animal), constitute the lowest animal subkingdom, and include a large number of animal beings of the lowest and simplest type of organisation. Their bodies consist either of a simple cell or of an aggregation of cells, each of which seems to retain its independent existence. In none of the P. can a nervous system, or organs of sense, be detected; and except in one group (the *Infusoria*), there is no trace of a mouth. Excepting the sponges, they are generally of very minute size, and only to be observed with the microscope; and excepting a few that inhabit the bodies of other animals, all are aquatic animals. They generally present the appearance of a transparent gelatinous cell, containing a nucleus; in addition to which, one or more clear pulsating spaces, termed *contractile vesicles*, may be frequently seen. Excepting the infusoria, none present true reproductive organs, reproduction being usually accomplished by fissure. They are divisible into the following groups or classes, each of which is noticed in a separate article: (1) *Gregarinidae*, (2) *Rhizopoda*, (3) *Spongiae*, and (4) *Infusoria*; to which Green, in his *Manual of Protozoa*, adds *Polycystina*, and *Thalassicollides* (both of which are commonly included in the *Rhizopoda*).

**PROUD-FLESH** is the popular term for coarse and too luxuriant Granulations (q. v.) springing up on wounds or ulcerated surfaces. Such granulations must be treated with nitrate of silver or sulphate of copper, either in the solid form or in strong solution.

**PROUDHON, PIERRE JOSEPH**, a noted French publicist and speculator on social and political

subjects, was born July 15, 1809, at Besançon, in which town his father was a poor cooper. Through the good offices of charitable friends, he received the rudiments of his education at the college of his native place, and from the first gave great promise of talent. While still very young, however, he quitted the institution in order to aid his family, which had fallen into great distress, and sought employment in a printing establishment. Here he was noted for the most punctual discharge of duty; and in the hours not occupied in work, he contrived, by a rare exercise of resolution, to complete and extend his education. In 1830, he declined an offer of the editorship of a ministerial journal, preferring an honourable independence as a workman, to the career of a writer pledged to the support of authority. He became partner in 1837 with MM. Lambert and Maurice in the development of a new typographical process; was engaged on an edition of the Bible, to which he contributed notes on the principles of the Hebrew language; and in 1838, published an *Essai de Grammaire Générale*; in approval of which, a triennial pension of 1500 francs was awarded to him by the Académie de Besançon. On this accession of funds, he paid a visit to Paris; and subsequently contributed to the *Encyclopédie Catholique* of M. Parent Desbarres the articles *Apostasie*, *Apocalypse*, and others. In 1840, he issued the work entitled *Qu'est-ce que la Propriété?* which afterwards became so famous. The nature of the doctrine announced in it is sufficiently indicated in its bold paradox, soon to be widely popularised—*La Propriété, c'est le Vol*. At the moment, it attracted little notice; and the sole results to its author were the withdrawal of his pension by the Academy, on the score of his noxious opinions, and the threat of a prosecution, which, however, was departed from, at the instance of M. Blanqui, the political economist, to whom reference in the matter was made. In 1842, for a repetition of offence in his *Avertissement aux Propriétaires*, he actually was prosecuted before the Cour d'Assises of Besançon, but succeeded in obtaining an acquittal. From 1843 to 1847, P. was employed at Lyon, under MM. Gauthier, in the superintendence of a scheme of water-transport on the rivers Saône and Rhône; publishing during this time at Paris the two works entitled *De la Création de l'Ordre dans l'Humanité*, and *Système des Contradictions Economiques*.

With the outburst of the Revolution of February 1848, the opportunity of P. had arrived. He instantly repaired to Paris, and on the 1st of April, he came before the public as editor of the *Représentatif du Peuple*, instantly, by his fierce and vigorous advocacy of extreme democratic and socialistic opinions, making his mark as a leading figure of the hour. His paper was suppressed in August following; but meantime, on June 4, no less than 77,094 enthusiastic admirers had voted him into the Constituent Assembly as representative of the department of the Seine. His career as a senator, if brief, brought him at least notoriety. *La Propriété, c'est le Vol*, though a maxim much commending itself to the moral sense of the hungry masses, naturally failed to find like acceptance with an audience mostly with some sous in the pocket. P. soon ceased to address the Assembly, for, so soon as he ascended the tribune, the indignant roar which saluted him rendered audible speech impossible. Under these circumstances, P. once more betook himself to his pen, and, as editor of three daily journals in succession, avenged himself on the adversaries who declined *viâ voce* to listen to him, the chief victims of his savage personalities being MM. Ledru Rollin, De Lamartine, Louis Blanc, Considérant, Cavaignac, &c. All three papers—*Le Peuple*

## PROUT—PROVERBS.

(November 23, 1848—April 1849), *La Voix du Peuple* (October 1849—May 1850), *Le Peuple de 1850* (June 16—October 13) —were in turn suppressed as anarchic and obnoxious. During their continuance, he was repeatedly subjected to fines, which were defrayed for him by popular subscription.

In January 1849, he attempted a reduction of his theories to practice by the institution of a *Banque du Peuple*. This project, which had for its object the suppression of capital, speedily experienced at the hands of 'capital' the fate it had intended to inflict. The bank was closed by authority, and its originator fled to Geneva, to escape threatened imprisonment. In June, however, he returned, and his next three years were passed in the prison of St Pelagia. While shut up there, he married. During his imprisonment, he gave to the world the works entitled *Confessions d'un Révolutionnaire* (1849), *Actes de la Révolution* (1849), *Gratuité du Crédit* (1850), and *La Révolution Sociale démontrée par le Coup d'Etat* (1852); the last of which is remarkable, in the light of subsequent events, for the clearness with which it states the alternative of *l'anarchie ou le Césarisme*, as pressed on Louis Napoleon, then president. In June 1852, he was set at liberty; and quitting Paris, no longer a desirable abode for such unquiet spirits, went to Belgium, where he continued to publish from time to time on his favourite subjects of speculation. He died in obscurity at Paris, January 19, 1865.

Monstrous as are the social theories with which, in the history of his time, the name of P. remains connected, his power as a writer is not to be denied. It may be questioned how far he was at any time the dupe of his own paradoxes, or blind to the utter insufficiency of the premises from which, with a show of scientific rigour, he evolved his portentous results. It is related that in the negotiation of his marriage, he was very sharply solicitous as to the disposal of certain property possessed by the lady; and that on her notary venturing some surprised allusion to the famous *La Propriété, c'est le Vol*, the philosopher gravely replied: 'Be pleased, my dear sir, on such an occasion as the present, to be, if possible, a little serious.'

PROUT, SAMUEL, painter in water-colours, was born at Plymouth in 1783. He evinced a strong love for nature at an early age. Mr Britton, when about to collect materials for his *Beauties of England and Wales*, engaged his professional aid; and his drawings made for Britton's work attracted so much notice in London, that he was induced to take up his residence in that city. In 1818, having been advised, on account of his health, which had always been delicate, to try a change of air, he went to Rouen by Havre; and the picturesque street-architecture and fine Gothic remains there made so strong an impression on his mind, that afterwards, his principal works were those in which architecture had a prominent place; and from time to time, in his after-career, he made excursions, ransacking every corner of France, Germany, the Netherlands, and Italy, for picturesque architectural remains. P.'s name is dear to all the artists and amateurs of this generation, for there are few who have not been incited or instructed by his numerous elementary drawing-books, in the slightest of which, talent and feeling for art are conspicuous. His water-colour drawings are characterised by decision — a handling, great breadth, and clear and pleasing colouring; good specimens are highly valued. He died at Camberwell on February 9, 1852. His character was amiable, and he was highly respected by his professional brethren.

PROVENCE, formerly a maritime province of France, in the extreme south-east of the country, was bounded on the S. by the Mediterranean, and comprised the modern departments of Bouches du Rhône, Var, Basses-Alpes, and the east part of Vaucluse. It included a portion of the territory belonging to the Roman province of Gaul generally called simply *Provincia* ('the Province'), whence it derived its name.

PROVERBS (Lat. *proverbium*, a common saying or word, Gr. *paroinion*, a way-side saying, corresponding to Eng. byword) are pithy, practical, popular sayings, expressive of certain more or less general convictions. The definitions of the proverb are almost as numerous as its own varieties of form. Aristotle speaks of them as 'remnants, which, on account of their shortness and correctness, have been saved out of the wreck and ruins of ancient philosophy.' Agricola considers them 'short sentences, into which, as in rules, the ancients have compressed life.' Erasmus holds them to be 'well-known and well-used dicta, framed in a somewhat out-of-the-way form or fashion.' Cervantes explains them as 'short sentences drawn from long experience.' Johnson talks of them as 'short sentences frequently repeated by the people.' Less definitions of, than general opinions on the proverbs, are sayings like that of Howell, that 'sense, shortness, and salt' form their component parts. They are 'the genius, wit, and spirit of a nation,' according to Bacon. 'The wisdom of many, and the wit of one,' according to Earl Russell. In them, it has been said, is to be found an inexhaustible source of precious documents in regard to the interior history, the manners, the opinions, the beliefs, the customs of the people; and their use has been strikingly pointed out by George Herbert, who entitled his collection of proverbs *Jacula Prudentium* (Darts or Javelins of the Wise), a term probably derived from Plato's *Protagoras*.

Yet there have, on the other hand, not been wanting those who, like Lord Chesterfield, have deprecated their use in polite society, on account of their occasional vulgarity, and recommended stilted sentences à la Larochevoucauld instead. Of these solitary voices, however, no more notice was ever taken than they deserve. From the earliest historical times, proverbs have been household words, not merely among the people at large, but among the greatest and wisest of men. The prodigious amount of sound wisdom and good common sense they contain, the spirit of justice and kindness they breathe, their prudential rules for every stage and rank, their poetry, bold imagery and passion, their wit and satire, and a thousand other qualities, have, by universal consent, made them the most favourite mode of imparting hints, counsels, and warnings.

Being emphatically sayings originated within or commonly adopted by the people, and handed down, in most cases, from the remotest antiquity, the question as to their origin and age is an exceedingly difficult one. Some of their sources have been pointed out in the responses of oracles, in the allegorical symbols of Pythagoras, in the verses of the ancient poets, in mythological tales, in historical events to which they allude. That they existed to a great extent before the times of which written records have reached us, is clear from the number of them which lie imbedded—as a kind of well-known quotations—in these records themselves; and what tends still further to increase the difficulty of giving them a kind of fixed habitation within a certain country or age, is the circumstance that the same proverbs are found, as it were, among all nations and at all ages. From the East they

were for the most part imported into Hellas, thence to Rome, and from thence they were scattered all over Europe, and partly brought back again, slightly altered, to the East. Even certain Jewish proverbs quoted by Christ and the apostles, which hitherto did not seem to offer any analogy in other languages, might be traced back to India, where they had existed for many long centuries before they found their way into the popular speech of Palestine and Babylonia, and thence into the Talmud. That the names of their authors should, as a rule, be lost, is not surprising; yet we do meet with single instances in which either the author of a proverb is well known, or others whose nationality and birthplace are easily recognised. In the former case, it is generally some memorable event in a celebrated man's life which is remembered in close connection with a certain striking sentence he then uttered. In the latter, the scenery, the circumstances, the history of a special country, may so unmistakably be pointed, that they leave no room for any doubts on the birthplace of the special proverb; and more than that, even the special period which gave it birth, may be recognised by some trace of its character, manners, fashions, and occupations. 'What is nearest and dearest to the heart of a nation, the aspect under which they contemplate life, how honour and dishonour are distributed among them, what is of good or of evil report in their eyes,' as a recent writer has it, will surely be apparent in their national proverbs. Thus, for instance, the Greek proverbs may be designated as being fraught with a thorough knowledge of their own mythology, poetry, and history, bearing testimony to the high intellectual training that ran through all classes. The Roman ones—fewer in number, as far as they are the genuine growth of their own soil—have much less poetry about them, and are also deficient in the refinement and delicacy which were indigenous to Hellas. On the other hand, the character of the people comes well out in the constantly reiterated lessons of frugality, patience, perseverance, independence they inculcate; the practical hints as to marriage, education; and the various pursuits of that busy, vigorous, energetic nation—and among which agriculture played a prominent part. Of the proverbs now in use among European nations—calculated at about 20,000—the Spaniards are supposed to have a very large, if not the largest proportion. They may be recognised by a certain *grandezza*, a stateliness and thoughtfulness, blended though they be with humour and irony; and by the spirit of chivalry, honour, and freedom with which they are filled. The Italian proverbs, which come next as to quantity, are, to a certain extent, replete with a certain shrewdness and selfishness; and while they are fraught with unbridled passion, teach doctrines of cynicism and general distrust; yet, on the other hand, there are many of the noblest stamp, of a delicate refinement of beauty, of a subtle wisdom, teaching honour and honesty, plain-dealing and uprightness. In the same way, the French, the German, the English, as well as the Chinese and the Hindus, and every nation under the sun, impart a certain distinctive type and stamp to their homely sayings, which tells a distinct tale respecting their own inner life and national peculiarities. Of the Scotch proverbs, of which Kelly collected 3000, it has been said that there is a shrewdness, although deficient in delicacy, about them; that they are 'idiomatic, facetious, and strike home.'

Of the general utility of the proverb, it is needless to speak, after what we have said; we will only adduce the well-known frequent use made

of them for ethical purposes in Scripture, which contains an entire book of them, ascribed, for the greater part, to the Wise King himself; in the Midraah and Talmud, which contains, likewise, a whole collection of pithy sayings of the 'Fathers,' or Mishnan teachers, and out of which several later collections have been compiled; in the patriotic and later theological writers, who, like Luther, drew very largely upon these popular treasures.

Erasmus lays claim to be the first modern collector of proverbs, although Polydore Vergil, and not without a certain amount of truth, accuses him of plagiarism. His *Adagia* (Par. 1500) fired the learned in Europe with a desire to collect and to publish proverbs of their own countries. F. Nunez and the Marquis of Santellana edited Spanish *Refrances*; Florio, an Italian, *Giardino di Recreations* (1591); which was followed by the Italian collections of Angelus Monozini and Julius Varini. Ondin published French proverbs as *Curiosités Françaises*. The first real German (Nether-Saxon) collection is due to Johann Agricola, whose *Gemeine Sprichwoerde* appeared in 1528. In England, Camden, Herbert, Howell, Fuller, Ray, Kelly, Bohn, and others; in Germany, Weber, Sailer, Nopitzsch, &c., have issued national collections. Freytag and Burkhardt published *Arabic Proverbs*; Dukes, a small collection of Neo-Hebrew proverbs, &c. Thus, it may easily be seen, there is by no means a lack of material; and yet very little has been done towards the investigation and elucidation of the numerous points of interest connected with this subject. Diaraeli's *Curiosities of Literature* contain a valuable essay on the 'Philosophy of Proverbs,' from which (as also from Eiselein's *Sprichwörter und Sinnsreden*, 1840) Archbishop Trench has derived a great deal of information for his excellent little book, *On the Lessons in Proverbs*. Freytag's introduction to his collection of *Arabic Proverbs*, and that of Le Roux de Lincy to his French collection, make honourable exceptions to the general run of vapid prefaces to most modern collections.

PROVERBS, THE BOOK OF (Heb. *Mishle*, LXX. *Paromia Salomonos*, Vulg. *Proverbia*), a canonical book of the Old Testament, containing an anthology of gnomes and sentences, the fruit of reflections on the Mosaic law and on the divine guidance of the people of the Israelites. It is also called the 'Book of Wisdom,' in as much as it embraces the doctrines of the old covenant crystallised into religious maxims of thought, will, and action. Practical piety is enjoined under the name of 'Life,' while 'Death' represents sin throughout. The form of these proverbs is manifold—similes, enigmas, theses and antitheses, wise sayings, gnomes, comparisons, &c., vary constantly. The book is divided into three sections, to which the two last chapters form an appendix. The first section (chaps. i.—ix.) contains a description and a recommendation of Wisdom as the highest good obtainable, and is further subdivided into three portions. The second (x.—xxiv. 34) is equally in three portions, in the first of which the sentences are very loosely strung together; while, in the second, they are joined into more continuous utterances, sometimes running through several verses; and the third, which has the inscription: 'These, too, are of the wise men,' contains, again, some single sentences, principally in the form of commandments and prohibitions. The third section (xxv.—xxix.) is inscribed: 'These are also proverbs of Solomon, which the men of Hezekiah king of Judah copied out,' and is somewhat different from the former by the more predominant form of theses and antitheses, catch-words by which an association of ideas is produced, and similes. The

first chapter appended (xxx.) contains the proverbs of Agur, which, in a very artificial garb, teach the true wisdom and its practice in life; the second (xxxi.), inscribed: 'Words of King Lemuel, the prophecy that his mother taught him,' contains from verses 1—9 wise maxims for a king anent chastity and temperance, and from 10—31, the praise and properties of a good wife, in the form of an alphabetical song. Tradition has ascribed the authorship of this book to Solomon, 'the wisest of men;' but although neither the language, nor the structure, nor—as has principally been urged—the contents, are of a nature to convince us of the absolute necessity of assuming various authors and various epochs, there is no doubt a strong presumption in favour of this hypothesis. Who the Agur was that is mentioned as the author of the last chapter but one, is not easily conjectured. Equally unsatisfactory are the results of the speculations about the reputed author of the last chapter, Lemuel, by some supposed to be the brother of Agur. Probably it is nothing more than a symbolical name. The last section (xxx. 10—31)—an alphabetical acrostic—probably belongs to the 7th c. B. C., and by its language and form, does not appear to belong to the author of the preceding part of the chapter. The nucleus of the book is formed by the second section (x.—xxii. 16), to which the first (1.—ix.) was added by way of introduction, and the third as the concluding portion. Whether that first anthology (from the 3000 proverbs of Solomon mentioned 1 Kings, iv. 32) was collected and redacted (into section two) during Solomon's lifetime, is very doubtful; so much, however, is certain, that the learned men at the time of Hezekiah undertook their additional collection with a view to a then already-existing portion. It may not be superfluous to add, that Jerome, misled by 1 Kings, iv. 32, erroneously states our Book of Proverbs to contain the 3000 proverbs there ascribed to Solomon. The canonicity of the book is matter of controversy in the Talmud; there seems to have been at one time an objection to receive it among the number of sacred books, on account of certain contradictions contained in it; this objection, however, was overruled, and it occurs in the order of the Hagiographa (Kethubim) of the Masoretic Code, generally between Job and Ecclesiastes. The order followed in the Authorised Version had been adopted already in the time of Jerome.—Principal writers on P. are Ewald, Bertheau, Hitzig, Elster, Rosenmüller, Hirzel, Umbreit, M. Staart, and Dr Noyes.

PROVIDENCE, a city, semi-capital, and seaport of the state of Rhode Island, U.S., situated at the head of navigation, on an arm of Narraganset Bay, at the mouth of Providence River, 35 miles from the ocean, 43 miles south-south-west from Boston, and 173 east of New York. It is the second city in New England, covering nine square miles on both sides of the river, which, above its two bridges, expands into a cove, a mile in circuit, on the borders of which is a handsome park, shaded with elms. It is a city of large commerce, manufactures, and wealth, abounding with beautiful villas and gardens. Two small rivers afford water-power to extensive manufacturing establishments. There are three daily and weekly papers, the oldest of which was established in 1762; 53 churches, among them the oldest Baptist church in America, established in 1638 by Roger Williams, when banished from Massachusetts; hospitals and asylums; a state prison, which had, in 1860, 67 convicts, making cabinet-work and shoes, and earning 3000 dollars a year over their expenses. Among its institutions are: Brown University; an Athenæum, with a library of 25,000 volumes; a

liberally-endowed college of the Society of Friends; a Roman Catholic Institute; Historical Society; 4 grades of free schools; 38 banks; 18 insurance companies; several railways, uniting in one central station; several lines of steam-boats; 6 cotton factories, 3 woollen; 26 iron works; 7 bleaching and calendering mills; 3 screw-factories, making 5000 tons a year; and 86 manufactories of gold and silver ware and jewellery. P. was settled in 1636, by a colony of refugees from Massachusetts, under Roger Williams. Pop. in 1860, 50,666.

PROVINCIAL OF AN ORDER is the superior of all the houses, and all the members of a monastic order, within any particular province. The office is generally held for a stated term of years, and in most orders, the appointment to it rests with the General (q. v.).

PROVINS, an old town of France, in the department of Seine-et-Marne, 59 miles east-south-east of Paris, occupies a valley irrigated by two streams, the Darten and the Vouizie, whose waters are employed to turn 50 or 60 corn-mills in the district. It is surrounded by ancient walls, flanked by ruined watch-towers, and is divided into the high and low towns. In the former, is an ancient tower built during the middle ages, but vulgarly called the *Tour de César*. The vicinity was long famous for its roses, which are still cultivated to a considerable extent. Pop. 5609.

PROVISION (Lat. *provisio*, from *providere*, to provide), in Church Law, means the bestowing an ecclesiastical benefice, and involves two stages—the designation of the person on whom it is bestowed, and the actual collation (Lat. *collatio*) of the benefice, which is completed by his taking possession. Both these acts fall properly to the ecclesiastical authority; but by usage of a very early date, the state, and often individuals, are admitted to a share in the provision of ecclesiastical benefices. In the mediæval church, the claim of the sovereign to the provision of vacant bishoprics, was often the subject of contention with the popes (see INVESTITURE), but at all times the right of final and complete provision was admitted to belong to the pope. In later times, this claim has commonly been regulated by concordat. In most Roman Catholic countries, the crown elects to bishoprics, and the pope is bound to confirm the nominee of the crown, unless canonical cause of rejection should appear. In the Russo-Greek Church, the candidates are presented by the Holy Synod, and the czar names the bishop from among them. In Protestant countries, the election to benefices and dignities in the Roman Catholic Church is generally by the chapters; but in some of them, as in Holland, Prussia, Hanover, a qualified veto is permitted to the crown. In the Church of England, the bishop is nominally elected by the chapter; but, in reality, the members of the chapter are only permitted to name the particular person whom the crown presents to them for election with the *congé d'élire*. In the Roman Catholic Church of England and of Ireland, the parochial clergy, together with the canons, recommend three candidates, one of whom is commonly, although not necessarily, appointed by the pope. The conditions and usages of provision to parochial and other benefices, have been explained under the head INSTITUTION (q. v.). The completing act of provision is the installing in possession, which is described under the head INDUCTION (q. v.).

PROVISORS, STATUTE OF. The object of this statute, 25 Edward III. st. 6, was to correct, and put an end to, the abuses which had arisen in the exercise of the papal prerogatives as to the disposal of benefices in England. See BISHOP; PATRONAGE.



**PROVOST** (*Lat. propositus, set over*), in Church Law, the chief dignitary of a cathedral or collegiate church, from which use the title has also been transferred to the heads of other similar bodies, whether religious, literary, or administrative. Properly, however, the name is given to the highest dignitary in the metropolitan or diocesan chapter, and is often held conjointly with the archdeaconry. The provost is the next in dignity after the archbishop or bishop, a position which is also the right of the provost of a collegiate chapter. The name is also given to the superiors of certain religious houses of lesser rank, and the relation of which to the more important houses is analogous to that of the priory to the abbey. It was also given to certain lay officials, whose duties, in relation to the church and the maintenance of its material condition, were similar to those of the modern churchwarden. In the Protestant Church in Germany, the name provost is sometimes used as synonymous with that of dean or arch-priest; and occasionally, where several minor churches or chapels are attached to one chief church, the minister of the latter is called 'provost.'

In England, the heads of several colleges in the university of Oxford, and the head of King's College, Cambridge, are designated provost. The head of Eton College is also so called. The Provost of the Mint is a judge appointed to apprehend and prosecute false coiners.

In Scotland, the chief municipal magistrate of a city or burgh is called Provost, the term corresponding to the English word mayor. The provost presides in the civic courts along with the bailies, who are his deputies. The chief magistrates of Edinburgh and Glasgow are styled Lord Provost, and the same designation has long been popularly given to the Provost of Aberdeen, and his right to it, which has been contested by the Court of Session, seems lately to have acquired some sanction from royal usage. It has been said that the Provost of Perth, from having been on one occasion addressed by Queen Victoria as Lord Provost, is entitled to the same style. The Lord Provost of Edinburgh is entitled to the prefix 'Right Honourable,' which may be attached not merely to the name of his office, but to his Christian name and surname, a usage which probably originated in the circumstance, that the Lord Provost of Edinburgh was *ex officio* a member of the old Scots Privy Council. Within the city and liberties of Edinburgh, the Lord Provost takes precedence next after members of the royal family. The Lord Provost of Glasgow is generally styled the 'Honourable,' a prefix, however, which belongs only to his office, and cannot be attached to his name.

In France, there were formerly various descriptions of inferior judges, known under the name of provost (*prévôt*). The Grand Provost of France had jurisdiction in the king's house and over its officers.

**PROVOST-MARSHAL**, in the *Navy*, is a person appointed to have charge of a prisoner before a court-martial, and until the sentence of the court is carried into execution. In the *Army*, the provost-marshal is an officer, with the rank of captain, appointed to superintend the preservation of order, and to be, as it were, the head of the police of any particular camp or district. He has cognizance of all camp-followers, as well as of members of the army. His power is summary, and he can punish an offender, taken *flagrante delicto*, on the spot, according to the penalties laid down in the Mutiny Act.

**PROW** (from the Latin *prova*) means, generally,

the fore-part of a ship, or more especially the beam or pointed cut-water of a galley, polacca, or rebec.

**PROXY** (contracted for Procuracy), the agency of one person who acts as substitute for another. Every member of the House of Lords can (by licence, in theory supposed to be obtained from the sovereign) appoint another Lord of Parliament his proxy to vote for him in his absence. A spiritual lord can, however, only be proxy for a spiritual lord, and a temporal for a temporal lord, and no peer can hold more than two proxies at the same time. Proxies cannot be used in judicial cases, or where the House is in committee, nor can a proxy sign a protest.

**PRUDENTIUS, AURELIUS CLEMENS**, a Christian poet of the 4th c., was a native of Spain, and was born 348 A. D. Nothing is known regarding him except what he has himself told in a poetical autobiography prefixed to his works. From this we learn that he received a liberal education, was admitted to the Roman bar, practised as a pleader, discharged the functions of civil and criminal judge, and was ultimately appointed to a high office at the imperial court. The year of his death is not known. In his youth, P. was fond of pleasure, and very dissipated; but as he grew old, he became very devout, and his writings (which are all in Latin verse) reflect the latter phase of his character. The principal are—1. *Catherismon Liber* (Book [i. e., of hymns] for Daily Use), being a series of twelve hymns, the first half of which were reckoned by the author suitable for devotional purposes at different parts of the day; 2. *Apotheosis* (a defence of the doctrine of the Trinity against heretics); 3. *Hamartigenia* (On the Origin of Evil, a polemic in verse, against the Marcionites); 4. *Psychomachia* (The Triumph of the Christian Graces in the Soul of a Believer); 5. *Contra Symmachum, Liber 1* (a polemic against the heathen gods); 6. *Contra Symmachum, Liber 2* (a polemic against a petition of Symmachus for the restoration of the altar and statue of Victory cast down by Gratian); 7. *Peri Stephanon Liber* (14 poems in praise of Spanish and other martyrs for the faith); 8. *Diptychon* (48 poems of four verses each, on Scriptural incidents and personages). Bentley calls P. 'the Horace and Virgil of the Christians,' which may be true enough if the critic only meant to say that P. is the first of the early Christian verse-makers; but is ridiculous if he intended to hint at a comparison with these masters of poetic elegance and grace.

**PRUD'HOMMES, COUNCIL OF** (from Latin *lance prudens*), municipal tribunals, which existed first in the middle ages at Marseille, Lyon, and perhaps elsewhere in France, exercising an equitable jurisdiction as arbiters of disputes between masters and workmen. Similar tribunals, under the same name, were reintroduced by Napoleon I. in 1806, and have been found of great practical utility. They now exist in two localities in France, Lyon and Paris. They were instituted in the former town in 1806, in favour of the silk-trade and other trades immediately connected with it. The council consists of manufacturers, mercers, master-workmen, foremen, dyers, and common workmen, elected among themselves. The council is empowered to dispose finally of all differences between manufacturers and their workmen, or between master-workmen, companions, and apprentices, where the sum in dispute does not exceed 200 francs; and it may also take cognizance, subject to an appeal to the Tribunal of Commerce or Tribunal of First Instance, of similar disputes, whatever their amount. Other functions of a miscellaneous nature belong to the Council of Prud'hommes, including the inspection of the workshops, in order to obtain

information regarding the number of looms and of workmen, and the giving an opinion, when required by the administrative authorities, on any question submitted to it. In 1844, a Council of *Prud'hommes* was established in Paris in favour of the metal trade, and all trades connected with it; and three new councils of the same kind were instituted in Paris in 1847—one connected with the manufacture of tissues of all kinds, another with the manufacture of chemicals, and a third having jurisdiction in all other trades.

**PRUNELLA**, a genus of plants of the natural order *Labiata*, having the upper lip of the calyx 3-toothed, the lower lip bifid; the upper lip of the corolla arched and nearly entire; the lower lip 3-lobed; and four filaments, each with two teeth at the extremity, of which one bears the anther. Several species are natives of Europe; one only is found in Britain, *P. vulgaris*, popularly known as *SELF-HEAL*, a plant very frequent in moist and barren pastures, as it is also throughout most parts of Europe, Central Asia, North America, and New Holland. It has oblong-ovate stalked leaves, and violet-blue flowers, very densely whorled, so as to form an imbricated oblong spike. It was at one time in considerable repute as a febrifuge. It is mildly aromatic and slightly astringent.

**PRUNES** are dried fruit of the plum-tree (*Prunus domestica*), of the variety called *Juliana*, which is so largely cultivated in France, that not only is that country supplied, but Britain also imports from thence over 400 tons per annum. They are much used in the manufacturing districts of England by the operatives, who make puddings and pies of them when fresh fruit is out of season. The very fine kind which are sold in highly ornamental boxes are called French Plums or Table P.; these are a much finer variety, viz., *Catherinea*, which are much larger, and, when ripe, are much sweeter. They are more carefully prepared, being gathered by hand, and separately dried. They are used chiefly as a dessert fruit. The imports of these into Britain amount to upwards of 200 tons per annum.

**PRUNING**, the removal of branches from fruit or forest trees, in order to the greater production of fruit, the improvement of the timber, or purposes of ornament. In pruning for ornamental purposes, taste must chiefly be consulted, but reference must be made to what has been too little regarded in pruning of every kind—the nature or habit of the tree itself. Some trees will bear clipping into fantastic forms, which would be utterly destructive of others. Such forms, once esteemed as the finest ornaments of a pleasure-ground, or the neighbourhood of a mansion, are rejected by the simpler taste of the present age, and the *topiarian art* has few admirers. Much may be done, however, by the removal of branches, to give a finer form to ornamental trees; but in this, as in the pruning of trees grown for the sake of their timber, a great mistake is very generally committed in permitting branches to grow to a considerable size before they are cut off. It may be accepted as a general rule, that the branches removed should be small in proportion to the whole bulk of the tree. The removal of twigs and small branches is attended by no bad effects, and may be beneficial; but the removal of large branches is dangerous. The leaving of stumps or snags is an aggravation of the evil. They rot away, and spoil the timber of the stem; indeed, a hole is not unfrequently formed. But as to forest trees, pruning may with great advantage be in great part avoided, by taking care to plant at proper distances, and thinning out the plantations sufficiently in early

periods of their growth. In this way, better timber is obtained, and a greater produce from the land. Pines and firs scarcely ever require pruning, and are probably in almost all cases the worse of that which they get, except in the removal of those lower branches which have actually begun to decay. In other trees, it is sometimes of importance to watch for branches that would divide the trunk, and to prevent the division, causing the main stem to ascend higher before it forms a crown; but to be of any use, this must be done whilst the branches are still very young. Plantations should therefore be examined with a view to pruning, at intervals of not more than two years, after they are six or eight years old.

In orchards and fruit-gardens, pruning is necessary, the object being not to produce timber, or the utmost luxuriance of trees, but fruit in the greatest perfection and abundance. The habits of each kind must be studied. Even in the pruning of gooseberry and currant bushes, regard must be had to natural diversities, the gooseberry and black-currant producing fruit chiefly on young wood, whilst the red and white-currant produce fruit chiefly on spurs from older branches. And so it is amongst trees; apricots, for example, producing fruit chiefly on young wood; cherries mostly on spurs, whilst plums produce both in the one way and in the other. The object of the gardener in pruning is to bring the tree into the condition best suited for producing fine fruit and in the greatest abundance; and to this the training of Wall Trees (q. v.) must also be accommodated. Sometimes, in order to produce particularly fine fruits for the improvement of the variety by seed, or for the sake of a prize at a horticultural exhibition, the gardener diminishes the number of branches likely to bear fruit, beyond what would otherwise be desirable.

The general seasons of pruning are winter and spring; but some trees, particularly cherries, are advantageously pruned in summer, as they then throw out less gum.

Pruning instruments are of various kinds—knives, axes, saws, bills of very various forms, &c., and the *averruncator*, which may be described as a pair of scissors, one blade hooked or crooked, attached to a long handle, and working by a cord and pulley. It is scarcely used except for standard trees in gardens and orchards.

**PRUNUS.** See **PLUM.**

**PRURIGO** is a non-contagious affection of the skin, in which intense itching is the most prominent symptom. Sometimes the parts affected present no marked deviation from the normal type, but most commonly they are covered with papula, which are nearly of the same colour as the skin. Hence *P.* has been placed among the papular diseases of the skin. William makes three varieties of this disorder—viz., *P. mitis*, *P. formicane*, and *P. senilis*. This affection seldom affects the whole surface; its favourite seats being the neck, the shoulders, the back, the outer surface of the limbs, the anus, &c. In *P. formicane* there is not only intense itching, but patients complain of a feeling like the creeping of ants (hence the specific name) or the stinging of insects, or as if hot needles were thrust into the skin. All the forms of this disease are aggravated by exposure to the air, and by heat, and the sensations are often so distressing after the patient has become warm in bed, as to prevent sleep for many hours. *P. senilis*, occurring, as its name implies, in old persons, is characterised by the extreme severity and permanence of the itching, and by the obstinacy with which it resists every kind of treatment. The different varieties of this disorder may probably be

## PRUSSIA.

often traced either to disease of the digestive system, or to want of personal cleanliness; but in most cases their origin is obscure.

In the treatment of this disease, attention should be paid to the diet. All stimulating condiments and drinks should be forbidden, and only a plain, easily digested food allowed. Internal remedies are seldom of use excepting opium, which in severe cases is required in free or large doses, in order to procure rest. The local applications that have been recommended are very numerous. Lotions of spirit, diluted vinegar, solution of acetate of ammonia, glycerine, prussic acid, &c., and ointments containing creasote, iodide of sulphur, aconitine, &c., have been advocated by various physicians of eminence. Unless, however, the greatest attention is paid to personal cleanliness, no remedy is likely to be of permanent benefit.

PRUSSIA (Germ. *Preussen*) is a kingdom of Northern Germany, consisting of two large tracts of land, separated from one another by other states. The eastern or larger portion is bounded N. by the Baltic; E. by Russia and Poland; S. by Austria and Austrian Poland, Saxony, Reuss, and Schwarzburg; and W. by Electoral Hesse, Hanover, Brunswick, and the Mecklenburg duchies. The western or smaller half is bounded N. by the Netherlands and Hanover; E. by Schaumburg-Lippe, Lippe-Detmold, Brunswick, Hanover, the Hesse territories, Waldeck, Nassau, Oldenburg, and the Rhenish Palatinate; S. by France; and W. by Belgium, and the Netherlands. Besides these two large sections of territory, P. owns various detached domains lying within the boundaries of other states, the largest of which are the Principality of Hohenzollern (q. v.) and Jade, in Minden.

The following table gives (according to the *Almanach de Gotha* for 1865) the areas and populations of the 8 provinces into which P. is divided:

	Area in sq. miles.	Pop. at the close of 1862.
1. Prussia, . . . . .	34,739	2,866,866
2. Posen, . . . . .	11,260	1,485,550
3. Pomerania, . . . . .	12,111	1,348,739
4. Silesia, . . . . .	15,677	3,990,695
5. Brandenburg, . . . . .	15,417	2,467,759
6. Saxony, . . . . .	9,673	1,976,417
7. Westphalia, . . . . .	7,727	1,618,065
8. Rhenish Prussia, . . . . .	16,230	3,215,784
District of Hohenzollern, . . . . .	444	64,675
" Jade, . . . . .	5	950

The troops quartered beyond the Prussian boundary number 14,720; giving for the whole of P. a population of 18,491,220, with an area of 107,183 square miles.

*Physical Character, &c.*—The eastern and larger portion of P. is a part of the great table-land of Eastern Europe, and, except in the south, on the Bohemian boundary, is an almost unbroken plain, only 600 or 700 feet above the level of the sea. The Sudetic Mountains, whose northern ranges, known as the Riesengebirge (q. v.), lie between the Oder and the Elbe, divide P. from Bohemia; while the Thüringerwald and the Harz Mountains (q. v.) intersect the line dividing it from Saxony, Hanover, and some of the lesser German states. None of these ranges rise, even in their highest summits, above 5000 feet. The surface of the great plain of Eastern P. is marked by two distinct tracts of more elevated land, one of which belongs to the elevation which, running generally parallel to the Baltic, may be traced from the mouth of the Elbe to the source of the Volga, and which in P. rises about 400 feet above the sea-level. This tract is diversified with numerous lakes, none of which is more than 20 square miles in extent, but which altogether occupy an area of more than 300 square miles. The

soil, consisting chiefly of loose sand interspersed with a large number of erratic blocks of granite, is sterile, covered in many places with heaths and belts of stunted pines. On the northern slope, terminating on the shores of the Baltic, there are several fertile districts, more especially along those rivers which have been carefully embanked, as the Niemen and the Vistula. The southern elevation of the Prussian plain, running between the Polish mountains of Sandomir in the south-east, and the Elbe between Magdeburg and Burg in the north-west, attains a height of about 1000 feet near Breslau on the Oder, where it is known as the Trebnitz Heights. Its general character is more fertile than the northern elevation; while the country between the two is, for the most part, extremely sterile. It includes the sandy waste in which Berlin, the capital, is situated. South of this tract, and in Silesia and Prussian Saxony, the country is fertile, including some of the most productive grain-growing districts of Prussia. Eastern P. has four large rivers—the Elbe, Oder, Vistula, and Niemen; the numerous affluents of which, running east and west, together with many smaller streams, between the two elevated tracts of the plain, contribute largely to the facilities of intercourse throughout the country, as many of them are navigable for vessels of several hundred tons.

Western P., which includes the Rhenish districts and Westphalia, is divided by the Rhine into two portions, each of which has an elevated and a low plain. On the west bank of the river, the level land terminates in the northern extremity of the Vosges, or, as they are here called, the Hart Mountains, and extends northward as far as Aix-la-Chapelle. This table-land is broken along the banks of the Moselle by ranges of the Hochwald and the Soonwald, the highest summit of which, Walderkopf, attains an elevation of about 2700 feet. The plain north of the Moselle, which is known as the Eifel and the Hohe Veen, has a mean elevation of 1600 feet, with a few higher hills. The level country between the Rhine and Maas, bordering the Eifel, is extremely fertile. On the east side of the Rhine, the table-land, rising along the banks of that river and the Main, terminates in the ridge of the Taunus, whose highest summit, the Feldberg, attains a height of more than 2800 feet, or about 800 feet more than the mean elevation. In the north, the plain ends in the Westerwald between the Lahn and the Sieg, and in the Sauerland between the Sieg and the Ruhr. The soil is generally poor in these districts, which, however, possess special sources of wealth in their iron and coal mines.

The narrow valley of the Rhine is noted as one of the most picturesque and beautiful parts of Germany. The Rhine (q. v.) is navigable throughout its entire course in P., which it traverses from south to north, receiving numerous other rivers—as the Lahn, Wied, Sieg, Wupper, Ruhr, Lippe, Berkel, and Vechte on the right; and on the left, the Ahr and the Moselle, the latter of which is navigable for more than 150 miles within the Prussian dominions. The rivers of P. are connected by numerous canals, the principal of which are the Neuer or Seckenburger, the Friedrichgraben, the Finow, Bromberger, and Friedrich Wilhelms, which unite the important districts of the Oder with the Vistula; the Sprea and the Havel; and the Planeeche, which connects the latter river with the Elbe.

*Climate, Products, &c.*—The climate of P. presents great differences in the eastern and western provinces—the former being exposed to heavy snow-storms in the winter, and great drought in the summer, and with a mean annual temperature of 45°

## PRUSSIA.

has a summer mean temperature of 61°, and winter, 26° F.; while the latter, which have milder winters, and a larger fall of rain, have a mean annual temperature of 49° 5'—summer, 63°, and winter, 35° F.

Agriculture and the rearing of cattle constitute the principal sources of employment and wealth of the rural population of the entire monarchy, and the state has hitherto directed its unremitting attention to the furtherance of the one, and the improvement of the other; abrogating onerous land-taxes, advancing money to landowners, encouraging agricultural institutions, introducing approved breeds of animals, and improved farm instruments, &c. Wheat, rye, oats, barley, peas, millet, rape-seed, maize, linseed, tobacco, flax, hemp, hops, chicory, are extensively cultivated, and largely exported. The finest grain districts are the Börde, near Magdeburg, the low lands on the Wartha and Netze, and on the Plöne and Madue lakes, the north-eastern parts of Pomerania, the island of Rügen, the valleys of the Oder in Silesia, of the Saale, Moselle, and Saar. Potatoes have of late years been largely grown. Western P. is noted for its excellent fruits and vegetables, and the Rhenish provinces stand pre-eminent for their wines, yielding on an average an annual quantity of about 26,700 gallons. The forest-lands, which are chiefly in East P., Posen, Upper Silesia, and Westphalia, are of great value and considerable extent, occupying an area of nearly 10,000,000 English acres. The mineral products of P. include coal, iron, lead, zinc, copper, cobalt, antimony, manganese, arsenic, sulphur, alum, nickel, black lead, baryta, gypsum, slate, lime, freestone, salt, amber, agate, jasper, onyx, &c. All metals, salt, precious stones, and amber belong to the crown. The latter substance is found almost exclusively along the 12 or 14 miles of sea-coast on the Baltic, between Pillau and Dirschkemen, where it is dug up, or dredged up close off the shore. P. has upwards of 100 mineral springs, of which the most noted and efficient are the sulphur baths of Aix-la-Chapelle, the iron springs of Driburg, and the hot and saline baths of Reinez, Landeck, Flinsberg, Freisenwalde, and Lauchstadt.

The statistical tables of P. for 1863, give the following numbers of domestic animals for all the provinces: horses, 1,680,663; horned cattle, 5,634,510; sheep, 17,428,017, of which more than one-third were of improved breed; swine, 2,709,709; goats, 805,806; mules and asses, 7793. East P. is noted for its royal studs, and the excellent breed of horses which it now raises, and of which large numbers are annually exported. Westphalia enjoys a special reputation for the excellence of its hams and pork, Pomerania for its smoked geese, and Brandenburg for its honey and wax.

Fish of all sorts are abundant in the rivers and numerous lakes; seals are taken in the Baltic. The wooded districts abound in game of every kind; pheasants, partridges, and wild geese being often found in enormous quantities. Besides stags, fallow-deer, wild boars, foxes, otters, weasels, polecats, martens, badgers, hares and rabbits, the lynx, bear, eagle, and beavers are occasionally met with.

**Manufactures, Commerce.**—The principal manufactures are linens, for which certain districts of Silesia, Prussian-Saxony, and Brandenburg enjoy a European celebrity, while of late years the cotton manufactories, worked by steam, in which there are about 3300 engines in operation in the Rhenish provinces, and as many more in the other parts of the state, have maintained a successful rivalry with the older linens, worked by hand-loom, of which there were 284,135 in operation in 1863. Besides these, there are numerous manufactories of silk, wool mixed cotton and linen fabrics;

including fine shawls and carpets in Brandenburg, stockings and ribbons in the Rhenish provinces, where, as well as in Westphalia, the flax, hemp, and silk and cotton thread is mainly prepared for the manufacturers. These districts, moreover, stand foremost in regard to the preparation and manufacture of iron, steel, and other metallic wares, paper, leather, soap, oil, cigars, and tobacco, and for the number of their distilleries and breweries; while Saxony and Silesia have the largest number of chicory, starch, beet-root, gunpowder, and glass works. Berlin and Elberfeld rank as the two most important centres of manufacture in the continent.

The commerce of P. is materially facilitated by her central European position, and the network of river and canal navigation (measuring in all nearly 4000 miles), which makes her territories the connecting medium between several of the great European states, and which, with 3340 miles of railway, 17,000 miles of public roads (all formed since the time of Frederick the Great), and a sea-line of nearly 500 miles on the Baltic, give her a free outlet to the rest of the world. The Prussian mercantile marine numbered, in 1863, 1471 sea-going, and 35 steam-vessels, with a tonnage of nearly 194,000 lasts (the last = 1½ tons), and 11,805 river-sailing, and 180 steam-vessels with a tonnage of about 432,000 lasts. The chief harbours of P. are Memel, Danzig, Swinemünde, Peenemünde, Stralsund, and Barth. Its principal commercial towns are Berlin, Königsberg, Breslau, Barmen, Elberfeld, Danzig, Stettin, Cologne, Magdeburg, and Aix-la-Chapelle. Annual fairs are still held at Breslau, Magdeburg, and Frankfurt-on-the-Oder. The commerce of P. constitutes a very important branch of the great Zollverein, to the organisation of which the Prussian government gave the first impulse in 1819; and owing to the intricate and complicated nature of the trade relations of the country with the other members of that union, we must refer to the article Zollverein for the statistical tables of the value of Prussian imports and exports, which include, under the head of the former: raw and crystallised sugars, coffee, tea, spices, wines, spirits, tobacco, cotton, raw silk, hops, colouring matters, tin, quackilver, saltpetre, glass, cattle, fish, train oil, furs, &c.; and under the latter, wool and woollen goods, thread, yarn, flax, rape and linseed, silk and cotton and linen fabrics, wines, wood, salt, amber, coal, iron, lead, zinc, metal wares, dye-stuffs, books, leather, corn and bread-stuffs, &c.

Of the 990 cities of P., three only had, in 1861, a population exceeding 100,000—viz., Berlin, with a population of about 525,000; Breslau, with 138,000; and Cologne, 113,000. Of the six cities which have between 50,000 and 100,000 inhabitants, Königsberg has the largest population—viz., 87,000; while of the remaining thirty, whose populations exceed 15,000, half fall below 20,000.

The money, measures, and weights of P. are those in use throughout the German Zollverein, whose central bureau is located at Berlin. Accounts are kept in thalers (q. v.) and silbergroschen. The Bank of Berlin, founded in 1765 with a capital of 19 million thalers, and 111 branches in the provinces, has the right of issuing notes of a fixed value, according to the demand required.

**Religion, &c.**—The dominant religion is Protestantism, and since 1817, the Lutheran and Reformed Churches have been united under the head of one common evangelical church. All matters connected with the external administration of church matters are under the control of the minister of the theological and medical department, but every religious community manages its own internal

concerns; the Protestant churches acting in conjunction with a consistory, one of which exists in each province, under the direction of the upper president, or provincial governor, and a clerical superintendent-general, who in Posen and Pomerania bears the title of bishop; while the Roman Catholic Church is directed by the two archbishops of Posen and Gnesen, and Cologne, under whom stand the four bishoprics of Culm, Münster, Paderborn, and Treves. The two episcopal sees of Breslau and Ermeland are directly under the jurisdiction of the pope, while the district of Glatz, in Silesia, belongs to the archbishopric of Prague, and Katocher, in Upper Silesia, to that of Olmutz. At a rough estimate, there are about 11½ million Protestants to nearly 7 million Roman Catholics, and upwards of 250,000 Jews, the rest of the population belonging to the Greek Church, and other religious denominations. The Protestants have rather more than 9000 licensed places of worship, with 6500 ordained clergymen; and the Roman Catholic Church nearly 8000 churches and chapels, with upwards of 6000 priests. There are 183 monastic or conventual establishments, with nearly 4000 inmates, the greater number of which are more especially devoted to purposes of education, or nursing the sick.

**Education.**—Education is compulsory in P., and its management and direction under the control of the state. In no country are better or ampler means supplied for the diffusion of knowledge among all classes of the community. P. has seven universities—viz., Königsberg, Berlin, Greifswald, Breslau, Halle, Münster, Bonn, and two colleges for the Catholic priesthood at Brauneberg and Münster; which together number 5600 students. At the close of 1861, there were in P. 28,546 schools and educational establishments of every kind, exclusive of the universities; and of these 300 were higher schools (gymnasiums), about 1000 classical private schools, 58 normal, and about 700 art, trade, and handicraft schools, and about 25,000 public elementary schools, with 35,000 teachers, and about 2,700,000 scholars. The management of the elementary national schools is in the hands of the local communities; but the state appoints the teachers, and in part pays their salaries, the remainder being supplied by the public. In addition to the libraries of the several universities, there is the Royal Library at Berlin, with 500,000 volumes and about 10,000 MSS. Among the numerous scientific, artistic, and literary schools and societies of P., the following are some of the more distinguished: the Academy of Arts, founded in 1699; the Royal Museum of Arts; the Academy of Sciences; the Natural History, Geographical, and Polytechnic Societies of Berlin; the Antiquarian Society of Stettin; the Breslau Natural History and Historical Societies; &c.

**Charities.**—P. has a large number of benevolent institutions, towards the maintenance of which the state gives annually about £16,000 sterling. In 1861 there were about 1000 public civil and military infirmaries, in which upwards of 170,000 patients were under treatment, and between 7000 and 8000 poor and almshouses; while 800,000 poor received support through these institutions or by extraneous relief. P. is supplied with asylums for the deaf and dumb, the blind and the maimed, and has good schools for training midwives, nurses, &c.

**Justice.**—The highest court of law is the Upper Tribunal in Berlin, and each province has its special court of appeal. Besides these, there are 125 magisterial, 7 commercial, and numerous military courts. In the Cologne district, the *Code Napoléon* is in force, and in Hither-Pomerania, the common

German law; but in other parts of the kingdom the Prussian code, compiled under Frederick the Great's direction, and introduced in 1794, is followed. A new penal code was promulgated in 1850, by which all pre-existing, seigniorial, municipal, or ecclesiastical rights of decreasing punishments were unconditionally abrogated. Members of the royal family are amenable to special laws and courts. Lesser courts for the settlement of minor debts and disputes, and juries have been introduced in every province of late years, and publicity is demanded by the constitution in the conduct of criminal cases. There are 44 civil prisons. The administration of military matters is under the control of the minister of war; military courts are presided over by two civil and three military officers, and are subordinate to the local provincial courts of appeal.

**Army, Navy, &c.**—The army numbers on a peace footing 191,033, and in time of war 356,532; besides 8265 garrison troops in the former case, and in the latter 153,966 garrison troops, and 123,923 men at the dépôts. The cavalry contributes 37,561 of this number in war time. The army consists of the regular troops and the landwehr, and in time of war an extra contingent can be called up under the title of the landsturm. Every able-bodied male Prussian is liable to be called upon to serve between 20 and 39 years of age. Mennonites (see ANABAPTISTS), clergymen of the Roman Catholic and Evangelical churches, and indispensable supporters of families are exempt. The time of active service is three years for some branches of the service, and two for the others. P. has 30 fortresses, of which Dantzic on the Weeser, Magdeburg, Cologne with the fortifications of Deutz on the opposite right bank of the Rhine, and Coblenz with the opposite rocky heights of Ehrenbreitstein, rank in the first class as the strongest. Great care is bestowed on the education and military training of officers and men, and besides numerous admirable academies, there are several good schools of operative and veterinary surgery, &c., connected with the educational department of the army. The Prussian navy, in 1864, numbered 119 vessels of all descriptions, carrying 416 guns and 3504 men. There is a harbour for the coast-fleet on the island of Danholm, near Stralsund, where there is a navigation school and a naval academy. The territory on either side of the mouth of the Jahde was purchased in 1863 from Oldenburg, with a view of obtaining a port on the German Ocean.

**Constitution, &c.**—P. was an absolute monarchy till the crisis of 1848, when the decided movement in favour of liberal views compelled the late king to convoke a national assembly and submit to the establishment of a constitutional form of government. The national representative body now consists of an upper chamber or *Herrenhaus*, with 230 members, which is composed of the princes of the royal house, elected by the king, and of members of 14 mediatised princely houses, the great noble land-owners, high official dignitaries, 5 representatives of the universities, and 27 representatives of cities. The lower chamber has 362 members, chosen by electors, whose numbers bear the relation of 1 to every 250 of the population. In addition to this general house of assembly there are representative bodies for the provinces, communes, and circles, which debate and legislate in regard to local matters within their several departments. The council of state is composed of 10 ministers, under whose ministries are numerous departments, embracing almost every conceivable subdivision of foreign policy or internal legislation, since nothing can be done in P. independently of the state. By the modified constitution of 1850, all exclusive

## PRUSSIA.

privileges arising from titles or station are abrogated, and perfect equality in the eyes of the law fully recognised; liberty of the subject guaranteed in regard to religious persuasion, the right to hold meetings unarmed within closed doors, and become members of societies; immunity from domiciliary visits, and inviolability of letters, &c. The monarchy is hereditary in the male line. The sovereign and royal family must profess the evangelical confession of faith. The king, who is not responsible for the measures of his government, and whose decrees require the counter-signatures of his ministers, exercises the executive power, nominates and dismisses the ministry, summons and dissolves the chambers, orders the promulgation of the laws, is commander-in-chief of the forces, has the right of proclaiming peace and war, granting reprieves, &c. He bears the titles of King of Prussia, Markgraf of Brandenburg, Sovereign-duke of Silesia, Prince of Orange, Grand Duke of Pomerania and the Lower Rhine, besides a host of lesser titles. The arms of P. are composed of four central shields, borne on the great shield of 48 fields, representing the different territories incorporated in the Prussian monarchy. The black eagle on a field argent, surmounted by the open crown, is the special cognizance of P.-Proper. The national colours are black and white; the standard is white, bearing the Prussian crowned eagle and an iron cross in the right corner. The eldest son of the king bears the title of Crown-Prince. The ordinary royal residences are the palaces at Berlin, Potsdam, and Charlottenburg. The royal domains were ceded to the state by Frederick-William III. in 1820, on condition of a rental of 2½ million thalers being paid first from them for the king and his family. Among the numerous military orders, the following deserve notice: the Order of the Swan, founded in 1443; and that of the Black Eagle, founded in 1701, regarded as of the highest dignity. The king is a member of the German Confederation on behalf of his German territories (that is, exclusive of P.-Proper and Posen), and has four votes in the *plenum* and one in the limited council. P. supplies a contingent of 93,638 men, with a reserve of 40,131 men to the federal army.

According to the budget of 1864, the receipts were 141,333,738 thalers (a thaler = 3s. sterling); and the expenses for the same period, 137,194,636 thalers; with extraordinary expenses amounting to 6,639,100 thalers; while the funded national debt in that year, in addition to debts for railways, &c., amounted to 261,835,704 thalers.

**Taxation.**—The indirect taxes are derived from tolls and duties at ports, harbours, roads, bridges, city-gates, &c., duties on malt, spirits, stamps, tobacco, salt, &c., at the rate of about eight thalers a head; direct taxes arise from land-rates, income, trade and property taxes, railways, &c.

**Population, Races.**—About five-sixths of the population of P. are Germans. Of the Slavonic tribes, the most numerous are Poles, numbering 2½ millions. In Brandenburg and Silesia there are about 80,000 Wends; and in East P., upwards of 136,000 Lithuanians; while Western P. has rather more than 10,000 Walloons, using the French language; intermixed in its generally German population, Silesia has nearly 59,000 Bohemians or Moravians—making in all 2½ millions who do not use the German language, or who employ it only as secondary to their native tongues.

**Ranks, Classes.**—Three distinct hereditary classes are recognised in P., viz., nobles, burghers, and peasants. To the first belong about 177,000 persons, including the higher officials of the state, although that number does not comprise the various

mediatised houses, of which 17 are Prussian, and others belonging to different states, but connected with P. by still existing, or former territorial possessions. The burgher class includes, in its higher branches, all public office-bearers, professional men, artists, and merchants; while the peasantry—to which belong all persons engaged in agricultural pursuits—are divided into classes, depending on the number of horses employed on the land, &c.

**History.**—The lands bounded by the Baltic, which now form part of P., were early occupied by Slavonic tribes, nearly allied to the Letts and Lithuanians. It is conjectured that they were visited by Phœnician navigators in the 4th c. B.C.; but beyond the fact of their having come into temporary conflict with the Goths and other Teutonic hordes, prior to the great exodus of the latter from their northern homes, little is known of the people till the 10th c., when they first appear in history under the name of Bornasi, or Prussians. In 997, Bishop Adalbert of Prague suffered martyrdom at their hands, while endeavouring to convert the people to Christianity. Boleslas, Duke of Poland, succeeded, however, about 1018, in compelling them to submit to baptism and subjection. After many futile attempts on the part of the people to throw off the yoke of Christianity and foreign domination, they finally made a successful stand against Boleslas IV. of Poland in 1161, and for a time maintained a rude and savage kind of independence, which the disturbed condition of Poland prevented its rulers from breaking down. The fear of losing their freedom if they adopted Christianity, made the Prussians obstinately resist every effort for their conversion; and it was not till the middle of the 13th c., when the knights of the Teutonic order entered upon their 'famous' crusade against them, that the Christian faith was formally established among them. The aggressive inroads of the pagan Prussians on the territories of their Christian neighbours, and their advance into Pomerania, were the exciting causes of this important movement. The knights of the order, when appealed to by Conrad, Duke of Masovia, to aid in the subjection of the heathen, gladly promised their services, on condition of being permitted to retain possession of the lands which they might conquer; and having entered the Prussian territories in considerable numbers, they entrenched themselves at Vogelsang and Nessel in 1230, and at once entered upon the conquest of Prussia. For half a century the belligerent brotherhood were engaged in war with the people—winning lands and souls by hard fighting—until at length, in 1283, they found themselves undisputed masters of the country, which they had both civilized and Christianised after a fashion, namely, by almost exterminating the pagan population. During this period of struggle, the knights founded the cities of Thorn, Kulm, Marienwerder, Memel, and Königsberg, re-peopled the country with German colonists, encouraged agriculture and trade, and laid the foundation of a well-ordered, prosperous state. The unhappy war between the knights and the Poles and Lithuanians, together with the moral degeneracy of the order, led, in the 14th and 15th centuries, to the gradual decline of their supremacy. In 1454, the municipal and noble classes, with the co-operation of Poland, rose in open rebellion against the knights, who were finally compelled to seek peace at any cost, and obliged, in 1466, to accept the terms offered to them by the Treaty of Thorn, by which West P. and Ermland were ceded by them unconditionally to Poland, and the remainder of their territories declared to be fiefs of that kingdom. In 1511, the knights

elected as their grand-master the Markgraf Albert of Anspach and Baireuth, a kinsman of the king of Poland, and a scion of the Frankish line of the Hohenzollern family. Although his election did not immediately result, as the knights had hoped, in securing them allies powerful enough to aid them in emancipating themselves from Polish domination, it was fraught with important consequences to Germany at large, no less than to the order itself. In 1525, the grand-master was acknowledged Duke of P., which was converted into a secular duchy (afterwards known as East P.), and renounced the Roman Catholic religion for Lutheranism, his example being followed by many of the knights. The country made rapid advances under the rule of Albert, who improved the mode of administering the law, restored some order to the finances of the state, established schools, founded the university of Königsberg (1544), and caused the Bible to be translated into Polish, and several books of instruction to be printed in German, Polish, and Lithuanian. His son and successor, Albert Frederick, having become insane, a regency was appointed. Several of his kinsmen in turn enjoyed the dignity of regent, and finally his son-in-law, Johann Sigismund, elector of Brandenburg, after having held the administration of affairs in his hands for some years, was, on the death of the duke in 1618, recognised as his successor, both by the people and by the king of Poland, from whom he received the investiture of the duchy of P.; which, since that period, has been governed by the Hohenzollern-Brandenburg House.

Here it will be necessary to retrace our steps in order briefly to consider the political and dynastic relations of the other parts of the Prussian state. In the 12th c. the northern Mark, comprising probably the territory between the Elbe and the Oder, as far as its confluence with the Spree, was held by the immediate descendants of Albert the Bear of Luxemburg, its first hereditary markgraf, who, during the next two or three centuries, extended their dominions eastward, beyond the Oder into Further Pomerania. On the extinction of this line, known as the Ascanian house, a remote kinsman, Frederick VI., count of Hohenzollern, and markgraf of Nürnberg, became possessed, partly by purchase and partly by investiture from the emperor, of the Brandenburg lands, which, in his favour, were constituted into an electorate. This prince, known as the Elector Frederick I., received his investiture in 1417. He united under his rule, in addition to his hereditary Franconian lands of Anspach and Baireuth, a territory of more than 11,000 square miles. His reign was disturbed by the insubordination of the nobles, and the constant incursions of his Prussian and Polish neighbours, but by his firmness and resolution he restored order at home and enlarged his boundaries. We are told that he gained possession of the castles of his refractory nobles by the aid of a 24-pounder, known as the Faule Grete; but even this unwonted auxiliary was of no avail in a long war which he waged against the Hussites, who devastated the land, and razed many of his cities in revenge for the part which Frederick had taken in acting as commander-in-chief of the imperial army, which had been sent against them. Under Frederick's successors the Brandenburg territory was augmented by the addition of many new acquisitions, although the system of granting appanages to the younger members of the reigning house, common at that time, deprived the electorate of some of its original domains, as for instance the markgrafate of Anspach, which passed, on the death of the Elector Albert Achilles in 1486, as an independent state to his

younger sons and their descendants. The most considerable addition to the electorate was the one to which reference has already been made, and which fell to the Elector John Sigismund through his marriage in 1609 with Anne, daughter and heiress of Albert Frederick, the Insane, duke of Prussia. In consequence of this alliance, the duchy of Cleves, the countships of Ravensberg, the Mark, and Limburg, and the extensive duchy of P., now known as East P., became incorporated with the Brandenburg territories, which were thus more than doubled in area. The reign of John Sigismund's successor, Georg-Wilhelm (1619-1640), was distracted by the miseries of the Thirty Years' War, and the country was alternately the prey of Swedish and imperial armies; and on the accession of Georg-Wilhelm's son, the great Elector Frederick-William (q. v.), in 1640, the electorate was sunk in the lowest depths of social misery and financial embarrassment. But so wise, prudent, and vigorous was the government of this prince, that at his death in 1688 he left a well-filled exchequer, and a fairly-equipped army of 38,000 men; while the electorate, which now possessed a population of one and a half million, and an area of 42,000 square miles, had been raised by his genius to the rank of a great European power. His successors, Frederick III. (q. v.), (1688-1713) and Frederick-William I. (1713-1740), each in his own way increased the power and credit of P., which had been in 1701 raised to the rank of a kingdom. The latter monarch was distinguished for his rigid economy of the public money and an extraordinary penchant for tall soldiers, and left to his son, the great Frederick II. (q. v.), a compact and prosperous state, a well-disciplined army, and a sum of nearly nine million thalers in his treasury. Frederick II. (1740-1786), dexterously availed himself of the extraordinary advantages of his position to raise P. to the rank of one of the great political powers of Europe. In the intervals between his great wars, he devoted all his energies to the improvement of the state, by encouraging agriculture, trade, and commerce, and reorganising the military, financial, and judicial departments of the state. By his liberal views in regard to religion, science, and government, he inaugurated a system, whose results reacted on the whole of Europe; and in Germany, more especially, he gave a new stimulus to thought, and roused the dormant patriotism of the people. Frederick was not over-scrupulous in his means of enlarging his dominions, as he proved by sharing in the first partition of Poland in 1772, when he obtained as his portion, nearly all West-P., and several other districts in East Prussia. His nephew and successor, Frederick-William II. (1786-1797), aggrandised his kingdom by the second and third partitions of Poland in 1793 and 1795. Frederick-William III. (q. v.), (1797-1840), who had been educated under the direction of his grand-uncle, Frederick the Great, succeeded his father in 1797, at a time of extreme difficulty, when continental rulers had no choice beyond being the opponents, the tools, or the victims of French republican ambition. By endeavouring to maintain a neutral attitude, P. lost her political importance, and gained no real friends, but many covert enemies. But the calamities which this line of policy brought upon P. roused Frederick-William from his apathy, and with an energy, perseverance, and self-denial, worthy of all praise, he devoted himself, with his minister Count Hardenberg, to the reorganisation of the state. In the ten years which succeeded the battle of Waterloo, P. underwent a complete reorganisation. Trade received a new impulse through the various commercial

## PRUSSIA.

treaties made with the maritime nations of the world, the formation of excellent roads, the establishment of steam and sailing packets on the great rivers, and at a later period the organisation of the customs-treaty, known as the Zollverein (q. v.), between P. and the other states of Northern Germany, and through the formation of an extended network of railways. The most ample and liberal provision was made for the diffusion of education over every part of the kingdom, and to every class. In like manner, the established Protestant Church was enriched by the newly-inaugurated system of government supervision, churches were built, the emoluments of the clergy were raised, and their dwellings improved; but not content with that, the king wished to legislate for the church in accordance with a set plan; and when the various Protestant churches refused to be joined in the Utopian union prescribed for them, difficulties arose. This tendency to over-legislation has long been the predominant evil feature of Prussian administration, and the state, without regard to the incongruous elements of which it was composed, was divided and subdivided into governmental departments, which, in their turn, under some head or other, brought every individual act under governmental supervision, to the utter annihilation of political or mental independence. The people, when they gradually began to comprehend the nature of this administrative machinery, saw that it made no provision for political and civil liberty, and demanded of the king the fulfilment of the promise he had given in 1815 of establishing a representative constitution for the whole kingdom. This demand was met with the most hypocritical and despotic insincerity on the part of the king, who professed to take high religious views of his duty as a sovereign, and its immediate fruits were strenuous efforts on his part to check the spirit of liberalism. Every measure taken by other sovereigns to put down political movements was vigorously abetted by him. Siding with the pietists of Germany, he introduced a sort of Jesuitical despotism, which has been continued by his sons, the late and the present king. The Landstände or provincial estates, organised in accordance with the system of the middle ages, were the sole and inadequate mode of representation granted to P. in this reign, notwithstanding the pledge made to the nation for a full and general representative government. An attempt made forcibly to unite Lutheran and Reformed Churches excited universal indignation, while the imprisonment, at a later period, of the Archbishops of Cologne and Gnesen for their conduct in regard to the vexed question of mixed marriages, involved the king in a long and fruitless dispute with the pope. The accession of Frederick-William IV. in 1840 seemed to open a better prospect to the friends of constitutional freedom, but the reality was scarcely equal to the expectations which had been warranted by the professions of the government. Still new hopes and requirements had been excited, and a new life was infused into every department of the state. Every branch of science, art, and literature was understood to receive the attentive consideration of the sovereign, who professed to be actuated by a love of universal progress. He made similar professions in regard to religious toleration, but the pietistic tendencies of his government exerted a forced and prejudicial influence in every department of the state; while the bureaucratic spirit of over-governing which characterised the administration was becoming daily more and more irksome to the nation, and gave rise to the formation of free churches or Protestant communities; while a contemporaneous excitement which had

arisen in the Roman Catholic Church of P., as the result of the schismatic movement due to the stand taken by the chaplain Ronge (q. v.) on the exhibition of the so-called Holy Coat of Treves (q. v.), further complicated the relations between church and state. The king and his advisers, underrating the importance of the movement of 1848 in Germany, thought they had satisfied the requirements of the hour by granting a few unimportant reforms, and making equivocal promises of further concessions. When at length, however, the citizens and troops came into collision, and blood was shed, Frederick-William came forward as the professed regenerator of his country, offering to lay down his royal title and merge his kingdom in the common fatherland, for the salvation of which he recommended a cordial union of all German princes and people in one bond, and proposing himself as the guide and leader of this new Germany. His own subjects, and at first many Germans in other states, were carried away by these Utopian schemes. The publication of a political amnesty, the nomination of a liberal ministry, the recognition of a civic guard, the retirement of the Prince of Prussia, the heir-presumptive—with whom every arbitrary measure of government was believed to originate—and the summons of a representative chamber to discuss the proposed constitution—all tended to allay the general discontent. But when the national assembly at Frankfurt, in disregard of the wishes of the Prussian king, declined to accept his proffered services, and elected the Archduke John of Austria lieutenant-general of Germany, his ardour in the cause of the fatherland cooled, his pledges to his own subjects were evaded as long and as completely as the occasion permitted, and his policy became more strongly tinged than before with a jealousy of Austria. His powerful co-operation in putting down the insurrection in Poland, and the democratic party in Baden, gave, however, ample proof of his determined opposition to every popular demonstration against absolutism. In the war of the Slesvig-Holstein duchies, the Prussians acted in concert with the disaffected against their sovereign, the king of Denmark, occupying the ducal provinces in the name and on the behalf of the diet. The latter years of this reign were characterised by great advance in the material prosperity and internal improvement of the country. Extensive lines of railway and post-roads were opened, the river navigation greatly facilitated, treaties of commerce formed with foreign countries, and great expansion given to the Prussian and North German Zollverein (q. v.), the army put upon a footing of hitherto unprecedented efficiency of arms and artillery, and the educational system of the country still further developed. The political freedom of P. cannot, however, be said to have made equal advance. The chambers which met for the discussion and framing of a constitutional mode of government, were constantly interrupted and obstructed in the prosecution of their task, and the constitution, which is now established by law, was modified every year between 1850 and 1857, until it may be said to retain few of its original bases; while the practical despotism of Frederick-William IV., and of his brother, the present king, who succeeded him in 1861, has hitherto put an effective check on all measures proposed by the body of representatives, which might have a tendency to interfere with the absoluteness of the regal power, or to promote the advance of thought and the progress of political freedom in the Prussian dominions. It was believed generally throughout Europe that the Liberals of Prussia, whose representatives formed a large majority in the Chamber of Deputies, were resolutely



bent on resisting the encroachments of the sovereign on their liberties; but partly through the unconstitutional audacity of the Prussian prime-minister, Count von Bismark, and partly through the outburst of national enthusiasm in the Slesvig-Holstein war, their 'opposition' has as yet produced no effect, nor even originated a policy.

PRUSSIA, one of the eight provinces into which the kingdom of the same name is divided, is bounded on the S.W. by Pomerania and the Baltic Sea, and on the E. and S. by Russia and Poland. Area, 24,739 sq. m.; pop. (1862) 2,866,866. It is divided into two districts or sub-provinces—East Prussia (14,833 sq. m.) and West Prussia (9906 sq. m.). About two-thirds of the soil consists of good land, the remainder being chiefly sandy. Agriculture is by far the most important branch of industry, manufactures being confined to such articles as supply merely local wants. Wheat is extensively cultivated, especially in the district of Gumbinnen; and, as the inhabitants live chiefly upon rye, the larger half of the wheat grown is exported. P. possesses a larger number of horses than any other province in the kingdom. For the history of the province of P., and for its principal physical features, see PRUSSIA, KINGDOM OF.

PRUSSIAN BLUE. See BLUE, CYANOGEN, FERROCYANOGEN, and FERRIDCYANOGEN.

PRUSSIC ACID. See HYDROCYANIC ACID.

PRUTH, an important affluent of the Danube, rises in the south-east of the Austrian crown-land of Galicia, on the north-east side of the Carpathian mountains, and near the base of Mount Rusky in that range. It flows in a deep valley eastward past Kolomea and Czernowitz, and, forming the boundary between Moldavia and the Russian territories from Bojana, passes Liptchany, then flows south-south-east to Katamori; after which its course lies south through Moldavia to the Danube, which it enters at Reni, about 12 miles below Galatz. Total length about 500 miles. Its affluents are very numerous but are inconsiderable.

PRYNNE, WILLIAM, noted as a pamphleteer and active politician during the reign of Charles I., and the subsequent period of the Commonwealth, was born near Bath in the year 1600. He received his early education there, and was afterwards transferred to Oriel College, Oxford, where, in 1620, he took his bachelor's degree. Selecting the law as his profession, he entered himself at Lincoln's Inn, where he became a bencher and reader; but it does not appear that he ever very seriously endeavoured to obtain practice at the bar. He was early drawn into the vortex of ecclesiastical controversy, and speedily made himself heard of as a champion of the Puritan party. In 1632, appeared his *Histriomastix, or a Scourge for Stage Players*, a tasteless and scurrilous attack on the popular amusements of the period, which procured him the attention of the authorities. For this performance he underwent prosecution in the Star Chamber, with results sufficiently unpleasant. His sentence involved him in a fine of £3000, degradation from the bar, expulsion from Oxford and Lincoln's Inn, the loss of both his ears in the pillory, and the shock to his vanity as an author, of seeing his book burned in public by the hangman. He was, moreover, condemned to perpetual imprisonment, and immured in the Tower accordingly. If the severity of the punishment seems, at first sight, astounding in its disproportion to the nature and amount of the offence, it is perhaps sufficiently explained by the fact, that P., by his previous issue of a series of anti-prelatical tracts, as by other indications of hostility, had made himself most obnoxious to Archbishop Laud and the clergy.

Three years after, the pertinacious offender found means to publish from his prison another pamphlet, in which he fiercely attacked the hierarchy, and was unsparring in his personal abuse of Laud and certain other bishops. For this he was again prosecuted; a fine of £5000 was imposed upon him; he was once more pilloried, losing such stumps of ears as the executioner had before spared; and was branded on both cheeks with the letters S. L. (Seditious Libeller). He was then removed to Caernarvon Castle, and afterwards to that of Mont Orgueil, Jersey, where he remained a close prisoner, till, in 1641—the Long Parliament then sitting—he was released by a warrant of the House of Commons, and a tumultuous expression of popular sympathy celebrated his restoration to liberty. Shortly afterwards, he was sent to parliament as member for Newport, in Cornwall, and for some years was actively, and, at times, even prominently engaged on the popular side in the proceedings of the House of Commons. In the extreme measures, however, leading to the deposition and death of the king, he declined all share; and being one of those of whom Cromwell shortly after 'purged' the House of Commons, he proceeded to assail him in print with an asperity not inferior to that with which he had before made war upon the bishops, as a consequence of which imprudence he was once more subjected to several years' imprisonment. On Cromwell's death he returned to his place in parliament, zealously interesting himself in the royal cause; and after the Restoration, the office was bestowed on him of Keeper of the Records in the Tower. Subsequently, his inveterate habit of venomous pamphleteering involved him in difficulties with the House of Commons, from which, on a charge of seditious libel, he narrowly escaped expulsion. He died at Lincoln's Inn in October 1669. The continuous stream of writings on the perilous topics of the day, which brought him so constantly into trouble, represents but a fraction of P.'s literary activity. He busied himself chiefly as a compiler of matter illustrative of constitutional and parliamentary history. His most valuable works in this field are the *Calendar of Parliamentary Writs*, and his *Records*, both of which contain much that is useful and important.

PSALMANAZAR, GEORGE, a somewhat remarkable impostor, was born about the year 1680. His real name and the place of his birth are unknown, but he is presumed to have been a native of Switzerland or the South of France. He received a good education, and gave early indication of talent, more especially for the acquisition of languages. Impelled by a restless and impatient temper, which indisposed him to any regular pursuit, for some years he roamed over Europe as a mere vagabond adventurer, assuming at first the disguise of an Irish pilgrim, exiled on account of his religion; and afterwards as soldier, menial, preceptor, beggar, or vagrant nondescript, living on his wits as he could, according to the whim or necessity of the hour. In the course of his wanderings, he was thrown into contact with a Colonel Lauder, commanding a Scotch regiment at Sluys, on whom he first passed the imposture to which he subsequently owed his notoriety, assuming the name by which he is since known, and representing himself as a Japanese convert to Christianity and native of the island Formosa. The good colonel seems to have been completely deceived by him; not so, however, the chaplain of the regiment, one Innes, a man equally acute and unprincipled, who speedily detected the deception, but was not the less willing to use it for the furtherance of his own ends. By Innes, P. was brought to England, and instantly became the

religious lion of the day, his patron skilfully availing himself of the connection to secure for himself preferment in the church. Dignitaries of the church contended for the honour of being serviceable to him; and through the influence of the Bishop of Oxford apartments were assigned him at the university, in order that he might prosecute his studies there. The talent, ingenuity, and resource which he displayed in keeping up the deception, go far to account for what may seem to us the strange credulity with which his story was received. He published, in Latin, a fabulous account of the island Formosa, the consistency and verisimilitude of which imposed upon the learned world. He also invented a language, compact and somewhat complex in structure; and was able, in virtue of a memory not less than astonishing, to defy the ordinary methods of detection. In the midst of his success, however, at the age of about 32, he became the subject of religious impressions, and his conscience awoke to the ignominy of the deceit which he was practising. Urged by what seems to have been a genuine feeling of penitence, he withdrew himself from public notice, and for the rest of his long life honourably earned his livelihood by literature, in which he had a moderate success. Besides much assiduous compilation for the booksellers, of history, geography, and the like, he published several works anonymously, one of which, *An Essay on Miracles, by a Layman*, was for some time exceedingly popular. On his death in London in 1762, it was found that he had also busied himself in preparing for posthumous publication an account of his curious career, which, under the title *Memoirs of —, commonly known as George Psalmanazar, a reputed native of Formosa, written by himself*, was some years after given to the world.

PSALMODY, in its widest sense, is the singing of the Psalms of David and other sacred songs; but from the beginning of the Reformation period, the term has been restricted to the singing of metrical versions of the Psalms to short simple airs. Psalm-singing was of ancient date among the Jews, and was practised from the first ages of Christianity; the charge of Pliny the Younger against the Christians was, that they sung psalms to Christ '*quasi Deo*.' No authentic record, however, exists of the kind of melodies sung to the psalms by the primitive Christians. The practice of singing psalms in antiphony, or by two choirs, as still practised (see ANTI-PHONY), was introduced at an early period; it is said to have been begun in the Eastern Church by Ignatius, Bishop of Antioch, in the 2d c.; and in the Western Church by Ambrose, Bishop of Milan, in the 4th century. At first, the whole congregation, clergy and laity, joined in the psalm; but difficulties and abuses arose from the growing neglect of musical cultivation; and with a view of restoring public decency and order, the Council of Laodicea, in the year 363, considered it necessary to forbid the laity to sing in church at all, except in certain simple chants of a popular description. Down to the Reformation, the music of the church was surrendered to the clergy and trained musicians.

Psalmody, in the more modern sense, began in the 16th c., when Clement Marot, the court-poet of Francis I. of France, translated 52 of the Psalms into French verse, dedicating them both to his royal master—whom he likened to the Hebrew psalmist—and to the ladies of France. The sacred song-book, on its first appearance, not being accompanied by music, it became the practice to sing the psalms to favourite tunes—often those of popular ballads, and for a considerable time, psalm-singing became a favourite fashion among the gay courtiers of Francis.

Marot's collection was continued and concluded by Theodore Beza, whose psalms had the advantage of being set to music, Beza having in this the assistance of Calvin, who engaged the best composers of the day to unite his sacred songs with beautiful and simple airs of a devotional character. Psalm-singing was taken up by the Reformers, first for private devotion, and soon as part of the service of the church, Luther and Calvin restoring to the people their share in the musical part of public worship, and furnishing them with the means of performing it. From the time that psalm-singing was adopted by the Reformers, it was discountenanced by the Roman Catholics, and soon came to be regarded as a badge of Protestantism. Luther and Calvin differed, however, in their ideal of psalmody; the former was favourable to harmony in parts, while the latter confined himself to the bare unaccompanied melody. Once taken up by the Calvinists and Lutherans, psalmody spread over France, Germany, and the Low Countries, and reached England at the moment of her embracing the Reformation. The first English metrical version of the Psalms was made in the reign of Henry VIII. by Thomas Sternhold, a native of Hampshire, groom of the robes to King Henry, aided by John Hopkins and William Whyttinghame. Vocal psalmody was soon after introduced into the church-service, the choral mode of singing being still retained in cathedrals and collegiate churches, and the liturgic hymns being retained in the prayer-book. Of the psalm-tunes which came into use, some have been attributed to Claude Goudimel, Claude Le Jeune, and Guillaume Franc, and a few owe their origin to Luther. The well-known 100th Psalm is an adaptation of Gregorian phrases by Guillaume Franc. The first important collection of psalm-tunes for four voices published in England was made by Thomas Ravenscroft, Mus. Bac., and appeared in 1621; it was entitled '*The whole Booke of Psalms, &c.*, composed into four parts by sundry authors, to such several tunes as have been and are usually sung in England, Scotland, Wales, Germany, Italy, France, and the Netherlands.' In this collection were included contributions by Tallis, Morley, Dowland, and all the great masters of the day, as well as by Ravenscroft himself, who contributed the tunes St David's, Bangor, and Canterbury. The name of John Milton, father of the poet, appears as composer of the tunes, York and Norwich. According to the then prevalent usage, the subject or air was given to the tenor voice. This custom was first departed from in the *Whole Book of Psalms, in Three Parts*, published in 1671, compiled and arranged by John Playford—whom Sir J. Hawkins calls the 'father of modern psalmody'—where we have the more proper practice, which has since obtained, of making the melody the soprano part. Croft, Courteville, Cary, the Bachs, and Handel have, since that time, contributed to the psalmody in use in Britain.

Among other metrical versions of the Psalms produced was one of doubtful origin which was attributed to James I.; and which, notwithstanding a strong recommendation by his son, was never much used in churches. The version of the Psalms by Sternhold and Hopkins came to be supplanted in England, towards the beginning of the last century, by that of Nahum Tate, poet-laureate under William III. and Anne, and Dr Nicholas Brady, less literal in its renderings than its predecessor, and somewhat commonplace as regards poetical character. This *New Version of the Psalms* first appeared in 1698, with the royal authority allowing its use in churches. Of late years, modern hymns, selected according to the taste and at the will of

the incumbent, have to a large extent taken the place of metrical psalms in the Church of England.

In Scotland, the early Reformers, while they banished instrumental music from churches, paid great attention to singing. In John Knox's Psalter, arranged for use in churches, the metrical psalms are set to music in harmony of four parts. Several early translations of the Psalms were produced in North Britain, but that of Sternhold and Hopkins was used in worship from 1564 down to the middle of the 17th century. In 1632, an attempt made by Charles I. to supersede it by King James's version, was more resolutely and decidedly opposed than in England. The version now in use in Scotland was introduced during the Commonwealth by the General Assembly, and founded on the metrical translation of Francis Rous, a member of Cromwell's council, which parliament had in vain endeavoured to bring into general use in England. This new version was in 1649 appointed by the General Assembly to be the only paraphrase of the Psalms sung in the Kirk of Scotland, and all other versions were prohibited to be made use of not merely in congregations, but in families, after 1650. Though somewhat rough and uncouth, it is sometimes expressive and forcible, and perhaps nearer the original than any other metrical translation of the Psalms. A few Paraphrases and Hymns have since been added, by authority of the General Assembly, and form together the psalmody in use in Presbyterian worship in Scotland.

**PSALMS** (Heb. *Tehillim*, Songs of Praise, or *Tefilloth*, Prayers; Jerome, *Liber Hymnorum*), the well-known canonical book generally ascribed to David. The single hymns contained in the book are variously designated either as 'Prayer' (Tefilla), as 'Praise' (Tehillah), or from some special characteristic 'Song' (Shir), or a song of deeper meaning, (Michtam), 'Instruction' (Maskil), or a dithyrambic poem (Shigayon). Respecting the general contents of the book, it may be said that it comprises, in the form of pious lyrics, written for and on behalf of the congregation, the quintessence of the dogmatical, ethical, historical, and theoretical portions of the Old Testament. The divine essence and qualities, providence and its guidance—especially of Israel—the rule of the universe, the nature of the human heart and its relations to God and His revelation, the blessings of the theocratic community: these and similar reflections form the themes of its ever-varying modes. A certain more spiritual conception of the ordinances of the Pentateuch is visible throughout, and although the strictest adherence to these is enjoined, yet their deeper meaning is impressed more strongly still. Used as a liturgical hymn book in the Temple, it has been bodily received for the same purpose in the Christian church; and certain additional hymns which occur in the Greek and Syriac Psalter have not been sanctioned by the authority of the general church. There are, in all, 150 canonical hymns or psalms, which, after the model of the Pentateuch, have been divided into five books—thus: i.—xli.; xlii.—lxxii.; lxxiii.—lxxxix.; xc.—cvi.; and cvii.—cl. The Syriac, the LXX., and the Vulgate Versions differ in some respects in their counting. The Authorised Version, however, follows strictly the Masoretic Jewish text, except with regard to the numbering of the verses; for while the latter includes the superscriptions among the verses, the former does not reckon those. This division into five books is, as it is traditional, also the most natural; and the doxologies at the ends of psalms xli., lxxii., lxxxix., and cvi., further mark authoritatively the respective ends of the special divisions. A further division, or rather classification, has been

attempted according to the contents; but, considering the constantly changing variety of moods and sentiments of manner and contents which these songs exhibit, it is a most precarious one.

The Psalms have generally—thirty-four only excepted—superscriptions more or less expressive of the contents of the special hymn, and sometimes with, sometimes without, the name of an author. In some, certain notes, referring to the musical and liturgical part, are added, which are far from being quite clear now, e. g., 'On the octave,' 'For the chief musician,' 'On Machalath' (illness?), 'In the time of death to the son,' 'The hind of Aurora,' 'Lilies,' 'Dumb doves of the far ones,' &c. One of the greatest puzzles is the word Selah, which occurs several times at the end, or in the middle of some psalms, and which the LXX. render Diapsalma, 'Interlude,' but about the real signification of which, numerous yet very unsatisfactory suggestions have been made at various times. Thus, it has been identified with amen, hallelujah, piano, &c. So much seems certain, that it was a kind of catch-word or sign for the performers. These headings belong very probably to the individual poets themselves, and not to the collectors, as has been surmised.

The authorship of the Psalms is ascribed by the headings of the various chapters as follows: Psalm xc.—one of the most ancient in form and contents—is attributed to 'Moses, the man of God.' Seventy-three psalms are inscribed with David's name; two with Solomon's; twelve with that of Asaph the Levite and singer, of which five, however, belong to the times of Jehoshaphat, Hezekiah, and the beginning of the Babylonian exile respectively. Eleven psalms go under the name of the Sons of Korah, or the Korahites—a family of singers descended from the Levite Korah, known from the Pentateuch. Their head at the time of David was Heman. Part of these psalms belongs to the time of David; others, to that of Solomon, and others are of an uncertain later period. Respecting the psalm inscribed 'Prayer of Moses,' there seems, indeed, to be no valid reason against its authenticity; it is quite worthy of the great legislator, and to a certain extent similar to other compositions of which he is reasonably regarded as the author. The numerous body of psalms attributed to David, manifest (those at least which can fairly be believed to be his work) a vivid and profound feeling and rare poetical gift. The singer abandons himself entirely to whatever feeling of joy or grief, repentance or revenge, piety or despair, sweeps over his soul. This also accounts to a certain extent for the violent manner in which he calls down at times the vengeance of God upon the heads of his adversaries; while at others, he humbles himself to the dust on account of his own iniquities. On his style and manner, we cannot enlarge here; suffice it to add, that his lyrics have deservedly been counted among the gems of all human literature for well-nigh 3000 years—quite apart from their sacred liturgical character. Asaph's psalms shew their author to have been a didactic poet of high order; but, as we said before, many of those ascribed to him belong to poets later than the schiam, and even posterior to the Exile. The Korahite hymns, although all more or less fraught with the same depth of feeling, the same consciousness, the same grandeur and lyrical exaltation, exhibit signs of being written partly during the time of Solomon, or even during the Exile. Of the anonymous psalms, some may fairly be added to the number of those that issued from the hand of the royal singer himself; others, however, belong to the post-exilian times. Some of these (the hallelujahs, for instance, or the 'Songs of

Degrees') were, in all probability, pilgrim-songs, chanted during the ascent to the sanctuary. Whether other psalms belong to the Maccabean period or not—a question hotly disputed—we cannot discuss here.

There is a great deal in favour of the opinion that the collection and redaction of the book, such as we have it now, is owing to one man, who arranged the single hymns according to their contents and tendency. Thus, following all the while the law of analogy, the redactor gave the first place to David's and his contemporaries (Asaph, Ethan, Heman) compositions. These were further classified according to the prevalent use of the peculiar divine name (Jehovistic and Elohistie), and were divided into three books—the first of which contains the Davidic Jehovistic psalms; the second, the Elohistie ones of the Korahites, of Asaph, David, Solomon, and some unknown poets; the third, the rest of Asaph's and the Korahite psalms of a mixed (Jehovah-Elohistie, or purely Jehovistic) nature. The arrangement within these larger classes was made, again, according to the inner nature and relation of these hymns to each other, and by a certain likeness in phraseology, similes, &c. Psalms i. and ii. were then prefixed, on account of their generally introductory matter and manner. The same laws have also been followed in the remaining portions of the collection.

It is difficult to fix the period of the redaction. Assuming, however, the collecting and editing to be the work of one man, he could not possibly have lived before the time of Nehemiah, even according to those who affirm the non-existence of Maccabean psalms in our canon. If, on the other hand, various single collections are assumed, out of which our present book has grown, there is no reason why some of those should not be placed at a much earlier date. We forbear to add a list of writers on the subject of psalms. Nearly all the principal authorities in biblical literature, in the Jewish, Roman, and Protestant churches, have contributed their share towards the elucidation of the Psalms; and to the individual works of the chief biblical commentators, the reader is referred for special information. Le Long, in his *Bibliotheca Sacra*, enumerates more than 500 commentators on the Psalms, and Calmet carries the number up to a thousand. Of these, some are very voluminous, that of Le Blanc filling no fewer than six folio volumes.

**PSAMMETICHUS**, the name of three kings of Egypt, of the 26th dynasty, distinguished on the monuments by different prænomena, and of two other persons of ancient history. The first and most notable P. was the son of Necho I. After the defeat and death of his father, he fled into Syria, and thence, by means of foreign aid, appears to have established himself as one of the twelve monarchs who then reigned over Egypt, with the rest of whom he was connected in a kind of federation. An oracle having declared that the monarchy of the whole country should go to that one who made a libation out of brass, P. fulfilled the condition by pouring it out of a brazen helmet. By the answer of another oracle, he was told that he should succeed by means of brazen men who would appear from the sea. Some Carian and Ionian pirates who appeared soon after in panoplies of brass on the shores of Egypt, answered the response of the oracle. P. engaged them in his service, and by their means finally subdued his rivals at Memphes, after a struggle of fifteen years' duration. He strengthened his power by employing Greek mercenaries, whom he settled at Daphnon and Pelusium, to protect the eastern

borders of Egypt, and whose headquarters were subsequently transferred to Memphis. To them he assigned the right wing, or post of honour in the army—their arms and discipline being far superior to that of the native troops. This proceeding gave great disgust to the Egyptian army, and on his refusing to send the Greeks home, after their term of service, the Elephantine garrison, of 240,000 men, deserted the country, and marched into Ethiopia beyond Meroë. Although exhorted, they refused to return. To protect Egypt from the Syrians, he besieged Azotus, which he finally took, after 29 years' siege. P. fostered in every way the Greek influence in Egypt, divided amongst them lands, encouraged the study of the language, and contracted alliances with the Athenians. He also facilitated the commerce, and opened the ports which had been hitherto closed. Under P., the arts revived, the sculpture and architecture imitated the older prototypes, and the government was remodelled on the plan of the ancient dynasties. In literature, a new handwriting, the demotic, was introduced. Egypt, however, had fallen into a national decadence, and its old polity and institutions, subverted by the foreign influence prevalent in the country, could not be restored. P. reigned, according to Manetho, 54 years; his reign closed about 609—610 B. C. The other personages of this name are of little importance.—Herodotus, ii. 154; Pliny, *Nat. Hist.* vi. 35; Diodorus, i. 67; Champollion-Figeac, *L'Égypte*, pp. 367—370; Sharpe, *Hist. Egypt.* p. 58.

**PSI'DIUM**. See **GUAVA**.

**PSITTA'CIDÆ**. See **PARROT**.

**PSKOV** (Ger. *Pleskau*), a government in the north-west of European Russia, lies south of the governments of St Petersburg and Novgorod. Area, 17,845 square miles; pop. 723,634, almost all Russians, except in the western districts, where there is a small number of Finns. The climate is temperate, the surface is hilly in the west, and the soil is of average fertility. Lake Pskov and Lake Ilmen receive almost all the drainage of the government, the river Velikaia falling into the former, and the Shelon, the Polista, and the Lovat into the latter. The rivers are navigable for rafts, and, nearer their mouths, for barges and ships. Lakes abound in the eastern and south-eastern districts. Agriculture is the staple employment; flax-growing being the most remunerative branch. The manufactures carried on in the government are inconsiderable. The St Petersburg and Warsaw Railway, by which ready access is afforded to the metropolitan market for the agricultural productions of P., is expected to have a beneficial influence in developing the industry and resources of the government.

**PSKOV**, a town in the north-west of European Russia, capital of the government of the same name, stands on the banks of the Velikaia, 180 miles south-south-west of St Petersburg by railway. During the 14th and 15th centuries, it made one in the confederation of the Hanse Towns, and had then a population greater than at present. In 1510, it was annexed to the kingdom of Moscow. During the wars with Lithuania, P. was a stronghold of great importance. It contains a cathedral, 41 churches, and 4 monasteries. Fish, obtained from Lake Peipus, and flax, are the principal articles of a foreign commerce which is not extensive. Pop. 15,457.

**PSORALEA**, a genus of plants of the natural order *Leguminosæ*, sub-order *Papilionaceæ*, having the calyx permanent after flowering, and its tube sprinkled with callous points; the legume one-seeded, sometimes ending in a beak. The flowers

are blue, purple, or white. The leaves are of various forms, but in general abruptly pinnate. Some of the species are natives of India; others of other warm countries.—*P. esculenta*, the BREAD-ROOT of North America, and *Prairie Apple* of the Canadian boatmen, is an herbaceous perennial, about a foot high, with a carrot-like root, swollen above the middle, and abounding in farinaceous matter. It is used as an article of food, both boiled and raw. In Britain, it requires the protection of a frame, in order to produce an abundant crop or large roots.

**PSORIASIS** (from the Greek word *psora*, which signifies a cutaneous eruption, supposed by some to be the itch) is now employed to signify a disease characterised by slight elevations of the surface of the skin covered with whitish scales. There are various forms of this disorder, such as *P. guttata* (which is the simplest kind, and derives its specific name from the scales not coalescing, but remaining distinct, like isolated drops of water on the skin); *P. diffusa*, when the disease spreads over large portions of the skin, and often renders the patient hideous to look at, the scaly incrustations being often interspersed with bleeding cracks and fissures in all directions; *P. inveterata*, which is merely the severer phase of the preceding form, and occurs chiefly in aged persons of broken-down constitution; and *P. gyrata*, a rare form, in which the disease occurs in narrow stripes or rings. The causes of psoriasis are very obscure. It is certainly not contagious, but there appears to be in some families an hereditary tendency to it. It is occasionally associated with gout and rheumatism. Persons of both sexes, of all ages, and of all conditions of life, are liable to it, although it is more common in middle and advanced life than in childhood. The treatment varies with the condition of the patient. A middle-aged, vigorous patient should be purged two or three times a week with sulphate of magnesia, should be restricted in his diet to vegetables and milk, should be debarred from all stimulants, and should take a warm bath daily. The internal remedies of most repute for this disease are—1. Decoction of dulcamara, from half a pint at first to a pint being taken in divided doses through the day; 2. Liquor potassæ, in doses of from half a drachm to a drachm, three times a day, in a glass of milk or beer; 3. Liquor arsenicalis, in doses of from three to four minims, three times a day, to be taken after meals; 4. Iodide of potassium, in five-grain doses, three times a day; and 5. Pitch pills. In very inveterate cases, tar ointment, first diluted with lard, or a weak ointment of iodide of sulphur, should be applied locally; but these should not be tried unless internal treatment fails.

**PSYCHÉ** (Gr. breath, or soul), a creation of the later mythology of Greece, or perhaps we should rather say, a personification of the human soul, devised by the later poets. Appuleius (q. v.) relates the following story about her, which is obviously allegorical. P. was the youngest of three daughters of a king. She was so exquisitely beautiful that mortals mistook her for Venus, and did not dare to love, but only to worship her. This excited the jealousy of the goddess, who sent Eros (Cupid) to inspire P. with a passion for the most contemptible of all men; but Eros was himself wounded as deeply by her glances as ever he had wounded others with his darts. Meanwhile, P.'s father wished to see his daughter married, and inquired about her at the oracle of Apollo, by whom he was told to bear the maiden in funeral robes to the summit of a hill, and

to leave her there alone, as she was destined to be the bride of a huge all-destroying snake monster, that terrified both gods and men. Amid loud wailing and lament, P. was borne to the fatal spot, and left trembling in horrible solitude, when suddenly a light-winged zephyr flew round her, and bore her off to a beautiful palace of pleasure belonging to Eros, who visited her, unseen and unknown, every night, and left her before morning broke. Here P. would have enjoyed perpetual delight, had she remembered the advice of her unknown lover, who warned her not to seek to know who he was. But her jealous sisters, whom, against Eros's injunction, she had allowed to visit her, working upon her curiosity, persuaded her that she was embracing a monster in the darkness of night; and having lighted a lamp when Eros was asleep, she saw with rapture that she was the mistress of the most handsome of gods. In her excitement, she let a drop of hot oil fall on the sleeper's shoulder, who awoke, upbraided her for her mistrust, and vanished. P. gave way to the most passionate grief; she even thought of drowning herself. After wandering about for some time, she came to the palace of Venus, where she was seized by the goddess, and kept as a slave. Eros, however, who still loved her, invisibly helped and comforted the hapless maiden, reconciled her to his mother, and was finally united to her in immortal wedlock. All critics have agreed to consider the story an allegory of the progress of the human soul through earthly passion and misfortune to pure celestial felicity.

**PSYCHOLOGY.** See MIND.

**PTARMIGAN** (*Lagopus*), a genus of *Tetraonidae*, differing from the true Grouse (q. v.) chiefly in having the toes thickly clothed with short feathers as well as the legs (*tarsi*). Hence the name *Lagopus*, a name used by Pliny, from the resemblance of the



Common Ptarmigan (*Lagopus mutus*).

foot to that of a hare. The bill is very short and clothed at the base with feathers. The species are natives of the northern parts of the world, and either of elevated or of strictly arctic regions. They are not polygamous, like the true grouse, nor do the males strut with erected and expanded tail. Most of the species change colour very much on the approach of winter, assuming a white, or nearly white plumage; and the diversities of colour have caused some confusion and difficulty concerning them. They are all much esteemed for the table. The COMMON

PTERICHTHYS—PTERODACTYL.

P., or GRAY P. (*L. vulgaris* or *L. mutus*), is a native of the most northern parts both of the Old and New Worlds. In Britain, it is now seldom seen much further south than the Grampians, and occurs only on high mountains. It was formerly an inhabitant of those of Cumberland and Wales. It is not found in Ireland. It is abundant in Norway, from which great numbers are annually brought to the London market. In arctic countries, the haunts of the P. are not mountain-tops, but low valleys and plains even to the sea-shore. In form and habits, it much resembles the Moorfowl (q. v.), but is rather smaller. The winter plumage is pure white, except a black band above the eye of the male, and some parts of the quill and tail feathers. The summer plumage is as beautifully adapted to the concealment of the bird from enemies, by its harmony with the general aspect of the ground, as that of winter; the male being mostly brownish-gray, with undulating lines of black; the wings, middle tail-feathers, and under parts of the body, white; the female similar, but with a prevalent yellow tinge. The plumage, however, varies very much, according to age, sex, and the season of the year. Ptarmigans seem to trust very much for safety to the facility with which they are able to elude observation, whether among the snows of winter or the lichen-covered rocks in summer, and an unaccustomed sportsman is often startled by a covey springing up close beside him, of which he had not previously observed one. The P. is capable of being tamed, and has even been found to breed in confinement. The voice of the P. is a low croaking cry. The name P. is a modification of the Gaelic name. The *Rock P.*, said to occur in the north of Scotland, and to be common in Norway, seems to be merely the common species in a particular state of plumage.—The Moorfowl (q. v.) is a species of Ptarmigan.—Another is the WILLOW P., or WILLOW GROUSE (*L. saliceti*), of the northern parts of the world, abundant in the arctic parts of America, and in Norway, from which great numbers are brought to the London market. Its summer plumage much resembles that of the moorfowl; but its winter plumage is white. It does not inhabit regions so cold or lofty as the common P., but loves thickets of willow and dwarf-birch. It is found in Europe as far south as the valleys of the Alps. In North America, it is partially migratory.—There are other species in Siberia, Iceland, the Rocky Mountains, the mountains of Mexico, &c.

PTERICHTHYS (Gr. wing-fish), a genus of ganoid fishes, peculiar to the beds of the Old Red Sandstone measure. Fragments of the bony case had been found in Russia as early as 1813; in 1840, they were described as belonging to a fish to which the generic name *Asterolepis* was given. In the same year, the late Hugh Miller exhibited to the members of the British Association the first specimen which gave an idea of the form of the fish, and to this Agassiz applied the generally-received name of P., from the wing-like appearance of the pectoral spines.

The head and anterior half of the body were covered with hard ganoid plates, fitting closely to each other, and forming a strong protecting case. The remainder of the trunk was flexible, and covered with small scales. The fish was furnished with a small dorsal fin, and the body terminated in a heterocercal tail; but neither of these, from their soft texture, is common in the fossil specimens. The creature was not fitted for rapid motion. The pectoral spines, which were at first erroneously supposed to be fins, were more probably used as weapons of defence, and perhaps they were also of service in assisting the P. to move along the

sandy bottoms on which it lived. The spines were composed of two segments, and were covered

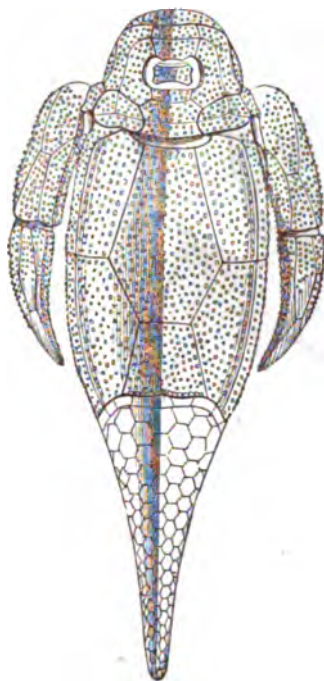

*Pterichthys Milleri* (Dorsal Surface).—From Owen.

with tubercles like the trunk. Twelve species of the genus have been described.

PTEROCLES. See GANGA.

PTERODACTYL (Gr. wing-finger), a remarkable genus of fossil lizards, peculiar to the Secondary strata. Its anomalous structure was long a puzzle to comparative anatomists. Blumenbach considered it a palmipede, or web-footed bird; while its original describer, Collini, and other more eminent naturalists, referred it to the mammalia, finding its nearest ally in the bat. The careful investigations of Cuvier, however, shewed that the P. was a true lizard, but possessed of the power of flight, which it performed, not by a membrane stretched over its ribs, like the living dragons, but more as in the bats, except that the wing was attached, not to several, but only to a single finger—the fifth—the others being free and short. The bones of the fifth finger were very greatly elongated, and the last joint terminated in a long, slender, unguarded apex; the terminal joints in the other fingers were furnished with strong claws. Mantell thus graphically describes the genus: 'With a long-snouted head and long neck much resembling that of a bird, bat-like wings, and a small trunk and tail, with lacertian affinities in its skull, teeth, and skeleton, and with a bird-like structure of sternum and scapular arch, these creatures present an anomaly of structure as unlike their fossil contemporaries as the duck-billed ornithorhynchus of Australia to living mammal.' The cranium is small; the jaws are long, and either armed with numerous, sharp-pointed teeth, or toothless, like those of a bird. The eye-orbit is very large; the sclerostica consists of a ring of bony plates, and the nostrils are placed near the orbits. The cervical vertebrae are large and strong, and capable of great flexibility backwards and forwards,

probably to allow the head to fall back to the centre of gravity during flight. The dorsal vertebræ are from 17 to 20 in number. The sacrum is formed by the coalescence of two vertebræ only, as in existing reptiles, and not of many, as in birds and certain extinct saurians. The tail is generally short, an unusual character with saurians; but a species with a long tail occurs at Solenhofen. There are five toes or digits on each foot; the outer finger of the forearm is immensely elongated for the support of a membranous expansion (the impression of which is preserved in some instances); and the other digits of fore and hind feet terminated in long curved claws. The size and



Pterodactyl.

form of the extremities shew that the Pterodactyl was capable of perching on trees, of hanging against perpendicular surfaces, and of standing firmly on the ground, when, with its wings folded, it might crawl on all-fours, or hop like a bird.' The famous quarry of lithographic stone at Solenhofen, of Upper Oolite age, has supplied a great variety of these flying lizards; but the largest species have been found in the Secondary beds of this country. In the Upper Greensand, at Cambridge, the remains of a species that must have had a spread of wing of 25 feet across, have been found; and in the Kentish Chalk, another has been met with very little short of this in its dimensions. The various species vary as much in structure as in form, so that the original genus has been lately raised to the position of an order, under the name of PTEROSAURIA, and the species have been arranged under the following genera, characterised principally by the structure of the jaw and teeth: *Pterodactylus*, in which the jaws are furnished with long slender teeth along their whole length; *Ramporhynchus*, with the extremities of the jaws smooth, probably furnished when living with a horny bill, and towards the bases of the jaws having four or five strong teeth; and *Dimorphodon*, with large strong teeth in front, and small shorter ones behind. Nearly 30 species have altogether been described.

**PTEROMYS.** See FLYING SQUIRREL.

**PTEROPODA** (Gr. wing-footed), a class of molluscs, having for their only organs of locomotion wing-like fins attached to

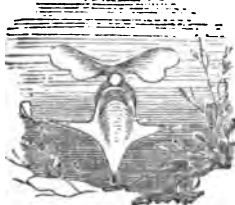

Example of the Pteropoda (*Cleodora pyramidata*).

the sides of the head or neck, one to each side, by which they make their way through the water, flapping them as a bird or an insect does its wings in the air. They are allied to *Gasteropoda*, but are inferior to them in organisation; and their wings are not at all homologous to the foot of that class. They are hermaphrodite. The head is perfectly distinct in some, but obscurely distinguished from the body in others. Those which have the head most distinct, as *Clio* (q. v.), have no shell, and form

the order *Gymnosomata*; those with the head indistinct, the order *Thecosomata*, have a thin external shell, which in some is globular, with alita for the wings to pass through, in some triangular and pyramidal, in some conical, in some slipper-shaped, &c. All the species are marine; they are small and delicate creatures, very lively and active, always in quest of food, and affording food to fishes and cetaceans. They are found in all parts of the world, some of them in immense numbers in tropical, and some in arctic seas. None of them are common on the British coasts. The genera and species are few.

**PTOLEMAIC SYSTEM** of Astronomy, so called from Ptolemy (q. v.), its chief expounder, was originated, however, long before his time, and was, in fact, merely an attempt to reduce to a scientific form the common and primitive notions concerning the motions of the heavenly bodies. It was implicitly adopted by Plato, Aristotle, Hipparchus, and (with the exception of the Pythagoreans, and probably of Pythagoras himself) all the eminent physicists and philosophers of ancient times; passing from them to the Byzantines and Arabs, who, especially the latter, were the means of disseminating it through Western Europe, where it continued to be the universally established doctrine till the 16th century. The primary and fundamental doctrines of this system are that the earth is the centre of the universe, and that the heavenly bodies revolve round it in circles, and at a uniform rate. These notions, which are naturally suggested by the first general aspect of things, having, previous to any accurate observation, established themselves as unquestionable axioms, phenomena which were found, on closer examination, to be inconsistent with them, were explained by the introduction of additional hypotheses. The belief that the earth is the centre of the universe, was supported by its being in accordance with the relation of the primary elements of which the material world was supposed to be composed. Thus, earth, the most stable of the elements, held the lowest place, and supported water, the second in order; above water was placed air, and then fire, ether being supposed to extend indefinitely above the others. In or beyond the ether element were certain zones or heavens, each heaven containing an immense crystalline spherical shell, the smallest enclosing the earth and its superincumbent elements, and the larger spheres enclosing the smaller. To each of these spheres was attached a heavenly body, which, by the revolution of the crystalline, was made to move round the earth. The first or innermost sphere was that of the moon, and after it in order came those of Mercury, Venus, the Sun, Mars, Jupiter, Saturn, and the fixed stars, eight in all. To this system, later astronomers added a ninth sphere, the motion of which should produce the precession of the Equinoxes (q. v.), and a tenth, to cause the alternation of day and night. This tenth sphere, or *primum mobile*, was supposed to revolve from east to west in 24 hours, and to carry the others along with it in its motion; but the Ptolemaic astronomers do not venture to explain how this was done, although since the axis of motion of the *primum mobile* was that of the equator, its extremities being the poles of the heavens, while that of the ninth sphere was the axis of the ecliptic, some explanation was certainly necessary. As observations of the heavens became increased in accuracy, it was found that the heavenly motions were apparently not uniform, and this was explained as follows: The acceleration of the sun on one side, and retardation on the other side of his orbit, is only apparent, and

results from the earth not being in the centre of his sphere, O (see fig.), but at E, and consequently his motion appears to be slowest at P, and

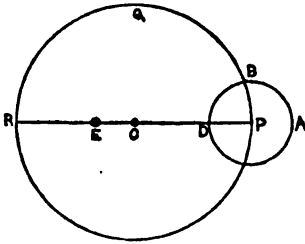

quickest at R. The alternate progression and regression of the planets was accounted for by supposing them to move, not directly with their crystallines, but in a small circle, whose centre was a fixed point in the crystalline, and which revolved on its axis as it was carried round with the latter; thus (fig.) the planet was carried round the small circle ABD, as that circle was carried round PQR (now supposed to represent the planetary crystalline). The planet, while in the outer portion of its small circle, would thus have a forward, and in the inner portion a backward motion. The larger circle was called an *eccentric*, and the smaller an *epicycle*. This theory of eccentrics and epicycles satisfied the early astronomers; but further investigation shewed its incompleteness, and in later times it was found necessary to explain newly-discovered discrepancies by heaping epicycle upon epicycle, till such a complication of the system had been produced, as drew from Alfonso X. of Castile, to whom the P. S. was being explained, the humorous though somewhat blasphemous remark, that 'if the Deity were now to reconstruct the world, he (Alfonso) could give him a few useful hints.' As soon as astronomers came to understand and test the *Copernican Theory* (q. v.), the venerable and disorderly pile of hypotheses, the then representative of the P. S., which had received the papal seal of infallibility, and had in various forms held supreme sway over the minds of men for twenty centuries, at once crumbled to atoms, and sunk into oblivion.

**PTOLEMAIS.** See **ACRE**.

**PTOLEMY I.**, son of Lagus, is also known by his surname **SOTER**, or the Preserver. He was believed by some to be the son of Philip of Macedon, because his mother, Arsinoë, had been a concubine of that king, his father being a Macedonian of humble station. P. acted as one of Alexander's generals in his eastern campaigns; and when the possessions of the great conqueror were divided, after his death at Babylon, 323 B. C., Egypt fell to the lot of the son of Lagus. Troubles soon followed such an acquisition; but P. was a man of energy and valour, and not only warded off danger from his own realm, but also extended his dominions by the addition of Phœnicia and Coele-Syria, capturing Jerusalem, too (most probably in this expedition), by assaulting it on the Sabbath-day. In 316 B. C., war again broke out between P., Lysimachus, and Casander on the one hand, and Antigonus on the other. (See these names.) It lasted till 301 B. C.; and at its conclusion P. was left in possession of almost the same territory as he ruled at its commencement, with the exception of Cyprus, which, by the naval battle off Salamis in that island (306 B. C.), was gained by Antigonus. P., however, recovered Cyprus in 295 B. C., and it was thereafter attached to the Egyptian kingdom.

After said battle of Salamis, in 306 B. C., Antigonus assumed the title of king, which example P. and the other successors of Alexander followed. In 305 B. C., P. compelled Demetrius, the valiant son of Antigonus, to raise the siege of Rhodes, for which deliverance the Rhodians were so grateful that they worshipped him as a deity, and conferred on him the title of *Soter*, or Preserver. The latter part of his reign was peace. He governed his kingdom with an enlightened and vigorous policy, and so laid the foundation of that prosperity which Egypt enjoyed for many succeeding generations. He encouraged commerce, and soon made Alexandria the great mart of the Mediterranean. He fostered literature, science, and art; and not only founded the famous Museum and Library of Alexandria, but also entertained at his court the votaries of the Muses; Euclid, the geometrician; Stilpo, the philosopher; Philetas, the elegiac poet; Zenodotus, the grammarian; Antiphilus and Apelles, the painters; with many others. The history of Alexander's wars, by P., is the basis of Arrian's work on the same subject. Two years before his death, which occurred in 283 B. C., he abdicated in favour of his son, Ptolemy Philadelphus. His reign extended from 323 to 285 B. C.

**PTOLEMY II.**, surnamed **PHILADELPHUS**, was the son of Ptolemy I. and Berenice. He was born, 309 B. C., in the island of Cos. His reign is remarkable rather for the successful cultivation of the arts of peace than of the practice of war. Excepting a contest with his half-brother, Magas, for the province of Cyrene, his wars against Syria are almost the only military exploits which interfered with the prosecution of those designs for the improvement of his kingdom, which have rendered his name famous among wise and enlightened sovereigns. He carried on, with even increased zeal, the good work which his father had begun. He enriched the library of Alexandria with all the literary treasures of his own and of earlier times, and the museum was crowded with the learned from all countries—with such men as Theocritus and Philetas, the poets; Euclid, the geometrician; Aristarchus and Aratus, the astronomers; Theodoros and Hegesias, the philosophers; and many more. Tradition alleges that it was by his orders the Hebrew Scriptures were translated into Greek, and the version called the 'Septuagint' (q. v.) thus formed. He induced Manetho to write, in Greek, a political history of Egypt, and an account of the religious tenets of the Egyptians. He encouraged the study of natural history; and to facilitate the pursuits of those who devoted themselves to it, he formed a collection of rare and curious animals in the preserves, which we may call the 'Royal Zoological Gardens' of Egypt. He founded many colonies in those parts of his empire which seemed specially suited to become centres of trade and of enlightenment, and thus spread more widely the seeds of civilisation and Greek culture; among these was Ptolemais (Acre), in Palestine. He ruled over Egypt, Phœnicia, and Coele-Syria, Lycia, Caria, Cyprus, and the Cyclades, with parts of Arabia, Libya, and Ethiopia. His son Ptolemy married Berenice, the daughter of Magas, and the province of Cyrene was thus peacefully brought back to his empire. Under P. Philadelphus, Egypt rose to a high rank among the nations in power and in wealth. The surname of Philadelphus was assumed by P. to indicate his great affection for his sister Arsinoë, whom he married after the death of her husband, Lysimachus. His former wife, Arsinoë, daughter of Lysimachus, was banished by him; and two of his brothers were put to death. It is with reference to this last circumstance that



PTOLEMY III.—PTOLEMY VII.

some have explained the name Philadelphus, as in irony. By his first wife, he had two sons, Ptolemy, his successor, and Lysimachus; and one daughter, Berenice, married to Antiochus II., king of Syria. He reigned from 285 to 247 B. C.

**PTOLEMY III.**, surnamed **EUERGETES**, succeeded his father Philadelphus, and reigned from 247 to 222 B. C. He made war on the kingdom of Syria, to avenge the death of his sister Berenice, who had been murdered at the instigation of Laodice, former wife of Antiochus. He overran all the provinces as far south as Babylon and Susa; those on the north and east as far as Bactria and India, offered him homage; and he might have extended the bounds of his empire much further, had not domestic troubles compelled him to hasten back to Egypt. The treasures he brought with him were immense; and among the things most highly prized were the statues of the Egyptian gods which Cambyses had carried off to Babylon in 525 B. C. It was the restoration of these to their proper temples which gained for P. the title of Euergetes (the Benefactor). His fleets gained many possessions on the coast of the Mediterranean, such as Pamphylia, Cilicia, and Ionia, which remained for a long time subject to Egypt, though the eastern provinces recently conquered soon returned to their former sovereign. He pushed the limits of the home-empire further south, by conquering part of Ethiopia, where he formed a colony and centre of trade at Adule. P., like his predecessors, patronised learned men, and encouraged the study of the arts and sciences. He added so largely to the library of Alexandria that he has by some been called its founder. Among the celebrated men who adorned his court, and kept up the fame of the 'Museum,' were Apollonius Rhodius, Eratosthenes, and Aristophanes, the grammarian. In his reign, the Egyptian kingdom reached the highest point of military glory, prosperity, and wealth.

**PTOLEMY IV.**, surnamed **PHILOPATOR**, reigned from 222 to 205 B. C. He was the unworthy son of the preceding king. His reign began in blood by the murder of his mother Berenice, his brother Magas, and his uncle Lysimachus; and it ended in blood by the violent death of his wife Arsinoë. He abandoned himself to debauchery, and intrusted the management of his kingdom to favourites. Antiochus, king of Syria, profiting by his indolence, wrested from him in war some of the provinces which his father had gained; but P., at length roused from his lethargy, took the field in person, and defeated Antiochus at the battle of Raphia. When peace was concluded, P. returned to his capital, and plunged with increased zest into every vice and indulgence. He died in 205 B. C.; his death being hastened by his excesses. He followed the example of his father and grandfather in patronising arts and letters, and cultivated friendship with the Romans, to whom he sent large supplies of grain during the second Punic War, but persecuted the Jews, against whom he had conceived a hatred in consequence of being refused admittance to the sanctuary at Jerusalem by the high priest.

**PTOLEMY V.**, **EPIPHANES**, succeeded to the throne of his father Philopator, when only five years of age, and reigned from 205 to 181 B. C. His dominions were invaded by Antiochus, king of Syria, and Philip, king of Macedonia, while he was still an infant, and several provinces were severed from the Egyptian kingdom; but the Romans at length interfered, and peace was concluded, it being arranged that P. should marry Cleopatra, daughter of Antiochus, and receive as her dowry those parts

of his empire in Syria which had been taken from him. He was declared of age in 196 B. C., and his coronation was performed with unusual splendor. The decree published on this occasion is that which forms the inscription on the far-famed Rosetta Stone (q. v.). P. married Cleopatra in 193 B. C. The affairs of the kingdom were managed by the wise and virtuous Aristomenes, and so long as P. followed his counsels, all went well. But the king's ear was gradually opened to insinuations against his great minister, whom he ultimately compelled to drink poison. While P. was preparing for an expedition against Syria, he was poisoned by some of his followers, whom he had alarmed for their own safety. Under him, Egypt rapidly sank in prosperity, power, and reputation.

**PTOLEMY VI.**, **PHILOMETOR**, reigned from 181 to 146 B. C. He was very young at his father's death, and the affairs of the kingdom were therefore directed by his mother Cleopatra, who acted with remarkable prudence and energy. When she died in 173 B. C., the administration fell into the hands of two worthless ministers, Eulaeus and Lenæus, who, engaging in war with Antiochus, brought the kingdom to the brink of ruin. The young king was taken prisoner by Antiochus (170 B. C.), who hoped to obtain possession of the whole of Egypt; but his younger brother, also called Ptolemy, immediately declared himself sovereign under the title of Euergetes II., and took vigorous measures to defend the kingdom. By the intervention of the Romans, Antiochus was compelled to return to his kingdom. The brothers reigned jointly for some time, but at length quarrelled, and a civil war ensued in which Euergetes II. was ultimately worsted. The deputies of the Roman Senate, who now did as they pleased in Egypt, arranged that P. Philometor should retain Egypt proper, while Euergetes II. should obtain Cyrene as a separate sovereignty. This settlement substantially held during the lifetime of the former. P. reigned 35 years, and died in 146 B. C., from injuries received by a fall from his horse in a battle against the Syrian usurper Alexander Balas. He is celebrated for his mild and humane disposition, which was strikingly evinced in his magnanimous treatment of his unworthy brother.

**PTOLEMY VII.**, or **EUERGETES II.**, best known by the nickname **PHYSOON**, or *Big-belly*, ascended the throne after the death of his brother. He married his brother's sister and widow, Cleopatra (who was also his own sister), and on the same day murdered her infant son P. Eupator, whom she had at first declared king. The history of his reign is one unbroken record of murder and blood, whence his subjects nicknamed him *Kabergetes* ('the malefactor'). Not only relatives who stood in his way to the throne, but those who opposed his accession, and even innocent persons, were butchered with savage cruelty. His private vices and debaucheries were equally infamous. He divorced his wife and sister Cleopatra to marry her daughter by her first husband—his own brother; and when temporarily driven from his throne, 130—127 B. C., by the indignation of his subjects, who chose the divorced Cleopatra in his room, the monster took a diabolical revenge by murdering his own and Cleopatra's son, and sending the head and hands as a present to the latter on her birthday. One is almost ashamed to add that he retained the hereditary taste for learning, and patronised learned men. He himself wrote a work of 24 books, called *Memoirs* (*Hypomnemata*). He reigned from 146 to 117 B. C.

Besides these, there are several Ptolemies of less

note—as, for example, PTOLEMY VIII., or SOTER II., otherwise called LATHYRUS or LATHURUS, who reigned first from 117 to 107 B.C., and again from 89 to 81 B.C.; also PTOLEMY IX., or ALEXANDER I., youngest son of Ptolemy VII., who reigned from 107 to 90 B.C.; PTOLEMY X., or ALEXANDER II., son of Alexander I., 81—80 B.C.; PTOLEMY XI., or DIONYSUS, or AULETES, an illegitimate son of Ptolemy Lathyrus, who reigned from 80 to 51 B.C.; PTOLEMY XII., who reigned for some time in conjunction with his sister Cleopatra, and who was ultimately drowned in the Nile, after being defeated by Cæsar; and lastly, PTOLEMY XIII., younger brother of the preceding. Cæsar appointed him joint ruler with Cleopatra, his sister and intended wife. He died by violence in 43 B.C., at the instigation of Cleopatra.

PTOLEMY, a celebrated astronomer and geographer, whose proper name is CLAUDIUS PTOLEMÆUS, was a native of Egypt, though it is uncertain whether he was born at Pelusium or Ptolemais in the Thebaid. Nothing is known of his personal history, except that he flourished in Alexandria in 139 A.D., and there is probable evidence of his having been alive in 161 A.D. The chief of his writings are: *Megalē Syntaxis tēs Astronomias*, which, to distinguish it from the next-mentioned, was probably denominated by the Arabs *megistē*, the greatest, whence was derived the name *Almagest* (Arab. article *al*, the), by which it is generally known; *Tetrabiblos Syntaxis*, with which is combined another work, called *Karpōs* or *Centiloquium*, from its containing a hundred aphorisms, both works treating of astrological subjects, and held by some on this account to be of doubtful genuineness; *Phasēs aplanōn asterōn kai synagōgēs epistēmaseiōn*, a treatise on the phenomena of the fixed stars, or a species of almanac; the *Geographikē Hyphēgētis*, his great geographical work, in eight books. The rest of his works are of inferior importance, and consist of descriptions of various kinds of Projections (q. v.), the theory of the musical scale, chronological and metaphysical treatises, and a summary of the hypotheses employed in his great work, the *Almagest*. Others of P.'s works have been lost, and it is still a moot-point whether or not they contained a treatise on Optics, as a Latin version of what is said to have been an Arabic translation of P.'s original treatise on that subject is still in existence.

P., both as an astronomer and geographer, held supreme sway over the minds of almost all the scientific men from his own time down till about the 15th c.; but, and in astronomy specially, he seems to have been not so much an independent investigator as a corrector and improver of the work of his predecessors. In astronomy, he had the labours of Hipparchus to guide him; and, indeed, scrupulously distinguishes between Hipparchus's labours and his own. To P. belongs the invention of a planetary theory, the discovery of the moon's Evection (q. v.), and the singular distinction of being the sole existing authority on the subject of ancient astronomy. From this last-mentioned fact, the system of astronomy which he sets forth in the *Almagest* received his name; and, as the *Ptolemaic System* (q. v.), obtained the homage of succeeding generations till the time of Copernicus. His great work, the *Almagest*, is divided into 13 books. P. seems to have been little of an independent observer, trusting implicitly to his predecessor, Hipparchus; but his geometrical powers were of a very high order, unless, as Delambre suggests, but with little probability, the elegant demonstrations here and there occurring in the *Almagest* were borrowed from other sources.

As a geographer, P. occupies a similar position to what he holds in astronomy; he appears before his readers as the corrector and improver of the works of a predecessor, Marinus of Tyre, about whom, except from P.'s writings, little is known. P. here appears to more advantage as an independent investigator, and his improvements and suggestions are at once more valuable and correct; but it is sometimes difficult to separate his data from those of Marinus. His geography is divided into eight books, all of which, with the exception of the first, eighth, and a portion of the seventh, are nothing more than a catalogue of places, with their latitude and longitude (to 12ths of a degree), with a brief general description prefixed to each continent and country or tribe, and interspersed here and there with remarks of a miscellaneous character on any point of interest. The rest of the work contains details regarding his mode of noting the positions of places—by latitude (*mēkos*) and longitude (*platos*)—with the calculation of the size of the sphere of the earth, and of the extent of surface then known. He also describes the mode adopted by him of projecting the surface of a hemisphere on a flat surface, and shews its superiority over the projections of Eratosthenes, Hipparchus, and Marinus. He also constructed a series of twenty-six maps, together with a general map of the world, in illustration of his work.

The *Almagest* and the *Geography* were the standard text-books to succeeding ages, the first till the time of Copernicus, the second till the great maritime discoveries of the 15th c. shewed its deficiencies. They have passed through numerous editions, the best of which are, for the *Almagest* and the most of P.'s minor works, that by Halma (Paris, 1813—16—19—20, quarto); and for the *Geography*, the Latin versions of 1482 and 1490, published at Rome, the *editio princeps* of the Greek text by Erasmus (Basel, 1533, 4to), and the Elzevir edition (Lugd. Bat. 1619, fol.). The catalogue of stars has been frequently reprinted separately, the last and best edition being that of Francis Baily, in vol. xiii. of the *Memoirs of the Royal Astronomical Society* (London, 1843).

PTO'SIS (from the Gr. *πτίπτω*, I fall) signifies a drooping or falling of the upper eyelid, and arises from palsy of the third or *motor oculi* nerve. It may arise either from debility, in which case it may be removed by tonics; or from congestion of the brain, when it is usually accompanied with giddiness, headache, &c., and should be treated by bleeding, purgatives, and low diet; or from organic disease of the brain, in which case remedies are of little use. If it occurs without any apparent cause, and resists medical treatment, it may be removed by a surgical operation, by which the eyelid is brought under the action of the occipito-frontal muscle, which receives its nervous power from another source.

PTYCHODUS, a genus of cretaceous fish, founded on large square crushing teeth, which occur in considerable quantity in the Chalk beds. The crown of the teeth are raised in the centre into a number of parallel transverse ridges, and the flat margin is finely granulated. They were set, as in the Port Jackson shark, like a pavement on the borders of the mouth, and were admirably adapted to crush the shells of the crustacea and mollusca on which they fed. Large dorsal spines have been found associated with the teeth; but as no materials exist for the restoration of the external form of the fish, the analogy of their modern representative, the Port Jackson shark, alone suggests that they belonged to the Ptychodus.

## PUBLICANI—PUBLIC-HOUSES.

**PUBLICANI** (from Lat. *publicum*, that which is public or belongs to the state), the name given by the Romans to those persons who farmed the public revenues (*pectungalia*). These revenues were put up to auction by the censors, and were 'sold' for a period of five years. They were derived chiefly from tolls, tithes, harbour-duties, *scriptura* (the tax paid for the use of public pasture-lands), mining and salt duties. As the state required the publicani to give security for the sum at which they had purchased the collecting of the taxes, and as this sum was usually much greater than the wealth of any single individual, companies (*societates*) were formed, the members of which took each so many shares and were thus enabled to carry on conjointly undertakings far beyond the capabilities of the separate shareholders. Their contract with the Roman government was made in the name of a single person, who was called *maniceps*, and who was held responsible for his *socii* to the state. Every *societas* had also a head-manager (*magister*), who resided at Rome, and transacted all foreign correspondence with the inferior officers who directly superintended the collection of the taxes. In general, a *societas* farmed only one branch of the revenue, but exceptions occur. Only Roman citizens were eligible as publicani, and, as a matter of course, only the wealthiest among these could become such. After the middle of the 2d c. B.C., the farming of the public revenues fell into the hands chiefly of the Equites (q. v.). By a wise regulation, no governor of a Roman province was allowed, during the period of his governorship, to have anything to do with these tax-gathering companies. The design of this was to place the governor in such a position that he could afford to act justly towards the people, who were often cruelly oppressed by the exactions of the provincial underlings—the 'publicans' of the New Testament.

**PUBLIC BURDENS** is a phrase in Scotch law to denote the usual taxes or charges on land, in respect both of its ownership and possession. Such are the land-tax, minister's stipend, manse assessments, schoolmaster's salary, poor-rates, rogue-money, road and bridge assessments. Public burdens, where no stipulation is made to the contrary, fall upon the landlord, and not on the tenant, except in the case of schoolmaster's salary, which is equally divided between landlord and tenant.

**PUBLIC HEALTH ACT** is an important act in England regulating sanitary matters (11 and 12 Vict. c. 63). It enabled local boards of health to be created all over England. The initiative was given to one-tenth of the rated inhabitants of cities, boroughs, parishes, and places having a defined boundary, to take proceedings to have the act applied to their district, whereupon and so to deal systematically with sewerage, drainage, water-supply, paving, lighting, watching. The General Board of Health first send an inspector to report, and afterwards direct the act to apply. The act has been further supplemented by a family of kindred acts called the Local Government Acts, the Nuisances Removal Acts, and the Prevention of Diseases Acts. The state of the law produced by these combined statutes is very complicated, but the result is greatly to extend sanitary improvements.

**PUBLIC-HOUSES** in England are known under two classes, viz., Ale-houses, also called Inns (q. v.), and Beer-houses. The former give board and lodging to travellers, while the latter are mere shops for the sale of beer to be consumed on the premises.—1. An ale-house must be first licensed by the justices, before the keeper of it can sell excisable liquors to be consumed on the premises. The granting of the

licence may be opposed by any inhabitant. The justices' licence is not enough to enable the publican to sell liquors, but it is absolutely essential; and an excise licence must follow, and not precede the justices' licence. The licence is in force for one year; and if any offence or misconduct is committed, the renewal of the licence may be opposed, and refused on the next meeting. The licence compels the keeper to keep unadulterated liquor, to use only legal measures, not to permit drunkenness or unlawful games, or bad characters, to keep good order, and lastly, not to open his house, except to travellers, on Sundays during the morning and afternoon divine service. The law as to the opening of public-houses during Sunday has been altered considerably of late years; but the present state of the law is as follows: no public-house can be opened for the sale of fermented or distilled liquors before half-past 12 at noon on Sunday, or, if the morning divine service is not then terminated, before such termination. It must be again shut between 3 and 5 P.M., and shut altogether at 11 P.M., until 4 A.M. of the following morning. Christmas-day and Good Friday, and public fast or thanksgiving days, are treated as Sundays. The same law applies to beer-houses and all places of public resort where fermented and distilled liquors are sold. Travellers are expressly excepted from the above rule, and the decisions of courts of law have settled the point that a traveller is a person who walks or drives a few miles out of town, whether for pleasure or on business. As regards public-houses, constables have the power of entering them at all times, and it is an offence in the publican to refuse them admission.—2. Beer-houses are subject to the same rules as ale-houses on Sundays. They do not require, however, to be licensed by justices. Any person who can produce a certificate of the overseers that he is the occupier and tenant of a house paying above £8 in the country, or £11 in large towns, and £15 in London of rent, can demand a licence from the excise, which is renewable each 10th of October. A board must be put over the door, and state that it is a licensed beer-house. The keeper of a beer-house can only sell beer, porter, ale, cider, or perry, but not wine or spirits, though he may, if he choose, obtain a separate wine licence. In London, he must close his shop between midnight and 5 A.M. of the next morning; and in towns of at least 2500 inhabitants, at 11 P.M., and elsewhere at 10 P.M. on week-days. Constables have free access to beer-houses as well as ale-houses. Though beer-houses are thus restricted as to the hour of closing at night, there is no restriction on ale-houses, except on the Sunday night, and therefore ale-house keepers may keep open their houses all the night long on other days of the week, if they think fit. But there was a restriction imposed in 1864 by 27 and 28 Vict. c. 64, whereby all public-houses and refreshment-houses in the metropolitan police-district must be closed between 1 and 4 A.M. Publicans are, as already stated, prohibited from allowing games in their houses; and it has been held that a publican cannot even allow his friends in his own back-parlour, though it is separated from the rest of the house, to practise this gaming, provided it is a game for money. There was a restriction imposed by the Tippling Act, 24 Geo. II. c. 40, on the keepers of ale-houses as regards debts for spirits under 20s., by which they could not recover payment of these small scores; but that enactment was repealed, except only as regards spirits sold to be consumed elsewhere than on the premises, and delivered to the purchaser in less quantities at one time than a quart. So that publicans are still prohibited, by 25 and 26 Vict. c. 38, from suing for debts due for small

quantities of spirits sent out of the house to purchasers.

In Scotland, the law affecting public-houses has been considerably altered of late years, and the governing statute is now 25 and 26 Vict. c. 35. Certificates for the sale of excisable liquors must be applied for to the justices of the peace, who meet for the purpose in April and October. The justices have a discretion in particular localities as to fixing the hours of closing within certain limits. Certificates to sell wines and spirits include power to sell beer and cider also; but they may be granted for the sale of wine, porter, ale, beer, cider, and perry only; or for beer, porter, ale, cider, and perry only; so that there are three kinds of certificates, corresponding to what exists in England. The justices' certificate also must be obtained for the spirit and wine licence, before application for the excise licence. The justices have power, in special circumstances, to regulate the hours of closing; but the general hours of closing in all cases are as follows: the houses shall not be open for sale or drinking before 8 A.M., nor after 11 P.M., with the exception of refreshment to travellers, or to persons lodging in the premises: and the house shall not be opened for the sale of any excisable liquors, or drinking thereof, on Sunday, except for the accommodation of lodgers and travellers. Though, however, on Sundays, travellers and lodgers only are to be supplied with drink, this is only so in the case of inns and hotels; for with regard to public-houses proper, and spirit or beer-shops, these are not allowed to be open on Sundays even to travellers or lodgers. The certificate of justices is granted on the same conditions as to good order as in England. The owner of any property in the neighbourhood may object to the granting or renewing of the certificate. Constables may enter at any time eating-houses, if they suspect excisable liquors are unlawfully sold there. The chief officer of police is to report to the procurator-fiscal the places where intoxicated persons are seen frequently to issue. Persons keeping shebeens, or uncertificated places where spirits or excisable liquors are sold or drunk, are punished heavily, and also the persons found drunk there may be fined 10s. The main difference between English and Scotch inns and public-houses is the shutting up these for the whole Sunday in Scotland. In both countries, travellers are excepted; though the same definition will and ought to be given to that word in both countries, still there is a penalty imposed in Scotland of £5 on any person who falsely represents himself to be a traveller, so as to procure entertainment and drink in an inn; whereas no such penalty is imposed in England, the only person who runs the risk there is the innkeeper himself, and he, of course, cannot be convicted unless it is shewn he actually knew that the party representing himself to be a traveller was not so. The policy of these restrictions on the closing of inns and public-houses on Sunday has been much discussed of late years.

**PUBLIC PROSECUTOR.** See PROSECUTOR.

**PUBLIC SCHOOLS.** See SCHOOLS.

**PUD, or POOD,** a Russian weight which contains 40 Russian pounds—almost equivalent to 36 English pounds avoirdupois.

**PUDDING,** although a word in such common use, and so generally understood, is very difficult to define, for there are few preparations of cookery so varied. It may be considered one of the national dishes of Great Britain; in no other country is it used so extensively by all classes of the people. The plum-pudding is the glory of an English table, and is regarded as an essential on all festive occasions. Puddings are either made

of dough simply boiled in a cloth or basin, and with or without other materials; or they may be made of a batter of flour, or other farinaceous material, and water, and poured into the pudding-cloth and boiled; or into a dish and baked. It is common also to make fruit and meat puddings, by rolling out dough or paste into large flat sheets, and enclosing the fruit or meat entirely in them, and then tying them up in the pudding-cloth and boiling them. These are the general characters of this dish, but the recipes for varying the details are innumerable.

**PUDDING-STONE,** a rock composed of water-worn pebbles, cemented together by a firm paste. It is now more generally known as Conglomerate (q. v.).

**P'UDDLING,** a process by which wells, ponds, canals, &c., are lined with clay or loam impervious to water. See EMBANKMENT.

**PUEBLA, or PUEBLA DE LOS ANGELES,** a city of Mexico, capital of a state of the same name, stands on a fruitful plain, 7391 feet above sea-level, and 76 miles east-south-east of the city of Mexico. In the vicinity are Orizaba, Popocatepetl, and other lofty mountains. It was founded in 1531, and, after the capital, it is not only the most populous, but also the most industrious city in the empire. Its streets are regular, broad, and well paved. The houses, which are frequently three stories in height, are flat-roofed, covered with variously-coloured tiles, and profusely ornamented, both inside and out, with fantastic paintings resembling frescoes. There are 44 fountains, and the water is supplied by means of an aqueduct. It contains 69 churches, 9 monasteries, 13 convents, and 23 theological colleges. On the great square stands the cathedral, an imposing building, the interior of which is decorated in the most sumptuous manner with ornaments of gold and silver, paintings, statues, &c. Among the numerous educational institutions, there are several of the highest class. There are also hospitals, the government and the bishop's palaces, charity schools, and other benevolent institutions. The more wealthy inhabitants are accomplished, refined, and benevolent; but the lower classes are esteemed the most demoralised in the empire. Glass, earthen-ware, soap, woollen fabrics, and sword-blades are manufactured. Pop. (1862) 85,000. After a siege of three months, the Mexican troops surrendered to the French, May 1863. See VERA CRUZ.

**PUERPERAL FEVER** is the most fatal disease to which women in childbed are liable. It has been described under various other names than that which is now assigned to it—as *Childbed Fever*, *Peritoneal Fever*, &c. A careful investigation of the records of more than two centuries shews that the disease prevails epidemically, and that it is more virulent in lying-in hospitals than in private practice. The essential nature of the disease is a subject that has led to the expression of many different opinions. The views that it is (1) *inflammation of the uterus*, (2) *inflammation of the omentum and intestines*, (3) *peritonitis, either alone or connected with erysipelas*, (4) *fever of a special nature*, (5) *disease of a putrid character*, or (6) *a disease of a complicated nature*, have all been advocated by physicians of high reputation; and Professor Scanzoni, one of the highest German authorities in the department of midwifery, maintains that the disease originates in an altered condition of the blood, and consists mainly in the presence of pus in that fluid. This variety of views is doubtless, in a great measure, due to the varied characteristics of different epidemics. When a disease is epidemic, it is always difficult to ascertain whether it is contagious; but in the case of

puerperal fever, there is an overwhelming amount of evidence, not only that the virus can be carried by the practitioner from one parturient woman to another, but from various other morbid sources; the peculiar condition of childbirth, and possibly certain atmospheric conditions, rendering the mother peculiarly susceptible of such contagion. Numerous series of fatal cases have been traced back to the medical man or nurse having immediately before been in attendance on a case of erysipelas, of sloughing sores, of gangrene, or of typhus fever. It is the opinion of Rokitsansky and others that the morbid matter acquired by the dissection of subjects not dying from this disease, may excite the disease in a patient shortly afterwards delivered by the dissector; and there is no doubt that any one who assists at the *post-mortem* examination of a puerperal patient, becomes, as it were, a focus of intense contagion. Considering the extreme severity and undoubted contagious nature of this disease, the practitioners and nurses who come in contact with it should wash their hands either with a weak solution of chlorine (which has been found of great service in destroying the contagion in the great lying-in hospital at Vienna), or in a solution of chloride of lime, as well as with soap and water. Moreover, persons much engaged in midwifery would do well not to take any part in *post-mortem* examinations, especially when the death resulted from this disease; and when of necessity they are present, they should wear a special dress for the occasion, and take every precaution as to ablution.

Puerperal fever occurs in such varied forms that numerous divisions or species of it have been suggested. The late Dr Gooch, one of the highest authorities on this subject, divided puerperal fever into (1) the *inflammatory* and (2) the *typhoid*; while Dr Robert Lee and Dr Ferguson (two of the highest living authorities) make four divisions.

*Inflammatory puerperal fever* is most commonly due to peritonitis, but may depend upon inflammation of the uterus, the ovaries and uterine appendages, the uterine veins, &c. The ordinary symptoms, in the most common form (namely, when there is peritonitis), are rigors, followed by heat of skin, thirst, flushed face, quickened pulse, and hurried respiration. The abnormal heat of the skin soon subsides, and is followed by nausea, vomiting, pain in the region of the womb, commencing at one spot, and extending over the abdomen. This pain increases as the inflammation extends, till the patient presents the symptoms described in the article PERITONITIS. The pulse is uniformly high; the tongue coated; the urinary secretion diminished, and often passed with difficulty; while the intellectual faculties are rarely affected. Five or six days are the average duration of this disease, which may prove fatal on the first day, or may extend to ten or eleven days. In some epidemics (as, for example, in Paris, in 1746; in Edinburgh, in 1773; and in Vienna, in 1795), none recovered. Dr Ferguson states, that 'to save two out of three may be termed good practice in an epidemic season.' The treatment so closely resembles that which is required in ordinary acute Peritonitis (q. v.), that

826

it is unnecessary to enter into any details regarding it.

*Typhoid* or *malignant puerperal fever* may commence in various ways, but is always accompanied with fever of a low typhoid character, and with the symptoms which usually are associated with such fever. Treatment is of little or no avail, and the patient usually sinks at the end of a few days, or even hours.

PUERPERAL MANIA comprehends many forms and degrees of mental derangement. In the experience of Esquirol, these forms presented the following proportions: of 92 cases, 49 exhibited symptoms of mania; 35, those of monomania; and 8, those of dementia. The points of agreement between these widely-differing moral phenomena are, that they occur during some stage of child-bearing, and that they can be traced to physical, but not necessarily common physical causes. Insanity is developed either during pregnancy, shortly after parturition, or during nursing. Under whatever circumstances the malady may arise, it is one of exhaustion, debility, and prostration; and this is nearly equally true, whether it be characterised by depression, languor, and passiveness, or by extreme excitement and violence. The latter are the features by which it is generally recognised, and which have justified the name by which it is generally known. The similarity to ordinary frenzy is great: there is the same watchfulness, fury, incoherence, the same vitiation of the secretions, and emaciation; and the chief differences between these affections consist in puerperal insanity being invariably traceable to disturbance of the circulation, or to animal poisoning, and in the short duration of the great majority of cases. The prognosis is, in fact, so favourable, recourse to seclusion in an asylum so painful, that it has been proposed to treat all such cases at home, or that a distinct hospital or sanatorium should be established exclusively for them. When it is stated that a physical cause may be detected in the puerperal condition, this must not be construed as excluding the psychological elements which enter into the production of all such affections. Thus, it was found by Macdonald, that of 66 cases, only 6 could be attributed to a purely physical origin; and that in the majority, fright, or anxiety, or anger had formed the last or principal of that series of conditions which culminated in alienation. It not merely affects feeble and hysterical females more than others, but in a marked manner those belonging to tainted families. Of 66 patients in the Bloomingdale Asylum, 17 laboured under a hereditary tendency to mental disease. As connected with this point, it may be mentioned that unmarried are more liable to the disease than married women, in the proportion of 11 to 2. This great disparity may partly be explained by the fact, that the fallen and unfortunate are, more than any other class of females, compelled to seek shelter in those institutions from which such statistics are obtained.

—Read on *Symptoms, Causes, and Treatment of Puerperal Insanity*; Marcé, *Folie des Femmes Encintes, des Nouvelles Accouchées et des Nourrices*.









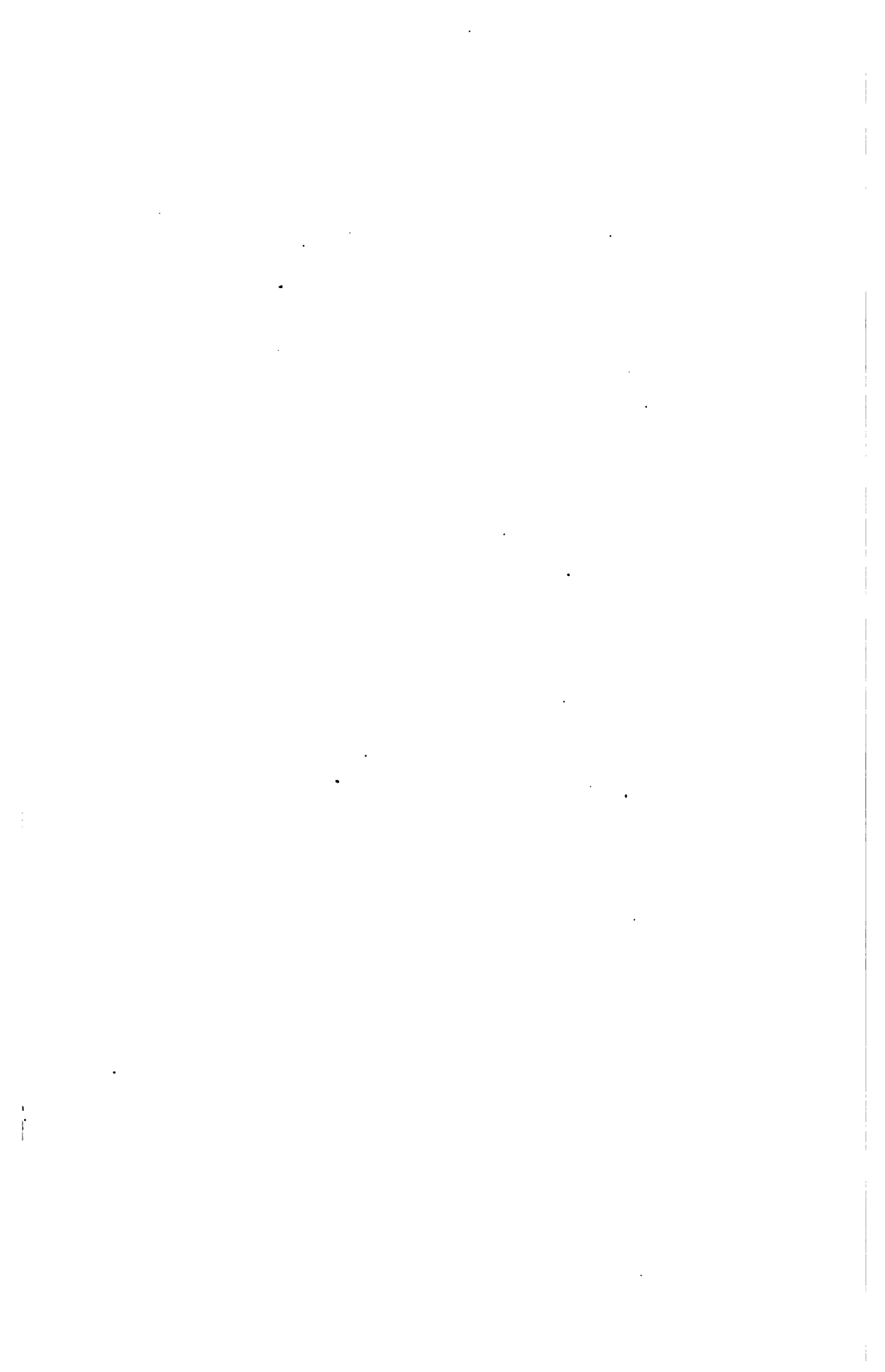

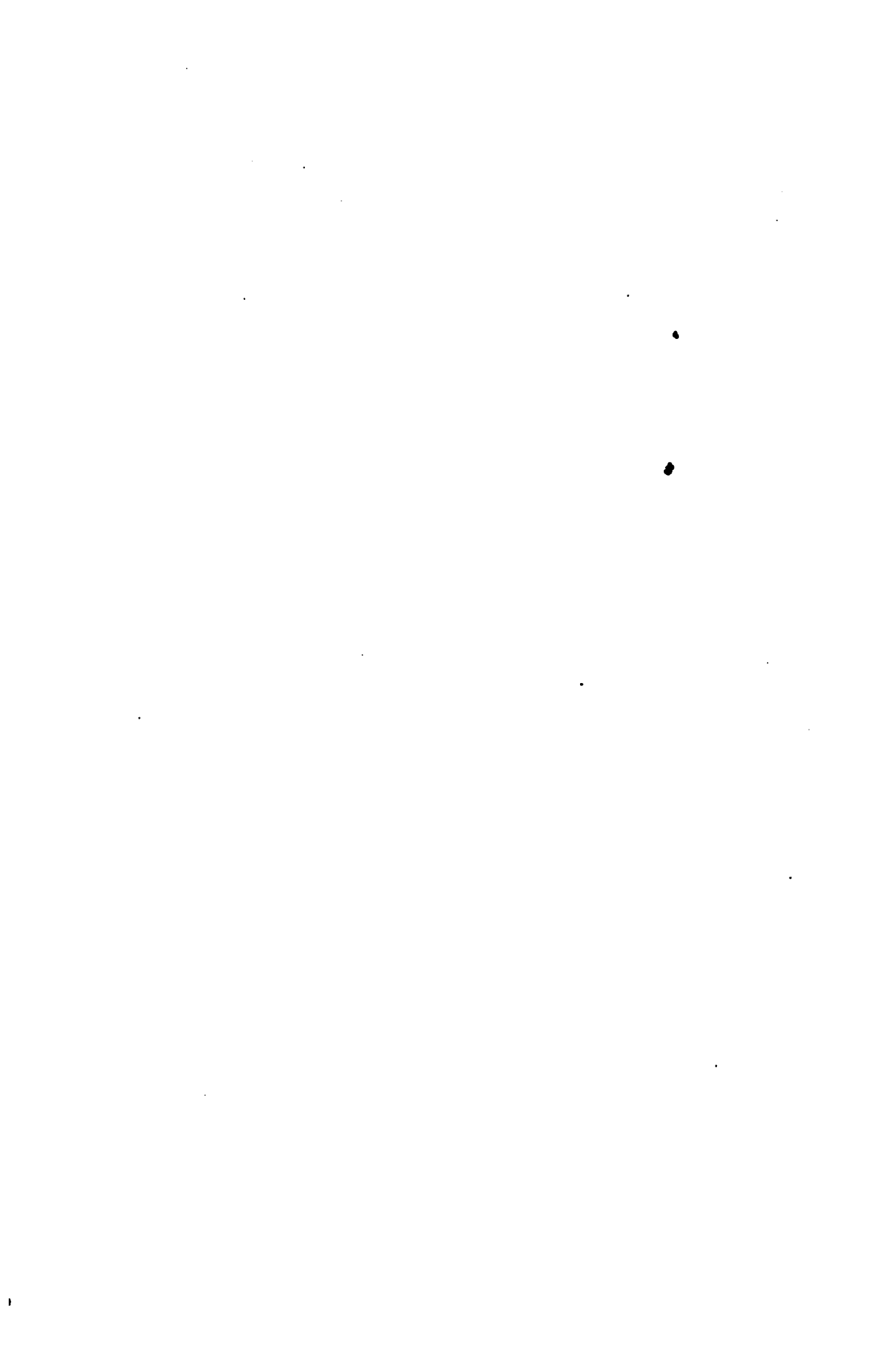

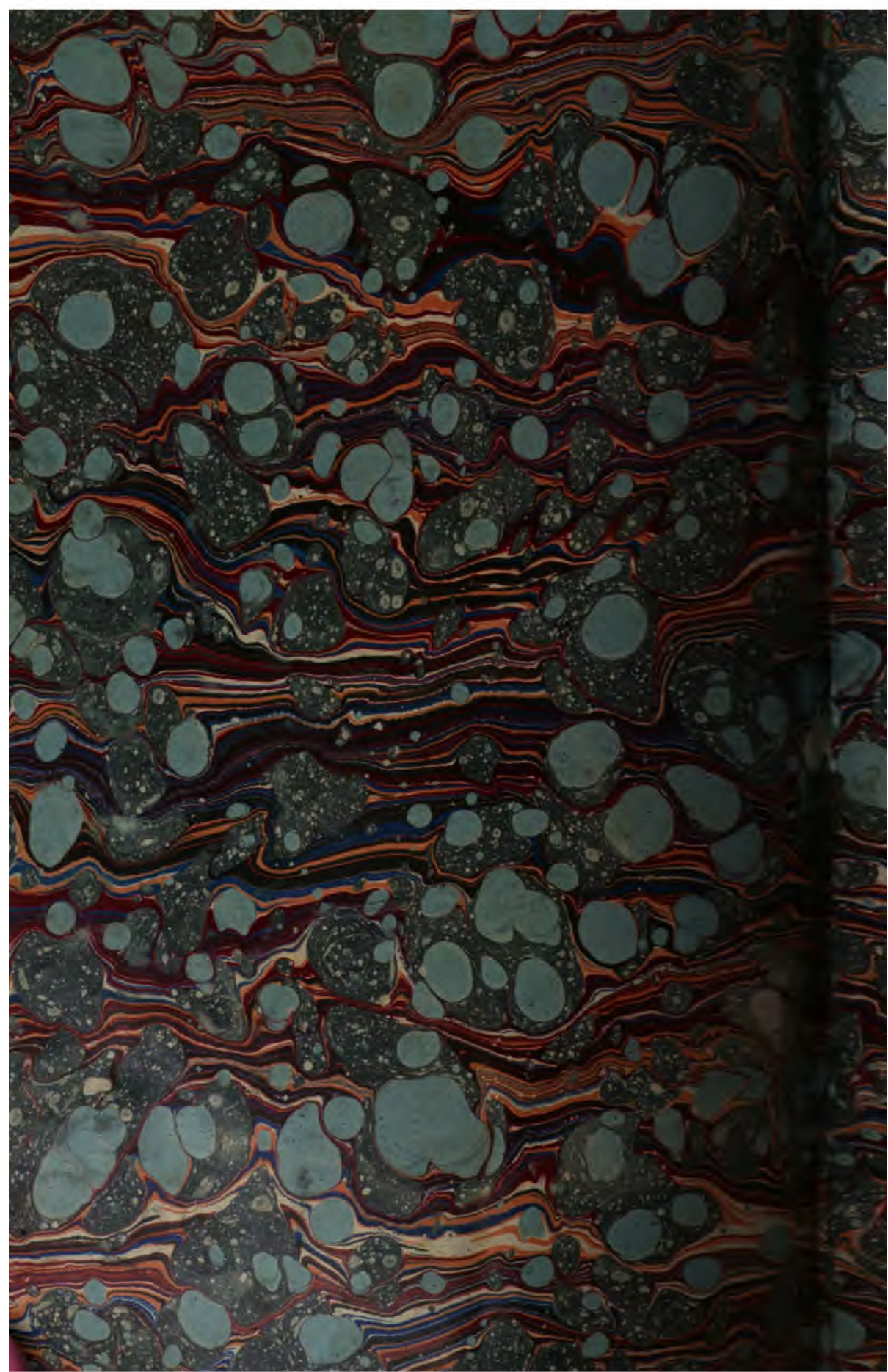

This book should be returned to the Library on or before the last date stamped below.

A fine of five cents a day is incurred by retaining it beyond the specified time.

Please return promptly.

